

**BINDING LIST DEC 1 1920**



1923

# Nature

A WEEKLY

ILLUSTRATED JOURNAL OF SCIENCE



Science  
Nature,  
October 7, 1920.

# Nature

A WEEKLY

ILLUSTRATED JOURNAL OF SCIENCE

VOLUME CV

MARCH, 1920, to AUGUST, 1920

*To the solid ground  
Of Nature trusts the mind which builds for aye.*—WORDSWORTH

158740  
3/2/21

London

MACMILLAN AND CO., LIMITED  
NEW YORK: THE MACMILLAN COMPANY

Q  
|  
N2  
v. 105  
cop. 2

PRINTED IN GREAT BRITAIN BY  
RICHARD CLAY AND SONS, LIMITED,  
BRUNSWICK STREET, STAMFORD STREET, S.E.1,  
AND BUNGAY, SUFFOLK.



# INDEX.

## NAME INDEX.

- Abbot (Dr. C. G.), A New Method of Determining the Solar Constant of Radiation, 667; Solar Variation and the Weather, 678
- Abel (Prof. J. J.), The Honorary Degree of Doctor of Law conferred upon, by Cambridge University, 730
- Abelous (J. E.), and J. Aloy, Digestive Hydrolyses by Mechanical Ionisation of Water, 380
- Ackermann (A. S. E.), British and Metric Systems of Weights and Measures, 456; Curious Formation of Ice, 741; and others, Grants from the Dixon Fund of the University of London, 569
- Acland (F. D.), and H. A. L. Fisher, The Directorship of Research to the Glass Research Association, 178
- Adami (Dr. T. G.), elected an Honorary Fellow of Christ's College, Cambridge, 440; elected an Honorary Fellow of Jesus College, Cambridge, 505
- Adams (Prof. E. P.), The Einstein Theory, 842
- Adams (F. D.), elected a Foreign Associate of the U.S. National Academy of Sciences, 463
- Adeney (Prof. W. E.), and H. G. Becker, The Rate of Solution of Atmospheric Nitrogen and Oxygen by Water (Part iii.), 379
- Adkin (R.), Migrations of Butterflies and Moths in regard to the British Islands, 530
- Adlam (C. H. J.), Acids, Alkalis, and Salts, 705
- Adrian (Dr.), appointed University Lecturer in Physiology in Cambridge University, 537
- Agar (Prof. W. E.), Cytology: with special reference to the Metazoan Nucleus, 482
- Agnew (A. P.), The "Ilford Tropical Hardener," 182
- d'Albe (Dr. E. E. Fournier), The Optophone: An Instrument for Reading by Ear, 205
- Alexander (Dr. C. P.), An Undescribed Species of Clytocosmus, Skuse (Tipulidae, Diptera), 635
- Alexander (Prof. S.), Space, Time, and Delity: The Gifford Lectures at Glasgow, 1916-18, 2 vols., 708
- Allbutt (Sir T. Clifford), Portrait of, by Sir William Orpen, in the Royal Academy, 335; to be Sworn a Member of the Privy Council, 50; Presidential Address to the British Medical Association, 661
- Alcock (H.), Decimal Coinage, 261
- Allen (Sir Charles), [obituary], 230
- Allen (Dr. E. J.), and E. W. Sexton, Mutations in Eye-colour in *Gammarus chevreuxi*, 368
- Allen (Dr. H. S.), An Electronic Theory of Isomerism, 71
- Alliott (E. A.), Recessed Plate and Plate-and-Frame Types of Filter Press, 606
- Allmand (Prof. A. J.), Anti-Gas Fans, 453, 612
- Amar (J.), Attitudes of the Body and Respiration, 635; The Index of Respiratory Endurance, 50
- Ameghino (Dr. C.), appointed Director of the National Museum of Natural History, Buenos Aires, 80; Discovery of Ancient Human Remains in Buenos Aires, 209
- Amos (A.), appointed University Lecturer in Agriculture in Cambridge University, 88
- Amplerer (Dr. O.), Influence of Deep Notches cut by Erosion on Tectonic Features, 836
- Amundsen (Capt. R.), News of the Expedition of, 240, 273, 305
- Anderson (J.), appointed Lecturer in Logic and Metaphysics in the University of Edinburgh, 280
- Anderson (J. A.), Spectra of Explosions, 668
- Anderson (J. Wemyss), appointed Professor of Engineering Refrigeration in Liverpool University, 376
- Andrew (Dr. J. H.), appointed Professor of Metallurgy in the Royal Technical College, Glasgow, 249
- Andrews (Sir Frederick), to Deliver the Harveian Oration, 722
- Andrews (E. S.), Elements of Graphic Dynamics, 65
- Angell (Dr. J. R.), elected President of the Carnegie Corporation of New York, 527; Relation of Psychology to the National Research Council, 796
- Angles (J. W.), Mensuration for Marine and Mechanical Engineers (Second and First Class Board of Trade Examinations), 163
- Annandale (Dr. N.), and others, Biological Papers from Bengal, 436
- Anthony (H. E.), Mammalian Remains in Jamaica, 757
- Appleton (E. V.), appointed an Assistant Demonstrator in Experimental Physics in the University of Cambridge, 56
- Arber (Dr. Agnes), awarded a Keddey Fletcher-Warr Studentship by the University of London, 155; The Binucleate Phase in the Plant-cell, 90
- Ariès (E.), The Equation of State of Ether, 314
- Armstrong (E. C. R.), Ancient Gold Articles found in an Irish Bog, 527
- Armstrong (Dr. E. F.), Catalytic Chemical Reactions and the Law of Mass Action, 606; and T. P. Hilditch, A Study of the Catalytic Action at Solid Surfaces, iii. and iv., 314; v., 631
- Armstrong (Prof. H. E.), A Chemical Service for India, 669
- Arthur (Sir George), Life of Lord Kitchener, 3 vols., 319
- Ascoli (M.), and A. Fagioli, Sub-epidermic Pharmacodynamic Experiences, ii., iii., 844
- Ashfield (H. W.), Scientific Apparatus and Laboratory Fittings, 357
- Ashworth (Dr. J. R.), A Possible Cause for the Diamagnetism of Bohr's Paramagnetic Hydrogen Atom, 516; The Diamagnetism of Hydrogen, 645
- Asiatic Petroleum Company, Gift to Birmingham University, 154
- Aston (Dr. F. W.), elected to a Fellowship in Trinity College, Cambridge, 568; Isotopes and Atomic Weights, 617; The Constitution of the Elements, 8, 547; The Separation of the Element Chlorine into Normal Chlorine and Meta-Chlorine, and the Positive Electron, 221; and T. Kikuchi, Moving Striations in Neon and Helium, 633
- Atack (F. W.), assisted by L. Whinyates, The Chemists' Year Book, 1920, 2 vols., 740
- Atanasoff (D.), and A. G. Johnson, The Use of Dry Heat for the Disinfection of Cereal Seeds, 310
- Athanasius (J.), The Supposed Dynamogenic Power of Alcohol, 251
- Atwood (Dr. W. W.), appointed President of Clark University and College, 602
- Audant (M.), The Critical State of Ethyl Ether, 634

- Auger (V.), The Salts of Nitrosophenylhydroxylamine (Cupferron): Uranous Salts, 379
- Ault (Capt. J. P.), Results of the Magnetic Survey of the Atlantic made by the *Carnegie*, 529; Results of the Magnetic Observations taken by the *Carnegie* in February and March, 1920, 788
- Austen (Major), The House-fly, 787
- Austin (Major E. E.), awarded a Mary Kingsley Medal, 697
- Avery (Margaret), A Text-book of Hygiene for Training Colleges, 259
- Ayrton (Mrs. Hertha), Anti-Gas Fans, 336, 422, 612, 613
- B. (A.), A Note on Telephotography, 488
- Backhouse (T. W.), [obituary], 335; Bequests by, 630
- Bacon (Mrs. P.), Bequest to the U.S. National Museum, 628
- Baglioni (Sig.), Life and Work of the late Prof. L. Luciani, 844
- Bagshawe (Dr. A. G.), awarded a Mary Kingsley Medal, 696
- Bailey (Prof. L. H.), reorganising the American Pomological Society, 623
- Bainbridge (Mr.), The Solubility of Basic Slag in Citric and Carbonic Acids, 184
- Baird (D. W.), British and Foreign Scientific Apparatus, 390; History of the Formation of the British Lamp-blow Scientific Glassware Manufacturers' Association, Ltd., 496
- Bairdston (L.), Applied Aerodynamics, 95; Knowledge and Power, 135
- Baker (C.), Scientific Apparatus and Laboratory Fittings, 356
- Baker (F. C.), Mollusca obtained by the Crocker Land Expedition, 593
- Baker (F. W. Watson), British and Foreign Scientific Apparatus, 518
- Baker (Prof. H. F.), Construction of the Ninth Intersection of Two Cubic Curves passing through Eight given Coplanar Points, 474
- Baker (Julian), re-elected Chairman of the London Section of the Society of Chemical Industry, 526
- Baker (Prof. R. P.), Engineering Education: Essays for English, selected and edited by, 258
- Baker (R. T.), The Hardwoods of Australia and their Economics, 802
- Baker (Commander T. Y.), A New Method for Approximate Evaluation of Definite Integrals between Finite Limits, 486
- Baldet (F.), The Diurnal Variation of the Atmospheric Potential at the Algiers Observatory, 283
- Balfour (Dr. A.), awarded a Mary Kingsley Medal, 697
- Balfour (H.), Presidential Address to the Somersetshire Archaeological and Natural History Society, 855
- Ball (Dr. J.), Astrolabe Diagram, 329; Use of Summer Lines in Navigation, 806; and H. Knox Shaw, A Handbook of the Prismatic Astrolabe, 329
- Ballantyne (Dr. A. J.), appointed Lecturer in Ophthalmology in Glasgow University, 761
- Ballou (H. H.), Cotton Pests, 503; and others, The Resistance of Plants to Insect Attacks, 503
- Balls (Dr. W. Lawrence), Cotton-growing in the British Empire, 103; Researches on Egyptian Cotton, 664; The Nature, Scope, and Difficulties of Research, 497; Trichodynamics, 777
- Balsillie (D.), The Intrusive Rocks of the Dundee District, 666
- Banks (Sir Joseph), The Centenary of, 530
- Bannister (C. O.), appointed Professor of Metallurgy in Liverpool University, 630
- Barber (Dr. C. A.), appointed Lecturer in Tropical Agriculture in the University of Cambridge, 537
- Barcroft (J.), Presidential Address to Section I of the British Association, 828
- Barjon (F.), Translated by Dr. J. A. Honeij, Radio-Diagnosis of Pleuro-Pulmonary Affections, 4
- Barker (Prof. A. F.), A Summer Tour (1919) through the Textile Districts of Canada and the United States, 789
- Barker (E.), appointed Principal of King's College, London, 630
- Barling (Sir Gilbert), The Need for Increasing the Stipends in Birmingham University, 730
- Barlot (J.), Determination of Poisonous Varieties of Amanita by Colour Reactions, 219
- Barlow (W.), Models illustrating the Atomic Arrangement in Potassium Chloride, etc., 570
- Barnard (Prof.), Photographs of the Broresen-Metcalf Comet, 467
- Barratt (S.), The Origin of the "Cyanogen" Bands, 633
- Bartholomew (Dr. J. G.), [obituary article], 238; Bequest to the University of Edinburgh, 537
- Bartlett (Capt. F. W.), and Prof. T. W. Johnson, Engineering Descriptive Geometry and Drawing, 3 parts, 515
- Bartrum (C. O.), A Rainbow Inside Out, 388
- Bartsch (P.), Experiments in the Breeding of Cerions, 545
- Barus (Prof. C.), An Example of Torsional Viscous Retardation, 667; Displacement Interferometry by the aid of the Achromatic Fringes. Part iv., 563
- Bary (P.), The Viscosity of Colloidal Solutions, 539
- Bateson (Dr. W.), Prof. L. Doncaster, 461; Genetic Segregation, 531; Organisation of Scientific Work, 6
- Bather (Dr. F. A.), Museums and the State, 69; Presidential Address to Section C of the British Association, 826
- Battestini (M.), The Optimum Magnification of a Telescope, 443
- Bauer (Dr. L. A.), Magnetic and Electrical Observations and their Reduction, 20; Results of Geophysical Observations during the Solar Eclipse of May 29, 1919, and their Bearing upon the Einstein Deflection of Light, 842; The Solar Eclipse of May, 1919, 311
- Bayliss (Prof. W. M.), British and Foreign Scientific Apparatus, 641; Scientific Apparatus from Abroad, 293; The Circulating Blood in Relation to Wound Shock, 10; The Properties of Colloidal Systems, iv.; Reversible Gelation in Living Protoplasm, 26; The Rockefeller Gift to Medical Science, 501
- Beamish (A. J.), elected to the Wrenbury Scholarship in Economics in Cambridge University, 601
- Beccari (Dr. O.), The Palms of the Philippines, 180
- Beck (C.), Scientific Apparatus and Laboratory Fittings, 355
- Becker (Prof. L.), Capture Orbits, 560; The Daily Temperature Curve, 282
- Beddard (Dr. F. E.), Two Embryos of the Sperm Whale, 275
- Bedford (the Duke of), The Cancer Research Fund, 696
- Beer (R.), and Dr. Agnes Arber, Multinucleate Cells, 90
- Beeson (C. F. C.), The Toon Shoot and Fruit Borer, 629
- Bell (A. J. M.), [obituary], 721
- Bellingham and Stanley, Ltd., Scientific Apparatus and Laboratory Fittings, 357
- Belot (E.), L'Origine des Formes de la Terre et des Planètes, 559
- Bemmelen (Dr. W. van), High Rates of Ascent of Pilot Balloons, 485
- Benedicks (Prof. C. A. F.), Recent Progress in Thermo-Electricity, 499
- Benedict (F. G.), The Basal Metabolism of Boys from One to Thirteen Years of Age, 667
- Bennett (A. G.), The Occurrence of Diatoms on the Skin of Whales, 633
- Bennett (G. T.), The Rotation of a Non-spinning Gyrostat, and its Effect in the Aeroplane Compass, 378
- Benson (O. H.), and G. H. Betts, Agriculture and the Farming Business, 35
- Berger (E.), Some Reactions Started by a Primer, 603
- Bernewitz (Dr.), The Duplicity of  $\nu$  Minorum, 340
- Berry (A. J.), re-elected to a Fellowship at Cambridge University, 761
- Berthoud (Prof. A.), The Structure of Atoms, 306
- Bertrand (G.), Action of Chloropicrin upon the Higher Plants, 283; Conditions which may Modify the Activity of Chloropicrin towards the Higher Plants, 347; and M. Brocq-Rousseau, The Destruction of Rats by Chloropicrin, 27; and Mme. Rosenblatt, Action of Chloropicrin upon some Bacterial Fermentations, 571; Action of Chloropicrin upon Yeast and *Saccharomyces vini*, 507; Does Chloropicrin Act upon Soluble Ferments?, 699

- Berwick (W. E. H.), appointed Lecturer in Mathematics in the University of Leeds, 56; Quintic Transformations and Singular Invariants, 474
- Besson (L.), The Actinometers of Arago and Bellani, 283
- Betts (Anne D.), Daylight Saving and the Length of the Working Day, 41
- Bevan (W.), The Agricultural Industries of Cyprus, 757
- Beveridge (Sir William), A Hitherto Unrecognised Periodicity in the Weather and the Crops, 370
- Bianco (O. Z.), "La Trepidazione in Dante?" 664
- Bidder (Dr. G. P.), Sponges, 441
- Bigourdan (G.), The Instruments and Work of the Sainte-Geneviève Observatory, 475
- Birchough (Sir Henry), appointed Chairman of the British Dyes Corporation, 303; Importance of the Dye Industry, 413
- Birkett (M. S.), The Iron and Steel Trades during the War, 787
- Bishop (F. C.), and H. P. Wood, A Remedy against Lice in Poultry, 663
- Bispham (Capt. J. W.), An Experimental Determination of the Distribution of the Partial Correlation Coefficient in Samples of 30, 187
- Bjerknes (Prof. V.), The Meteorology of the Temperate Zone and the General Atmospheric Circulation, 522
- Blacklock and Carter, *Anopheles plumbeus*, 241
- Blackman (Dr. A. M.), "The House of the Morning" in Egyptian Ritual, 241
- Blackman (Dr. F. F.), The Protoplasmic Factor in Photosynthesis, 89
- Blair (Sir Robert), Presidential Address to Section L of the British Association, 828
- Blaise (E. E.), The Action of Hydrazine on the 1:4 Acyclic Diketones, 506; The Action of Substituted Hydrazines upon Acyclic 1:4-Diketones, 666
- Blake (E.), Selected Studies in Elementary Physics: A Handbook for the Wireless Student and Amateur, 739
- Blake (Dr. F. G.), The Relation of the *Bacillus influenzae* to Influenza, 763
- Blakeslee (E. B.), The Control of the Peach-borer, 629
- Blamires (Mrs. M.), Gift to the Huddersfield Technical College, 185
- Blaringham (L.), The Stability and Fertility of the Hybrid *Gesum urbanum* × *G. rivale*, 475
- Bloch (L. and E.), Production of the Band Spectra of Nitrogen by Electrons of Low Velocity, 539; Some new Spark Spectra in the Extreme Ultra-violet, 27
- Blythe (E.), A Text-book on Machine Drawing for Electrical Engineers, 260
- Boecker (Dr. R. H. D.), Our National Forests: A Short Popular Account of the Work of the U.S. Forest Service on the National Forests, 477
- Boisacq (E.), The Psychology of the Future ("L'Avenir des Sciences Psychiques"), Translated and Edited with an Introduction by W. de Kerlor, 323
- Bond (Hon. Col. C. J.), Loss of Fragrance of Musk Plants, 709
- Bone (Prof. W. A.), The Position of University Teachers in relation to the Teachers (Superannuation) Act, 89
- Booney (Prof. T. G.), Marlborough R. Pryor, 333
- Bonnier (Prof. G.), elected a Foreign Member of the Linnean Society, 366; The Changes in Plant Forms Obtained Experimentally, 539
- Boot (Sir Jesse), Gift to University College, Nottingham, 665
- Borchardt (W. G.), School Mechanics. Part i., School Statics, 163
- Borradaile (L. A.), A Manual of Elementary Zoology. Third edition, 804
- Bose (Sir Jagadis Chandra), Conferment upon, of an Honorary Degree by Aberdeen University, 154; Experiments on Movements in Plants, 304; Life Movements in Plants, 416; Organisation of Scientific Work, 39; Researches on Growth of Plants, 615, 648
- Bosworth (Dr. T. O.), Geology of the Mid-Continent Oil-fields. Kansas, Oklahoma, and North Texas, 608
- Bottazzi (F.), Researches on the Posterior Salivary Gland of Cephalopodes (iii.), 251
- Bougault (J.) and J. Perrier, New Researches Relating to the Action of Hydrocyanic Acid on Glucose, 539; The Action of Hydrocyanic Acid on Glucose; Kiliani's Reaction, 443; and P. Robin, The Iodoamidines, 666
- Boulin (Ch.), and L. J. Simon, Action of Water on Dichloroethyl Sulphide, 283; The Preparation of Methyl Chloride and Bromide starting from Dimethyl Sulphate, 218
- Bourion (F.), A Method of Physico-chemical Analysis of Commercial Chlorobenzenes, 379; Kinetic Study of the Chlorination of Benzene, 506; The Analysis of Commercial Chlorobenzenes by Distillation, 347; The Impurities of the Benzene extracted from Commercial Chlorobenzenes, 443
- Bourquelot (Em.), and M. Bridel, A New Glucoside capable of Hydrolysis by Emulsin, Scabiosin, 187; Detection and Characterisation of Glucose in Plants by a New Biochemical Method, 218; The Biochemical Preparation of Cane-sugar starting with Gentianose, 666; and H. Hérissé, The Presence in the Melilot and Woodruff of Glucosides furnishing Coumarin under the Hydrolysing Action of Emulsin, 634
- Boutroux (Prof. P.), Les Principes de l'Analyse Mathématique: Exposé Historique et Critique. Tome ii., 356
- Bower (Prof. F. O.), The Earliest Known Land Flora, 681, 712
- Bowie (W.), Report on the Connection of the Arcs of Primary Triangulation along the Ninety-eighth Meridian in the United States and in Mexico, and on Triangulation in Southern Texas, 141
- Bowly (Sir Anthony A.), elected President of the Royal College of Surgeons of England, 622
- Boys (Prof. C. V.), A Noon Reflector, 117
- Braak (Dr. C.), Atmospheric Variations of Short and Long Duration in the Malay Archipelago and Neighbouring Regions, and the Possibility to Forecast Them, 729
- Brabrook (Sir Edward), Anthropology and Economics during the Past Quarter of a Century, 530; Sir Norman Lockyer, 784
- Bradford (S. C.), An Electronic Theory of Isomerism, 171; Langmuir's Theory of Atoms, 41, 725
- Bradley (Dr. O. C.), elected President of the Royal (Dick) Veterinary College, Edinburgh, 601
- Bragg (Sir W. H.), elected an Honorary Fellow of Trinity College, Cambridge, 88; Increased Interest in Scientific Studies, 281; to receive the Honorary Degree of D.Sc. from the University of Dublin, 89
- Bragg (Prof. W. L.), Crystal Structure, 646
- Brady (Ad.), Method for Collecting and Characterising the Sublimates Produced by Metalloids and Metals Volatilised by the Blowpipe, 219
- Brashear (Dr. J. A.), [obituary], 273
- Brenchley (Dr. W. E.), Sugar Cultivation in India, 840; The Improvement of Grassland, 408
- Breuil (l'Abbé), appointed Munro Lecturer for 1920-21 in Edinburgh University, 121
- Bridgman (Dr. P. W.), Effects of Pressure on the Electrical Resistance and Thermo-electric Properties of Metals, 529
- Brierley (Mrs. S.), The Present Attitude of Employees to Industrial Psychology, 400
- Brierley (W. B.), A Form of *Botrytis cinerea* with Colourless Sclerotia, 186; Ellis's Applied Botany, 164
- Briggs (G. E.), elected to the Allen Scholarship in Cambridge University, 154; The Beginning of Photosynthesis in the Green Leaf, 89
- Brindley (H. H.), Further Notes on the Food-plants of the Common Earwig (*Forficula auricularia*), 378
- Brindley (H. S. B.), [obituary], 208
- British Dyestuffs Corporation, Gift to Oxford University towards the Extension of the Organic Chemical Laboratory, 313
- Britten (J.), Banks as a Botanist, 530
- Britten (N. L.), and C. P. Berkey, The Scientific Survey of Porto Rico and the Virgin Islands, 147
- Brives (A.), Some Results of a New Journey in Morocco, 475
- Broad (Dr. C. D.), appointed Professor of Philosophy in Bristol University, 630

- Broden (Dr. A. L. G.), awarded a Mary Kingsley Medal, 697
- Brodetsky (Dr. S.), A Graphical Treatment of Differential Equations, 466; Mathematics: Pure and Applied, 65
- Brodie (J. A.), elected President of the Institution of Civil Engineers, 304
- Brogie (L. de), Calculation of the Limiting Frequencies of K and L Absorption of the Heavy Elements, 218; The Fine Structure of X-ray Spectra, 475
- Brook (A.), The Buzzard at Home, 740
- Brooks (C. E. P.), Climates of the British Empire Suitable for the Cultivation of Cotton, 338; The Climate and Weather of the Falkland Islands and South Georgia, 275
- Brooks (F. S.), The Control of the Apple-tree Borer, 629
- Brotherus (Prof. V. F.), elected a Foreign Member of the Linnean Society, 366
- Brown (Prof. Adrian), Erection of a Memorial Tablet to in the Brewing School of Birmingham University, 154
- Brown (G. E.), The British Journal Photographic Almanac and Photographer's Daily Companion, 1920, 66
- Brown (O. F.), appointed Technical Officer to the Radio Research Board, 463
- Brown (S. G.), The Gyrostatic Compass, 44, 77
- Brown (Dr. T. Graham), The Function of the Brain, 123
- Brown (Prof. W.), The Decay of Magnetism in Bar Magnets, 123; and P. O'Callaghan, The Change in the Rigidity of Nickel Wire with Magnetic Fields, 634
- Browne (Dr. E. G.), to deliver the FitzPatrick Lectures, 722
- Browne (R. Grant), Races of the Chindwin, Upper Burma, 281
- Bruce (Major-Gen. Sir David), The Prevention of Tetanus during the Great War, 785
- Brunner, Mond, and Co., Ltd., Purchase of H.M. Nitrate Factory at Billingham-on-Tees, 312; Vote of 100,000. for Scientific Education and Research, 762
- Bryan (Prof. G. H.), awarded the Hopkins Prize of the Cambridge Philosophical Society, 440
- Bryant (W. W.), The Cost of Scientific Publications, 327; The Position of the Meteorological Office, 38
- Bryce (G.), Structure and Development of the Small Woody "Burs" or "Nodules" in *Hevea brasiliensis*, 20
- Bryce (Lord), to receive the Honorary Degree of LL.D. from the University of Dublin, 89
- Brylinski (E.), The Transport of Electrical Energy to Great Distances, 347
- Buchanan (Capt. A.), Wild Life in Canada, 426
- Budge (Sir E. A. Wallis), The "Book of the Dead," 755
- Buller (Prof. A. H. R.), Essays on Wheat, 224
- Bullock (F.), The Compilation of Bibliographies, 116
- Bumstead (Prof. H. A.), elected Chairman of the U.S. National Research Council, 526
- Burke (E. T.), The Venereal Problem, 543
- Burnet (A.), Conjunction of Mercury with  $\epsilon$  Geminorum, 370
- Burnside (Dr. W.), awarded the Hopkins Prize of the Cambridge Philosophical Society, 440; Cyclical Oscillation, 473
- Burrow (E. J.), The Ancient Entrenchments and Camps of Gloucestershire, 128
- Burrows (Principal R. M.), [obituary article], 364
- Burstall (Prof. F. W.), elected Dean of the Faculty of Science of Birmingham University, 505
- Bury (H.), Mortlakes as a Cause of River-windings, 391
- Bury (Prof. J. B.), The Idea of Progress: An Inquiry into its Origin and Growth, 733
- Butler (Sir Geoffrey), appointed Secretary of the Board of Research Studies in Cambridge University, 345
- Butler (S.), Luck, or Cunning, as the Main Means of Organic Modification? An Attempt to Throw Additional Light upon Darwin's Theory of Natural Selection. Second edition, 773; Unconscious Memory. Third edition, 774
- Butterworth (S.), The Maintenance of a Vibrating System by means of a Triode Valve, 842
- Cadman (Sir John), Impending Resignation of the Chair of Mining in the University of Birmingham, 409; W. B. Hardy, and Prof. S. Young appointed Members of the Advisory Council to the Committee of the Privy Council for Scientific and Industrial Research, 590
- Cahen (E.), and W. O. Wootton, The Mineralogy of the Rarer Metals: a Handbook for Prospectors. Second edition, revised by E. Cahen, 259
- Caillas (A.), The Search for Invertin in Pure Honey, 218
- Cain (Dr. J. C.), The Chemistry and Technology of the Diazo-Compounds. Second edition, 449; The Manufacture of Intermediate Products for Dyes. Second edition, 260
- Cajal (S. R. y.), elected a Foreign Associate of the U.S. National Academy of Sciences, 463
- Cabbage (R. H.), A New Species of Queensland Ironbark, 732
- Camichel (C.), The Permanent Régime in Water-chambers, 314
- Campbell (A.), The Magnetic Properties of Silicon Iron (Stalloy) in Alternating Magnetic Fields of Low Value, 473
- Campbell (D. F.), Recent Developments of the Electric Furnace in Great Britain, 605
- Campbell (Prof. D. H.), Derivation of the Flora of Hawaii, 217
- Campbell (R. E.), Distribution, Life History, and Measures of Control of *Bruchus rufimanus*, Boh, 310
- Campbell (Prof. W. W.), and J. H. Moore, Researches on Nebulae, 490
- Cannon (H. G.), Production and Transmission of an Environmental Effect in *Simoccephalus vetulus*, 538
- Cannons (H. G. T.), Bibliography of Industrial Efficiency and Factory Management, 641
- Carmody (Prof. P.), Camphor-growing in the British Empire, 757
- Carnot (A.), [obituary], 555
- Carnwath (Dr.), Influenza, 151
- Carpenter (Dr. G. D. H.), The Bionomics of *Glossina palpalis* on Lake Victoria, 663
- Carpenter (Prof. G. H.), elected Secretary of the Royal Irish Academy, 590; Injurious Insects observed in Ireland during the years 1916-18, 634; and F. J. S. Poltard, Presence of Lateral Spiracles in the Larvæ of Warble-flies, 855
- Carpenter (Prof. H. C. H.), The Future of the Iron and Steel Industry in Lorraine, 588; and Prof. G. C. Cullis, Report on the World's Production of Silver, 73
- Carr (Prof. H. Wildon), Behaviourism, 512
- Carruthers (D.), The Heart of a Continent, 330
- Case (Prof. E. C.), The Environment of Vertebrate Life in the Late Paleozoic in North America, 223
- Casella and Co., Ltd. (C. F.), Catalogue of Meteorological Instruments, 20
- Cassel (Sir Ernest), Educational Trust Gifts to the University of London, 25
- Cattell (Dr. J. McK.), Methods, 705
- Cave (Capt. C. J. P.), A Peculiar Halo, 171; Weather Notes of Evelyn, Pepys, and Swift in Relation to British Climate, 393; and J. S. Dines, Soundings with Pilot Balloons in the Isles of Scilly, 663
- Cayeux (L.), The Hettangian Iron Minerals of Burgundy, 443
- Cellerier (M.), The Verification of Screw Gauges, 184
- Cesàro (Prof. G.), Minerals from Monte Somma and Vesuvius, 464
- Chadwick (J.), elected to the Clerk Maxwell Scholarship in Experimental Physics in Cambridge University, 601
- Chalmers (Mrs. A. J.), awarded a Mary Kingsley Medal, 697
- Chalmers (Dr. A. J.), [obituary article], 271
- Chalmers (Dr. A. K.), appointed Head of the Health Department of Glasgow, 19
- Chalmers (T. W.), Paper-making and its Machinery: including Chapters on the Tub-sizing of Paper, the Coating and Finishing of Art Paper, and the Coating of Photographic Paper, 480
- Chamberlin (R. V.), *Priapulus humanus*, 786
- Chamberlin (Prof. T. C.), awarded the Hayden Memorial Medal of the Academy of Natural Sciences of Philadelphia, 390
- Chapman (D. L.), The Separation of the Isotopes of Chlorine, 487, 611

- Chapman (F.), awarded the David Syme Prize and Medal, 496
- Chapman (Prof. S.), The Effects of Lunar Tides on the Earth's Atmosphere, 506; and E. A. Milne, The Composition, Ionisation, and Viscosity of the Atmosphere at Great Heights, 570
- Chardin (P. T. de), The Pitdown Remains, 503
- Charpy (G.), The Minute Fissures in Steel Ingots, 27
- Châtelier (H. L. le), elected an Honorary Member of the Royal Irish Academy, 111
- Chaudron (G.), Reversible Reactions of Water on Tungsten and the Oxides of Tungsten, 411
- Cheney (W. L.), The Measurement of Hysteresis Values when using High Magnetising Forces, 838
- Cherry (Major T.), The Origin of Agriculture, 474
- Chevalier (A.), Plans for the Reorganisation and Extension of Scientific Services in French Indo-China, 401
- Chevenard (P.), The Elasticity of Torsion of Nickel-Steels with a High Proportion of Chromium, 699; The Thermal Change of the Elastic Properties of Nickel-Steels, 603
- Chick (Dr. Harriette), awarded the Stewart Prize of the British Medical Association, 432
- Chinnery (A. W. P.), awarded the Cuthbert Peek Grant of the Royal Geographical Society, 112
- Chisolm (Sir Valentine), The Enduring Power of Hinduism, 834
- Chisholm (G. G.), Dr. J. G. Bartholomew, 238; Dr. J. G. Bartholomew and the Layer System of Contour Colouring, 328
- Chofardet (P.), Observations of the Periodic Comet Tempel II. (Schaumasse) 1920a, 794
- Chree (Dr. C.), A Magnetic Storm on March 4 and 5, 56; Simultaneous Values of Magnetic Declination at Different British Stations, 632; The Magnetic Storm of March 22-23 and Associated Phenomena, 136
- Church (Major A. G.), Applied Science and Industrial Research, 423, 547; Expenses of Scientific Work, 72, Scientific Direction of Industrial Research, 40
- Church (A. H.), Elementary Notes on Structural Botany; Elementary Notes on the Reproduction of Angiosperms, 162
- Church (Sir William), Investigations of the Imperial Cancer Research Fund, 606
- Cisotti (U.), Integration of the Equation of Wave-motion in a Deep Canal, ii, 843
- Clapham (Dr. J. H.), Presidential Address to Section F of the British Association, 827
- Clark (H. L.), Distribution of Littoral Echinoderms of the West Indies, 270
- Clark (J. E.), The Surrey Hailstorm of July 16, 1918, 281; and H. B. Adames, Report on the Phenological Observations for 1919, 442
- Clarke (G. A.), An Analysis of Cloud Distribution at Aberdeen during the years 1916-18, 148
- Clay (Dr. R. S.), Plea for an Ampler Provision of Scholarships, 23
- Clay (V.), Development of the Synthetic Dye Industry, 686
- Clayton (C. H. J.), Land Drainage from the Engineering Point of View, 42
- Cleland (Dr. J. B.), appointed Professor of Pathology in Adelaide University, 217
- Clerk (Sir Dugald), The Conservation of Fuel, 406
- Clodd (E.), The Prevalence of Occultism, 432
- Clough (Miss B. A.), appointed Principal of Newnham College, Cambridge, 537
- Coates (Dr. J. E.), appointed Professor of Chemistry at University College, Swansea, 665
- Cobb (Prof. J. W.), Fuel Research, 550
- Cobbold (E. S.), The Cambrian Horizons of Comley (Shropshire) and their Brachiopoda, etc., 314
- Coblentz (W. W.), and H. Kahler, A New Spectroprismeliometer and Solar Measurements made with it, 625
- Cockayne (Dr. L.), New Zealand Plants and their Story, Second edition, 707
- Cockerell (Prof. T. D. A.), Eye Colour in Bees, 518
- Cocking (T. T.), "Cresineol," 726
- Coffin (Dr. J. G.), The Attainment of High Levels in the Atmosphere, 437
- Cohen (Prof. J. B.), A Class-book of Organic Chemistry, Vol. ii., 195
- Cohen-Kysper (A.), Rückläufige Differenzierung und Entwicklung, 164
- Cole (J. H.), Systematic Error in Spirit Levelling, 409
- Coles (Principal C.), The Necessity for Close Co-operation between Technical Colleges and the Universities, 728
- Colin (H.), The Diastatic Hydrolysis of Inulin, 380
- Collie (Prof. J. N.), Krypton and Xenon, 441
- Collinge (Dr. W. E.), Sea Birds: Their Relation to the Fisheries and Agriculture, 172; The Plumage Bill and Bird Protection, 196
- Collingwood (Dr. B. J.), appointed Professor of Physiology at St. Mary's Hospital Medical School, 568
- Collins (W. H.), Replacement of Sands and Gravels by Silica, 242
- Compton (R. H.), The Botany of New Caledonia, 122
- Comrie (L. J.), Occultation of a Star by Saturn, 22
- Comstock (Prof. G. C.), The Summer Line or Line of Position as an Aid to Navigation, 552; Use of Summer Lines in Navigation, 742
- Connaught (Duke of), admitted an Honorary Fellow of the Royal College of Surgeons of England, 556
- Connaught (Prince Arthur of) and others, The Scheme for the Extension of the Engineering Laboratories of University College, London, 114
- Conway (Sir Martin), The Formation of the Imperial War Museum, 626
- Cook (Dr. M. T.), Applied Economic Botany: Based upon Actual Agricultural and Gardening Projects, 34
- Cook (O. F.), Commercial Parasitism in the Cotton Industry, 548
- Cooke (H. C.), The Gabbros of East Sooke, 464
- Coolidge (Dr. W. D.), The Manufacture of the Coolidge Tube, 655
- Cope (Miss L.), Calendars of the Indians North of Mexico, 75
- Corbett (Sir J. S.), History of the Great War, based on Official Documents. By direction of the Historical Section of the Committee of Imperial Defence: Naval Operations, Vol. i., 546
- Core (A. F.), The Separation of the Isotopes of Chlorine, 582, 677
- Corney (B. G.), A Remarkable Stone Bowl in the Museo Arqueológico, Madrid, 755
- Cornubert (R.), The Constitution of some Dialkylcyclohexanones, 475
- Cortie (Rev. A. L.), Report and Notes on the Stonyhurst College Observatory, 624; Stonyhurst Observations in 1919, 780; The Magnetic Storm of March 22-23 and Associated Phenomena, 137
- Cottrell (Dr. F. G.), awarded the Willard Gibbs Medal of the Chicago Section of the American Chemical Society, 526; nominated as Director of the U.S. Bureau of Mines, 432
- Coupin (H.), Seedlings which turn Green in the Dark, 411
- Cournot (J.), The Annealing of Electrolytic Iron, 763
- Coursey (P. R.), Telephony without Wives, 5
- Coward (T. A.), The Birds of the British Isles and their Eggs, First Series, 132
- Cowles (R. P.), The Transplanting of Sea-anemones by Hermit Crabs, 668
- Cox (Dr. A. H.), A Report on Magnetic Disturbances in Northamptonshire and Leicestershire and their Relations to the Geological Structure, 175; and A. K. Wells, The Lower Palaeozoic Rocks of the Arthog-Dolgelly District, 123
- Crabtree (J. H.), Grasses and Rushes and How to Identify Them, 805; Wonders of Insect Life: Details of the Habits and Structure of Insects, 651
- Craib (W. G.), appointed Professor of Botany in the University of Aberdeen, 120
- Cranworth (Capt. the Lord), Profit and Sport in British East Africa, being a Second Edition, revised and enlarged, of "A Colony in the Making," 392
- Craster (Lt.-Col. J. E. E.), Estimating River Flow from Rainfall Records, 42
- Creak (Capt. E. W.) [death], 178; [obituary article], 300
- Cremer (H. W.), appointed Lecturer in Inorganic Chemistry at King's College, London, 698

- Crewe (Marquess of), The Imperial College of Science and Technology, 281; The Working of the Education Act of 1918, 22
- Cripps (Miss L. D.), awarded the Dr. Jessie Macgregor Prize of the Royal College of Physicians, Edinburgh, 794
- Crommelin (Dr. A. C. D.), Calendar Reform, 105; Deflection of Light during a Solar Eclipse, 8; The Einstein Deflection of Light, 23; Woltjer's Investigations in the Theory of Hyperion, 675
- Crooke (Dr. W.), Nudity in India in Custom and Ritual, 723; to receive the Honorary Degree of D.Litt. from the University of Dublin, 89
- Crossley (Dr. A. W.), The Constitution and Methods of the British Cotton Industry Research Association, 372
- Crosthwaite (P. M.), Earthworks and Retaining Walls, 87
- Crowther (Dr. J. A.), Ions, Electrons, and Ionising Radiations, 740
- Cullis (Prof. C. E.), Matrices and Determinoids, Vol. ii., 191
- Cumming (Dr. A. C.) and Dr. S. A. Kay, A Text-book of Quantitative Chemical Analysis, Third edition, 33
- Cumming (W. M.), appointed Senior Lecturer in Organic Chemistry at the Royal Technical College, Glasgow, 630
- Cunard Steamship Co., Ltd., Gift to Liverpool University, 313, 762
- Cunningham (Dr. Brysson), Rainfall and Land Drainage, 42
- Cunningham (E.), Relativity and Geometry, 350
- Cunnington (Mrs. M. E.), A Curious Stone Mould found on the Worms' Head, Glamorganshire, 407
- Curtis (A. H.), Manganese Ores, 193
- Curtis (Dr. H. D.), appointed Director of the Allegheny Observatory, 366; Researches on Nebulae, 489
- Curtis (Miss K. M.), The Life History and Cytology of *Synchytrium endobioticum* (Schilb.), Perc., the Cause of Wart Disease in Potato, 346
- Cushing (Prof. H.), The Honorary Degree of Doctor of Law conferred upon, by Cambridge University, 730
- Cushman (J. A.), Recent Foraminifera from off New Zealand, 242
- Cuthbertson (C. and Maude), The Refraction and Dispersion of Carbon Dioxide, Carbon Monoxide, and Methane, 58
- Cvijic (Prof. J.), awarded the Patron's Medal of the Royal Geographical Society, 112
- Czaplicka (Miss), awarded the Murchison Grant of the Royal Geographical Society, 112
- D. (F. V.), The Mole Cricket, 294
- D. (I. S.), Sea and Sky at Sunset, 358
- Da Fano (C.), Method for the Demonstration of the Golgi Apparatus in Nervous and other Tissues, 249
- Dakin (Prof. W. J.), appointed Derby Professor of Zoology in the University of Liverpool, 537
- Dalby (Prof. W. E.), The Elastic Properties and the Plastic Extension of Metals, 377
- Dale (Prof. J. B.), Some Methods of Approximate Integration and of Computing Areas, 138
- Dall (Dr. W. H.), The Mollusca Obtained by the Crocker Land Expedition, 688
- Dalton (H.), appointed Reader in Commerce at the London School of Economics and Political Science, 568
- Damour (E.), The Application Value (*valeur d'usage*) of Combustibles, 634
- Dangeard (P. A.), Structure of the Plant Cell and its Metabolism, 251
- Daniel (A.), A New Race of *Asphodelus* Obtained by the Action of a Marine Climate, 506
- Darwin (C. G.), Lagrangian Methods for High-speed Motion, 379
- Darwin (Sir Horace) and W. G. Collins, A Universal Microtome, 570
- Davenport (Dr. C. B.), Influence of the Male on the Production of Twins, 755
- Davidson (the late Sir J. Mackenzie), Proposed Memorial to, 50
- Davies (Rev. A. E.), Anselm's Problem of Truth and Existence, 569
- Davies (G. M.), Tin Ores, 193
- Davies (J. H.), A Map of the World (on Mercator's Projection), having Special Reference to Forest Regions and the Geographical Distribution of Timber Trees, Timber Maps, Nos. 1, 2, 3, 4, 577
- Davis (H. V.), "Little Book about Snowdon," 787
- Davis (Prof. W. M.), The Small Islands of Almost-Atolls, 292
- Davidson (Dr. C.), Differential Calculus for Colleges and Secondary Schools, 65
- Dawson (B. H.), Determination of the Orbit of  $\beta$  Eridani, 84
- Dawson (Dr. H. M.), appointed Professor of Physical Chemistry in the University of Leeds, 409
- Dawson (Sir Philip), Electric Railway Contact Systems, 657
- Dawson of Penn (Lord), presented with the Medal of Honour of the University of Brussels, 440
- Daynes (H. A.), The Process of Diffusion through a Rubber Membrane, 122; The Theory of the Katharometer, 122
- De Angelis (M.), Crystalline Forms of Nitrodichloroacetanilide, 844
- Debenham (F.), The Transfer of Marine Deposits from the Sea-floor to the Surface of Glacier Ice, 724
- De Candolle (A. P.), [obituary], 365
- Dee (A. A.), appointed an Assistant Lecturer in Physics in Birmingham University, 120
- Deeley (R. M.), Anticyclones, 677; The Antarctic Anticyclone, 808
- Defant (Dr. A.), Tides in Landlocked and Border Seas, Bays, and Channels, 466
- De Launay (L.), The Course of the Coal Measures in the Central Massif and at its Edges, 614
- Délepine (M.), Ethylene Sulphide,  $C_2H_4S$ , 666; and L. Ville, The Chloride of Bromine: its Combination with Ethylene, 539
- Délepine (Prof. S.), The Problem of Clean and Safe Milk, 385
- De Lury (Prof. A. T.), The Appointment of, in the University of Toronto, 762
- Demoussy (Dr. E.), Engrais. Amendements Produits anticryptogamiques et Insecticides, 738
- Dendy (Prof. A.), The Plumage Bill and Bird Protection, 169
- Denigès (G.), Iodic Acid as a Microchemical Reagent • Characteristic of Gaseous Ammonia, 763; Iodic Acid as a Microchemical Reagent for Calcium, Strontium, and Barium, 379
- Denning (W. F.), Discovery of a Nova in Cygnus, 838; Fireball of February 4, 1915; The Great Red Spot on Jupiter, 423; Wasps, 328
- Dennis (L. G.), Canadian Water-power Development, 311
- Dennis (T.), An Arithmetic for Preparatory Schools, with Answers, Second edition, 67
- Desch (Prof. C. H.), Some Properties of 60-40 Brass, 695
- Descolas and Prétet, The Macrographic Study of the Propagation of Cooling in the Interior of a Steel Ingot Starting from its Solidification, 411
- Detmold (E. J.), Twenty-four Nature Pictures, 352
- Dévaux (H.) and H. Bouygues, The Usefulness of Sodium Fluoride employed as an Antiseptic for the Preservation of Railway-sleepers, 370
- Dewar (Sir James), elected a Corresponding Member of the French Academy of Sciences, 80
- Dewey (H.), Arsenic and Antimony Ores, 318; Flat-based Celts from Kent, Hampshire, and Dorset, 153
- Dey (M. L.), Fireball of February 4, 1915
- Dickie (R. S.), Economics of the Petroleum Industry, 369
- Dicksee (Prof. L. R.), appointed Professor of Accountancy and Business at the London School of Economics and Political Science, 568
- Dines (J. S.), Methods of Computation for Pilot-balloon Ascents, 837; The Rate of Ascent of Pilot-balloons, 581
- Dines (W. H.), Attainment of High Levels in the Atmosphere, 454; The Ether Differential Radiometer, 570; The Stretching of Rubber in Free Balloons, 613
- Dixey (F.), Pleistocene Movements of Elevation in Sierra Leone, 689

- Dixon (Prof. R. B.), A New Theory of Polynesian Origins, 763
- Dixon (Prof. W. E.), Practical Pharmacology, 420
- Dobbie (Sir James J.), re-elected President of the Chemical Society, 145; and J. J. Fox, The Absorption of Light by Elements in the State of Vapour, 538
- Poidge (Miss Ethel M.), The Haustoria of the Genera *Meliola* and *Irene*, 667
- Dollo (Prof. L.), elected a Foreign Member of the Linnean Society, 366
- Domville-Fife (Lieut. C. W.), Submarine Warfare of Today, 36
- Doncaster (Prof. L.), An Introduction to the Study of Cytology, 190; Genetic Studies of *Drosophila*, 405; [death], 431; [obituary article], 461; Resolution of the Senate of Liverpool University on the Death of, 472
- Doodson, Carey, and Baldwin, The Theoretical Determination of the Longitudinal Seiches of Lake Geneva, 275
- Douglas (Capt. C. K. M.), Clouds as seen from an Aeroplane, 218; Temperature Variations at 10,000 ft., 614
- Douglass (Prof.), The Annual Rings of Trees in Relation to Climate and Solar Activity, 562
- Dowd (Mary T.) and Jean D. Jameson, Food: its Composition and Preparation, 99
- Downing (Prof. E. R.), A Field and Laboratory Guide in Physical Nature-study, 675
- Dowsett (H. M.), Wireless Telegraphy and Telephony: First Principles, Present Practice, and Testing, 483
- Drach (J.), The Spiral Compensator and New Problems of the Mechanics of Regulation, 443
- Dreaper (W. P.), Notes on Chemical Research: An Account of Certain Conditions which apply to Original Investigation, Second edition, 773
- Drew (G. A.), The Spermatophores of *Octopus americana*, 279
- Drummond (Dr. J. C.), appointed Reader in Physiological Chemistry at University College, London, 608
- Dryer (C. R.), "Mackinder's 'World Island' and its American 'Satellite,'" 624
- Drysdale (J. W. W.), [obituary], 590
- Dubois (G.), The Discovery of a Fossil-bearing Layer in the Flanders Clay at Watten (Nord), 705
- Dubrisay (R.), Application of a New Method of Physico-chemical Analysis to the Study of Double Salts, 634
- Duckworth (Dr. W. L. H.), Presentation to, 704
- Duerden (Prof. J. E.), A Stalked Parapineal Vesicle in the Ostrich, 516; Ostrich Study in South Africa, 106; The Plumage Bill and Bird Protection, 263
- Duffield (W. G.), T. H. Burnham, and A. A. Davis, The Pressure upon the Poles of Metallic Arcs, including Alloys and Composite Arcs, 121
- Dufraisse (C.), The Stereo-isomeric Forms of Benzoyl-phenylacetylene Di-iodide, 475
- Dufton (A. F.), A New Apparatus for Drawing Conic Curves, 187; A New Method for Approximate Evaluation of Definite Integrals between Finite Limits, 354, 455
- Duly (S. J.), The Natural Wealth of Britain: Its Origin and Exploitation, 579
- Dunkerley (J. S.), British and Foreign Scientific Apparatus, 425
- Dunn (J. P.), appointed a Lecturer in the Department of Music of the University of Edinburgh, 527
- Dunoyer (L.), Magnetic Induction in the Soft Iron Compass Correctors under the Influence of the Needles, 539
- Durrant (R. G.), Calculation of Vapour Densities, 742
- Dutcher (R. A.), The Nature and Function of the Antineuritic Vitamine, 667
- Dymes (T. A.), The Nature Study of Plants in Theory and Practice for the Hobby Botanist, 804
- Eastman (G.), Gift to the University of Rochester, N.Y., 601
- Eccles (Prof. W. H.), Wireless Telephony, 510
- Eckersley (Capt. P. P.), The Application of Duplex Wireless Telephony to Aircraft, 154
- Eclair-Heath (Principal C. L.), Continuation Schools and their Relation to Technical Institutes and Colleges, 728
- Eddington (Prof. A. S.), Gravitational Deflection of High-speed Particles, 37; Presidential Address to Section A of the British Association, 825; and others, Einstein's Theory of Relativity, 306
- Edgcombe (Major K.), elected Chairman of the National Illumination Committee of Great Britain, 557
- Edgell (Miss), Memory and Conation, 603
- Edgeworth (Lt.-Col. K. E.), Science and the New Army, 233; Sea and Sky at Sunset, 358
- Edrige-Green (Dr. F. W.), appointed a Special Examiner in Colour Vision and Eyesight by the Board of Trade, 654; The Physiology of Vision, with special reference to Colour Blindness; Card Test for Colour Blindness, 575
- Edwards (Prof. C. A.), appointed Professor of Metallurgy at University College, Swansea, 665
- Edwards (F. W.), Mosquitoes, 787
- Einstein (Prof.), awarded the Barnard Medal of Columbia University, 590
- Eisig (Prof. H.), [obituary], 50
- Elgie (J. H.), Elgie's Weather Book: For the General Reader, 739
- Elhuft (L.), General Science: First Course, 352
- Elliott (G. F. Scott), The Trade Routes of the British Empire in Africa, 274
- Ellis (Dr. D.), Iron Bacteria, 323; Iron Depositing Bacteria, 727
- Ellis (G. S. M.), Applied Botany, 164
- Ellis (Havelock), The Philosophy of Conflict: and other Essays in War-time, Second Series, 353
- Ellis (T. S.), Mortalakes as a Cause of River-windings, 264
- Enriques (Prof.), Experiments in Breeding Blow-flies, 756
- Entat (M.), The Destructive Effect of Light on Textiles, Dopes, and Rubberised Fabrics, 758
- Escher (Dr. B. G.), Percussion Figures, 171
- Evans (Dr. E. A.), appointed Professor of Physics at University College, Swansea, 665
- Evans (I. H. N.), A Rock Shelter in the Batu Kurau Parish, Perak, 834
- Evans (Dr. J. W.), Knowledge and Power, 165; Scientific Research, 358
- Eve (Prof. A. S.), Observation of an Aurora in Montreal on March 5, 1917
- Everdingen (Prof. E. van), Aerial Navigation and Meteorology, 637, 776; Investigation of the Upper Air, 663
- Evermann (Dr.), The Present Position of the Northern Fur Seal, 623
- Evershed (J.), The Einstein Displacement of Spectral Lines, 244; and Mrs., The Prominence Observations of, 340
- Evershed (S.), Permanent Magnets in Theory and Practice, 435
- Ewart (Prof. J. C.), The Nestling Feathers of Birds, 250
- Ewing (Sir Alfred), Molecular Energy in Gases, 472
- F.R.S., Museums and the State, 136
- Fabre (J. H.), Translated by A. T. de Mattos, The Mason Wasps, 201; The Story Book of Birds and Beasts, 651; The Story Book of Science, 651
- Failes (Rev. W.), [obituary], 18
- Fallaize (E. N.), Dr. R. Munro, 685; Suggestions for the Classification of the Subject-matter of Anthropology, 626; The Present Condition of the Aborigines of Central Australia, 601
- Fallou (J.), The Expansion caused by Joule's Effect at the Contact of Two Solids, 506
- Farabee (W. C.), Form of Puberty Ordeal among the Apalaki Indians, 240; The Central Arawaks, 159
- Fargher and Pyman, The Composition of Salvarsan, 185
- Farmer (G. W.), A First-year Physics for Junior Technical Schools, 229
- Farrer (R.), awarded the Gill Memorial of the Royal Geographical Society, 112
- Fawcett (W.) and Dr. A. B. Rendle, Flora of Jamaica, Vol. iv., Dicotyledons: Families Leguminosæ to Callitrichaceæ, 738
- Fayet (M.), Tempel's Comet, 789
- Feldman (W. M.), The Principles of Ante-Natal and Post-Natal Child Physiology: Pure and Applied, 638
- Fenton (Dr.) and A. J. Berry, Studies on Cellulose Acetate, 378

- Fernbach (A.) and M. Schoen, New Observations on the Biochemical Production of Pyruvic Acid, 251
- Ferraris' "Dioptric Instruments": Being an Elementary Exposition of Gauss' Theory and its Applications. Translated by Dr. O. Faber from Prof. F. Lippich's German Translation of Prof. G. Ferraris' "The Fundamental Properties of Dioptric Instruments," 542
- Ferry (E. S.), O. W. Silvey, G. W. Sherman, jun., and D. C. Duncan, A Handbook of Physics Measurements, 2 vols., 193
- Fewkes (J. W.), Prehistoric Villages, Castles, and Towers of South-Western Colorado, 367
- Fields (Prof. J. C.), Universities, Research, and Brain Waste, 839
- Filon (Prof. L. N. G.), Science and the New Army, 133
- Findlay (Prof. A.), The Hurter and Driffield Memorial Lecture, 689
- Firth (J. B.), Sorption of Iodine by Carbon, 602
- Firth (Sir R. H.), Musings of an Idle Man, 100
- Fisher (H. A. L.), elected a Fellow of the Royal Society, 556; The Government Offer of a Site for the University of London, 404
- Fisher (Lord), Memories, 95
- Fisher (R. A.), Kenyon and Lovitt's Mathematics for Collegiate Students of Agriculture and General Science, Revised edition, 131
- Flammario (C.), Reform of the Calendar, 22, 105
- Fleck (Dr. A.) and T. Wallace, Conduction of Electricity through Fused Sodium Hydrate, 602
- Fleming (A. P. M.), Engineering Research in the U.S.A., 598; Industrial Research, 771
- Fleming (Prof. J. A.), The Propagation of Electric Currents in Telephone and Telegraph Conductors, Third edition, 611; The Thermionic Valve in Wireless Telegraphy and Telephony, 716
- Fletcher (J. J.), Presidential Address to the Linnean Society of N.S.W., 724
- Fletcher (Sir Walter), The Work of the Medical Research Committee, 400
- Flett (Dr. J. S.), appointed Director of the Geological Survey and Museum, 590
- Flint (G. E.), The Whole Truth about Alcohol, 386
- Flint (H. T.), appointed Lecturer in Physics at King's College, London, 698
- Florentin (M.), The French Experience of German Gas Warfare, 434
- Forbes (Dr. H. O.), The Doctor of Philosophy in England, 234
- Forcrand (Prof. R. de), Cours de Chimie à l'usage des Etudiants P.C.N. et S.P.C.N., Dieux. édition, Tome i. et Tome ii., 63
- Forder (H. G.), Gravitational Deflection of High-speed Particles, 138
- Fornander (Judge), Source and Migrations of the Polynesian Race, 628
- Forrest (H. E.), A Handbook to the Vertebrate Fauna of North Wales, 386
- Forsyth (Prof. A. R.), Solutions of the Examples in a Treatise on Differential Equations, 260; The Central Differential Equation in the Relativity Theory of Gravitation, 186
- Fotheringham (Dr. J. K.), Tycho Brahe, 672
- Fournier d'Albe (Dr. E. E.), The Optophone: An Instrument for Reading by Ear, 295; and Prof. A. Barr, The Optophone, 722
- Fourniols (M.), Utilisation of the Water-power of the Rhone, 466
- Fowler (Prof. A.), elected a Corresponding Member of the Paris Academy of Sciences, 52; Sir Norman Lockyer's Contributions to Astrophysics, 831
- Fowler (Dr. G. J.), Scientific Work: Its Spirit and Reward, 387
- Fowler (R. H.), The Dynamics of Shell Flight, 450; The Elementary Differential Geometry of Plane Curves, 321; E. C. Gallop, C. N. H. Lock, and H. W. Richmond, The Aerodynamics of a Spinning Shell, 377
- Francis (Prof. F.), appointed Pro-Vice-Chancellor of Bristol University, 601
- Francotte (Rev. E.), Meteorological Observations at St. Xavier's College, Calcutta, Part i., 55
- Franklin (Capt. T. B.), Effect of Weather Changes on Soil Temperatures, 282, 628
- Fraser (Dr. A. M.), The Prevention of Venereal Diseases, 114
- Fraser (P.), appointed Deputy Dean of the Faculty of Science of Bristol University, 630
- Frazer (Sir James G.), elected a Fellow of the Royal Society, 556
- Frederiksen (J. D.), The Story of Milk, 229
- Freeman (W. G.) and others, Cultivation of the Avocado or Alligator Pear, 408
- Fremont (Ch.), The Resistance of Steels to Cutting by Tools, 187; Work Done in Sawing Metals by Hand, 251
- Freundlich (Dr. E.), The Foundations of Einstein's Theory of Gravitation, Translated by H. L. Brose, 350
- Friedel (Prof. G.), Opening Address on the Installation of the Chair of Mineralogy at the University of Strasbourg, 368
- Fullarton (Dr. J. H.), [obituary], 365
- Fuller (Brevet-Col. J. F. C.), Tanks in the Great War, 1914-1918, 702
- Fulton (A. R.), Earthworks and Retaining Walls, 88
- Gadow (H.), appointed Reader in the Morphology of Vertebrates in Cambridge University, 345
- Gallenkamp and Co., Ltd., List of Graduated Instruments for Volumetric Analysis, 306
- Gamble (J. S.), Flora of the Presidency of Madras, Part iii., 36; Organisation of Scientific Work, 6
- Gamble (W.), Photography and its Applications, 740
- Gardiner (Prof. J. Stanley), Museums and the State, 101; Presidential Address to Section D of the British Association, 826; to Undertake the Temporary Direction of the Scientific Work of the Fisheries Department of the Ministry of Agriculture and Fisheries, 52
- Garner (W. E.), An Electronic Theory of Isomerism, 171
- Garner (W. W.) and H. A. Allard, Light and Plant-growth, 404
- Garnett (J. C. M.), A National System of Education, 728; Resignation of the Principals of the Manchester College of Technology, 630
- Garrod (Sir Archibald E.), appointed Professor of Medicine in the University of Oxford, 25; to receive the Honorary Degree of M.D. from the University of Dublin, 89
- Gascard (A.), Ceryl Alcohol and Cerotic Acid from China Wax, 506; The Melissic Alcohol of Brodie, 314
- Gatenby (J. B.), The Modern Technique of Cytology, 463
- Gates (Dr. R. R.), The Meiotic Phenomena in the Pollen Mother-cells and Tapetum of Lettuce, 186, 756
- Gault (H.) and R. Weick, A Case of Isomerism in the Series of the Aromatic  $\alpha$ -Ketonic Acids, 539
- Gauthier (D.), The Synthesis of  $\alpha$ -Ketonic Tertiary Alcohols, 27
- Gautier (Ch.), A Sundial giving Legal Time throughout the Year, 506
- Gayley (J.), [obituary], 239
- Geddes (Sir Auckland C.), appointed Ambassador Extraordinary and Plenipotentiary in Washington; Resignation of the Principals of McGill University, 17
- Gee (W. J.), A New Process for Centrifugal Filtration, 696
- Geikie-Cobb (Dr. W. F.), Mysticism, True and False, 633
- Gentil (L.), The Mode of Formation of Terraces in Chalk Districts, 315
- George (W. L.), The Birth-rate, 82
- Georges (H.), A New Alternating Mercury Arc, 91
- Gerhardt (Charles), Proposed Monument to, 436
- Giaya (S.), Zinc in the Human Organism, 315
- Gibson (C. R.), Chemistry and its Mysteries: The Story of what Things are made of, Told in Simple Language, 99
- Gilbreth (F. B. and Dr. L. M.), Motion Study for the Handicapped, 737
- Gill (J. F.), and F. J. Teago, Examples in Electrical Engineering, 195
- Gill (T. P.), Impending Resignation from the Secretaryship of the Department of Agriculture and Technical Instruction for Ireland, 376



- Gilmore (C. W.), A Skeleton of Dimetrodon from the Permian of Texas, 118
- Gilmour (W. H.), appointed Professor of Dental Surgery in Liverpool University, 630
- Ginsberg (M.), Is there a General Will?, 155
- Giua (Prof. M.), *Chimica delle Sostanze Esplosive*, 483
- Glaugaud (Ph.), *The Geyser of Martres d'Artières (Puy-de-Dôme)*, 315
- Glazebrook (Sir Richard), elected First President of the Institute of Physics, 304; Lectures on Aeronautics, 214
- Glennie (R. S.), appointed Chief Lecturer in Pharmaceutics in the Royal Technical College, Glasgow, 841
- Godchot (M.), *The Oxidation of Coal*, 666
- Goddard (Prof. R. H.), *A Method of Reaching Extreme Altitudes*, 809
- Godfrey (E. H.), *Fifty Years of Canadian Progress*, 147
- Gold (Lt.-Col. E.), *Aerial Navigation and Meteorology*, 775; *Science and the New Army*, 135
- Goodwin (Vice-Admiral Sir George), *Progress in Naval Engineering*, 235
- Goodwin (Gen. Sir John), *Army Hygiene Prior to the Recent War*, 52; *Army Hygiene and its Lessons*, 532; *Military Hygiene*, 114
- Goold (J.), *The Musical Scale*, 666
- Gordon (A.), *The Nesting Habits of the Storm-Petrel*, 20
- Gordon (G. F. C.), appointed Superintendent of the Engineering Workshops of Cambridge University, 345
- Gordon (Dr. W. T.), *Archaeocyathinae from the Moraine of the Beardmore Glacier*, 528
- Gorgas (Maj.-General W. C.), [death], 590; [obituary article], 620
- Goris (A.), *The Chemical Composition of the Tubercle Bacillus*, 604
- Gossling (B. S.), *Development of Thermionic Valves for Naval Uses*, 559
- Gough (G. W.), *Half-past Twelve: Dinner-hour Studies for the Odd Half-hours*, 611
- Gouineau (M.), *Verification of the Thermo-electricity of Liquid Mercury*, 634
- Graham (Dr. G. W.), *Volcanic Rocks in the Anglo-Egyptian Sudan*, 199
- Graham (Dr. M.), *The Alligator Pear*, 517; *The Cluster Pine*, 675
- Grace (J. H.), re-appointed University Lecturer in Mathematics in Cambridge University, 505
- Graham (Dr. G.), appointed Goulstonian Lecturer of the Royal College of Physicians of London, 1921, 755
- Graham (J. I.), *Apparatus for the Estimation of Carbon Monoxide in the Air of Mines*, 624
- Gramont (A. de), *The Spectrographic Detection of Metals, especially Zinc, in Animal Organisms*, 411
- Granger (R. F. T.), *Meteorological Conditions of an Ice-cap*, 709
- Grassi (Prof. B.), awarded a Mary Kingsley Medal, 697
- Gray (H. St. George), *Use of Graphs in Society and Museum Statistics*, 463
- Gray (Mrs. R.), *The Collection of Lower Palaeozoic Fossils of, to be purchased by the British Museum*, 336
- Green (J. F. N.), *The Vulcanicity of the Lake District*, 242
- Greenhill (Sir George), *Artillery Science*, 268
- Greenwood (H. W.), *Barytes in the English Triassic Strata Derived from Overlying Jurassic Strata*, 837
- Gregory (Prof. J. W.), *Meteorological Influences of the Sun and the Atlantic*, 715; *Museums and the State*, 68; *The Conservation of our Coal Supplies*, 108; *The Irish Eskers*, 346
- Gregory (Sir Richard), *Plea for a National Survey of the Conditions and Requirements of University and Higher Technical Education in the Country*, 281; *Scientific and Technical Books*, 41
- Gregory (T. E. G.), appointed a Reader in Commerce at the London School of Economics and Political Science, 568
- Grey (E. C.), *The Enzymes of *B. coli communis* which are Concerned in the Decomposition of Glucose and Mannitol, Part iv.*, 538
- Grierson (Sir George), elected a Fellow of the Royal Danish Society of Science, 200; *The Indo-Aryan Vernaculars*, 557; *The Linguistic Survey of India*, 688
- Griffith (A. A.), *The Phenomena of Rupture and Flow in Solids*, 58
- Grinnell (J.) and J. Dixon, *Life-histories of Ground-squirrels in California*, 81
- Grist (W. R.), appointed Secretary of the Leeds University Appointments Board, 698
- Gros (F.), *Improvements Relating to the Commercial Production of Oxides of Nitrogen in Arc Furnaces*, 283
- Groves (C. E.), *Bequests of*, 145
- Gruzewska (Mme. Z.), *Study of Laminaria from *Laminaria flexicaulis**, 187
- Gudger (E. W.), *The Ovary of *Felichthys felis**, 279
- Guerbet (M.), *A Reaction for Benzoic Acid Based on its Diazoitization*, 666
- Guérin (P.) and A. Goris, *A New Plant Containing Coumarin, *Melettis melissophyllum**, 411; and Ch. Lormand, *The Action of Chlorine and Various Vapours upon Plants*, 59
- Guérithault (B.), *Presence of Copper in Plants, and particularly in Food of Vegetable Origin*, 763
- Guglielminetti (Dr.), *The Physiological Aspect of Flying at High Altitudes*, 491
- Guiche (A. de Gramont de), *Work of the Institute of Optics of France*, 466
- Guild (J.), *The Use of Vacuum Arcs for Interferometry*, 842
- Guillaume (Dr. Ch. Ed.), *Action of Metallurgical Additions on the Anomaly of Expansion of the Nickel Steels*, 571; *The Anomaly of Elasticity of the Nickel Steels*, 699; *The Anomaly of the Nickel Iron Alloys: Its Causes and its Applications*, 438; *Values of the Expansions of Standard Nickel Steels*, 634
- Guillaume (J.), *Observations of the Sun made at the Lyons Observatory*, 218, 251
- Guillet (A.), *An Auto-ballistic Astronomical Pendulum*, 506; and M. Aubert, *An Absolute Bispherical Electrometer*, 59
- Guillet (L.), *The Alloys of Copper, Zinc, and Nickel*, 91; and M. Gasnier, *The Plating with Nickel of Aluminium and its Alloys*, 475
- Gunton (Major H. C.), *Entomological-meteorological Records of Ecological Facts in the Life of British Lepidoptera*, 26
- Gurney (J. H.), *Ornithological Notes from Norfolk for 1919*, 81
- Gurney-Dixon (Dr. S.), *The Transmutation of Bacteria*, 131
- Guthrie (Lord), [obituary], 302
- Gutteridge (H. C.), appointed Professor of Commercial and Industrial Law at the London School of Economics and Political Science, 568
- Guyon (Prof. J. C. F.), [obituary article], 721
- Guyot (J. and L. J. Simon), *Combustion of Methyl Esters with a Mixture of Sulphuric and Chromic Acids*, 187; *Combustion of Mixtures of Sulphuric and Chromic Acids of Organic Bodies Containing Chlorine*, 251
- H. (G. W. O.), *University Stipends and Pensions*, 582
- Hadfield (J. E.), appointed Lecturer in Psychology at King's College, London, 608
- Hadley (L.), *The Elements of *Ç' Ursæ Majoris**, 244
- Hadwen (Dr. S.), *Resignation of the Post of Chief Pathologist of the Biological Laboratory, Health of Animals Branch, Canadian Department of Agriculture, and appointed Chief Pathologist in the Reindeer Investigations of the U.S. Biological Survey*, 623
- Halbert (J. N.), *Acarina of the Intertidal Zone*, 474
- Haldane (Viscount), *Prof. Alexander's Gifford Lectures*, 708
- Hale (Dr. G. E.), elected an Honorary Member of the Royal Irish Academy, 113; *Some Tests of the 100-in. Hooker Telescope*, 266
- Haleole (S. N.), *The Functions of the *Kahuna**, 628
- Hall (A. L.), *The Mica Industry in Eastern Transvaal*, 787
- Hall (Sir Daniel), *Development and Use of Allotments*, 371; *Social and Gardening and Food Production*, 371; *Social and Hygienic Conditions respecting Gardens and Allotments*, 371; *The Soil: An Introduction to the Scientific Study of the Growth of Crops*. Third edition, 384
- Hall (Dr. G. Stanley), *Resignation of the Presidency of Clark University*, 602

- Hall (H. V.), African Art, 180  
Hall (Maxwell), [obituary], 302  
Haller (A.) and R. Cornubert, The Constitution of the Dimethylcyclohexanone obtained by Methylation of the Sodium Derivative of  $\alpha$ -Methylcyclohexanone, 250; The Constitution of the Methylthylcyclohexanone prepared by the Ethylation of  $\alpha$ -Methylcyclohexanone, 379; and Mme. Ramart-Lucas, Bromohydrins and Dibromoderivatives, 762  
Halliburton (Prof. W. D.), The Essentials of Chemical Physiology. Tenth edition, 192  
Hansen (Lieut. G.), Leading a Supporting Expedition for Amundsen's Trans-Polar Voyage, 82  
Hansen (Dr. H. J.), The Cumacea and Phyllocarida in the Seas round Iceland and South Greenland, 81  
Harden (Dr. A.), and Dr. S. S. Zilva, The Antiscorbatic Requirements of the Monkey, 493  
Harder (E. C.), Iron Depositing Bacteria and their Geologic Relations, 727  
Harding (Dr. V. J.), appointed Professor of Pathological Chemistry in the University of Toronto, 537  
Hardy (G. H.), Synonyms, Notes, and Descriptions of Australian Flies in the Family Asilidae, 635  
Hardy (Prof. G. H.), S. Ramanujan, 494; The Cost of Scientific Publications, 353  
Hardy (Dr. M. E.), The Geography of Plants, 386  
Harker (Dr. A.), Petrology for Students: An Introduction to the Study of Rocks under the Microscope. Fifth edition, 99  
Harkins (Prof. W. D.), The Separation of the Element Chlorine into Normal Chlorine and Meta-Chlorine, and the Positive Electron, 230  
Harper (F.), The Okefinokee Swamp, Georgia, 593  
Harrison (J. W. H.), Melanism in British Lepidoptera, 278  
Harrison (W. J.), The Theory of Vibrations, 473  
Hartog (P. J.), appointed Vice-Chancellor of the University of Dacca, 569  
Hartridge (Dr. H.), Microscopic Illumination, 275  
Harvey (A.), Practical Leather Chemistry, 382  
Harvey (Prof. E. N.), Animal Luminescence and Stimulation, 843; Chemistry of Light Production in Luminous Organisms, 279  
Harvey-Webb (the late Capt. G. D.), Gift by the Relatives of to University College, London, 155  
Hatfield (Dr. W. H.), and H. M. Duncan, The Mechanical Properties of Turbine Steels, 148  
Hatschek (E.), Laboratory Manual of Elementary Colloid Chemistry, 705  
Hatton (Prof. J. L. S.), The Theory of the Imaginary in Geometry, together with the Trigonometry of the Imaginary, 736  
Houghton (J. L.), Measurement of Electrical Conductivity in Metals and Alloys at High Temperatures, 602  
Houghton (S. H.), The Reptilian Fauna of the Karroo System, 837  
Haupt (Prof. P.), The Beginning of the Fourth Gospel, 764  
Haviland (Miss Maud D.), Preliminary Note on Antennal Variation in an Aphid (*Myzus ribis*, Linn.), 378  
Haworth (Dr. H. F.), Measurement of Electrolytic Resistances using Alternating Currents, 602  
Haworth (Dr. W. N.), appointed Professor of Organic Chemistry at Armstrong College, 537  
Hayata (B.), The Flora of the Island of Formosa, 664  
Hayward (Dr. F. H.), A First Book of School Celebrations, 707; A Second Book of School Celebrations, 804  
Head (Dr. H.), elected an Honorary Fellow of Trinity College, Cambridge, 88; Sensation and the Cerebral Cortex, 363  
Heath (Sir Thomas L.), elected an Honorary Fellow of Trinity College, Cambridge, 88; Euclid in Greek. Book I. With Introduction and Notes, 288  
Hedrick (U. P.), Manual of American Grape-growing, 674  
Heenan (H.), [obituary], 555  
Heilbron (Prof. I. M.), appointed Professor of Organic Chemistry in the University of Liverpool, 537  
Heiland (W. E.), Agriculture in Italy in Imperial Times, 557  
Hele-Shaw (Prof. H. S.), The Title of Emeritus Professor of Engineering Conferred upon, by Liverpool University, 841  
Holland-Hansen (Dr. B.), and Dr. F. Nansen, Temperature Variations in the North Atlantic Ocean and in the Atmosphere, 715  
Henderson (G. S.), Practical Salt-Land Reclamation, 434  
Henderson (G. T.), awarded a Frank Smart Prize of the University of Cambridge, 537  
Henderson (Dr. J. A. R.), Alchemy and Chemistry among the Chinese, 474  
Henri (Dr. V.), Etudes de Photochimie, 640  
Henry (Prof. A.), Forests, Woods, and Trees in Relation to Hygiene, 158  
Henson (G. W.), and S. H. Fowles, The More Economical Utilisation of the Coke-oven and Blast-furnace Gases for Heating and Power, 695  
Herdman (Prof. W. A.), Oceanography and the Sea-Fisheries (Presidential Address to the British Association), 813; The Cost of Scientific Publications, 326  
Héricourt (Dr. J.), Translated, and with a Final Chapter, by B. Miail, The Social Diseases: Tuberculosis, Syphilis, Alcoholism, Sterility, 543  
Heritsch (Dr. F.), Discovery of Tabulate Corals in the Supposed Mesozoic Mantle of the Hohe Tauern, 836  
Herkless (Ppl. Sir John), [obituary], 495  
Herman (C. L.), The Platana of the Cape Peninsula, 700  
Heron (F. A.), Gifts to Queen's University, Belfast, 248  
Heron-Allen (E.), and A. Earland, An Experimental Study of the Foraminiferal Species *Verneuilina polystrophia*, Reuss, etc., 282  
Herrera (A. L.), The Imitation of Cells, Tissues, Cell-division, and the Structure of Protoplasm with Calcium Fluosilicate, 635  
Hetherington (Prof. H. J. W.), appointed Principal of Exeter University College, 280  
Hewitt (Dr. C. Gordon), [death], 18; [obituary article], 75  
Hewitt (J.), Survey of the Solifugae of South Africa, 275  
Hewitt (Dr. J. A.), appointed Lecturer and Demonstrator in Physiology at King's College, London, 698  
Heycock (C. T.), Presidential Address to Section B of the British Association, 825  
Hicks (Prof. G. Dawes), The Ultimate Data of Physics, 446  
Hickson (Prof. S. J.), Science in Medical Education, 643; elected an Honorary Fellow of Downing College, Cambridge, 761  
Higham (J.), appointed Lecturer in Physics and Electrical Engineering in Manchester University, 698  
Hildt (E.), The Hydrolysis of the Polysaccharides, 603  
Hiley (W. E.), The Fungal Diseases of the Common Larch, 639  
Hilger (Adam), Ltd., Catalogue of Wave-length Spectrometer, etc., 369  
Hill (A. V.), and W. Hartree, The Thermo-elastic Properties of Muscle, 537  
Hill (C. A.), Progress in Science and Pharmacy, 659  
Hill (J. G.), Telephonic Transmission, Theoretical and Applied, 418  
Hillebrand (W. F.), Analysis of Silicate and Carbonate Rocks, 836  
Hillhouse (P. A.), Degree of D.Sc. conferred upon, by Glasgow University, 568  
Hilliar (H. W.), The Pressure-wave Thrown Out by Submarine Explosions, 313  
Hills (Col. E. H.), Science and the New Army, 103  
Hilton-Simpson (M. W.), Flint-trimming in Algeria, 81  
Hind (Dr. Wheelton), [obituary], 555  
Hinks (A. R.), The Total Solar Eclipse of September 20, 1922, 84  
Hinton (M. A. C.), Rats and the Need of Repressive Measures, 756  
Hiorns (A. H.), [obituary], 335  
Hirst (H.), Scorpions, Mites, Ticks, Spiders, and Centipedes, 787  
Hitchcock (A. S.), and P. C. Standley, Flora of the District of Columbia and Vicinity, 242  
Hobbs (Prof. W. H.), The Mechanics of the Glacial Anticyclone, illustrated by Experiment, 644  
Hobson (Dr. F. G.), New Aspects in the Assessment of Physical Fitness, 812  
Hodge (E. T.), The Geological History of Porto Rico, 593

- Hogan (M. A.), elected to a Beit Fellowship for Scientific Research, 665
- Hogarth (Dr. D. G.), Discoveries in the Hejaz, 528
- Hogben (L. T.), Studies on Synapsis, ii., 539; The Problem of Synapsis, 570
- Holden (H. F.), elected to the Benn W. Levy Research Studentship in Biochemistry in Cambridge University, 601
- Holland (Sir Thomas H.), The Organisation of Scientific Work in India, 452
- Holmes (Dr. G. M.), appointed Croonian Lecturer of the Royal College of Physicians of London, 1922, 755
- Holt and Co., Ltd. (A.), Gift to the Liverpool University Appeal Fund, 376
- Holtedahl (Dr.), The Distribution of Land and Water in the North Atlantic Region in Palaeozoic Times, 212; The Scandinavian Mountain Problem, 613
- Holthum (R. E.), awarded a Frank Smart Prize of the University of Cambridge, 537
- Hooper (Miss L.), Shamanism among the Cahuilla Indians, 592
- Hopkins (Prof. F. Gowland), The Present Position of Vitamins in Clinical Medicine, 722
- Hopwood (Dr. F. L.), The Thermionic Properties of Hot Filaments, 473
- Horner (D. W.), Meteorology for All: Being Some Weather Problems Explained, 323
- Horsfall (B.), Habits of the Sage Grouse, 786
- Horton (Dr. F.), and Ann C. Davies, The Effects of Electron Collisions with Atmospheric Neon, 633
- Housman (W. B.), The Aurora of March 22-23, 200
- Houston (Dr. R. A.), An Experiment on the Spectrum, 421
- Howard (A. L.), The Empire Timber Exhibition, 691
- Howard (B. F.), and O. Chick, Some Recent Samples of "Grey" Cinchona Bark, 726
- Howell, Jun. (B. F.), The Middle Cambrian Beds at Manuels, Newfoundland, and their Relations, 843
- Howorth (Sir Henry), Presentation of Mammalian and other Remains to the Natural History Museum, 209; and others, Buddhism in the Pacific, 407
- Hoy (C. M.), Extinction of the Australian Native Fauna, 558
- Hoyle (Dr. W. E.), Museums and the State, 69
- Hubble (E. P.), Faint Nebulae, 84
- Hudson (W. H.), Birds in Town and Village, 651; The Book of a Naturalist, 651
- Hughes (E. E.), appointed Lecturer in History at University College, Swansea, 665
- Hughes (T. H.), Gift to the Appeal Fund of Liverpool University, 345
- Hughes (W. E.), The Deposition of Iron by Electrolysis, 594; The Uses of the Electro-deposition of Metals, 339
- Hull (L. M.), A Device for Obviating the Use of the High Voltages required in Wireless Telegraphy, 624
- Humberstone (T. L.), The Industrial Fellowship System for the Promotion of Industrial Research, 665
- Huntington (Prof. A. W.), [death], 239; [obituary article], 271
- Hurst (H. E.), Records of the Nile Gauges. 1913 to 1918, 275
- Hurter (Ferdinand), and Vero C. Driffield, A Memorial Volume containing an Account of the Photographic Researches of, Being a Reprint of their Published Papers, together with a History of their Early Work, and a Bibliography of Later Work on the Same Subject, Edited by W. B. Ferguson, 609
- Husband (J.), appointed Professor of Civil Engineering in Sheffield University, 601
- Hutchinson (R. W.), Intermediate Text-book of Magnetism and Electricity, 515
- Hyatt (J. W.), [obituary], 462
- Hyde (E. P.), P. W. Cobb, H. M. Johnson, and W. Weniger, Report on the Relative Merits of Monocular and Binocular Field-glasses under Service Conditions, 243
- Hyde (J. H.), The Viscosities and Compressibilities of Liquids at High Pressure, 57
- Hyslop (Dr. J. H.), [death], 555
- I. (F. O.), Knowledge and Power, 165
- Ifford, Ltd., Panchromatism. Second edition, 306
- Imms (Dr. A. D.), and others, The Investigation of Grain Pests, 236; The Training of Practical Entomologists, 676
- Inchley (Dr. O.), appointed Lecturer in Pharmacology at King's College, London, 608
- Innes (R. T. A.), A Search for Proper Motions by the Blink Method; Galactic Condensation, 759
- Inge (Dean W. R.), elected President of the Aristotelian Society, 622; The Idea of Progress, 431
- Ingle (H.), Elementary Agricultural Chemistry. Third edition, 773
- Inostraness (Prof. A. A.), [obituary], 525
- Jackson (Prof. A. V. W.), The Zoroastrian Doctrine of the Freedom of the Will, 763
- Jackson (Dr. B. Daydon), Banks as a Traveller, 530; The Cost of Scientific Publications, 354
- Jackson (Sir Herbert), elected President of the Institute of Chemistry, 19
- Jackson (J.), Double Stars, 436
- Jackson (V. G.), Cultivation of the Vine in America, 674
- Jacobson (E.), and C. B. Kloss, The Sumatran Hare (*Nesolagus Netscheri*), 115
- Jaffrey (Sir Thomas), Gift to Aberdeen University, 154
- James (Rev. E. O.), An Introduction to Anthropology: A General Survey of the Early History of the Human Race, 384
- Jardine (E. E.), Practical Science for Girls: As Applied to Domestic Subjects, 705
- Jarry-Desloges (R.), Different Phenomena observed on the Planet Mars, 603
- Jastrow, junr. (Prof. M.), A Gentle Cynic: Being a Translation of the Book of Koheleth, commonly known as Ecclesiastes, stripped of Later Additions; also its Origin, Growth, and Interpretation, 226; The Hittite Civilisation, 763
- Jeans (J. H.), Problems of Cosmogony and Stellar Dynamics, 31
- Jee (Dr. E. C.), Fishery Investigations. Ser. III. Hydrography, Vol. I.; The English Channel, Part II.; Vol. II., Lightship Observations, Part I.; Vol. III., The Atlantic Ocean, Part I., 150
- Jeffery (G. B.), Plane Stress and Plane Strain in Bipolar Co-ordinates, 632
- Jeffreys (Dr. H.), Gravitational Shift of Spectral Lines, 37; Tidal Friction and the Lunar and Solar Accelerations, 403; Tidal Friction in Shallow Seas, 632
- Jellicoe (Lord), The Grand Fleet, 1914-16, 93
- Jenkin (C. F.), Presidential Address to Section G of the British Association, 827
- Jenkins (Dr. J. T.), The Sea Fisheries, 397
- Jensen (P. B.), The Fish-food in the Limfjord, 1900-1917, 527
- Job (P.), and G. Urbain, Detection of Masked Sulphuric Ions in Complex Compounds, 283
- Johansen (Dr. A. C.), and Dr. Kirstine, Intensive Fishing, 216
- Johnson (Dr. S. C.), Pastimes for the Nature Lover, 774; Wild Fruits and How to Know Them, 774
- Johnson (Sir H. H.), The Plumage Bill and Bird Protection, 168
- Johnson (Lt.-Col. W. J.), New Editions of the One-inch and Quarter-inch Ordnance Survey Maps, 312
- Jolibois (P.), and P. Bouvier, The Precipitation of Mercuric Salts by Sulphuretted Hydrogen, 603
- Jolliffe (A. E.), appointed Professor of Mathematics at the Royal Holloway College, 568
- Jolly (W. A.), The Reflex Times in *Xenopus laevis*, 699
- Jones (D. W.), Chemical Sheet-Lead, 695
- Jones (E. G.), Chemistry for Public Health Students, 705
- Jones (Prof. E. T.), The Action of the Induction Coil, 360
- Jones (Ll. Rodwell), appointed a Lecturer in Commerce at the London School of Economics and Political Science, 568
- Jones (Sir Robert), awarded the Cameron Prize of the University of Edinburgh, 622

- Jordan (M. E. C.), elected a Foreign Associate of the U.S. National Academy of Sciences, 463
- Joynt (T. A.), appointed a Lecturer in Commerce at the London School of Economics and Political Science, 568
- Kamakau, Ancient Religious Ceremonies of the Hawaiians, 628
- Kapp (Prof. G.), The Principles of Electrical Engineering and their Application. Vol. II., Application, 418
- Kapteyn (Prof. J. C.), Researches on the Stellar System, 838
- Karpinski (Prof. L. C.), Prof. H. Y. Benedict, and Prof. J. W. Calhoun, Unified Mathematics, 162
- Keane (Prof. A. H.), Man: Past and Present. Revised, and largely re-written, by Mrs. A. H. Quiggin and Dr. A. C. Haddon, 255
- Keane (Dr. C. A.), The Sir John Cass Technical Institute, 121
- Keeble (Prof. F. W.), Presidential Address to Section M of the British Association, 828
- Keen (B. A.), Physical Problems in Soil Cultivation, 438
- Keeping (H.), "Reminiscences," 624
- Keith (Prof. A.), How Far Can Osteological Characters Help in Fixing the Antiquity of Human Remains?, 153; The Engines of the Human Body: Being the Substance of Christmas Lectures given at the Royal Institution of Great Britain, Christmas, 1916-1917, 195; The Mathematician as Anatomist, 767
- Kellogg (Prof. V.), The United States National Research Council, 332
- Kelly (R. J.), Donnybrook Fair, 433
- Kennedy (J.), [obituary], 555
- Kennelly (Dr. A. E.), The Transient Process of Establishing a Steady Alternating Electric Current on a Long Line from Laboratory Measurements on an Artificial Line, 843
- Kenyon (Prof. A. M.), and Prof. W. V. Lovitt, Mathematics for Collegiate Students of Agriculture and General Science. Revised edition, 131.
- Kershaw (J. B. C.), Fuel, Water, and Gas Analysis for Steam Users. Second edition, 227
- Kessler (D. W.), Tests of the Physical and Chemical Properties of Commercial Marbles of the United States, 181
- Kestner (P.), presented with the Gold Medal of the Society of Chemical Industry, 654
- Kidston (Dr. R.), Presentation of Mesozoic Fossil Plants to the Geological Department of the University of Edinburgh, 280; and Prof. Lang, *Asteroxylon Mackieii* from the Rhyolite Chert-bed of Aberdeenshire, 527
- Kienast (A.), Equivalence of Different Mean Values, 474
- Kiess (C. C.), and W. F. Meggers, The Infra-red Arc Spectra of Seven Elements, 726
- Kincer (J. B.), Sunshine in the United States, 791
- Kinch (Prof. E.), [obituary], 784
- King (A. S.), The Zeeman Effect in Furnace Spectra, 529
- King (H. H.), Entomological Work in the Anglo-Egyptian Sudan, 503
- King (Dr. L. V.), appointed Macdonald Professor of Physics at the Macdonald Physics Building, McGill University, 721
- Kingdon (K. H.), Low-voltage Ionisation Phenomena in Mercury Vapour, 632
- Kingzett (C. T.), Popular Chemical Dictionary, 227
- Kirkaldy (J.), [obituary], 784
- Kitchin (F. L.), and J. Pringle, A Mass of Gault and Cenomanian Strata Inverted on Lower Greensand, 836
- Kling (A.), and D. Florentin, The Differentiation of Masked and Apparent Sulphuric Ions in Complex Salts, 379; and A. Lassieur, The Separation of Tin and Antimony, 442
- Knecht (Prof. E.), Alpine Insolation Effects on Unprotected Wood, 90
- Knibbs (N. V. S.), and H. Palfreeman, The Theory of Electro-chemical Chlorate and Perchlorate Formation, 602
- Knobel (E. B.), The Cost of Scientific Publications, 327
- Knoop (D.), appointed a Reader in Commerce at the London School of Economics and Political Science, 568; appointed Professor of Economics in Sheffield University, 665
- Knott (Dr. C. G.), Cost of Scientific Publications, 425; Earthquake Waves and the Elasticity of the Earth, 730
- Kobold (Prof.), Astronomical Announcements by Wireless Telegraphy, 403
- Kodak, Ltd., Circular Light-filters for Work with the Microscope, 435
- Kofoed (Prof. C. A.), Noctiluca, 433
- Konno (S.), The Heat Conductivities of Metals Below and Above Their Melting Points, 181
- Konstant (E. M.), Land Drainage from the Administrative Point of View, 42
- Kopaczewski (W.), A. H. Roffo, and Mme. H. L. Roffo, Anæsthesia and Anaphylaxis, 540
- Korczynski (A.), W. Mrozinski, and W. Vielau, New Catalytic Elements for the Transformation of Diazo-compounds, 763
- Krempf (A.), The Development of *Pocillopora cespitosa* and *Seriatorpora subulata*, 380
- Kroeber (Prof. A. L.), Peoples of the Philippines, 420
- Kromm (F.), A Star with a Large Proper Motion, 282
- Kténas (C. A.), The Hydrocarbon Zone of Western Greece, 251
- Lacroix (A.), An Eruption of the Karthala Volcano at Grand Comore in August, 1918, 666; The Eruption of Katla (Iceland), in 1918, 314
- Lacroix (F. A. A.), elected a Foreign Associate of the U.S. National Academy of Sciences, 463
- Lalesque (Dr. F.), Arcachon, Ville de Santé: Monographie Scientifique et Médicale, 322
- Lamb (C. G.), Notes on Magnetism, 193
- Lamb (Prof. H.), elected an Honorary Fellow of Trinity College, Cambridge, 88
- Lamb (J.). The Running and Maintenance of the Marine Diesel Engine, 290
- Lamplugh (G. W.), Anticlinal Uplift the Sequel to Deposition in a Gradually Deepening Trough, 338; Some Features of the Pleistocene Glaciation of England, 58
- Lang (H.), The Pygmies of Central Africa, 367
- Lang (Dr. W. D.), Old Age and Extinction in Fossils, 212
- Langmuir (L.), Theories of Atomic Structure, 261
- Lankester (Sir E. Ray), Museums and the State, 100; Presentation of the Gold Medal of the Linnean Society, 526; Progress!, 733; re-elected President of the Marine Biological Association, 303; Some Rostrocarinate Flint Implements and Allied Forms, 631
- Lapicque and Brocq-Rousseu, Marine Algae as Food for the Horse, 635
- Lapworth (Prof. A.), Latent Polarities of Atoms and Mechanism of Reaction, with Special Reference to Carbonyl Compounds, 346
- Lapworth (Prof. C.), [death], 76; [obituary article], 110
- Larmor (Sir Joseph), elected a Corresponding Member of the French Academy of Sciences, 113; Oration in Presentation of an Honorary Degree to, 568
- Latter (O. H.), Note on the Habits of the Tachinid Fly, *Sphæxapata (Miltogramma) conica*, 614
- Laucks (I. F.), Commercial Oils: Vegetable and Animal, with Special Reference to Oriental Oils, 132
- Lavington (F.), appointed Girdlers' Lecturer in Economics in Cambridge University, 601
- Laws (B. C.), Conferment of the Degree of D.Sc. upon, by the University of London, 409
- Layard (Miss Nina F.), Worked Flints with Finger-grips, 557
- Lazarus-Barlow (Dr. W. S.), appointed Professor of Experimental Pathology at Middlesex Hospital Medical School, 668
- Le Bon (G.), Certain Antagonistic Properties of Various Regions of the Spectrum, 571
- Lecat (Dr. M.), La Tension de Vapeur des Mélanges de Liquides: L'Azéotropisme. Première Partie, 129
- Lee (H. A.), and H. S. Yates, The "Pink Disease" in the Philippines, 115
- Lee (Miss R. M.), The Scale-markings of Fishes, 275
- Leechman (D.), The Present State of the Patent Law in the Light of the New Patent Act, 366

- Leffingwell (E. de K.), The Canning River Region, Northern Alaska, 559
- Lefroy (Prof. H. Maxwell), The Plumage Bill and Bird Protection, 168; and others, The Education of Economic Entomologists, 503
- Legroux (R.), and J. Mesnard, Vitamines for the Culture of Bacteria, 315
- Leiper (Prof. R. T.), awarded a Mary Kingsley Medal, 697
- Leishman (Sir William), to Deliver the Horace Dobell Lecture, 722
- Lemarchands (M.), The Reactions of the Metallurgy of Zinc, 282
- Lempriere (Dr.), Indices of Physical Progress, 26
- Leonard (A. G. G.), and Agnes Browne, Some Derivatives of Nitrotoluidine, 634
- Leslie (C. D.), [obituary], 19
- Lespiau and Borguel, Production of True Acetylene Hydrocarbons starting from Epidibromhydrin, 635; and Garreau, The Phenylpropines, 699
- Lester (J. H.), elected Chairman of the Chemical Section of the Manchester Literary and Philosophical Society, 335
- Levi-Civita (T.), Harmonics in the Neighbourhood of an Assigned Function, 844
- Levinstein (Dr. H.), The Close Co-operation of the German Government and the "Interessen Gemeinschaft," 722
- Lewes (the late Prof. V. B.), and Prof. J. S. S. Brame, Service Chemistry. Fifth edition, 287
- Lewis (Dr. T.), appointed Oliver Sharpey Lecturer of the Royal College of Physicians of London, 1921, 755
- Liapin (N.), An Easy Method of Finding Latitude, 625
- Licent (E.), Use of Mixtures of Formal and Chromium Compounds as Fixing Agents, 604
- Lillie (Prof. F. R.), Problems of Fertilisation, 225
- Lindsay (Prof. W. M.), elected a Fellow of the Royal Danish Society of Science, 209
- Ling (A. R.), appointed Adrian Brown Professor of Brewing in Birmingham University, 154
- Link (Dr. H. C.), Employment Psychology: The Application of Scientific Methods to the Selection, Training, and Grading of Employees, 673
- Lister (Lord), Commemorating the Work of, 654
- Littlewood (J. E.), appointed Cayley Lecturer in Mathematics in Cambridge University, 505
- Lewellyn (Dr. T. L.), and others, Lighting Conditions in Mines, with Special Reference to the Eyesight of Miners, 21
- Lloyd (L.), The Destruction of the Glasshouse Tomato Moth, 629
- Lloyd (S. L.), Mining and Manufacture of Fertilising Materials, and their Relation to Soils, 4
- Lockhart (Dr. R. D.), appointed a Lecturer in Anatomy in Aberdeen University, 730
- Lockyer (Sir Norman), Contributions to Astrophysics, 831; [obituary articles], 781, 784
- Lockyer (Major W. J. S.), Central Wireless Station for Astronomy, 454; Helium: Its Discovery and Applications, 360; Recent Researches on Nebulae, 489
- Loder (Sir Edmund Giles), [obituary article], 301
- Lodge (Sir Oliver), Prof. A. Righi, 753
- Lones (Dr. T. E.), Zinc and its Alloys, 193
- Loring (Capt. F. C.), Announcement that the Post Office is in Favour of Granting Wireless Licences for Experimental Work, 80
- Louis (Prof. H.), British Iron Ores, 419
- Lounsbury (C. P.), Legislation in Regard to Plant Pests in the British Empire, 502
- Love (Prof. A. E. H.), A Treatise on the Mathematical Theory of Elasticity. Third edition, 511; elected an Honorary Member of the Royal Irish Academy, 113
- Lowie (H. J.), Bees and the Scarlet Runner Bean, 742
- Lowell (Dr. A. L.), The Honorary Degree of Doctor of Law Conferred upon, by Cambridge University, 730
- Lowry (Dr. T. M.), appointed Professor of Physical Chemistry in Cambridge University, 630; and F. C. Hemmings, The Properties of Powders, 217; and S. Wilding, The Setting of Dental Cements, 217
- Lucas (A.), Legal Chemistry and Scientific Criminal Investigation, 772
- Lumière (A.), Are Vitamines Necessary to the Development of Plants?, 795
- Lundmark (K.), The Parallaxes of Globular Clusters and Spiral Nebulae, 215
- Lunn (A. C.), The Commutativity of One-parameter Transformations in Real Variables, 667
- Lunt (Dr. J.), The Expanding Disc of Nova Aquilae, 595; The Spectrum of  $\eta$  Argus, 149
- Lyons (Col. H. G.), appointed Director and Secretary of the Science Museum, South Kensington, 493
- Lyster (A. G.), [obituary], 143
- MacAlister (Sir Donald), to Receive the Honorary Degree of LL.D. from the University of Dublin, 89
- MacArthur (J. S.), [obituary], 112
- MacBride (Prof. E. W.), Museums and the State, 68; The Method of Evolution, 655
- MacCallum (Dr. Bella D.), appointed Assistant in Botany in Edinburgh University, 120
- MacDougall (Dr. D. T.), The Components and Colloidal Behaviour of Protoplasm, 795
- MacDougall (Dr.), Insects in Relation to Afforestation, 503
- MacFadden (Dr.), Work of Inspectors of Food, 151
- Macgregor (M.), and others, The Iron Ores of Scotland. Vol. xi, 419
- MacIntyre (Dr. J.), Degree of LL.D. conferred upon, by Glasgow University, 568
- Mackenzie (Col. J. S. F.), A Night Raid into Space: The Story of the Heavens told in Simple Words, 100
- Mackenzie (K. J. J.), Cattle and the Future of Beef Production in England. With a Preface and Chapter by Dr. F. H. A. Marshall, 62
- Mackenzie (Sir Leslie), presented with the Medal of Honour of the University of Brussels, 440
- MacLachlan (Dr. N. W.), The Testing of Bars of Magnet Steel, 122
- Maclaurin (Dr. R. C.), [obituary], 144
- MacMahon (Major P. A.), Congruences with Respect to Composite Moduli, 474
- MacMichael (H. A.), Stone Worship, 115
- MacMillan (Prof. W. D.), The Structure of the Universe, 780
- MacNutt (J. S.), The Modern Milk Problem in Sanitation, Economics, and Agriculture, 385
- McAdie (Prof. A.), The Attainment of High Levels in the Atmosphere, 437; The Principles of Aerography, 470
- McAulay (Prof. A.), Relativity and Hyperbolic Space, 808
- McBain (Prof. J. W.), Colloidal Electrolytes, 760
- McBride (G. McC.), The Possibilities of Cotton-growing in South America, 399
- McCarrison (Col.), Vitamines in their Relation to Health, 557
- McClelland (Prof. J. A.), [obituary article], 238; and A. Gilmour, The Electric Charge on Rain, 498; (the late Prof.), and the Rev. H. V. Gill, The Causes of the Self-ignition of Ether-air Mixtures, 634
- McClure (Rev. Canon E.), Buzzards and Bitterns, 105
- McCurdy (E.), Leonardo da Vinci, 307, 340
- McDougall (Dr. W.), An Introduction to Social Psychology. Fourteenth edition, 201
- McEwen (G. F.), and E. L. Michael, The Functional Relation of One Variable to each of a Number of Correlated Variables, 82
- McFarlane (J.), Presidential Address to Section E of the British Association, 826
- McFarlane (Miss Margaret), awarded a Keddy Fletcher-Warr Studentship by the University of London, 155
- McGregor (E. A.), The "Red Spiders" of America, 275
- McIntosh (Dr. J.), appointed Professor of Pathology at Middlesex Hospital Medical School, 25
- McIntosh (Prof. W. C.), International Council for Fishery Investigations, 167, 358
- McKendrick (Major), and Major Morison, Influenza on Shipboard, 40
- McLennan (Prof. J. C.), Helium: Its Production and Uses, 747, 778; Sources of Helium in the British Empire, 725; and A. C. Lewis, Spark Spectra of Various Elements in Helium in the Extreme Ultra-violet, 632; J. F. T.

- Young, and H. J. C. Ireton, Arc Spectra *in vacuo* and Spark Spectra in Helium of Various Elements, 632
- McNamara (Dr. J.), The Flight of Flying-fish, 421
- Maihle (A.) A New Method of Formation of Nitriles by Catalysis, 283; A New Preparation of Amines by Catalysis, 442; The Catalytic Hydration of Nitriles, 795; and F. de Godon, The Preparation of Fatty Acids by the Catalytic Oxidation of the Primary Alcohols, 187; The Catalytic Formation of Ether Oxides, 27
- Majorana (Q.), Gravitation, 283; vi., 251; ix., 844
- Malinovsky (Dr. B.), Kula: The Circulating Exchange of Valuable in the Archipelagoes of Eastern New Guinea, 688; and others, The Economic Pursuits of the Trobriand Islanders, 564
- Mallock (A.), Genera and Species, 675; Growth of Waves, 777; Influence of Temperature on the Rigidity of Metals, 631; Muscular Efficiency, 197; Weather Forecasts and Meteorology, 580
- Malone (Capt.) and Capt. Maitra, Encephalitis lethargica in Karachi, 834
- Mangenot (G.), The Chondriome of the Vaucheria, 571
- Mangham (S.), appointed Professor of Botany at the University College of Southampton, 608
- Manning (Dr. V. H.), appointed Director of Research in the American Petroleum Institute, 527
- Mansbridge (A.), Technical Schools and Their Part in Adult Education, 23
- Maquenne (L.), and E. Demoussy, a Case Favourable to the Action of Copper on Vegetation, 634; The Catalytic Action of Copper Salts on the Oxidation by air of Ferrous Compounds, 609; The Absorption of Calcium by Plant-roots, etc., 91
- Marchal (Prof. P.), elected a Foreign Member of the Linnean Society, 366
- Marconi (G.), An Appreciation of the late Prof. Righi, 526
- Marr (Prof. J. E.), The Relationship of the Various Periods of Prehistoric Man to the Great Ice Age, 153
- Marshall (the late Prof. A. Milnes), and the late Dr. C. H. Hurst, A Junior Course of Practical Zoology. Ninth edition, revised by Prof. F. W. Gamble, 516
- Marshall (the late Rev. E. S.), Bequest to Cambridge University, 601
- Marshall (J.), A Law of Force Giving Stability to the Rutherford Atom, 666
- Martin (Major A. J.), Presentation to, of the Gold Medal of the Institution of Sanitary Engineers, 526; The Nature and Treatment of Sewage, 702
- Martin (Prof. C. J.), elected a Member of the Athenæum Club, 209
- Martin (E. A.), The Condition of Kent's Cavern, 742; The Glaciation of the South Downs, 530
- Martin (J.), A Geography of Asia, 35
- Martin (M. J.), Wireless Transmission of Photographs. Second edition, 451
- Mason (T. G.), The Inhibition of Invertase in the Sap of *Galanthus nivalis*, 123
- Mason (Dr. W.), appointed Professor of Engineering (Strength of Materials), in Liverpool University, 630
- Massy (Miss Anne L.), a Revised List of the Species of Holothurioidae of the Coasts of Ireland, 433
- Mathews (Prof. G. B.), Complex Elements in Geometry, 736
- Matignon (C.), and J. A. Lecanu, The Reversible Oxidation of Arsenious Acid, 247; and Mlle. Marchal, The Prolonged Action of Carbon Dioxide on Silicates and Quartz, 443
- Matisse (G.), Action de la Chaleur et du Froid sur l'Activité des Êtres Vivants, 161
- Matthew (W. D.), Plato's Atlantis in Palæogeography, 667
- Matthews (D. J.), Demoussy's Engrais, 738
- Matthews (R. Bortase), The Technical Library, 505
- Maulik (Prof. S.), The Fauna of British India, including Ceylon and Burma. Coleoptera. Chrysomelidae (Hispinæ and Cassidinae), 64
- Maurice (H. G.), elected President of the International Council for the Exploration of the Sea, 86
- Mauzy (Miss C. J.), The Shells of Porto Rico, 503
- Max Müller (Dr. W.), The Bilingual Inscriptions at Philæ, 592
- Maxwell (Sir Herbert), Sir Edmund Giles Loder, 301; The Plumage Bill and Bird Protection, 169
- Mayer (A.), Guieysse, Plantefol, and Fauré-Fremiet, Pulmonary Lesions determined by Blistering Compounds, 604; H. Magne, and L. Plantefol, Reflex Action Produced by the Irritation of the Deeper Respiratory Tracts, 507; H. Magne, and L. Plantefol, The Reflexes Provoked by Irritation of the Respiratory Passages, 443
- Mayo (C. H. P.), Elementary Calculus, 163
- Meek (Prof. A.), The Physiology of Migrations in the Sea, 197
- Meek (D. B.), Degree of D.Sc. conferred upon, by Glasgow University, 568
- Mees (Dr. C. E. Kenneth), The Nature of Photographic Images, 307; The Organisation of Industrial Scientific Research, 771
- Meggors (W. F.), and C. G. Peters, Measurements of the Index of Refraction of Arc for Wave-lengths, 53
- Meldrum (A. N.), The Development of the Atomic Theory, 212
- Mellanby (Dr.), appointed Professor of Pharmacology in Sheffield University, 601
- Meltzer (Dr. S. J.), The Dualistic Conception of the Processes of Life, 763
- Mennell (F. P.), Rare Zinc-copper Minerals from the Rhodesian Broken Hill Mine, Northern Rhodesia, 569
- Mercer (J.), Symmetrisable Functions and their Expansion in Terms of Biorthogonal Functions, 632
- Mercer (Right Rev. Dr. J. E.), Some Wonders of Matter, 67
- Merchant (C. F.), A New Method for Approximate Evaluation of Definite Integrals between Finite Limits, 422
- Merrill (E. D.), New or Noteworthy Philippine Plants, 146
- Merrill (G. P.), An Interesting Meteorite, 750
- Merrill (P. W.), Variable Stars of Class Md, 244
- Merton (Dr. T. R.), The Structure of the Balmer Series of Hydrogen Lines, 314; The Title of Professor Conferred upon, by Oxford University, 440; and Brigadier-General H. Hartley, The Separation of Isotopes, 104
- Mesnil (Prof. F.), awarded a Mary Kingsley Medal, 607
- Messel (Dr. R.), [death], 239; [obituary article], 270; Bequests by, 569
- Metcalfe (J.), [obituary], 273
- Meunier (J.), The Catalytic Action of Aluminium in the Preparation of the Chlorobenzenes, 571
- Miall (Dr. S.), The Standard of Atomic Weights, 294
- Michell (A. G. M.), A Simple Viscometer, 344
- Michelson (Prof. A. A.), awarded the Albert Medal of the Royal Society of Arts, 406; The Application of Interference Methods to Astronomical Measurements, 666
- Middleton (Sir T. H.), Organisation of Scientific Work, 103; The Place of Basic Slag in the Agricultural System of the Country, 183
- Miers (Sir Henry A.), re-elected President of the Manchester Literary and Philosophical Society, 303; C. G. Darwin, and Dr. H. Robinson, Moseley Memorial, 200
- Mignonaç (G.), The Catalytic Hydrogenation of Nitriles, 600; The Ketimines, 247
- Mill (Dr. H. R.), The Position of the Meteorological Office, 38; Woods and Water Supply, 158
- Miller (Dr.), List of Observed Parallaxes, 500
- Miller (Prof. D. C.), The Velocity of Explosive Sounds, 842
- Miller (L. E.), In the Wilds of South America: Six Years of Exploration in Colombia, Venezuela, British Guiana, Peru, Bolivia, Argentina, Paraguay, and Brazil, 159
- Millikan (Prof. R. A.), to Receive the Honorary Degree of D.Sc. from the University of Dublin, 89
- Milne (E. A.), appointed Assistant Director of the Solar Physics Observatory, Cambridge, 376
- Milne (J.), The Analytical Geometry of the Straight Line and the Circle, 65
- Milner (H. B.), Petroleum Geology, 608
- Mitchell (Dr. A. C.), The Magnetic Storm of March 22-23 and Associated Phenomena, 170
- Mitchell (C. Ainsworth), Characteristics of Pigments in Early Pencil Writing, 12
- Mitchell (Dr. P. Chalmers), Impressions on the Physiography of the Nile Basin, 113; Value of Aviation in Scientific Exploration, 336

- Mitchell (S. A.), and C. P. Olivier, The Binary Krueger 60, 307
- Mohr (O. L.), and C. Wriedt, A New Type of Hereditary Brachyphalangy in Man, 464
- Moullard (M.), Influence of a Small Quantity of Potassium on the Physiological Characters of *Sterigmatocystis nigra*, 347
- Moir (J.), Colour and Chemical Constitution. Part xi., 667
- Moir (J. Reid), An Early Neolithic "Floor" in the Neighbourhood of Ipswich, 527; Early Palaeolithic Flint Implements, 146; Naturally Fractured Eocene Flints, 358; Pre-Palaeolithic Man, 289
- Molteno (Mr. and Mrs. P. A.), Further Gift Towards the Molteno Institute of Parasitology at Cambridge, 665
- Monaco (Prince Albert de), Stray Mines in the North Atlantic, 282
- Montagu (Hon. E. S.), The Plumage Bill, 303
- Montagu of Beaulieu (Lord), Some National Aspects of Transport, 469
- Moon (Dr. R. O.), appointed FitzPatrick Lecturer of the Royal College of Physicians of London, 1921, 755
- Moore (Dr. B.), appointed Professor of Biochemistry in the University of Oxford, 537; E. Whitley, and T. A. Webster, Sunlight and the Life of the Sea, 90; and T. A. Webster, Photosynthesis in Fresh-water Algae, 26
- Moore (H.), The Ignition Points of Liquid Fuels, 245
- Morant (Sir Robert), [obituary], 76
- Moreno (Dr. F. P.), [obituary], 76
- Morgan (Prof. C. Lloyd), appointed Emeritus Professor of Psychology and Ethics in Bristol University, 630
- Morgan (P. G.), The Limestone Resources of New Zealand, 465
- Morgan (Prof. T. H.), Dr. C. B. Bridges, and A. H. Sturtevant, Contribution to the Genetics of *Drosophila melanogaster*, 405
- Morphy (B. H.), Scientific Apparatus and Laboratory Fittings, 356
- Morrell (Dr. R. S.), elected President of the Oil and Colour Chemists' Association, 527
- Morris (H.), The Evolution of Wealden Flint Culture from Pre-Palaeolithic Times, 431
- Morris (Lord), and others, The Imperial College of Science and Technology, 471
- Morrison (Dr. G. E.), [obituary], 431
- Morrison (W.), Gift to the Bodleian Library, Oxford, 731
- Mortimer (G.), Aluminium: Its Manufacture, Manipulation, and Marketing, 805
- Moses (Prof. A. J.), [obituary], 365.
- Mottram (V. H.), appointed Professor of, Physiology at King's College for Women Household and Social Science Dept., 698
- Mottram and Clarke, Reduction in Number of White Blood Corpuscles in those Handling Radium for Curative Purposes, 400
- Moulton (Lord), The Training and Functions of the Chemical Engineer, 82
- Moureu (Prof. C.), Notions fondamentales de Chimie Organique. Sixième édition, 63; and J. C. Bongrand, New Researches on Carbon Sub-nitride, 411; and G. Mignonac, Acylketimines, 539
- Muir (F.), A New Genus of Australian Delphacidae (Homoptera), 635
- Muir (Sir Thomas), Gift of Mathematical Works to the South African Public Library, Cape Town, 305
- Mullens (W. H.), H. Kirke Swann, and Rev. F. C. R. Jourdain, A Geographical Bibliography of British Ornithology from the Earliest Times to the end of 1918. Part i., 353
- Mumford (Dr. A. A.), Investigation and Standardisation of the Physical Efficiency of Children, 26
- Munby (A. E.), The Cost of Laboratory Fittings, 294, 456
- Munro (Dr. R.), [obituary article], 685
- Munroe (Prof. C. E.), Products of Detonation of T.N.T., 795
- Murphy (J. B.), The Effect of Physical Agents on the Resistance of Mice to Cancer, 668
- Myers (C. M.), and C. Voegtlin, The Chemical Isolation of Vitamines, 667
- Myers (Dr. C. S.), Science and the New Army, 135
- Myers (Dr. J. E.), and J. B. Firth, Elementary Practical Chemistry. For Medical and Other Students. Second edition, 705
- Nagaoka (H.), Diffraction Image of a Disc, 436
- Nansen (Dr. F.), The Discovery of Spitsbergen, 210
- Nash (J. K.), The Nesting of the Bee-eater in Scotland, 780
- Neale (R. E.), Electricity: Its Production and Applications, 804
- Neave (the late Dr. G. B.), and Prof. I. M. Heilbron, The Identification of Organic Compounds. Second edition, 774
- Neilson-Jones (W.), appointed Professor of Botany at Bedford College, 155
- Neville (G. O.), The Aborigines of Western Australia: Their Treatment and Care, 248
- Neville (H. A. D.), and L. F. Newman, A Course of Practical Chemistry for Agricultural Students. Vol. ii., Part i., 33
- Newman (Sir George), The Origin and Growth of the Medical Department of the Local Government Board, 151; and others, The Place of "Preliminary Science" in the Medical Curriculum, 661
- Newman (L. F.), and Prof. H. A. D. Neville, A Course of Practical Chemistry for Agricultural Students. Vol. i., 291
- Nichols (Prof. E. F.), Resignation of the Chair of Physics at Yale University, 440; appointed Director of Pure Science in the Nela Research Laboratory, 834
- Nichols (E. L.), H. L. Howes, and others, The Fluorescence and Absorption Spectra of Uranyl Salts, 498
- Nicholson (Prof. J. W.), The Secondary Spectrum of Hydrogen, 166
- Nicoll (M. J.), Hand-list of the Birds of Egypt, 674
- Nicolle (M.), E. Césari, and C. Jouan, Toxines et Antitoxines, 67
- Nierenstein (Dr. M.), Waage's Phytochemical Synthesis of Phloroglucin from Glucose, 391
- Nordenfelt (T.), [obituary], 19
- North (B.), assisted by N. Bland, Chemistry for Textile Students, 382
- Northumberland (Duke of), elected President of the Royal Institution, 304
- Nottin (P.), The Absorptive Power of Earth for Manganese, 666
- Noyes (A. A.), and D. A. MacInnes, The Ionisation and Activity of Largely Ionised Substances, 667
- Ogilvy (J. W.), British and Foreign Scientific Apparatus, 424
- Ohashi (Prof. R.), The Plumbeiferous Barytes from Shibukuro, Japan, 569
- Oldham (R. D.), elected President of the Geological Society, 52; The Frequency of Earthquakes in Italy in the Years 1896 to 1914, 186
- Onicescu (O.), Newtonian Fields in the Neighbourhood of a given Vectorial Field, 843
- Onnes (H. K.), elected a Foreign Associate of the U.S. National Academy of Sciences, 463
- Onslow, The Melanic Variety of *Boarmia (Tephrosia) consonaria*, 278
- Orange (J. A.), Deflection of Light during a Solar Eclipse, 8
- Ormandy (Dr. W. R.), Patents taken out for Mixtures Intended as Motor Fuels, 21; The Filtration of Colloids, 666
- Orpen (Sir William), elected a Member of the Athenæum Club, 209
- Ortmann (Dr. A. E.), Correlation of Shape and Station in Fresh-water Mussels, 843
- Osborn (Prof. H. F.), Report of the American Museum of Natural History, 1910, 724; and C. C. Mook, Reconstruction of the Skeleton of the Sauropod Dinosaur *Camarasaurus*, Cope (Morosaurus, Marsh), and W. K. Gregory, Restoration of *Camarasaurus* and Life-model, 667; Type Specimens of Fossil Horses from the Old Cocene, Miocene, and Pliocene Formations of North America, 117

- Osborne (Prof. W. A.), Marat and the Deflection of Light, 450
- O'Shea (Prof. L. T.), [death], 239; [obituary article], 272
- Oster (the late Sir William), Proposed Memorial to, 50
- Osterhout (Prof. W. J. V.), Respiration, 795
- Oxley (Dr. A. E.), Atomic and Molecular Structure, 231; Atomic and Molecular Forces and Crystal Structure, 327; Diamagnetism and the Structure of the Hydrogen Molecule, 581; Diamagnetism of Hydrogen, 709; Langmuir's Theory of Atoms, 105; The Magnetic Properties of Forty Organic Compounds, 243
- Oyler (Rev. D. S.), The Shilluks' Belief in Medicine Men, 527
- Pacific Steam Navigation Co., Gift to the Liverpool University Appeal Fund, 762
- Page (L.), Gravitational Deflection of High-speed Particles, 233
- Palander (Admiral A. L.), [obituary], 754
- Palmer (W. G.), The Catalytic Activity of Copper. Part i., 633
- Parker (Prof. G. H.), The Phosphorescence of Renilla, 843
- Parker (W. H.), appointed Director of the National Institute of Agricultural Botany, 335
- Parkinson (Dr. W. H.), and H. D. Bell, Insect Life on Sewage Filters, 131
- Parsons (Prof. F. G.), and others, The Colour Index of the British Isles, 531
- Parsons (S. J.), Malleable Cast Iron. Second edition, 290
- Partington (Prof. J. R.), The Standard of Atomic Weights, 264
- Partridge (W.), appointed Lecturer in Chemistry (Public Health), at King's College, London, 698
- Pascoe (Dr. E. H.), Relations of the Indus, the Brahmaputra, and the Ganges, 835
- Patchell (W. H.), Operating a By-product Producer-gas Plant for Power and Heating, 148
- Paulson (R.), Stages in the Spuration of Gonidia within the Thallus of *Evernia prunastri*, Ach., 281
- Pauthenier (M.), Ratio of the Absolute Retardations in Carbon Bisulphide for Increasing Durations of Charge, 699; Ratio of the Absolute Retardations in the Kerr Phenomenon for Different Wave-lengths in the case of Nitrobenzene, 634
- Payman (W.), Need of a Safety Lamp in Chemical Works, 116; The Propagation of Flame in Complex Gaseous Mixtures, 279
- Peachey (S. J.), A Process for the Cold Vulcanisation of Rubber, 625
- Peake (H.), The Finnic Question and Some Baltic Problems, 723
- Pearl (Prof. R.), The Consumption of Foodstuffs in America from 1911-1918, 597; and J. R. Miner, Milk Production of Ayrshire Cattle, 245
- Pearson (E. S.), awarded the Sheepshanks Exhibition in Astronomy in Cambridge University, 313
- Pearson (Prof. Karl), Presidential Address to Section H of the British Association, 827; The Permanent Value of University Benefactions, 501; and Julia Bell, A Study of the Long Bones of the English Skeleton. Part i., The Femur; Part ii., Section ii., The Femur of Man, with Special Reference to other Primates Femora, 767
- Pease (F. G.), Photograph of the Moon, 267
- Peirce (Prof. B. O.), Magnetic Characteristics of the Iron Core of a Transformer or of an Induction Coil, 243
- Pendred (L.), Plant-life in Cheddar Caves, 709
- Percival (A. S.), Some Methods of Approximate Integration and of Computing Areas, 70
- Péringuey (L.), Stone Implements of Palæolithic Type Throwing Light on the Manufacture in South Africa, 699; Strand-loopers, 558; The Whales Frequenting South African Waters, 507
- Perkin (Prof. W. H.), University Grants, 805
- Perot (A.), Comparison of the Wave-lengths of a line of the Cyanogen Band in the Light of the Sun and that of a Terrestrial Source, 794
- Perotti (R.), Measure of Ammoniating Power of Soils, 844; Nitrogen of the Cyanic Group in Manures, 844
- Perrett (Dr. W.), "All-or-None" in the Auditory nerve, 390; Photographs of Seven Vocal Notes, 39
- Perry (Prof. J.), [obituary articles], 751, 752
- Perry (W. J.), The Origin of Warlike States, 442; The Search for Amber in Antiquity, 274; The Search for Gold and Pearls in Neolithic Times, 250
- Perrycoste (Honor M. M.), The First Act of a Young Thrush, 456
- Petavel (Sir J. E.), elected a Member of the Athenæum Club, 209
- Petch (T.), Revisions of Ceylon Fungi, Part vi., 20
- Petersen (Prof. C. G. J.), Our Gobies (Gobiidae) from the Egg to the Adult Stages, 527
- Petrie (Prof. Flinders), A Remarkable Ebony Statue from Egypt, 463; and Dr. Dennison, Personal Ornaments Found in Upper Egypt, 210
- Peyrouel (B.), A Parasite of the Lupin, *Blepharospora terrestris*, 844
- Pfeffer (Prof. W.), [obituary article], 302
- Phibby (H. St. John B.), awarded the Founder's Medal of the Royal Geographical Society, 112
- Philip (A.), Reform of the Calendar, 22
- Philip (J. B.), Experiments with Plants. A First School-book of Science, 805
- Philip (Sir Robert W.), Degree of LL.D. Conferred upon, by Glasgow University, 568
- Philips (Rev. T. E. R.), The Planet Jupiter, 500
- Phillips (W. J.), Insect Pests in the United States Affecting Grain Crops, Cultivated Grasses, and Wild Grasses, 662
- Pictet (A.), and P. Castan, Glucosane, 795
- Piedallu (A.), P. Malvezin, and L. Grandchamp, The Treatment of the Blue casse of Wines, 442
- Pierantoni (Prof.), Physiological Symbiosis, 756
- Piettre (M.), and A. Vila, The Separation of the Proteins of the Serum, 571
- Pilgrim (Dr. G. E.), A Great Pliocene River Running on the South Side of the Himalayas, 836
- Pilon (H.), authorised translation, The Coolidge Tube. Its Scientific Applications. Medical and Industrial, 739
- Pilsbry (Dr. H. A.), Review of the Land Mollusks of the Belgian Congo, 433
- Pitman (P.), Pelton-wheel Construction, 625
- Pitt (Miss F.), The Colour and Markings of Pedigree Hereford Cattle, 211
- Piutti (A.), Action of Chloropicrin on the Parasites of Wheat and on Rats, 283
- Pixell-Goodrich (Mrs.), Cause of the Death of Honey-bees, 53
- Pleasance (R. E.), appointed Demonstrator in Pathology in Sheffield University, 601
- Pocock (R. I.), External Characters of the South American Monkeys, 218
- Poincaré (L.), [death], 50; [obituary], 208
- Pollard (S.), awarded a Smith's Prize by Cambridge University, 88
- Poole (H. H.), The FitzGerald-Lorentz Contraction Theory, 200
- Pope (S. T.), The Medical History of Ishi, 755
- Pope (Sir W. J.), elected an Associate of the Académie Royale de Belgique, 463; nominated President of the Society of Chemical Industry, 432; elected President of the Society of Chemical Industry, 654
- Porcher (C.), Milk and Apthous Fever, 699; Want of Food and the Chemical Composition of Milk, 571
- Porrirt (B. D.), appointed Director of Research by the Research Association of British Rubber and Tyre Manufacturers, 179
- Portier (P.), The Rabbit deprived of its Cæcal Appendix Regenerates this Organ, 347
- Posternak (S.), The Variations of the Composition of Ammonium Phosphomolybdate, 347
- Pott (J. A.), [obituary], 334
- Potts (F. A.), appointed University Lecturer in Zoology in Cambridge University, 537
- Powell (B.), Methods for the Verification of Screw Gauges, 184
- Prain (Sir David), elected a Foreign Associate of the U.S. National Academy of Sciences, 463



- Preston (Prof. T.), *The Theory of Heat*. Third edition. Edited by J. R. Cotter, 228
- Priest (F. E.), [obituary], 273
- Prince (Major C. E.), *Wireless Telephony in Aeroplanes*, 55
- Prince (Prof. J. D.), *Celt and Slav*, 763
- Pring (J. N.), *Occurrence of Ozone in the Atmosphere*, 645
- Prior (Dr. G. T.), *The Meteoric Iron of Mount Ayliff, Griguland East*, 156
- Procopiu (S.), *The Double Refraction and Dichroism of the Fumes of Ammonium Chloride in the Electric Field*, 571
- Procter (J.), [obituary], 112
- Pryor (Marlborough R.), [obituary article], 333
- Puente (C.), *Methods of Determining Time and Latitude*, 213
- Purcell (Prof. P. F.), *The Peat Resources of Ireland*, 791
- Quayle (E. T.), *Tropical Control of Australian Rainfall*, 152
- R. (H.), *Standard Time in Finland*, 145
- Rabut (C.), *Light Concrete*, 91
- Rainbow (W. J.), [obituary], 208
- Raman (Prof. C. V.), *The Einstein Deflection of Light*, 23
- Ramanujan (Prof. S.), [death], 431; [obituary article], 404
- Ramsbottom (J.), and others; *Canvas-destroying Fungi*, 563
- Rankin (Dr. W. H.), *Manual of Tree Diseases*, 577
- Ransom (Dr. B. H.), *The Trematode Family Heterophyidae*, 786
- Rao (C. V. H.), and Prof. Baker, *Generation of Sets of four Tetrahedra Mutually Inscribed and Circumscribed*, 379
- Rateau (A.), *Flight at Very High Altitudes and the Use of a Turbo-compressor*, 282; *Maps of the Network of Electricity Distribution in France*, 571
- Ravenshear (E. W.), awarded the Harkness Scholarship of the University of Cambridge, 537
- Ravn (Prof. F. K.), *Plant Culture in Denmark*, 761
- Rawnsley (Rev. Canon H. D.), [obituary], 430
- Rawson (E.), appointed Principal of the West Bromwich Municipal Technical Institute, 698
- Ray (S. H.), *Schmidt's Die Gliederung der Australischen Sprachen*, 707; *The Religion and Origin of the Hawaiian People*, 628
- Ráy (Sir Prafulla Chandra), *The Indian Chemical Service*, 325
- Rayleigh (the late Lord), *Proposed Memorial to*, 50, 687; *Formation of a Committee to Collect Funds for a Memorial to*, 303
- Rayleigh (Lord), *A Re-examination of the Light Scattered by Gases in Respect of Polarisation. I. Experiments on the Common Gases*, 631; *The Blue Sky and the Optical Properties of Air*, 584
- Read (Sir C. Hercules), elected President of the Society of Antiquaries of London, 273; *The Prospects of Archaeological Research*, 497
- Reboul (G.), and L. Dunoyer, *Utilisation of Cirrus Clouds for Weather Prediction*, 251
- Redgrove (H. S.), *Bygone Beliefs: Being a Series of Excursions in the Byways of Thought*, 610
- Reece (Dr.), and Dr. MacNalty, *Encephalitis lethargica*, 151
- Rees (A. W.), *The Heron of Castle Creek and Other Sketches of Bird Life*, 514
- Rees (W.), *The D.Sc. (Economics) Degree Conferred upon*, by the University of London, 25
- Rees (W. J.), *The Corrosion of Coke-oven Walls*, 605
- Reid (Mrs. Eleanor M.), *A Comparative Review of Pliocene Floras, Based on the Study of Fossil Seeds*, 240; *Two Pre-Glacial Floras from Castle Eden (County Durham)*, 249
- Reid (Prof. H. F.), *Distribution of Land and Water on the Earth*, 763; and S. Taber, *The Porto Rico Earthquake of October 11, 1918*, 276
- Reid (W. F.), *The Difficulty of Inventors in Obtaining Recognition*, 367
- Reilly (Dr. J.), and W. J. Hickinbottom: (1) *The Influence of Electrolytic Dissociation on the Distillation in Steam of the Volatile Fatty Acids*. (2) *Some Applications of the Method of Distillation in Steam*, 379; and others, *Preparation of Acetone by the Fermentation of Starchy Material*, 466
- Rendall (M. J.), *The Teaching of Art in Local Museums*, 627
- Rendle (Dr. A. B.), *Banks as a Patron of Science*, 530; *The Cost of Scientific Publications*, 353
- Rennesson (M.), *Loss of Energy in the Dielectric of Commercial Cables*, 218
- Renouf (L.), *The Mounting of Wet Specimens under Watch-glasses and Petri Dishes*, 680
- Renwick (F. F.), *The Hurter Memorial Lecture*, 689
- Rew (Sir R. Henry), elected President of the Royal Statistical Society, 526; *Food Supplies in Peace and War*, 320; *Social Service in Rural Areas*, 731
- Reynolds (Prof. J. Emerson), [obituary article], 49
- Rhead (E. L.), *Technical Education and Mind Training*, 439
- Rhodes (C. E.), [obituary], 495
- Rice (G. S.), *The Mines and Methods of Working Them, in the Pas-de-Calais District*, 688
- Richardson (Lt.-Col. A. R.), appointed Professor of Mathematics at University College, Swansea, 665; *Science and the New Army*, 170
- Richardson (C. A.), *Spiritual Pluralism and Recent Philosophy*, 773; *The Principle of Equivalence and the Notion of Force*, 72
- Richardson (H.), appointed Principal of the Bradford Technical College, 505
- Richardson (L. F.), *Some Measurements of Atmospheric Turbulence*, 57; *The Supply of Energy to Atmospheric Eddies*, 378
- Richardson (W. A.), *A New Model Rotating-stage Petrological Microscope*, 570; *The Fibrous Gypsum of Nottinghamshire*, 560
- Ridgeway (Sir W.), *Two Wooden Maori Daggers*, 274; and Dr. L. D. Barnett, *The Origin of the Hindu Drama: Additional Evidence*, 433
- Righi (Prof. A.), [death], 462; G. Marconi, 526; [obituary article], 753
- Rijkevoersel (Dr. E. van), *Secondary Maxima and Minima*, 761
- Riquoir (G.), *Colloidal Complexes and Sera*, 187
- Robb (Dr. A. A.), *The Construction of a Magnetic Shell Equivalent to a Given Electric Current*, 199
- Robertshaw (G. F.), *Examination of Lubricating Oils*, 339
- Robertson (Principal C. Grant), *University Grants*, 774
- Robertson (G. Scott), *Effect of Various Types of Open-hearth Basic Slags on Grassland*, 184
- Robertson (J. B.), *The Chemistry of Coal*, 382
- Robertson (Prof. P. W.), and D. H. Burleigh, *Qualitative Analysis in Theory and Practice*, 705
- Robertson (Sir Robert), *The Research Department, Woolwich*, 710, 743
- Robertson (Prof. T. B.), *The Physical Chemistry of the Proteins*, 257
- Robinson (J. W. D.), *The Devonian of Ferques (Lower Boulonnais)*, 314
- Robinson (Prof. R.), *The Conjugation of Partial Valencies*, 346; *The Mechanism of the Production of Kynurenic Acid in the Dog*, 346
- Rocasolano (A. de G.), *The Catalytic Decomposition of Solutions of Hydrogen Peroxide by Colloidal Platinum*, 603
- Rogers (Sir Leonard), *Fevers in the Tropics*. Third edition, 33; *Organisation of Scientific Work*, 202; *Return of*, to England, 303
- Rogers (R. A. P.), *Perimeter of an Ellipse*, 8; Dr. F. A. Tarleton, 554; *Some Methods of Approximate Integration and of Computing Areas*, 138
- Rohwer (S. A.), and F. X. Williams, *Philippine Wasp Studies*, 600
- Rootham (C.), Mr. Sedley Taylor, 143
- Rose (Lady Jenny), *Early Hawthorn Blossom*, 234
- Rose (W. N.), *Mathematics for Engineers*. Part ii., 260
- Rosenhain (Dr. W.), *Glass Manufacture*. Second edition, 128
- Rosenheim (O.), *The Formation of Anthocyanins in Plants*, 401

- Ross (Sir Ronald), Organisation of Scientific Work, 6; Philosophies; Psychologies, 414; Fellow-workers, 455
- Rothé (E.), A New Electrical Anemometer, 443
- Roubaud (E.), The Mode of Action of Powdered Trioxymethylene on the Larvæ of Anopheles, 667
- Roubaud (E.), Use of Trioxymethylene in Powder for the Destruction of the Larvæ of Mosquitoes, 604
- Rouch (J.), Manuel Pratique de Météorologie, 451; The Height of Sea-Waves, 219
- Routledge (Mrs. Scoresby), The Mystery of Easter Island: The Story of an Expedition, 583
- Roux (Dr. E.), and Dr. C.-F. Muettel, Aliments Sucrés. Sucres—Miels—Sirops—Confitures—Sucreries—Sucrs et Régisse, 641
- Rowett (J. Q.), Gift to the Institute of Research in Animal Nutrition at Aberdeen, 80
- Russ (Dr. S.), appointed Professor of Physics at the Middlesex Hospital Medical School, 25
- Russell (Dr. A.), Applications of Electricity, 418; The Capacity Coefficients of Spherical Conductors, 57; Occurrence of Cotunnite, Anglesite, Leadhillite, and Galena on Fused Lead from the Wreck of the Fireship *Firebrand*, Falmouth Harbour, 156
- Russell (Dr. E. J.), A Student's Book on Soils and Manures. Second edition, 130; Basic Slag and Its Uses in Agriculture, 183; British Crop Production, 176, 206; Organisation of Scientific Work, 7; The Manufacture of Artificial Fertilisers, 4; The Nation's Food, 320; Wheat and Wheat-growing, 224
- Russell (Prof. H. N.), The Masses of the Stars, 500; The Planetary Families of Comets, 467
- Russell (Sir Thomas W.), [death], 302
- Rutherford (Sir Ernest), elected an Honorary Member of the Royal Irish Academy, 113; elected a Fellow of the Royal Danish Society of Science, 209; To Deliver the Bakerian Lecture of the Royal Society, 80; Nuclear Constitution of Atoms, 500
- Rutherford (Capt. W. J.), "A Border Myth: The Standing Stones at Duddo," 623
- Rydberg (Prof. J. R.), [obituary article], 525
- Ryneveld (Col. van), and Capt. Brand, Completion of African Aeroplane Flight, 113
- Sabatini (V.), Leucitic Lavas of the Volcano of Roccamonfina, 844
- Saccardo (Dr. P. A.), [obituary], 76
- Sadler (Sir M. E.), University Grants, 740
- Saha (M. N.), Ionisation in the Solar Chromosphere, 232
- Saillard (E.), The Sugar-beet During the War, 571
- St. John (C. E.), The Einstein Displacement of Spectral Lines, 244
- Salmon (Dr. C. S.), appointed Lecturer in Physical Chemistry at King's College, London, 668
- Sampson (Prof. R. A.), appointed Halley Lecturer for 1920, 56; Eiffel Tower Wireless Time-signals, 265; Longitude by Wireless Telegraphy, 370; Relativity and Reality, 708
- Sanderson (F. W.), The Evil in Existing Educational Systems, 561
- Sanford (Dr. E. C.), Resignation of the Presidency of Clark College, 602
- Sargent (H. C.), The Lower Carboniferous Chert-formations of Derbyshire, 58
- Saunders (Miss E. R.), Presidential Address to Section K of the British Association, 828
- Sauzin (M.), The Propagation of Sustained Electrical Oscillations in Water and the Dielectric Constant of Water, 763
- Savage (R. E.), Structure of Scales of Fishes, 275
- Savor (S. R. U.), Rotating Liquid Cylinders, 379
- Savory (Isabel), The Romantic Roussillon: In the French Pyrenees, 163
- Sazerac (R.), Culture of the Tubercle Bacillus on a Medium of Autolysed Yeast, 795
- Scales (Dr. S.), appointed University Lecturer in Medical Radiology and Electrology in Cambridge University, 601
- Schafer (Sir E. Sharpey), London University Site and Needs, 484; The University Problem, 698
- Schaumasse (M.), A New Comet, 658; Discovery and Observations of the Comet 1920b (Schaumasse), 794
- Schleier (Dr. F.), Religion and Culture: A Critical Survey of Methods of Approach to Religious Phenomena, 451
- Schlesinger (Prof. F.), and Z. Daniel, Capella, 183
- Schlick (Prof. M.), Rendered into English by H. L. Brose, Space and Time in Contemporary Physics: An Introduction to the Theory of Relativity and Gravitation, 546
- Schmidt (P. W.), Die Gliederung der Australischen Sprachen, 707
- Schroeder (Major R. W.), Record Aeroplane Height Flight, 18
- Schwarz (Prof. E. H. L.), The Kalahari and Ovamboland, 297
- Scott (A.), A Swarm of Noctiluca and Pleurobrachia and Berœë in the Barrow Channel, 656
- Scott (Dr. H.), appointed Curator in Entomology in Cambridge University, 345
- Scott (H. H.), and C. Lord, Skeleton of Nototherium Found in Tasmania, 593; Studies of Tasmanian Mammals, Living and Extinct. Part ii., 796
- Scott (J. W.), appointed Professor of Logic and Philosophy in the University College of South Wales and Monmouthshire, 537
- Scott (Sir Percy), Fifty Years in the Royal Navy, 94
- Searle (A. B.), elected President of the National Association of Industrial Chemists, 785; The Preparation of Tungsten and its Uses in the Filaments of Incandescent Lamps, etc., 339; The Use of Colloids in Health and Disease, 351
- Searle (G. F. C.), A Bifilar Method of Measuring the Rigidity of Wires, 473; An Experiment on a Piece of Common String, 474; Experiments with a Plane Diffraction Grating, Using Convergent Light, 474
- Seeger (H.), The Lighting of Museums and Art Galleries, 627; The Lighting of Picture-galleries and Museums, 72
- Selous (the late Capt. F. C.), Memorial to, 504
- Semmes (D. R.), The Geology of the San Juan District, Porto Rico, 148
- Senderens (J. B.), and J. Aboulenc, The Catalytic Decomposition of the Fatty Acids by Carbon, 411
- Sergent (Dr. F.), awarded a Mary Kingsley Medal, 697
- Seton (E. Thompson), Animal Heroes. Fourth impression, 580; Monarch: The Big Bear of Tlallac, 450; The Arctic Prairies: A Canoe-journey of 2,000 Miles in Search of the Caribou, 426
- Seward (Prof. A. C.), A Study in Palæogeography, 223; Fossil Plants. Vol. iv.: Ginkgoales, Coniferales, Gnetales, 97; Organisation of Scientific Work, 7; The Origin of the Vegetation of the Land, 250
- Seyewetz (Dr.), Photographic Developing Agents, 182
- Seymour (H. L.), Astronomy in Town Planning, 691
- Shanahan (Dr. E. W.), Animal Foodstuffs: Their Production and Consumption, with a Special Reference to the British Empire, 513
- Shapley (Dr. H.), Increasing the Photographic Power of Telescopes, 625; Star Clusters, 54
- Shaughnessy (Major), A New Radio Call Signal, 600
- Shaw (F.), appointed Assistant Lecturer in Electrical Engineering in Birmingham University, 154
- Shaw (Sir Napier), appointed Professor of Meteorology in the Department of Aeronautics at the Imperial College of Science and Technology, 841; Impending Retirement of, from the Meteorological Office, 144
- Sheldon (W.), [obituary], 405
- Sheppard (W. F.), Reduction of Error by Linear Compounding, 632
- Sheriff (Miss C. W. M.), appointed Assistant Lecturer in Mathematics at King's College, London, 668
- Sherman (H. C.), The Protein Requirement of Maintenance in Man, 668
- Shidrowitz (Dr. P.), to Direct the School of Rubber Technology at the Northern Polytechnic Institute, 731
- Shive (J. W.), Relation of the Moisture in Solid Substrata to the Physiological Salt-balance, etc., 310
- Shore (A.), Alternating Current Work. An Outline for Students of Wireless Telegraphy, 133

- Shull (Prof. G. H.), A Third Duplication of Genetic Factors in Shepherd's-purse, 795
- Silberstein (Dr. L.), Abstracts of Papers Presented to the Accademia dei Lincei, January 18, 251; Feb. 1, 283; Projective Vector Algebra: An Algebra of Vectors Independent of the Axioms of Congruence and of Parallels, 65; The Aspherical Nucleus Theory Applied to the Balmer Series of Hydrogen, 441
- Sillars (D.), The Formation of Basic Slag in the Manufacture of Steel, 184
- Silvester (Lieut. N. L.), Local Weather Conditions at Mullion, Cornwall, 281
- Simmitt (Major W. E.), Resignation of the Direction and Editorship of the Technical Review; appointed to Direct the Intelligence Branch of the Ministry of Transport, 722; Technical Libraries and Intelligence, 505
- Simpson (Dr. G. C.), appointed Director of the Meteorological Office, 721; The Antarctic Anticyclone, 777
- Simpson (J. T.), Hidden Treasure: The Story of a Chore Boy who made the Old Farm Pay, 36
- Sindall (R. W.), Paper-making and its Machinery, 480
- Singer (Dr. C.), Early English Magic and Medicine, 337; Greek Science and Philosophy, 373; Science and Scholasticism, 127, 548
- Sitter (Prof. W. de), The Lunar Parallax and Related Constants, 529
- Skaife (S. H.), Some South African Entomophthoraceæ, 507
- Skinner (Ada M. and Eleanor L.), Stories for the Nature Hour, 804
- Slate (Prof. F.), The Fundamental Equations of Dynamics and its Main Co-ordinate Systems Vectorially Treated and Illustrated from Rigid Dynamics, 65
- Slipher (Dr.), and others, Observations of the Total Solar Eclipse of 1918, June 8, 117
- Small (Dr. J.), appointed Professor of Botany in Queen's University, Belfast, 25; The Chemical Reversal of Geotropic Response in Roots and Stems, 249; The Origin and Development of the Compositæ, 450
- Small (Principal L.), Local Colleges and Adult Education, 728
- Smith (Hon. Sir Charles A.), bequest to Peterhouse, Cambridge University, 313
- Smith (Dr. E. W.), By-products from Coke-oven Gas, 695
- Smith (F. B.), appointed Reader in Estate Management in Cambridge University, 120
- Smith (F. E.), appointed Director of Scientific Research of the Admiralty, 245
- Smith (Prof. G. Elliot), elected to the Mary Louisa Prentice Montgomery Lectureship in Ophthalmology, 240; Keane's Man: Past and Present, 255; Medical Research, 605
- Smith (Dr. G. F. H.), Scientific Reunions at the Natural History Museum, 72
- Smith (Dr. G. L. Malcolm), appointed Assistant in Clinical Medicine in the University of Edinburgh, 280
- Smith (H. G.) and A. R. Penfold, The Manufacture of Thymol, Menthone, and Menthol from Eucalyptus Oils, 732
- Smith (J. D.), appointed a Lecturer in Commerce at the London School of Economics and Political Science, 568
- Smith (Dr. R. C.), Misinformation and Misconception concerning Natural History, 146
- Smith (T.), The Balancing of Errors, 122; Tracing Rays through an Optical System, 473
- Smith (Prof. Sir William), presented with the Medal of Honour of the University of Brussels, 440
- Smith (W. C.), Riebeckite-rhyolite from North Kordofan, Sudan, 156
- Smith (W. W.), A Theory of the Mechanism of Survival: The Fourth Dimension and its Applications, 484
- Sô and Imai, Two Factors concerned in Spotting in Mice, 400
- Soddy (Prof. F.), Applied Science and Industrial Research, 422; Education in the New Era, 561; Le Radium: Interprétation et Enseignement de la Radioactivité, Traduit de l'Anglais par A. Lepape, 805; Science and Life: Aberdeen Addresses, 1; The Public Support of Scientific Research, 309; The Separation of the Isotopes of Chlorine, 516, 642
- Sola (C.), The New Minor Planet GM, 595
- Solvay (Dr. E.), elected an Honorary Member of the American Chemical Society, 500
- Sonntag (Dr. C. F.), Comparative Anatomy of the Tongues of the Mammalia, 218
- Sorabji (R. K.), Facilities for Indian Students in America and Japan, 377
- Souder (W. H.), and P. Hidvert, Measurements of the Expansion of Samples of Porcelain, etc., 181
- Souèges (R.), The Embryogeny of the Solanaceæ, 442, 475
- Spaight (Dr. J. M.), Aircraft in Peace and the Law, 483
- Speare (A. T.), Experiments on *Sorosporella ucella*, 310
- Speidel (C. C.), Gland-cells of Internal Secretion in the Spinal Cord of the Skates, 279
- Spring (F. G.), and J. N. Milsum, Food Production in Malaya, 180
- Squier (Gen.), Multiplex Telephony and Telegraphy over Open-circuit Bare Wires laid in the Earth or Sea, 467
- Stacey (W. F.), Practical Exercises on the Weather and Climate of the British Isles and North-west Europe, 133
- Stamp (L. D.), appointed Demonstrator in Geology at King's College, London, 608
- Stanton (T. E.), Miss D. Marshall, and Mrs. C. N. Bryant, The Conditions at the Boundary of a Fluid in Turbulent Motion, 441
- Starkie (Dr. W. J. M.), [obituary], 686
- Stauffacher (Dr. H.), Neue Beobachtungen über den Erreger der Maulund Klauenseuche: Die Entwicklung des Schmarotzers im Blut, speziell in den roten Blutkörperchen, 100
- Staward (R.), Practical Hardy Fruit Culture, 545
- Stead (Dr. J. E.), Progress made in the Ferrous Industries during the past Fifty Years, 403
- Stebbing (E. P.), appointed Professor of Forestry in the University of Edinburgh, 537; Commercial Forestry in Britain: its Decline and Revival, 577
- Stephens (Miss Jane), The Fresh-water Sponges of Ireland, 474
- Stephenson (Prof.), Oligochoeta from the Lesser-known Parts of India and from Eastern Persia, 656
- Stephenson (T. A.), The Genus *Corallimorphus*, 474
- Stevens (Dr. H. P.), The Stretching of Rubber in Free Balloons, 613
- Stevenson (Dr. T. H. C.), The Fertility of the Social Classes in England and Wales, 655
- Steward (G. C.), appointed Assistant Lecturer in Applied Mathematics in Leeds University, 698
- Stewardson (H. C.), [obituary], 502
- Stewart (Prof. A. W.), Stereochemistry. Second edition, 129
- Stiles (Prof. C. W.), awarded a Mary Kingsley Medal, 697
- Stillwell (Dr. F. L.), The Factors Influencing Gold Deposition in the Bendigo Goldfield, 465
- Stoklasa (J.), The Action of Hydrocyanic Acid on the Organism of Plants, 530
- Stoney (Edith A.), The Carrying Power of Spores and Plant-life in Deep Caves, 740
- Stratton (Dr. F. J. M.), The Universities and the Army, 234
- Street (R. O.), The Tidal Motion in the Irish Sea: its Currents and its Energy, 632
- Stromeyer (C. E.), The After-effects of Cannibalism, 90
- Strong (Prof. J.), elected President of the Association of University Teachers, 537
- Stuart (H. Akroyd), Claim for Recognition as a Pioneer Inventor of Oil-engine Cycles, 409
- Stuart (Sir Thomas P. Anderson), [obituary article], 111
- Sullivan (L. R.), The Pygmy Races of Man, 367
- Sulman (A. E.), Australian Wild Flowers. Second series, 34; Some Familiar Wild Flowers, 34
- Sulman (F.), A Popular Guide to the Wild Flowers of New South Wales. Vol. ii., 34
- Summers (A. L.), Asbestos and the Asbestos Industry: the World's Most Wonderful Mineral and other Fireproof Materials, 193
- Sutton and Sons, Experiments in Seed Electrification, 337
- Sutton (J. R.), A Possible Lunar Influence upon the Velocity of the Wind at Kimberley, 700; Overgrowths on Diamond, 507; Statistics of Thunder and Lightning at Kimberley, 507; The Relationship between Cloud and Sunshine, 667

- Swinton (A. A. Campbell), elected Chairman of the Council of the Royal Society of Arts, 654; Life and Letters of Silvanus P. Thompson 448; Receipt of Wireless Messages from Paris and Slough while Lecturing, 80
- Sydenham (Lord), Science and the Nation, 468
- Sykes (Major-Gen. Sir Frederic H.), Imperial Air Routes, 359
- Sykes (Miss Ella), and Brig.-Gen. Sir Percy Sykes, Through Deserts and Oases of Central Asia, 330
- Tancock (E. O.), The Elements of Descriptive Astronomy. Second edition, 131
- Tanner (Dr. F. W.), Bacteriology and Mycology of Foods, 99
- Tanret (G.), Pelletierene and Methylpelletierene, 442
- Tansley (A. G.), The New Psychology and its Relation to Life, 770
- Tarleton (Dr. F. A.), [death], 525; [obituary article], 554
- Tattersall (Dr. W. M.), Life-history of the Periwinkle, 373; Museums and the State, 102
- Tavener (P. A.), "The Birds of Eastern Canada," 623
- Taylor (E. H.), Need for the Protection of the Philippine Hawksbill Turtle, 756
- Taylor (Dr. Griffith), Agricultural Climatology of Australia, 442; Climatic Cycles and Evolution, 728
- Taylor (H. J.), Day Continuation Schools, 23
- Taylor (Dr. H. S.), Fuel Production and Utilisation, 609
- Taylor (Dr. Monica), Aquarium Cultures for Biological Teaching, 232
- Taylor (Sedley), [obituary article], 143
- Taylor (W.), Scientific Apparatus and Laboratory Fittings, 357
- Taylor (W. T.), Calculation of Electric Conductors, 229
- Templeton (J.), appointed Lecturer in Botany in Edinburgh University, 120
- Terada (Prof.), Effect of Topography on Precipitation in Japan, 509
- Terhune (A. P.), *Lad: a Dog*, 484
- Termier (Prof. P.), "Les Grands Enigmes de la Géologie," 593; "Les Océans à travers les Âges," 624
- Terras (H.), The Story of a Cuckoo's Egg, 746
- Thaxter (Prof. R.), elected a Foreign Member of the Linnean Society, 366
- Thomas (H. Hamshaw), Aircraft Photography in the Service of Science, 457; Petrographical Notes on Rocks from Deception Island and Roberts Island, etc., 282; re-appointed Curator of the Cambridge University Botanical Museum, 313; and E. G. Radley, Certain Xenolithic Tertiary Minor Intrusions in the Island of Mull, 473
- Thomas (J. S. G.), A Directional Hot-wire Anemometer, 122
- Thomas (T.), Revision Arithmetic, Logarithms, Slide Rule, Mensuration, Specific Gravity, and Density. Second edition, 220
- Thomas (W. N.), Surveying, 801
- Thompson (Prof. D'Arcy W.), Hydrographical Studies, 150; Poetry and Medicine, 414
- Thompson (Dr. F. C.), awarded the Sorby Research Fellowship, 377
- Thompson (Dr. J. M'Lean), New Stellar Facts and their Bearing on Stellar Theories for the Ferns, 250
- Thompson (J. S.), and H. G. Thompson, Silvanus Phillips Thompson, D.Sc., LL.D., F.R.S., his Life and Letters, 448
- Thompson (L. Beatrice), Just Look! or How the Children Studied Nature, 651
- Thomsen (T. C.), Memorandum on Solid Lubricants, 372
- Thomson (D. H.), A New Alignment Diagram for Engineers, 116
- Thomson (Sir Joseph), elected a Fellow of the Royal Danish Society of Science, 200; *La Théorie Atomique*, Traduit par Prof. M. C. Moureu. Nouveau Tirage, 36; Oration in Presentation of an Honorary Degree to, 568
- Thomson (W.), and H. S. Newman, Behaviour of Amalgamated Aluminium Wire, 90; Further Notes on the Filamentous Growths from Aluminium Amalgams, 506
- Thorne (P. C. L.), Chemistry from the Industrial Standpoint, 227
- Thorpe (Prof. Jocelyn), The Indian Chemical Service, 324
- Thorpe (Sir T. E.), Lewes and Brame's Service Chemistry. Fifth edition, 287; Monument to Charles Gerhardt, 436
- Thring (L. G. P.), appointed Superintendent of the Engineering Drawing Office of Cambridge University, 345
- Thurn (Sir Everard im), The Island of Stone Statues, 583
- Tilho (J.), The Frequency of Fogs in the Eastern Sahara, 571
- Tillyard (Dr. R. J.), The Cawthron Institute, 603; The Neuropteroid Insects of the Hot Springs Region, N.Z., in relation to the Problem of Trout-food, 667; The Panorpid Complex. Additions to part 3, 667
- Timiriazeff (Prof. C. A.), [obituary article], 430
- Ting (Sih Ling), Electron Emission from Hot Bodies, 441
- Tinkler (Dr. C. K.), and Helen Masters, Applied Chemistry. Vol. i., Water, Detergents, Textiles, Fuels, etc., 227
- Tisdale (C. W. W.), and J. Jones, Butter and Cheese, 738
- Tizard (Capt. T. H.), Use of Summer Lines in Navigation, 552, 742
- Tomes (Sir Charles), Gift of Microscopical Preparations to the Museum of the Royal College of Surgeons of England, 557
- Tonelli (L.), Primitive Functions, 251
- Toni (Prof. G. B. de), elected a Foreign Member of the Linnean Society, 366
- Toporescu (M.), The Lime and Magnesia carried down by Precipitates of Ferric Oxide, 475
- Torrance (W.), Observations on Soil Erosion, 434
- Tostevin (Eng.-Comdr. H. B.), The Use of Mechanical Reduction Gears between the Turbines and the Propeller in the Royal Navy, 148
- Trafton (G. H.), The Teaching of Science in the Elementary School, 420
- Travers (Dr. M. W.), Scientific Research and the Glass Industry in the United States, 9; The Indian Chemical Service, 354
- Trechmann (Dr. C. T.), A Dried Specimen of *Holopus* from Barbados, 757
- Traub (Prof. H.), [death], 208
- Trillat (A.), and M. Mallein, The Projection of Microorganisms into the Air, 475
- Trotter (A.), The Supposed Parthenocarp of the Hazelnut and its Possible Characters (ii.), 251
- Trowbridge (Prof. A.), Sound-ranging as Practised by the U.S. Army during the War, 116
- Trueman (Dr. A. E.), appointed Lecturer in Geology at University College, Swansea, 665
- Tsuboi (S.), Oshima, 787
- Turner (Major C. C.), The Struggle in the Air, 1914-18, 229
- Turner (Prof. H. H.), The Cost of Scientific Publications, 326; and others, Papers on Astronomy published during 1914-19, 407
- Turner (Dr. W. E. S.), appointed Professor of Glass Technology in Sheffield University, 601
- Turrell (Dr. W. J.), The History of Electro-therapy, 81
- Turrill (W. B.), Botanical Exploration in Chile and Argentina, 433
- Tutton (Dr. A. E. H.), Monoclinic Double Selenates of the Copper Group, 538
- Tychonis Brahe Dani Opera Omnia. Editid I. L. E. Dreyer. Tomus vi., 672
- Tyndall (Prof. A. M.), appointed Dean of the Faculty of Science of Bristol University, 630
- Unwin (A. H.), African Softwoods for Pulp Production, 500
- Urich (F. W.), and others, Artificial *versus* Natural Methods of Control of Insect Pests, 503
- Ussher (W. A. E.), [obituary], 144
- Vail (T. N.), [obituary], 272
- Vanghetti (Dr. G.), awarded the Riberi Prize, 557

- Van Rhijn (P. J.), Total Light of the Stars, 54  
 Vaughan (T. W.), The American Tertiary, Pleistocene, and Recent Coral-reefs, 401  
 Vaughan-Williams (Capt.), Discovery of supposed Saxon Remains in Windsor Great Park, 209  
 Vernon (R. H.), appointed Assistant to the Professor of Chemistry in the University of Cambridge, 665  
 Verschaffel (J. E.), and R. Crombez, Anomalous Dispersion of Methyl-violet, etc., 559  
 Veil (Mlle. S.), Alloys of Oxides, 347  
 Very (Prof. F. W.), The Wasting of Stellar Substance, 276  
 Vignaud (H.), The Columbian Tradition on the Discovery of America and of the part played therein by the Astronomer Toscanelli, 803  
 Vignon (L.), The Resistance of Tissues to Light and Ultra-violet Rays, 506  
 Villey (J.), Flight at High Altitudes, 346  
 Vincent (Dr. J. H.), Further Experiments on the Variation of Wave-length of the Oscillations Generated by an Ionic Valve due to Changes in Filament Current, 121; The Origin of the Elements, 842  
 Violle (H.), Milk and Hæmolysis, 411  
 Virville (Ad. Davy de), Comparative Geographical Distribution of *Primula officinalis*, *P. grandiflora*, and *P. elatior* in the west of France, 411  
 Vlès (F.), Study of Absorption based on the Properties of the Nitrophenols, 506; Ultra-violet Spectrophotometry of the Nitrophenols, 475  
 Vleuten (Miss A. van), The Possibility of accounting for the Daily Variations of the Earth's Magnetic Field, 401  
 Vournazos (A. C.), A new Series of Complex Combinations: the Antimony Oxyiodides, 475  
 Voûte (J.), and others, Parallax of the B-type Star Boss 1517, 838
- Waddell (J. A. L.), The Economical Use of Special Alloy Steels in the Construction of Bridges, 699  
 Wagner (W. G.), Museums and the State, 70  
 Wakeford (the late E. K.), Canonical Forms, 369  
 Walcott (Dr. C. D.), The Persistence of Genera, 689  
 Wales (the Prince of), nominated as an Honorary Fellow of the Royal Society of Edinburgh, 335; patron of the British School of Archaeology in Jerusalem, 52  
 Walker (Dr. C.), appointed Associate-Professor in Cytology and Lecturer in Histology in Liverpool University, 376  
 Walker (Dr. G. T.), The Probable Amount of Monsoon Rainfall in 1920, 724  
 Walker (G. W.), A Dynamical Specification of the Motion of Mercury, 198  
 Walker (Prof. J.), Introduction to Physical Chemistry. Eighth edition, 129  
 Wall (Dr. R. C. B.), to Deliver the Bradshaw Lecture, 722  
 Wallas (Prof. Graham), gift to University College, London, 155  
 Waller (Dr. A. D.), The apparent "Growth" of Plants (and of Inanimate Materials) and of their apparent "Contractility," 410  
 Wallis (T. E.), The Lycopodium Method of Quantitative Microscopy, 249  
 Walmsley (Lt. L.), "The Recent Trans-African Flight," 624  
 Walsh (Prof. J. J.), Medieval Medicine, 127; Science and Scholasticism, 547  
 Walshe (Dr. F. M. R.), The Pathology and Symptomatology of Beri-beri, 241  
 Walton (Sir Charles), Eugenics, Civics, and Ethics, 804  
 Waltenberg (R. G.), and W. W. Coblenz, The Spectral Reflective Properties of Alloys of Aluminium, etc., 212  
 Waran (H. P.), The Effect of a Magnetic Field on the Intensity of Spectral Lines, 379  
 Ward (Miss E. M.), The Evolution of the Hastings Coast-line, 82  
 Ward (Dr. F.), Animal Life under Water, 651  
 Ward (W. A.), Modern By-product Coke-oven Construction, 695  
 Warren (S. H.), A Natural "Eolith" Factory beneath the Thanet Sand, 378  
 Waterson (J.), Fleas and their relation to Man and Domestic Animals, 787
- Watkins (L. T.), Libraries in Indian High Schools, 698  
 Watson (Prof. J. B.), Psychology from the Standpoint of a Behaviorist, 512  
 Watson (J. S.), Development of the Generating Stations of the Newcastle-upon-Tyne Electric Supply Co., 369  
 Watt (Sir George), Cotton-growing in the British Empire, 104; to deliver Lectures on Indian Forest Trees at Edinburgh University, 120  
 Watt (Dr. H. J.), The Foundations of Music, 98  
 Watts (Sir Francis), Tropical Departments of Agriculture, with Special Reference to the West Indies, 344  
 Watts (Prof. W. W.), The Evolution of the Bicycle, 435  
 Webb (Sir Aston), Value of Science and Scientific Research to Medicine and Surgery, 304  
 Webb (W. M.), The Brent Valley Bird-sanctuary, 614  
 Weber (Dr. F. Parkes), appointed Mitchell Lecturer of the Royal College of Physicians of London, 1921, 755  
 Webster (A. D.), National Afforestation, 577  
 Webster (D. L.), The Intensities of X-rays of the L series II, 667  
 Wedderburn (Dr. E. M.), The Importance of Meteorology in Gunnery, 492  
 Wedmore (E. B.), The Importance of Co-operative Scientific Research, 339  
 Weiss (H.), The Constituents formed by Reciprocal Penetration of Zinc and Copper at a Temperature where One of the Two Metals and All their Alloys are in the Solid State, 699  
 Wells (Prof. H. L.), Chemical Calculation Tables: for Laboratory Use. Second edition, 33  
 Wells (Dr. S. Russell), London Degrees in Commerce, 440; re-elected Vice-Chancellor of London University, 568  
 Wells and Southcombe, The Theory and Practice of Lubrication, 21  
 Wertheimer (Prof. J.), Seconding of Officers for Study at Universities, 41  
 West (F. L.), N. E. Edlfsen, and S. Ewing, Determination of Normal Temperatures by Means of the Equation of the Seasonal Temperature Variations, etc., 628  
 West (G. D.), A Modified Theory of the Crookes Radiometer, 473; The Forces Acting on Heated Metal-foil Surfaces in Rarefied Gases, 122  
 West (Dr. S. H.), [obituary], 50  
 Westaway (F. W.), Science and Theology: Their Common Aims and Methods, 607; Scientific Method: its Philosophy and its Practice, 5  
 Wharton (the late Rear-Admiral Sir W. J. L.), Hydrographical Surveying. Fourth edition, revised and enlarged by Adml. Sir Mostyn Field, 576  
 Wheaton (Dr.), Maternity and Child Welfare, 151  
 Wheeler (Dr. R. B.), appointed Professor of Fuel Technology in Sheffield University, 665  
 Wheeler (Dr. R. E. M.), appointed Keeper of the Department of Archaeology in the National Museum of Wales, and Lecturer in Archaeology in the University of South Wales and Monmouthshire, 569  
 Wheeler (Prof. W. M.), The Parasitic Aculeate Hymenoptera, 835; and I. W. Bailey, Feeding Habits of Pseudomyrmex Ants, 843  
 Whiddington (Prof. R.), An Attempt to Detect the Fizeau Effect in an Electron Stream, 708; Science and the New Army, 135  
 Whipple (Prof. G. C.), Vital Statistics: An Introduction to the Science of Demography, 131  
 Whipple (R. S.), Electrical Methods of Measuring Body Temperatures, 338  
 White (B.), Gold: Its Place in the Economy of Mankind, 774; Silver: Its Intimate Association with the Daily Life of Man, 774  
 White (Dr. N.), Health Conditions in Eastern Europe: Typhus a Serious Menace, 723  
 White (R. S.), Report on Outbreak of Pellagra amongst Armenian Refugees at Port Said, 592  
 Whitehead (Prof. A. N.), An Enquiry Concerning the Principles of Natural Knowledge, 446  
 Whitehead (Prof. J. B.), The High-voltage Corona in Air, 842  
 Whitfield (Dr. A.), appointed Lumsian Lecturer of the Royal College of Physicians of London, 1921, 755

- Whitley (E.), Gift for the Endowment of a Professorship in Biochemistry in Oxford University, 313
- Widal (F.), P. Abrami, and N. Iancovescu, The Proof of Digestive Haemoclasia and Latent Hepatism, 794; Proof of Digestive Haemoclasia in the Study of Hepatic Insufficiency, 762; The Possibility of Promoting the Haemoclastic Crisis by the Intravenous Injection of Portal Blood Collected during the Digestive Period, 699
- Wild (L. J.), Soils and Manures in New Zealand, 130
- Williams (Dr. A. M.), The Pressure Variation of Equilibrium Constant in Dilute Solution, 603
- Williams (W. R.), [obituary], 76
- Williamson (J. W.), Applied Science and Industrial Research, 387, 518; Remuneration and Superannuation of the Scientific Workers of Research Associations, 372
- Wilson (C. T. R.), awarded the Hopkins Prize of the Cambridge Philosophical Society, 440; Investigations on Lightning Discharges and on the Electric Field of Thunderstorms, 377
- Wilson (Prof. F. J.), and Prof. I. M. Heilbron, Chemical Theory and Calculations. Second edition, 805
- Wilson (Prof. J.), Application of the Food-unit System to the Fattening of Sheep, 282
- Wilson (J. S.), and G. A. Garfit, Map of the Eyam Moor Circle in Derbyshire, 180
- Wilson (Prof. J. T.), elected Professor of Anatomy in Cambridge University, 439
- Wilson (R. E.), Researches on Nebulae, 491
- Wilson (W. H.), and Miss T. D. Epps, Construction of Thermo-couples by Electro-deposition, 842
- Wilson-Barker (Sir David), The "Flight" of Flying-fish, 455
- Wilton (T. R.), appointed Lecturer in Dock and Harbour Engineering in Liverpool University, 505
- Wimmer (Prof. L. F. A.), [obituary], 365
- Winstedt (R. O.) Analogies between the Local Customs of the Malay Peninsula and those of the Brahmans of South India, 834
- Winterbotham (Lt.-Col. H. S. L.), awarded the Victoria Medal of the Royal Geographical Society, 112; Principles and Practice of Surveying, 801
- Witz (Prof. A.), Heat Economy, 212
- Wohlgenuth (Dr. A.), Pleasure—Unpleasure: An Experimental Investigation on the Feeling-elements, 3
- Wolf (Prof.), A Nova in a Spiral Nebula, 213
- Woltjer, jun. (Dr. J.), Investigations in the Theory of Hyperion, 675
- Wood Bros. Glass Co., Ltd., Catalogue of English Chemical Glassware, 435
- Wood (Miss J. F.), History of Popular Education since the Act of 1870, 213
- Wood (T. B.), and Dr. F. H. A. Marshall, Physiology of Farm Animals. Part i., General, Dr. F. H. A. Marshall, 704
- Woodland (Prof. W. N. F.), The "Flight" of Flying-fish, 455; The "Renal Portal" System (Renal Venous Mesh-work) and Kidney Excretion in Vertebrata, 410
- Woodward (Dr. A. Smith), re-elected President of the Linnæan Society, 496
- Wordie (J. M.), awarded the Back Grant of the Royal Geographical Society, 112
- Worsdell (W.), [obituary], 239
- Wright (C. S.), Science and the New Army, 391
- Wright (H. E.), Coke-oven Gas for Town Supply, 695
- Wright (Lewis), Optical Projection. Fifth edition, rewritten and brought up to date by R. S. Wright (in two parts). Part i., The Projection of Lantern Slides, 773
- Wright (Wilbur), Unveiling a Statue to the Memory of, 654
- Wright (W. B.), An Analysis of the Palaeozoic Floor of North-East Ireland, with Predictions as to Concealed Coalfields, 368; The Asiatic Origin of Man, 728
- Wright (W. H.), Certain Aspects of Recent Spectroscopic Observations of the Gaseous Nebulae, 842; Infra-red Spectra of Nebulae, 149; Researches on Nebulae, 492
- Wyatt (R. B. H.), appointed Lecturer in Bacteriology in Birmingham University, 154
- Wyatt (S.), Individual Differences in Output in the Cotton Industry, 657
- Wybergh (W.), The Coastal Limestones of the Cape Province, 689
- Wyeth (F. J.), Development of the Auditory Apparatus in *Sphenodon punctatus*, 26
- X. Y. Z., International Council for Fishery Investigations, 262
- Xanthoudides (M.), Excavations in Crete, 273
- Yamasaki (E.), The Chemical Kinetics of Catalase, 402
- Yeatman (M. E.), British and Metric Systems of Weights and Measures, 355
- Yendo (Prof. K.), The Genus of Brown Seaweeds, *Alaria*, 664
- Yerkes (Dr. R. M.), Psychological Examining and Classification in the U.S. Army, 795
- Yokoyama (Prof. M.), Fossils from the Miura Peninsula and its Immediate North, 836
- Young (J.), The Royal Military Academy, 487
- Youngusband (Lt.-Col. Sir Francis), Plea for a Wider Outlook in Geography, 465
- Yule (G. U.), re-appointed University Lecturer in Statistics in Cambridge University, 88
- Zammit (Prof. T.), awarded a Mary Kingsley Medal, 697; conferment upon, of the Honorary Degree of Doctor of Letters by Oxford University, 440
- Zangheli (C.), A New View of the Nascent State, 339; New Researches on the Action of Gases in a very Fine State of Division, 763; and B. Papaconstantinou, Colloidal Rhodium, 411; The Acceleration of the Decomposition of Hydrogen Peroxide by Colloidal Rhodium, 443

## TITLE INDEX.

- Aberdeen University: W. G. Craib appointed Professor of Botany in, 120; Gift to, by Sir Thomas Jaffrey; conferment of an Honorary Degree upon Sir Jagadis Chandra Bose, 154; Dr. R. D. Lockhart appointed a Lecturer in Anatomy, 730
- Aborigines of Central Australia, The Present Condition of the, E. N. Fallaize, 601
- Absorption: Based on the Properties of the Nitrophenols, F. Vlès, 506; Light by Elements in the State of Vapour, Sir James Dobbie and J. J. Fox, 538
- Abstracts of Papers in Scientific Transactions and Periodicals, 758
- Academic Research and Industrial Application, 449
- Académie Royale de Belgique, Sir W. J. Pope elected an Associate of the, 463
- Academy, The Royal, 300
- Acarina of the Intertidal Zone, J. N. Halbert, 474
- Acetone, Preparation of, by the Fermentation of Starchy Material, J. Reilly, and others, 466
- Acetylene Hydrocarbons. The Production of True, starting from Epidibromhydrin, Lespiau and Bourguel, 635
- Acids, Alkalis and Salts, G. H. J. Adlam, 705
- Acromyde pancheri*, Pilger, Structure and Affinities of, B. Sahni, 346
- Actinometers of Arago and Bellani, The, L. Besson, 283
- Acyiketamines, C. Moureu and G. Mignonac, 539
- Adelaide University, Dr. J. B. Cleland appointed Professor of Pathology in, 217
- Admiralty, F. E. Smith appointed Director of Scientific Research to the, 245

- Advisory Council to the Committee of the Privy Council for Scientific and Industrial Research, Sir John Cadman, W. B. Hardy, and Prof. S. Young appointed Members of the, 590
- Aerial Navigation and Meteorology, Lt.-Col. E. Gold, 775; Prof. E. van Everdingen, 637, 776
- Aerodynamics, Applied, L. Bairstow, 95; of a Spinning Shell, The, R. H. Fowler, E. C. Gallop, C. N. H. Lock, and H. W. Richmond, 377
- Aerography, The Principles of, Prof. A. McAdie, 479
- Aeronautical Research, 95, 342
- Aeronautics: Education and Research in, Report of the Committee on, 15; Lectures on, at the Imperial College of Science and Technology, Sir Richard Glazebrook, 214; Research in, The Relationship of Education to, 14; Report of the Advisory Committee for Aeronautics for the year 1918-19, 561
- Aeroplane: Flight: along Africa from North to South, Col. van Ryneveld and Capt. Brand, 113; From Cairo to the Cape, Failure of the, 18; Height Flight, Record, Major R. W. Schroeder, 18
- Aeroplanes, Wireless Telephony in, Major C. E. Prince, 55
- Afforestation, National, A. D. Webster, 577
- African: Art, H. V. Hall, 180; Softwoods for Pulp Production, A. H. Unwin, 599
- Agricultural: Development in the West Indies, 344; Research, American, 310
- Agriculture: and the Farming Business, O. H. Benson and G. H. Betts, 35; Basic Slag and its Uses in, Dr. E. J. Russell, and others, 183; The Origin of, Major T. Cherry, 474
- Aircraft: in Peace and the Law, Dr. J. M. Spaight, 483; Photography in the Service of Science, H. Hamshaw Thomas, 457
- Air: Ministry. Convention for the Regulation of Aerial Navigation (October 13, 1919), 637; Routes, Imperial, Maj.-Gen. Sir Frederic H. Sykes, 359; Service, Science and Research in the, 142; The Optical Properties of, the Blue Sky, and, Lord Rayleigh, 584; The Struggle in the, 1914-18, Major C. C. Turner, 229
- Alaria, Prof. K. Yendo, 664
- Alaska, Exploration and Illustration of, 147
- Alchemy and Chemistry among the Chinese, Dr. J. A. R. Henderson, 474
- Alcohol: The Supposed Dynamogenic Power of, J. Athanasiu, 251; The whole Truth About, G. E. Flint, 386
- Alcohols, *a*-Ketonic Tertiary, The Synthesis of, D. Gauthier, 27
- Algebra, Projective Vector, An Algebra of Vectors Independent of the Axioms of Congruence and of Parallels, Dr. L. Silberstein, 65
- Alignment Diagram for Engineers, A New, D. H. Thomson, 116
- Alliments Sucrés. Sucres—Miels—Sirops—Confitures—Sucrées—Sucs et Régisse, Drs. E. Roux and C.-F. Muttetle, 641
- Almost-Atolls, The Small Islands of, Prof. W. M. Davis, 292
- Alpine Insolation Effects on Unprotected Wood, Prof. E. Knecht, 90
- Alternating: Current Work. An Outline for Students of Wireless Telegraphy, A. Shore, 133; Electric Current, The Transient Process of Establishing a steady, Dr. A. E. Kennelly, 843
- Altitudes, Extreme, a Method of Reaching, Prof. R. H. Goddard, 809
- Aluminium: Amalgamated, and Aluminium Wire, The Behaviour of, W. Thomson and H. S. Newman, 90; Amalgams, The Filamentous Growths from, W. Thomson and H. S. Newman, 506; Catalytic Action of, in the Preparation of the Chlorobenzenes, J. Meunier, 571; Its Manufacture, Manipulation, and Marketing, G. Mortimer, 805
- Allegheny Observatory, Dr. H. D. Curtis appointed Director of the, 366
- Alligator Pear, The, 408; Dr. M. Grabham, 517
- "All-or—None" in the Auditory Nerve, Dr. W. Perrett, 390
- Allotments, The Development and Uses of, Sir Daniel Hall, 371
- Alloys of Copper, Zinc, and Nickel, The, L. Guillet, 91
- Amanita, Determination of Poisonous Varieties of, by Colour Reactions, J. Barlot, 219
- Amber in Antiquity, The Search for, W. J. Perry, 274
- American: Agricultural Research, 310; Chemical Society, Dr. F. G. Cottrell awarded the Willard Gibbs Medal of the Chicago Section of the, 526; Dr. E. Solvay elected an Honorary Member of the, 590; Fisheries Society, Forthcoming Jubilee of the, 591; Fossil Vertebrate Animals, Prof. H. F. Osborn, and others, 117; Grape-growing, Manual of, U. P. Hedrick, 674; Museum of Natural History, Report for 1919 of the, Prof. H. F. Osborn, 724; Petroleum Institute, Dr. V. H. Manning appointed Director of Research in the, 527; Pomological Society, Re-organisation of the, by Prof. L. H. Bailey, 623; Tertiary, Pleistocene, and Recent Coral-reefs, T. W. Vaughan, 401
- Amines by Catalysis, A New Preparation of, A. Mailhe, 442
- Ammonium Phosphomolybdate, Variations of the Composition of, S. Posternak, 347
- Amundsen's Trans-Polar Voyage, a Supporting Expedition for, 82; Further News of, 305
- Anæsthesia and Anaphylaxy, W. Kopaczewski, A. H. Roffo, and Mme. H. L. Roffo, 540
- Ancient: Camps in Gloucestershire, 128; *Egypt*, Resumption of, 180; Entrenchments and Camps of Gloucestershire, The, E. J. Burrow, 128
- Anemometer, A Directional Hot-wire, J. S. G. Thomas, 122
- Angiosperms, Reproduction of, Elementary Notes on the, A. H. Church, 162
- Anglo-Egyptian Sudan, Entomological Work in the, H. H. King, 503
- Animal: Foodstuffs: The World's Supply of, 513; Their Production and Consumption, with a Special Reference to the British Empire, Dr. E. W. Shanahan, 513; Heroes: Being the Histories of a Cat, a Dog, a Pigeon, a Lynx, two Wolves, and a Reindeer, E. Thompson Seton. Fourth impression, 580; Life under Water, Dr. F. Ward, 651; Luminescence and Stimulation, Prof. E. N. Harvey, 843; Nutrition, Institute of Research in, at Aberdeen, Gift to the, by J. Q. Rowett, 80; Products, The Chemistry of, 192
- Animals, The Slaughter of, and the Distribution of Meat for Human Consumption, Appointment of a Committee of Inquiry Upon, 591
- Anomalous Dispersion of Methyl-violet, etc., J. E. Verschaffel and R. Crombez, 559
- Anopheles plumbeus*, Misses Blacklock and Carter, 241
- Anselm's Problem of Truth and Existence, Rev. A. E. Davies, 569
- Antarctic Anticyclone, The, Dr. G. C. Simpson, 777; R. M. Deeley, 808
- Anthocyanins in Plants, Formation of, O. Rosenheim, 402
- Anthropology: An Introduction to, Rev. E. O. James, 384; and Economics, Progress in, Sir Edward Brabrook, 530; Suggestions for the Classification of the Subject-matter of, E. N. Fallaize, 626
- Anticyclones, R. M. Deeley, 677
- Anti-Dumping Bill, The, 125; Gas Fan, Neglect in regard to the Use of the, Mrs. Ayrton, 336; 422; 612; 613; Prof. A. J. Allmand, 453; 612
- Antineuritic Vitamine, The Nature and Function of the, R. A. Dutcher, 667
- Antiquaries of London, Society of, Election of Officers and Council of the, 273
- Antiquity of Human Remains?, How Far can Osteological Characters Help in Fixing the, Prof. A. Keith, 153
- Ants, Pseudomyrmecine. Feeding Habits of, Prof. W. M. Wheeler and I. W. Bailey, 843
- Apalali Indians of the Amazon, The, W. C. Farabee, 249
- Applied Science and Industrial Research, J. W. Williamson, 518; Major A. G. Church, 547
- Apprentices in Shipyards and Marine Engineering Works. Education and Training of, 151
- Approximate Integration, Some Methods of, and of Computing Areas, Prof. J. B. Dale; R. A. P. Rogers, 138

April Meteor Shower, The, 276  
 Aquarium Cultures for Biological Teaching, Dr. Monica Taylor, 232  
 Arawaks, The Central, W. C. Farabee, 159  
 Arcachon, Ville de Santé; Monographie Scientifique et Médicale, Dr. F. Lalesque, 322  
 Archaeocyathinae from the Weddell Sea, Dr. W. T. Gordon, 528  
 Archaeological Research, The Prospects of, Sir C. H. Read, 497  
 Arc Spectra *in vacuo* and Spark Spectra in Helium of Various Elements, Prof. J. C. McLennan, J. F. T. Young, and H. J. C. Ireton, 632  
 Arcs of Primary Triangulation along the Ninety-eighth Meridian in the U.S. and in Mexico, and on Triangulation in Southern Texas, Connection of the, W. Bowie, 141  
 Arctic Expedition, Capt. Roald Amundsen's, 240, 273; Prairies, The, E. Thompson Seton, 426  
 Argus, Spectrum of, Dr. J. Lunt, 149  
 Aristotelian Society, Dean Inge elected President of the, 622  
 Arithmetic: for Preparatory Schools, An, with Answers, T. Dennis. Second edition, 67; Revision, Logarithms, Slide Rule, Mensuration, Specific Gravity, and Density, T. Thomas. Second edition, 229  
 Armstrong College, Dr. W. N. Haworth appointed Professor of Organic Chemistry at, 537  
 Army: Hygiene and its Lessons, Lt.-Gen. Sir Thomas Goodwin, 532; Prior to the Recent War, Gen. Sir John Goodwin, 52; The New, Science and, 61; Col. E. H. Hills, 103; Prof. L. N. G. Filon; Prof. R. Whiddington, 133; Lt.-Col. E. Gold; Dr. C. S. Myers, 135; Prof. A. R. Richardson, 170; Col. K. E. Edgeworth, 233; C. S. Wright, 391; The Scheme for the Education of the Rank and File of the, 121; The Universities and the, 157; F. J. M. Stratton, 234  
 Arsenic and Antimony Ores, H. Dewey, 338  
 Arsenious Acid, The Reversible Oxidation of, C. Matignon and J. A. Lecanu, 347  
 Art, The Teaching of, in Local Museums, M. J. Rendall, 627  
 Artillery Science, Sir George Greenhill, 268  
 Asbestos and the Asbestos Industry: The World's Most Wonderful Mineral and other Fireproof Materials, A. L. Summers, 193  
 Asia, A Geography of, J. Martin, 35  
 Asiatic Origin of Man, The, W. B. Wright, 728  
 Aspherical Nucleus Theory Applied to the Balmer Series of Hydrogen, The, Dr. L. Silberstein, 441  
 Asphodelus, A New Race of, Obtained by the Action of a Marine Climate, L. Daniel, 506  
 Association: of Technical Institutions, Forthcoming Summer Meeting of the, 631; of University Teachers, Prof. J. Strong elected President of the, 537  
 Asteroxylon *Mackiei* from the Rhynie Chert-Bed of Aberdeenshire, Dr. Kidston and Prof. Lang, 527  
 Astrographic Catalogue, The, 403  
 Astrolabe: Diagram, Dr. J. Ball, 329; A Handbook of the Prismatic, Dr. J. Ball and H. K. Shaw, 329  
 Astronomical Announcements by Wireless Telegraphy, Prof. Kobold, 403

## ASTRONOMICAL NOTES.

Comets:  
 Return of Tempel's Comet, 436; Photographs of the Broersen-Metcalf Comet, Prof. Barnard, 467; The Planetary Families of Comets, Prof. H. N. Russell, 467; Tempel's Second Periodic Comet, 560; Denning's Comet of 1881 and a Meteoric Shower, Rev. M. Davidson, 560; A New Comet, M. Schaumasse, 658; Tempel's Comet, M. Fayet, 789  
 Instruments:  
 A New Spectrophotometer and Solar Measurements made with it, W. W. Coblentz and H. Kahler, 625  
 Meteors:  
 Bright Meteors, 54; April Meteors, 149; The April Meteor Shower, 276; A Bright Fireball, 370; Commencement

of the Great Perseid Shower of Meteors, 595; An Interesting Meteorite, G. P. Merrill, 759

## Observatories:

The Madrid Observatory, 213; Memoirs of the Kodakian Observatory, vol. i., part ii., 340; Parallax Work at the Sproul Observatory, Dr. Miller, 500; Publications of the Dominion Astrophysical Observatory, Victoria, B.C., vol. i., No. 1, 658; Annual Report for 1920 of the Hill Observatory, Sidmouth, 726; New Solar Radiation Station in Arizona, 726; The Union Observatory, Johannesburg, 759; Stonyhurst Observations in 1919, Rev. A. L. Cortie, 789; Publications of the Astronomical Laboratory at Groningen, No. 29, Prof. J. C. Kapteyn, 838

## Planets:

Cape Observations of the Sun, Mercury, and Venus, 183; Conjunction of Jupiter and Neptune, 213; Occultation of a Star by Saturn, Prof. Plassmann and others, 244; Eclipse of the Moon, 276; Mars and Wireless Signals, 276; The Lunar Eclipse, 307; Conjunction of Mars with Spica, 340; Conjunction of Mercury with  $\epsilon$  Geminorum, A. Burnet, 370; The Planet Jupiter, Rev. T. E. R. Phillips, 500; Mercury an Evening Star, 529; The Lunar Parallax and Related Constants, Prof. W. de Sitter, 529; The New Minor Planet GM, 595

## Stars:

Occultation of a Star by Saturn, L. J. Comrie, 22; Total Light of the Stars, P. J. Van Rhijn, 54; Star Clusters, Dr. H. Shapley, 54; The Binary Star  $\rho$  Eridani, B. H. Dawson, 84; Faint Nebulae, E. P. Hubble, 84; Spectrum of  $\eta$  Argus, Dr. J. Lunt, 149; Infra-red Spectra of Nebulae, Dr. K. Burns and W. H. Wright, 149; Capella, Prof. F. Schlesinger and Z. Daniel, 183; A Nova in a Spiral Nebula, Prof. Wolf, 213; Stellar Spectroscopy at the Detroit Observatory, P. W. Merrill, L. Hadley, 244; The Wasting of Stellar Substance, Prof. F. W. Very, 276; The Binary Krueger 60, S. A. Mitchell and C. P. Olivier, 307; The Duplicity of  $\nu$  Geminorum, Dr. Bernewitz, 340; Conjunction of Mercury with  $\epsilon$  Geminorum, A. Burnet, 370; Double Stars, J. Jackson, 436; Diffraction Image of a Disc, Dr. H. Nagaoka, 436; The Masses of the Stars, Prof. H. N. Russell, 500; Capture Orbits, Prof. L. Becker, 560; The Expanding Disc of Nova Aquilae, Dr. J. Lunt, 595; Galactic Denotation, R. T. A. Innes, 759; Discovery of a Nova in Cygnus, W. F. Denning, 838; Parallax of the B-type Star Boss 1517, J. Voûte and others, 838

## Sun:

The Total Solar Eclipse of September 20, 1922, A. R. Hinks, 84; The Total Solar Eclipse of 1918, June 8, 117; Cape Observations of the Sun, Mercury, and Venus, 183; Kodaikanal Observations of Prominences, J. and Mrs. Evershed, 340

## Miscellaneous:

The Nautical Almanac for 1922, 22; Calendar Reform, A. Philip, M. Flammarion, 22; A Noon Reflector, Prof. C. V. Boys, 117; The Einstein Displacement of Spectral Lines, J. Evershed, C. E. St. John, 244; The Nature of Photographic Images, Dr. Kenneth Mees, 307; Longitude by Wireless Telegraphy, Prof. Sampson, 370; Astronomical Announcements by Wireless Telegraphy, Prof. Kobold; The Astrographic Catalogue, Tidal Friction and the Lunar and Solar Accelerations, Dr. H. Jeffreys, 403; The Zeeman Effect in Furnace Spectra, A. S. King, 529; An Easy Method of Finding Latitude, N. Liapin, 625; Increasing the Photographic Power of Telescopes, Dr. Shapley, 625; The Date of Easter, 691; Astronomy in Town Planning, H. L. Seymour, 691; The Infra-red Arc Spectra of Seven Elements, C. C. Kiess and W. F. Meggers, 726; The Structure of the Universe, Prof. W. D. MacMillan, 789

Astronomy: At Oxford during the War, Prof. H. H. Turner, and others, 407; Central Wireless Station for, Major W. J. S. Lockyer, 454; Descriptive, the



- Elements of, E. O. Tancock. Second edition, 131; in Town Planning, H. L. Seymour, 691
- Astrophysics**, Sir Norman Lockyer's Contributions to, Prof. A. Fowler, 831
- Athenæum Club**, Prof. C. J. Martin, Sir William Open, and Sir J. E. Pelavel elected members of the, 209
- Atlantic**: Meteorological Influences of the Sun and the, Prof. J. W. Gregory, 715; Ocean, an Oceanographical and Meteorological Atlas of the, Pt. i., 368
- Atmosphere**: At Great Heights, Composition, Ionisation, and Viscosity of the, Prof. S. Chapman and E. A. Milne, 570; High Levels in the, Attainment of, W. H. Dines, 454; Occurrence of Ozone in the, J. N. Pring, 645
- Atmospheric**: Circulation, General, The Meteorology of the Temperate Zone and the, Prof. V. Bjerknes, 522; Eddies, the Supply of Energy to, L. F. Richardson, 378; Nitrogen, Rate of Solution of, and Oxygen by Water, Prof. W. E. Adeney and H. G. Becker. Part iii., 379; Potential at the Algiers Observatory, A Diurnal Variation of the, F. Baldet, 283; Turbulence, Some Measurements of, L. F. Richardson, 57; Variations of Short and Long Duration in the Malay Archipelago and Neighbouring Regions, and the Possibility to Forecast Them, Dr. C. Braak, 729
- Atomic**: and Molecular Forces and Crystal Structure, Dr. A. E. Oxley, 327; and Molecular Structure, on, Dr. A. E. Oxley, 231; Structure, Theories of, I. Langmuir, 261; Theory, The Development of the, A. N. Meldrum, 212; Weights, Isotopes, and, Dr. F. W. Aston, 617; The Standard of, Prof. J. R. Partington, 264; Dr. S. Miall, 294
- Atomique**, La Théorie, Sir J. J. Thomson; Traduit par Prof. C. Moureu, Nouveau tirage, 36
- Atoms**: Langmuir's Theory of, S. C. Bradford, 41, 725; Dr. A. E. Oxley, 105; Nuclear Constitution of Atoms, Sir Ernest Rutherford, 500; The Structure of, Prof. A. Berthoud, 306
- Attitudes of the Body and Respiration**, J. Amar, 635
- Auditory Nerve**, "All-or-None" in the, Dr. W. Perrett, 390
- Aurora**: A Brilliant, Observed at Montreal, Prof. A. S. Eve, 337; of March 22-23, The, W. B. Housman, 200
- Australia**, Agricultural Climatology of, Dr. Griffith Taylor, 442
- Australian**: Delphacidae (Homoptera), A New Genus of, F. Muir, 635; Flies of the Family Asilidae, Synonyms, Notes, and Descriptions of, G. H. Hardy, 635; Hardwoods, 802; Native Fauna, Extirpation of the, C. M. Hoy, 558; Rainfall, Tropical Control of, E. T. Quayle, 152
- Australischen Sprachen**, Die Gliederung der, P. W. Schmidt; S. H. Ray, 707
- Auto-ballistic Astronomical Pendulum**, An, A. Guillet, 506
- Automobile Steels**, Research on, 600
- Aviation**: and Scientific Exploration, Dr. P. Chalmers Mitchell, 336; Civil, Report of the Advisory Committee on, 556; Report of the Department of, 592
- Avocado** or Alligator Pear, Cultivation of the, W. G. Freeman, 408
- Ayrshire Cattle**, Milk Production of, Prof. R. Pearl and J. R. Miner, 245
- E. coli communis***, The Enzymes of, E. C. Grey, 538
- Bacteria**, The Transmutation of, Dr. S. Gurney-Dixon, 131
- Bakerian Lecture**, The, Sir Ernest Rutherford, 500
- Balmer Series of Hydrogen Lines**, The Structure of the, Dr. T. R. Merton, 314
- Band Spectra of Nitrogen**, Production of the, by Electrons of Low Velocity, L. and E. Bloch, 530
- Banks**: Sir Joseph, The Centenary of, 496; Dr. B. Dryden Jackson; Dr. A. B. Rendle; J. Britten; Dr. A. Smith Woodward, 530
- Barnard Medal of Columbia University**, The, awarded to Prof. Einstein, 500
- Barvets** in the English Triassic Strata derived from overlying Jurassic Strata, H. W. Greenwood, 857
- Basic Slag and its Uses in Agriculture**, Dr. E. J. Russell; Sir Thomas Middleton, 183; Bainbridge; G. Scott Robertson; D. Sillars, 184
- Batu Kurau Parish, Perak**, Exploration of a Rock Shelter in the, I. H. N. Evans, 834
- Bedford College for Women**, Appeal for Funds by, 186
- Bee-Eater** in Scotland, Nesting of the, J. K. Nash, 786
- Bees**: Eye-Colour in, Prof. T. D. A. Cockerell, 518; and the Scarlet-Runner Bean, H. J. Lowe, 742
- Beetles**, Indian, 64
- Behaviourism**, Prof. H. Wildon Carr, 512
- Beit Fellowship for Scientific Research**, M. A. Hogan elected to a, 605
- Belfast, Queen's University**: Dr. J. Small appointed Professor of Botany in, 25; Gift to, by F. A. Heron, 248
- Belgian Congo Territory**, Zoological Collections made in the, during 1909-15, 593
- Bengal, Biological Papers from**, Dr. N. Annandale, 436
- Benzene**: Chlorination of, Kinetic Study of the, F. Bourion, 506; extracted from Commercial Chlorobenzenes, Impurities of the, F. Bourion, 443
- Benzoic Acid**, A Reaction for, based on its Diazotisation, M. Guerber, 666
- Benzoylphenylacetylene di-iodide**, The Stereo-isomeric forms of, C. Dufraisse, 475
- Beri-Beri**, The Pathology and Symptomatology of, Dr. F. M. R. Walshe, 241
- Bibliographies**, The Compilation of, F. Bullock, 116
- Bicycle**, The Evolution of the, Prof. W. W. Watts, 435
- Billingham-on-Tees**, Sale of the Nitrate Factory at, to Brunner, Mond and Co., Ltd., 312
- Biological Papers from Bengal**, Dr. N. Annandale, and others, 436
- Bipolar Co-ordinates**, Plane Stress and Plane Strain in, G. B. Jeffery, 632
- Bird**: Life, The Romance of, 746; Protection, The Plumage Bill and, Sir H. H. Johnston; Prof. H. M. Lefroy, 168; Sir Herbert Maxwell; Prof. A. Dendy, 169; Dr. W. E. Collinge, 196; Prof. J. E. Duerden, 263
- Birds**: and Beasts, The Story-Book of, J. H. Fabre, 651; in Town and Village, W. H. Hudson, 651; Life and Lore of, 514; of Eastern Canada, The, P. A. Tavener, 623; of Egypt, Hand-List of the, M. J. Nicoll, 674; of the British Isles, The, and their Eggs, T. A. Coward. First series, 132
- Birkbeck College**, A Course of Training for ex-Service Men for Positions on Rubber and Tea Plantations, 280
- Birmingham University**: A. A. Dee appointed an Assistant Lecturer in Physics in, 120; A. R. Ling appointed Adrian Brown Professor of Brewing; Erection of a Memorial Tablet to Prof. Adrian Brown; Gift from the Asiatic Petroleum Co.; F. Shaw appointed Assistant Lecturer in Electrical Engineering, and R. B. H. Wyatt Lecturer in Bacteriology, 154; Impending Resignation of Sir John Cadman of the Chair of Mining, 409; Students in, 472; The Department of Mining to be re-organised and extended; Prof. F. W. Burstall elected Dean of the Faculty of Science, 505; Conferment of Degrees, 630; Increase in Cost of Fees; The Necessity for Increasing the Stipends of the Staff, Sir Gilbert Barling, 730
- Birth-Rate**, The, W. L. George 82
- Bitterns**, Buzzards and, Canon E. McClure, 105
- Black Smoke Tax**, The, 471
- Blepharospora terrestris***, A Parasite of the Lupin, B. Peyrouel, 844
- Blood**, The Circulating, in Relation to Wound-Shock, Prof. W. M. Bayliss, 9
- Blow-flies**, Experiments in Breeding, Prof. Enriques, 756
- Board of Trade**, Dr. Edridge-Green appointed a Special Examiner in Colour Vision and Eyesight by the, 654
- Body Temperatures**, Electrical Methods of Measuring, R. S. Whipple, 338
- "Book of the Dead," The, Sir E. A. Wallis Bridge, 755
- Books**, Scientific and Technical, Sir R. A. Gregory, 41
- Boss** 1517, Parallax of the B-type, J. Voûte, and others, 838
- Botanical Guides**, 34
- Botany**: Applied, G. S. M. Ellis, 164; Applied Economic, Based upon Actual Agricultural and Gardening Projects, Dr. M. T. Cook, 34; A University Course in, 162; Structural, Elementary Notes on, A. H. Church, 162

- Botrytis cinerea*, with colourless sclerotia, A Form of, W. B. Brierley, 186
- Bowl, a Remarkable Stone, in the Museo Arqueológico, Madrid, B. G. Corney, 755
- Brachyphalangy, Hereditary, in Man, A New Type, of, O. L. Mohr and C. Wriedt, 464
- Bradford Technical College, H. Richardson appointed Principal of the, 505
- Brain, The Function of the, Dr. T. G. Brown, 123
- Brass, 60-40, Some Properties of, Prof. C. H. Desch, 695
- Brent Valley Bird Sanctuary, The, W. M. Webb, 614; 622
- Bristol University: Forthcoming Award of the Vincent Stuckey Lean Scholarship; Proposed Extensions of the Engineering Faculty, 313; Prof. F. Francis appointed Pro-Vice-Chancellor, 601; Resignation of Prof. F. Francis as Dean of the Faculty of Science; Prof. A. M. Tyndall appointed Dean of the Faculty of Science, and P. Fraser Deputy Dean; Prof. C. Lloyd Morgan appointed Emeritus Professor of Psychology and Ethics; Dr. C. D. Broad appointed Professor of Philosophy, 630
- British: Aeronautics, 561; and Foreign Scientific Apparatus, D. H. Baird, 390; J. W. Ogilvy, 424; J. S. Dunkerly, 425; F. W. Watson Baker, 518; Prof. W. M. Bayliss, 641; and Metric Systems of Weights and Measures, A. S. E. Ackermann, 456; Association, The Sectional Presidents of the Cardiff Meeting of the, 112; Forthcoming Meeting of the, 399; The Cardiff Meeting of the, 524, 780; Subjects for Discussion at the Cardiff Meeting, 626; Bequest to, by T. W. Backhouse, 630; Presidential Address, Prof. W. A. Herdman, 813; Summaries of Addresses of the Presidents of Sections, 825; The Meeting at Cardiff, 830; Astronomical Association, Bequest to, by T. W. Backhouse, 631; Chemical Mission on Chemical Factories in the Occupied Area of Germany, A Summary of the Report of the, 253; Chemists, Central Headquarters for, 607; Cotton Industry Research Association, pending Scientific Appointments by the, 274; Constitution and Methods of the, Dr. A. W. Crossley, 372; First Annual Report of the, 840; Crop Production, Dr. E. J. Russell, 176, 206; Dyes Corporation, Sir Henry Birchenough appointed Chairman of the, 303; East Africa, Profit and Sport in, being a Second Edition, revised and enlarged, of "A Colony in the Making," Capt. the Lord Cranworth, 392; The Development of, 392; Empire, Cotton-Growing in the, Dr. W. Lawrence Balls, 103; Sir George Watt, 104; Exhibition, The Forthcoming, 755; Forestry Conference, The Principal Members of the, Received by the King, 687, 759; Order of the, Promotions and Appointments of the, 144; Sugar Research Association, The, 80; Timber Exhibition, The, 591; India, The Fauna of, including Ceylon and Burma, Coleoptera, Chrysomelidae (Hispaniae and Cassidinae), Prof. S. Maulik, 64; Iron Ores, Prof. H. Louis, 419; Isles and North-West Europe, Practical Exercises on the Weather and Climate of the, W. F. Stacey, 133; The Birds of the, and their Eggs, T. A. Coward, First Series, 132; The Colour Index of the, Prof. F. G. Parsons, and others, 531; *Journal of Experimental Pathology*, No. 1, 82; Lampblown Scientific Glassware Manufacturers' Association, Ltd., History of the Formation of the, D. H. Baird, 496; Motor Cycle and Cycle Car Industry, The Research Association for the, Approved, 526; Ornithology from the Earliest Times to the end of 1918, A Geographical Bibliography of, W. H. Mullens, H. Kirke Swann, and Rev. F. C. R. Jourdain. Part I., 353; Research Association for the Woollen and Worsted Industries. Report of, for 1918-19, 118; Rubber and Tyre Manufacturers, Research Association of, B. D. Porritt appointed Director of Research by the, 170; School of Archaeology in Jerusalem, The Prince of Wales Patron of the, 52; Science Guild, The Forthcoming Annual Meeting of the, 398; Annual Meeting of the, 268; *Journal of the*, June, 657; Sea Fisheries, The, Bromohydrins and Dibromo-derivatives, A. Haller and Mme. Ramart-Lucas, 702
- Brorsen-Metcalf Comet, Photographs of the, Prof. Barnard, 467
- Bruchus rufimanus*, Boh, Distribution, Life-History, and Measures of Control of, R. E. Campbell, 310
- Brussels University, The Medal of Honour Presented to Lord Dawson of Penn, Sir Leslie Mackenzie, and Prof. Sir William Smith, 440
- Buddhism in the Pacific, Sir Henry Howorth, and others, 407
- Buenos Aires, Discovery of Early Remains of Man in, Dr. C. Ameghino, 209; National Museum of Natural History, Dr. C. Ameghino appointed Director of the, 80
- Butter and Cheese, C. W. W. Tisdale and J. Jones, 738
- Buzzard at Home, The, A. Brook, 746
- Buzzards and Bitterns, Canon E. McClure, 105
- Bygone Beliefs: Being a Series of Excursions in the Byways of Thought, H. S. Redgrove, 610
- Cairo, Proposed University at, 731
- Calcium, The Absorption of, by Plant-Roots and its Antitoxic Properties towards Copper, L. Maquenne and E. Demoussy, 91
- Calculus: Differential for Colleges and Secondary Schools, Dr. C. Davison, 65; Elementary, C. H. P. Mayo (with answers), 163
- Calcutta, Report for 1918-19 of the Bureau of Education, 794
- Calendar Reform, A. Philip, C. Flammarion, 22; C. Flammarion, Dr. A. C. D. Crommelin, 105
- Camarasaurus, Cope (Morasaurus, Marsh), Reconstruction of the Skeleton of, H. F. Osborn and C. C. Mook, and Restoration of the Camarasaurus and Life-Model, W. K. Gregory, 667
- Cambrian Horizons of Comley (Shropshire), The, and their Brachiopoda, etc., E. S. Cobbold, 314
- Cambridge University: Girton College, Offer of a Fellowship by, 25; E. V. Appleton appointed an Assistant Demonstrator in Experimental Physics; Proposal to Create a Readership in the Morphology of Vertebrates and a Lectureship in Zoology; New Building Schemes, 56; Prof. H. Lamb, Sir Thomas L. Heath, Prof. W. H. Bragg, and Dr. H. Head elected Honorary Fellows of Trinity College; A. Amedeo appointed University Lecturer in Agriculture, and G. U. Yule re-appointed University Lecturer in Statistics, 88; A Smith's Prize awarded to S. Pollard; Grants from the Gordon-Wigan Fund, 88; Fresh Regulations for the Diplomas in Agriculture and Forestry Drafted, 80; Two Exhibitions Offered by Emmanuel College; Approval of the New Statute Authorising the Degree of Doctor of Philosophy for Research, 120; F. B. Smith appointed Reader in Estate Management, in, 120; G. E. Briggs elected to the Allen Scholarship; The New Ph.D. Statute, 154; Gifts towards the Hopkinsian Professorship in Thermodynamics; The Linacre Lecture to be delivered by Dr. H. Head; Proposed Honorary Degrees, 312; The Sheepshanks Exhibition in Astronomy awarded to E. S. Pearson; Examination for the Diploma in Medical Radiology and Electrology; H. Hamshaw Thomas re-appointed Curator of the Botanical Museum; Bequest by the Hon. Sir Charles A. Smith to Peterhouse, 313; Report of Syndicate on the Relation of Women Students; Sir Geoffrey Butler appointed Secretary of the Board of Research Studies; H. F. Gadow appointed Reader in the Morphology of Vertebrates; Dr. H. Scott Curator in Entomology; G. F. C. Gordon Superintendent of the Engineering Workshops; L. G. P. Thring Superintendent of the Engineering Drawing Office, 345; E. A. Milne appointed Assistant Director of the Solar Physics Observatory; The First M.B. Examination: Relation of Women to the University; The Local Lectures Summer Meeting, 376; Conferment of Honorary Degrees, 409; Prof. I. T. Wilson appointed Professor of Anatomy, 439; Hopkins Prize Awards

- made to Dr. W. Burnside, Prof. G. H. Bryan, and C. T. R. Wilson, 440; Dr. T. G. Adami elected an Honorary Fellow of Christ's College, 440; Offer for the Erection, etc., of a Low-Temperature Station, 440; Gift for a Biochemistry Building, 472; The Gift for the Sir William Dunn School of Biochemistry; Dr. T. G. Adami elected an Honorary Fellow of Jesus College; J. E. Littlewood appointed Cayley Lecturer in Mathematics; J. H. Grace re-appointed University Lecturer in Mathematics, 505; Substitution of Thermodynamics for Elementary Optics in Schedule A of Part II. of the Mathematical Tripos Recommended; Proposed Honorary Degrees; 505; A Course for a Degree in Horticulture, 506; An *ad interim* grant by the Government; Donation Received for Lectures in Tropical Agriculture; Dr. C. A. Barber appointed Lecturer in Tropical Agriculture; Miss B. A. Clough appointed Principal of Newnham College, 537; Dr. Adrian appointed University Lecturer in Physiology; F. A. Potts University Lecturer in Zoology; E. W. Ravenshear awarded the Harkness Scholarship; R. E. Holthum and G. T. Henderson, Frank Smart Prizes, 537; Dr. F. W. Aston elected to a Fellowship in Trinity College; Latin Orations at the Presentation of Sir Joseph Thomson and Sir Joseph Larmor for Honorary Degrees, 568; Bequest by Rev. E. S. Marshall, 601; Dr. S. Scales appointed University Lecturer in Medical Radiology and Electrology; F. Lavington appointed Girdlers' Lecturer in Economics; J. Chadwick elected to the Clerk Maxwell Scholarship in Experimental Physics; H. F. Holden to the Benn W. Levy Research Studentship in Biochemistry; A. J. Beamish to the Wrenbury Scholarship in Economics, 601; Dr. T. M. Lowry appointed Professor of Physical Chemistry, 630; Further Gift by Mr. and Mrs. P. A. Molteno towards the Cost of the Molteno Institute of Parasitology; R. H. Vernon appointed Assistant to the Professor of Chemistry; Impending Conferment of Honorary Degrees, 665; The Balfour Memorial Fund Studentship; The Honorary Degree of Doctor of Law Conferred upon Dr. A. L. Lowell, Prof. J. J. Abel, and Prof. H. Cushing, 730; Prof. S. J. Hickson elected an Honorary Fellow of Downing College; A. J. Berry re-elected to a Fellowship, 761; Presentation to Dr. W. L. H. Duckworth, 794
- Cameron Prize of the University of Edinburgh, The, Awarded to Sir Robert Jones, 622
- Camphor-growing in the British Empire, Prof. P. Carnot, 757
- Canada: and the United States, A Summer Tour (1919) through the Textile Districts of, Prof. A. F. Barker, 780; Arctic, Insects of, 730; Natural History Studies in, 426; Summary Report of the Mines Branch of the Department of Mines of, for the year 1918, 242
- Canadian: Arctic Expedition, 1913-18, Reports on Crustacea, Prof. A. Willey and Dr. C. Juday, 835; Progress, Fifty Years of, E. H. Godfrey, 147; Water-power Development, L. G. Dennis, 311
- Cancer: Effect of Physical Agents on the Resistance of Mice to, J. B. Murphy, 668; Research Fund, The Imperial, 687, 696
- Cane-sugar, The Biochemical Preparation of, starting with Gentianose, Em. Bourquelot and M. Bridel, 666
- Cannibalism, The After-effects of, C. E. Stromeyer, 90
- Canning River Region, The, Northern Alaska, E. de K. Leffingwell, 520
- Canonical Forms, The late E. K. Wakeford, 369
- Canvas-destroying Fungus, J. Ramsbottom; Major W. Broughton-Alcock, 563
- Capella, Prof. F. Schlesinger and Z. Daniel, 183
- Capture Orbits, Prof. L. Becker, 560
- Carbon: Bisulphide for Increasing Durations of Charge, The Ratio of the Absolute Retardations in, M. Pauthenier, 609; Dioxide, Prolonged Action of, on Silicates and Quartz, C. Matignon and Mlle. Marchal, 443; Monoxide in the Air of Mines, Apparatus for the Estimation of Small Quantities of, J. I. Graham, 624; Sub-nitride, New Researches on, C. Moureu and J. C. Bongrand, 411
- Carbonyl Compounds, Latent Polarities of Atoms and Mechanism of Reaction, with Special Reference to, Prof. A. Lapworth, 346
- Carnegie: Corporation of New York, Dr. J. R. Angell elected President of the, 527; Foundation, The, and Teachers' Pensions, 590; Magnetic Observations taken on the, in February and March, 1920, 788; Results of the Magnetic Survey of the Atlantic made by the, J. P. Ault, 520; United Kingdom Trust, Sixth Annual Report of the, 50
- Cass Technical Institute, Sir John, Membership of and Courses at the, Dr. C. A. Keane, 121
- Catalase, The Chemical Kinetics of, E. Yamasaki, 402
- Catalytic: Action at Solid Surfaces, A Study of the, Dr. E. F. Armstrong and T. P. Hilditch, III, and IV., 314; V., Dr. E. F. Armstrong and T. P. Hilditch, 631; Activity of Copper, Part I., W. G. Palmer, 633; Chemical Reactions and the Law of Mass Action, Dr. E. F. Armstrong, 696; Decomposition of Solutions of Hydrogen Peroxide by Colloidal Platinum, A. de G. Rocasolano, 603; of the Fatty Acids by Carbon, J. B. Senderens and J. Aboulenc, 411; Hydration of Nitriles, The, A. Mailhe, 795
- Cattle and the Future of Beef-Production in England, K. J. J. Mackenzie, with a Preface and Chapter by Dr. F. H. A. Marshall, 62
- Cawthron Institute, Appointments at the, 590; Dr. R. J. Tillyard, 603
- Cells, Multinucleate: An Historical Study (1879-1919), R. Beer and Dr. Agnes Arber, 90
- Céllulose Acetate, Studies on, Dr. Fenton and A. J. Berry, 378
- Celt and Slav, Prof. J. D. Prince, 763
- Celts, Flat-based, from Kent, Hampshire, and Dorset, H. Dewey, 153
- Census, The Forthcoming, 707
- Central: Asia, Through Deserts and Oases of, Miss Ella Sykes and Brig.-Gen. Sir Percy Sykes, 330; Australia, The Present Condition of the Aborigines of, E. N. Fallaize, 601
- Cephalopods, Researches on the Posterior Salivary Gland of III., F. Bottazzi, 251
- Cereal Seeds, Dry Heat Treatment of, D. Atanasoff and A. G. Johnson, 310
- Cereals, Estimated Yields of, Throughout the World, 657; The Prospective Yields of, for 1919-20, 147
- Cerebral Cortex, Sensation and the, Dr. H. Head, 363
- Cerions, Experiments in the Breeding of, P. Bartsch, 545
- Ceryl Alcohol and Cerotic Acid from China Wax, A. Gascard, 506
- Ceylon Fungi, Revisions of, Part VI., T. Petch, 20
- Chadwick Public Lectures, Forthcoming, 20
- Chaleur et du Froid, Action de la, sur l'Activité des Etres Vivants, G. Matisse, 161
- Cheddar Caves, Plant-Life in, L. Pendred, 709
- Chemical: Age, Vol. I., 116; Analysis, Quantitative, A Text-book of, Dr. A. C. Cumming and Dr. S. A. Kay, Third Edition, 33; Calculation Tables: For Laboratory Use, Prof. H. L. Wells, Second Edition, 33; Dictionary, Popular, C. T. Kingzett, 227; Engineer, The Training and Functions of the, Lord Moulton, 83; Industry, Society of, The Medal of the, awarded to P. Kestner, 366; Sir William J. Pope elected President of the; The Gold Medal of the, Presented to P. Kestner, 654; Annual Meeting of, 605; Industries of German Rhineland, The, 253; Physiology, The Essentials of, Prof. W. D. Halliburton, Tenth Edition, 192; Research as Applied to Industry, An Impending French Institute for, 722; Notes on, An Account of Certain Conditions which apply to Original Investigation, W. P. Dreaper, Second Edition, 773; Service for India, A. Prof. H. E. Armstrong, 669; Sheet-Lead, D. W. Jones, 605; Society, Proposals for Election of Honorary and Foreign Members, 52; Election of Officers and Council of the, 145; and its New By-laws, 344; Women Made Eligible for Fellowships of the, 432; Text-books, 705; Theory

- and Calculations, Profs. F. J. Wilson and I. M. Heilbron, Second Edition, 805
- Chemistry: Annual Reports on the Progress of, for 1919, Vol. XVI., 708; and its Mysteries: The Story of what Things are Made of, told in Simple Language, C. R. Gibson, 99; Applied, A Practical Handbook for Students of Household Science, and Public Health, Dr. C. K. Tinkler and Helen Masters, Vol. I., 227; Manuals on, 382; Elementary Agricultural, H. Ingle, Third Edition, 773; Practical, for Medical and other Students, Dr. J. E. Myers and J. B. Firth, Second Edition, 705; for Public Health Students, E. G. Jones, 705; for Textile Students, B. North, assisted by N. B. Land, 382; from the Industrial Standpoint, P. C. L. Thorne, 227; French Text-books of, 63; Industrial, New Books on, 227; Institute of, Annual General Meeting of the, 19; Legal, and Scientific Criminal Investigation, A. Lucas, 772; of Coal, The, J. B. Robertson, 382; Organic, A Class-book of, Prof. J. B. Cohen, Vol. II., 195; Physical, Introduction to, Prof. J. Walker, Eighth Edition, 129; Practical, 33; A Course of, for Agricultural Students, Vol. I., L. F. Newman and Prof. H. A. D. Neville, 291; Vol. II., Part I., H. A. D. Neville and L. F. Newman, 33; Leather, A. Harvey, 382; Service, the late Prof. V. B. Lewes and Prof. J. S. S. Brame, Fifth Edition, Sir T. E. Thorpe, 287
- Chemists: British, Central Headquarters for, 697; Industrial, The National Association of, A. B. Searle elected President of, 785; Year Book, 1920, Edited by F. W. Atack, assisted by L. Whinyates, 2 vols., 740
- Child Physiology: The Principles of Ante-Natal and Post-Natal, Pure and Applied, W. M. Feldman, 638
- Children, Physical Efficiency of, Investigation and Standardisation of the, Dr. A. A. Mumford, 26
- Chile and Argentina, Botanical Exploration in, W. B. Turill, 433
- Chimica delle Sostanze Esplosive, Prof. M. Giua, 483
- Chimie: Cours de, à l'usage des Etudiants P.C.N. et S.P.C.N., Prof. R. de Forcrand, Deuxième édition, Tome I., et Tome II., 63; Organique, Notions Fondamentales de, Prof. C. Moureu, Sixième édition, 63
- Chindwin, Upper Burma, Races of the, R. Grant Browne, 281
- Chloride of Bromine, The: Its Combination with Ethylene, M. Delépine and L. Ville, 539
- Chlorine: and Various Vapours, The Action of, upon Plants, P. Guerin nad Ch. Lormand, 59; The Separation of the Isotopes of, D. L. Chapman, 487, 611; Prof. F. Soddy, 516, 642; The Separation of the Element, into Normal Chlorine and Meta-chlorine, and the Positive Electron, Prof. W. D. Harkins, 230; Dr. F. W. Aston, 231; A. F. Core, 582, 677
- Chlorobenzenes, Commercial, Analysis of, by Distillation, F. Bourion, 347
- Chloropiricin: Act Upon Soluble Ferments? Does, G. Bertrand and Mme. Rosenblatt, 690; Action of, Upon Yeast and *Saccharomyces vini*, G. Bertrand and Mme. Rosenblatt, 507; Activity of, Towards the Higher Plants, Conditions which may Modify the, G. Bertrand, 347; Upon Some Bacterial Fermentations, G. Bertrand and Mme. Rosenblatt, 571; Upon the Higher Plants, G. Bertrand, 283; on the Parasites of Wheat and on Rats, A. Piutti, 283
- Chondriome of the Vaucheria, The, G. Mangenot, 571
- Cinchona: Bark, "Grey," Some Recent Samples of, B. F. Howard and O. Chick, 726; Botanical Station, Continued American Lease of the, 19
- Civil: Aviation, Report of the Advisory Committee on, 556; Engineers, Institution of, Awards of the, 303; Election of Officers of the, J. A. Brodie President, 304; List Pensions, Some, 654; Service Estimates for 1920-21, Education and Science in the, 246
- Clark University and Clark College, Resignations of Dr. G. Stanley Hall and Dr. E. C. Sanford; Appointment of Dr. W. W. Atwood as Head of Both Institutions, 602
- Clifton College Scientific Society, 631
- Climate of the Netherlands, 600
- Climatic: Cycles and Evolution, Dr. Griffith Taylor, 728; Cycles and Tree-growth, Prof. Douglass, 502
- Climatology of North-west Russia and France, 119
- Cloud and Sunshine, The Relationship between, J. R. Sutton, 667; Distribution at Aberdeen during the years 1916-18, An Analysis of, G. A. Clarke, 148
- Clouds as Seen from an Aeroplane, Capt. C. K. M. Douglas, 218
- Cluster Pine, The, Dr. M. Grabham, 675
- Clytocosmus, An Undescribed Species of, Skuse (*Tipulidæ*, *Diptera*), Dr. C. P. Alexander, 635
- Coal: Measures in the Central Mansif and at its Edges, The Course of the, L. De Launay, 634; Supplies, Our, The Conservation of, Prof. J. W. Gregory, 108; The Chemistry of, J. B. Robertson, 382; The Oxidation of, M. Godchot, 666
- Coastal Limestones of the Cape Province, W. Wybergh, 689
- Coke-oven: Construction, Modern By-product, W. A. Ward, 695; and Blast-furnace Gases for Heating and Power, The More Economical Utilisation of the, G. W. Henson and S. H. Fowles, 695; Gas, By-products from, Dr. E. W. Smith, 695; for Town Supply, H. E. Wright, 695; Walls, The Corrosion of, W. J. Rees, 695
- Colloid Chemistry, Elementary, Laboratory Manual of, E. Hartschek, 705
- Colloidal: Complexes and Sera, G. Riquoir, 187; Electrolytes, Prof. J. W. McBain, 760; Systems, The Properties of, IV.: Reversible Gelation in Living Protoplasm, Prof. W. M. Bayliss, 26; Therapy, 351
- Colloids: in Health and Disease, The Use of, A. B. Searle, 351; The Filtration of, Dr. W. R. Ormandy, 696; The Physics and Chemistry of, Forthcoming Symposium and Discussion on, 654
- Cologne Post, Anniversary of the, 211
- Colour: and Chemical Constitution, Part XI., J. Moir, 667; Blindness, Card Test for, Dr. F. W. Edridge-Green, 575; Index of the British Isles, The, Prof. F. G. Parsons, and others, 531; Vision, The Theory and Facts of, 575
- Colouring Matters of Plants, 139
- Columbia and Vicinity, Flora of the District of, A. S. Hitchcock and P. C. Standley, 242
- Columbian Tradition, The, on the Discovery of America and of the Part Played Therein by the Astronomer Toscanelli, H. Vignaud, 803
- Combustibles, The Application Value of, E. Damour, 634
- Commercial Parasitism in the Cotton Industry, O. F. Cook, 548
- Compass: The Gyrostatic, S. G. Brown, 44, 77; The Mariner's, 44
- Complex Combinations: A New Series of, the Antimony Oxylodides, A. C. Vournazos, 475
- Compositæ: Ancestral Studies of, 450; The Origin and Development of the, Dr. J. Small, 450
- Concrete, Light, C. Rabut, 91
- Conflict, The Philosophy of, and other Essays in War-time, Havelock Ellis, Second Series, 353
- Congress, Librarian of, Report of the, for the year ending June 30th, 1919, 537
- Congruences with respect to Composite Moduli, Major P. A. MacMahon, 474
- Conic Curves, A New Apparatus for Drawing, A. F. Dufton, 187
- Conjoint Board of Scientific Societies, Report for 1919, 343
- Conquest, August, 756
- Continent, The Heart of a, D. Carruthers, 330
- Continuation Schools and their Relation to Technical Institutes and Colleges, Principal C. L. Clair-Hugh, 728
- Contour Colouring, the Layer System of, Dr. J. G. Bartholomew and, G. G. Chisholm, 328
- Coolidge Tube: The Manufacture of the, Dr. W. D. Coolidge, 625; The Radiator Dental Type of, 758; Its Scientific Applications, Medical and Industrial, H. Pilon translated, 739
- Copper: A Case Favourable to the Action of, on Vegetation, L. Maquenne and E. Demoussy, 634; in Plants, The Presence of, and particularly in food of Vegetable Origin, B. Guérithault, 763

Corallimorphus, The Genus, T. A. Stephenson, 474  
Correlation Coefficient, Partial, in Samples of 30, An Experimental Determination of the Distribution of the, J. W. Bispham, 187

CORRESPONDENCE.

Aerial Navigation and Meteorology, Lt.-Col. E. Gold, 775;  
Prof. E. van Everdingen, 770  
Alligator Pear, The, Dr. M. Grabham, 517  
"All-or-None" in the Auditory Nerve, Dr. W. Perrett, 390  
Almost-Atolls, The Small Islands of, Prof. W. M. Davis, 292  
Antarctic Anticyclone, The, Dr. G. C. Simpson, 777; R. M. Deeley, 808  
Anticyclones, R. M. Deeley, 677  
Anti-Gas Fans, Mrs. Hertha Ayrton, 422, 612, 613; Prof. A. J. Allmand, 452, 612  
Applied Science and Industrial Research, J. W. Williamson, 387, 518; Prof. F. Soddy, 422; Major A. G. Church, 423, 547  
Aquarium Cultures for Biological Teaching, Dr. Monica Taylor, 232  
Army: the New, Science and, Col. E. H. Hills, 103; Prof. L. N. G. Filon, 133; Prof. R. Whiddington, 134; Lt.-Col. E. Gold; Dr. C. S. Myers, 135; Prof. A. R. Richardson, 170; K. E. Edgeworth, 233; C. S. Wright, 391; The Universities and the, Dr. F. J. M. Stratton, 234  
Atomic: and Molecular Forces and Crystal Structure, Dr. A. E. Oxley, 327; and Molecular Structure, On, Dr. A. E. Oxley, 231; Structure, Theories of, I. Langmuir, 261; Weights, The Standard of, Prof. J. R. Partington, 264; Dr. S. Miall, 294  
Atoms, On Langmuir's Theory of, S. C. Bradford, 41; Dr. A. E. Oxley, 105  
Aurora of March 22-23, The, W. B. Housman, 200  
Balloons, Free, The Stretching of Rubber in, Dr. H. P. Stevens; W. H. Dines, 613  
Bees: and the Scarlet-Runner Bean, H. J. Lowe, 742; Eye-Colour in, Prof. T. D. A. Cockerell, 516  
Bohr's Paramagnetic Hydrogen Atom, A Possible Cause for the Diamagnetism of, J. R. Ashworth, 516  
Books, Scientific and Technical, Sir R. A. Gregory, 41  
Brent Valley Bird Sanctuary, The, W. M. Webb, 614  
British: and Foreign Scientific Apparatus, D. H. Baird, 390; J. W. Ogilvy, 424; J. S. Dunkerly, 425; F. W. Watson Baker, 518; Prof. W. M. Bayliss, 641; and Metric Systems of Weights and Measures, M. E. Yeatman, 355; A. S. E. Ackermann, 456  
Buzzards and Bitterns, Rev. Canon E. McClure, 105  
Calendar Reform, C. Flammarion; Dr. A. C. D. Crommelin, 105  
Chemical Service, The Indian, Prof. Jocelyn Thorpe, 324; Sir Prafulla Chandra Ray, 325; Dr. M. W. Travers, 354  
Chlorine: The Separation of the Element, into Normal Chlorine and Meta-Chlorine, and the Positive Electron, Prof. W. T. Harkins; Dr. F. W. Aston, 230; the Isotopes of, The Separation of, D. L. Chapman, 487, 611; Prof. F. Soddy, 516, 642; A. F. Core, 582, 677  
Commercial Parasitism in the Cotton Industry, O. F. Cook, 548  
Contour Colouring, the Layer System of, Dr. J. G. Bartholomew and, G. G. Chisholm, 328  
Cotton: Growing in the British Empire, Dr. W. Lawrence Balls, 103; Sir George Watt, 104; Industry, Commercial Parasitism in the, O. F. Cook, 548  
Cricket, The Mole, F. V. D., 204  
Crystal Structure, Atomic and Molecular Forces and, Dr. A. E. Oxley, 327  
Daylight Saving and the Length of the Working Day, Annie D. Betts, 41  
Decimal Coinage, H. Allcock, 261  
Definite Integrals between Finite Limits, A New Method for Approximate Evaluation of, A. F. Dufton, 354, 455; C. F. Merchant, 422; Commander T. Y. Baker, 486  
Diamagnetism: and the Structure of the Hydrogen Molecule, Dr. A. E. Oxley, 581; of Bohr's Paramagnetic

Hydrogen Atom, A Possible Cause for the, Dr. J. R. Ashworth, 516; of Hydrogen, The, Dr. J. R. Ashworth, 645; Dr. A. E. Oxley, 709  
Doctor of Philosophy in England, The, Dr. H. O. Forbes, 234  
Eiffel Tower Wireless Time-Signals, Prof. R. A. Sampson, 265  
Elements, The Constitution of the, Dr. F. W. Aston, 547  
Ellipse, Perimeter of an, R. A. P. Rogers, 8  
Entomologists, Practical, The Training of, Dr. A. D. Inms, 676  
Eocene Flints, Naturally Fractured, J. Reid Moir, 358  
Equivalence, The Principle of, and the Notion of Force, C. A. Richardson, 72  
Expenses of Scientific Work, Major A. G. Church, 72  
Fellow-Workers, Sir Ronald Ross, 455  
Fireball of February 4, M. L. Dey, W. F. Denning, 105  
Fishery Investigations, International Council for, X. Y. Z., 262; Prof. W. C. McIntosh, 167, 358  
FitzGerald-Lorentz Contraction Theory, The, H. H. Poole, 200  
Fizeau Effect in an Electron Stream, An Attempt to Detect the, Prof. R. Whiddington, 708  
Flying-fish, The Flight of, Dr. J. McNamara, 421; Prof. W. N. F. Woodland, Sir David Wilson-Barker, 455  
Genera and Species, A. Mallock, 675  
Glacial Anticyclone, The Mechanics of the, illustrated by Experiment, Prof. W. H. Hobbs, 644  
Gravitational: Deflection of High-speed Particles, Prof. A. S. Eddington, 37; H. G. Forder, 138; L. Page, 233; Shift of Spectral Lines, Dr. H. Jeffreys, 37  
Halo, A Peculiar, Capt. C. J. P. Cave, 171  
Hawthorn Blossom, Early, Lady Jenny Rose, 234  
High Levels in the Atmosphere, Attainment of, W. H. Dines, 454  
High Rates of Ascent of Pilot Balloons, Dr. W. van Bemmelen, 485; J. S. Dines, 581  
Hydrogen, The Secondary Spectrum of, Prof. J. W. Nicholson, 166  
Hyperbolic Space, Relativity and, Prof. A. McAulay, 808  
Ice, Curious Formation of, A. S. E. Ackermann, 741  
Indian Chemical Service, The, Prof. Jocelyn Thorpe, 324; Sir Prafulla Chandra Ray, 325; Dr. M. W. Travers, 354  
Industrial Research, Scientific Direction of, Major A. G. Church, 40  
Integration, Approximate, and of Computing Areas, Some Methods of, A. S. Percival, 70; Prof. J. B. Dale; R. A. P. Rogers, 138  
Ionisation in the Solar Chromosphere, M. N. Saha, 232  
Isomerism, An Electronic Theory of, Dr. H. S. Allen, 71; W. E. Garner; S. C. Bradford, 171  
Isotopes: The Separation of, Dr. T. R. Merton and Brig.-Gen. H. Hartley, 104; of Chlorine, The Separation of the, D. L. Chapman, 487, 611; Prof. F. Soddy, 516, 642; A. F. Core, 582, 677  
Jupiter, The Great Red Spot on, W. F. Denning, 423  
Kent's Cavern, The Condition of, E. A. Martin, 742  
Knowledge and Power, L. Bairstow, 135; F. O. L., Dr. J. W. Evans, 165  
Laboratory Fittings, The Cost of, A. E. Munby, 294, 456; C. Beck, 355; B. H. Morphy; C. Baker, 356; Bellingham and Stanley, Ltd., W. Taylor; H. W. Ashfield, 357  
Langmuir's Theory of Atoms, On, S. C. Bradford, 41; Dr. A. E. Oxley, 105  
Light: Deflection of, During a Solar Eclipse, J. A. Orange; Dr. A. C. D. Crommelin, 8; the Deflection of, Marat and, Prof. W. A. Osborne, 456  
London University Site and Needs, Sir E. Sharpey Schafer, 484  
Magnetic: Shell, The Construction of a, Equivalent to a given Electric Current, Dr. A. A. Robb, 199; Storm of March 22-23, The, and Associated Phenomena, Dr. C. Chree, 136; Rev. A. L. Cortie, 137; Dr. A. C. Mitchell, 170  
Marat and the Deflection of Light, Prof. W. A. Osborne, 456  
Medical Education, Science in, Prof. S. J. Hickson, 643

- Mercury, Motion of, A Dynamical Specification of the, G. W. Walker, 198
- Meteorological: Conditions of an Ice Cap, R. F. T. Granger, 709; Office, The Position of the, Dr. H. R. Mill, W. W. Bryant, 38
- Migrations in the Sea, The Physiology of, Prof. A. Meek, 197
- Mole Cricket, The, F. V. D., 294
- Mortlakes as a Cause of River Windings, T. S. Ellis, 264; H. Bury, 391
- Moseley Memorial, Sir Henry A. Miers, C. G. Darwin, and Dr. H. Robinson, 200
- Muscular Efficiency, A. Mallock, 197
- Museums and the State, Prof. E. W. MacBride, Prof. J. W. Gregory, 68; Dr. F. A. Bather, Dr. W. E. Hoyle, 69; W. G. Wagner, 70; Sir E. Ray Lankester, 100; Prof. J. Stanley Gardiner, 101; Dr. W. M. Tattersall, 102; F.R.S., 136
- Musk Plants, Loss of Fragrance of, Hon. Col. C. J. Bond, 709
- Officers, Seconding of, for Study at Universities, Prof. J. Wertheimer, 41
- Organisation of Scientific Work, Dr. W. Bateson, J. S. Gamble, Sir Ronald Ross, 6; Dr. E. J. Russell, Prof. A. C. Seward, 7; Sir J. C. Bose, 39; Sir T. H. Middleton, 103; Sir Leonard Rogers, 292; in India, Sir Thomas H. Holland, 452
- Ostrich, A Stalked Parapineal Vesicle in the, Prof. J. E. Duerden, 516
- Ozone in the Atmosphere, Occurrence of, J. N. Pring, 645
- Percussion Figures, Dr. B. G. Escher, 171
- Pilot Balloons, High Rates of Ascent of, Dr. W. van Bemmelen, 485; J. S. Dines, 581
- Pine, The Cluster, Dr. M. Grabham, 675
- Plant Life in Cheddar Caves, L. Pendred, 709
- Plumage Bill, The, and Bird Protection, Sir H. H. Johnston, Prof. H. M. Lefroy, 168; Sir Herbert Maxwell, Prof. A. Dendy, 169; Dr. W. E. Collinge, 196; Prof. J. E. Duerden, 263
- Rainbow Inside Out, A. C. O. Bartrum, 388
- Relativity: and Hyperbolic Space, Prof. A. McAulay, 808; and Reality, Prof. R. A. Sampson, 708
- Royal Military Academy, The, J. Young, 486
- Science: and Scholasticism, Prof. J. J. Walsh, 547; Dr. C. Singer, 548; and the New Army, Col. E. H. Hills, 103; Prof. L. N. G. Filon, 133; Prof. R. Whiddington, 134; Lt.-Col. E. Gold, Dr. C. S. Myers, 135; Prof. A. R. Richardson, 170; K. E. Edgeworth, 233; C. S. Wright, 391; in Medical Education, Prof. S. J. Hickson, 643
- Scientific: and Technical Books, Sir R. A. Gregory, 41; Apparatus from Abroad, Prof. W. M. Bayliss, 293; C. Beck, 355; B. H. Morphy, C. Baker, 356; Bellingham and Stanley, Ltd., W. Taylor, H. W. Ashfield, 357; British and Foreign, D. H. Baird, 390; J. W. Ogilvy, 424; J. S. Dunkerly, 425; F. W. Watson Baker, 518; Prof. W. M. Bayliss, 641; Direction of Industrial Research, Major A. G. Church, 40; Publications, The Cost of, Prof. W. A. Herdman, Prof. H. H. Turner, 326; E. B. Knobel, W. W. Bryant, 327; Prof. G. H. Hardy, Dr. A. B. Rendle, 353; Dr. B. Daydon Jackson, Dr. C. S. Myers, 354; Dr. C. G. Knott, 425; Research, Dr. J. W. Evans, 358; Reunions at the Natural History Museum, Dr. G. F. H. Smith, 72; Work, Expenses of, Major A. G. Church, 72; Its Spirit and Reward, Dr. G. J. Fowler, 387; Organisation of, Dr. W. Bateson, J. S. Gamble, Sir Ronald Ross, 6; Dr. E. J. Russell, Prof. A. C. Seward, 7; Sir J. C. Bose, 39; Sir T. H. Middleton, 103; Sir Leonard Rogers, 292; in India, Sir Thomas H. Holland, 452
- Sea and Sky at Sunset, Lt.-Col. K. E. Edgeworth, J. S. D., 358
- Spectrum, An Experiment on the, Dr. R. A. Houstoun, 421
- Sphexapata (Milogramma) conica*, Note on the Habits of the Tachnid Fly, O. H. Larter, 614
- Spores and Plant Life in Deep Caves, The Carrying Power of, E. A. Stoney, 740
- Summer Lines in Navigation, Use of, Prof. G. C. Comstock, Capt. T. H. Tizard, 742; Dr. J. Ball, 806
- Telephotography, A Note on, A. B., 488
- Temperature Variations at 10,000 ft., C. K. M. Douglas, 614
- Thrush, The First Act of a Young, Honor M. M. Perry-coste, 456
- Trichodynamics, Dr. W. Lawrence Balls, 777
- Universities, The, and the Army, Dr. F. J. M. Stratton, 234
- University: Grants, Sir Michael E. Sadler, 740; Principal C. Grant Robertson, 774; Prof. W. H. Perkin, 805; Stipends and Pensions, Prof. G. W. O. Howe, 582
- Vapour Densities, Calculation of, R. G. Durrant, 742
- Vocal Notes, Seven, Photographs of, Dr. W. Perrett, 39
- Volcanic Rocks in the Anglo-Egyptian Sudan, Dr. G. W. Grabham, 199
- Waage's Photochemical Synthesis of Phloroglucin from Glucose, Dr. M. Nierenstein, 391
- Wasps, W. F. Denning, 328
- Waves, Growth of, A. Mallock, 777
- Weather Forecasts and Meteorology, A. Mallock, 580
- Weights and Measures, British and Metric Systems of, M. E. Yeatman, 355; A. S. E. Ackermann, 456
- Wireless: Station for Astronomy, Central, Major W. J. S. Lockyer, 454; Time-Signals, Eiffel Tower, Prof. R. A. Sampson, 265
- Corrosion Research Committee, Appeal for Funds by the, 304
- Cosmogony, Problems of, and Stellar Dynamics, J. H. Jeans, 31
- Cottage Building, Experimental, 792
- Cotton: Climates of the British Empire suitable for the Cultivation of, C. E. P. Brooks, 338; Egyptian, Researches on, Dr. W. L. Balls, 664
- Cotton Growing: Future Organisation, 793; in South America, Possibilities of, G. McC. McBride, 399; in the British Empire, Dr. W. Lawrence Balls, 103; Sir George Watt, 104; Industry, Commercial Parasitism in the, O. F. Cook, 548; Research, 840; Pests, H. H., 503
- Cotunnite, Anglesite, Leadhillite, and Galena, The Occurrence of, on Fused Lead from the Wreck of the Fireship *Firebrand*, Falmouth Harbour, A. Russell, 156
- Coumarin, *Melettis melissophyllum*, A New Plant containing, P. Guérin and A. Goris, 411
- "Cresinool," T. T. Cocking, 726
- Crete, Excavations in, M. Xanthoudides, 273
- Cricket, The Mole, F. V. D., 294
- Crocker Land Expedition, Mollusca obtained by the, F. C. Baker, 593
- Crookes Radiometer, A Modified Theory of the, G. D. West, 473
- Crop Production, British, Dr. E. J. Russell, 176, 206
- Crystal Structure: Atomic and Molecular Forces and, Dr. A. E. Oxley, 327; Prof. W. L. Bragg, 646
- Cubic Curves, Construction of the Ninth Intersection of two, passing through eight given Coplanar Points, Prof. H. F. Baker, 474
- Cuckoo's Egg, The Story of a, Hilda Terras, 746
- Cumacea and Phyllocarida obtained by the Ingolf and other expeditions, Dr. H. J. Hansen, 81
- Currency Reform and the Need for a Nickel Coinage on a Decimal Basis, 114
- "Cyanogen" Bands, The Origin of the, S. Barratt, 633
- Cylindrical Octosection, On, W. Burnside, 473
- Cyprus: The Agricultural Industries of, W. Bevan, 757; The Handbook of, Eighth Issue, Edited by H. C. Luke and D. J. Jardine, 291
- Cytology: An Introduction to the Study of, Prof. L. Doncaster, 190; English, 190; The Modern Technique of, J. B. Gatenby, 463; with special reference to the Metazoan Nucleus, Prof. W. E. Agar, 482
- Dacca University: P. J. Hartog appointed Vice-Chancellor, 509
- Dante and Trepidation, O. Z. Bianco, 664
- Day Continuation Schools, H. J. Taylor, 23
- Daylight Saving and the Length of the Working Day, Annie D. Betts, 41

DEATHS.

Allen (Sir Charles), 239  
 Backhouse (T. W.), 335  
 Bartholomew (Dr. J. G.), 238  
 Bell (A. J. M.), 721  
 Brashear (Dr. J. A.), 273  
 Brindley (H. S. B.), 208  
 Burrows (Principal R. M.), 364  
 Carnot (A.), 555  
 Chalmers (Dr. A. J.), 271  
 Creak (Capt. E. W.), 178; 300  
 De Candolle (A. P.), 365  
 Doncaster (Prof. L.), 431; 461  
 Drysdale (J. W. W.), 590  
 Eisig (Prof. H.), 50  
 Failes (Rev. W.), 18  
 Fullarton (Dr. J. H.), 365  
 Gayley (J.), 239  
 Gorgas (Major-Gen. W. C.), 590; 620  
 Guthrie (Lord), 302  
 Guyon (Prof. J. C. F.), 721  
 Hall (Maxwell), 302  
 Heenan (H.), 555  
 Herkless (Ppl. Sir John), 495  
 Hewitt (Dr. C. Gordon), 18; 75  
 Hind (Dr. Wheelton), 555  
 Hiorns (A. H.), 335  
 Huntington (Prof. A. K.), 239; 271  
 Hyatt (J. W.), 462  
 Hyslop (Dr. J. H.), 555  
 Inostranetz (Prof. A. A.), 525  
 Kennedy (J.), 555  
 Kinch (Prof. E.), 784  
 Kirkcaldy (J.), 784  
 Lapworth (Prof. C.), 76; 110  
 Leslie (C. D.), 19  
 Lockyer (Sir Norman), 781; 784; 831  
 Loder (Sir Edmund Giles), 301  
 Lyster (A. G.), 143  
 MacArthur (J. S.), 112  
 Maclaurin (Dr. R. C.), 144  
 McClelland (Prof. J. A.), 238  
 Messel (Dr. R.), 270; 270  
 Metcalfe (J.), 273  
 Morant (Sir Robert), 76  
 Moreno (Dr. F. P.), 76  
 Morrison (Dr. G. E.), 431  
 Moses (Prof. A. J.), 365  
 Munro (Dr. R.), 685  
 Nordenfelt (T.), 19  
 O'Shea (Prof. L. T.), 239; 272  
 Palander (Admiral A. L.), 754  
 Perry (Prof. John), 751; 752  
 Pfeffer (Prof. W.), 302  
 Poincaré (L.), 50; 208  
 Pott (J. A.), 334  
 Priest (F. E.), 273  
 Procter (J.), 112  
 Pryor (M. R.), 333  
 Rainbow (W. J.), 208  
 Ramanujan (Prof. S.), 431; 494  
 Rawnsley (Canon H. D.), 430  
 Reynolds (Prof. J. Emerson), 49  
 Rhodes (C. E.), 495  
 Righi (Prof. A.), 462; 753  
 Russell (Sir Thomas W.), 302  
 Rydberg (Prof. J. R.), 525  
 Saccardo (Dr. P. A.), 76  
 Sheldon (W.), 495  
 Starkie (Dr. W. J. M.), 686  
 Stewardson (H. C.), 302  
 Stuart (Sir Thomas P. Anderson), 111  
 Tarleton (Dr. F. A.), 525; 554  
 Taylor (Sedley), 143  
 Timiriazeff (Prof. C. A.), 430  
 Treub (Prof. H.), 208  
 Ussher (W. A. E.), 144  
 Vail (T. N.), 272  
 West (Dr. S. H.), 50  
 Williams (W. R.), 76

Wimmer (Prof. L. F. A.), 365  
 Worsell (W.), 230  
 Decimal Coinage: H. Allcock, 261; Report of the Royal Commission on, 145; 210  
 Definite Integrals: A New Method for Approximate Evaluation of, between Finite Limits, A. F. Dufton, 354, 455; Commander T. Y. Baker, 480; C. F. Merchant, 422  
 Denmark, Plant Culture in, Prof. J. K. Ravn, 761  
 Denning's Comet of 1881 and A Meteoric Shower, 560  
 Dental Cements, The Setting of, Dr. T. M. Lowry and S. Wilding, 217  
 Deutsche Seewarte, Report of the, for 1914-18, 528  
 Devonian of Ferques (Lower Boulonnais), The, J. W. D. Robinson, 314  
 Diabetes, Returns concerning, 723  
 Diallylcyclohexanones, The Constitution of Some, R. Cornubert, 475  
 Diamagnetism and the Structure of the Hydrogen Molecule, Dr. A. E. Oxley, 581; of Bohr's Paramagnetic Hydrogen Atom, A Possible Cause for the, J. R. Ashworth, 516; of Hydrogen, The, J. R. Ashworth, 645; Dr. A. E. Oxley, 709  
 Diamond, Overgrowths on, J. R. Sutton, 507  
 Diatoms on the Skin of Whales, Occurrence of, A. G. Bennett and E. W. Nelson, 633  
 Diazo-compounds: New Catalytic Elements for the Transformation of, A. Korcznski, W. Mrozinski, and W. Vielau, 763; The Chemistry and Technology of the, Dr. J. C. Cain, second edition, 449  
 Dielectric of Commercial Cables, Loss of Energy in the, M. Rennesson, 218  
 Diesel Engine, Marine, The Running and Maintenance of the, J. Lamb, 290  
 Differential Equations: Graphical Treatment of, Dr. S. Brodetsky, 466; Solutions of the Examples in a Treatise on, Prof. A. R. Forsyth, 260  
 Diffraction: Grating, Experiments with a Plane, using Convergent Light, G. F. C. Searle, 224; Image of a Disc, H. Nagaoka, 436  
 Diffusion through a Rubber Membrane, The Process of, H. A. Daynes, 122  
 Digestive Haemoclasis: and Latent Hepatitis, The Proof of, F. Widal, P. Abrami, and N. Iancovsco, 704; in the Study of Hepatic Insufficiency, Proof of, F. Widal, P. Abrami and N. Iancovsco, 762; Hydrolyses by Mechanical Ionisation of Water, J. E. Abelous and J. Aloy, 380  
 Dimethylcyclohexanone, The Constitution of the, obtained by Methylation of the Sodium derivative of  $\alpha$ -Methylcyclohexanone, A. Haller and R. Cornubert, 250  
 Dimetrodon, a Skeleton of, from the Permian of Texas, C. W. Gilmore, 118  
 Dioptric Instruments, Theory of, 542  
 Discovery, The Encouragement of, 189  
 Disease, Radiological Diagnosis of, 4  
 Distillation in Steam, Some Applications of the Method of, Dr. J. Reilly and W. J. Hickinbottom, 379  
 Doctor of Philosophy in England, The, 204; Dr. H. O. Forbes, 234  
 Dogs, Vivisection of, The Bill to Prohibit the, 51; 112  
 Dominion Astrophysical Observatory, Victoria, B.C., Publications of the, Vol. I, No. 1, 658  
 Donnybrook Fair, R. J. Kelly, 433  
 Dove Marine Laboratory, Report of the, 216  
 Drosophila: Genetic Studies of, Prof. L. Doncaster, 405; *melanogaster*, Contributions to the Genetics of, Prof. T. H. Morgan; Dr. C. B. Bridges; A. H. Sturtevant, 405  
 Dublin: Trinity College, Forthcoming Election to a Fellowship in Experimental Physics or Physical Chemistry, 731; University, decision to grant Honorary Degrees to, Dr. W. Crooke, Lord Bryce, Sir Donald MacAlister, Sir Archibald E. Garrod, Prof. W. H. Bragg, and Prof. R. A. Millikan, 80; and Trinity College, Dublin, appointment of a Royal Commission to inquire into the financial resources and working of, 89  
 Duplex Wire-less Telephony, Application of, to Aircraft, Capt. P. P. Eckersley, 154

- Dutch East Indies, Rainfall Records in the, for 1915, 1916, 1917, 368
- Dye Industry : Development of the Synthetic, V. Clay, 686 ; Present State of the, 413
- Dyes, The Manufacture of Intermediate Products for, Dr. J. C. Cain, second edition, 260
- Dynamics : Graphic, Elements of, E. S. Andrews, 65 ; The Fundamental Equations of Dynamics and its Main Co-ordinate Systems Vectorially Treated and Illustrated from Rigid Dynamics, Prof. F. Slate, 65
- Earth : The Absorptive Power of, for Manganese, P. Nottin, 666 ; The Elasticity of the, Earthquake Waves and, Dr. C. G. Knott, 730
- Earthquake Waves and the Elasticity of the Earth, Dr. C. G. Knott, 730
- Earthquakes in Italy in 1896 to 1914, The Frequency of, R. D. Oldham, 186
- Earth's Magnetic Field, The Daily Variations of the, Miss A. van Vleuten, 401
- Earthworks and Retaining Walls, P. M. Crosthwaite, 87 ; A. R. Fulton, 88
- Easter, The Date of, 691
- Easter Island, The Mystery of, the Story of an Expedition, Mrs. Scoresby Routledge, 583
- Eastern Europe : Health Conditions in, Typhus a Serious Menace, Dr. N. White, 723
- Economic : Biologists, Association of, Meeting of the, 170 ; Entomologists, The Education of, Prof. H. Maxwell Lefroy, and others, 503
- Edinburgh University : Sir George Watt to deliver the course of lectures on Indian Forest Trees ; J. Templeton appointed Lecturer in Botany ; Dr. Bella D. MacCallum appointed assistant in the Botany department ; a series of lectures on Aeronautics to be delivered, 120 ; l'Abbé Breuil appointed Munro Lecturer on Prehistoric Archaeology for 1920-21, 121 ; The King to lay the foundation stone of new buildings ; no person not of British nationality and parentage to be appointed professor of German ; Dr. G. L. Malcolm Smith appointed assistant in Clinical Medicine ; J. Anderson appointed Lecturer in Logic and Metaphysics ; Mesozoic fossil plants presented to the Geological Department by Dr. R. Kidston ; loans of forestry exhibits to the Forestry Department, 280 ; E. P. Stebbing appointed Professor of Forestry ; J. P. Dunn a Lecturer in the Department of Music ; bequest by Dr. J. G. Bartholomew, 537 ; Foundation-stone of new buildings laid by the King ; acceptance of the Honorary Degree of LL.D. by the Queen, 601 ; The New Science Buildings of, 627
- Education : and Science in the Civil Service Estimates for 1920-21, 246 ; Act of 1918, Working of the, Marquess of Crewe, 22 ; L.C.C. Draft Scheme, 603 ; A National System of, 345 ; J. C. M. Garnett, 728 ; in the New Era, Prof. F. Soddy, 561 ; Medical, 573 ; Medical Science and, Sir T. Clifford Allbutt, and others, 661 ; National, 213 ; Naval, 445 ; Popular, since the Act of 1870, Miss J. F. Wood, 213 ; The Relationship of, to Research in Aeronautics, 14 ; University and Higher Technical, 509
- Educational Systems, The Evil in Existing, F. W. Sanderson, 561
- Eel Fisheries, Report on, 368
- Egypt : Discovery of a Remarkable Ebony Statue in, Prof. Flinders Petrie, 463 ; the Birds of, Hand-list of, M. J. Nicoll, 674 ; Upper, Personal Ornaments found in, Prof. Flinders Petrie and Dr. Dennison, 210
- Egyptian Cotton, Researches on, Dr. W. L. Balls, 664
- Eiffel Tower Wireless Time-Signals, Prof. R. A. Sampson, 265
- Einstein : Deflection of Light, The, Dr. A. C. D. Crommelin ; Prof. C. V. Raman, 23 ; Displacement of Spectral Lines, The, J. Evershed and C. E. St. John, 244 ; Theory, The, Prof. E. P. Adams, 842 ; The Foundations of, Dr. E. Freundlich, translated by H. L. Brose, 350 ; Relativitv, Prof. A. Eddington, and others, 306
- Elasticity, the Mathematical Theory of, A Treatise on, Prof. A. E. H. Love, third edition, 511
- Electric Charge on Rain, The, Prof. J. A. McClelland and A. Gilmour, 498 ; Conductors, Calculation of, W. T. Taylor, 229 ; Currents in Telephone and Telegraph Conductors, The Propagation of, Prof. J. A. Fleming, third edition, 611 ; Furnace in Great Britain, Recent Developments of the, D. F. Campbell, 695 ; Railway Contact Systems, Sir Philip Dawson, 657
- Electrical and Allied Industries, Education and Training for the, 151 ; Anemometer, A New, E. Rothe, 443 ; Conductivity, Measurement of, in Metals and Alloys at High Temperatures, J. L. Houghton, 602 ; Energy, The Transport of, to great distances, E. Brylinski, 347 ; Engineering and their Application, The Principles of, Prof. G. Kapp, Vol. II., Application, 418 ; Examples in, J. F. Gill and F. J. Teago, 195 ; Oscillations in Water, The Propagation of Sustained, and the Dielectric Constant of Water, M. Sauzin, 763
- Electricity : Applications of, Dr. A. Russell, 418 ; Conduction of, through fused Sodium Hydrate, Dr. A. Fleck and T. Wallace, 602 ; Distribution in France, Maps of the Network of, A. Rateau, 571 ; Its Production and Applications, R. E. Neale, 804
- Electro : -chemical Chlorate, Theory of, and Perchlorate formation, N. V. S. Knibbs and H. Palfreeman, 602 ; deposition of Metals, Uses of the, W. E. Hughes, 339
- Electrolytes, Colloidal, Prof. J. W. McBain, 060
- Electrolytic : Dissociation, Influence of, on the Distillation in Steam of the Volatile Fatty Acids, Dr. J. Reilly and W. J. Hickinbottom, 379 ; Iron, The Annealing of, J. Cournot, 763 ; Resistances, Measurement of, using Alternating Currents, Dr. H. F. Haworth, 602
- Electrometer, An Absolute Bispherical, A. Guillet and M. Aubert, 59
- Electron : Collisions, Effects of, with Atmospheric Neon, Dr. F. Horton and Ann C. Davies, 633 ; Emission from Hot Bodies, The, Sih' Ling Ting, 441
- Electro-therapy, The History of, Dr. W. J. Turrell, 81
- Elements : The Constitution of the, Dr. F. W. Aston, 8, 547 ; The Origin of the, Dr. J. H. Vincent, 842
- Elgie's Weather Book : For the General Reader, J. H. Elgie, 739
- Ellipse, Perimeter of an, R. A. P. Rogers, 8
- Empire Timber Exhibition, The, A. L. Howard, 601
- Employment Psychology : The Application of Scientific Methods to the Selection, Training, and Grading of Employees, Dr. H. C. Link, 673
- Encephalitis i ethargica : Dr. Reece and Dr. MacNalty, 151 ; in Karachi, Capts. Malone and Maitra, 834
- Engineering : Descriptive Geometry and Drawing, Capt. F. W. Bartlett and Prof. T. W. Johnson, 3 Parts, 515 ; Education : Essays for English, selected and edited by Prof. R. P. Baker, 258 ; Naval, Progress in, Vice-Admiral Sir George Goodwin, 235 ; Research in the United States, A. P. M. Fleming, 598 ; Science and, 258
- Engineers, Education of, 152
- English : Magic and Medicine, Early, Dr. C. Singer, 337
- Sedimentary Series, Thickness of, G. W. Lamplugh, 338 ; Skeleton, A Study of the Long Bones of the, Prof. Karl Pearson and Julia Bell. Part I, The Femur. Part I, Section II, The Femur of Man, with special reference to other Primate Femora, 767
- Engrais : Amendements Produits Anticryptogamiques et Insecticides, Dr. E. Demoussy, 738
- Entomological : Conference, The, 502 ; -Meteorological Records of Geological Facts in the Life of British Lepidoptera Major H. C. Gunton, 26
- Entomologists, Practical, The Training of, Dr. A. D. Imms, 676
- Entomology, Economic, in the Philippines, 600
- Eocene Flints, Naturally Fractured, J. Reid Moir, 358
- "Eolith" Factory, A Natural, beneath the Thanet Sand, S. H. Warren, 378
- Equilibrium Constant, The Pressure Variation of, in Dilute Solution, Dr. A. M. Williams, 603
- Equivalence, The Principle of, and the Notion of Force, C. A. Richardson, 72
- b* Eridani, The Binary Star, B. H. Dawson, 84
- Errors, The Balancing of, T. Smith, 122
- Eruption of Katla (Iceland) in 1918, The, A. Lacroix, 314
- Ether : -Air Mixtures, The Self-Ignition of the Causes of,



- the late Prof. McClelland and Rev. H. V. Gill, 634;  
Differential Radiometer, The, W. H. Dines, 570;  
Oxides, The Catalytic Formation of, A. Mailhe and F. de Godon, 27; The Equation of State of, E. Ariès, 314;  
The Critical State of, M. Audant, 634
- Ethylene Sulphide, C<sub>2</sub>H<sub>4</sub>S, M. Delépine, 666
- Eucalyptus Oils, The Manufacture of Thymol, Menthone, and Menthol from, H. G. Smith and A. R. Penfold, 732
- Euclid in Greek. Book I, with introduction and notes, Sir Thomas L. Heath, 288
- Euclid's Elements, 288
- Eugenics, Civics, and Ethics, Sir Charles Walston, 804
- European Thought, Recent Developments in, Essays arranged and edited by F. S. Marvin, 607
- Evelyn, Pepsy, and Swift, Weather Notes of, in Relation to British Climate, Capt C. J. P. Cave, 393
- Evolution, The Method of, Prof. E. W. MacBride, 655
- Exeter University College, Prof. H. J. W. Hetherington appointed Principal of, 280
- Exhibition of Diseases of the Para Rubber Tree, 86
- Expansion caused by Joule's Effect at the Contact of Two Solids, The, J. Fallou, 506
- Exploration of the Sea, International Council for the: Meeting of the, 51, 84; H. G. Maurice elected President of the, 86
- Explosive Sounds, The Velocity of, Prof. D. C. Miller, 842
- Eyam Moor Circle in Derbyshire, Map of the, J. S. Wilson and G. A. Garfitt, 180
- Eye-Colour in Bees, Prof. T. D. A. Cockerell, 518
- Falkland Islands and South Georgia, The Climate and Weather of, C. E. P. Brooks, 275
- Falmouth Observatory, The Weather Experienced at, 656
- Farm Animals, Physiology of, T. B. Wood and Dr. F. H. A. Marshall. Part I, General, Dr. F. H. A. Marshall, 704
- February, The Weather of, 53
- Federation of Science, The, 317
- Feelings, A Natural History of the, 3
- Felichthys felis*, The Ovary of, E. W. Gudger, 279
- Fellow-Workers, Sir Ronald Ross, 455
- Felsted School Scientific Society, Report of the, for 1918 and 1919, 623
- Fertilisers, Artificial, The Manufacture of, Dr. E. J. Russell, 4
- Fertilising Materials, Mining and Manufacture of, and their Relation to Soils, S. L. Lloyd, 4
- Fertility of the Social Classes in England and Wales, The, Dr. T. H. C. Stevenson, 655
- Fertilization, Problems of, Prof. F. R. Lillie, 225
- Ferraris' "Dioptric Instruments": Being an Elementary Exposition of Gauss' Theory and its Applications. Translated by Dr. O. Faber from Prof. F. Lippich's German translation of Prof. G. Ferraris' "The Fundamental Properties of Dioptric Instruments," 542
- Ferrous Industries during the past fifty years, The Progress made in the, Dr. J. E. Stead, 403
- Fevers in the Tropics, Sir Leonard Rogers, Third edition, 33
- Field Glasses, Monocular and Binocular, Report on, E. P. Hyde, P. W. Cobb, H. M. Johnson and W. Weniger, 243; Museum of Natural History, Work of the Botanical Laboratories of the, 408
- Filter Press, Recessed Plate and Plate-and-Frame Types of, E. A. Alliott, 606
- Filtration, Centrifugal, A New Process for, W. J. Gee, 606
- Finland, Standard Time in, H. R. 145
- Finnic Question, The, and Some Baltic Problems, H. Peake, 723
- Fireball: A Bright, 370; of February 4, M. L. Dey; W. F. Denning, 105
- Fisheries, Department of the Ministry of Agriculture and Fisheries, Prof. J. Stanley Gardiner to direct temporarily the scientific work of the, 52
- Fishery: Investigations, Ser. III, Hydrography, Vol. I, The English Channel, Part II; Vol. II, Lightship Observations, Part I; Vol. III, The Atlantic Ocean, Part I, Dr. E. C. Jee, 150; International, 84; Council for, Prof. W. C. McIntosh, 167, 358; X.Y.Z., 262; Recent, 216
- Fishes, Determination of the Age of, by Inspection of the Scales, R. E. Savage, Rosa M. Lee, 275
- Fish-Food in the Limfjord, 1909-1917, P. B. Jensen, 527
- Fishing, "Intensive," Drs. A. C. Johansen and Kirstine, 210
- FitzGerald-Lorentz Contraction Theory, The, H. H. Poole, 200
- Fizeau Effect in an Electron Stream, An Attempt to detect the, Prof. R. Whiddington, 708
- Flame in Complex Gaseous Mixtures, The Propagation of, W. Payman, 279
- Flight at High Altitudes, J. Villey, 346
- Flint Implements, The Earliest, 286
- Flints: Trimming of, in Algeria, M. W. Hilton-Simpson, 81; worked, with finger-grips, Miss Nina F. Layard, 557
- Flora: Land, The Earliest Known, Prof. F. O. Bower, 681, 712; of Jamaica. Vol. IV, Dicotyledons: Families Leguminosae to Callitrichaceae, W. Fawcett and Dr. A. B. Rendle, 738; of the Hawaiian Islands, 217; of the Presidency of Madras, J. S. Gamble, Part III, 36
- Flowers: Wild, Australian, Second Series, photographed by A. E. Sulman, 34; Wild, of New South Wales, A Popular Guide to the, F. Sulman, Vol. II, 34; Wild, Some Familiar, Photographed by A. E. Sulman, 34
- Fluid in Turbulent Motion, The Conditions at the Boundary of a, T. E. Stanton, Miss P. Marshall and Mrs. C. N. Bryant, 441
- Flying: at High Altitudes, The Physiological Aspect of, Dr. Guglielminetti, 401; -fish, The Flight of, Dr. J. McNamara, 421; Prof. W. N. F. Woodland; Sir David Wilson-Barker, 454
- Fogs in the Eastern Sahara, Frequency of, J. Tilho, 571
- Food: Consumption, National, in the United States, Prof. R. Pearl, 507; Inspectors of, Work of, Dr. MacFadden, 151; Its Composition and Preparation, Mary T. Dowd and Jean D. Jameson, 99; Science of, 99; Supplies in Peace and War, Sir R. Henry Raw, 320; Supply, The National, 371; The Nation's, Dr. E. J. Russell, 320; Want of, and the Chemical Composition of Milk, Ch. Porcher, 571
- Foods, Bacteriology and Mycology of, Dr. F. W. Tanner, 99
- Foraminifera from off New Zealand, Recent, J. A. Cushman, 242
- Foreign Decorations, permission to scientific men to wear, 463
- Forest Research, 630
- Forestry: Commercial, in Britain; Its Decline and Revival, E. P. Stebbing, 577; Commission, The, 215; Conference, The British Empire, 759; Tree Diseases, and Timber, 577
- Forests: Our National, A Short Popular Account of the Work of the U.S. Forest Service on the National Forests, Dr. R. H. D. Boerker, 577; Woods, and Trees in Relation to Hygiene, Prof. A. Henry, 158
- Forficula auricularia*, The Food-Plants of, H. H. Brindley, 378
- Formal and Chromium Compounds as Fixing Agents, The Use of Mixtures of, E. Licent, 604
- Formosa: The Flora of the Island of, B. Hayata, 664; The Rainfall in the Island of, 680
- Fossil: -bearing Layer in the Flanders Clay at Watten (Nord), Discovery of a, G. Dubois, 705; Plants: A Textbook for Students of Botany and Geology, Prof. A. C. Seward, Vol. IV, Ginkgoales, Coniferales, Gnetales, 97
- Fossils: from the Miura Peninsula and its Immediate North, Prof. M. Yokoyama, 836; Lower Palaeozoic, The Gray Collection of, to be purchased by the British Museum, (Natural History), 336; Old Age and Extinction in, Dr. W. D. Lang, 212
- Fourth Gospel, The Beginning of the, Prof. P. Haupt, 764
- France, Études sur le Climat de la, Deux. Partie, A. Angot, 110
- Franklin Medals of the Franklin Institute presented to the Hon. Sir Charles A. Parsons and Prof. Svante A. Arrhenius, 432

- Free Balloons, The Stretching of Rubber in, Dr. H. P. Stevens; W. H. Dines, 613
- French Academy of Sciences, Sir James Dewar elected a Corresponding Member of the, 80; Sir Joseph Larmor elected a Corresponding Member of the, 113
- French: Indo-China, The Reorganisation and Extension of the Scientific Services in, A. Chevalier, 401; Text-books of Chemistry, 63
- Fruit Culture, Hardy, The Elements of, 545
- Fruits, Wild, and How to Know Them, Dr. S. C. Johnson, 774
- Fuel: Problems, 609; Production and Utilization, Dr. H. S. Taylor, 609; Research, Prof. J. W. Cobb, 550; The Conservation of, Sir Dugald Clerk, 406; Water, and Gas Analysis for Steam Users, J. B. C. Kershaw. Second edition, 227
- Fumes of Ammonium Chloride in the Electric Field, The Double Refraction and Dichroism of the, S. Procopin, 571
- Functional Relation of One Variable to each of a number of Correlated Variables, G. F. McEwen and E. L. Michael, 82
- Fungal Diseases of the Common Larch, The, W. E. Hiley, 639
- Gabbros of East Sooko, The, H. C. Cooke, 464
- Galactic Condensation, R. T. A. Innes, 759
- Galanthus vivalis*, Inhibition of Invertase in the Sap of, T. G. Mason, 123
- Gammarus chevreuxi*, Experiments with, Dr. E. J. Allen and E. W. Sexton, 368
- Garden, A, in the Dunes, 322
- Gardening and Food Production, Sir Daniel Hall, 371
- Gardens and Allotments, Social and Hygienic Conditions respecting, Sir Daniel Hall, 371
- Gas Cylinders, Tests of, 113
- Gases, The Molecular Energy in, Sir Alfred Ewing, 472
- Gault and Cenomanian Strata, A Mass of, inverted on Lower Greensand, F. L. Kitchin and J. Pringle, 836
- Gelatine Photographic Plates under Tropical Conditions, Working, A. P. Agnew, 182
- v Geminorum, The Duplicity of, Dr. Bernewitz, 340
- Genera: and Species, A. Mallock, 675; The Persistence of, Dr. C. D. Walcott, 680
- Genetic: Segregation, Dr. W. Bateson, 531; Studies of Drosophila, Prof. L. Doncaster, 405
- Geodetic Survey in North America, 141
- Geography: of Asia, A. J. Martin, 35; of Plants, The, Dr. M. E. Hardy, 386; Plea for a Wider Outlook in, Lt.-Col. Sir Francis Younghusband, 465
- Geological: Society, Election of Officers and Council of the, R. D. Oldham, President, 52; Structure, Magnetic Disturbances and, 175; Survey and Museum, Dr. J. S. Flett appointed Director of the, 590; Survey Board, Appointment of a, 209
- Geologie, "Les Grands Enigmes de la, Prof. P. Termier, 503
- Geologische Reichsanstalt*, Vienna, change of name to *Geologische Staatsanstalt*, and changes on the staff, 836
- Geology: of the Mid-Continent Oilfields, Kansas, Oklahoma, and North Texas, Dr. T. O. Bosworth, 608; of the West Indies, The, 24
- Geometry: Complex Elements in, Prof. G. B. Mathews, 736; Differential, The Elementary, of Plane Curves, R. H. Fowler, 321; Relativity and, E. Cunningham, 350; The Analytical, of the Straight Line and the Circle, J. Milne, 65; The Theory of the Imaginary in, together with the Trigonometry of the Imaginary, Prof. J. L. S. Hatton, 736
- Geophysical Observations during the Solar Eclipse of May 20, 1919, Results of, Dr. L. A. Bauer, 842
- Geotropic Response in Roots and Stems, The Chemical Reversal of, Prof. J. Small, 249
- Gerhardt, Charles, Monument to, Sir T. E. Thorpe, 436
- German: Aniline Dye Manufacturers, The German Government and the Combine of the, Dr. H. Lervinstein, 722; Gas Warfare, The French Experience of, M. Florentin, 434; Imperial Chemico-technical Test Laboratory, A Suggested, 785; Rhineland, The Chemical Industries of, 253
- Germany, The Works Council Bill in, 145
- Geum urbanum* x *G. rivale*, The Stability and Fertility of the Hybrid, L. Blaringhem, 475
- Gifford Lectures, Prof. Alexander's, Viscount Haldane, 798
- Gilford Anticyclone, The Mechanics of the, illustrated by Experiment, Prof. W. H. Hobbs, 644
- Glaciation of the South Downs, The, E. A. Martin, 530
- Gland-cells of Internal Secretion in the Spinal Cord of the Skates, C. C. Speidel, 279
- Glasgow: Health Department, Dr. A. K. Chalmers appointed Head of the Enlarged, 19; Royal Technical College, Dr. J. H. Andrew appointed Professor of Metallurgy at the, 249; Work of the, in the War, 410; W. M. Cumming appointed Senior Lecturer in Organic Chemistry at the, 630; R. S. Glennie appointed Chief Lecturer in Pharmaceutics at the, 841; University, Reports on the Hunterian Collections for 1918-19, 146; Conferment of Degrees upon P. A. Hillhouse, D. B. Meek, Dr. J. MacIntyre, and Sir Robert W. Philip; Award of Prizes, 568; Conferment of Degrees, 665; Dr. A. J. Ballantyne appointed Lecturer in Ophthalmology, 761.
- Glass: Industry in the United States, Scientific Research and the, Dr. M. W. Travers, 9; -making, Principles of, 128; Manufacture, Dr. W. Rosenhain, Second Edition, 128; Research Association, The Appointment of a Director of Research to the, F. D. Acland and H. A. L. Fisher, 178; -ware, English Chemical, Wood Bros.' Catalogue of, 435; Scientific, Volumetric Testing of, 120
- Globular Clusters and Spiral Nebulae, The Parallaxes of, K. Lundmark, 215
- Glossina Palpalis*, Bionomics of, Dr. G. D. H. Carpenter, 663
- Gloucestershire, The Ancient Entrenchments and Camps of, E. J. Burrow, 128
- Glucosane, A. Pictet and P. Castan, 795
- Glucose: Action of Hydrocyanic Acid on, Kiliani's Reaction, J. Bougault and J. Perrier, 443; in Plants, The Detection and Characterisation of, by a New Biochemical Method, Em. Bourquelot and M. Bridel, 218
- Glue, Manufacture of, in the Tropics from Tannery Refuse, 690
- Gobies, Our (Gobiidae) from the Egg to the Adult Stages, Prof. C. G. J. Petersen, 527
- Gold: and Pearls in Neolithic Times, The Search for, W. J. Perry, 250; Deposition in the Bendigo Goldfield, The Factors Influencing, Dr. F. L. Stillwell, 465; Its Place in the Economy of Mankind, B. White, 774; Objects, Ancient, Found in an Irish Bog, E. C. R. Armstrong, 527
- Golgi Apparatus, Method for the Demonstration of the, in Nervous and other Tissues, C. Da Fano, 249
- Gonidia, Stages in the Sporulation of, within the Thallus of *Eoerania prunastri*, Ach., R. Paulson, 281
- Graduated Instruments for Volumetric Analysis, Gallenkamp and Co.'s List of, 306
- Grain Pests, The Investigation of, Dr. A. D. Imms, 236
- Grand Fleet, The, 1914-16, Lord Jellicoe, 93
- Graphs, The Use of, in Society and Museum Statistics, H. St. George Gray, 463
- Grasses and Rushes and How to Identify Them, J. H. Crabtree, 805
- Grassland, The Improvement of, Dr. W. E. Brenchley, 408
- Gravitation, Q. Majorana, VI., 251; Q. Majorana, 283; Q. Majorana, IX., 844; Einstein's Theory of, The Foundations of, Dr. E. Freundlich, Translated by H. L. Brose, 350
- Gravitational Deflection of High-speed Particles, Prof. A. S. Eddington, 37; H. G. Forder, 138; L. Page, 233; Shift of Spectral Lines, Dr. H. Jeffreys, 37
- Greek: at Oxford University, Abolition of Compulsory, 17; Science and Philosophy, Dr. C. Singer, 373
- Greenwich: Royal Observatory, Annual Visitation of the, 469; Time or the Nearest Standard Meridian Time for Magnetic Records? Dr. L. A. Bauer, 21

- Groningen Astronomical Laboratory, Publications of the, No. 29, Prof. J. C. Kapteyn, 838
- Ground-squirrels of California, The, J. Grinnell and J. Dixon, 81
- Gunnery, Meteorology in, The Importance of, Dr. E. M. Wedderburn, 492
- Guthrie Lecture of the Physical Society of London, The, Dr. C. E. Guillaume, 438
- Gymnospermic History, 97
- Gypsum, The Fibrous, of Nottinghamshire, W. A. Richardson, 569
- Gyrostal, a Non-spinning, Rotation of, and its Effect in the Aeroplane Compass, G. T. Bennett, 378
- Gyrostatic Compass, The, S. G. Brown, 44, 77
- Hæmoclasic Crisis, The Possibility of Promoting the, by the Intravenous Injection of Portal Blood Collected During the Digestive Period, F. Widal, P. Abrami, and M. N. Lancovesco, 699
- Hailstorm, The Survey, of July 16, 1918, J. E. Clark, 281
- Half-past Twelve: Dinner-hour Studies for the Odd Half-hours, G. W. Gough, 611
- Halo, A Peculiar, Capt. C. J. P. Cave, 171
- Hardwoods of Australia, The, and Their Economics, R. T. Baker, 802
- Hardy Fruit Culture: Practical, R. Staward, 545; The Elements of, 545
- Harmonics in the Neighbourhood of an Assigned Function, T. Levi-Civita, 844
- Hastings Coast-line, The Evolution of the, Miss E. M. Ward, 82
- Hawaiian Islands, Rainfall in the, 181; People, The Religion and Origin of the, Kamagau; S. N. Haleole; Judge Forander; S. H. Ray, 628
- Hawaii, Derivation of the Flora of, Prof. D. H. Campbell, 217
- Hawthorn Blossom, Early, Lady Jenny Rose, 234
- Hayden Memorial Medal of the Academy of Natural Sciences of Philadelphia, The, Awarded to Prof. T. C. Chamberlin, 399
- Hazel-nut, The Supposed Parthenocarpy of the, and its Possible Characters, II., A. Trotter, 251
- Health and the Teacher, 259
- Heat: Economy, Prof. A. Witz, 212; The Theory of, Prof. T. Preston, Third Edition, Edited by J. R. Cotter, 228
- Hejaz, Discoveries in the, Dr. D. G. Hogarth, 528
- Helium: in the British Empire, Sources of, Prof. J. C. McLennan, 725; Its Discovery and Applications, Dr. W. J. S. Lockyer, 360; Its Production and Uses, Prof. J. C. McLennan, 747, 778
- Hereditas*, No. 1., 558
- Hereford Cattle, Colour and Markings of Pedigree, Miss F. Pitt, 211
- Heron of Castle Creek, The, and Other Sketches of Bird Life, A. W. Rees, 514
- Heterophyidæ, A Synopsis of the Trematode Family, Dr. B. H. Ransom, 786
- Hettangian Iron Minerals of Burgundy, The, L. Cayeux, 443
- Hevea brasiliensis*, Structure and Development of the Woody "Burs" or "Nodules" in, G. Bryce, 20
- Hidden Treasure: The Story of a Chore Boy who made the Old Farm Pay, J. T. Simpson, 36
- High Levels in the Atmosphere: The Attainment of, Prof. A. McAulie; Dr. J. G. Coffin, 437; W. H. Dines, 454
- High-voltage Corona in Air, Prof. J. B. Whitehead, 842
- Hill Observatory, Sidmouth, Report of the, 726
- Hindu Drama: The Origin of the, Additional Evidence, Sir W. Ridgeway and Dr. L. D. Barnett, 433
- Hinduism, The Enduring Power of, Sir Valentine Chirol, 834
- Hittite Civilisation, The, Prof. M. Jastrow, jun., 763
- Holopus, a Dried Specimen of, Found in Barbados, Dr. C. T. Trechmann, 757
- Holothurioida of the Coasts of Ireland, Species of, Miss Anne L. Massy, 433
- Honey-bees, Cause of Death of, Mrs. Pixell-Goodrich, 53
- Hong-Kong, Meteorology at, 244; Royal Observatory, Report for 1919 of, 788
- Hood, H.M.S., 182
- Hooker Telescope, The 100-in., Some Tests of, Dr. G. E. Hale, 260
- Hot Filaments, The Thermionic Properties of, Experiments on, Dr. F. L. Hopwood, 473
- House of the Morning," "The, in Egyptian Ritual, Dr. A. M. Blackman, 241
- Huddersfield Technical College, Gift to, by Mrs. M. Blamires, 185
- Human Body, The Engines of the, Prof. A. Keith, 195
- Hurter and Driffield: A Memorial Volume Containing an Account of the Photographic Researches of Ferdinand Hurter and Vero C. Driffield: Being a Reprint of their Published Papers, together with a History of their Early Work and a Bibliography of Later Work on the Same Subject, Edited by W. B. Ferguson, 609; Memorial Lecture, The, Prof. A. Findlay, 689; F. F. Renwick, 689
- Hydrazine, Action of, on the 1:4 Acyclic Diketones, E. E. Blaise, 506
- Hydrazines, The Action of Substituted, upon Acyclic 1:4 Diketones, E. E. Blaise, 666
- Hydrocyanic Acid, The Action of, on Glucose, J. Bougault and J. Perrier, 539; on the Organism of Plants, J. Stoklasa, 539
- Hydro-electric Power Works at the Great Lake, Tasmania, The, 690
- Hydrogen: Molecule, The Structure of the, Diamagnetism and, Dr. A. E. Oxley, 581; Peroxide, The Acceleration of the Decomposition of, by Colloidal Rhodium, C. Zenghelis and B. Papaconstantinos, 443; The Diamagnetism of, Dr. J. R. Ashworth, 645; The Secondary Spectrum of, Prof. J. W. Nicholson, 166
- Hydrographical Studies, Prof. D'Arcy W. Thompson, 150; Surveying, the late Rear-Admiral Sir W. J. L. Wharton, Fourth Edition, Revised and Enlarged by Admiral Sir Mostyn Field, 576
- Hydrolysing Action of Emulsin, Presence in the Melilot and Woodruff of Glucosides Furnishing Coumarin under the, Em. Bourquelot and H. Hérisséy, 634
- Hygiene, Army, and its Lessons, Lieut.-General Sir Thomas Goodwin, 532; for Training Colleges, A Text-book of, Margaret Avery, 259
- Hymenoptera, The Parasitic Aculeate, Prof. W. M. Wheeler, 835
- Hyperbolic Space, Relativity and, Prof. A. McAulay, 808
- Hyperion, The Theory of, Investigations in, Dr. J. Woltjer, jun.; Dr. A. C. D. Crommelin, 675
- Hysteresis Values when Using High Magnetising Forces, The Measurement of, W. L. Cheney, 838
- Iberica*, A New Spanish Scientific Journal, 755
- Ice, Curious Formation of, A. S. E. Ackermann, 741; in Arctic Seas, State of the, 275
- Ignition Points of Liquid Fuels, H. Moore, 245
- Illuminating Engineering Society, Report of the Council of the, 402
- Imitation of Cells, Tissues, Cell-Division, and the Structure of Protoplasm with Calcium Fluosilicate, A. L. Herrera, 635
- Imperial: Air Routes, Major-General Sir Frederic H. Sykes, 359; College of Science and Technology, Provision of Post-Graduate Scholarships at American Universities, 89, 173; Claim of the, to University Status, Lord Morris, and others, 471; The Department of Aeronautics, The Work and Staff of the, 841; Entomological Conference, The Forthcoming, 308, 432, 502; War Museum, The Formation of the, Sir Martin Conway, 626; Wireless Telegraph Committee, Report of the, 504
- India: A Chemical Service for, Prof. H. E. Armstrong, 660; Map-making in, 277; Scientific Work in, The Organisation of, Sir Thomas H. Holland, 452, 565; Sugar Cultivation in, Dr. W. E. Brenchley, 840; Survey of, Report for 1915-16 of the Records of the, 277; The Census of 1921, Consideration of the Prin-

- ciples of, 338; The Linguistic Survey of, Sir George Grierson, 688
- Indian: Beetles, 64; Bauxites, Dr. L. L. Fermor, 212; Chemical Service, The, Prof. Jocelyn Thorpe, 324; Sir Prafulla Chandra Ray, 325; Dr. M. W. Travers, 354; Students in America and Japan, Facilities for, R. K. Sorabji, 377
- Indians North of Mexico, Calendars of the, Miss L. Cope, 75
- Indo-Aryan Vernaculars, The, Sir George Grierson, 557
- Induction Coil, Action of the, Prof. E. T. Jones, 369
- Indus, Brahmaputra, and Ganges, Relations of the, Dr. E. H. Pascoe, 835
- Industrial: Efficiency and Factory Management, Bibliography of, H. G. T. Cannons, 641; Fatigue Research Board, First Annual Report of the, 786; Seventh Report of the, S. Wyatt, 657; Fellowship System for the Promotion of Industrial Research, The, T. L. Humberstone, 665; Peace, The Road to, 55; Psychology, The Present Attitude of Employees to, Mrs. S. Brierley, 400; Research, A. P. M. Fleming, 771; Applied Science and, J. W. Williamson, 387; Prof. F. Soddy, 422; Major A. G. Church, 423; J. W. Williamson, 518; Scientific Direction of, Major A. G. Church, 40; Scientific Research, The Organisation of, Dr. C. E. Kenneth Mees, 771
- Industry, Optical Instruments in, 304
- Influenza: Dr. Carnwath, 151; Epidemic of 1918-19 in Switzerland, The, 400; on Shipboard, Majors McKendrick and Morison, 400; Returns, 274, 367; of the Registrar-General, 557; The Relation of the *Bacillus influenzae* to, Dr. F. G. Blake, 763
- Infra-red Arc Spectra of Seven Elements, The, C. C. Kiess and W. F. Meggers, 726; Spectra of Nebulae, W. H. Wright, 149
- Injurious Insects Observed in Ireland During 1916-18, Prof. G. H. Carpenter, 634
- Insect: Life on Sewage Filters, Dr. W. H. Parkinson and H. D. Bell, 131; Life: Wonders of, Details of the Habits and Structure of Insects, J. H. Crabtree, 651; Pests, Artificial versus Natural Methods of Control of, F. W. Ulrich, and others, 503; Control of, L. Lloyd; E. B. Blakeslee; F. S. Brooks; C. F. C. Beeson, 629; W. J. Phillips, 662; F. C. Bishop and H. P. Wood, 663
- Insects of Arctic Canada, 730
- Institute: of Industrial Administration, Foundation of the, E. T. Elbourne Elected Honorary Secretary, 754; of Metals, The May Lecture of the, 499; of Optics of France, Work at the, A. de Gramont de Guiche, 466
- Institution of Sanitary Engineers, The Gold Medal of the, Presented to Major A. J. Martin, 526
- Integration, Approximate, Some Methods of, and of Computing Areas, A. S. Percival, 70
- Intellectual Stock-taking, 607
- Interference Methods, The Application of, to Astronomical Measurements, A. A. Michelson, 666
- Interferometer, The, in Physical Measurements, 563
- Interferometry, Displacement, by the Aid of the Achromatic Fringes, Prof. C. Barus, 563
- International: Bureau of Weights and Measures at Sèvres, The, 242; Council for Fishery Investigations, Prof. W. C. McIntosh, 167, 358; Federation of University Women, First Conference of the, 662; Fishery Investigations, 84; Research Council: Constitutive Assembly held at Brussels, July 18th to July 28th, 1919, Report of Proceedings, Edited by Sir Arthur Schuster, 543
- Intrusive Rocks of the Dundee District, The, D. Balsillie, 666
- Inulin, The Diastatic Hydrolysis of, H. Colin, 380
- Inventor, Relations of the, to the State, D. Leechman, 366; W. F. Reid, 367
- Invertin in Pure Honey, The Search for, A. Caillas, 218
- Iodic Acid: as a Microchemical Reagent Characteristic of Gaseous Ammonia, G. Denigès, 763; as a Microchemical Reagent for Calcium, Strontium, and Barium, G. Denigès, 379
- Iodine, Sorption of, by Carbon, J. B. Firth, 602
- Iodoamidines, The, J. Bougault and P. Robin, 666
- Ionisation: and Activity of largely Ionised Substances, A. A. Noyes and D. A. MacInnes, 667; in the Solar Chromosphere, M. N. Saha, 232
- Ions, Electrons, and Ionising Radiations, Dr. J. A. Crowther, 740
- Ireland: Department of Agriculture and Technical Instruction, Impending Retirement of T. P. Gill from the Secretaryship of the, 376; The Peat Resources of, Prof. P. F. Purcell, 791
- Irish Eskers, The, Prof. J. W. Gregory, 346
- Iron: and Steel Industry in Lorraine, The Future of the, Prof. H. C. H. Carpenter, 588; and Steel Institute, Annual Meeting of the, 179; Presidential Address to the, Dr. J. E. Stead, 403; Trades during the War, The, M. S. Birkett, 787; Bacteria, Dr. D. Ellis, 323; Cast, The Heat Treatment of, 290; Core of a Transformer or of an Induction Coil, Magnetic Characteristics of the, The Late Prof. B. O. Peirce, 243; -depositing Bacteria, Dr. D. Ellis, 727; and their Geologic Relations, E. C. Harder, 727; Ores of Scotland, The, M. Macgregor, and others, vol. XI, 419; The Deposition of, by Electrolysis, W. E. Hughes, 594
- Ishi, The Medical History of, S. T. Pope, 755
- Isis, and other Periodicals dealing with the History of Science, 241
- Isomerism, An Electric Theory of, Dr. H. S. Allen, 71; W. E. Garner; S. C. Bradford, 171
- Isotopes: and Atomic Weights, Dr. F. W. Aston, 617; The Separation of, Dr. T. R. Merton and Brig-Gen. H. Hartley, 104; of Chlorine, The Separation of the, D. L. Chapman, 487, 611; Prof. F. Soddy, 516, 642; A. F. Core, 582, 677
- Italy, Agriculture in, in Imperial Times, W. E. Heitland, 557
- Jamaica, Flora of, Vol. IV., Dicotyledons: Families Leguminosæ to Callitrichaceæ, W. Fawcett and Dr. A. B. Rendle, 738
- Japan, Effect of Topography on Precipitation in, Prof. Terada, 599
- Japanese Botanical Work, 664
- Java, Long-range Forecasting in, 720
- Jib, a Long Wooden, for a Derrick Crane, 838
- Jupiter: Conjunction of, with Neptune, 213; The Great Red Spot on, W. F. Denning, 423; The Planet, Rev. T. E. R. Phillips, 500
- Just Look! or, How the Children Studied Nature, L. Beatrice Thompson, 651
- K and L Absorption of the Heavy Elements, Calculation of the Limiting Frequencies of, L. de Broglie, 218
- Kalahari, The, and Ovamboland, Prof. E. H. L. Schwarz, 297
- Karoo System, The Reptilian Fauna of the, S. H. Haughton, 837
- Karthala Volcano, An Eruption of the, at Grand Comore in August, 1918, A. Lacroix, 666
- Katharometer, The Theory of the, H. A. Daynes, 122
- Kent's Cavern, The Condition of, E. A. Martin, 742
- Kerr Phenomenon, The Ratio of the Absolute Retardations in the, for Different Wave-lengths in the case of Nitrobenzene, M. Pauthenier, 634
- Ketimines, The, G. Mignonac, 347
- Kew, Royal Botanic Gardens: Bulletin of Miscellaneous Information, 1919, 228; Official Guide to the Museum of British Forestry at the, 211; Question of Guide Lectures at the, Lord Sudeley, 178
- King's Birthday Honours, The, 462
- King's College, London: decision to form an Old Students' Association in connection with, 217; Post-Graduate Courses for Engineers, 313
- Kingsley, Mary, Medals, Award of, 666
- Kitchener, Lord: as a Scientific Worker, 319; Life of, Sir George Arthur, 3 Vols., 319
- Knowledge: and Power, 93; L. Bairstone, 135; F.O.I.: Dr. J. W. Evans, 165; and Understanding, 1
- Kodaikanal Observations of Prominences, J. and Mrs. Evershed, 340

- Kohleth, Book of, commonly known as Ecclesiastes, A Gentle Cynic: Being a Translation of the, stripped of Later Additions; also its Origin, Growth, and Interpretation, Prof. M. Jastrow, Jun., 226
- Krueger 60, The Binary, S. A. Mitchell and C. P. Olivier, 307
- Krypton and Xenon, Notes on, Prof. J. N. Collie, 441
- Kula: The Circulating Exchange of Valuables in the Archipelagos of Eastern New Guinea, Dr. B. Malinowsky, 688
- Kynurenic Acid in the Dog, Mechanism of the Production of, Prof. A. Robinson, 346
- Laboratory Fittings: Scientific Apparatus and, C. Beck, 355; B. H. Morphy; C. Baker, 356; Bellingham and Stanley, Ltd.; W. Taylor; H. W. Ashfield, 357; The Cost of, A. E. Munby, 294, 456
- Lad: A Dog, A. P. Terhune, 484
- Laird, Cammell, and Co., Ltd., The Birkenhead Shipyard and Works of, 560
- Lake: District, The Vulcanicity of the, J. F. N. Green, 242; Geneva, The Theoretical Determination of the Longitudinal Seiches of, Doodson, Carey, and Baldwin, 275
- Laminarine from *Laminaria flexicaulis*, The Study of, Mme. Z. Gruzewska, 187
- Lancashire Sea-Fisheries Laboratory, Report of the, for 1919, 656
- Land: and Water in the North Atlantic Region in Palaeozoic Times, The Distribution of, Dr. Holtehlahl, 212; Land and Water on the Earth, Distribution of, Prof. H. F. Reid, 763; Drainage from the Administrative Point of View, E. M. Konstam, 42; Land Flora, The Earliest Known, Prof. F. O. Bower, 681, 712; from the Engineering Point of View, C. H. J. Clayton, 42; Rainfall and, Dr. Brysson Cunningham, 42; Mollusks of the Belgian Congo, Dr. H. A. Pilsbry, 433
- Langmuir's Theory of Atoms, On: S. C. Bradford, 47; Dr. A. E. Oxley, 105
- Larch, The Common, The Fungal Diseases of, W. E. Hiley, 639
- Latitude, An Easy Method of Finding, N. Liapin, 625
- League of Nations Union, Forthcoming Summer School in connection with the, 280
- Leather Chemistry, Practical, A. Harvey, 382
- Leeds University: W. E. H. Berwick appointed Lecturer in Mathematics in, 56; Dr. H. M. Dawson appointed Professor of Physical Chemistry, 409; Increase in the Scale of Fees, 697; Institution of an Appointment Board, with W. R. Grist as Secretary; G. C. Stewart appointed Assistant Lecturer in Applied Mathematics, 698
- Leonardo da Vinci, E. McCurdy, 307, 340
- Lepidoptera, British, Melanism in, J. W. H. Harrison; Hon. H. Onslow, 278
- "Les Maitres de la Pensée Scientifique," 788
- "Les Océans à travers les âges," Prof. P. Termier, 624
- Lethargic Encephalitis, 785
- Lettuce, The Meiotic Phenomena in the Pollen Mother-Cells and Tapetum of, Dr. R. R. Gates, 186, 756
- Levelling Errors, 400
- Libraries in Indian High Schools, L. T. Watkins, 608
- Life: and Existence, Wisdom of, 226; and Temperature, 161; Movements in Plants, Sir Jagadis Chunder Bose, 416; The Processes of, The Dualistic Conception of, Dr. S. J. Meltzer, 763
- Light: and Plant-Growth, The Relationship between, W. W. Garner and H. A. Allard, 464; Production in Luminous Organisms, The Chemistry of, E. N. Harvey, 270; Scattered by Gases in respect of Polarisation, A Re-examination of the, I. Lord Rayleigh, 631; The Absorption of, by Organic Compounds, 640; Deflection of, during a Solar Eclipse, J. A. Orange; Dr. A. C. D. Crommelin, 8; Marat and, Prof. W. A. Osborne, 456; Destructive Effect of, on Textiles, etc., M. Entat, 758; Filters for Visual Work with the Microscope, Kodak Ltd., 435; The Einstein Deflection of, Dr. A. C. D. Crommelin; Prof. C. V. Raman, 23
- Lighting: Conditions in Mines, with special reference to the Eyesight of Miners, Dr. T. L. Llewellyn, and others, 21; of Picture-Galleries and Museums, The, H. Seager, 723
- Lightning Discharges, Investigations on, and on the Electric Field of Thunderstorms, C. T. R. Wilson, 377
- Lime and Magnesia carried down by Precipitates of Ferric Oxide, The, M. Toporescu, 475
- Linné, Carl von, Movement to Restore the Botanic Garden and House of, 591
- Linnean Society: Election of Officers and Council of the, 496; Profs. G. Bonnier, V. F. Brotherus, G. B. de Toni, L. Dollo, P. Marchal, and R. Thaxter elected Foreign Members of the, 366; The Financial Position and Outlook of the, 80; The Gold Medal of the, Presented to Sir Ray Lankester, 526
- Linnean Society of N.S.W., Presidential Address to the, J. J. Fletcher, 724
- Liquid: Cylinders, Rotating, C. R. U. Savoour, 379; Fuels, Ignition Points of, H. Moore, 245; Mercury, The Thermo-Electricity of, Verification of, M. Gouineau, 634
- Liquids at High Pressure, Viscosities and Compressibilities of, J. H. Hyde, 57
- Lister: Lord, Proposals for Commemorating the Work of, 654; Institute of Preventive Medicine, Establishment at the, of a National Collection of Type Cultures, 590
- Liverpool: School of Tropical Medicine, Inception and History of the, 785; Opening of the Sir Alfred Jones Laboratories of the; Award of Mary Kingsley Medals, 606; University, Appeal for Funds, 121; Contribution by the King to the Appeal Fund, 601; Gift to the Appeal Fund by the Pacific Steam Navigation Co., 762; Gift to, by the Cunard Steamship Co., 313, 762; Gift by T. Harrison Hughes, 345; Dr. C. Walker appointed Associate-Professor in Cytology and Lecturer in Histology; J. Wemyss Anderson appointed Professor of Engineering Refrigeration, Gifts to the Appeal Fund, 376; Conferment of Honorary Degrees, 440; Resolution of the Senate on the Death of Prof. L. Doncaster, 472; T. R. Wilton appointed Lecturer in Dock and Harbour Engineering, 505; Dr. W. J. Dakin appointed Professor of Zoology; Dr. I. M. Heilbron Professor of Organic Chemistry, 537; Dr. W. Mason appointed Professor of Engineering (Strength of Materials); C. O. Bannister Professor of Metallurgy, and W. H. Gilmour Professor of Dental Surgery, 630; The Title of Emeritus Professor of Engineering conferred upon Prof. H. S. Hele Shaw, 841
- Local Colleges and Adult Education, Principal L. Small, 728
- Local Government Board, The Origin and Growth of the Medical Department of the, Sir George Newman, 151; Forty-eighth Annual Report of the, 151
- Long-range Forecasting in Java, 720
- London: County Council, Compulsory Day Continuation Schools, Forthcoming Appointment of Principals of, 280; Draft Scheme, The, The Education Act, 1918, 693; Degrees in Commerce, Dr. Russell Wells, 440; School of Economics, The Foundation-Stone of the New Wing of the, Laid by the King, 440; University, Appointment of Fellows of University College; The Degree of D.Sc. conferred on W. Rees, 25; Gifts to, by the Sir Ernest Cassel Educational Trust; Dr. J. McIntosh appointed Professor of Pathology at the Middlesex Hospital Medical School; Dr. S. Russ appointed Professor of Physics at the Middlesex Hospital Medical School, 25; Appeal for a War Memorial, 57; W. Neilson-Jones appointed Professor of Botany at Bedford College; Posts in connection with the Sir Ernest Cassel Benefactions; Various Gifts; Conferment of Doctorates; Award of Keddey Fletcher-Warr Studentships to Dr. Agnes Arber and Miss Margaret McFarlane; Annual Report of University College, 155; Forthcoming Public Lectures, 312; Courses of Advanced Lectures, 376; The University of, A Great Opportunity, 381; Government Offer of a Site, H. A. L. Fisher, 404; The Degree of D.Sc. conferred on B. C. Laws; Report

- of the Principal Officer for 1919-20, 409; Site and Needs, Sir E. Sharpey Schafer, 484; and the British Museum, Chance of Increased Co-operation between, 528; Dr. S. Russell Wells re-elected Vice-Chancellor; Acceptance of the Rockefeller Gift; Appointments; Grants from the Dixon Fund, 568; The Degree of Bachelor of Science in Household and Social Science to be Instituted, 569; Resolution re the Proposed Site for, 569; E. Barker appointed Principal of King's College, 630; Mr. Fisher on King's College, 665; V. H. Mottram appointed Professor of Physiology at King's College for Women Household and Social Science Department; Dr. W. S. Lazarus-Barlow appointed Professor of Experimental Pathology at Middlesex Hospital Medical School; Dr. J. C. Drummond appointed University Reader in Physiological Chemistry at University College, 698; Conferment of Doctorates; The Proposed Site; Appointments at King's College, 698; University College, Opening of the New Buildings of the Department of Applied Statistics, 470
- Longitude by Wireless Telegraphy, Prof. R. A. Sampson, 370
- Lorraine, The Future of the Iron and Steel Industry in, Prof. H. C. H. Carpenter, 588
- Louth: Disastrous Flood at, 432; The Thunderstorms of May 20, and the, 468; The Flood at, 504
- Lower Carboniferous Chert-formations of Derbyshire, The, H. C. Sargent, 58
- Lower Palæozoic Rocks of the Arthog-Dolgelley District, The, Prof. A. H. Cox and A. K. Wells, 123
- Lubricants, Solid, Memorandum on, T. C. Thomsen, 372
- Lubricating Oils, Methods of Examining, Plea for Uniformity in, G. F. Robertshaw, 339
- Lubrication, The Theory and Practice of, Wells and Southcombe, 21
- Luciani, Prof. L., Life and Work of the late, Sig. Baglioni, 844
- Luck, or Cunning, as the Main Means of Organic Modification? An Attempt to Throw Additional Light upon Darwin's Theory of Natural Selection, S. Butler, second edition, 773
- Lunar: Eclipse, The, 307; Parallax, The and Related Constants, Prof. W. de Sitter, 529; Tides, The Effects of, on the Earth's Atmosphere, Prof. S. Chapman, 506
- McGill University: Resignation of the Principalship of, Sir Auckland C. Geddes, 17; Dr. L. V. King appointed Macdonald Professor of Physics at the Macdonald Physics Building of, 721
- Macgregor, The Dr. Jessie, Prize for Medical Science, Forthcoming Award of, 377
- Machine Drawing, A Text-book on, for Electrical Engineers, E. Blythe, 260
- Mackinder's "World Island" and its American "Satellite," C. R. Dryer, 624
- Madras, Flora of the Presidency of, J. S. Gamble, part iii., 36
- Madrid Observatory, Annual of the, for 1920, 213
- Magnet Steel, Bars of, The Testing of, Dr. N. W. MacLachlan, 122
- Magnetic: Declination, Simultaneous Values of, at Different British Stations, Dr. C. Chree, 632; Disturbances and Geological Structure, 175; Disturbances in Northamptonshire and Leicestershire, A Report on, and their Relations to the Geological Structure, Dr. A. H. Cox, 175; Induction in the Soft Iron Compass Correctors under the Influence of the Needles, L. Dunover, 539; Shell Equivalent to a Given Electric Current, The Construction of a, Dr. A. A. Robb, 109; Storm of March 4-5, Dr. C. Chree, 56; of March 22-23, The, and Associated Phenomena, Dr. C. Chree, 136; Rev. A. L. Corbie, 137; and Associated Phenomena, Dr. A. Crichton Mitchell, 170
- Magnetism: and Electricity, Intermediate Text-book of, R. W. Hutchinson, 515; Notes on, for the Use of Students of Electrical Engineering, C. G. Lamb, 193; The Decay of, in Bar Magnets, Prof. W. Brown, 123
- Magnets, Permanent, in Theory and Practice, S. Evershed, 435
- Malaya, Food Production in, F. G. Spring and J. N. Milsum, 180
- Malleable Cast Iron, S. J. Parsons. Second edition, 290
- Mammalia, Tongues of the, Comparative Anatomy of the, Dr. C. F. Sonntag, 218
- Mammalian Remains from Cuba and Porto Rico, H. E. Anthony, 757
- Man: Past and Present Prof. A. H. Keane. Revised, and largely re-written, by Mrs. A. H. Quiggin and Dr. A. C. Haddon; Prof. G. Elliot Smith, 255; The Ascent of, 708; The Asiatic Origin of, W. B. Wright, 728
- Manchester: College of Technology, Work of the, in the War, 410; Resignation of, J. C. M. Garnett of the Principalship of the, 630; Literary and Philosophical Society, Sir Henry A. Miers re-elected President of the, 303; J. H. Lester elected Chairman of the Chemical Section of the, 335; University, Grant from the Carnegie United Kingdom Trust for the Foundation and Maintenance of a Library for Deaf Education, 155; Developments at, 278; The Appeal Fund of, 313; Gift by the King to the Appeal Fund, 630; J. Higham appointed Lecturer in Physics and Electrical Engineering, 698
- Manganese Ores, A. H. Curtis, 193
- Manures: Soils and A Student's Book on, Dr. E. J. Russell. Second edition, 130; and, in New Zealand, L. J. Wild, 130
- Maori Daggers, Two Wooden, Sir W. Ridgeway, 274
- Map-making in India, 277
- Maps, New Ordnance Survey, Lt.-Col. W. J. Johnston, 312
- Marat and the Deflection of Light, Prof. W. A. Osborne, 456
- Marine: Algæ as Food for the Horse, Lapique and Brocq-Rousseau, 635; Biological Association, Annual General Meeting of the, Sir E. Ray Lankester re-elected President, 303; Biological Structures and Functions, 279; Deposits, The Transfer of, from the Sea-floor to the Surface of Glacier Ice, F. Debenham, 724; Diesel Engine, The Running and Maintenance of the, J. Lamb, 290
- Mariner's Compass, The, 44
- Marlborough College Natural History Society, Report for 1919, 337
- Marriages between Hindus of Different Castes, Bill to Make Valid, 241
- Mars: and Wireless Signals, 276; Conjunction of, with Spica, 340; Different Phenomena Observed on the Planet, R. Jarry-Desloges, 603
- Martres d'Artières (Puy-de-Dôme), The Geyser of, Ph. Glangeaud, 315
- Mason-Wasps, The, J. H. Fabre. Translated by A. T. de Mattos, 291
- Maternity and Child Welfare, Dr. Wheaton, 151
- Mathematical: Books and Pamphlets, Gift of, to the South African Public Library, Cape Town, by Sir Thomas Muir, 305; Cosmogony, 31; Text-books, Recent, 162
- Mathematician as Anatomist, The, Prof. A. Keith, 767
- Mathematics: Critical, 256; for Collegiate Students of Agriculture and General Science, Prof. A. M. Kenyon and Prof. W. V. Lovitt. Revised edition, R. A. Fisher, 31; for Engineers, part ii., W. N. Rose, 260; of Elasticity, 511; Pure and Applied, Dr. S. Brodetsky, 65; Unified, Prof. L. C. Karpinski, H. Y. Benedict, and J. W. Calhoun, 162
- Mathématique, Les Principes de l'Analyse, Exposé Historique et Critique, Prof. P. Bourtroux. Tome second, 256
- Matrices and Determinoids, Prof. C. E. Cullis, vol. ii., 191
- Matter, Some Wonders of, Rt. Rev. Dr. J. E. Mercer, 67
- Maulund Klausensuche, Neue Beobachtungen über den Erreger der: Die Entwicklung des Schmarotzers im Blut, speziell in den roten Blutkörperchen, Dr. H. Stauffacher, 100
- Mean Values, Equivalence of Different, A. Kienast, 474

- Meat and Milk in the Food Supply of the Nation, Report on, 400
- Mechanical: Engineers, Institution of, Researches under the Direction of the, 53; Reduction Gears, Use of, between the Turbines and the Propeller in the Royal Navy, Eng.-Comdr. H. B. Tostevin, 148
- Mechanics, School, part i., School Statics, W. G. Borchardt, 163
- Medical: Discovery, Awards for, Visit of a Deputation of the British Medical Association and the British Science Guild on, to Mr. Balfour, 18; Education, 573; Science in, Prof. S. J. Hickson, 643; Research, Prof. G. Elliot Smith, 605; and the Practitioner, 541; Committee, The Work of the, 43; The Work of the, Sir Walter Fletcher, 400; The Promotion of, 221; Science and Education, Sir T. Clifford Allbutt, and others, 661; Women, Admission of Qualified, to the Fellowship of the Royal College of Surgeons of Edinburgh, 51
- Medicine, Medieval, Prof. J. J. Walsh, 127; Poetry and, Prof. D'Arcy W. Thompson, 414
- Mediterranean Oceanography, A Project for Systematic Exploration in, 113
- Melanism in British Lepidoptera, J. W. H. Harrison, Hon. H. Onslow, 278
- Meliola and Irene, The haustoria of the Genera, Miss Ethel M. Doidge, 667
- Melissic Alcohol of Brodie, The, A. Gascard, 314
- Memories, Lord Fisher, 95
- Memory: and Conation, Miss Edgell, 603; Unconscious, S. Butler. Third edition, 774
- Mensuration for Marine and Mechanical Engineers (Second- and First-class Board of Trade Examinations), J. W. Angles, 163
- Mercuric Salts, Precipitation of, by Sulphuretted Hydrogen, P. Jolibois and P. Bouvier, 603
- Mercury: Arc, A New Alternating, H. Georges, 91; as an Evening Star, 529; Conjunction of, with  $\epsilon$  Geminorum, A. Burnet, 370; the Motion of, A Dynamical Specification of, G. W. Walker, 108; Vapour, Low-voltage Ionisation Phenomena in, K. H. Kingdon, 632
- Metabolism of Boys from One to Thirteen Years of Age, The, Basal, F. G. Benedict, 667
- Metal-foil Surfaces in Rarefied Gases, The Forces Acting on Heated, G. D. West, 122
- Metals: Heat Conductivities of, S. Konno, 181; Institute of, The Autumn Meeting of the, to be Held at Barrow-in-Furness, 366; The Journal of the, vol. xxii., No. 2, 1919. Edited by G. Shaw Scott, 164; Minerals and, 193; Spectrographic Detection of, especially Zinc, in Animal Organisms, A. de Gramont, 411; The Elastic Properties and the Plastic Extension of, Prof. W. E. Daiby, 377; The Mineralogy of the Rarer, A Handbook for Prospectors, E. Cahen and W. O. Wootton. Second edition, revised by E. Cahen, 259
- Meteor Shower, The April, 276
- Meteoritic Iron of Mount Ayliff, Griqualand East, The, Dr. G. T. Prior, 156
- Meteorite, An Interesting, G. P. Merrill, 759
- Meteorological: Conditions of an Ice-cap, R. F. T. Granger, 709; Conference, International, Work of the Paris Meeting of the, 180; Influences of the Sun and the Atlantic, Prof. J. W. Gregory, 715; Instruments, C. F. Casella and Co.'s Catalogue of, 20; Magazine, The, 83; Observations in Netherlands East India, 1917, 758; at St. Xavier's College, Calcutta, Rev. E. Francotte, 55; Office, The Position of the, W. W. Bryant, 38; Dr. H. R. Mill, 38; Resolution of the Scottish Meteorological Society on, 87; Impending Retirement of Sir Napier Shaw from the Directorship of the, 144; Dr. G. C. Simpson appointed Director of the, 721; Variations, Short-period, Dr. E. van Rijckevorsel, 761
- Météorologie, Manuel Pratique de, J. Rouch, 451
- Meteorology, Aerial Navigation and, Prof. E. van Everdingen, 617, 776; Lt.-Col. E. Gold, 775; at Hong-Kong, 244; for All: Being some Weather Problems Explained, D. W. Horner, 323; in Gunnery, The Importance of, Dr. E. M. Wedderburn, 492; of the Temperate Zone, The, and the General Atmospheric Circulation, Prof. V. Bjerknes, 522; Weather Forecasts and, A. Mallock, 580
- Meteors: April, 149; Bright, 54; Great Perseid Shower of, Commencement of the, 595
- Methods, Dr. J. McK. Cattell, 795
- Methwold, Norfolk, The National Demonstration Farm at, 179
- Methyl: Chloride and Bromide, The Preparation of, starting from Dimethyl Sulphate, Ch. Boulin and L. J. Simon, 218; Esters, Combustion of, with a Mixture of Sulphuric and Chromic Acids, J. Guyot and L. J. Simon, 187
- Methylcyclohexanone, The Constitution of the, prepared by the Ethylation of  $\alpha$ -Methylcyclohexanone, A. Haller and R. Cornubert, 379
- Metric Literature Clues, 179
- Mica Industry, The, in Eastern Transvaal, A. L. Hall, 787
- Mice, Spotting in, Sô and Imai, 400
- Micro-organisms, The Projection of, into the Air, A. Trillat and M. Mallein, 475
- Microscopic Illumination, Dr. H. Hartridge, 275
- Microscopy, Quantitative, The Lycopodium Method of, T. E. Wallis, 249
- Microtome, A Universal, Sir Horace Darwin and W. G. Collins, 570
- Middle Cambrian Beds at Manuels, Newfoundland, The, and their Relations, B. F. Howell, jun., 843
- Middlesex Hospital, Reorganisation and Co-operation of Research Departments of the, 240
- Migrations in the Sea, The Physiology of, Prof. A. Meek, 196
- Military Hygiene, Gen. Sir John Goodwin, 114
- Milk: and Apthous Fever, C. Porcher, 699; and Haemolysis, H. Violle, 411; Problem, The Modern, in Sanitation, Economics, and Agriculture, J. S. MacNutt, 385; Production of Ayrshire Cattle, Prof. R. Pearl and J. R. Miner, 245; The Problem of Clean and Safe, Prof. S. Delépine, 385; The Story of, J. D. Frederiksen, 229
- Mind Training, Technical Education and, E. L. Rhead, 439
- Mineralogical Abstracts, part i., 147
- Mineralogy of the Rarer Metals, The, A Handbook for Prospectors, E. Cahen and W. O. Wootton. Second edition, revised by E. Cahen, 259
- Minerals: and Metals, 193; from Monte Somma and Vesuvius, Prof. G. Cesàro, 464
- Mines in the Pas-de-Calais District, and the Method of Working Them, G. S. Rice, 688
- Models Illustrating the Atomic Arrangement in Potassium Chloride, etc., W. Barlow, 570
- Mole Cricket, The, F. V. D., 294
- Molecular Energy in Gases, The, Sir Alfred Ewing, 472
- Mollusca Obtained by the Crocker Land Expedition, Dr. W. H. Dall, 688
- Monarch: The Big Bear of Tallac, E. Thompson Seton, 450
- Monkey, The Antiscorbutic Requirements of the, Drs. A. Harden and S. S. Silva, 499
- Monoclinic Double Selenates of the Copper Group, Dr. A. E. H. Tutton, 538
- Monsoon Rainfall in 1920. The Probable Amount of, Dr. G. T. Walker, 1920, 724
- Montefiore, Fondation George, Prize, 834
- Montgomery, Mary Louisa Prentice, Lectureship in Ophthalmology, Prof. G. Elliot Smith elected to the, 240
- Moon: Eclipse of the, 276; Photograph of the, F. G. Pease, 267
- Morocco, Some Results of a New Journey in, A. Brives, 475
- Mortlakes as a Cause of River-windings, T. S. Ellis, 264; H. Bury, 391
- Moseley Memorial, Sir Henry A. Miers, C. G. Darwin, Dr. H. Robinson, 200
- Motion: High-speed, Langrangian Methods for, C. G. Darwin, 379; Study and the Manual Worker, 737; for the Handicapped, F. B. and Dr. L. M. Gilbreth, 737
- Motor Fuels, Mixtures for Use as, Dr. W. R. Ormandy, 211
- Mounting of Wet Specimens under Watch-glasses and Petri Dishes, L. Renouf, 689
- Mowra Flowers, Suggested Use of, for the Manufacture of Alcohol, 147
- Murchison, Charles, Scholarship in Clinical Medicine, of the Royal College of Physicians of London, The, 280

- Muscle, The Thermo-elastic Properties of, A. V. Hill and W. Hartree, 537
- Muscular Efficiency, A. Mallock, 107
- Museums: and Art Galleries, The Lightning of, H. Seeger, 627; and the Advanced Student, Report on, 463; and the State, Prof. E. W. MacBride; Prof. J. W. Gregory, 68; Dr. F. A. Bather; Dr. W. E. Hoyle, 69; W. G. Wagner, 70; Sir E. Ray Lankester; Prof. J. Stanley Gardiner, 101; Dr. W. M. Tattersall, 102; F.R.S., 136; Association, Annual Conference, 626; National, The State and the, 29; The Proposed Transfer of, to the Local Education Authorities, Dr. F. A. Bather and Sir A. Selby-Bigge, 114
- Music, The Foundations of, Dr. H. J. Watt, 98
- Musical: Scale, The, J. Goold, 666; Sound, The Nature of, 98
- Musings of an Idle Man, Sir R. H. Firth, 100
- Musk Plants, Loss of Fragrance of, Hon. Col. C. J. Bond, 709
- Mussels, Fresh-water, Correlation of Shape and Station in, Dr. A. E. Ortmann, 843
- Mysticism, True and False, Dr. W. F. Geikie-Cobb, 633
- Myzus ribis*, Linn., Preliminary Note on Antennal Variation in, Miss Maud D. Haviland, 378
- Nascent State, A New View of the, C. Zenghelis, 330
- National: Education, 213; Food Consumption in the United States, Prof. R. Pearl, 597; Food Supply, The, 371; Illumination Committee of Great Britain, Major K. Edgcombe elected Chairman of the, 557; Institute of Agricultural Botany, W. H. Parker appointed Director of the, 335; Museum of Wales, Dr. R. E. M. Wheeler appointed Keeper of the Department of Archaeology, and Lecturer in Archaeology in the University College of South Wales and Monmouthshire, 569; Physical Laboratory, Annual Visitation of the, 595; Report for 1919 of the, 725; Physique, A Survey of, 202; Research Council, Relation of Psychology to the, Dr. J. R. Angell, 796; Prof. V. Kellogg, 332; Union of Scientific Workers, Progress of the, 53
- Native Tribes of Western Australia, The, 248
- Natural: History, Misinformation and Misconception concerning, Dr. R. C. Smith, 146; Museum Pamphlets (Economic Series), New Editions of, 787; Presentation to, by Sir Henry Howorth of a Collection of Mammalian, and other Remains, 209; Staff Association, Scientific Reunion of the, 52; History, Popular, 651; Studies in Canada, 426; Knowledge, An Inquiry concerning the Principles of, Prof. A. N. Whitehead, 446; Wealth of Britain, The, Its Origin and Exploitation, S. J. Duly, 579
- Naturalist, The Book of a, W. H. Hudson, 651
- Nature: Hour, Stories for the, Compiled by Ada M. and Eleanor L. Skinner, 804; Pictures, Twenty-four, E. J. Detmold, 352; -study of Plants, The, in Theory and Practice for the Hobby-botanist, T. A. Dymes, 804
- Nature, The Jubilee of, Congratulations upon, from the Nova Scotian Institute of Science, 113
- Nautical Almanac for 1922, The, 22
- Naval: Education, 445; Engineering, Progress in, Vice-Admiral Sir George Goodwin, 235; Research and Experiment, 245
- Navy Estimates, A Vote for Scientific Services under the, 366
- Nebulae: Faint, E. P. Hubble, 84; Recent Researches on, H. D. Curtis, and others; Major W. J. S. Lockyer, 489
- Nela Research Laboratory, The, 834
- Neolithic "Floor" in the Neighbourhood of Ipswich, An Early, J. Reid Moir, 527
- Neon and Helium, Moving Striations in, Dr. F. W. Aston and T. Kikuchi, 633
- Neptune, Conjunction of Jupiter with, 213
- Nesting Feathers of Birds, The, Prof. J. C. Ewart, 250
- Netherlands, Climate of the, 600
- Neuropteroid Insects of the Hot Springs Region, New Zealand, The, in relation to the Problem of Trout-food, Dr. R. J. Tillyard, 667
- New Caledonia, The Botany of, R. H. Compton, 122
- New Zealand: Institute, The, 24; Fellowship of the, 88; Plants and their Story, Dr. L. Cockayne, Second edition, 707; Soils and Manures in, L. J. Wild, 130; The Limestone Resources of, P. G. Morgan, 465
- Newcastle-upon-Tyne, Electric Supply Co., Development of the Generating Stations of the, J. S. Watson, 360
- Newtonian Fields in the Neighbourhood of a given Vectorial Field, O. Onicescu, 843
- Nickel: Iron Alloys: The Anomaly of the, its Causes and its Applications, Dr. C. E. Guillaume, 438; -Steels, Expansion of the, Action of Metallurgical Additions on the Anomaly of, Ch. Ed. Guillaume, 571; Standard, Values of the Expansions of, Ch. Ed. Guillaume, 634; The Thermal Change of the Elastic Properties of, P. C. Chevenard, 603; Wire, The Change in the Rigidity of, with Magnetic Fields, Prof. W. Brown and P. O'Callaghan, 634
- Night: Raid into Space, A, The Story of the Heavens told in Simple Words, Col. J. S. F. Mackenzie, 100; Sky Recorder, A, Royal Observatory, Greenwich, 281
- Nile: Basin, Physiography of the, Dr. P. Chalmers Mitchell, 113; Gauges, Report upon the, for 1913-1918, H. E. Hurst, 275; Proposals for the Development of the Cultivable Area of the Valley of the, Opposition to the, 837
- Nitriles: by Catalysis, A New Method of Formation of, A. Mailhe, 283; The Catalytic Hydrogenation of, G. Mignonac, 699
- Nitrodichloroacetanilide, Crystalline Forms of, M. De Angelis, 844
- Nitrogen: of the Cyanic Group in Manures, R. Perotti, 844; Products Committee, Final Report, 201; Problem, The: By-products, 201
- Nitro-phenols, Ultra-violet Spectrophotometry of the, F. Vles, 475
- Nitrosophenylhydroxylamine (Cupferon), The Salts of, V. Auger, 379
- Nitrotoluidine, Some Derivatives of, A. G. G. Leonard and Agnes Browne, 634
- Noctiluca: Prof. C. A. Kofoid, 433; Pleurobrachia and Beroë, A Swarm of, in the Barrow Channel, A. Scott, 656
- Noon Reflector, A, Prof. C. V. Boys, 117
- Norfolk and Norwich Naturalists' Society, Transactions of the, vol. x., part 5, 115
- North: America, Geodetic Survey in, 141; Atlantic Ocean, Meteorological Office Chart of the, February, 181; Stray Mines in the, Prince Albert de Monaco, 282; -East Ireland, An Analysis of the Palaeozoic Floor of, with Predictions as to Concealed Coalfields, W. B. Wright, 368; Wales, A Handbook to the Vertebrate Fauna of, H. E. Forrest, 386
- Northern: Fur-seal, Present Position of the, Dr. Evermann, 623; Polytechnic Institute, Re-establishment of the School of Rubber Technology at the, under the Directorship of Dr. P. Shidrowitz, 731
- Nototherium: Skeleton Found in Tasmania of the, 559; H. H. Scott and C. Lord, 593
- Nottingham, University College, Gift by Sir Jesse Boot, 665
- Nova: Aquilae, The Expanding Disc of, Dr. J. Lunt, 595; in Cygnus, Discovery of a, W. F. Denning, 838; in a, Spiral Nebula, Prof. Wolf, 213
- Nuclear Constitution of Atoms, Sir Ernest Rutherford, 500
- Nucleus, The Structure of the, 482
- Nudity in India in Custom and Ritual, Dr. W. Crooke, 723
- Obligation, Autonomy, and the Common Good, C. C. J. Webb, 249
- Occultism, The Prevalence of, E. Clodd, 432
- Oceanography and the Sea-fisheries, Prof. W. A. Herdman, 813
- Officers: Seconding of, for Study at Universities, Prof. J. Wertheimer, 41; Training Corps, The, and the Universities, 349
- Oil: and Colour Chemists' Association, Dr. R. S. Morrell elected President of the, 527; -engine Cycles, Claim as a Pioneer Inventor of, H. Akroyd Stuart, 499



- Oils, Commercial, Vegetable and Animal. With Special Reference to Oriental Oils, I. F. Laucks, 132
- Okefinokee Swamp, Georgia, F. Harper, 593
- Oligochaeta from the Lesser-known Parts of India and from Eastern Persia, Prof. Stephenson, 656
- Optical: Instruments in Industry, 394; Projection, Lewis Wright. Fifth edition, re-written and brought up to date by R. S. Wright. (In two parts.) Part I., The Projection of Lantern Slides, 773
- Optics and Mechanics of Precision, Review of, March and April, 725
- Optophone: The, Dr. E. E. Fournier d'Albe, 295; of Dr. E. E. Fournier d'Albe and Prof. A. Barr, 722
- Ordnance Survey Maps, New, Lt.-Col. W. J. Johnston, 312
- Organic Compounds: Magnetic Properties of, Major A. E. Oxley, 243; The Identification of, the late Dr. G. B. Neave and Prof. I. M. Heilbron. Second edition, 774
- Organisation of Scientific Work: Dr. W. Bateson; J. S. Gamble; Sir Ronald Ross, 6; Dr. E. J. Russell; Prof. A. C. Seward, 7; Sir Leonard Rogers, 292
- Ornithological Notes from Norfolk, J. H. Gurney, 81
- Oshima, A Study of, S. Tsuboi, 787
- Ostrich: A Stalked Parapineal Vesicle in the, Prof. J. E. Duerden, 516; Study in South Africa, Prof. J. E. Duerden, 106
- Ovamboland, The Kalahari and, Prof. E. H. L. Schwarz, 297
- Ovum, The Fertilisation of the, 225
- Oxford University: Abolition of Compulsory Greek at, 17; Sir Archibald E. Garrod appointed Regius Professor of Medicine in, 25; Prof. R. A. Sampson appointed Hailey Lecturer for 1920, 56, 227; Dean Inge to deliver the Romanes Lecture on "The Idea of Progress," 155; Acceptance of Offer from E. Whitley towards the Endowment of a Professorship of Biochemistry; Donation towards the Extension of the Organic Chemical Laboratory from the British Dyestuffs Corporation, 313; Conferment of the Honorary Degree of Doctor of Letters upon Prof. T. Zammit; Dr. T. R. Merton granted the title of Professor, 440; Dr. B. Moore appointed Professor of Biochemistry; Gift by W. Morrison to the Bodleian Library, 731
- Oxidation by Air of Ferriferous Compounds, The Catalytic Action of Copper Salts on the, L. Maquenne and E. Demoussy, 699
- Oxides: Alloys of, Mlle. S. Veil, 347; of Nitrogen, Improvements relating to the Commercial Production of, in Arc Furnaces, F. Gros, 283
- Ozone in the Atmosphere, Occurrence of, J. N. Pring, 645
- Palaogeography, A Study in, Prof. A. C. Seward, 223
- Palaolithic Flint Implements found in the River Gravels of the South of England, J. Reid Moir, 146
- Palestine, Establishment of a Department of Antiquities for, 785
- "Panchromatism," Second Edition, 306
- Panorpid Complex, The, Additions to Part 3, Dr. R. J. Tillyard, 667
- Pan-Pacific Scientific Congress, Forthcoming, 398
- Paper-Making and its Machinery, R. W. Sindall, 480; Including Chapters on the Tub-sizing of Paper, the Coating and Finishing of Art Paper, and the Coating of Photographic Paper, T. W. Chalmers, 480
- Parallax Work at the Sproul Observatory, Dr. Miller, 500
- Parallaxes of Globular Clusters and Spiral Nebulae, K. Lundmark, 215
- Para Rubber-Tree, Diseases of the, Exhibition of, 86
- Paris Academy of Sciences, Prof. A. Fowler elected a Corresponding Member of the, 52
- Pastimes for the Nature Lover, Dr. S. C. Johnson, 774
- Peat Resources of Ireland, The, Prof. P. F. Purcell, 791
- Pellagra amongst Armenian Refugees at Port Said, R. S. White, 592
- Pelletierine and Methylpelletierine, G. Tanret, 442
- Peltori-Wheel Construction, P. Pitman, 625
- Pencil Writing, Early, Characteristics of Pigments in, C. Ainsworth Mitchell, 12
- Pensions, University Stipends and, 477
- Peps, Evelyn and Swift, Weather Notes of, in Relation to British Climate, Capt. C. J. P. Cave, 393
- Percussion-Figures, Dr. B. G. Escher, 171
- Periodicity in Weather and Crops, Sir William Beveridge, 379
- Periwinkle, Life-History of the, Dr. W. M. Tattersall, 373
- Petrographical Notes on Rocks from Deception Island and Roberts Island, etc., H. H. Thomas, 282
- Petroleum: Geology, H. B. Milner, 608; Industry, Economics of the, R. S. Dickie, 369
- Petrological Microscope, A New Model Rotating-Stage, W. A. Richardson, 570
- Petrology for Students: An Introduction to the Study of Rocks under the Microscope, Dr. A. Harker, Fifth Edition, 99
- Pharmacodynamic Experiences, Sub-epidermic, M. Ascoli and A. Fagioli, II., III., 844
- Pharmacology, Practical, Prof. W. E. Dixon, 420
- Pharmacy, Science and, Progress in, C. A. Hill, 659
- Phenological Observations for the Year 1919, J. E. Clark and H. B. Adames, 442
- Phenylpropines, The, Lespieau and Garreau, 699
- Phylæ, Decipherment of the Bilingual Inscriptions at, Dr. W. Max Müller, 592
- Philippine: Hawksbill Turtle, Need of Protection of the, E. H. Taylor, 756; Plants, New or Noteworthy, E. D. Merrill, 146; Wasp Studies, Part I., S. A. Rohwer; Part II., F. X. Williams, 600
- Philippines: Palms of the, Dr. O. Beccari, 180; Peoples of the, Prof. A. L. Kroeber, 420
- Philosophies, Sir Ronald Ross, 414
- Philosophy, A Forthcoming Congress of, 654
- Photochimie, Etudes de, Dr. V. Henri, 640
- Photographic: Almanac, The British Journal, and Photographer's Daily Companion, 1920, Edited by G. E. Brown, 67; Developing Agents, Dr. Seyewetz, 182; Images, The Nature of, Dr. C. E. Kenneth Mees, 307
- Photography: Aircraft, in the Service of Science, H. Hamshaw Thomas, 457; and its Applications, W. Gamble, 740
- Photosynthesis: in Fresh-Water Algæ, Prof. B. Moore and T. A. Webster, 26; in the Green Leaf, The Beginning of, G. E. Briggs, 89; The Photoplasmic Factor in, Dr. F. F. Blackman, 89
- Physical: Chemistry, 129; Examination of Men of Military Age by National Service Medical Boards from November 1, 1917-October 31, 1918, Report upon the, 202; Fitness, The Assessment of, New Aspects in, Dr. F. G. Hobson, 812; Nature-Study, A Field and Laboratory Guide in, Prof. E. R. Downing, 675; Progress, Indices of, Dr. Lempriere, 26
- Physico-chemical Analysis: A Method of, of Commercial Chlorobenzenes, F. Bourion, 379; Application of a New Method of, to the Study of Double Salts, D. Dubrisay, 634
- Physics: Elementary, Selected Studies in, A Handbook for the Wireless Student and Amateur, E. Blake, 739; for Junior Technical Schools, A First Year, G. W. Farmer, 229; Institute of, Foundation of the, Sir Richard Glazebrook elected First President, 304; Measurements, A Handbook of, E. S. Ferry, O. W. Silvey, G. W. Sharman, Jun., and D. C. Duncan, 2 Vols, 193; Some Applications of, to War Problems, 237; The Ultimate Data of, Prof. G. Dawes Hicks, 446; Theoretical and Practical, 193
- Physiological Symbiosis, Prof. Pierantoni, 756
- Physiology: and National Needs, Edited by Prof. W. D. Halliburton, 286; of Farm Animals, 704; Useful, 286
- Pigments in Early Pencil Writing, Characteristics of, C. Ainsworth Mitchell, 12
- Pilot: -balloon Ascents, Methods of Computation for, J. S. Dines, 837; Balloons, High Rates of Ascent of, Dr. W. van Bammelen, 485; Soundings with, in the Isles of Scilly, Capt. Cave and J. S. Dines, 663; The Rate of Ascent of, J. S. Dines, 581
- Pitlood Remains, The, P. T. de Chardin, 593
- Pine, The Cluster, Dr. M. Grabham, 675
- "Pink Disease" in the Philippines, H. A. Lee and H. S. Yates, 115

- Planet GM, The New Minor, C. Sola, 595  
Planetary Families of Comets, The, Prof. H. N. Russell, 467  
Plant: -cell, Structure of the, and its Metabolism, P. A. Dangeard, 251; The Binucleate Phase in the, Dr. Agnes Arber, 90; Culture in Denmark, Prof. J. K. Ravn, 761; -forms, The Changes in, obtained experimentally, G. Bonnier, 539; Pests in the British Empire, Legislation in regard to, C. P. Lounsbury, 502; Protection Institute, Organisation in the U.S.A. of a, 687  
Plants: Colouring Matters of, 139; Experiments with J. B. Philip, 805; Movements in, Experiments on, Sir Jagadis Chunder Bose, 305; Movements of, 416; Researches on Growth of, Sir Jagadis Chunder Bose, 615, 648; Resistance of, to Insect Attacks, H. A. Ballou, and others, 503; The Apparent "Growth" of, (and of Inanimate Materials), and of the Apparent "Contractility," Dr. A. D. Waller, 410; The Geography of, Dr. M. E. Hardy, 386  
Platana of the Cape Peninsula, The, C. L. Herman, 700  
Plating with Nickel of Aluminium and its Alloys, The, L. Guillet and M. Gasnier, 475  
Plato's Atlantis in Palaeogeography, W. D. Matthew, 667  
Pleasure-Unpleasure: An Experimental Investigation on the Feeling-Elements, Dr. A. Wohlgemuth, 3  
Pleistocene Glaciation of England, Some Features of the, G. W. Lamplugh, 58  
Pliocene: Floras, A Comparative Review of, based on the Study of Fossil Seeds, Mrs. Eleanor M. Reid, 249; River, a Great, on the South Side of the Himalayas, Dr. G. E. Pilgrim, 836  
Plumage: Bill, The, and Bird Protection, Sir H. H. Johnston; Prof. H. M. Lefroy, 168; Sir Herbert Maxwell; Prof. A. Dendy, 169; Dr. W. E. Collinge, 196; Prof. J. E. Duerden, 269; "Talked Out," 303; (Prohibition) Bill, Importation of, Second Reading Carried, 366  
Plumbiferous Barytes from Shibukuro, Japan, Prof. R. Ohashi, 569  
Poetry and Medicine, Prof. D'Arcy W. Thompson, 414  
*Pocillopora cespitosa* and *Seriatopora subulata*, The Development of, A. Krempf, 380  
Poles of Metallic Arcs, The Pressure upon the, including Alloys and Composite Arcs, W. G. Duffield, T. H. Burnham, and A. A. Davis, 121  
Polynesian Origins, A New Theory of, Prof. R. B. Dixon, 763  
Polysaccharides, The Hydrolysis of the, E. Hildt, 603  
Pomology: Scientific and Systematic, 629; The Journal of, Nos. 1 and 2, 629  
Population and Parenthood, Problems of (Being the Second Report of, and the Chief Evidence taken by, the National Birth-rate Commission, 1918-20), 543  
Porcelain, etc., Measurements of the Expansion of Samples of, W. H. Souder and P. Hidnert, 181  
Port Erin Biological Station, The, 179  
Porto Rico: Scientific Survey of, and the Virgin Islands, N. L. Britton and C. P. Berkey, 147; The Earthquake at, on October 11, 1918, Prof. H. F. Reid and S. Taber, 276; The Geological History of, E. T. Hodge, 593; The Shells of, Miss C. J. Mawry, 593  
Potassium, Influence of, on the Physiological Characters of *Sterigmatocystis nigra*, M. Moilliard, 347  
Powders, The Properties of, Dr. T. M. Lowry and F. C. Hemmings, 217  
Power: Knowledge and, 93; L. Bairstow, 135; F.O.I., Dr. J. W. Evans, 165  
Precipitation in Japan, Effect of Topography on, Prof. Terada, 599  
Pre-Glacial Floras, Two, from Castle Eden (Co. Durham), Mrs. Eleanor M. Reid, 249  
Prehistoric: Man and Racial Characters, 153; Relationship of the Various Periods of, to the Great Ice Age, Prof. J. E. Marr, 153; Villages, Castles, and Towers of South-Western Colorado, J. W. Fewkes, 367  
Pre-Palaeolithic Man, J. Reid Moir, 289  
Pressure on the Electrical Resistance and Thermo-electric Properties of Metals, Effects of, Dr. P. W. Bridgman, 529  
*Priapulius humanus* taken by the Canadian Arctic Expedition, 1913-18, R. V. Chamberlin, 786  
Primitive Functions, L. Tonelli, 251  
*Primula officinalis*, etc., in the West of France, The Comparative Geographical Distribution of, Ad. Davy de Virville, 411  
Privy Council, Sir T. Clifford Allbutt to be Sworn a Member of the, 590  
Producer-Gas Plant for Power and Heating, Operating a By-product, W. H. Patchell, 148  
Progress! Sir E. Ray Lankester, 733; The Idea of, Dean Inge, 431; An Inquiry into its Origin and Growth, Prof. J. B. Bury, 733  
Prominences, Observations of, J. and Mrs. Evershed, 340  
Proper Motions, Search for, by the Blink Method, R. T. A. Innes, 759  
Protein Requirement of Maintenance in Man, The, H. C. Sherman, 668  
Proteins: The, 257; The Physical Chemistry of the, Prof. T. B. Robertson, 257  
Protoplasm, The Components and Colloidal Behaviour of, Dr. D. T. MacDougal, 795  
Psychological Tests in Industry, 673  
Psychologies, Sir Ronald Ross, 414  
Psychology: Applied, A Laboratory of, 305; from the Standpoint of a Behaviorist, Prof. J. B. Watson, 512; New Conceptions of, 363; of the Future, The ("L'Avenir des Sciences Psychiques"), E. Boirac; Translated and Edited with an Introduction by W. de Kerlor, 323; Social, An Introduction to, Dr. W. McDougal, Fourteenth Edition, 291; The New, and its Relation to Life, A. G. Tansley, 770; Vocational, A Laboratory of, 210  
Psychotherapy, The Theoretic Basis of, 770  
Public Health and Welfare, 151  
Pulmonary Lesions determined by Blistering Compounds, A. Mayer, Guisysse, Plantefol, and Fauré-Fremiet, 604  
Pygmies of Central Africa, The, H. Lang, 367  
Pygmy Races of Man, The, L. R. Sullivan, 367  
Pyruvic Acid, New Observations on the Biochemical Production of, A. Fernbach and M. Schoen, 251  
  
Qualitative Analysis in Theory and Practice, Prof. P. W. Robertson and D. H. Burleigh, 705  
Queensland Ironbark, A New Species of, R. H. Cambage, 732  
Quintic Transformations and Singular Invariants, W. E. H. Berwick, 474  
  
Rabbit, The, deprived of its Cæcal Appendix, regenerates this Organ by differentiation of the Extremity of the Cæcum, P. Portier, 347  
Radio: Call Signal, A New, Major Shaughnessy, 690; -Diagnosis of Pleuro-Pulmonary Affections, E. Barjon, Translated by Dr. J. A. Honeil, 4; Research Board, O. F. Brown appointed Technical Officer to the, 463; Sub-Committees to assist the, 754  
Radium: Facts, 435; for Curative Purposes, Reduction in the number of White Corpuscles in those handling, Mottram and Clarke, 400; Le, Interpretation et Enseignement de la Radioactivité, Prof. F. Soddy, Traduit de l'Anglais par A. Lepape, 805  
Railways, Electrification of, Appointment of a Committee on the, 113  
Rainbow Inside Out, A, C. O. Bartrum, 388  
Rainfall and Land Drainage, Dr. Brysson Cunningham, 42  
Ramsay Memorial Fellowships, Forthcoming Award of, 249  
Rats: Destruction of, by Chloropicrin, G. Bertrand and M. Brocq-Rousseu, 27; Repressive Measures against, M. A. C. Hinton, 750  
Rayleigh, The Late Lord, The Memorial to, 687  
Rays, Tracing, through an Optical System, T. Smith, 473  
Reactions started by a Primer, Some, E. Berger, 603  
Reading, The Proposed University of, 88  
Real Variables, The Commutativity of One-parameter Transformations in, A. C. Lunn, 667

- Reduction of Error by Linear Compounding, W. F. Shepard, 632
- Reflex Action produced by the Irritation of the deeper Respiratory Tracts, A. Mayer, H. Magne, and L. Plantefol, 507
- Refraction: and Dispersion of Carbon Dioxide, Carbon Monoxide, and Methane, C. and Maude Cuthbertson, 58; of Air for Wave-lengths, Measurements of the Index of, W. F. Meggers and C. G. Peters, 53
- Regional Association, and the Civic Education League, Proposed Meeting of the, 376
- Relativity: and Geometry, E. Cunningham, 350; and Hyperbolic Space, Prof. A. McAulay, 808; and Reality, Prof. R. A. Sampson, 708; Theory of Gravitation, The Central Differential Equation in the, Prof. A. R. Forsyth, 186
- Religion and Culture: A Critical Survey of Methods of Approach to Religious Phenomena, Dr. F. Schleiter, 451
- Reminiscences, H. Keeping, 624
- "Renal Portal" System (Renal Venous Meshwork) and Kidney Excretion in Vertebrata, The, Prof. W. N. F. Woodland, 410
- Renilla, The Phosphorescence of, Prof. G. H. Parker, 843
- Research: Association for the Silk Industry, The, Approved, 591; for the Cutlery Industry, The, Approved, 623; Associations, Remuneration and Superannuation of Scientific Workers employed by, J. W. Williamson, 372; Defence Society, Annual Meeting of the, 557, 785; The Nature, Scope, and Difficulties of, Dr. W. L. Balls, 497
- Respiration, Prof. W. J. V. Osterhout, 795
- Respiratory: Endurance, The Index of, J. Amar, 59; Passages, The Reflexes provoked by Irritation of the, A. Mayer, H. Magne, and L. Plantefol, 443

REVIEWS AND OUR BOOKSHELF.

**Agriculture and Horticulture:**

- Benson (O. H.), and G. H. Betts, Agriculture and the Farming Business, 35
- Buller (Prof. A. H. R.), Essays on Wheat, 224
- Frederiksen (J. D.), The Story of Milk, 229
- Hall (Sir A. D.), The Soil: An Introduction to the Scientific Study of the Growth of Crops. Third edition, 384
- Hedrick (U. P.), Manual of American Grape-growing, 674
- Lloyd (S. L.), Mining and Manufacture of Fertilising Materials, and their Relation to Soils, 4
- Mackenzie (K. J. J.), with a preface and chapter by Dr. F. H. A. Marshall, Cattle and the Future of Beef-production in England, 62
- Newman (L. F.), and Prof. H. A. D. Neville, A Course of Practical Chemistry for Agricultural Students, Vol. 1., 291
- Rew (Sir R. Henry), Food Supplies in Peace and War, 320
- Russell (Dr. E. J.), A Student's Book on Soils and Manures. Second edition, 130
- Shanahan (Dr. E. W.), Animal Foodstuffs: Their Production and Consumption, with a special reference to the British Empire, 513
- Simpson (J. T.), Hidden Treasure: The Story of a Chore Boy who made the Old Farm Pay, 36
- Staward (R.), Practical Hardy Fruit Culture, 545
- Wild (L. J.), Soils and Manures in New Zealand, 130
- Wood (T. B.), and Dr. F. H. A. Marshall, Physiology of Farm Animals. Part I., General, Dr. F. H. A. Marshall, 704

**Anthropology and Archaeology:**

- Burrow (E. J.), The Ancient Entrenchments and Camps of Gloucestershire, 128
- Farabee (W. C.), The Central Arawaks, 159
- Harrison (Dr. H. S.), The Ascent of Man, 708
- James (Rev. E. O.), An Introduction to Anthropology: A General Survey of the Early History of the Human Race, 384

- Keane (Prof. A. H.), Man: Past and Present. Revised, and largely re-written by A. H. Quiggin and Dr. A. C. Haddon, 255
- Kroeber (Prof. A. L.), Peoples of the Philippines, 420
- Routledge (Mrs. Scoresby), The Mystery of Easter Island: The Story of an Expedition, 583
- Schleier (Dr. F.), Religion and Culture: A Critical Survey of Methods of Approach to Religious Phenomena, 451
- Schmidt (P. W.), Die Gliederung der Australischen Sprachen: Geographische, bibliographische, linguistische Grundzüge der Erforschung der Australischen Sprachen, 707

**Biology:**

- Agar (Prof. W. E.), Cytology: With Special Reference to the Metazoan Nucleus, 482
- Bartsch (P.), Experiments in the Breeding of Cerions, 545
- Boerker (Dr. R. H. D.), Our National Forests: A Short Popular Account of the Work of the U.S. Forest Service on the National Forests, 577
- Borradaile (L. A.), A Manual of Elementary Zoology. Third edition, 804
- Brook (A.), The Buzzard at Home, 746
- Buchanan (Capt. A.), Wild Life in Canada, 426
- Church (A. H.), Elementary Notes on Structural Botany: Elementary Notes on the Reproduction of Angiosperms, 162
- Cockayne (Dr. L.), New Zealand Plants and their Story. Second edition, 707
- Cook (Dr. M. T.), Applied Economic Botany: Based upon Actual Agricultural and Gardening Projects, 34
- Coward (T. A.), The Birds of the British Isles and their Eggs. First series, 132
- Crabtree (J. H.), Grasses and Rushes, and How to Identify Them, 805; Wonders of Insect Life: Details of the Habits and Structure of Insects, 651
- Davies (J. H.), A Map of the World (on Mercator's Projection), having special reference to Forest Regions and the Geographical Distribution of Timber Trees: Timber Maps, Nos. 1 to 4, 577
- Detmold (E. J.), Twenty-four Nature Pictures, 352
- Doncaster (Prof. L.), An Introduction to the Study of Cytology, 190
- Dymes (T. A.), The Nature Study of Plants in Theory and Practice for the Hobby-Botanist, 804
- Ellis (Dr. D.), Iron Bacteria, 323
- Ellis (G. S. M.), Applied Botany, 164
- Fabre (J. H.), Translated by A. T. de Mattos, The Mason-Wasps, 291; The Story Book of Science; The Story Book of Birds and Beasts, 651
- Fawcett (W.), and Dr. A. B. Rendle, Flora of Jamaica. Vol. iv., Dicotyledons: Families Leguminosæ to Callitrichaceæ, 738
- Forrest (H. E.), A Handbook to the Vertebrate Fauna of North Wales, 386
- Gamble (J. S.), Flora of the Presidency of Madras. Part iii., 36
- Hardy (Dr. M. E.), The Geography of Plants, 386
- Hiley (W. E.), The Fungal Diseases of the Common Larch, 639
- Hudson (W. H.), Birds in Town and Country; The Book of a Naturalist, 651
- Jenkins (Dr. J. T.), The Sea Fisheries, 397
- Johnson (Dr. S. C.), Wild Fruits and How to Know Them, 774
- Lillie (Prof. F. R.), Problems of Fertilisation, 225
- Marshall (the late Prof. A. M.), and the late Dr. C. H. Hurst, A Junior Course of Practical Zoology. Ninth edition, revised by Prof. F. W. Gamble, 516
- Matisse (G.), Action de la Chaleur et du Froid sur l'Activité des Etres Vivants, 161
- Maulik (Prof. S.), The Fauna of British India, including Ceylon and Burma. Coleoptera. Chrysomelidæ (Hispinæ and Cassidinae), 64
- Mullens (W. H.), H. Kirke Swann, and Rev. F. C. R. Jourdain, A Geographical Bibliography of British Ornithology from the Earliest Times to the end of 1918. Part i., 353

- Nicoll (M. J.), Hand-list of the Birds of Egypt, 674  
 Parkinson (Dr. W. H.), and H. D. Bell, Insect Life on Sewage Filters, 131  
 Philip (J. B.), Experiments with Plants. A First School-book of Science, 805  
 Rankin (Dr. W. H.), Manual of Tree Diseases, 577  
 Rees (A. W.), The Heron of Castle Creek and other Sketches of Bird Life, 514  
 Royal Botanic Gardens, Kew: Bulletin of Miscellaneous Information, 1919, 228  
 Seton (E. Thompson), Animal Heroes: Being the Histories of a Cat, a Dog, a Pigeon, a Lynx, two Wolves, and a Reindeer. Fourth impression, 580; Monarch: The Big Bear of Tallac, 450; The Arctic Prairies: A Canoe-journey of 2000 miles in Search of the Caribou, 426  
 Seward (Prof. A. C.), Fossil Plants. Vol. iv., 97  
 Skinner (Ada M. and Eleanor L.), Stories for the Nature Hour, 804  
 Small (Dr. J.), The Origin and Development of the Composite, 450  
 Stebbing (E. F.), Commercial Forestry in Britain: Its Decline and Revival, 577  
 Sulman (A. E.), Australian Wild Flowers. Second series, 34; Some Familiar Wild Flowers, 34  
 Sulman (F.), A Popular Guide to the Wild Flowers of New South Wales. Vol. ii., 34  
 Terras (H.), The Story of a Cuckoo's Egg, 746  
 Thompson (L. Beatrice), Just Look! or, How the Children Studied Nature, 651  
 Ward (Dr. F.), Animal Life under Water, 651  
 Webster (A. D.), National Afforestation, 577
- Chemistry:**  
 Adlam (G. H. J.), Acids, Alkalis, and Salts, 705  
 Annual Reports on the Progress of Chemistry for 1919. Vol. xvi., 708  
 Atack (F. W.), assisted by L. Whinayates, The Chemists' Year Book, 1920, 2 vols., 740  
 Brantt (W. T.), and Dr. W. H. Wahl, Techno-Chemical Receipt Book, 739  
 Brown (G. E.), The British Journal Photographic Almanac and Photographer's Daily Companion, 1920, 67  
 Cain (Dr. J. C.), The Chemistry and Technology of the Diazo-Compounds. Second edition, 449  
 Cohen (Prof. J. B.), A Class-book of Organic Chemistry. Vol. ii., 195  
 Cumming (Dr. A. C.), and Dr. S. A. Kay, A Text-book of Quantitative Chemical Analysis. Third edition, 33  
 Demoussy (Dr. E.), Engrais-Amendements Produits anticryptogamiques et Insecticides, 738  
 Dowd (M. T.), and J. D. Jameson, Food: Its Composition and Preparation, 99  
 Dreaper (W. P.), Notes on Chemical Research: An Account of Certain Conditions which Apply to Original Investigation. Second edition, 773  
 Forcrand (Prof. R. de), Cours de Chimie à l'usage des Etudiants P.C.N. et S.P.C.N., Deux. édition. Tome i. et Tome ii., 63  
 Gamble (W.), Photography and its Applications, 740  
 Gibson (C. R.), Chemistry and its Mysteries, 99  
 Giua (Prof. M.), Chimica delle Sostanze Esplosive, 483  
 Halliburton (Prof. W. D.), The Essentials of Chemical Physiology. Tenth edition, 192  
 Harvey (A.), Practical Leather Chemistry, 382  
 Hatschek (E.), Laboratory Manual of Elementary Colloid Chemistry, 705  
 Henri (Dr. V.), Etudes de Photochimie, 640  
 Hurter (Ferdinand), and Vero C. Driffield, A Memorial Volume containing an Account of the Photographic Researches of, edited by W. B. Ferguson, 609  
 Ingle (H.), Elementary Agricultural Chemistry. Third edition, 773  
 Jardine (E. E.), Practical Science for Girls: As applied to Domestic Subjects, 705  
 Jones (E. G.), Chemistry for Public Health Students, 705  
 Kershaw (J. B. C.), Fuel, Water, and Gas Analysis for Steam Users, 227  
 Kingzett (C. T.), Popular Chemical Dictionary, 227  
 Laucks (I. F.), Commercial Oils: Vegetable and Animal, with special reference to Oriental Oils, 132  
 Lecat (Dr. M.), La Tension de Vapeur des Mélanges de Liquides: L'Azéotropisme. Première Partie, 129  
 Lewes (the late Prof. Vivian B.), and Prof. J. S. S. Brame, Service Chemistry: Being a Short Manual of Chemistry and Metallurgy and their Application in the Naval and Military Services. Fifth edition, 287  
 Lucas (A.), Legal Chemistry and Scientific Criminal Investigation, 772  
 Morureu (Prof. C.), Notions fondamentales de Chimie Organique. Sixième édition, 63  
 Myers (Dr. J. E.), and J. B. Fifth, Elementary Practical Chemistry. For Medical and other Students. Second edition, 705  
 Neave (the late Dr. G. B.), and Prof. I. M. Heilbron, The Identification of Organic Compounds. Second edition, 774  
 Neville (H. A. D.), and L. F. Newman, A Course of Practical Chemistry for Agricultural Students. Vol. i., 201. Vol. ii., Pt. i., 33  
 North (B.), assisted by N. Bland, Chemistry for Textile Students, 382  
 Robertson (J. B.), The Chemistry of Coal, 382  
 Robertson (Prof. P. W.), and D. H. Burleigh, Qualitative Analysis in Theory and Practice, 705  
 Robertson (Prof. T. B.), The Physical Chemistry of the Proteins, 257  
 Roux (Dr. E.), and Dr. C.-F. Muttelet, Aliments Sucrés. Sucres—Miels—Sirops—Confitures—Sucreries—Sucrs en Réglisse, 641  
 Searle (A. B.), The Use of Colloids in Health and Disease, 351  
 Soddy (Prof. F.), Le Radium: Interprétation et Enseignement de la Radioactivité. Traduit de l'Anglais par A. Lepape, 805  
 Stewart (Prof. A. W.), Stereochemistry. Second edition, 129  
 Tanner (Dr. F. W.), Bacteriology and Mycology of Foods, 99  
 Taylor (Dr. H. S.), Fuel Production and Utilisation, 609  
 Thorne (P. C. L.), Chemistry from the Industrial Stand-point, 227  
 Tinkler (Dr. C. K.), and Helen Masters, Applied Chemistry: A Practical Handbook for Students of Household Science and Public Health. Vol. i., 227  
 Walker (Prof. J.), Introduction to Physical Chemistry. Eighth edition, 129  
 Wells (Prof. H. L.), Chemical Calculation Tables: For Laboratory Use. Second edition, 33  
 Wilson (Prof. F. J.), and Prof. I. M. Heilbron, Chemical Theory and Calculations. Second edition, 805
- Engineering:**  
 Bairstow (L.), Applied Aerodynamics, 95  
 Baker (Prof. R. P.), Engineering Education: Essays for English, Selected and Edited by, 258  
 Bartlett (Capt. F. W.), and Prof. T. W. Johnson, Engineering Descriptive Geometry and Drawing, Three Parts, 515  
 Blythe (E.), A Text-book on Machine Drawing for Electrical Engineers, 260  
 Gill (J. F.), and F. J. Teago, Examples in Electrical Engineering, 195  
 Hill (J. C.), Telephonic Transmission: Theoretical and Applied, 418  
 Kapp (Prof. G.), The Principles of Electrical Engineering and their Application. Vol. ii., Application, 418  
 Lamb (J.), The Running and Maintenance of the Marine Diesel Engine, 290
- Geography and Travel:**  
 Cranworth (Capt. the Lord), Profit and Sport in British East Africa, being a second edition, revised and enlarged, of "A Colony in the Making," 392  
 Cyprus, The Handbook of. Eighth issue, edited by H. C. Luke and D. J. Jardine, 291  
 Lalesque (Dr. F.), Arcachon, Ville de Santé; Monographie Scientifique et Médicale, 322

Martin (J.), *A Geography of Asia*, 35  
 Miller (L. E.), *In the Wilds of South America: Six Years of Exploration in Colombia, Venezuela, British Guiana, Peru, Bolivia, Argentina, Paraguay, and Brazil*, 159  
 Savory (I.), *The Romantic Roussillon: In the French Pyrenees*, 163  
 Sykes (Miss Ella), and Brig.-Gen. Sir Percy Sykes, *Through Deserts and Oases of Central Asia*, 330  
 Vignaud (H.), *The Columbian Tradition on the Discovery of America and the Part played therein by the Astronomer Toscanelli*, 83

**Geology and Mineralogy:**

Bosworth (Dr. T. O.), *Geology of the Mid-Continent Oil-fields, Kansas, Oklahoma, and North Texas*, 608  
 Cahen (E.), and W. O. Wootton, *The Mineralogy of the Rarer Metals: A Handbook for Prospectors*. Second edition, revised by E. Cahen, 259  
 Case (Prof. E. C.), *The Environment of Vertebrate Life in the Late Palaeozoic in North America: A Paleogeographic Study*, 223  
 Duly (S. J.), *The Natural Wealth of Britain: Its Origin and Exploitation*, 579  
 Harker (Dr. A.), *Petrology for Students*. Fifth edition, 99  
 Moir (J. Reid.), *Pre-Palaeolithic Man*, 289

**Mathematical and Physical Science:**

Andrews (E. S.), *Elements of Graphic Dynamics*, 65  
 Angles (J. W.), *Mensuration for Marine and Mechanical Engineers (Second and First Class Board of Trade Examinations)*, 163  
 Ball (Dr. J.), *Astrolabe Diagram*, 329  
 Ball (Dr. J.), and H. K. Shaw, *A Handbook of the Prismatic Astrolabe*, 329  
 Blake (E.), *Selected Studies in Elementary Physics: A Handbook for the Wireless Student and Amateur*, 739  
 Borchardt (W. G.), *School Mechanics*. Part I., *School Statics*, 163  
 Boutroux (Prof. P.), *Les Principes de l'Analyse Mathématique: Exposé Historique et Critique*. Tome Second, 256  
 Claude et Drencourt, *Description et Usage de l'Astrolabe à Prisme*, 329  
 Comstock (Prof. G. C.), *The Summer Line or Line of Position as an Aid to Navigation*, 552  
 Coursey (P. R.), *Telephony without Wires*, 5  
 Cullis (Prof. C. E.), *Matrices and Determinoids*. Vol. ii., 197  
 Crowther (Dr. J. A.), *Ions, Electrons, and Ionising Radiations*, 740  
 Davison (Dr. C.), *Differential Calculus for Colleges and Secondary Schools*, 65  
 Dennis (T.), *An Arithmetic for Preparatory Schools*. With Answers. Second edition, 67  
 Downing (Prof. E. R.), *A Field and Laboratory Guide in Physical Nature-study*, 675  
 Dowsett (H. M.), *Wireless Telegraphy and Telephony: First Principles, Present Practice, and Testing*, 483  
 Farmer (G. W.), *A First Year Physics for Junior Technical Schools*, 229  
 Ferraris' "Dioptric Instruments": Being an Elementary Exposition of Gauss' Theory and its Applications. Translated by Dr. O. Faber from Prof. F. Lippich's German Translation of Prof. G. Ferraris' Italian Work entitled "The Fundamental Properties of Dioptric Instruments," 542  
 Ferry (E. S.), and others, *A Handbook of Physics Measurements*. Two vols., 193  
 Fleming (Prof. J. A.), *The Propagation of Electric Currents in Telephone and Telegraph Conductors*. Third edition, 611  
 Forsyth (Prof. A. R.), *Solutions of the Examples in a Treatise on Differential Equations*, 260  
 Fowler (R. H.), *The Elementary Differential Geometry of Plane Curves*, 321  
 Freundlich (E.), translated by H. L. Brose, *The Foundations of Einstein's Theory of Gravitation*, 350  
 Hatton (Prof. J. L. S.), *The Theory of the Imaginary in*

*Geometry, together with the Trigonometry of the Imaginary*, 736  
 Heath (Sir Thomas L.), *Euclid in Greek*. Book I. With Introduction and Notes, 288  
 Hutchinson (R. W.), *Intermediate Text-book of Magnetism and Electricity*, 515  
 Jeans (J. H.), *Problems of Cosmogony and Stellar Dynamics*, 31  
 Karpinski (Prof. L. C.), Prof. H. Y. Benedict, and Prof. J. W. Cahoun, *Unified Mathematics*, 162  
 Kenyon (Prof. A. M.), and Prof. W. V. Lovitt, *Mathematics for Collegiate Students of Agriculture and General Science*. Revised edition, 131  
 Lamb (C. G.), *Notes on Magnetism*, 193  
 Love (Prof. A. E. H.), *A Treatise on the Mathematical Theory of Elasticity*. Third edition, 511  
 Mackenzie (Col. J. S. F.), *A Night Raid into Space*, 100  
 Martin (M. J.), *Wireless Transmission of Photographs*. Second edition, 451  
 Mayo (C. H. P.), *Elementary Calculus (with Answers)*, 163  
 Mercer (Rt. Rev. Dr. J. E.), *Some Wonders of Matter*, 67  
 Milne (J.), *The Analytical Geometry of the Straight Line and the Circle*, 65  
 Preston (Prof. T.), *The Theory of Heat*. Third edition, edited by J. R. Cotter, 228  
 Rose (W. N.), *Mathematics for Engineers*. Part ii., 260  
 Schlick (Prof. M.), *Rendered into English by H. L. Brose, Space and Time in Contemporary Physics: An Introduction to the Theory of Relativity and Gravitation*, 546  
 Shore (A.), *Alternating Current Work*, 133  
 Silberstein (Dr. L.), *Projective Vector Algebra: An Algebra of Vectors Independent of the Axioms of Congruence and of Parallels*, 65  
 Slate (Prof. F.), *The Fundamental Equations of Dynamics and its main Co-ordinate Systems Vectorially Treated and Illustrated from Rigid Dynamics*, 65  
 Tancock (E. O.), *The Elements of Descriptive Astronomy*. Second edition, 131  
 Taylor (W. T.), *Calculation of Electric Conductors*, 229  
 Thomas (T.), *Revision Arithmetic Logarithms, Slide Rule, Mensuration, Specific Gravity, and Density*. Second edition, 229  
 Thompson (J. S. and H. G.), *Silvanus Phillips Thompson, D.Sc., LL.D., F.R.S., His Life and Letters*, 448  
 Thomson (Sir J. J.), traduit par Prof. M. C. Moreau, *La Théorie Atomique*, 36  
 Trümpler (R.), *Bestimmung fundamentaler Sternörter aus Höhendurchgangsbeobachtungen*, 329  
 Tychoonis Brahe Dani Opera Omnia. Edidit I. L. E. Dreyer. Tomus vi., 672  
 Whipple (Prof. G. C.), *Vital Statistics*, 131  
 Whitehead (Prof. A. N.), *An Enquiry concerning the Principles of Natural Knowledge*, 446  
 Woltjer, jun. (Dr. J.), *Investigations in the Theory of Hyperion*, 675  
 X-rays, *The Examination of Materials by*. A General Discussion held by the Faraday Society and the Röntgen Society, Tuesday, April 29, 1919, 132

**Medical Science:**

Avery (Margaret), *A Text-book of Hygiene for Training Colleges*, 259  
 Barjon (F.), translated by Dr. J. A. Honeij, *Radio-Diagnosis of Pleuro-Pulmonary Affections*, 4  
 Dixon (Prof. W. E.), *Practical Pharmacology*, 420  
 Edridge-Green (Dr. F. W.), *The Physiology of Vision, with Special Reference to Colour Blindness; Card Test for Colour Blindness*, 575  
 Feldman (W. M.), *The Principles of Ante-Natal and Post-Natal Child Physiology: Pure and Applied*, 638  
 Gurney-Dixon (Dr. S.), *The Transmutation of Bacteria*, 131  
 Keith (Prof. A.), *The Engines of the Human Body: Being the substance of Christmas Lectures given at the Royal Institution of Great Britain, Christmas, 1916-1917*, 195

Nicollé (M.), E. Césari, and C. Jouan, Toxines et Antitoxines, 67  
 Pearson (Prof. Karl), and Julia Bell, A Study of the Long Bones of the English Skeleton, 767  
 Physiology and National Needs, edited by Prof. W. D. Halliburton, 286  
 Pilon (H.), The Coolidge Tube: Its Scientific Applications, Medical and Industrial, 739  
 Rogers (Sir Leonard), Fevers in the Tropics. Third edition, 33  
 Stauffacher (Dr. H.), Neue Beobachtungen über den Erreger der Maulund Klauenseuche, 100  
 Walsh (Prof. J. J.), Medieval Medicine, 127

#### **Metallurgy:**

Curtis (A. H.), Manganese Ores, 193  
 Davies (G. M.), Tin Ores, 193  
 Lones (Dr. T. E.), Zinc and its Alloys, 193  
 Macgregor (M.), and others, The Iron Ores of Scotland, 419  
 Metals, Institute of, Journal of the, vol. xxii., No. 2, edited by G. Shaw Scott, 164  
 Parsons (S. J.), Malleable Cast Iron. Second edition, 290

#### **Meteorology:**

Elgie (J. H.), Elgie's Weather Book: For the General Reader, 739  
 Horner (D. W.), Meteorology for All: Being some Weather Problems Explained, 323  
 McAdie (Prof. A.), The Principles of Aërography, 479  
 Rouch (J.), Manuel Pratique de Météorologie, 451  
 Stacey (W. F.), Practical Exercises on the Weather and Climate of the British Isles and North-West Europe, 133

#### **Miscellaneous:**

Arthur (Sir George), Life of Lord Kitchener, 3 vols., 319  
 Bose (Sir Jagadis Chunder), Life Movements in Plants, 416  
 Burke (E. T.), The Venereal Problem, 543  
 Bury (Prof. J. B.), The Idea of Progress: An Inquiry into its Origin and Growth, 733  
 Cannons (H. G. T.), Bibliography of Industrial Efficiency and Factory Management, 641  
 Corbett (Sir J. S.), History of the Great War, based on Official Documents. By direction of the Historical Section of the Committee of Imperial Defence: Naval Operations, vol. i., 546  
 Domville-Fife (Lieut. C. W.), Submarine Warfare of To-Day, 36  
 Elhuff (L.), General Science: First Course, 352  
 Firth (Sir R. H.), Musings of an Idle Man, 100  
 Fisher (Lord), Memories, 95  
 Flint (G. E.), The Whole Truth about Alcohol, 386  
 Fuller (E.), (Brevet-Col. J. F. C.), Tanks in the Great War, 1914-1918, 702  
 Gilbreth (F. B. and Dr. Lillian M.), Motion Study for the Handicapped, 737  
 Gough (G. W.), Half-past Twelve: Dinner Hour Studies for the Odd Half-hours, 611  
 Hayward (Dr. F. H.), A First Book of School Celebrations, 707; A Second Book of School Celebrations, 804  
 Henry (Prof. A.), Forests, Woods, and Trees in relation to Hygiene, 158  
 Héricourt (Dr. J.), The Social Diseases: Tuberculosis, Syphilis, Alcoholism, Sterility. Translated, and with a final chapter, by B. Miall, 543  
 International Research Council: Constitutive Assembly held at Brussels, July 18 to July 28, 1919. Report of Proceedings, edited by Sir Arthur Schuster, 543  
 Jellicoe (Lord), The Grand Fleet, 1914-16, 93  
 Johnson (Dr. S. C.), Pastimes for the Nature Lover, 774  
 MacNutt (J. S.), The Modern Milk Problem in Sanitation, Economics, and Agriculture, 385  
 Mees (Dr. C. E. Kenneth), The Organisation of Industrial Scientific Research, 771  
 Population and Parenthood, Problems of (being the

Second Report of, and the Chief Evidence taken by, the National Birth-rate Commission, 1918-20), 543  
 Ross (Sir Ronald), Philosophies; Psychologies, 414  
 Scientific and Learned Societies of Great Britain and Ireland, The Year Book of the. Thirty-sixth annual issue, 580  
 Scott (Sir Percy), Fifty Years in the Royal Navy, 92  
 Soddy (Prof. F.), Science and Life: Aberdeen Addresses, 1  
 Spaight (Dr. J. M.), Aircraft in Peace and the Law, 483  
 Terhune (A. P.), Lad: A Dog, 484  
 Thomas (W. N.), Surveying, 801  
 Tisdale (C. W. W.), and J. Jones, Butter and Cheese, 738  
 Trafton (G. H.), The Teaching of Science in the Elementary School, 420  
 Turner (Major C. C.), The Struggle in the Air, 1914-18, 229  
 Walston (Sir Charles), Eugenics, Civics, and Ethics, 804  
 Watt (Dr. H. J.), The Foundations of Music, 98  
 Westaway (F. W.), Scientific Method: Its Philosophy and its Practice. New edition, 5  
 Wharton (the late Rear-Admiral Sir W. J. L.), Hydrographical Surveying: A Description of Means and Methods employed in constructing Marine Charts. Fourth edition, revised and enlarged by Admiral Sir Mostyn Field, 576  
 Wright (Lewis), Optical Projection. Fifth edition, rewritten and brought up to date by R. S. Wright (in two parts). Part I., The Projection of Lantern Slides, 773

#### **Philosophy and Psychology:**

Alexander (Prof. S.), Space, Time, and Deity: The Gifford Lectures at Glasgow, 1916-18. Two vols., 798  
 Boirac (E.), translated and edited with an introduction by W. de Kerlor, The Psychology of the Future ("L'Avenir des Sciences Psychiques"), 323  
 Butler (S.), Luck or Cunning, as the Main Means of Organic Modification? An Attempt to throw Additional Light upon Darwin's Theory of Natural Selection. Second edition, 773; Unconscious Memory. Third edition, 774  
 Cohen-Kysper (A.), Rückläufige Differenzierung und Entwicklung, 164  
 Ellis (Havelock), The Philosophy of Conflict: and other Essays in War-time. Second series, 353  
 European Thought, Recent Developments in, Essays arranged and edited by F. S. Marvin, 607  
 Jastrow, jun. (Prof. M.), A Gentle Cynic: Being a Translation of the Book of Koheleth, commonly known as Ecclesiastes, stripped of later additions; Also its Origin, Growth, and Interpretation, 226  
 Link (Dr. H. C.), Employment Psychology: The Application of Scientific Methods to the Selection, Training, and Grading of Employees, 673  
 McDougall (Dr. W.), An Introduction to Social Psychology. Fourteenth edition, 291  
 Redgrove (H. S.), Bygone Beliefs: Being a series of Excursions in the Byways of Thought, 610  
 Richardson (C. A.), Spiritual Pluralism and Recent Philosophy, 773  
 Smith (W. W.), A Theory of the Mechanism of Survival: The Fourth Dimension and its Applications, 484  
 Tansley (A. G.), The New Psychology and its Relation to Life, 770  
 Watson (Prof. J. B.), Psychology from the Standpoint of a Behaviorist, 512  
 Westaway (F. W.), Science and Theology: their Common Aims and Methods, 607  
 Wohlgenuth (Dr. A.), *The British Journal of Psychology*: Monograph Supplements. No. vi., Pleasure—Unpleasure, 3

#### **Technology**

Baker (R. T.), The Hardwoods of Australia and their Economics, 802  
 Chalmers (T. W.), Paper-making and its Machinery: Including chapters on the Tub-sizing of Paper, the

- Coating and Finishing of Art Paper, and the Coating of Photographic Paper, 480
- Mortimer (G.), Aluminium: Its Manufacture, Manipulation, and Marketing, 805
- Neale (R. E.), Electricity: Its Production and Applications, 804
- Rosenhain (Dr. W.), Glass Manufacture. Second edition, 128
- Summers (A. L.), Asbestos and the Asbestos Industry: The World's Most Wonderful Mineral, and other Fire-proof Materials, 193
- White (B.), Gold: Its Place in the Economy of Mankind, 774; Silver: Its Intimate Association with the Daily Life of Man, 774
- Revista di Biologia*, A New Italian Review, 756
- Rhodesia Museum, Bulawayo, Report of the, 367
- Rhodium, Colloidal, C. Zenghelis and B. Papaconstantinou, 411
- Rhone, Utilisation of the Water-power of the, M. Fournils, 465
- Richards, Ellen, Research Prize, The, 366
- Riebeckite-rhyolite from North Kordofan, Sudan, W. C. Smith, 156
- Rigidity of Wires, A. Bifilar Method of Measuring the, G. F. C. Searle, 473
- River: Flow, Estimating, from Rainfall Records, Lt.-Col. J. E. E. Craster, 42; -windings, Mortlakes as a cause of, T. S. Ellis, 264
- Roast Beef of Old England, The, 62
- Roccamonfina, Leucitic Lavas of the Volcano of, V. Sabatini, 844
- Rochester University, Endowment from the U.S. General Education Board and G. Eastman, for a School of Medicine, etc., 601
- Rockefeller Gift to Medical Science, The, Prof. W. M. Bayliss, 501
- Romanes Lecture, The, Dean Inge, 431
- Rostro-carinate Flint Implements and Allied Forms, Some, Sir Ray Lankester, 631
- Rotary Club of London and Demobilised Men out of employment, 402
- Rothamsted Experimental Station, Visit of the Association of Economic Biologists and the Imperial Entomological Conference to the, 464
- Roussillon, The Romantic, in the French Pyrenees, Isabel Savory, 163
- Royal: Academy, The, 300; the Portrait of Sir Clifford Allbutt in the, 335; Botanic Society of London, Quarterly Summary, July, of the, 835; College of Physicians, Edinburgh, The, Dr. Jessie Macgregor Prize awarded to Miss Lucy Davis Cripps, 794; of London, Arrangement for the Delivery of Lectures of the, 722; Appointment of Lecturers in connection with the, 755; College of Science, Annual Dinner of Old Students of the, Speeches by Sir Richard Gregory, the Marquess of Crewe, and others, 281; for Ireland, Award of the Fellowship Diploma of the, to H. Ramage and R. L. Wills, 25; College of Surgeons of England, Subject for the Jacksonian Prize for 1921, 249; The Duke of Connaught admitted an Honorary Fellow of the, 556; Gift to the Museum of Microscopical Preparations by Sir Charles Tomes, 557; Elections in connection with the, 622; College of Veterinary Surgeons, Dr. O. C. Bradley elected President of the, 601; Danish Society of Science, Sir Ernest Rutherford, Sir Joseph Thomson, Sir George Grierson, and Prof. W. M. Lindsay elected Fellows of the, 209; Geographical Society, Awards of the, 112; Institution Lecture Arrangements, 80; Election of Officers of the, the Duke of Northumberland President, 304; Irish Academy, H. L. Le Châtelier, Prof. G. E. Hale, Prof. A. E. H. Love, and Sir Ernest Rutherford elected Honorary Members of the, 113; Prof. G. H. Carpenter elected Secretary of the, 590; Military Academy, The, J. Young, 487; Navy, Fifty Years in the, Admiral Sir Percy Scott, 94; Observatory, Greenwich, Annual Visitation of the, 469; Society, Recommended Candidates for the Fellowship of the, 17; Reports of the Grain Pests (War) Committee, Nos. 4 to 7, 236; Con-
- versazione, The, 373; H. A. L. Fisher and Sir James G. Frazer elected Fellows of the, 556; Society of Edinburgh, The Prince of Wales nominated as an Honorary Fellow of the, 335; W. W. Campbell, Prof. Y. Delage, Prof. H. A. Lorentz, A. G. Nathorst, Ch. E. Picard, Prof. C. Richey, and Prof. G. O. Sars elected Foreign Honorary Fellows of the, 556; Society of Arts, The Albert Medal of the, awarded to Prof. A. A. Michelson, 496; Award of Medals of the, 556; A. A. Campbell Swinton elected Chairman of the Council of the, 654; Statistical Society, Election of Officers of the, 526
- Rubber: Cold Vulcanisation of, A Process for the, S. J. Peachey, 625; The Industrial Uses of, Offer of Prizes in connection with, 496; The Stretching of, in Free Balloons, Dr. H. P. Stevens; W. H. Dines, 613
- Rückläufige Differenzierung und Entwicklung, A. Cohen-Kysper, 164
- Rupture and Flow in Solids, The Phenomena of, A. A. Griffith, 58; Russia, North-West, The Climate of, 119
- Rutherford Atom, A Law of Force giving Stability to the, J. Marshall, 666
- Safety Lamps in Chemical Works, Need of, W. Payman, 116
- Sage Grouse, Habits of the, B. Horsfall, 786
- S. T. Andrews University, Forthcoming Conferment of Honorary Degrees, 440
- Sainte-Genèveve Observatory, Instruments and Work of the, G. Bigourdan, 475
- Salisbury Public Library, Report for 1919-20 of the, 240
- Salt-Land Reclamation, Practical, G. S. Henderson, 434
- Salts necessary for Plant Nutrition, The Physiological Balance of the, J. W. Shive, 310
- Salvarsan, The Composition of, Fargher and Pyman, 185
- San Juan District, Porto Rico, The Geology of the, D. R. Semmes, 148
- Sands, Stratified, and Gravels replaced by "Snow-white Granular Silica," W. H. Collins, 242
- Saturn, Occultation of a Star by, 244
- Savages of the Far Past, 384
- Sawing Metals by Hand, Work done in, Ch. Fremont, 251
- Saxon Remains, Supposed, Discovery of, in Windsor Great Park, Capt. Vaughan-Williams, 209
- Scabiosine, A New Glucoside capable of Hydrolysis by Emulsion, Em. Bourquelot and M. Bridel, 187
- Scandinavian Mountain Problem, The, O. Holtehdahl, 633
- Schaumasse Comet, 1920b, Discovery and Observations of, A. Schaumasse, 794
- Scholarships, Plea for an Ampler Provision of, Dr. R. S. Clay, 23
- Scholasticism, Science and, Prof. J. J. Walsh, 547; Dr. C. Singer, 548
- School: and University Training, Formation of a Consultative Council of the Overlapping of, 602; Celebrations, A First Book of, Dr. F. H. Hayward, 707; A Second Book of, Dr. F. H. Hayward, 804
- Science: and Crime, 772; and Engineering, 258; and Life: Aberdeen Addresses, Prof. F. Soddy, 1; and Pharmacy, Progress in, C. A. Hill, 659; and Philosophy, Greek, Dr. C. Singer, 373; and Research in the Air Service 142; and Scholasticism, Dr. C. Singer, 127; Prof. J. J. Walsh, 547; Dr. C. Singer, 548; and Scientific Research in Medicine and Surgery, Sir Aston Webb, 304; and the Nation, Lord Sydenham, 468; and the New Army, 61; Col. E. H. Hills, 103; Prof. L. N. G. Filon; Prof. R. Whiddington, 133; Lt.-Col. E. Gold; Dr. C. S. Myers, 135; Prof. A. R. Richardson, 170; Col. K. E. Edgeworth, 233; C. S. Wright, 391; and Technology, The Imperial College of, 173; and Theology: their Common Aims and Methods, F. W. Westaway, 607; Applied and Industrial Research, J. W. Williamson, 387; Prof. F. Soddy, 422; Major A. G. Church, 423; J. W. Williamson, 518; Major A. G. Church, 547; Artillery, Sir George Greenhill, 268; Education and, in the Civil Service Estimates for 1920-21, 246; General, First Course, L. Elhufl, 352; History of, Courses on the, 270; in Medical Education, Prof. S. J. Hickson, 643; in the Elementary School,

- the Teaching of, G. H. Trafton, 420; Museum, South Kensington, Col. H. G. Lyons appointed Director and Secretary to the, 463; the Geological Survey and Museum of Practical Geology, Reports on the, for 1919, 656; Practical for Girls: as Applied to Domestic Subjects, E. E. Jardine, 705; The Federation of, 317; The Story Book of, J. H. Fabre, 651
- Scientific and Technical Books, Sir R. A. Gregory, 41; Apparatus and Laboratory Fittings, C. Beck, 355; B. H. Morphy; C. Baker, 356; Bellingham and Stanley, Ltd.; W. Taylor; H. W. Ashfield, 357; Apparatus, British and Foreign, D. H. Baird, 390; J. W. Ogilvy, 424; J. S. Dunkerly, 425; F. W. Watson Baker, 518; Prof. W. M. Bayliss, 641; Apparatus from Abroad, Prof. W. M. Bayliss, 293; Direction of Industrial Research, Major A. G. Church, 40; Method: Its Philosophy and its Practice, F. W. Westaway. New edition, 5; Publications, The Cost of, 285; Prof. W. A. Herdman; Prof. H. H. Turner, 326; E. B. Knobel; W. W. Bryant, 327; Prof. G. H. Hardy; Dr. A. B. Rendle, 353; Dr. C. S. Myers, 354; Dr. C. G. Knott, 425; Research, Dr. J. W. Evans, 358; and the Glass Industry in the United States, Dr. M. W. Travers, 9; Importance of Co-operative, E. B. Wedmore, 339; The Public Support of, Prof. F. Soddy, 309; Reunions at the Natural History Museum, Dr. G. F. H. Smith, 72; Societies, Conjoint Board of, Report for 1919, 343; Work, Expenses of, Major A. G. Church, 72; in India, The Organisation of, 565; Sir Thomas H. Holland, 452; Work: Its Spirit and Reward, Dr. G. J. Fowler, 387; Organisation of, Dr. W. Bateson; J. S. Gamble, Sir Ronald Ross, 6; Dr. E. J. Russell; Prof. A. C. Seward, 7; Sir J. C. Bose, 39; Sir T. H. Middleton, 103; Sir Leonard Rogers, 292
- Scotland, The Economic Geology of the Central Coalfield of, 656
- Scottish Shale Oil Scientific and Industrial Research Association, Approval of the, 210
- Screw Gauges, Verification of, for Munitions of War, M. Cellier; B. Powell, 184
- Sea: and Sky at Sunset, Lt.-Col. K. E. Edgeworth; J. S. D., 358; -anemones, The Transplanting of, by Hermit Crabs, R. P. Cowles, 668; -birds: Their Relation to the Fisheries and Agriculture, Dr. W. E. Collinge, 172; Fisheries, Oceanography and the, Prof. W. A. Herdman, 813; The, Dr. J. T. Jenkins, 397; -waves, the Height of, J. Rouch, 219
- Seed: Electrification, Experiments in, Sutton and Sons, 337; -wheat, the Treating of, for Bunt, 211
- Seedlings which turn Green in the Dark, H. Coupin, 411
- Seismological Observations at De Bilt, Report of the, for 1916, 276
- Selous Memorial at the Natural History Museum, The, 504
- Sensation and the Cerebral Cortex, Dr. H. Head, 363
- Serum, Proteins of the, Separation of the, M. Piettre and A. Vila, 571
- Service Chemistry, the late Prof. V. B. Lewis and Prof. J. S. S. Brame. Fifth edition, Sir T. E. Thorpe, 287
- Sewage: Filters, Insect Life on, Dr. W. H. Parkinson and H. D. Bell, 131; Systems, Past and Present, A. J. Martin, 702
- Shamanism among the Cahuilla Indians, Miss L. Hooper, 502
- Sheep, the Fattening of, Application of the Food-unit System to, Prof. J. Wilson, 282
- Sheffield: University, Dr. W. E. S. Turner appointed Professor of Glass Technology; J. Husband, Professor of Civil Engineering; Dr. Mellanby, Professor of Pharmacology; R. E. Pleasance, Demonstrator in Pathology, 601; Dr. R. B. Wheeler appointed Professor of Fuel Technology; D. Knoop, Professor of Economics, 665
- Shell Flight, The Dynamics of, R. H. Fowler, 459
- Shepherd's-nurse, A Third Duplication of Genetic Factors in, Prof. G. H. Shull, 705
- Shilluks' Belief in Medicine Men, The Rev. D. S. Oyler, 527
- Sierra Leone, Pleistocene Movements of Elevation in, F. Dixey, 689
- Silicate and Carbonate Rocks, Analysis of, W. F. Hillebrand, 836
- Silicon Iron (Stalloy), The Magnetic Properties of, in Alternating Magnetic Fields of Low Value, A. Campbell, 473
- Silver: Its Intimate Association with the Daily Life of Man, B. White, 774; The World's Production of, Report on, Prof. H. C. H. Carpenter and Prof. C. G. Cullis, 72
- Simocephalus vetulus*, Production and Transmission of an Environmental Effect in, H. G. Cannon, 538
- Sky, the Blue, and the Optical Properties of Air, Lord Rayleigh, 584
- Slag, a New Use for, 434
- Sleeping Sickness Commission of the Royal Society, Reports of the, No. xvii., 663
- Smithsonian, Lessons from the, 627
- Smoke Nuisance, The, 471
- Snowdon, Little Book About, H. V. Davis, 87
- Social: Diseases, The, Tuberculosis, Syphilis, Alcoholism, Sterility, Dr. J. Héricourt. Translated, and with a final chapter, by B. Miall, 543; Service in Rural Areas, Sir Henry Rew, 731
- Société Helvétique des Sciences Naturelles, Forthcoming Annual Meeting of the, 687
- Society of Tropical Medicine and Hygiene, The, to be known in future as the Royal Society of Tropical Medicine and Hygiene, 526
- Sodium Fluoride, The Usefulness of, Employed as an Antiseptic for the Preservation of Railway-sleepers, H. Devaux and H. Bouygués, 379
- Softwoods, African, for Pulp Production, A. H. Unwin, 599
- Soil: Cultivation, Physical Problems in, B. A. Keen, 438; Erosion, Observations on, W. Torrance, 434; Temperatures, F. L. West, N. E. Edlefsen, and S. Ewing; Capt. T. B. Franklin, 628; Effect of Weather Changes on, Capt. T. B. Franklin, 282; The, An Introduction to the Scientific Study of the Growth of Crops, Sir A. D. Hall. Third edition, 384
- Soils: A Standard Book on, 384; Ammoniating Power of, Measure of the, R. Perotti, 844; and Manures, A Student's Book on, Dr. E. J. Russell. Second edition, 130; in New Zealand, L. J. Wild, 130
- Solanaceae, The Embryogeny of the, R. Souèges, 442, 475
- Solar: Constant of Radiation, A New Method of Determining the, C. G. Abbot, 667; Chromosphere, Ionisation in the, M. N. Saha, 232; Eclipse, The Total, of 1918, June 8, Dr. Slipher, and others, 117; of May, 1919, The, Prof. L. A. Bauer, 311; Radiation Station, New, in Arizona, 726; Variation and the Weather, Dr. C. G. Abbot, 678
- Solfidugæ of South Africa, Survey of the, J. Hewitt, 275
- Solvay, International Institute of Physics, Impending Resumption of the Work of the, 399
- Somersetshire: Archaeological and Natural History Society, Annual Meeting of the, Presidential Address to the, H. Balfour, 835
- Sorby Research Fellowship, The, awarded to Dr. F. C. Thompson, 377
- Sorsoporella uella*, Experiments on, A. T. Speare, 310
- Sound: -ranging as practised by the U.S. Army during the War, Prof. A. Trowbridge, 116
- South: Africa, Ostrich Study in, Prof. J. E. Duerden, 106; African Entomophthoraceæ, Some, S. H. Skiffe, 507; America: In the Wilds of, Six Years of Exploration in Colombia, Venezuela, British Guiana, Peru, Bolivia, Argentina, Paraguay, and Brazil, L. E. Miller, 159; The Wilds of, 159; American Monkeys, External Characters of, R. I. Pocock, 218; -Eastern Union of Scientific Societies, Annual Congress of the, 530
- Southampton, University College of, S. Mangham appointed Professor of Botany at the, 608
- Southern Pine Association, Gift from the, for Forestry Work, 52
- Space: and Time in Contemporary Physics: An Introduction to the Theory of Relativity and Gravitation, Prof.



- M. Schlick. Rendered into English by H. L. Brose, 546; Time, and Deity: The Gifford Lectures at Glasgow, 1916-18, Prof. S. Alexander, 2 vols., 798
- Spark Spectra of various Elements in Helium in the Extreme Ultra-violet, Prof. J. C. McLennan, and A. C. Lewis, 632
- Species, Genera and, A. Mallock, 675
- Spectra of Explosions, J. A. Anderson, 668
- Spectral: Lines, Intensity of, Effect of a Magnetic Field on the, H. P. Waran, 379; Reflective Properties of certain Alloys, Preparation and Determination of the, R. G. Waltenberg and W. W. Coblenz, 212
- Spectrometer, etc., Wave-length, Catalogue of Hilger's, 369
- Spectropheliometer, A New, and Solar Measurements made with it, W. W. Coblenz and H. Kahler, 525
- Spectroscopic Observations of the Gaseous Nebulæ, Certain Aspects of Recent, W. H. Wright, 842
- Spectrum: An Experiment on the, Dr. R. A. Houstoun, 421; Certain Antagonistic Properties of various Regions of the, G. Le Bon, 571
- Sphenodon punctatus, Development of the Auditory Apparatus in, F. J. Wyeth, 26
- Spherical Conductors, The Capacity Coefficients of, A. Russell, 57
- Sphexapata (*Millogramma*) conica, Notes on the Habits of the Tachinid Fly, O. H. Latter, 614
- Spica, Conjunction of Mars with, 340
- Spiral: Compensator, The, and New Problems of the Mechanics of Regulation, J. Drach, 443; Nebulæ, Globular Clusters and, The Parallaxes of, K. Lundmark, 215
- Spirit Levelling, Systematic Error in, J. H. Cole, 409
- Spiritual Pluralism and Recent Philosophy, C. A. Richardson, 773
- Spitsbergen, The Discovery of, Dr. F. Nansen, 210
- Sponges: Dr. G. P. Bidder, 441; of Ireland, the Fresh-water, Miss Jane Stephens, 474
- Spores and Plant-life in Deep Caves, The Carrying Power of, Edith A. Stoney, 740
- Spraying of Trees, Injury to Foliage by the, 211
- Sproul Observatory, Parallax Work at the, Dr. Miller, 500
- Standard Time in Finland, H.R., 145
- Standing Stones at Duddo, The, Capt. W. J. Rutherford, 623
- Star: A, with a Large Proper Motion, F. Kromm, 282; Clusters, Dr. H. Shapley, 54; Occultation of a, by Saturn, L. J. Comrie, 22
- Stars: Double, J. Jackson, 436; The Masses of the, Prof. H. N. Russell, 500; Total Light of the, P. J. Van Rhijn, 54
- State: Museums and the, Prof. E. W. MacBride; Prof. J. W. Gregory, 68; Dr. F. A. Bather; Dr. W. E. Hoyle, 69; W. G. Wagner, 70; Sir E. Ray Lankester; Prof. J. Stanley Gardiner, 101; Dr. W. M. Tattersall, 102; F.R.S., 136; The, and the National Museums, 29
- Statics, School (School Mechanics, Part. I.), W. G. Borchardt, 163
- Statistics, Applied, 470
- Steel: Ingot, The Macrographic Study of the Propagation of Cooling in the Interior of a, starting from its solidification, Descolas and Prêtet, 411; Ingots, the Minute Fissures in, G. Charpy, 27; Nickel, The Anomaly of Elasticity of the, C. E. Guillaume, 609; The Elasticity of Torsion of, with a high proportion of Chromium, P. Chevenard, 609; Special Alloy, in the Construction of Bridges, The Economical Use of, J. A. L. Waddell, 699; The Resistance of, to Cutting by Tools, Ch. Fremont, 187
- Stellar: Facts, New, and their bearing on Stellar Theories for the Ferns, J. M'Lean Thompson, 250
- Stellar: Dynamics, Problems of Cosmogony and, J. H. Jeans, 31; Spectroscopy at the Detroit Observatory, 244; Substance, The Wasting of, Prof. F. W. Very, 276
- Stereochemistry, Prof. A. W. Stewart. Second edition, 129
- Stewart Prize of the British Medical Association, The, awarded to Dr. Harriette Chick, 432
- Stipends and Pensions, University, 477
- Stone: Implements of Palæolithic Type Throwing Light on the Method of Manufacture in South Africa, Dr. L. Péringuey, 609; Mould, A Curious, Mrs. M. E. Cunningham, 497; Statues, The Island of, Sir Everard im Thurn, 583; Worship, A Curious Case of, H. A. MacMichael, 115
- Stonehenge, Restoring to a Position of Safety the Stones of, 209
- Stonyhurst: College: Observatory. Report and Notes on, 1019, Rev. A. L. Cortie, 624; Observations, 1919, Rev. A. L. Cortie, 789
- Storm-petrel, Nesting Habits of the, A. Gordon, 20
- Strand-loopers, Dr. L. Péringuey, 558
- Strasbourg University, Opening Address at Installation of the Chair of Mineralogy in, Prof. G. Friedel, 368
- String, An Experiment on a Piece of Common, G. F. C. Searle, 474
- Sublimates produced by Metalloids and Metals Volatilised by the Blowpipe, Method for Collecting and Characterising the, Ad. Braly, 219
- Submarine; Explosions, The Pressure-wave thrown out by, H. W. Hilliar, 313; Warfare of To-day, Lt. C. W. Domville-Fife, 36
- Sugar: -beet during the War, The, E. Saillard, 571; Production in England, Possibilities of, 434; Cultivation in India, Dr. W. E. Brenchley, 840
- Sulphuric Ions: Detection of Masked, in Complex Compounds, R. Job and G. Urbain, 283; in Complex Salts, the Differentiation of Masked and Apparent, A. Kling and D. Florentin, 379
- Sumatran Hare (*Nesolagus Netscheri*), The, E. Jacobson and H. B. Kloss, 115
- Summer, The Weather of the Present, 837
- Summer Line: The, or Line of Position as an Aid to Navigation, Prof. G. C. Comstock, 552; Lines in Navigation, Use of, Capt. T. H. Tizard, 552; Prof. G. C. Comstock; Capt. T. H. Tizard, 742; Dr. J. Ball, 806
- Sun: as a Weather Prophet, The, 830; Mercury, and Venus, Cape Observations of the, 183; Meteorological Influences of the, and the Atlantic, Prof. J. W. Gregory, 715; Observations of the, made at the Lyons Observatory, J. Guillaume, 218; 251
- Sundial giving Legal Time throughout the Year, A. Ch. Gautier, 506
- Sunlight and the Life of the Sea, Dr. B. Moore, E. Whiteley, and T. A. Webster, 90
- Sunshine in the United States, J. B. Kincer, 791
- Surveying: W. N. Thomas, 801; Principles and Practice of, Lt.-Col. H. S. Winterbotham, 801
- Survival: A Theory of the Mechanism of, The Fourth Dimension and its Applications, W. W. Smith, 484
- Swanley Horticultural College, Proposal to allot a Treasury Grant for the, 472
- Swansea: University College, Prof. C. A. Edwards appointed Professor of Metallurgy, Dr. J. E. Coates Professor of Chemistry, Dr. E. A. Evans Professor of Physics, Lt.-Col. A. R. Richardson Professor of Mathematics, Dr. A. E. Trueman Lecturer in Geology, E. E. Hughes, Lecturer in History, 6 5; The Laying of the Foundation-stone by the King, 665 Grants to, by the Treasury, 841
- Swift, Evelyn, Pepsy, and, Weather Notes of, in Relation to British Climate, Capt. C. J. P. Cave, 393
- Syme, The David, Prize awarded to F. Chapman, 496
- Symmetrisable Functions and their Expansion in Terms of Biorthogonal Functions, J. Mercet, 632
- Synapsis: Studies on, II., L. T. Hogben, 539; The Problem of, L. T. Hogben, 570
- Synechtrium endobioticum (Schlib.). Perc., Life-history and Cytology of, Miss K. M. Curtis, 346
- Synthetic Ammonia, The Manufacture of, and Production of Nitrates, 312
- T.N.T., Products of Detonation of, Prof. C. E. Munroe, 795
- Tanks: and Scientific Warfare, 702; in the Great War, 1914-1918, Brevet-Col. J. F. C. Fuller, 702
- Tannins from Wattle-bark, Extraction of, 724

- Tasmanian Mammals, Living and Extinct, Studies of. Part. ii., H. H. Scott and C. Lord, 796
- Teachers in the U.S.A., The Supply and Remuneration of, 731
- Technical: Colleges and the Universities, The Necessity for Close Co-operation Between, Principal C. Coles, 728; Education and Mind Training, E. L. Rhead, 439; Institutions, Association of, Annual General Meeting of the, 22; 727; Libraries and Intelligence, Major W. E. Simmet, 505; Library, The, R. Borlase Matthews, 505; *Review*, Retirement of Major W. E. Simmet from the Editorship and Direction of the, 722; Schools and their part in Adult Education, A. Mansbridge, 23
- Techno-Chemical Receipt Book, Compiled and Edited by W. T. Brannt and Dr. W. H. Wahl, 739
- Telephonic Transmission: Theoretical and Applied, J. G. Hill, 418
- Telephony and Telegraphy, Multiplex, over Open-circuit Bare Wires laid in the Earth or Sea, Gen. Squier, 467; Wireless, Prof. W. H. Eccles, 519; without Wires, P. R. Coursey, 5
- Telephotography, A Note on, A.B., 488
- Telescope, The Optimum Magnification of a, M. Battestini, 443
- Telescopes, Increasing the Photographic Power of, Dr. Shapley, 625
- Tempel's Comet: Return of, 436; 560; M. Fayet, 789; P. Chofardet, 704
- Temperature: Curve, The Daily, Prof. L. Becker, 282; Life and, 161; The Influence of, on the Rigidity of Metals, A. Mallock, 631; Variations at 10,000 ft., C. K. M. Douglas, 614; in the North Atlantic Ocean and in the Atmosphere, Drs. B. Helland-Hansen and F. Nansen, 715
- Terra Sigillata, Introduction to the Study of, Dr. F. Oswald and T. D. Price, 240
- Terraces in Chalk Districts, The Mode of Formation of, L. Gentil, 315
- Terre et des Planètes, L'Origine des formes de la, E. Belot, 559
- Tetanus during the Great War, Prevention of, Major-Gen. Sir David Bruce, 785
- Tetrahedra, Generation of Sets of Four, mutually Inscribed and Circumscribed, C. V. H. Rao and Prof. Baker, 379
- Textile: Industries and Technical Education in Canada and the United States, 789; Research in, 118; Students, Chemistry for, B. North, assisted by N. Bland, 382
- Therapeutic Substances offered for Sale, Appointment of a Committee Upon, 273
- Thermionic: Valve, The, in Wireless Telegraphy and Telephony, Prof. J. A. Fleming, 716; Valves, The Development of, for Naval Uses, B. S. Gossling, 559
- Thermo: -couples, Construction of, by Electro-deposition, W. H. Wilson and Miss T. D. Epps, 842; -electricity, Recent Progress in, Prof. C. A. F. Benedicks, 499
- Thermostatic Metal, 703
- Thompson: Life and Letters of Silvanus P., A. A. Campbell Swinton, 448; Silvanus Phillips, D.Sc., LL.D., F.R.S., His Life and Letters, J. S. and H. G. Thompson, 448
- Thrush, The First Act of a Young, Honor M. M. Perry-coste, 456
- Thunder and Lightning at Kimberley, Some Statistics of, J. R. Sutton, 507
- Thunderstorms of May 29, The, and the Louth Disaster, 468
- Tidal: Friction and the Lunar and Solar Accelerations, Dr. H. Jeffreys, 403; in Shallow Seas, H. Jeffreys, 632; Motion in the Irish Sea: Its Currents and its Energy, R. O. Street, 632; Power, 427
- Tides in Landlocked and Border Seas, Bays, and Channels, Dr. A. Defant, 466
- Timber: Exhibition, The Empire, A. L. Howard, 691; Map, Nos. 1 to 4, J. H. Davies, 577
- Timbers Grown in France, Forthcoming Researches upon, 722
- Time: and Latitude, Methods of Determining, C. Puente, 213; -reckoning of the North American Indians, 75
- Tin: and Antimony, The Separation of, A. Kling and A. Lassieur, 442; Ores, G. M. Davies, 193
- Tissues, Resistance of, to Light and Ultra-violet Rays, L. Vignon, 506
- Topography, Effect of, on Precipitation in Japan, Prof. Terada, 599
- Toronto University: Dr. V. J. Harding appointed Professor of Pathological Chemistry in, 537; the Appointment of Prof. A. T. De Lury as head of the Department of Mathematics, 762
- Torquay Natural History Society, Journal of the, Vol. II, No. 6, 788
- Total Solar Eclipse of September 20, 1922, The, A. R. Hinks, 84
- Toxines et Antitoxines, M. Nicolle, E. Césari, and C. Jouan, 67
- Trade Routes of the British Empire in Africa, G. F. Scott Elliott, 274
- Trans-African Flight, The Recent, Lt. L. Walmsley, 624
- Transport, Some National Aspects of, Lord Montagu of Beaulieu, 469
- Tree: Diseases, Manual of, Dr. W. H. Rankin, 577; -growth, Climatic Cycles, etc., Prof. Douglass, 562
- Trichodynamics, Dr. W. Lawrence Balls, 777
- Trioxymethylene: in Powder, The Use of, for the Destruction of the Larvæ of Mosquitoes, E. Roubaud, 604; The Mode of Action of Powdered, on the Larvæ of Anopheles, E. Roubaud, 667
- Trobridian Islands, The Economic Pursuits of the, Dr. B. Malinowski, and others, 564
- Tropical: Agriculture, A College of, 153; Control of Australian Rainfall, E. T. Quayle, 152; Departments of Agriculture, with Special Reference to the West Indies, Sir Francis Watts, 344; Medicine, 33
- Tsetse-Fly Problem, The, R. W. Jack, and others, 503
- Tubercle Bacillus: Culture of the, on a Medium of Autolysed Yeast, R. Sazerac, 795; The Chemical Composition of the, A. Goris, 604
- Tuberculosis, particularly in connection with the War, 558
- Tungsten: and the Oxides of Tungsten, Reversible Reactions of Water on, G. Chaudron, 411; Preparation and Uses of, in Incandescent Lamp Filaments, etc., A. B. Searle, 339
- Turbine Steels, The Mechanical Properties of, Dr. W. H. Hatfield and H. M. Duncan, 148
- Turin Academy of Medicine, Award of the Riberi Prize to Prof. G. Vanghetti, 557
- Twins, Influence of the Male on the Production of, Dr. C. B. Davenport, 755
- Tycho Brahe, Dr. J. K. Fotheringham, 672
- Tychonis Brahe Dani Opera Omnia, Edidit, I. L. E. Dreyer. Tomus VI, 672
- Typhus Fever, 81
- Ultra-Violet, Extreme, Some New Spark Spectra in the, L. and E. Bloch, 27
- Union Observatory, The, Johannesburg, Circular No. 17, 759
- U.S.A.: Increased Demand for Collegiate Education in the, 731; Army, Psychological Examining and Classification in the, Dr. R. M. Yerkes, 705; Bureau of Mines, Dr. F. G. Cottrell nominated as Director of the, 432; Commercial Marbles of the, Physical and Chemical Properties of, D. W. Kessler, 181; Engineering Research in the, A. P. M. Fleming, 598, General Education Board, Appropriations by the, 602; Glass Industry in the, Scientific Research and the, Dr. M. W. Travers, 9; National Academy of Sciences, F. D. Adams, M. E. C. Jordan, F. A. L. Lacroix, H. K. Onnes, Sir David Prain, and S. R. y Cajal elected Foreign Associates of the, 463; National Food Consumption in the, Prof. R. Pearl, 597; National Research Council, Appointment of a Committee on Eugenics, 240; Election of Chairman of Divisions of the, 754; Election of Officers of the, 526; Prof. V. Kellogg, 332; Statistics of School Systems in the, for 1917-18, 841; Sunshine in the, J. B. Kincer, 791

- Universe, The Structure of the, Prof. W. D. MacMillan, 789
- Universities: and the Excess Profits Duty, 686; Research and Brain Waste, Prof. J. C. Fields, 839; The, and the Army, 157; F. J. M. Stratton, 234; The Officers' Training Corps and the, 349
- University: and Higher Technical Education, 509; Benefactions, The Permanent Value of, Prof. Karl Pearson, 501; College, London, the Engineering School of, Scheme for Extension of, Prince Arthur of Connaught, and others, 113; College of South Wales and Monmouthshire, J. W. Scott appointed Professor of Logic and Philosophy in the, 537; Extension, Public Discussion and Information Service of, 762; Grants, 701; Sir M. E. Sadler, 740; Principal C. Grant Robertson, 774; Prof. W. H. Perkin, 805; of California Publications, Publications of the Lick Observatory. Vol. xiii., 489; of London: The, A Great Opportunity, 381; The, Government Offer of a Site, H. A. L. Fisher, 404; Problem, The, Sir E. Sharpey Schafer, 698; Stipends and Pensions, 477; G. W. O. H., 582; Teachers, Position of, in Relation to the Teachers (Superannuation) Act, 89; Women, First Conference of the International Federation of, 569, 663
- Upper Air, Investigations of the, Dr. van Everdingen; Capt. Cave and J. S. Dines, 663
- Uranyl Salts, The, Fluorescence and Absorption Spectra of, E. L. Nichols, H. L. Howes, and others, 498
- Vacuum Arcs, The Use of, for Interferometry, J. Guild, 842
- Valencies, Partial, The Conjugation of, Prof. R. Robinson, 346
- Vapeur des Mélanges de Liquides: La Tension de, L'Azéotropisme, Dr. M. Lecat. Première Partie, 129
- Vapour Densities, Calculation of, R. G. Durrant, 742
- Vegetation of the Land, The Origin of the, Prof. A. C. Seward, 250
- Veneral: Disease, Disinfection against, 834; Diseases, Portsmouth Borough Council and Prevention against, 335; Special Report on the Prevention of, Dr. A. M. Frazer, 114; Problem, The, E. T. Burke, 543
- Vermiculina polystropha*, Reuss, An Experimental Study of the Foraminiferal Species, and some others; E. Heron-Allen and A. Earland, 282
- Vertebrate: Fauna of North Wales, A Handbook to the, H. E. Forrest, 386; Life in the Late Paleozoic in North America, The Environment of, Prof. E. C. Case, 223
- Vibrating System, Maintenance of a, by Means of a Triode Valve, S. Butterworth, 842
- Vibrations, Notes on the Theory of, W. J. Harrison, 473
- Victoria History of the Counties of England, Issue in Parts of the, 305
- Vinci, Leonardo da, E. McCurdy, 307, 340
- Vine, Cultivation of the, in America, V. G. Jackson, 674
- Viscometer, A Simple, A. G. M. Michell, 344
- Viscosity of Colloidal Solutions, The, P. Barry, 539
- Viscous Retrogression, Torsional, An Example of, C. Barus, 667
- Vision, The Physiology of, with Special Reference to Colour Blindness, Dr. F. W. Edridge-Green, 575
- Vital Statistics: An Introduction to the Science of Demography, Prof. G. C. Whipple, 131
- Vitamines: for the Culture of Bacteria, R. Legroux and J. Mesnard, 315; in Clinical Medicine, The Present Position of, Prof. F. Gowland Hopkins, 722; in their Relation to Health, Col. McCarrison, 557; Necessary to the Development of Plants? Are, A. Lumière, 795; The Chemical Isolation of, C. M. Myers and C. Voegtlin, 667
- Vocal Notes, Photographs of Seven, Dr. W. Perrett, 39
- Volcanic Rocks in the Anglo-Egyptian Sudan, Dr. G. W. Grabham, 199
- Volumetric Testing of Scientific Glassware, 120
- Waage's Phytochemical Synthesis of Phloroglucin from Glucose, Dr. M. Nierenstein, 391
- War: History of the Great, based on Official Documents. Naval Operations. Vol. I., Sir J. S. Corbett, 546; Problems, Some Applications of Physics to, 237
- Warble-lies, Lateral Spiracles in the Larvae of, Prof. G. H. Carpenter and F. J. S. Pollard, 835
- Warlike States, The Origin of, W. J. Terry, 442
- Washington, Ambassador Extraordinary and Plenipotentiary in, Sir Auckland C. Geddes appointed, 17
- Wasps, W. F. Denning, 328
- Water: -chambers, The Permanent Régime in, C. Camichel, 314; Power Resources Committee, Second Interim Report of the, 556, 705; Power Development, Canadian, L. G. Dennis, 311; Resources, The Control of, 705; Supply Papers of the United States Geological Survey, 434; Supply, Woods and, Dr. H. R. Mill, 158
- Wave: -length of the Oscillations Generated by an Ionic Valve due to Changes in Filament Current, Variation of, J. H. Vincent, 121; -lengths of a Line of the Cyanogen Band in the Light of the Sun and that of a Terrestrial Source, Comparison of the, A. Perot, 794; -motion in a Deep Canal, Integration of the Equation of, H., U. Cisotti, 843
- Waves, Growth of, A. Mallock, 777
- Wealden Flint Culture from pre-Palaeolithic Times, Evolution of, H. Morris, 431
- Weather: and Climate of the British Isles and North-west Europe, Practical Exercises on the, W. F. Stacey, 133; and Crops, Periodicity in, Sir William Beveridge, 370; Changes, Effect of, on Soil Temperatures, Capt. T. B. Franklin, 282; Conditions, Local, at Mullion, Cornwall, Lieut. N. L. Silvester, 281; Forecasts and Meteorology, A. Mallock, 580; Notes of Evelyn, Pepys, and Swift in Relation to British Climate, Capt. C. J. P. Cave, 393; of 1919, The, 243; of the Spring Season, The, 498; Prediction, Utilisation of Cirrus Clouds for, G. Reboul and L. Dunoyer, 251; Solar Variation and the, Dr. C. G. Abbot, 678
- Weights and Measures, British and Metric Systems of, M. E. Yeatman, 355; A. S. E. Ackermann, 456
- Welfare Work, 55
- West: Bromwich Municipal Technical Institute, E. Rawson appointed Principal of the, 698; Indies, Agricultural Development in the, 344; Distribution of Littoral Echinoderms of the, H. L. Clark, 279; Report of the Tropical Agricultural College Committee, 153; The Geology of the, 24
- Western: Australia, A Coloured Geological Map of, 498; Royal Society of, Journal and Proceedings of the, 1918-19, 559; The Aborigines of, G. O. Neville, 248; Greece, The Hydrocarbon Zone of, C. A. Kténas, 251
- Whale, Sperm, Two Embryos of the, Dr. F. E. Beddard, 275
- Whales Frequenting South African Waters, Dr. L. Péringuey, 507
- Wheat: and Wheat-growing, Dr. E. J. Russell, 224; Essays on, Prof. A. H. R. Buller, 224
- Wild Life in Canada, Capt. A. Buchanan, 426
- Will? Is there a General, M. Ginsberg, 155; The Freedom of the, The Zoroastrian Doctrine of, Prof. A. V. W. Jackson, 763
- Wind at Kimberley, A Possible Lunar Influence upon the Velocity of the, J. R. Sutton, 700
- Wines, Blue Casse of, Treatment of the, A. Piedallu, P. Malvezin, and L. Grandchamp, 442
- Wireless: Licences for Experimental Work, The Post Office and, 80; Messages from Paris and Slough, 80; Signals, Mars and, 276; Station for Astronomy, Central, Major W. J. S. Lockyer, 454; Telegraphy, Device for Obviating the Use of High Voltages in, L. M. Hull, 624; Longitude by, Prof. Sampson, 370; to America, Reduction of Charges for, 18; and Telephony: First Principles, Present Practice, and Testing, H. M. Dowsett, 483; for Use in the Army, 528; The Thermionic Valve in, Prof. J. A. Fleming, 716; Telephony, Prof. W. H. Eccles, 519; Duplex, Application of, to Aircraft, Capt. P. P. Eckersley, 154; in Aeroplanes, Major C. E. Prince, 55; to and from Aeroplanes, and Wireless Direction-finding Apparatus, Demonstration of, 145; Time-signals, Eiffel Tower, Prof. R. A. Sampson, 205; Transmission of Photographs, M. J. Martin. Second

- edition, 451; Weather Forecasts for London and South-East England, 465
- Wood, Treatment and Preservation of, 401
- Woods and Water Supply, Dr. H. R. Mill, 158
- Woolwich: The Research Department, Sir Robert Robertson, 710, 743; Exhibits of the, at the Imperial War Museum, 622
- Wound-shock, The Circulating Blood in Relation to, Prof. W. M. Bayliss, 9
- Wright, Wilbur, Unveiling a Statue to the Memory of, 654
- Xenolithic Tertiary Minor Intrusions in the Island of Mull, Certain, Dr. H. H. Thomas, with Chemical Analyses by E. G. Radley, 473
- Xenopus laevis*, The Reflex Times in, W. A. Jolly, 699
- X-ray: Spectra, The Fine Structure of, M. de Broglie, 475; Tube Stands, Manipulation and Precision in Adjusting, 625
- X-rays: of the L Series, The Intensities of, D. L. Webster, 667; The Examination of Materials by, A General Discussion held by the Faraday Society and the Röntgen Society, April 29, 1919, 132
- Year-book of the Scientific and Learned Societies of Great Britain and Ireland, The, Thirty-sixth Annual Issue, 580
- Yorkshire Summer School of Geography, Forthcoming, 185
- Zeeman Effect in Furnace Spectra, The, A. S. King, 599
- Zinc: and Copper, The Constituents formed by Reciprocal Penetration of, at a Temperature where One of the Two Metals and all their Alloys are in the Solid State, H. Weiss, 699; and its Alloys, Dr. T. E. Lones, 193; Copper Minerals, Rare, from the Rhodesian Broken Hill Mine, F. P. Mennell, 569; in the Human Organism, S. Giaya, 315; Metallurgy of, Reactions of the, M. Lemarchands, 282
- Zonal Deposition, 498
- Zoological Bibliography and Publication, Recommendations of the British Association Committee on, 724
- Zoology: Elementary, A Manual of, L. A. Borradaile. Third edition, 804; Practical, A Junior Course of, the late Prof. A. Milnes Marshall and the late Dr. C. H. Hurst. Ninth edition, revised by Prof. F. W. Gamble, 516

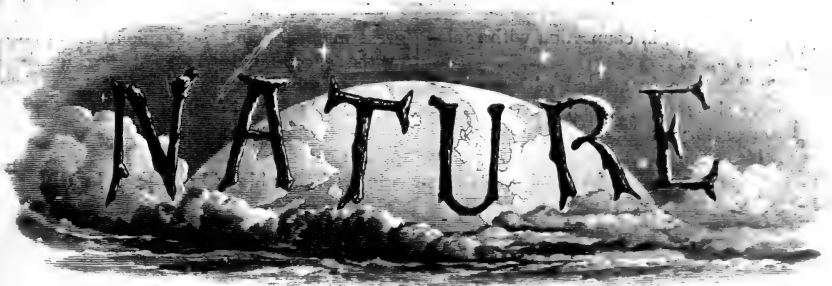

A WEEKLY ILLUSTRATED JOURNAL OF SCIENCE.

"To the solid ground  
Of Nature trusts the mind which builds for aye."—WORDSWORTH.

THURSDAY, MARCH 4, 1920.

Knowledge and Understanding.

Science and Life: Aberdeen Addresses. By Prof. Frederick Soddy. Pp. xii+229. (London: John Murray, 1920.) Price 10s. 6d. net.

Hear, Land of Cakes and brither Scots,  
Frae Maidenkirke to Johnny Groat's;  
If there's a hole in a' your coats,  
I rede ye tent it;  
A chiel's awn ye takin' notes,  
And, faith, he'll prent it.

PROF. SODDY, who has recently removed from the chair of chemistry in the University of Aberdeen to the newly created Lee's professorship of inorganic and physical chemistry in the University of Oxford, is well known throughout the scientific world by reason of his work in connection with the subject of radio-activity, to which he has made very important contributions. But it was not suspected, at least generally, that from his northern post of observation he was finding so many holes in the coats of the inhabitants of that part especially, and of the institutions of the country generally, and that he would "prent it." Yet here is a volume which bears as sub-title "Aberdeen Addresses," the delivery of which must have caused many of his "unco' guid" neighbours to sit up and perhaps *furieusement à penser*. But, as the old clerk in "Silas Marner" said: "Where's the use o' talking? You can't think what goes on in a cute man's inside."

We must all agree with the author in the view that "the times seem to call for outspokenness, if one has anything to say, rather than persuasive propagandism and time-serving compromise. It may be recalled that scientific men have, for nearly a century, pointed out the dangers to the nation of the traditional school and university training, disastrous especially in that it embraces

even those who are to be its rulers and statesmen." So Prof. Soddy has spoken out with a voice which is bound to be heard even by those who, having no ears to hear, or understanding to learn, cannot help catching the echoes of this new trumpet-call.

The essays may be broadly divided into two groups, of which one contains an exposition of the marvellous disclosures concerning the physical constitution of matter which have absorbed the concentrated attention of so many physicists during the last twenty years, while the second group, addressed to various audiences, shows the bearing of modern scientific discovery on the philosophies hitherto prevalent.

Let us glance first at the former set of essays. For nearly a century the atomic theory of Newton and Dalton had been accepted by chemists as the almost undisputed basis of their theoretical conceptions, and for all ordinary chemical phenomena the atom is still the fundamental unit of mass. Views as to the nature of the atom and its constitution now assume a different form. It is as though an observer, looking along a street, having formerly supposed each house to consist of a solid mass of bricks, now finds out that each contains many chambers and inhabitants capable of moving about. This knowledge has been obtained in two ways. By bombardment the constituent materials and inhabitants have been distributed in various directions, and in a strange, unaccountable way the inhabitants of certain houses escape from them carrying away portions of the fabric, which is thus gradually led to tumble down. The metaphor can be carried no farther, but is sufficient to remind the reader of the conceptions gradually introduced as the result of experimental work carried on first by Crookes, and later especially by Sir Joseph Thomson, and, on the other hand, by the discoveries of

Becquerel and the Curies in connection with radio-activity.

Prof. Soddy has been associated with research on radio-activity since 1901, when, in Sir Ernest Rutherford's laboratory in Montreal, he joined in framing the idea which attributes radio-active change to the spontaneous disintegration of the atom. Later, in conjunction with Ramsay, he proved that the  $\alpha$ -particles escaping from radium are electrified atoms of helium. In 1913 he also traced, simultaneously with other observers, the nature of the successive changes in radio-active matter which ultimately lead to the production of non-radio-active elements, of which the best-known case is lead. The whole story is told in a condensed form in several of the essays in this volume, and it could not be told better. Those who are interested in such subjects should obtain the book and read it.

Turning, now, to the remainder of the contents of this volume, so many questions are touched on of which many would be regarded as debatable that it seems probable that readers will be divided into two camps, those who would cordially approve and support the views set forth, and those, chiefly the orthodox, who would deeply resent the attitude and conclusions of the writer. The first article, entitled "Science and Life," deals with the influence which scientific discovery has exercised on the conditions of modern life, seen from various points of view, and contains little that is seriously controversial. There are, of course, passages which seem a little over-enthusiastic—e.g. the statement that, "if not yet, some time in the future, the synthesis of food from the material constituents and any form of available energy will probably become possible"—but the review given of the sources of energy in Nature is useful as popular instruction. The author's remarks on the relations of brains, labour, and capital seem rather to belong to the views likely to find expression at the meetings of a young men's debating society, though it is certainly true that "the exploiters of the wealth of the world are not its creators," and is likely to remain so until human nature undergoes a profound change. A similar remark might be made on the question which occurs in the second article: "Physical force, the slave of science, is it to be the master or the servant of man?"

Of course, Prof. Soddy has a good deal to say on the subject of education. He is an experienced and distinguished teacher, but in one direction he seems to overlook the necessity for clearly differentiating the kind of general education which must necessarily be provided wholesale for the

great majority, and that which should be adapted to the exceptional youth, the genius, that *rara avis* for whom is wanted more in the shape of opportunity than in direct instruction along lines which may or may not be useful to him. The great difficulty in regard to this kind of student is to recognise his qualities early enough. In connection with the continued appropriation of more than their due share of scholarships, emoluments, and facilities of all kinds by the authorities and powers which claim to represent humanist interests at the schools and universities, everyone concerned with such matters remembers Prof. Soddy's criticism of the action of the executive committee of the Carnegie Trust for the Universities of Scotland in January, 1918, and the inadequate reply thereto. The whole of the relevant papers are added to this volume in a series of appendices A, B, and C.

Many people will find the lecture given to the Aberdeen University Christian Union on "Matter, Energy, Consciousness, and Spirit" among the most startling of the utterances contained in this book. There are still many serious religious persons who find the almost universal abandonment of the Mosaic account of Creation and of so many of the Hebrew legends disturbing to the whole of their Christian faith and subversive of all religion. But the religious reader may get some comfort from this chapter if he will read it thoughtfully and with prejudice discarded as much as possible. Truth in the realm of science is of a quality and nature quite its own, and the man of science who frames a hypothesis does so in the knowledge that, while it responds to every test applied to it up to that moment, it may be modified by further discovery or absorbed into and covered by a theory of a more comprehensive character. The continuous advance of knowledge proves, however, that the foundations have been well and truly laid. "The scientific man seeks truth as a continually developing revelation, and he changes his outlook on the world according as it unfolds itself before his eyes. The priest teaches that in some remote period of the world God Himself revealed Truth once and for all time, and his profession is to guard it against all comers. I do not believe that the soul, any more than the mind, can stagnate. It must grow or decay. Christianity cannot be crystallised into a creed binding for all time, and least of all into a creed dating back to the century that preceded the relapse of Europe into intellectual barbarism. The world changes and has changed in the last hundred years out of all recognition . . . on account of the new revelations of science, though these have come about by a process the reverse

of supernatural. . . . They constitute an essential part of the whole truth, be our religious convictions what they may."

And there we must leave this interesting volume to the judgment of the many readers who will certainly be attracted by its contents.

W. A. T.

### A Natural History of the Feelings.

*The British Journal of Psychology: Monograph Supplements. No. vi. Pleasure—Unpleasure: An Experimental Investigation on the Feeling-Elements.* By Dr. A. Wohlgenuth. Pp. vii+252. (Cambridge: At the University Press, 1919.) Price 14s. net.

WHAT the psychologists of the Würzburg school have so largely done for the thought processes, Dr. Wohlgenuth has here attempted for the feeling-elements of the mind. The investigation consists essentially of a lengthy series of introspections on the affective states produced by various sensory stimuli—given singly or in combination—carried out by four trained observers under strictly experimental conditions, the data thus obtained being submitted to a detailed consideration and analysis, and eventually summarised and expressed in seventy-seven rules. These rules, the author maintains, may be regarded as a first step towards the building up of a natural history of the feeling-elements—a task which should precede any systematic attempt at theorisation or at the application of the psychology of feeling to practical life.

A novelty in the presentation as regards work of this kind consists of the fact that the data from which the conclusions are drawn (*i.e.* the protocols of the observers) are recorded in full, occupying the largest portion of the book (137 closely printed pages), references in the margin indicating passages in the protocols from which the subsequently stated conclusions have been drawn. From the purely scientific point of view, this procedure has everything to recommend it. There exist no well-recognised and trustworthy methods of summarising introspective data, such as there are, for instance, in the case of purely quantitative results, and the presentation of the complete material enables the reader and critic to control at each step the author's conclusions, or to draw new and independent conclusions of his own, in a way that would not otherwise be possible. The opportunity of studying the observers' gradually increasing power of analysing and describing the fleeting affective contents of the mind should, moreover, be welcome to all who are interested in the possibilities of the modern

method of exact introspection in psychology. On the other hand, the inclusion of the full data has increased by not a little the size (and doubtless also the cost) of the present work.

It is impossible to summarise adequately the wealth of conclusions arrived at from the study of the protocols. A very few only of the more salient points can be mentioned here. The observers find that "the feeling-elements are not attributes or functions of sensations or other cognitive processes, but a separate class of conscious processes. Although generally closely dependent upon the cognitive and conative processes to which they belong, they often show a certain independence and detachment." The feeling-elements possess two qualities only—pleasure and unpleasure, this result supporting the more common view as against the multi-dimensional theories advanced by Wundt and certain others. Unpleasure must be clearly distinguished from pain, which is not a feeling, but a sensation—"a sensation of a definite modality whose feeling tone is mostly unpleasant, but which may be neutral or sometimes even pleasant."

As regards the much-disputed question concerning the possibility of the co-existence in consciousness of distinct feeling-elements, some fairly strong evidence is brought in favour of such co-existence, the co-existing feelings being either of the same quality (*i.e.* both pleasant or unpleasant) or of different qualities (*i.e.* one pleasant, the other unpleasant). There are, however, important individual differences in the ease and frequency with which such co-existence can be observed.

A further disputed question—that of the localisability of the feelings—is also answered in the affirmative, the localisation of feelings being closely dependent on the observer's power of objectifying the feelings in question. In this connection it is interesting to observe that "the behaviour of feeling-elements is inverse to that of sensations in this way, that whilst sensations of the auditory and visual senses are more readily objectified than those of other senses, the feeling-elements when belonging to the former are less readily objectified and localised than when they belong to the latter."

An important difference between feeling and sensation was found in the fact that "there is nothing on the affective side of consciousness to correspond with the memory image on the cognitive side. The memory of a past feeling-element is merely knowledge—*i.e.* solely cognition. The affective experience attaching to an ekphored [*i.e.* recalled] cognitive experience is a new feeling-element, a new pleasure or a new unpleasure."

Another difficult point on which much light is thrown concerns the influence of attention upon feeling. At first individual differences were discovered which corresponded to the opposing views that have been held on this subject. It was found, however, that these differences resulted merely from a difference of attitude. "If a feeling-element is attended to as belonging to a cognitive content or as part of a situation or complex, it is intensified and becomes clearer; but if an attempt be made to focus the attention upon it to the exclusion of its cognitive concomitant, the feeling-element is destroyed." On the other hand, the feeling-element is also destroyed, or at least weakened, if attention is directed exclusively to the purely cognitive aspects of an experience.

Many of these results and of the others which we have no room to mention here have a practical as well as a theoretical interest, and the author anticipates that, as a result of the further study of the feelings, we shall be able to formulate canons in order to increase pleasure and reduce unpleasure, to evolve, in fact, a normative science of kalobiotics.

The book contains little or no theory, confining itself almost entirely to an elaborate statement and discussion of the experimental results. As such it makes, perhaps, a greater demand on the reader's powers of concentration and endurance than is the case with most of the works that have hitherto appeared on this subject. Nevertheless, it constitutes fairly certainly the most complete and satisfactory study of feeling from its own point of view, and is one of the most important existing scientific contributions to this aspect of psychology.

### Radiological Diagnosis of Disease.

*Radio-Diagnosis of Pleuro-Pulmonary Affections.* By F. Barjon. Translated by Dr. James A. Honeij. Pp. xix + 183. (New Haven: Yale University Press; London: Humphrey Milford; Oxford University Press, 1918.) Price 10s. 6d. net.

THE author points out that the perfecting of the instruments used in radiological examinations has changed a process regarded at first as a mere curiosity into a useful scientific and practical method. Radiology has gradually extended its province in an extraordinary manner. It has entered the physiological and pathological study of all the important organs. In lesions of the lungs and pleura the radiologist can determine the topography of the trouble in a manner aptly called by Claude Bernard "a living autopsy." No other method of exploration demonstrates so clearly and

simply the functions of the heart and lungs. It shows, without the cardiograph, the pulsations of the auricles and ventricles and the aorta. It estimates, without the spirometer, the respiratory value of the lungs, and shows the movements of the diaphragm, the intercostal spaces, and the displacement of the mediastinum in inspiration and expiration.

The author shows that the radiological method should not be used alone, but always in conjunction with other methods. "The radiologist must be a physician. The interpretation of X-ray results demands a very accurate knowledge of anatomy, physiology, and pathology." Conversely, it is well also for the physician to be, in a less degree, a radiologist.

The book contains a very full and complete account of the radiological appearances of the diseases of the lungs and pleura, with many valuable hints to help the observer from falling into errors of diagnosis. The subject of pulmonary tuberculosis is discussed in full detail. The perusal of this section leaves no room for doubt as to the extreme importance of the X-ray method in the diagnosis of this disease. Even in the early stages the exact position of the lesion is clearly shown, and its extent revealed. The progress of treatment, also, can be followed; in successful cases the gradual clearing of the affected portions of the lungs can be studied.

The last part of the book deals with penetrating wounds of the thorax by war projectiles. It shows how the nature of the projectile is to be recognised, how its exact situation within the thorax is to be localised, and how the radiologist may aid in deciding whether operative interference is advisable or urgently needed.

The book is printed in good type, and profusely illustrated by diagrams in the text and by half-tone reproductions of X-ray prints and negatives in plates printed on art paper.

### The Manufacture of Artificial Fertilisers.

*Mining and Manufacture of Fertilising Materials, and their Relation to Soils.* By Strauss L. Lloyd. Pp. vi + 153. (New York: D. Van Nostrand Co.; London: Crosby Lockwood and Son, 1919.) Price 9s. net.

THERE is at present no good book in English on the manufacture of artificial fertilisers, but there is ample room for one. Mr. Lloyd does not quite supply the need. He evidently knows something about the mining and working of Florida phosphate rock and the making of superphosphate, but instead of giving a clear description of all this, illustrated by diagrams, he occupies



valuable space with an account of soils and soil analysis which the reader could far better obtain elsewhere. Yet there is scarcely a more vital industry at the present time than the manufacture of artificial fertilisers, nor is its importance likely to diminish.

The best chapters are the two on pebble phosphate and on hard-rock phosphate. The Florida phosphates are usually classified into four groups: hard rock, soft rock, land pebble, and river pebble, all of which occur in the Eocene and more recent formations. Of these the hard rock is the purest, containing phosphate equivalent to 80-85 per cent. of dicalcic phosphate; the land pebble contains somewhat less, while for the soft rock and river pebble the corresponding figures are about 55 to 68 per cent. The method of working is fairly well described. The remaining chapters, however, are not so good. More information might have been given about the mechanical dens and other contrivances used in the manufacture of superphosphate. Scarcely anything is said about the manufacture of mixed manures, although this is one of the largest branches of the business. The chapter on the fixation of atmospheric nitrogen is some years out of date; no mention is made of the Haber or the Ostwald process; the old view, now given up elsewhere, is still put forward, that cyanamide changes to "dicyanamide" (dicyanodiamide) and then to ammonia by bacterial action.

Should a second edition be called for, the author would be well advised to omit the chapters on soil and the science of manuring. It might also be wise to ask a chemist to read the proofs in view of his gibe about treatises on agricultural analysis with methods which the student "would have to unlearn if he entered a fertiliser factory, where he would have to analyse manures against chemists of some reputation." The reader would thus be spared some interesting specimens of chemistry which we hope are not typical of the new chemistry given in American fertiliser factories in place of the unlearned college work, such as:—

"The sodium chloride decomposed by the free phosphoric acid caused the bags to burst in transit, for there is no substance which rots bags like free chlorine and fluorine—two elements given off when nitrate and damp superphosphate are mixed."

E. J. RUSSELL.

### Our Bookshelf.

*Telephony without Wires.* By Philip R. Coursey. Pp. xix+414. (London: The Wireless Press, Ltd., 1919.) Price 15s. net.

This book gives a fairly complete account of the practical development of radio-telephony. Accurate descriptions are given of very many types of

apparatus. The book, therefore, is more useful for reference than for learning the principles of the art. Little space is devoted to theoretical considerations, but the author mentions some of the difficulties encountered, and indicates possible lines of advance. The bibliography is very complete, some 700 references being given to original papers on the subject.

From the commercial point of view, radio-telephony is not very attractive at present, as its applications are mainly confined to those cases where the ordinary telephone service cannot be used. It is possible by using very costly apparatus to telephone on land over thousands of miles. For instance, New York and San Francisco were put in telephonic communication in November, 1917, although the distance is 3400 miles. The experiment was successful, but it did not prove the commercial feasibility of such a long-distance service, as the value of the apparatus in use when talking was 400,000l.

Radio-telephony was very useful in the later months of the war, as communication was established by its use not only between aeroplanes and the earth, but also directly between aeroplanes. It has also proved useful in establishing communication between moving trains and the ordinary fixed telephone systems. During the last few years the rapid development of radio-telephony has been mainly due to the researches of the physicist and the mathematician. The problems it furnishes are of absorbing interest, and it is rapidly widening our knowledge of the laws of Nature.

*Scientific Method: Its Philosophy and its Practice.*

By F. W. Westaway. New edition. Pp. xxi+426. (London: Blackie and Son, Ltd., 1919.) Price 10s. 6d. net.

SIR J. J. THOMSON'S committee on the position of natural science in the educational system of Great Britain expressed agreement with the view that "some knowledge of the history and philosophy of science should form part of the intellectual equipment of every science teacher in a secondary school." There is no more enlightening and helpful volume from which to acquire such knowledge than this by Mr. Westaway. The implications of scientific reasoning, method, and practice are clearly presented, and the examples are both apt and instructive. Any science teacher, whether in university or school, who reads the book cannot fail to derive profit and interest from it.

In this second edition the chapter on "Philosophers and Some of their Problems" has been re-written, and is now a more precise statement of the specific claims of philosophy than was the chapter in the original issue. A new appendix, entitled "Retrospect and Reflections," surveys the function and influence of science and scientific method in national life, superseding one on "An American School Course in Chemistry." The index is missing in our copy of the book, though there was one in the first edition, but its absence is possibly due to a fault of the binders.

### Letters to the Editor.

[The Editor does not hold himself responsible for opinions expressed by his correspondents. Neither can he undertake to return, or to correspond with the writers of, rejected manuscripts intended for this or any other part of NATURE. No notice is taken of anonymous communications.]

#### Organisation of Scientific Work.

THE relations between scientific inquiry and constituted authority, whether ecclesiastical or civil, have seldom been cordial or wholesome. Science was once a fearful dragon, to be destroyed or confined. With the discovery that the beast had powers from which profit could be made by cunning masters, it was found more expedient to tempt him into harness. Our former state was probably the better, or at least the safer, and most of us will agree with Prof. Soddy that the scheme devised by the Indian Industrial Commission is simply an offer of servitude undisguised. While there is time, those with whom the decision rests should be told very plainly that the adoption of such rules of service as those quoted in the leading article in NATURE of February 19 must mean the alienation of all sincere and genuine investigators.

Research, like art, literature, and all the higher products of human thought, grows only in an atmosphere of freedom. The progress of knowledge follows no prescribed lines, and by attempting such prescription the head of a Service would merely kill the spontaneity and enterprise of his workers. No one fit to be entrusted with research worthy the name would undertake it knowing that his results might be burked or withheld from publication at the whim of his superior in the Service. Such conditions may be appropriate to certain forms of technical or industrial invention, where the sole purpose is to get ahead of a trade rival, but we can scarcely imagine that the vast and manifold undertakings promoted by the scientific services of the Indian Government are to be conducted in that spirit.

W. BATESON.

The Manor House, Merton, S.W.10.

I HOPE you will allow me to express through the medium of NATURE my concern at the proposal referred to in the leading article in the issue of February 19 to centralise in an Imperial Department the various scientific services in India—a policy which I believe to be likely to prove detrimental to good work. I was a member of the Indian Forest Department during the years 1871-99, so that my Indian experience is not very recent, but I have kept myself informed of what was going on. Since I left India research institutes have been established in different provinces with officers attached to them required to devote themselves to the study of scientific questions. In my opinion, it is of the utmost importance that these officers should have as free a hand as possible, and be allowed to work in their own way on the subjects which they know themselves most competent to study. If they are called upon to work under a centralised Department, and perhaps to turn from branches of study which they thoroughly understand to others in which they may have to begin by reading up, much of their time will be wasted and the results poor.

A centralised Department, to most people of Indian experience, means many reports and returns and constant correspondence, and I believe the result of such an innovation will be that some hours at the beginning of each day will have to be spent on what may be called "clerical duties." If a scientific worker is to do his best, he must be able to spend

all his time on his researches, and not be obliged to waste much of the day on clerical duties, only beginning his real work when tired and unable to do his best.

Centralisation will also mean, in my opinion, the spending of much money in keeping up clerical staffs, which, as most Indian officers will admit, have a wonderful tendency to increase. It will be much better that the recommendations of the last paragraph but one of your leading article should be followed and the money spent in giving financial assistance to the universities and research institutes instead. The paragraph to which I refer puts the arguments for the continuance of the present system and its better development excellently in a few words, and I trust it may have the effect on the administrative authorities that I feel sure it must have had on the scientific men who have read it.

J. S. GAMBLE.

Highfield, East Liss, Hants, February 25.

I HAVE not yet had time to study the Report of the Indian Industrial Commission, and may, therefore, be ignorant of some of the arguments for centralisation, but I am certainly in general agreement with the views expressed in the leading article in NATURE of February 19, and by Prof. Soddy and Dr. Rendle in the issue for February 26, regarding the dangers of that method of research organisation. Investigations under centralised bureaucratic control must almost always be concerned solely with questions capable of receiving easy and immediate replies, for the obvious reason that directors and committees can rarely be persuaded to authorise attacks upon difficult or distant objectives, regarding which, perhaps, no replies at all may be forthcoming. Now the most important discoveries have generally been made precisely by such attacks, and investigation is a lottery in which the greatest prize often falls to him who takes the greatest risks. Directors and committees do not like risks, and, consequently, seldom make discoveries. I should like to know, for instance, how any "Indian Scientific Service" would have attacked the malaria problem, which I commenced to assault (in a very foolhardy manner!) in 1890. I am sure it would have refused to authorise my attempts, and even to publish my first results. On the other hand, it would have wasted, with ripe bureaucratic prudence, thousands of pounds in looking for Plasmodia in marshes, or in trying to correlate various species of mosquitoes with local outbreaks of the disease, and I am sure it would have achieved nothing at all up to the present day.

We forget that, like really valuable art and invention, scientific discovery is almost always due mainly to the individual. One might as well try to organise an Institute for the Writing of Poetry as institutions for making great discoveries or inventions. Like art, discovery is creative. It depends much more on the brain than on the hand, even in work requiring the most careful manipulative skill. Scientific services will not be able to pick up "discoverers" on every bush. All they can do is to organise hand-work, for which they may be useful. But if the Government of India wishes to obtain great results for its expenditure it must buy genius. Now genius may be defined as the quality which achieves success, and the only way to buy it is to reward success—as suggested by the Committee on Awards in NATURE of January 8. What we all fear is that the Government of India will be tempted to spend much larger sums of money in buying, not genius, but its opposite.

At the same time certain researches, even of a petty kind, will require subsidies, and the Government

ought also to possess expert advisers in many branches of science. Some kind of scientific service will therefore be needed, but this should not be allowed to engross the whole field; and the best results are sure to be obtained in the future, as they have been in the past, by untrammelled men of capacity working as they please.

RONALD ROSS.

In discussing the best ways of fostering research work it is important to remember that the word "research" is used in two widely distinct senses: it may stand either for the careful collection of observations, or for the deduction of the principles expressing the relationship between one set of phenomena and another. The difference between them is like that between the discovery of a new country and the careful mapping of one known in a general way but not in full detail.

It would be unfair to set either of these kinds of research above the other; each is indispensable to the other. Experience shows, however, that the power to collect careful observations can be imparted to a large number of men and women, while the power to utilise the material and deduce from it anything more than the comparatively obvious is rare and cannot be imparted. Further, this ability is not equally divided as between different classes of men or as between men and women.

The recognition of the necessity for each kind of ability is essential to the proper conduct of a research institution, and one of the great difficulties is to find deducers of new ideas and to ensure that they shall work harmoniously with the equally necessary, but less rare, collectors of observations. The difference between the two groups of workers is fundamental and far-reaching, manifesting itself even in trivial daily actions. One difference is particularly important for the present discussion: the first group greatly resent immediate direction; the second do not, provided they see advantages therein. In all research institutions of any size the chief problem is to keep both groups of workers as nearly abreast as possible. Deductions made in advance of facts are often wrong and sometimes harmful. Facts and observations accumulated without any illuminating hypothesis or general principle are rather dreary and soon forgotten. It is one of the tragedies of a life devoted to science that so often the fruit falls stillborn and is entombed in some journal, never again to see the light. We have all known such workers:

And, as year after year  
Fresh products of their barren labour fall  
From their tired hands, and rest  
Never yet comes more near,  
Gloom settles slowly down over their breast.

The only way of avoiding the tragedy and its accompanying waste is to ensure that both groups of workers keep together.

It is not only between these two groups, however, that co-operation is necessary; under modern conditions there must also be close relationship between the workers in different subjects. Science is becoming increasingly specialised; no one man now knows much of any subject except his own. For the investigation of phenomena such as those of agriculture, which lie outside the present arbitrary divisions of science, recourse must be had to team-work; a body of young workers whose minds are still elastic must be interested in the problem and induced to work together for its solution.

Experience shows that successful co-operation is achieved only when a deliberate attempt is made to secure optimum conditions for each individual worker.

How can a State system be adapted to fit these various necessities? For financial reasons complete elasticity is impossible; Treasuries must know their liabilities. In any Civil Service system promotion is almost inevitably by seniority. Individual action and thought would be intolerable; everything must go through a chief, while anything repugnant to him must be suppressed. In all these directions the State system is absolutely incompatible with living research, although it might be consistent with much careful accumulation of facts, with survey work, and with the establishment of some central collecting institute. For these reasons I cannot believe that the intensely centralised system proposed for India could succeed. One man may organise work in one institution where he is accessible to the staff morning, noon, and night; but he would indeed need to be a superman of most exalted degree if he aspired to direct the research work of a country.

The system devised by the English Ministry of Agriculture is, in my view, much better. It possesses some degree of financial elasticity. While it contains the inevitable regulation about promotion by seniority, this is qualified by clauses under which the best man available can, nevertheless, be appointed to fill a vacant post. There is no attempt to govern from Whitehall; no general director, deputy director, or other official to run the research workers, but only occasional friendly gatherings of the chief officers to discuss common problems. Could not some such system be tried in India?

E. J. RUSSELL.

Rothamsted Experimental Station, Harpenden.

THE question of reorganising and developing scientific work in India discussed in the leading article in NATURE of February 19 is of the utmost importance to all concerned with the welfare and scientific reputation of the Empire. Now that there is a prospect of recognition by the Government of India and the Secretary of State of the necessity for increased expenditure on scientific investigation, it is essential that the new era should be inaugurated under the most favourable conditions. Two policies are apparently under consideration, which may be referred to respectively as centralisation and decentralisation; these are clearly defined in the article of February 19. The advantage of organising research within certain limits is generally admitted; facilities should be afforded for supplying information, for suggesting problems, and for the co-ordination of the activities of individuals or institutions, but it would seem that the policy of centralisation advocated by the Indian Industrial Commission, presided over by Sir Thomas Holland and "favoured by a number of administrators," is much more than this. It is, in short, a proposal to bring scientific investigation into line with routine official work—a procedure which, one learns with surprise, has the support of several scientific witnesses examined by the Commission. If there is one thing vital for the successful prosecution of scientific research of the best type and for the encouragement of the full development of a researcher's capacity, it is freedom of action.

It is safe to predict that very few men possessing what may be called the research temperament would consent to submit to a bondage that would be not only irksome and irritating, but also fatal to individual initiative and enthusiasm. If adequate remuneration is offered and reasonable laboratory facilities are provided, good men will be easily secured. Given the right sort of men, I venture to think that the only rational course is to trust them to work out in

their own way, with such advice or assistance as may be asked for, the problems entrusted to them.

The appointment of a head for each department of science with the powers of a dictator would be the surest means of encouraging mediocrity, and of warning off just that type of original thinker and independent investigator whose services would be of inestimable value to the State. It may be contended that any State scheme, whether concerned with routine duties or original work, must be under some central direction, but there is no reason why the direction should be of such a kind as would be tantamount to asking every researcher to place himself, body and soul, under a dictator.

A. C. SEWARD.

Botany School, Cambridge, February 26.

### The Constitution of the Elements.

In continuation of my letter on the above subject in NATURE of December 18, 1919, several more elements have been subjected to analysis, yielding interesting "mass-spectra."

Argon (atomic weight 39.88 Ramsay, 39.91 Leduc) gives a very strong line exactly at 40, with double charge at 20 and triple charge at 13½. The last line, being closely bracketed by known reference lines at 13 and 14, provides very trustworthy values. At first this was thought to be its only constituent, but further photographs showed an associated faint line at 36. This has not yet been proved an element by double and triple charges, as the probable presence of OH<sub>2</sub> and the certain presence of C prevent this, but other lines of reasoning make it extremely probable that this is a true isotope, the presence of which to the extent of 3 per cent. is enough to account for the fractional atomic weight quoted.

Helium was compared with O<sup>++</sup> (8) by a special system of bracketing, and directly with C<sup>++</sup> (6) by extrapolation. Both methods give its mass as 4, with an accuracy of 2 or 3 parts in 1000.

By the same methods H<sub>1</sub>, H<sub>2</sub>, and H<sub>3</sub> all give consistent results for the mass of the hydrogen atom as 1.008 within experimental error, agreeing with the value given by chemical analysis, and, incidentally, confirming the nature of H<sub>3</sub> beyond doubt. *These three lines are the only ones diverging from the whole number rule to a definite and measurable extent.*

Nitrogen is apparently a "pure" element, its doubly charged atom being 7 exactly.

Krypton (atomic weight 82.92) has no fewer than six constituents: 78, 80, 82, 83, 84, and 86. The last five are strong lines most beautifully confirmed by double- and triple-charged clusters, which can be compared with great accuracy against A (40) and CO (28). These reference lines obliterate one of each group, but not the same one. The 78 line has not yet been confirmed in this way owing to its faintness, but there is no reason to doubt its elemental nature. Krypton is the first element giving unmistakable isotopes differing by one unit only.

The partial pressure of xenon (atomic weight 130.2) in the gas used was only sufficient to show its singly charged lines clearly. These appear to follow the whole number rule, and rough provisional values for the five made out may be taken as 128, 130, 131, 133, and 135.

Further examination of the multiply charged mercury clusters indicate the probability of a strong line at 202, a weak component at 204, and a strong band including 197 and 200, unresolvable up to the present.

F. W. ASTON.

Cambridge Laboratory, Cambridge,  
February 25.

NO. 2627, VOL. 105.]

### Deflection of Light during a Solar Eclipse.

PROF. ANDERSON has suggested in NATURE that the apparent displacement of stars observed during the solar eclipse may be ascribed to an unusual form of refraction in the terrestrial atmosphere. The discussion which has followed shows some lack of agreement as to the importance of such a refraction effect. I wish to suggest that it might, perhaps, be possible to form an estimate of the magnitude of this effect by making measurements of the apparent diameter of the moon during the eclipse. Star photographs would seem to be somewhat unsuitable, although one diameter of the moon may leave a clear enough trace on the plates (a diameter at right angles to the apparent motion of the moon relative to the stars). It should be possible, however, to obtain sharp silhouette images of the moon on plates devoted to this particular purpose; perhaps such photographs are already available. The nature of the clockwork drive needed is dependent on the necessary exposure, and need not be discussed.

J. A. ORANGE.

MR. ORANGE's point is, of course, that we should use the one object in the field of which the light has not been through the sun's gravitational field in order to get rid of the Einstein disturbance; also of the suggested refraction by gases near the sun. I have talked the matter over with Mr. C. Davidson, who agrees with me that nothing is to be done with existing photographs in this direction—the exposures were too long, and the moon's limb too ill-defined; but it is possible that in future eclipses short exposures, given specially for the purpose, might yield something of interest. The chief difficulty is that we do not know the moon's dark photographic diameter. It cannot be assumed equal to the bright photographic diameter, for irradiation (and other similar actions) go in the reverse direction.

A. C. D. CROMMELIN.

55 Ulundi Road, Blackheath, S.E.3,  
February 28.

### Perimeter of an Ellipse.

THE following approximate formula for finding the perimeter of a fairly flat ellipse may be found practically useful. Suppose  $a=1$ , then the length of a quadrant of the ellipse is nearly

$$1 + 0.6b^2,$$

where  $a$  is the major, and  $b$  the minor, axis. The formula works best from about  $b=0.2$  to  $b=0.5$ , after which the formula of Boussinesq is more accurate, viz.

$$\frac{\pi}{4} \left\{ \frac{3}{2}(1+b) - \sqrt{b} \right\}.$$

But the formula I give is for practical purposes quite satisfactory up to  $b=0.6$ , the relative error never being large. It does not work if the ellipse is nearly circular. Boussinesq's formula is of no use if the ellipse is flat.

Other more accurate formulæ could be given, but the above has the advantage that it can be calculated very rapidly, and, within the range mentioned, I doubt if higher accuracy is ever required in practice.

R. A. P. ROGERS.

Trinity College, Dublin,  
February 16.

## Scientific Research and the Glass Industry in the United States.

By DR. M. W. TRAVERS, F.R.S.

THE great American glass works engineer, Mr. Owens, referring to the fact that he had been refused admission to an English glass works, once observed to a friend of mine, "If a man refuses to admit me to his plant I generally reckon that he is ashamed of it." I had often wondered whether Mr. Owens's countrymen really practised the policy which he preached, and last autumn the opportunity offered of putting it to the test. During a seven weeks' tour through the States I paid almost daily visits to glass plants, with no other introduction than the information conveyed by my private visiting card, and only once was my visit restricted to the office. Generally I was shown the whole plant, and all my questions were frankly answered; sometimes I was even permitted to make a second round of the works on my own account. In the research laboratories of both private companies and great industrial corporations I was made doubly welcome. I can only express a sense of obligation, which I can never repay.

It was very frequently that I heard statements made to the effect that the application of science to industry in America was only in its infancy. It is a fact that American industry is absorbing the whole output of the universities, and also drawing men from this country. America has found the application of science to industry to be a proposition which appears to be a sound one, and, in conformity with American industrial policy, means to give science a fair trial. If men of science prove their value from the commercial point of view, they will rank equally with men of business capacity, who are able to dictate the terms of their science to industry.

It must be remembered that the American glass industry is relatively small, and even in Pittsburgh, where the glass factories are most numerous, it is entirely overshadowed by the steel industry. However, so far as scientific research goes, the industry is in a remarkably favourable position. The Geophysical Laboratory at Washington, D.C., which I visited, is primarily an institution for the investigation of scientific problems connected with glasses, of which the earth itself so largely consists, and the Bureau of Standards has devoted a considerable amount of attention to the subject. In April, 1917, soon after America joined in the war, American industry had to face a demand for an immense amount of optical glass. The work done by the staff of the Geophysical Laboratory is told in a few words in the director's report for 1918: "Suffice it to say that with a staff of twenty scientifically trained men, all trained in the handling of silicate solutions at temperatures required for the making of glass, and familiar with the control of the most important factors in the problem, it proved practicable to make rapid progress." After two months the output had doubled, and rejections by Government inspectors had become

very rare. A few months later "the output had reached a magnitude such that an adequate supply of suitable glass was assured for national needs, and . . . many refinements were being effected to bring the quality of the glass to a higher level."

To achieve these results, the staff of the Geophysical Laboratory did not remain in Washington and issue advice to manufacturers, but actually took over the scientific control of the plants, some of which were built after America's entry into the war, and in such positions I still found some of them when I was in America. The Bureau of Standards also established a small manufacturing plant in Pittsburgh, and here some very important work on glass pots for optical glass manufacture was carried out by Dr. Bleiniger. Accounts of much of this work have been published in the *American Journal of Science* and the *Journal of the American Ceramic Society*, and the work is described as being carried out "at the Geophysical Laboratory and at the plants of the Bausch and Lomb Optical Co., Spencer Lens Co., and Pittsburgh Plate Glass Co., under the authority of the War Industries Board." Anyone who is interested may learn exactly what was accomplished and what the position is at the moment, and may visit such of the plants as are in operation. Can anyone say what really has been accomplished in connection with optical glass in this country, what remains to be done in order to establish the industry, and what organisation exists for doing it?

The Bureau of Standards is, of course, an official institution; the Geophysical Laboratory is maintained by the Carnegie Institution, and is not under the control of Government. I do not know how far the experimental work in connection with optical glass was subsidised by the Federal Government, but during the war very substantial funds for research work were at the disposal of the National Research Council, which was organised, at the request of the President, by the National Academy of Sciences, and money from this source was available for such purposes. It must be noted that wherever an appointment had to be made in any matter of a scientific character, even in the case of officials, it was made on the recommendation of the men of science. In this we find an essential difference between American and British practice.

The development of scientific glassware, other than optical glass, was left to individual effort, and was solved with equal success by several firms. The Corning Glass Works, at Corning, N.Y., succeeded, however, in producing a very remarkable glass, which is called "Pyrex" glass, from which are manufactured both chemical hollow-ware and the so-called oven-ware. This glass has so low a coefficient of expansion and so high a tenacity that one can take extraordinary liberties with it, and it is much more highly resistant to changes of temperature than any glass previously produced. The

production of this glass is a very remarkable achievement.

"Pyrex" glass and the Empire bulb-blowing machine were only two of the many interesting developments which I was shown at Corning. When I was there, Dr. A. L. Day, who has long been connected with the works, was acting as vice-president of the company; and Dr. E. C. Sullivan and Dr. W. C. Taylor, assisted by a considerable scientific staff, were in charge of the technical side of the work. Dr. Taylor told me that they had been carrying out a systematic survey of possible combinations in glasses, and that as each glass was made experimentally its properties were investigated and recorded. In the Steuben Works, which are under the same management, and only a few hundred yards distant, Dr. J. C. Hochstetter was collaborating with Mr. F. C. Carder in the investigation of problems relating to coloured glasses.

Scientific glassware was also being manufactured at the H. C. Fry Glass Works, where I spent a day with Dr. Scholes and his staff, and at the Macbeth Evans Glass Co.'s plant, also near Pittsburgh, Pa., over which I was shown by Dr. Macbeth and Prof. Hower, who is consultant to the firm. I found quite a numerous scientific staff working in excellent laboratories.

In the bottle-making branch of the industry the engineer predominates. I believe that the first bottle machine was English, and one would like to know why it is that the development of bottle machinery has been practically wholly American. The Owens machine, the Hartford-Fairmont flow feed, the Westlake machine, and the Empire machine are purely American, and they are American because Americans understand the value of science organised in the service of industry, and are willing to give good brains a fair chance and to back them with good money. Developments in this direction are entirely a matter of private enterprise, in which consumers as well as manufacturers are often financially interested.

To no branch of the glass industry has science

been of greater service than to that of the electric lamp industry. I was able to spend two days in the research laboratories attached to the great plant of the General Electric Co. at Schenectady, in company with Drs. Whitney, Langmuir, Coolidge, and Hull, whose names are as well known in Europe as in America. The staff of the laboratory is said to number more than 150 members, and the work carried on is in some cases purely scientific, and in others highly technical, processes being actually worked in the laboratory until the demand for the goods or material produced justifies the erection of separate factories. While I was at Cleveland, Ohio, Dr. W. M. Clark, the chief chemist of the National Lamp Association, was good enough to show me over the whole plant of his firm. Here a physical laboratory dedicated to investigations connected with illumination, but only indirectly with artificial lighting, has been established in recognition of the services of science to the industry.

In several of the universities research is being carried out in connection with glass, and I had the good fortune to meet both Prof. Washburn, of Illinois University, and Prof. Silverman, of Pittsburgh University, and to discuss with them their work on the chemistry and physics of glass.

A short article permits me to deal only with isolated incidents in my tour, but the impression which I brought away with me and wish to convey to others is that there are a great many men of high scientific ability engaged in the American glass industry, which has learned, as the German glass industry learned, to our undoing, that industrial progress implies the co-operation of science and industry. American industry is not securing the co-operation of science for sentimental reasons, but with a view to competition with us in the markets of the world. To this movement science, through the National Research Council, organised by the National Academy of Sciences, in co-operation with the national scientific and technical societies of the United States, is giving its heartiest support.

### The Circulating Blood in Relation to Wound-Shock.<sup>1</sup>

By PROF. W. M. BAYLISS, F.R.S.

THE system of vessels in which the blood is contained must be conceived of as a *closed* system. But the walls are distensible and elastic; they can therefore stretch and collapse to accommodate varying amounts of liquid. This is possible, however, only to a limited extent. Although the veins have thinner walls than the arteries, and appear to be less supported by surrounding structures than are the capillaries, it is remarkable that they oppose a greater resistance to a bursting pressure than do the arteries. Veins, moreover, have a muscular coat which is in a

more or less contracted state during life. Hence the introduction of more fluid into the system must encounter a certain resistance and raise the internal pressure, unless the muscular coat actively relaxes to accommodate the fluid introduced.

This closed system contains, under normal conditions, about four litres of blood in man. It consists, as is generally known, of the heart, of branching tubes (arteries), leading from the heart to the tissues, where they break up into a network of much finer tubes, the capillaries, which unite again to form the veins, and so lead the blood back to the heart. Consider the distribution of the blood at the time when the heart is at rest.

<sup>1</sup> Discourse on "The Volume of the Blood and its Significance," delivered at the Royal Institution on Friday, February 13.

The amount present in each part, including the heart itself, is obviously in proportion to the capacity of each part.

The heart, however, works as a pump. The way in which the blood is circulated was first clearly propounded by Harvey in 1616, although Leonardo da Vinci came very near to the discovery more than a century before. Harvey saw the blood sent out from the heart, propelled to the tissues in the arteries, and returned to the heart by the veins. The course of the blood from one to the other through the minute capillaries could not be seen until the invention of the microscope by Leeuwenhoek, who made use of it in 1686 to observe the blood traversing the capillaries in the tail of the tadpole.

The heart, then, when it contracts, drives out the blood which is contained in its cavities, or nearly the whole of it. This same quantity must be returned by the veins, otherwise the blood would soon all be accumulated in the peripheral parts of the body. Further, the heart is capable of driving out the more blood the greater the quantity it contains when contraction begins. This is what has been called by Starling the "law of the heart." It depends on the fact that muscular fibres contract the more powerfully the greater the length to which they are stretched to begin with—within limits, of course.

We see, therefore, that the amount of blood driven through the organs of the body in a given time depends on the amount present in the heart at rest. Since this is a definite fraction of the whole blood, the irrigation, as we may call it, of the body is in proportion to the total quantity of blood available. The importance of sufficient irrigation is obvious. The blood conveys to the active cells the materials required for their work, and of these the most necessary is oxygen. If the supply is too meagre, the first few cells with which the blood meets exhaust it, and those beyond suffer from deprivation. Waste products are removed at the same time.

Although the part played by the volume of the circulating blood in relation to the capacity of the vascular system was realised by Carl Ludwig and his school, who made many experimental investigations on the subject, the matter came especially into prominence in connection with the explanation and treatment of the state known previously as "surgical shock," but which occurred with alarming frequency in men wounded in the late war. The name "wound-shock" is a more comprehensive name, although the use of the word "shock" is liable to give a misleading impression as to the rapidity of its onset, and to cause confusion with "shell-shock," another unsatisfactory name, but used to designate an affection of the nervous system of quite a different nature from that brought about by the wounds themselves. Wound-shock is not easily defined in such terms as to distinguish it clearly from other similar states, such as that due to loss of blood, but it may be said to be one of general collapse, ending in death if not combated in some way.

It does not come on immediately after injury, but in the course of some two or three hours. It shows itself by pallor, coldness, sweating, vomiting, thirst, low blood-pressure, and the other symptoms which were early recognised as indicating a defective circulation.

But what is the actual cause of this collapse of the circulatory mechanism? It was soon realised, by those who examined cases of wound-shock, that it was not due to any failure of the heart itself, nor was the central nervous system involved, except indirectly in the later stages. On the other hand, much difficulty was found in distinguishing between this state, even when attended by very little loss of blood, and that resulting from great loss of blood unaccompanied by serious injury. The latter is obviously the result of the defective volume of blood and its consequences, since blood is known to have left the body. But why do the former cases also appear to be suffering from the same condition, when scarcely any blood has actually been lost?

In the endeavour to find an explanation for this, we may call to mind the circumstance that blood may be effectively removed from circulation by being pooled away in some part or other of the vascular system, as, for example, by a great dilatation of this part. The amount which is available for propulsion by the heart to serve for continuous irrigation of the tissues is reduced as much as it would be if the blood held in the pool were actually lost to the outside. Such changes in the capacity of the peripheral blood-vessels play a large part in the regulation of the blood-pressure and the supply of blood to various organs. We may inquire whether anything of this kind happens after severe injuries.

The first step taken in the course of this inquiry was the discovery that some poisonous substance is produced in injured tissues. This, passing into the blood, is carried to all parts of the body. Sir Cuthbert Wallace, some years ago, had noticed that operations in which the cutting of large masses of tissue was involved were especially liable to be followed by shock. Quénu and others, during the war, were struck by the rapid benefit frequently ensuing from removal of the injured parts or even when they are tied off from connection with the rest of the blood-vessels, if such is possible. Cannon and myself found that we could produce the state of wound-shock in anaesthetised animals in the laboratory, and that it was due to a chemical agent, not to any effect on nerves. This being so, we see that we can replace the name of "wound-shock" by the more descriptive one of "traumatic toxæmia."

But can we form any conclusion as to the chemical nature of this toxic substance or as to the way in which it acts? It is evidently produced too quickly to be a result of bacterial infection, and, indeed, McNee was able to exclude this possibility quite definitely. Dale and Laidlaw, however, showed that there is a compound of known chemical structure, called "histamine,"

and produced without difficulty from a constituent of the nitrogenous cell structures, which is able to produce a state of the circulation like that present in wound-shock. It was found that the effect was not due to a dilatation of the arterial part of the system, as was known to be the case in the fall of blood-pressure brought about by vaso-motor reflexes. Here the similarity to traumatic toxæmia showed itself again, because it was known that arterial dilatation was not present in this state. Next, Dale and Richards, by a number of ingenious experiments, were able to localise the effect in the capillaries, which became widely dilated and thus capable of taking up the greater part of the blood in the body, leaving the heart nearly empty, with too meagre a supply to carry on the circulation with any degree of efficacy. It is to be admitted that we have not yet definite proof that it is histamine itself which is responsible for the toxæmia of injury. But that the agent is something which acts in the same way is made clear by the observations that have been made on wounded men. The determinations of the volume of the blood in circulation, made by N. M. Keith, may be especially mentioned. Keith showed that, in severe cases, it may be reduced to little more than half the normal amount, although scarcely any has actually been lost by hæmorrhage. The method used was that of introducing into a vein a known quantity of an innocuous dye which does not pass through the walls of the blood-vessels, and, after a short interval, taking a sample of the blood and finding how much the dye has been diluted.

If the toxæmia is severe, a second property of the poison shows itself. This is an effect on the walls of the capillaries such that they allow the liquid part of the blood to escape by filtration. In this way the volume of the blood is still further reduced.

The treatment, in principle, is obvious. Restore the blood-volume. It would appear that when blood has been lost it ought to be replaced by blood. The case of traumatic toxæmia is not so clear at once, because blood has not been actually lost, and it should be possible to keep up an effective circulation by some other liquid until the poison is got rid of and the pooled blood returned to circulation. In fact, as experience

increased, it was realised that the important matter is to maintain the volume in circulation, whether by blood or other solution. An innocuous fluid seemed to serve practically as well as blood, and had the advantage of being always at hand and in as large a quantity as required.

As to the properties of such a solution, it was soon found that a simple saline solution is very rapidly lost from the circulation and is useless. It is necessary to add to it some colloid with an osmotic pressure, such as gelatin or gum acacia. The colloid does not pass through the walls of the blood-vessels, and its osmotic pressure causes an attraction of water to balance that lost by filtration. Thus, although the slow circulation incidental to a small volume of blood is inadequate, this very quantity, if diluted to normal volume, is able to serve effectively. Comparing the oxygen carried by the red corpuscles to railway passengers, it will be realised that if we have a limited number of trains, we can carry more passengers in a given time if the velocity of the trains is increased. Animal experiments made by Gasser showed that this is actually the case with the blood. After a loss of blood the injection of gum-saline might even raise the supply of blood-corpuscles to a level beyond what it was before the hæmorrhage.

The general conclusion is that the volume of the liquid in circulation must be kept up to its normal value, whatever this liquid may be. Of course, the number of red corpuscles cannot be allowed to fall below some particular value, and it has been found that about one-quarter of the normal quantity is the lowest compatible with life. If they fall below this, moreover, there is no production of new corpuscles.

In the later stages of the war gum-saline was largely used in the British, American, and French Armies, and is reported to have saved many lives. Unfortunately, if too long a time is allowed to elapse before treatment, nothing avails, not even transfusion of blood. Hence the importance of the early use of intravenous injection, and also of removal of the injured tissue by operation. As the war progressed, these procedures were, therefore, pushed more and more forward to the battle area, and with more and more favourable results.

### Characteristics of Pigments in Early Pencil Writing.

By C. AINSWORTH MITCHELL.

**P**ENCIL pigments may be classified in the following groups: (1) Metallic lead or alloys of lead; (2) graphite cut from the block; (3) early composite pigments containing graphite, sulphur, resins, etc., but no clay; (4) graphite powder compressed into blocks; and (5) composite pigments containing graphite with clay and other ingredients. These pigments usually show distinctive microscopic characteristics in the marks which they produce.

When examined under the microscope with a magnification of about twenty diameters and the light at right angles, ordinary lead shows, in its vertical markings on paper, a series of irregularly distributed patches, uniformly and brilliantly lit up, and marked with regular vertical striations which have the appearance of ridges. In the case of Borrowdale graphite (Fig. 1) the vertical lines show relatively few brilliant straight striations (due to siliceous impurities), and when these occur in the



heavier strokes they are disjointed and irregular. The fibres of the paper may be brilliantly lit up by particles of adhering graphite which reflect the light, especially in those places showing a metallic lustre to the naked eye. Less pure forms of graphite show more numerous striations, but these are always more or less disjointed and irregular, and quite distinct from the fine striations in modern pencil markings.

The composite pigments (containing sulphur) in early specimens of pencils in South Kensington Museum, which Mr. T. H. Court kindly placed at my disposal, show a faint greyish pigment, with occasional striations, whilst Brockedon's graphite (1843) (Fig. 2) and other kinds of compressed graphite produce lines which show a rich black pigment with silvery dashes and lines distributed fairly uniformly all over the field.

Modern pencil compositions, mainly of graphite, clay, and wax, all have a similar microscopic appearance in the vertical lines made by them on paper, which is quite different from the markings of the old pencils of natural graphite, and in most cases from those made from the old compressed graphite powder. In the modern pigments the fine siliceous particles, derived from the clay and impurities in the graphite, are evenly distributed, and appear in the pigment on paper as fine beaded striations, which are uniform and parallel throughout the line (Fig. 3). Chemical methods of distinguish

these pigments have been described by the present writer (*J. Soc. Chem. Ind.*, 1919, xxxviii., 383T).

Some particulars of early pencil markings are given in a curious book by C. T. Schönemann (*Versuch eines Systems der Diplomantik*, Leipzig, 1818, 2 vols.) upon the codices preserved in the libraries in Germany. In vol. ii. (p. 108) it is asserted that lines in blacklead (*Reisblei*) had been drawn on the "Codex Berengarii Turonensis" of the eleventh or twelfth century, which was in the Wolfenbüttel library. The "Codex Guidonis Aretini de Musica" (eleventh or twelfth century) in the Göttingen library contained vertical and horizontal lines showing traces of blacklead (p. 112), whilst the "Codex Theophili" (twelfth century) in the Wolfenbüttel library showed very fine vertical lines in blacklead.

Now, as graphite was not known until about 1560, it is obvious that Schönemann mistook the

markings in ordinary metallic lead for graphite. Through the kindness of Mr. J. P. Gilson, of the MSS. department, I have been able to examine specimens of early pencil marks in the writing and drawings in manuscripts in the British Museum. The earliest example was a drawing in the Stowe MSS., "Arms of Ancient Nobilitie" (705), of the early seventeenth century. The particles composing the lines of this drawing all reflected the light brilliantly, but were much smaller, and lacked the striations which are characteristic of metallic lead. On the other hand, the lines had not the appearance of any form of graphite, the particles being disjointed and not showing any connecting interrupted striations, as are often to be seen in lines of graphite having a metallic lustre. It is therefore probable that this

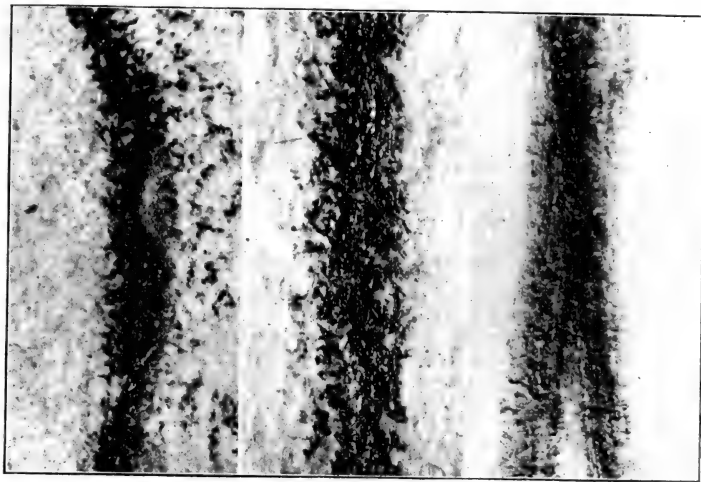

FIG. 1.—Typical early graphite marking, 1831.  $\times 20$ .

FIG. 2.—Brockedon's compressed graphite, 1843. (Mark made by specimen in Geological Museum).  $\times 20$ .

FIG. 3.—Typical modern composite pencil.  $\times 20$ .

drawing was done with a metallic pencil in which lead did not predominate.

A later MS. (1691) (Add. 22,550) includes drawings in which the lines show the large isolated particles with the vertical striations characteristic of metallic lead. In another Stowe MS., 686 (*circ.* 1630), the lines in the drawings have the appearance of ordinary graphite. The pencil markings in two note-books of Sir Thomas Cotton (Harley, 6018, about 1630-40) and Cotton Appendix, xlv. (1640-44), have all the characteristics of graphite.

The writing in Lord Hardwicke's "Notes on Briefs" (1718) is undoubtedly in graphite, but a drawing by Vertue (Add. MS. 2111) (1741) has the appearance of metallic pigment. A note-book of Hogarth (Egerton MS. 3011) (prior to 1753) contains heavy pencil writing, the pigment of which is a particularly rich graphite.

The pencil outline of a drawing on the top of ink in another of Hogarth's note-books is also in typical graphite. The lines in the drawings of a later volume of Stowe MSS. (993), about 1747, show fine interrupted striæ, such as are frequently noticeable in the marks made by pure graphite. In "Heraldic Collections" (Stowe MS. 661) of 1763-64 the pigment in the drawings of the coats-of-arms is also in graphite, and shows the fibres of the paper lit up by adherent particles. An interesting example of graphite markings is to be seen in a letter from Prof. Herrmann (1780) from Strasbourg (Add. MS. 22,935, fol. 140b). This contains a pencil drawing of a fish, in which the pigment has formed branching striations along the lines of the paper fibres.

Flaxman was in the habit of making drawings on the backs of the envelopes of letters received by him at Buckingham Street, Fitzroy Square, and a series of these, dating from about 1800 to 1814, is preserved in the British Museum. In every instance the pigment in these drawings is typical of pure graphite, and even interrupted striations are only of exceptional occurrence.

In view of the fact that Conté's composite clay process was invented in 1795 in Paris, it is interesting to note that a card sent to Flaxman by the painter Fleury Epinat, of Lyons, between

1805 and 1814 was written with a pencil producing the characteristic fine regular beaded striations of the modern type of pencil. This is the first instance noted of the occurrence of writing in a composition pigment in the MSS. in the Museum.

Of the other manuscripts and drawings of the early nineteenth century, mention may be made of a letter of Byron (about 1809) which is written in a particularly brilliant graphite, and of the pencil corrections made by Keats (about 1820) in his manuscript of "Hyperion," which are also in pure graphite. The same characteristics of rich pigment deposit, showing only scanty, irregular, broken striations, may also be seen in a letter of Lord Wellesley written about 1828.

The manufacture of graphite pencils by the original method of cutting from the block was continued until about 1869, overlapping the modern process; but, as the old pencils must have been widely distributed, it is not surprising that the characteristics of pure graphite are frequently to be found in writing, and especially in drawings, for several years after that date. Hence it is quite in accordance with the development of the industry that the note-book of James Thomson, the author of "The City of Dreadful Night," for the year 1869 should be written with a pencil which produced no silvery striations.

### The Relationship of Education to Research in Aeronautics.

THE relation of education to research is a simple one in most fields of scientific work, in that the universities provide both one and the other. This simplicity cannot, however, extend to the subject of aeronautics, because the cost of experimentation is so great and the organisation required so complex. In the future the universities may perhaps be equipped even for this extension of their activities, but at the present time, and for many years to come, the experimental work will in general be beyond their means. The Government, however, for its own sake, needs to continue to carry on aeronautical research, and the question naturally arises: What are to be the relations between the Government research establishments and the university teaching establishments? The Committee appointed in October, 1918, by Lord Weir to advise on this matter has now reported, and its recommendation is to merge the staffs undertaking these two classes of work. At the present time it is scarcely practicable or wise to found more than one school of aeronautics, and the Committee selects the Imperial College of Science as its home, suggesting that the staff of the school should for the most part be composed of those members of the Government research establishments who are best qualified for the work, and can be permitted to spend part of their time at the Imperial College.

The Committee also provides that the Advisory Committee for Aeronautics should come to an end, and that its former powers should—with certain additions—be made over to a new body, the Aero-

nautical Research Committee. The Advisory Committee has had a very distinguished history. Its composition was mainly non-official, and it became a watchful and highly independent body able and ready to intervene in any matter where it thought such intervention was required. With the many reorganisations of Air Service matters during the war, whether relating to the R.N.A.S., the R.F.C., the Air Board, the Air Ministry, or the R.A.F., it became the one continuously operating body, and rendered services to the State of a value which can be realised only by those who kept in touch with its wide activities. The Education and Research Committee endeavours to pay tribute to the Advisory Committee, and it must have had some difficulty in finding words appropriate to the occasion.

It seems that the Government took definite decisions some six months ago that an Aeronautical Research Committee should be created to replace the existing Advisory Committee; that, in addition, research work should be undertaken by a Research Association to be formed by the Department of Scientific and Industrial Research, on the usual terms, if the industry should so desire; and that the Imperial College should be the educational centre (although applications from provincial universities for grants would be considered). The Committee, taking note of these decisions, suggests that the new Aeronautical Research Committee (A.R.C.) should supervise both research and education. Any plan for the supervision of research needs to take into account

the nature of the establishments where it is at present undertaken. These places are the Royal Aircraft Establishment (Farnborough); the National Physical Laboratory (controlled by the D.S.I.R.); Martlesham Heath, Biggin Hill, Pulham, Grain, Felixstowe, and possibly other Government aerodromes. All of these, except the R.A.E. and the N.P.L., are controlled by the Director of Research at the Air Ministry on behalf of the Air Council, which is responsible for these centres and pays for them. The Committee does not attempt to pursue the allocation of responsibilities further, but such allocation need not be expected to lead to difficulty, since much of the work from these centres found its way in the past to the old Advisory Committee, and will doubtless in the future find its way to its successor.

As regards the educational side, the Committee mentions an estimate that before the war the total yearly number of honours graduates in engineering, including civil, mechanical, and electrical, and in naval architecture, etc., from all the universities in the United Kingdom averaged only about two hundred, and that of these it rightly considers only a fraction of the future number are likely to devote themselves entirely to aeronautics. It certainly seems probable that the number will be quite small; the Government has its own Air Service establishments, and these will naturally take a proportion of the possible entrants each year. Moreover, the most promising career for aeronautical engineering work at present is the Government service, since it is the Government which controls nearly all the research and no small proportion of the full-scale design, to say nothing of the ordinary Service work and its attraction to the adventurous. The only factor which would seem capable under present conditions of adding materially to the numbers of students taking an aeronautical engineering course at the Imperial College or elsewhere would be if the Government used this means for the training of its own future technical staff.

The course, once formed, is to consist of twelve months' specialised teaching, coming after the usual degree or diploma course in engineering already provided at the universities and great technical schools. The subjects selected for this course are: Aerodynamics; aero-engines; general design; instruments, meteorology, and navigation. The proposed staff includes a general director, who would be the Zaharoff professor of aviation, two other professors, and a number of lecturers. This staff should, the Committee suggests, act as a clearing-house for the study of the results of experimental work, whether full-scale or in the laboratory, and for the dissemination of conclusions based thereon as forming the right foundation for further design. As the Committee naturally adds, no school for providing this education can be successful unless the students are brought into direct touch with practical problems during their tuition, and unless those engaged in teaching are also occupied in, or directing, scientific research or experimental design.

Some extracts from the Committee's report are subjoined.

#### INTRODUCTION.<sup>1</sup>

The Government has now decided how provision is to be made for research in aeronautics. We desire at the outset to emphasise the necessity for that research. The Department of Scientific and Industrial Research is to continue the provision for fundamental research at the National Physical Laboratory, and to assist the aeronautical industry in the same manner as other industries by taking part, when desired, in the formation of a research association. In our view, at the start of a new industry something more is required. At the present moment the industry is passing through a crisis; Government support is necessary if it is to emerge satisfactorily. The time is critical and the development of civil aviation is beset by numerous difficulties, and calls for the fullest consideration. It is urgently necessary that the policy adopted should command the support of all who desire to maintain the superiority in the air gained during the past eventful years, and that ample funds should be provided for carrying it into effect.

A difficulty which arises in the case of a new industry of this kind lies in the fact that the scope of the work is inadequate to maintain automatically a sufficient number of experts in design and production. A research organisation may elucidate problems and provide general information and specific facts, but before these can bear fruit of industrial value they must be interpreted and applied by a suitable technical staff, closely associated with the works organisation. At the end of the war most of the works had collected a team of technical experts of marked ability; many of these teams have now been disbanded, and further disintegration is in progress. We see no possibility of achieving the desired result except by such Government action as will secure the retention of adequate technical staffs.

During the war this country obtained the lead in aeronautical research; it would be lamentable to see the fruits of the work pass from a paralysed industry to better-supported foreign competitors. In the later sections of our report we recommend the establishment of an organisation for aeronautical research to assist the Air Council, and, in our view, it is important that the work of that organisation should be available in great measure for the assistance of the industry and for the advance of civil aviation, as well as for the Services. Should an industrial research association be formed, it should be linked up with the organisation we recommend.

Education and research are clearly very closely inter-related. The education with which we have chiefly concerned ourselves is that suitable for aeronautical engineers and constructors—that is to say, post-graduate work for which the students will be fitted by a previous undergraduate course of either mechanical or general engineering training at one of the universities or technical colleges. We have not dealt with the training of pilots or of mechanics. The course we contemplate will comprise a special study of the following matters:—Aerodynamics, the laws of motion of bodies moving in the air, illustrated by experiments and researches in wind-channels; the principles of design and construction; engines and the methods of propulsion of aircraft; and the inves-

<sup>1</sup> Abridged from the Report of the Committee on Education and Research in Aeronautics (Cmd. 354, price 2d. net) to Mr. Winston S. Churchill, Secretary of State for Air. The members of the Committee were: Sir R. T. Glazebrook, K.C.B. (Chairman), Sir Alfred Keogh, G.C.B., Sir H. Frank Heath, K.C.B., Sir Francis G. Ogilvie, Mr. F. Handley Page, Mr. G. Holt Thomas, Prof. J. E. Petavel, and Lt.-Col. H. T. Tizard.

tigation of instruments used in flight, with problems in meteorology and navigation. The engineer must also gain the practical knowledge acquired only in the workshop, and must have experience of the full-scale researches necessary to test and verify his theoretical conclusions. Such a course might eventually involve one or more centres of theoretical instruction with experimental aerodromes and laboratories where the full-scale problems may be worked out, but as the number of persons likely to require this higher post-graduate education will not be great we consider that it will be wise for the present to concentrate the work in one central institution with which the experimental aerodromes should be closely connected. Such a central institution we find in the Imperial College of Science and Technology, at which the professorship lately founded by Sir Basil Zaharoff is to be held.

To turn now to research. This is the means by which advance in aeronautics is possible, and it is required by all interested in the progress of the subject: by the State, whether for the purposes of defence or to enable it to lay down the rules necessary for the safety of aircraft when used for civil purposes; by the professor, whose aim is to increase knowledge; and by the industry, in order that it may maintain the superiority which British aircraft has already achieved. Research is difficult, its requirements are costly, and the men who can undertake it are few. To establish separate research laboratories and aerodromes for each of these special interests is, for the moment, out of the question; here, again, combination is called for—combination, too, with the agencies concerned in education. At the same time we recognise fully that special problems may be dealt with at other research centres, and we trust that every encouragement may be given to these for such work.

Since the commencement of practical aeronautics, research has been directed by the Advisory Committee for Aeronautics, a body, under the presidency of the late Lord Rayleigh, appointed by the Prime Minister in the year 1909 "for the superintendence of the investigations at the National Physical Laboratory and for general advice on the scientific problems arising in connection with the work of the Admiralty and War Office in aerial construction and navigation."

Full-scale research has been carried out at Farnborough, in part at the initiation of the Advisory Committee, in part at that of the military authorities; the Committee, however, has no control over the work there, and occupies only an advisory position with regard to it. During the war other centres of full-scale research were established—e.g. the Isle of Grain and Felixstowe for seaplanes, Kingsnorth and Pulham for airships—and the Advisory Committee has been kept in close touch with the work in progress at all of these. Its activities have been of the greatest value. In our view, a central co-ordinating body of this kind is essential, and it is now proposed to establish an Aeronautical Research Committee, to which the duties of the Advisory Committee would be transferred, and certain other duties and responsibilities added with regard both to the central research aerodromes and to education. The proposed Committee should be in a position to supervise effectively such work as comes within its purview.

The work in aeronautics conducted at the National Physical Laboratory would also, usually, be undertaken on the initiation of the Committee. The expenditure for such work forming part of the budget of the Department of Scientific and Industrial Research.

In order to connect the Committee with the educational work and to render the opportunities of research at Farnborough and elsewhere available both to teachers and to students, we suggest that arrange-

ments should be made between the Committee and the Imperial College for dealing with matters with which they are jointly concerned. In this connection, moreover, we suggest that it would be possible in a number of cases for members of the research staff to act as professors or lecturers at the college.

#### CONSTITUTION OF THE AERONAUTICAL RESEARCH COMMITTEE.

The Aeronautical Research Committee should include representation of (a) the Department or Departments responsible for (i) naval and military aeronautics, (ii) the regulation of civil aerial transport; (b) the Department of Scientific and Industrial Research, including direct representation of the National Physical Laboratory; (c) the aircraft industry; (d) the Imperial College; as well as (e) other members of scientific attainments. The chairman of the Committee should be an eminent man of science, and in a position independent of the Government Departments represented on the Committee. He and the other non-official members of the Committee should receive suitable remuneration.

#### FUNCTIONS OF THE AERONAUTICAL RESEARCH COMMITTEE.

It should be the duty of the Aeronautical Research Committee to devote itself to the advance of aeronautical science, and, with this object, in particular (1) to advise on scientific and technical problems relating to the construction and navigation of aircraft; (2) to undertake or supervise such research or experimental work as is proposed to the Committee by the Air Ministry, and to initiate any research work which the Committee considers to be advisable; to carry out such work itself or to recommend by whom the work should be carried out; (3) to take over complete responsibility for the Air Inventions Committee and for the Accidents Committee; (4) to promote education in aeronautics by co-operating with the governors of the Imperial College; (5) to assist the aeronautical industry of the country by scientific advice and research, and to co-operate with any research association that may be established; (6) to prepare for the approval of the Air Council a scheme of work and estimate of expenditure for the year, and to administer the funds placed at its disposal by the Air Council; and (7) to make reports from time to time to the Air Council.

#### CO-ORDINATION OF THE RESEARCH AND EDUCATIONAL ORGANISATION.

We have referred to the need for close association between the research and experimental work and the strictly academic portion of the higher education. No school for providing this education can be successful unless the students are brought into direct touch with practical problems during their tuition, and unless those engaged in teaching are also engaged in or directing scientific research or experimental design.

The arrangements whereby the student will divide his period of post-graduate instruction between work on books and at lectures and practical work at research stations should apply also in regard to the duties of the teaching staff. These should be such as to enable a professor or lecturer to spend part of his time in giving instruction at the Imperial College, while giving the rest to investigations at one of the research centres.

The School of Aeronautics should provide advanced instruction as regards aeroplanes, seaplanes, airships, and kite-balloons in (1) aerodynamics; (2) aero-engines and methods of propulsion; (3) design,

including structure and materials; and (4) instruments, meteorology, and navigation. It would follow, therefore, that certain of the professors or lecturers in each of these subjects will discharge double responsibilities (a) as members of the staff of the Imperial College and (b) as officers of the research organisation directed by the Aeronautical Research Committee.

The Interim and Final Reports of Special Committee No. 5 of the Civil Aerial Transport Committee contain much valuable information as to the organisation of teaching and research. One factor of importance which they emphasise is the need for a trained staff to act as a clearing-house for the co-ordination and dissemination of aeronautical knowledge in all its aspects. The Central School of Aeronautics should, in our view, serve this purpose.

The functions of the teaching staff of the School may be stated under four distinct, though closely related, purposes:—(a) To study, co-ordinate, summarise, apply, and extend the knowledge derived from the experimental work carried out by the individual workers at various experimental stations in this country and abroad. (b) To stimulate research by indicating what information is most urgently required and what line of attack is likely to prove most profitable. (c) To guide and encourage research by constructive criticism based on a careful study of past and current work in this country and abroad. (d) To impart this knowledge by personal teaching to a limited number of post-graduate students.

A similar clearing-house for current knowledge would be of value in any science, but for aeronautics it is, for the present, essential; for whereas in older sciences—physics, for instance—the bulk of the experimental data has, throughout the course of generations, crystallised into well-defined laws which form a framework ready to receive any new facts and a criterion by which their accuracy can be estimated, in aeronautics the facts are the result of the work of the last five or ten years, and the framework uniting them exists only in the minds of the few men who have been personally connected with the process of development.

Before the war the total available knowledge was small, and it was possible for the members of the Advisory Committee to keep all the facts in mind while devoting most of their time to other duties. They then provided the necessary co-ordinating factor. This is no longer possible, and the function could best be discharged by the staff of the School working under their director with the view of co-ordinating and making available all the knowledge in each branch of the work as existing at the moment.

For these reasons it is essential that the permanent staff of the Central School should be adequate both in numbers and in range of experience to the duties outlined above.

The subject of meteorology, including with it training in navigation and the use of instruments employed in flight, is one of great importance. The position, however, of the teacher of this subject must depend on the action taken with regard to research and inquiry into meteorological science generally. We have made provision in the estimates for a teacher in meteorological subjects closely connected with aeronautics who should combine this work with research at one of the experimental stations. His work would be brought into connection with the central meteorological establishment. We would add that, quite apart from the other interests concerned, we feel it our duty to press for the establishment of a properly equipped centre of teaching in this subject, the need for which has been felt for some years and is now acute.

## Notes.

By a majority of seventy-five in a House of close on eight hundred Oxford has decided, for good or ill, that the Greek language shall no longer be a compulsory study for any of her *alumni*. In favour of the statute embodying this policy, which came before a full meeting of Convocation on March 2, speeches were delivered by Mr. C. Bailey, of Balliol College, Dr. Farnell, Rector of Exeter College, and Dr. David, Headmaster of Rugby. The opposition was undertaken by Mr. R. W. Livingstone, of Corpus, Mr. R. Carter, Headmaster of Bedford Grammar School, and Mr. John Murray, M.P., of Christ Church. The issue before Convocation was, perhaps, not quite so clear as it might have been; for it is probable that many voters thought that the rejection of the statute would have meant the perpetuation of the old form of Responsions, an examination which is allowed on all hands to be in need of radical reform. There is no doubt that in any case, whether the statute passed or was rejected, no attempt would have been made by the advocates of Greek in Responsions to make that language compulsory for passmen or for honours candidates in science or mathematics. But the feeling against compulsory Greek in any circumstances prevailed with the majority of voters, and Oxford has distinctly and definitely decided that, so far as she is concerned, the Greek language, however desirable as a study for specialists, is no longer to be considered a necessary element in a general education. The present vote may be taken as the final settlement of a keenly debated and long-protracted controversy.

THE council of the Royal Society has decided to recommend for election into the fellowship of the society the following fifteen from the list of candidates:—Dr. Edward Frankland Armstrong, Sir Jagadis Chunder Bose, Dr. Robert Broom, Prof. Edward Provan Cathcart, Mr. Alfred Chaston Chapman, Dr. Arthur Price Chattock, Mr. Arthur William Hill, Dr. Cargill Gilston Knott, Prof. Frederick Alexander Lindemann, Dr. Francis Hugh Adam Marshall, Dr. Thomas Ralph Merton, Dr. Robert Cyril Layton Perkins, Prof. Henry Crozier Plummer, Prof. Robert Robinson, and Prof. John William Watson Stephens.

THE KING has been pleased to approve the appointment of the Right Hon. Sir Auckland C. Geddes, K.C.B., President of the Board of Trade, as his Majesty's Ambassador Extraordinary and Plenipotentiary in Washington. Sir Auckland Geddes was formerly demonstrator and assistant professor of anatomy in the University of Edinburgh; professor of anatomy, Royal College of Surgeons, Dublin; and late professor of anatomy, McGill University, Montreal. A year ago he was appointed to succeed the late Sir William Peterson as principal of McGill University, and he has now cabled his resignation of this post.

DURING the war little was heard of wireless telegraphy except that its use by unauthorised persons was entirely prohibited, but a great deal of pioneering research in the development of new methods and the

perfection of old was carried out. The oscillation valve in particular came to its own as a wave generator, an amplifier, and a detector, and wireless telephony passed from its experimental to its practical stages. The human voice is now heard across the Atlantic and from aeroplane to aeroplane. Notable advances have also been made in long-distance wireless telegraphy, especially in the directions of increased speed of transmission and carrying capacity of installations. It is mainly due to these improvements that, as announced in the *Times* of March 2, it has now been found possible to accept commercial messages to America at rates lower than the ordinary cable rates by as much as 4d. per word. A service on these lines was inaugurated on Monday last between the high-power Marconi station at Carnarvon and Belmar (New Jersey). High-speed automatic transmitters are employed, and the installation is duplexed so that messages can pass simultaneously in both directions.

A DEPUTATION representing the British Medical Association and the British Science Guild waited upon Mr. Balfour at the Privy Council Office on Tuesday, March 2, to urge that a sum of about 20,000l. should be set aside annually for the purpose of awards for medical discovery on the lines suggested in the report of the joint committee of the two bodies published in *NATURE* of January 8 (p. 488). The deputation was introduced by Sir Watson Cheyne, and its views were put forward by Sir Clifford Allbutt and Sir Richard Gregory. In 1802 the House of Commons voted Jenner a grant of 10,000l. in recognition of the national value of vaccination, and five years later made him a further grant of 20,000l. The proposal is that this precedent should be made the basis of an established system of awards for medical and scientific discoveries as just compensation for financial sacrifice commonly involved in producing them. The Medical Research Committee and the Department of Scientific and Industrial Research have funds from which grants are made to assist research, but they cannot offer reward or even recompense to the investigator who makes a notable discovery with or without any such aid. Organised work on particular problems is necessary, but its character is different from that of the creative genius, who must be left free to follow his own course wherever it may lead. Devotion to such research ought not to signify ultimate pecuniary loss when the results achieved contribute substantially to human welfare and progress, and a modern State may well accept the obligation to make reasonable provision for those who have thus enriched it. Mr. Balfour expressed himself in full sympathy with these views, and promised to put them before the Prime Minister, who, he reminded the deputation, had always been ready to give practical support to scientific work and to show his appreciation of its essential value in national life.

MUCH regret will be felt at the failure of the *Times* aeroplane, with Dr. Chalmers Mitchell as scientific observer, to complete the flight from Cairo to the Cape. On Friday last, February 27, a forced descent at Tabora, in the Tanganyika territory, due to the failure of one of the engines, damaged the machine

beyond repair, and further flight with it has had to be abandoned. Fortunately, Dr. Chalmers Mitchell and his companions are safe, though two of them are hurt. Misfortune has followed the attempt from the beginning, owing chiefly to engine trouble. On February 20, soon after starting from Mongala, the starboard magneto cut out, and the aeroplane had to return there. Leaving later the same day, an unintended descent was necessary at Nimule, at the head of the Nile rapids. Then followed two comparatively short flights to Jinja, where the Nile leaves the Victoria Nyanza, and past the archipelago in the north-eastern part of the lake to Kisumu. The visit to Jinja probably enabled Dr. Chalmers Mitchell to settle the question whether the Ripon Falls, where the Nile discharges from the Victoria Nyanza, are due to a dyke of igneous rock, as has been often asserted, or to a hard band of gneiss. The next stage of the journey from Kisumu to the southern end of Lake Tanganyika was known to present new difficulties, but if these had been surmounted the rest of the route would have been near railways, along which there would be better facilities for repairs than between Khartum and the Victoria Nyanza. It is very disappointing that the disaster should have happened after the worst part of the journey had been traversed, yet we are confident that the observations made by Dr. Chalmers Mitchell in the course of his flight will abundantly justify the scientific purpose he had in mind in taking part in it.

WE much regret to see in the *Daily Express* of March 2 the announcement that Dr. C. Gordon Hewitt, Dominion entomologist, has died in Ottawa.

THE New York correspondent of the *Times* reports that Major R. W. Schroeder, chief test pilot at Dayton (Ohio), on February 27 ascended to the record height of 36,020 ft. (nearly seven miles) in an attempt to attain a height of 40,000 ft. At the former height the oxygen supply ceased to flow, and Major Schroeder fainted. He raised his goggles to see if the emergency supply was working. "All at once," he says, "it seemed as though a terrific explosion had taken place inside my head. My eyes hurt terribly. I could not open them. I seemed to be peeping through a crack. There was a tremendous rush of air, and I seemed to be falling. . . . I do not remember landing."

THE news of the death of the Rev. Watson Failes has been received with deep regret by Old Westminsters and many former colleagues who remember him with affection. Mr. Failes was a mathematical scholar of Trinity College, Cambridge, and graduated as nineteenth Wrangler in the year 1871. He was assistant master at Bromsgrove in 1874 and 1875, and at Dulwich from 1875 to 1877. In 1877 he went to Westminster School, where he remained for thirty years. On the retirement of Mr. Cheyne and Mr. Jones he became senior mathematical master, and in 1897 he became master of Rigauds. Mr. Failes was an enthusiastic and stimulating teacher; his own solutions, especially of purely geometrical problems, were models of lightness and elegance. He was the

author of "Solutions of Jones' and Cheyne's 'Algebraical Exercises.'"

A GROUP of American botanical institutions and individuals has arranged through the Smithsonian Institution for the continuation of the lease of the Cinchona Station in Jamaica. Both British and American botanists are welcomed at Cinchona. Any British workers desiring to use the station should apply direct to the Jamaican Government. Local information could be obtained from Mr. William Harris, the Government Botanist, at Hope Gardens, Kingston, Jamaica. The opportunity of studying the peculiarly rich flora of the mountain forests is exceptionally good, while the station itself provides laboratory space. Not the least advantage to British students would be the intercourse with American students and the interchange of ideas which would naturally follow. The arrangements for American students are in the hands of a committee consisting of Dr. Britton and Profs. Coulter and Duncan Johnson.

THORSTEN NORDENFELT, whose death at Stockholm was recently announced, was best known as the inventor of the gun which bears his name and as the builder of a submarine. Gatling, Gardner, Hotchkiss, and Nordenfelt all achieved success with their machine-guns, but the greatest advance was made by Maxim, who first used the force of the recoil to work the mechanism. In the Nordenfelt gun the barrels were placed side by side horizontally, the firing mechanism being actuated by a lever moved to and fro by the gunner. A series of trials carried out at Portsmouth in 1880 led to the use of the Nordenfelt gun in H.M. ships for defence against torpedo-boats. In 1883 Nordenfelt constructed a submarine of about 60 tons displacement. The propelling machinery consisted of a compound surface-condensing steam-engine of about 100 h.p., the surface speed being nine knots. Steam generated while on the surface could be stored, and this was used for running short distances when the boat was submerged. The crew consisted of three men, and the boat carried Whitehead torpedoes. It was, however, as the inventor of the gun bearing his name that Nordenfelt was best known in this country, and the firm formed for the manufacture of the gun became amalgamated with the Maxim Co., and now forms part of the Vickers Co.

WE regret to see the announcement of the death of Mr. C. D. Leslie at Fortuna, Transvaal, as the result of a railway collision. Mr. Leslie was born in Ross-shire, Scotland, in 1871, and was educated at Fortrose Academy and George Watson College, Edinburgh. In 1889 he went to South Africa to take up a position with the Natal Civil Service, and six years later he left Natal to try his fortunes on the Rand. Here he acquired his practical knowledge of mining by working side by side with the miners, and his early experience gave him a great insight into underground working conditions and a profound knowledge of the miners. His first position on the Rand was that of contractor to one of the mines of the Central Mining group, after which he joined the Consolidated

Gold Fields group, and became manager of the Jupiter, Nigel Deep, and Simmer and Jack Proprietary Mines, where his organising powers and general mining knowledge, gained in his early mining training, fitted him for the position which he ultimately held as consulting mining engineer to the Consolidated Gold Fields of South Africa, Ltd. During the time that Mr. Leslie held this position he interested himself considerably in improving general mining conditions, being, amongst other things, prominent in the organisation of the early trials on drill steels, and the interest he took in the mining industry was exemplified by the able address he made during his period as president of the South African Association of Engineers and by the scientific movement he initiated in 1916 to develop the industries of South Africa.

At the forty-second annual general meeting of the Institute of Chemistry, held on March 1, Sir Robert Robertson, vice-president, occupied the chair in the place of Sir Herbert Jackson, the president, who was absent through illness. In moving the adoption of the report of council, Sir Robert read the president's address, in which reference was made to the position of professional men under prevailing economic conditions. The situation is far more promising than at the time of the armistice; more than 530 chemists whose names had been on the appointments register have now no further need of this assistance. The roll of the institute is steadily increasing, numbering nearly three thousand fellows and associates and more than five hundred registered students. The council has taken up the question of securing representation of chemistry in the Ministry of Health, with the satisfaction of seeing Sir William Tilden appointed a member of the Council of Medical and Allied Services, and Dr. J. F. Tocher, Chemist to the Scottish Board of Health. Jointly with the Institute of Metals, a committee is engaged on questions affecting the status and organisation of chemists and metallurgists with the Navy, Army, and Air Force. The officers and members of council for the year 1920-21 were elected as follows:—*President*: Sir Herbert Jackson. *Vice-Presidents*: H. Ballantyne, Sir J. J. Dobbie, E. M. Hawkins, G. T. Morgan, Sir Robert Robertson, and G. Stubbs. *Hon. Treasurer*: E. W. Voelcker. *Members of Council*: W. E. Adeney, W. Bacon, E. C. C. Baly, O. L. Brady, F. H. Carr, A. Chaston Chapman, A. Cottrell, A. C. Cumming, J. T. Dunn, L. Eynon, A. Findlay, G. W. Gray, F. W. Harbord, C. A. Hill, P. H. Kirkaldy, J. H. Lester, W. Macnab, S. E. Melling, G. W. Monier-Williams, A. More, F. Mollwo Perkin, G. H. Perry, B. D. Porritt, F. M. Potter, J. Rogers, E. W. Smith, and W. M. G. Young.

An important scheme for the co-ordination of the Health Department of Glasgow has been adopted by the City Council. Dr. A. K. Chalmers, the Medical Officer of Health, will be the head of an enlarged health department, which will now include the sanitary inspector, the veterinary surgeon, and the bacteriologist, each of whom until now has been head of a separate department and largely independent of the others. It can scarcely be doubted that this arrangement will conduce to efficiency and economy.

THE first of three Chadwick public lectures on "Military Hygiene in Peace and War" will be delivered by Gen. Sir John Goodwin, Director of the Army Medical Department, on Monday next, March 8, at 5.15 p.m., in the lecture-room, Royal Society of Arts, John Street, Adelphi, W.C.2. Immediately preceding the lecture Chadwick gold medals and prizes for services in promoting the health of the men of the Navy and Army will be presented to Surg.-Comdr. E. L. Atkinson, R.N., and Brig.-Gen. W. W. O. Beveridge, A.M.S.

AN extremely interesting account of the nesting habits of the storm-petrel by Mr. Audrey Gordon appears in *British Birds* for February. The author's notes were made during a brief stay on one of the smaller islands of the Inner Hebrides. Of the courting habits of this bird nothing is known, but the author believes that certain weird noises uttered while on the wing during dark and stormy nights or when the nights were misty are to be regarded as part of the courtship performances of the males. During this time the birds would seem to be circling round the nesting area at a great pace, like nocturnal swifts. While this is going on an incessant "purring" can be heard from the birds, which were probably the females, ensconced in rocky crevices. Mention is made of the bare patch on the crown of the nestling. This deserves closer investigation. It is found also in the young ostrich and in the nestling of the great crested grebe, where it takes the form of a vermilion heart-shaped prominence.

IN the Annals of the Royal Botanic Gardens, Peradeniya (vol. vii.), Mr. T. Petch continues the publication of his work on the fungi of Ceylon. "Revisions of Ceylon Fungi," part vi., embodies a critical examination of a large number of species and the correlation of the specimens in the original collections of Thwaites in Ceylon with those sent by Thwaites to Berkeley and Broome, now at Kew and the British Museum respectively, from which the species were described. Incidentally, an interesting question arises as to which series is to be regarded as containing the type-specimens. A second paper, "*Gasteromycetæ zeylanicæ*," contains a list of these larger fungi, including those originally recorded by Berkeley and Broome, as well as more recent additions. A full account of one of these, a remarkable phalloid form, which the author has studied in detail, appears in the Transactions of the British Mycological Society (vol. vi., part ii.), where it is described as the type of a new genus, *Pharus*.

THE Annals of the Royal Botanic Gardens, Peradeniya (vol. vi., part iv.), contains an account, by Mr. C. Bryce, of the structure and development of the small woody "burs" or "nodules" which are found in the cortex of the rubber-tree, *Hevea brasiliensis*. The nodules increase from the size of a pea to that of a hen's egg, and may sometimes produce large sheets of woody tissue. As they grow larger the stem becomes gnarled and warted, the cortex cracks and latex oozes out, and the tree becomes useless for tapping. These nodules occur

only on trees which have been tapped, and appear to be the result of physiological changes, the nature and cause of which are at present unknown, in the contents of the latex-vessels. They are formed round altered latex-vessels or round lesions or areas in the cortex into which latex has oozed and coagulated. The tendency to nodule formation appears to be confined to certain predisposed individual trees, and this abnormal condition is apparently not infectious. The nodules in *Hevea* are somewhat similar in structure to the isolated woody nodules which occur in the cortex of beech, pear, and apple. They consist of a central dark brown core, appearing as a point or line, of cortical elements, surrounded by a zone of wood derived from cambium and forming the bulk of the nodule. They are quite distinct from the globular woody shoots, such as are well known in beech, and are formed by the subsequent growth of dormant buds which have lost their original connection with the woody cylinder of the stem. These occur in both tapped and untapped trees of *Hevea*, but never form large masses of woody tissue as do the nodules.

A CATALOGUE of meteorological instruments has just been issued by Messrs. C. F. Casella and Co., Ltd., of Westminster. It is interesting to see the return of pre-war activity in this direction; necessarily a largely increased cost has occurred in the manufacture of the instruments, ranging from 33 to 75 per cent. Full details are given of the respective instruments, and there is much information as to the placing and the exposure required by meteorologists to render the observations of scientific value. Many may require the instruments only for casual use, but occasions will occur when the observations may be of real value to meteorologists. The catalogue gives a large range of choice with regard to price, and without doubt even the cheaper instruments noted are trustworthy. From a scientific point of view a mercurial barometer should be preferred to an aneroid. In the class of thermometers, perhaps a Six's maximum and minimum thermometer should be less preferable than the more ordinary maximum and minimum thermometers; experience has proved it to be more liable to get out of order. Referring to terrestrial radiation thermometers, it is recommended that the instrument should be placed at a height of about 2 in. above short grass; to fall into line with the recommendations of the Meteorological Office, the bulb of the thermometer should just touch the blades of short grass. Good illustrations are given of the various self-registering instruments, and the catalogue affords an easy means of selecting an outfit for all meteorological purposes.

IN the December, 1919, issue of *Terrestrial Magnetism and Atmospheric Electricity* the editor, Dr. L. A. Bauer, directs attention to the difficulties raised by the directors of magnetic and electrical observatories who do not carry out the decisions as to the observations and their reduction arrived at after adequate discussion at meetings of the International Commission on Terrestrial Magnetism and Atmospheric Electricity. Although at the Innsbruck meeting of the Commission in 1905 it was resolved without any dissent that future tabulation of the



magnetic elements should be in Greenwich time, no British observatory outside Great Britain has carried out the decision. With the view of securing uniformity, Dr. Bauer invites discussion of the following questions: Shall Greenwich time or the nearest standard meridian time be used for the magnetic records? Shall the mean value of an element be taken from a full hour to the next or from a half-hour to the next half-hour?

At the meeting of the Illuminating Engineering Society on February 24 a discussion on "Lighting Conditions in Mines, with Special Reference to the Eyesight of Miners," was opened by Dr. T. Lister Llewellyn, a considerable number of members of the Council of British Ophthalmologists and of the Ophthalmological Section of the Royal Society of Medicine being present. The introductory paper dealt largely with the disease of the eyes known as "miners' nystagmus," the increase in which has given much concern in recent years. The disease is common in coal-mines, but practically unknown in metalliferous mines. Dr. Llewellyn, by the aid of statistics on eyesight, supplemented by data on the actual working illumination in mines, contended that the disease was mainly due to inadequate illumination; while Dr. H. S. Elworthy adduced data to show that the colour of the reflected light, depending chiefly on the nature of the coal-surface, was also an influential factor. Medical men from various mining districts emphasised the complexity of the problem, but there was general agreement that illumination and the dark nature of the reflecting surface in coal-mines were important factors. A variety of types of miners' lamps were exhibited, and Mr. E. Fudge, secretary of the Home Office Committee on Miners' Lamps now sitting, made some remarks on possible developments. The question of whitewashing coal-surfaces in order to improve the reflection of light was also considered. At the conclusion of the discussion Mr. L. Gaster suggested a comprehensive investigation by competent photometric experts, aided by ophthalmic surgeons, in order to obtain data on a uniform basis, establish the nature of the conditions of illumination to be guarded against, and consider possibilities of meeting lighting requirements.

AN interesting paper on the theory and practice of lubrication was read by Messrs. Wells and Southcombe before the London Section of the Society of Chemical Industry on February 2. Free fatty acids in lubricants have hitherto been judged mainly by the injurious effects which they are capable of causing. It has now been found, however, that these acids, in strictly limited amount, can greatly increase the value of mineral oils as lubricants. Tested in a Thurston friction machine under conditions of very low speed and high pressure, it was found that 0.5 per cent. of the fatty acids of rape-oil added to a mineral oil reduced the friction coefficient from 0.0066 to 0.0049, whilst nearly 60 per cent. of the same rape-oil free from acid was required to produce the same effect. It appears, therefore, that this discovery affords the means of diverting to other and more useful purposes

the greater part of the saponifiable oils and fats now used for blending with mineral oils.

In a paper read to the Institution of Petroleum Technologists on February 17, Dr. W. R. Ormandy describes a number of patents which have been taken out for mixtures intended to be used as motor fuels. Protesting against the present system, he states that patents have been granted for admixtures of bodies which every chemist knows will mix, and every engineer knows will drive an internal-combustion engine. Many of them are certainly not inventions or discoveries. Presumably the patents have been granted because the patent records of the preceding fifty years cannot show that anything of the sort has previously been patented. But it is common knowledge to those skilled in the matter that such liquids as paraffin, petrol, benzol, alcohol, ether, and acetone will mix either in any proportion or in restricted proportions; and also that by admixture, for example, of petrol with benzol a certain amount of alcohol can be caused to dissolve in the mixture which would not dissolve in the petrol alone. It is equally common knowledge to chemists and engineers that any admixture of two or more volatile fuel bodies will result in a third substance also capable of being used as a fuel. Disclaiming any intention of expressing a pronounced opinion on any of the specifications, the author regards it as prejudicial to the general interests of the community that such patents should exist, and has no doubt that they contain the seeds of many lawsuits.

We have received from Messrs. Flatters and Garnett, Oxford Road, Manchester, their price-list of stains, chemicals, slides, cover-glasses, dissecting instruments, etc., for use in microscopical and histological work. The list of stains, which are all tested, seems fairly complete, and the solids are supplied in quantities of 2½, 5, 10, and 25 grams. With a selection of this kind to choose from, the worker in these branches of science should be independent of foreign supplies.

Messrs. Methuen and Co., Ltd., will publish shortly a translation by Mr. R. W. Lawson, of the University of Sheffield, of "The Special and the General Theory of Relativity," by Prof. Einstein. The volume is primarily intended for those who are not conversant with the mathematical analysis used in theoretical physics, the aim of the author being to give the main ideas of the theory of relativity in the clearest and simplest form.

A COURSE of lectures was delivered in the University of London in 1913 by Prof. E. Bresslau, of the University of Strassburg, and a volume based on them, bearing the title of "The Mammary Apparatus of the Mammalia in the Light of Ontogenesis and Phylogenesis," with a preface by Prof. J. P. Hill, is to be issued by Messrs. Methuen and Co., Ltd., this spring. It will provide an epitome of Prof. Bresslau's investigations on the development of the milk-glands and related parts in the mammalia, and of his conclusions respecting the evolutionary history of the mammary apparatus, and be fully illustrated.

### Our Astronomical Column.

**OCULTATION OF A STAR BY SATURN.**—Mr. A. Burnet has pointed out that the star Lalande 20654 (mag. 7.3) will be occulted by Saturn on the evening of March 14. Mr. L. J. Comrie gives some further details and a diagram in the *Journal of the British Astronomical Association* for January. At Greenwich the star disappears at 7h. 5m. in position angle  $281^\circ$ , just to the north of the ring, reappearing at 8h. 40m. in angle  $121^\circ$ . The star will pass very close to Titan about 12h. 15m., and an occultation by that satellite will probably occur somewhere on the earth; hence it is important to observe the conjunction with care, and, if an occultation occurs, to take the times of disappearance and reappearance, as a useful determination of Titan's diameter might be made from such observations. A central occultation would last about five minutes.

**THE NAUTICAL ALMANAC FOR 1922.**—This volume has lately been issued, and is of interest as being the last almanac in which the places of the moon are based on Hansen's tables; these were first used in the 1862 almanac, but, starting with 1883, Newcomb's corrections have been applied to them. For ten years after this the errors of the almanac places of the moon were very small, then they began to mount up, and now reach nearly 1 sec. in R.A. The introduction of Brown's tables in the 1923 volume will greatly reduce this error, but will not remove it entirely, since Dr. Brown has preferred not to introduce a term of some sixty years' period which is indicated by the observations.

**CALENDAR REFORM.**—This question, which was suspended during the war, is again coming to the front. The majority of the reformers agree on the following points:—(1) That each quarter should have ninety-one days (thirteen weeks), there being two months with thirty days and one with thirty-one, these lengths repeating themselves in the same order in each quarter; (2) that one day in each year, and a second day in leap year, should stand outside the week, so that the week-days repeat themselves alike in every year; and (3) that the leap day should come at the end of the year, its position in the second month being extremely inconvenient. Mr. Alexr. Philip proposes to begin the year with March, thus restoring the meaning of the names September, etc. He further suggests that the day outside the week should be Whit-Sunday, which is put at the end of the first quarter (May 31); it is immediately followed by an ordinary Sunday, taking advantage of the fact that the day following Whit-Sunday is already a general holiday. Easter Sunday on this plan would always be on April 12. The leap day would come as now, at the end of February, but this would then be the last month of the year. He further suggests that, if it be desired to keep the months as nearly as possible at their present lengths, his scheme would involve no greater change than that August should give one day to February.

M. Flammarion's scheme, reprinted in the *Annuaire Astronomique* for 1920, is similar, but more revolutionary. He would begin the year at the vernal equinox, giving new names to all the months. Their lengths in each quarter would be 30, 30, and 31 days. Easter would be the 21st of the first month (corresponding with April 10). The extra-week day and the leap day would both come at the end of the year.

It would seem desirable that all reformers should agree to adopt one of the many schemes that have been proposed, as unanimity is required to give sufficient driving power to carry any reform. The fact that the present most illogical calendar has survived so long is a forcible illustration of the strong conservatism of mankind.

NO. 2627, VOL. 105]

### The Association of Technical Institutions.

**T**HE twenty-seventh annual general meeting of the Association of Technical Institutions was held in the Cordwainers' Hall, E.C., on Friday and Saturday last, February 27 and 28. The meeting was opened by the retiring president, Lord Sydenham. The Marquess of Crève, K.G., was elected president for the year 1920, and delivered his inaugural address, in which he dealt at length with the working of the Education Act of 1918, especially in its relation to continuation schools, and went on to plead strongly for better education and training in the science and methods of agriculture, certainly our oldest, and possibly our largest and most vital, industry. No industry demands for its successful prosecution a sounder knowledge of the various sciences, including chemistry, botany, geology, bacteriology, entomology, meteorology, and engineering. Modern agriculture is a complex business, and measures should be taken for the due training of all concerned, whether engaged in it on a small or a large scale, and especially in the scientific study and practice of forestry. One of the fruits of the great war was seen in the newly awakened interest of employers in the applications of science to industry, and in their greater readiness to find appointments and opportunities for students who, on the foundation of a good general education, had specialised in scientific subjects and showed themselves willing and able to undertake important research. In this regard we could learn valuable lessons from American practice. It was gratifying to observe also the keenness displayed by the general class of workers, who, under the auspices of the Workers' Educational Association, are now, with shorter traditions and scantier leisure than other social classes, interesting themselves in liberal studies relating to literature and history, and in social and political economy. It is all to the good in the building up of an educated nation.

The report for the year 1919 was submitted, showing that the membership of the association now comprised 108 institutions, the highest in its history, being an increase of ten over that of 1914. Steps have been taken to bring before the Board of Education the necessity for providing not only facilities, either in full-time or vacation courses, for persons desiring to become teachers in the new continuation schools set forth in the Education Act of 1918, but also opportunities for present continuation-school teachers who need further training in this special form of educational work. It was suggested by the council that full-time courses might be of one year's duration or not shorter than six months, and that in the event of approved teachers so devoting themselves the Board might consider favourably the question of granting a maintenance allowance for such teachers. The council was assured of the sympathy of the Board in this matter, especially in the case of demobilised officers, and that a maintenance allowance would be made.

The question of pensions for teachers in technical institutions had also been considered and information thereon sought from the Board, which states that, with the approval given by the Treasury, the following will be accepted as counting for *qualifying* service, namely, in private schools (prior to April 1, 1910), provided they are conducted on the same standards of efficiency as schools under public management; as inspectors of schools under any Government Department in England, Scotland, or Ireland; as officials of the Board of Education or of the Scotch or Irish Education Department; as officials of a local education authority whose salaries are paid out of the education rate; as officials of any school or educational institution (not conducted for private profit), including a university, if the institution is one, teaching service

in which would be regarded as recognised and qualifying service; in the case of trade or commercial instructors, five years of practical experience or not more than seven years in special cases; in any university or university college; in any school receiving grants provided by a Government Department; as a supplementary teacher in a public elementary school; in any school in any British Colony or Dependency or in India, aided or under regular inspection by the Government; in any foreign country where there exists an arrangement for the interchange of teachers made by the Board of Education.

The question of salaries for teachers of various grades in technical institutions had been carefully considered, and the following scale was submitted to, and approved by, the meeting, and ordered to be forwarded to local education authorities and the governing bodies of technical institutes for their consideration, namely: Principals in four grades of schools ranging from 1250*l.* down to 500*l.*, and rising by annual increments during five years to 1500*l.* and 750*l.*; heads of departments in three grades ranging from 600*l.* down to 400*l.*, and rising by annual increments during ten years to 900*l.* and 600*l.*; heads of junior technical and commercial schools to be classed as heads of departments; lecturers in three grades ranging from 400*l.* down to 250*l.*, and rising by annual increments during three years to 600*l.* and 400*l.* respectively.

In a paper by Mr. A. Mansbridge on "Technical Schools and their Part in Adult Education," it was urged that a great crusade against the unworthy use of leisure is a pressing need of the time. There can be no better way for the worker to tread in his off-hours than that which leads to the development of his interests or his skill. Technical training can, however, never flourish in a community which does not regard the matters with which it deals as of fundamental importance to the whole health of man. A nation which merely regards it as a means of outstripping others must always be content with superficial achievement. The education of a man lies deeper than the pursuit of knowledge or training. Some turn to the influencing or contemplation of the ideas and movements of men, others to the creation of material things, and each alike serves his generation if the direction be true. Mr. Mansbridge pleaded that the technical institutes should make provision for adult men and women to study in their leisure time the matters, technical or non-technical, in which they are interested, or rather for which they possess the necessary aptitude. He asked that serious attention should be given to the notable Report of the Committee on Adult Education issued in July last.

A paper was read on "Day Continuation Schools" by Mr. H. J. Taylor, of Dewsbury, in which he urged that a hearty response should be given to the invitation of Mr. Fisher to local education authorities to establish these schools voluntarily on the lines laid down by the Board of Education in its recent circular, namely, that such schools must give as great a measure of liberal education, both physical and mental, as opportunity and time afford. Mr. Taylor contended that the most effective way in which the conditions could be met was by arranging for a complete day each week for groups of boys and girls, and cited the efforts of the Dewsbury Education Committee and of the employers of the town (without reducing the wages of their employees) to establish such a school as illustrating its possibility.

A further paper was read by Dr. R. S. Clav, of the Northern Polytechnic, London, in which he advocated an ampler provision of scholarships throughout the whole sphere of education by the institution to each ten thousand of the population of six junior scholar-

ships from elementary to secondary schools, six industrial scholarships, three intermediate scholarships to enable the recipients to continue their education at the secondary school until the age of eighteen or nineteen, one senior scholarship to the university or the technical institute, and one post-graduate or research exhibition tenable at the close of the graduate course.

Resolutions were adopted dealing with lengthened vacations, so that teachers of special subjects should have facilities for keeping in touch with industrial developments; maximum teaching hours for ordinary lecturers and heads of departments; the appointment of a consultative committee comprised of representatives of industry, and including representatives of universities and technical institutions, to advise the university and technological branches of the Board of Education on all matters affecting the relationship of university and higher technical education to industry; and, finally, the provision that should be made in the preparation of schemes required by the Education Act of 1918 for the continuation of study on the part of science teachers by means of suitable tutorial courses of science lectures and practical work, together with facilities to attend meetings of scientific and technical societies and to visit special educational centres and industrial works.

### The Einstein Deflection of Light.

THE idea of detecting the Einstein deflection by measures of two neighbouring stars has occurred to many people, and Prof. C. V. Raman writes to suggest that the apparent distance of the two components of a binary star may be influenced by the effect. It seems, therefore, worth while to examine the conditions, and to try to discover whether any sensible effects are to be expected.

First, it is easy to show that where the linear distance between the two stars is small compared with their distance from the sun, then the angular shift of the further star, due to the Einstein effect, is diminished as seen from the sun in the approximate ratio: Distance between the stars/their distance from the sun. That is, it becomes absolutely evanescent, and the effect suggested by Prof. Raman is non-existent.

Secondly, let the two stars be at different distances from the sun; for simplicity, take the distance of the



FIG. 1.—To illustrate the production of an image of a distant star by the gravitational bending of its light by a nearer one.

nearer star as half that of the further; let their angular diameters be 0.002" and 0.001" respectively, and let the angular distance between them be 1". Then the light from the further star passes the nearer star at a distance of 1000 of its radii. If the bending of a grazing ray be 2", the bending in the actual case is 0.002", and the apparent shift as seen from the sun 0.001". It appears that in no case where the two star-discs are sufficiently far apart to be easily separable is the Einstein shift appreciable.

A second Einstein effect has been imagined, viz. the formation of an image of the distant star on the reverse side of the nearer one. From C, the centre of the latter, draw tangents CA, CB, and produce them backward to DE. Then DE is one-millionth of a second. Now it is only along the arc DE that the Einstein image is produced, and the radial diameter

of the image can easily be shown to be of the same order as DE; whence the angular area of the image is, say, one-millionth of the area of AB; and since no optical arrangement can increase the surface brilliancy of an image, the latter is fifteen magnitudes fainter than AB, and therefore utterly invisible.

It is only when two stars approach each other so closely that their discs are almost in contact that any sensible Einstein effect occurs; and since the two discs are in this case absolutely inseparable, the visible effect would be simply a slight brightening. In view of (1) the rarity of such close appulses, (2) the impossibility of predicting them, and (3) the transient nature of the brightening, which would last for only a few days, the prospect of detecting such a phenomenon is very small.

The outburst of novæ cannot be explained in this manner, as some have suggested, for it could not possibly produce a ten-thousandfold increase in light; moreover, the light-curve before and after maximum would be exactly symmetrical, which is assuredly not the case with novæ, the increase of light being much more rapid than the decline.

It is to be noted that even if some brightening were observed in an appulse, it would be impossible to say whether the light-bending followed the Newtonian or the Einstein law.

A. C. D. CROMMELIN.

### The New Zealand Institute.

THE publication of the fifty-first volume of the Transactions and Proceedings of the New Zealand Institute marks the commencement of a new epoch in the history of that very vigorous scientific organisation. The volume itself compares very favourably with those of past years, and its contents show that there is at least one part of the British Empire where pure science is being cultivated as strenuously as before the war. We are glad to see that the institute is receiving more support from the New Zealand Government, while the large membership of the nine constituent societies scattered throughout the Dominion clearly indicates the influence which it is exerting upon the New Zealand public.

The volume opens with obituary notices and portraits of three distinguished New Zealanders—Alexander Turnbull, who devoted his leisure to the collection of a magnificent library, bequeathed to the Dominion, including 32,000 bound volumes, dealing especially with the history of the Pacific Islands; Henry Suter, known throughout the scientific world as a distinguished student of conchology, and author of the "Manual of the New Zealand Mollusca"; and Thomas Adams, who did great work for his adopted country in the promotion of scientific arboriculture.

Of the numerous original memoirs which the volume contains, it is not too much to say that they embody a large amount of information of high scientific value, and if they relate almost exclusively to matters of local interest, dealing chiefly with the fauna, flora, and geology of the islands, this is only as it should be, for it is in these fields that the New Zealand man of science finds his magnificent opportunities. Where there is so much to choose from it is difficult to single out particular contributions for notice, but the attention of zoologists should be directed to the very interesting discovery of a second species of New Zealand frog, *Liopelma Hamiltoni*, found by Mr. Harold Hamilton on Stephen Island, in Cook Straits, and described (with excellent coloured illustrations) by Mr. A. R. McCulloch, of the Australian Museum. This species is closely related to the long-known but rare *Liopelma Hochstetteri* of the North Island, the only previously known New Zealand

amphibian. In the botanical field Dr. J. E. Holloway continues his admirable studies on the genus *Lycopodium*, while geology is well represented by papers by Dr. P. Marshall, Mr. R. Speight, and others. In the department of geophysics Mr. A. W. Burrell contributes a very interesting account of a working model to demonstrate the manner in which ocean currents may be caused by the rotation of the earth.

In conclusion, we may note that the institute has decided to elect a body of fellows, limited to forty in number, who are to have the privilege of writing after their names the letters F.N.Z.Inst.—a distinction which we do not doubt will have a real value in the world of science.

### The Geology of the West Indies.

EARLY in 1914 Dr. T. Wayland Vaughan, of the United States Geological Survey, paid an official visit to several of the smaller West Indian islands, partly with help from the Carnegie Institution of Washington. Besides studying the stratigraphical geology of the islands and making notes on their physiography, he also collected large series of fossils which were sent for detailed examination to Washington. He thus obtained material for a valuable contribution to our knowledge of the Tertiary sedimentary rocks which form the greater part of these islands, and made possible satisfactory comparisons with the corresponding geological formations of the southern United States. Dr. Vaughan has already published several preliminary notes on his results, and an especially important memoir on some fossil corals and the formation of coral-reefs. His final report, however, on the details of local geology and the general conclusions are deferred until all the fossils are examined and described. He has just edited a series of these descriptions, which has been published by the Carnegie Institution (Publication No. 291, 1919) in a small volume illustrated by beautiful photographic plates.

Calcareous algæ from the Eocene limestone of St. Bartholomew and from the Oligocene limestone of Antigua and Anguilla are described by Mr. Marshall A. Howe. Lithothamnium and related forms are well illustrated by enlarged sections. The Foraminifera are not only described with excellent figures by Mr. J. A. Cushman, but also discussed from the geological point of view. Some of the larger orbitoid species make correlations possible with corresponding rocks both in continental America and in Europe, while the small Miocene species allow very definite correlations with Panama and the coastal plain of the United States. The Bryozoa, described by Drs. F. Canu and R. S. Bassler, are of Upper Oligocene and Lower Miocene age, and notes are added on the distribution of those species which occur in other parts of the world. The Eocene and Oligocene mollusca, described by Mr. C. W. Cooke, are of great geological importance, and comparisons are facilitated by faunal lists. The account of the Decapod Crustacea, by Miss Mary J. Rathbun, is almost entirely new, only two species of one genus (*Ranina*) having previously been recorded from the Tertiary formations of the West Indies. A few genera are distinctively American, but some have close affinity with those at present living in the Indo-Pacific region.

We congratulate Dr. Wayland Vaughan and his colleagues on the thoroughness with which they are accomplishing their task, and we look forward to the publication of the concluding sections of this great contribution to the geology and palæontology of the Central American region.

### University and Educational Intelligence.

**BELFAST.**—Dr. James Small, lecturer on botany in Bedford College, London, and in the London School of Pharmacy, has been appointed professor of botany in succession to Prof. Yapp.

**CAMBRIDGE.**—It has already been announced that a friend of Girton College has given 10,000*l.*, to be applied, both capital and interest, during the next twenty years for the encouragement of research by women in mathematical, physical, and natural sciences. We now learn that a fellowship of the value of 300*l.* a year is offered by the college for research in such sciences as chemistry, electricity, engineering, botany, geology, medicine, agriculture, etc. The election of the fellow will take place in time to permit of the award by the council being made not later than June 30. Women who are graduates or have taken honours in a final degree examination of any university, and members of the Girton College Roll, are eligible for the fellowship. The fellow will be elected for three years in the first instance. Applications for the fellowship must be sent to the secretary of the college on or before March 31. Each candidate should describe a course of research and submit a dissertation or published work, in addition to any other evidence she may desire to furnish of her fitness to undertake the proposed course of research.

**LONDON.**—The Senate has received two letters from Viscount Haldane of Cloan, chairman of the Sir Ernest Cassel Educational Trust, offering important gifts in connection with the new degrees in commerce. The trustees offer an endowment of 150,000*l.* in War Loan, producing 7500*l.* a year, for the provision of eight, or possibly more, teaching posts in banking and currency, foreign trade, accountancy and business methods, transport and shipping, industrial organisation, and commercial law, and propose that these should include three Sir Ernest Cassel professorships in banking and currency, foreign trade, and accountancy and business methods respectively. They further suggest that the teaching in all the above-named subjects should be given at the London School of Economics, it being understood that accommodation for increased teaching is to be provided in the new buildings now being erected at the school, with the assistance of the sum of 50,000*l.* recently given by the General Committee for Degrees in Commerce, on the new site granted by the London County Council. The trustees also offer to allot to the University an annual grant up to 3000*l.* a year, for five years in the first instance, for the provision of additional instruction in the following modern languages required to meet the needs of students in commerce: French, German, Spanish, Portuguese, Italian, Russian, and Arabic, together with a further sum of 1000*l.* for the current year to meet the expenditure on additional modern-language instruction incurred during this year. They also place at the disposal of the University a sum of 1000*l.* a year, in the first instance for five years, for travelling scholarships for the benefit of students in commerce. The offers have been accepted by the Senate, and the Vice-Chancellor has been asked to convey to Sir Ernest Cassel and to the chairman of the Cassel Trust "the warmest thanks of the Senate for these great gifts for the cause of education, from which they anticipate the most fruitful results."

Dr. James McIntosh has been appointed as from March 1 to the University chair of pathology tenable at the Middlesex Hospital Medical School. During the war Dr. McIntosh carried out investigations at the Royal Herbert Military Hospital, Woolwich, on cerebro-spinal fever, and at the London Hospital on

gas-gangrene. For the last nine months he has been a full-time investigator on the staff of the Medical Research Committee. Dr. McIntosh is the author of numerous reports and other articles in medical and scientific journals.

Dr. Sidney Russ has been appointed as from March 1 to be the first incumbent of the Joel chair of physics tenable at the Middlesex Hospital Medical School. The work of this professorship, recently established by the munificence of Messrs. S. B. and J. B. Joel, will deal especially with physics in relation to medicine. From 1906 to 1910 Dr. Russ was demonstrator in physics at the University of Manchester, and was appointed physicist to the Middlesex Hospital in 1913. He is the author of a large number of articles and other papers dealing with radio-activity and other aspects of medical physics.

The following have been appointed fellows of University College:—Mr. F. J. F. Barrington, assistant surgeon, Surgical Unit, University College Hospital; Mr. W. C. Clinton, assistant professor in the department of electrical engineering and Sub-Dean of the college faculty of engineering; Miss Ethel M. Elderton, Galton research fellow in the department of applied statistics and eugenics; Dr. T. H. C. Stevenson, superintendent of statistics at the General Register Office, and fellow and joint secretary of the Royal Statistical Society; and Dr. Ethel N. Thomas, lecturer in the department of botany, and keeper of the department of botany in the National Museum of Wales.

The degree of D.Sc. (Economics) has been conferred on Mr. W. Rees, an internal student, of the London School of Economics, for a thesis entitled "An Agrarian Survey of South Wales and the March, 1284-1415."

On Wednesday next, March 10, at 5.30 p.m., Lord Moulton will deliver an address at University College on "The Training and Functions of the Chemical Engineer." Prince Arthur of Connaught will preside.

**OXFORD.**—The King has been pleased to approve of the appointment of Sir Archibald E. Garrod, K.C.M.G., F.R.S., to be Regius professor of medicine in the University in succession to the late Sir William Osler, Bart.

The fellowship diploma of the Royal College of Science for Ireland has been awarded to Mr. Hugh Ramage and Mr. R. L. Wills.

MR. W. D. EGGAR will deliver a course of four public illustrated lectures on "Optics" at Gresham College, Basinghall Street, E.C.2, at 6 o'clock, on March 9, 10, 11, and 12, in place of the course announced for delivery by the Gresham professor of geometry, who is suffering from illness.

The Master and fellows of Corpus Christi College, Cambridge, propose to elect in July next a holder of the Almeric Paetz studentship in political science, economics, and kindred subjects. The studentship is of the value of 150*l.*, and tenable for one year. Applications should be addressed to Mr. W. Spens, Corpus Christi College, Cambridge, by, at latest, July 1.

The next of the series of lectures for teachers on "Recent Developments in Science," arranged by the Education Officer of the London County Council, will be on "The Dye Industry," by Prof. G. T. Morgan, and will be delivered at Finsbury Technical College, Leonard Street, City Road, E.C.2, on Saturday, March 20, at 11 a.m. The chair will be taken by Dr. M. O. Forster.

H.R.H. PRINCE ARTHUR OF CONNAUGHT will preside on March 19 at a luncheon to be held at the Savoy

Hotel, when the proposals for the reconstruction and re-equipment of the engineering laboratories at University College, London, will be explained by the treasurer, Sir Ernest Moir, and others. It will be remembered that an appeal for 100,000l. towards this object was recently issued. Already more than 33,000l. has been collected—that is, about one-third of the total sum required. It is urgently necessary that the whole fund should be subscribed by June at the latest, in order that the buildings may be put in hand. Further donations should be sent to H.R.H. Prince Arthur of Connaught at 42 Upper Grosvenor Street, W.1.

IN *School Hygiene* (vol. xi., No. 1, February) Dr. A. A. Mumford puts forward an interesting scheme for the investigation and standardisation of the physical efficiency of children which is characterised by the breadth of view we should expect from the author of the "History of the Manchester Grammar School." Grading his subjects in six age-groups from two to eighteen, he indicates the materialistic tests which are appropriate. A boy of about thirteen, for example, should be able to run 100 yards in 14 seconds; for the oldest boys Flack's manometer test of expiratory force is of value. But realising, as medicine has come to realise more and more in recent years, the influence of the mind on the body, he emphasises the necessity of studying the emotional incentives to be found in the imagination, and would have the school medical officer pay attention to sulkiness as much as to adenoids. In the discussion of the paper Dr. Lempiere, of Haileybury, describes the quick, practical utility of height-weight ratios as indices of physical progress. Athletes are taller and heavier than the average, "crocks" shorter and lighter; it is, perhaps, characteristic that nothing is said about the physical qualities of the scholars and dances.

## Societies and Academies.

LONDON.

**Royal Society**, February 19.—Sir J. J. Thomson, president, in the chair.—B. Moore and T. A. Webster: Studies of photosynthesis in fresh-water algæ. (1) The fixation of both carbon and nitrogen from the atmosphere to form organic tissue by the green plant-cell. (2) Nutrition and growth produced by high gaseous dilutions of simple organic compounds, such as formaldehyde and methyl alcohol. (3) Nutrition and growth by means of high dilutions of carbon dioxide and oxides of nitrogen without access to atmosphere. The primeval living organism, like the inorganic colloidal systems which were its precursors, must have possessed the power of fixing carbon and nitrogen, and building these up into reduced organic compounds with uptake of energy. The source of the energy was sunlight. This power is still possessed by the lowliest type of synthesising cell existing, namely, the unicellular alga. A synthesising cell must have existed prior to bacteria and other fungi, since these can exist only upon organic matter, and the primeval world before the advent of life could contain no organic matter. Their specific reactions show that even the ultra-microscopic filter-passing organisms are highly organised products on the path from the inorganic towards life, and hence it follows that there is a long intermediate range of evolution. The first synthesising system acting upon light was thus probably an inorganic colloidal system in solution, capable of adsorbing the simple organic substances which it synthesised. It is therefore futile to search for the origin of life at the level of bacteria and torulae.

As complexity increased with progressive evolution, more and more rapid transformers for the capture of the energy of sunlight came into existence. Such transformers are found in the green cell for fixation of both carbon and nitrogen. The earlier transformers in the inorganic colloidal systems can only utilise light of short wave-lengths; the later transformers in the living cells are adapted to utilise longer wave-lengths; and the very short wave-lengths, which are lethal, are cut off by their colour-screens of chlorophyll, etc.—W. M. Bayliss: The properties of colloidal systems. iv.: Reversible gelation in living protoplasm. With intense dark-ground illumination it is possible to see that the apparently clear pseudopodia of *Amoeba* are filled with numerous very minute particles in Brownian movement, thus affording further evidence of the liquid, hydrosol nature of simple protoplasm. By electrical stimulation this sol can be reversibly changed into the gel state, evidenced by the sudden cessation of the Brownian movement.—F. J. Wyeth: The development of the auditory apparatus in *Sphenodon punctatus*. This memoir contains a detailed and fully illustrated account of the development of the auditory apparatus and associated structures in the New Zealand Tuatara. As this important type is on the verge of extinction, it was thought desirable to treat the subject fully, although, as might be expected, the developmental history agrees closely with that found in other reptiles. The work was carried out chiefly by means of wax-plate reconstruction models. The third and fourth visceral clefts are closed by a backwardly growing operculum, but separate dorsal and ventral openings of the clefts were not observed. The existence of two pairs of head-cavities was confirmed, those of each pair communicating with each other by transverse canals. The vascular system was found to exhibit a number of primitive features. The region investigated includes cranial nerves vi.-xii., the development of which was worked out in detail. The general development of the internal ear and auditory nerve is thoroughly normal. The development of the cristæ and maculae acusticæ from the primitive neuroepithelium is given in detail. A well-marked macula neglecta is found. As regards the much-debated question of the origin of the columellar apparatus, evidence is brought forward in support of the contention that this is essentially a derivative of the hyoid arch, and it is maintained that the auditory capsule contributes at most a portion of the foot-plate of the stapes.

**Linnean Society**, February 19.—Dr. A. Smith Woodward, president, in the chair.—Major H. C. Gunton: Entomological-meteorological records of ecological facts in the life of British Lepidoptera. The author believed that interesting facts would be obtained by recording and plotting the results of observations made by a number of entomologists in various localities. The scheme exhibited was derived from his notes from February to December, 1919, within a radius of four miles from Gerrard's Cross, Bucks, which includes oak and beech woods, heath, marsh, and cultivated land. Special signs are used to denote the occurrence of species of macro-Lepidoptera on sallow-bloom in the spring, ivy in the autumn, sugar, and light. Thirty-five species of butterflies and two hundred and forty species of moths are thus tabulated and correlated with meteorological data. The diagram places many facts before the eye, as the long continuance of certain species, the presence of more than one brood, and the like. Sugar scarcely appeals when honey-dew is abundant, and artificial light is ineffective during bright moonlight. Other problems, as of immigration, still await solution.

## PARIS.

**Academy of Sciences**, February 9.—M. Henri Deslandres in the chair.—P. A. Dangeard: The plastidome, vacuome, and spherome in *Selaginella Kraussiana*.—G. Charpy: The minute fissures in steel ingots. The mode of formation and method of detection of minute cavities in steel ingots are described, together with an account of their alteration during rolling and forging.—M. Leclerc du Sablon was elected a correspondant for the section of botany in succession to the late M. Farlow, and M. Lugon correspondant for the section of mineralogy in succession to M. Walcott, elected foreign associate.—C. Rabut: The reduction of contact transformations.—R. Birkeland: A reduction of Abelian integrals.—J. Bourquart: The Quaternary glaciation of Central Albania.—L. and E. Bloch: Some new spark spectra in the extreme ultra-violet. Measurements for wavelengths between 1855 and 1500 Å.U. are given for the ultra-violet spectra of cadmium, bismuth, nickel, and silver.—J. A. Le Bel: New observations on catalytic phenomena.—D. Gauthier: The synthesis of  $\alpha$ -ketonic tertiary alcohols. A correction relating to the constitution of a body previously described.—J. Guyot and L. J. Simon: The action of water on methyl chlorosulphonate.—A. Mailhe and F. de Godon: The catalytic formation of ether oxides. Calcined alum is an excellent reagent for the conversion of ethyl alcohol into ether, with a yield of 71 per cent. This reaction has been extended to propyl alcohol (yield of ether 54 per cent.), isopropyl alcohol (yield 10 per cent.), isoamyl alcohol (yield 28 per cent.), and mixtures of alcohols. In the last case mixed ethers can be prepared.—P. Bertrand: The normal succession of the coal flora in the Gard coal basin.—L. Besson: Extraordinary haloes.—A. Loubière: The fungi of Brie cheese.—E. F. Galiano: The histology of the branchial hearts of *Sepia officinalis* and their appendices.—V. Gallpe: Researches on the evolution of the protoplasm of certain plant-cells by the method of culture.—G. Bertrand and M. Brocq-Roussen: The destruction of rats by chloropicrin. Both the rat and the rat-flea are readily destroyed by the vapour of chloropicrin, and, as this substance is without action upon cloth materials and dyes, it can be utilised for the destruction of rats in ships.

## Books Received.

A Course of Practical Chemistry for Agricultural Students. By L. F. Newman and Prof. H. A. D. Neville. Vol. i. Pp. 235. (Cambridge: At the University Press.) 10s. 6d. net.

A Treatise on the Mathematical Theory of Elasticity. By Prof. A. E. H. Love. Third edition. Pp. xviii+624. (Cambridge: At the University Press.) 37s. 6d. net.

Pastimes for the Nature Lover. By Dr. S. C. Johnson. Pp. 136. (London: Holden and Hardingham, Ltd.) 1s. net.

Department of Applied Statistics, University of London, University College. Drapers' Company Research Memoirs. Biometric Series. X: A Study of the Long Bones of the English Skeleton. By Karl Pearson and Julia Bell. Part i.: The Femur. Text, chaps. i. to vi., pp. v+224; Atlas, pp. vii+plates lix; and Tables of Measurements and Observations. Part i., section ii. Text, pp. 225-539; Atlas, pp. vii+plates lx-c. (Cambridge: At the University Press.) Part i., Text and Atlas, 30s. net; part i., section ii., Text and Atlas, 40s. net.

Tanks in the Great War, 1914-1918. By Brevet-Col. J. F. C. Fuller. Pp. xxiv+331+vii plates. (London: John Murray.) 21s. net.

The Heron of Castle Creek, and other Sketches of Bird Life. By A. W. Rees. Pp. 218. (London: John Murray.) 7s. 6d. net.

The Soil: An Introduction to the Scientific Study of the Growth of Crops. By Sir A. D. Hall. Third edition. Pp. xv+352. (London: John Murray.) 7s. 6d. net.

Medieval Medicine. By Prof. J. J. Walsh. Pp. xii+221. (London: A. and C. Black, Ltd.) 7s. 6d. net.

Laboratory Manual of Elementary Colloid Chemistry. By E. Hatschek. Pp. 135. (London: J. and A. Churchill.) 6s. 6d.

Euclid in Greek. Book i. With Introduction and Notes. By Sir Thomas L. Heath. Pp. ix+239. (Cambridge: At the University Press.) 10s. net.

Sleeping for Health. By Dr. E. F. Bowers. Pp. 128. (London: G. Routledge and Sons, Ltd.) 2s. 6d. net.

Animal Foodstuffs: Their Production and Consumption, with Special Reference to the British Empire. By Dr. E. W. Shanahan. Pp. viii+331. (London: G. Routledge and Sons, Ltd.) 10s. 6d. net.

Intermediate Text-book of Magnetism and Electricity. By R. W. Hutchinson. Pp. viii+620. (London: W. B. Clive.) 8s. 6d.

The Mineralogy of the Rarer Metals. By E. Cahen and W. O. Wootton. Second edition. Revised by E. Cahen. Pp. xxxii+246. (London: C. Griffin and Co., Ltd.) 10s. 6d.

The Running and Maintenance of the Marine Diesel Engine. By J. Lamb. Pp. xii+231+4 plates. (London: C. Griffin and Co., Ltd.) 8s. 6d.

Memoirs of the Geological Survey, Scotland. Special Reports on the Mineral Resources of Great Britain. Vol. xi.: Iron Ores (continued). The Iron Ores of Scotland. By M. Macgregor and others. Pp. vii+240. (Edinburgh: H.M.S.O.; Southampton: Ordnance Survey Office.) 10s. net.

Motion Study for the Handicapped. By F. B. Gilbreth and Dr. L. M. Gilbreth. Pp. xvi+165. (London: G. Routledge and Sons, Ltd.) 8s. 6d. net.

Qualitative Analysis in Theory and Practice. By Prof. P. W. Robertson and D. H. Burleigh. Pp. 63. (London: E. Arnold.) 4s. 6d. net.

Tychonis Brahe Dani Opera Omnia. Eddidit J. L. E. Dreyer. Tomus vi. Pp. v+375. (Hauniae: Libraria Gyldendaliana.)

Moses: The Founder of Preventive Medicine. By P. Wood. Pp. xi+116. (London: S.P.C.K.) 4s. net.

Manual of American Grape-Growing. By W. P. Hedrick. Pp. xiii+458+xxxii plates. (New York: The Macmillan Co.; London: Macmillan and Co., Ltd.) 17s. net.

## Diary of Societies.

THURSDAY, MARCH 4.

ROYAL INSTITUTION OF GREAT BRITAIN, at 3.—Lt.-Col. E. Gold: The Upper Air; (f) Modern Methods of Investigation, and their Application in the War.

Royal Society, at 4.30.—Dr. F. Blackman: The Protoplasmic Factor in Photosynthesis.—G. E. Briggs: The Beginning of Photosynthesis in the Green Leaf.—Prof. B. Moore, E. Whitley, and T. A. Webster: Sunlight and the Life of the Sea.

LINNEAN SOCIETY, at 5.—Dr. A. B. Rendle, E. G. Baker, and S. L. Moore: A Contribution to the Flora of New Caledonia based upon the Collections of R. H. Compton in 1914.

ROYAL COLLEGE OF PHYSICIANS, at 5.—Dr. A. Castellani: The Higher Fungi in relation to Human Pathology (Milroy Lecture).

ROYAL INSTITUTE OF PUBLIC HEALTH, at 5.—Dr. T. G. Maitland: Hospital Treatment of Pulmonary Tuberculosis.

ROYAL SOCIETY OF MEDICINE, at 5.30.—Dr. W. Edgecomb: Visceral Fibrosis.—Discussion on paper by Dr. Ferreyrolle: Immunity and Mineral Water Treatment.

CHEMICAL SOCIETY, at 8.—E. H. Rennie, W. T. Cooke, and H. H. Finlayson: An Investigation of the Resin from Species of *Xanthorrhiza* Not Previously Examined.—L. S. Bagster: The Reaction between Nitric Acid and Copper.—M. Chikashige: Ancient Oriental Chemistry and

ALLIED ARTS.—J. N. Mukherjee: Coagulation of Metal Sulphide Sols. Part II. Influence of Temperature on the Rate of Coagulation of Arsenious Sulphide Hydrosols.

ROYAL SOCIETY OF MEDICINE (Obstetrics and Gynaecology Section), at 8.—G. Ley: Utero-Placental Apoplexy (Accidental Haemorrhage). An Analysis of Fifty Cases.

#### FRIDAY, MARCH 5

ROYAL ASTRONOMICAL SOCIETY, at 8.—(A. Geophysical Discussion.) J. de Graaf Hunter and Others: The Earth's Axes and Figure.

CONCRETE INSTITUTE (at 295 Vauxhall Bridge Road), at 6.—E. S. Andrews: Some Properties of Steel.

INSTITUTE OF MECHANICAL ENGINEERS, at 6.—Adjourned Discussion on Recent Advances in Utilization of Water Power. E. M. Bergstrom.

INSTITUTE OF ELECTRICAL ENGINEERS (Students' Meeting) (at City and Guilds (Engineering) College), at 7.—Roger T. Smith: Presidential Address.

TECHNICAL GENERAL ASSOCIATION (at the Royal Society of Arts), at 7.30.—W. L. Baillie: Sampling—Some Problems and Fallacies.

JUNIOR INSTITUTION OF ENGINEERS (at 39 Victoria Street), at 7.30.—F. H. Rolt: Notes on Gauge Testing and Measuring Appliances.

ROYAL INSTITUTION OF GREAT BRITAIN, at 9.—Hon. J. W. Fortescue: Military History.

#### SATURDAY, MARCH 6

ROYAL INSTITUTION OF GREAT BRITAIN, at 3.—Sir J. J. Thomson: Positive Rays.

#### MONDAY, MARCH 8

ROYAL INSTITUTION OF GREAT BRITAIN, at 3.—Sir John Cadman: Modern Development of the Miner's Safety Lamp.

ROYAL GEOGRAPHICAL SOCIETY (at Lower Lodge), at 5.

BIOCHEMICAL SOCIETY (Annual General Meeting) (at Institute of Physiology, University College), at 5.30.—S. S. Zilva: The Fat-Soluble Accessory Factor in Cabbage and Carrots.—A. Harden and S. S. Zilva: The Antiscorbic Requirements of the Monkey.—A. Harden and S. S. Zilva: Dietetic Experiments with Carrots.—K. Rosenheim, G. Drummond: The Association of Fat-Soluble A with Lipochrome Pigments.—F. R. Henley: Bacterial Process for the Manufacture of Acetone.

SURVEYORS' INSTITUTION (Junior Meeting), at 7.

ARISTOTELIAN SOCIETY (at 74 Grosvenor Street), at 8.—M. Ginsberg: Excuse a General Will?

MEDICAL SOCIETY OF LONDON, at 8.30.—Dr. W. H. Wilcox: Heat Hyperpyrexia: The Clinical Aspect.—Dr. L. E. Hill: The Physiological Aspect.

#### TUESDAY, MARCH 9

ROYAL HORTICULTURAL SOCIETY, at 3.—J. Hudson: Fruits which can be Grown under Glass without Fire Heat.

ROYAL INSTITUTION OF GREAT BRITAIN, at 3.—Prof. A. Keith: British Ethnology—The Invaders of England.

ROYAL COLLEGE OF PHYSICIANS, at 5.—Dr. J. L. Birley: The Principles of Medical Science as applied to Military Aviation (Goulstonian Lecture).

INSTITUTE OF CIVIL ENGINEERS, at 5.30.—Maj.-Gen. Sir Gerard M. Higney: Royal Engineers' Work in the West.

BRITISH PSYCHOLOGICAL SOCIETY (Education Section) (at London Day Training College), at 6.—D. J. Collar: A Statistical Survey of Arithmetical Ability.

ROYAL PHOTOGRAPHIC SOCIETY OF GREAT BRITAIN (Scientific and Technical Group), at 7.—G. I. Higson: Photomicrography in Photographic Research, at 8.15.—K. Wickham: A New Washing Device and Plate Kicker; (2) Dark-room Illumination by means of Lamps in Liquid Cells.

QUERQUET MICROSCOPICAL CLUB, at 7.30.

#### WEDNESDAY, MARCH 10

ROYAL INSTITUTION OF GREAT BRITAIN, at 3.—Sir John Cadman: Petroleum and the War.

ROYAL SOCIETY OF ARTS, at 4.30.—H. M. Thornton: Gas in Relation to Industrial Production and National Economy.

GEOLOGICAL SOCIETY OF LONDON, at 5.30.—Prof. A. H. Cox and A. K. Wells: The Lower Palaeozoic Rocks of the Arthog-Dolgelley District.

#### THURSDAY, MARCH 11

ROYAL INSTITUTION OF GREAT BRITAIN, at 3.—Lt.-Col. E. Gold: The Upper Air: (ii) Results and their Interpretation.

INSTITUTE OF METALS (at Institution of Mechanical Engineers) (Annual General Meeting), at 4.—Eng. Vice-Admiral Sir George Goodwin: Inaugural Address.

ROYAL SOCIETY, at 4.30.—Probable Papers—W. G. Duffield, T. H. Burnham, and A. A. Davis: The Pressure upon the Poles of Metallic Arcs, including Alloys and Composite Arcs.—J. H. Vincent: Further Experiments on the Variation of Wave-length of the Oscillations Generated by an Ionic Valve Due to Changes in Filament Current.—H. A. Daynes: (1) The Theory of the Katharometer; (2) The Process of Diffusion through a Rubber Membrane.

ROYAL COLLEGE OF PHYSICIANS, at 5.—Dr. J. L. Birley: The Principles of Medical Science as applied to Military Aviation (Goulstonian Lecture).

ROYAL SOCIETY OF MEDICINE (Occasional Lecture), at 5.—Sir Jagadis Bose: Plant and Animal Response (with Demonstrations of Growth by the Magnetic Crescograph).

CHILD-STUDY SOCIETY (at Royal Sanitary Institute), at 6.—Miss M. Jane Keeley: The Educational Needs of Adolescence.

INSTITUTE OF ELECTRICAL ENGINEERS (at Institution of Civil Engineers), at 6.—W. H. Patchell: Operating a By-Product Producer-Gas Plant for Power and Heating.—S. H. Fowles: Production of Power from Blast-furnace Gas.

OIL AND COLOUR CHEMISTS' ASSOCIATION (at a FURNIVAL STREET), at 7.—J. B. Shaw: Various Points in the Manufacture of Lake and Pigment Colours.

OPTICAL SOCIETY, at 7.30.

INSTITUTE OF AUTOMOBILE ENGINEERS (Graduate Section), at 8.—C. A. Chappell: Magnetos.

INSTITUTE OF METALS (at Institution of Mechanical Engineers) (Annual General Meeting), at 8.—Dr. G. D. Bengough, R. M. Jones, and Ruth Pirret: Fifth Report to the Corrosion Research Committee.—R. Selligman and P. Williams: The Action on Aluminium of Hard Industrial Waters.

ROYAL SOCIETY OF MEDICINE (Neurology Section), at 8.30.—Prof. J. S. B. Stopford: Results of End-to-end Suture of Peripheral Nerves.

#### FRIDAY, MARCH 12

INSTITUTE OF METALS (at Institution of Mechanical Engineers) (Annual General Meeting), at 10.30.—J. Neil MacLean: The Art of Casting in High Tensile Brass.—H. Moore and S. Bedkinsale: The Removal of Internal Stress in 70:30 Brass by Low-temperature Annealing.—Dr. W. Rosenblum, J. L. Haughton, and Kathleen Binham: Zinc Alloy with Aluminium and Copper.—Dr. W. Rosenblum: A Model for Representing the Constitution of Ternary Alloys.—A. C. Vivian: Tin-Phosphorus Alloys.—W. C. Hotherhall and E. L. Khead: Some Notes on the Effect of Hydrogen on Copper.

INSTITUTE OF METALS (at Institution of Mechanical Engineers) (Annual General Meeting), at 2.30.—W. E. Alkint: The Effect of Progressive Drawing upon some Physical Properties of Commercially Pure Copper.—F. Johnson: The Influence of Cold Rolling on the Physical Properties of Copper.—J. L. Haughton: The Study of Thermal Electro-motive Force as an Aid to the Investigation of the Constitution of Alloy Systems.—H. H. Hayes: The Polishing and Etching of Zinc for Micro-examination.—W. E. Hughes: Idiomorphic Crystals of Electro-deposited Copper.

ROYAL ASTRONOMICAL SOCIETY, at 5.—F. W. Newman: Absorption of Gases in the Electric Discharge Tube.—F. S. G. Thomas: A New Directional Hot Wire Anemometer.—Dr. Hans Pettersson: Exhibit of a New Micro balance.

MALACOLOGICAL SOCIETY OF LONDON (at Linnean Society), at 6.

ROYAL INSTITUTION OF GREAT BRITAIN, at 9.—W. W. Rouse Ball: String Figures.

#### SATURDAY, MARCH 13

ROYAL INSTITUTION OF GREAT BRITAIN, at 3.—Sir J. J. Thomson: Positive Rays.

## CONTENTS.

	PAGE
Knowledge and Understanding. By W. A. T. . . . .	1
A Natural History of the Feelings . . . . .	3
Radiological Diagnosis of Disease . . . . .	4
The Manufacture of Artificial Fertilisers. By Dr. E. J. Russell, F.R.S. . . . .	4
Our Bookshelf . . . . .	5
Letters to the Editor:—	
Organisation of Scientific Work.—Prof. W. Bateson, F.R.S.; J. S. Gamble, F.R.S.; Sir Ronald Ross, K.C.B., F.R.S.; Dr. E. J. Russell, F.R.S.; Prof. A. C. Seward, F.R.S. . . . .	6
The Constitution of the Elements.—Dr. F. W. Aston . . . . .	8
Deflection of Light during a Solar Eclipse.—J. A. Ormerge; Dr. A. C. D. Crommelin . . . . .	8
Perimeter of an Ellipse.—R. A. P. Rogers . . . . .	8
Scientific Research and the Glass Industry in the United States. By Dr. M. W. Travers, F.R.S. . . . .	9
The Circulating Blood in Relation to Wound-shock. By Prof. W. M. Bayliss, F.R.S. . . . .	10
Characteristics of Pigments in Early Pencil Writing. (Illustrated.) By C. Ainsworth Mitchell . . . . .	12
The Relationship of Education to Research in Aeronautics . . . . .	14
Notes . . . . .	17
Our Astronomical Column:—	
Occultation of a Star by Saturn . . . . .	22
The Nautical Almanac for 1922 . . . . .	22
Calendar Reform . . . . .	22
The Association of Technical Institutions . . . . .	23
The Einstein Deflection of Light. (With Diagram.) By Dr. A. C. D. Crommelin . . . . .	23
The New Zealand Institute . . . . .	24
The Geology of the West Indies . . . . .	24
University and Educational Intelligence . . . . .	25
Societies and Academies . . . . .	26
Books Received . . . . .	26
Diary of Societies . . . . .	27

#### Editorial and Publishing Offices:

MACMILLAN AND CO., LTD.,  
ST. MARTIN'S STREET, LONDON, W.C.2.

Advertisements and business letters to be addressed to the Publishers.

#### Editorial Communications to the Editor

Telegraphic Address: PHUSIS, LONDON.  
Telephone Number: GERRARD 8830.



THURSDAY, MARCH 11, 1920.

### The State and the National Museums.

WHILE reconstruction in almost every direction is in the air, there is a very real danger that the needs of our national museums may escape notice. The time is, indeed, more than ripe for the State to consider with all due care whether their value to the community might not be vastly increased were there some system of co-ordination between them, the connecting links being of sufficient flexibility to allow each of them to perform its proper work without the irksome trammels that accompany undue centralisation. In the course of two reports issued by the late Ministry of Reconstruction, certain suggestions are made for achieving this end; to them we shall refer later. The proposal which we put forward is not very different, but we consider it to be a more complete solution. To apprehend more correctly the nature of the problem, it will be necessary first to set out briefly the origin and the present position of the principal national museums.

Perhaps without exception the museums came into being, not as parts of some wide and comprehensive scheme, but casually and at haphazard because some particular contingency arose and had to be met. The oldest and most famous of them—the British Museum—was founded in 1753 for the purpose of housing and conserving the valuable collections which had been bequeathed to the nation by Sir Hans Sloane, a great antiquary and collector in his day. In the following century the growth of the collections was so great, fed as they were by donations, bequests, and parliamentary grants, and, as regards the library, by the operation of the Copyright Act, that it became necessary in the early 'eighties to transfer the natural history collections to the new buildings at South Kensington which had been erected for their reception. But the rate of growth of the collections tended ever to increase, and additional accommodation was soon urgently needed at both branches of the museum. It was only just before the outbreak of war that a new wing was opened at Bloomsbury by the King and Queen, while the plans which had been prepared for relieving the congestion at South Kensington had, owing to the war, necessarily to be held in abeyance, and it is uncertain when it will be possible to proceed with them.

The original Act of Parliament constituting the museum provided for its governance by a body of trustees; this arrangement still remains, and

no exception could be taken to it were it not for the fact that election to the standing committee of the British Museum has come to be regarded as a distinction to be awarded on quite irrelevant grounds, and that, owing in the past to the little attention given to science in the public schools, this process has not in general led to the selection of trustees most suitable for the Natural History Museum. Despite the actual physical distance between the two branches of the British Museum, and the great difference in the character of the work carried on at the two institutions, they are still officially regarded as one museum, and the Natural History Museum is subordinated to the parent establishment, the official title of its director being Director of the Natural History Departments. There can, unfortunately, be little question that the development of the Natural History Museum has been grievously hampered by the persistent attempt made to fit it to a system devised for the older building, and especially for the great library, which has, in fact, always tended to overshadow the rest of the museum.

The institution which was at one time known as the South Kensington Museum originated in the collections which were purchased at the Exhibition of 1851 on account of the excellence of their art and workmanship. Half a century later the need for expansion had become acute, and plans for new buildings were put in hand, but in the reorganisation of this museum wiser counsels prevailed, and the Science Museum was created a separate institution, quite independent of the Art Museum, afterwards known as the Victoria and Albert Museum. The title of the former museum cannot be considered altogether happy, since it is concerned, not with science in general, but chiefly with engineering and applied mechanics. Both museums are administered by the Board of Education.

The Museum of Practical Geology was a necessary concomitant of the Geological Survey, which was instituted in 1832. Plans had been prepared for bringing this museum and the offices of the Survey to a new building to be erected near the Natural History Museum at South Kensington, but the war intervened, and many years are likely to elapse before they reach maturity. Up to a few months ago the Survey was attached to the Science Museum under the administration of the Board of Education, but it has now been transferred to the Department of Scientific and Industrial Research, the creation of which is one of the few beneficent results of the war.

The London Museum, now located at Lancaster

House, was instituted for the conservation of the antiquities of London. The Wallace Collection, bequeathed to the nation in 1897, is contained in Hertford House, which was acquired by the Government for the purpose. Both the last-named museums are under independent bodies of trustees. The Imperial Institute contains large collections of the economic products of the Empire, and a scientific and technical staff has been provided for their conservation and study; it is managed by the Secretary of State for the Colonies, assisted by an executive committee. Towards the close of the war the Imperial War Museum was founded for the preservation and custody of objects and records connected with the war. Besides the museums, there are the various picture galleries in London, all under independent bodies of trustees, and outside London there are important national museums at Edinburgh, Cardiff, and Dublin, all under their own authorities.

Owing to the overlapping of the scope of several of these institutions, there often arises duplication of work and competition for the acquisition of specimens. Thus similar ground is covered by certain sections of the British Museum and the Victoria and Albert Museum as regards art; by the Natural History Museum, the Geological Museum, and the Imperial Institute as regards minerals and rocks; by the Natural History Museum and Kew Gardens as regards the systematic study of plants. There is further overlapping in the range covered by the associated libraries—to some extent that is both desirable and inevitable—but at the same time no attempt is made to ensure that a copy of every important book or periodical is accessible in London.

The lack of co-ordination between the various museums was noticed by the Sub-Committee, under the chairmanship of Lord Haldane, which was appointed by the Reconstruction Committee in July, 1917, to investigate the machinery of Government, and confirmed in its appointment when the Ministry of Reconstruction began its brief existence. In its report published in 1918 (Cd. 9230) the following important paragraph occurs:—

“As regards the other national museums [i.e. other than the Geological Museum, the suggested transference of which to the Department of Scientific and Industrial Research was approved] . . . , we think that the responsible authorities might consider with advantage the possibility of entering into regular arrangements, by means of a body representative of each of the museums, and established for the purpose, whereby the spheres of the

respective museums should be arranged with a view to the avoidance of competition for objects, and to the development of each museum to the full as a centre of education and research. From the latter point of view it would no doubt be desirable to secure that the Board of Education, and the general organisation for research and information, . . . should be associated with any movement in this direction.”

In this connection we may refer also to the third interim report by the Adult Education Committee, which was also appointed by the Ministry of Reconstruction, in its report on libraries and museums (Cd. 9237, 1919), in which it is urged that “the powers and duties of the Local Government Board regarding [the local] public libraries and museums should be transferred forthwith to the Board of Education.” Those interested in such institutions promptly took steps to register their strong disapproval of the course proposed; with that dissent we are in full accord. It must be remembered that it is the business of the Board of Education to allocate parliamentary grants to schools and other teaching institutions, and to see that the range of the curriculum of the studies at them adheres to the official regulations, and not to take part in the actual practice of education. A department of which the vision is restricted by the blinkers of sub-heads and schedules is not often able to take a broad view on questions of learning and research.

In our opinion the best solution of the difficulty would be to expand the present Department of Scientific and Industrial Research into a Ministry of Learning and Research, and to bring under it the national museums and picture galleries, as well as the national institutions engaged in research. To ensure proper co-ordination and continuity of policy, the administration of the proposed Ministry should be entrusted to a board of trustees, comprising representatives of the standing committees appointed to control each of the constituent establishments.

We recognise the complexity of the question, and our readers must not assume that we consider the solution which we offer to be beyond criticism and discussion. In the House of Lords on March 3 Lord Sudeley suggested that the Government should appoint a committee on museums and galleries “to consider and recommend how these institutions can be further adapted to public needs, and especially be made throughout the country of far greater use for public benefit and instruction.” His lordship made it clear, in the course of the speech with which he intro-

duced the motion, that he had in mind the ordinary member of the public, and particularly the child in the elementary school, and appeared to be under the impression that the expert was already sufficiently well cared for. An instructive feature of the debate is the almost entire absence of any reference to science in general, or to the Natural History Museum, in particular. Another revealing point is suggested by a passage in Lord Crawford's reply for the Government, in which, in reference to Lord Bryce's proposal that a central scientific department of the Government should be set up, he said: "Among the purposes for which the Scientific and Industrial Research Department was set up . . . is actually that of acting as a central advisory body on any scientific question in relation to any Government Department"; for, apropos of this statement, we must observe that, whereas every administrative Department is represented by at least one assessor to the Advisory Council, that Department appears to be unaware of the existence of the Natural History Museum. Lord Sudeley's motion was eventually by leave withdrawn; nevertheless, we hope that the matter will not be allowed to rest there. We think, indeed, the question of sufficient importance for the consideration of a Royal Commission, the terms of reference of which should include the system of remunerating the specialist, who at present enjoys a much lower scale of salary than the administrator of corresponding standing, and we strongly urge the Government to appoint one with the least possible delay.

### Mathematical Cosmogony.

#### *Problems of Cosmogony and Stellar Dynamics.*

By J. H. Jeans. Being an essay to which the Adams prize of the University of Cambridge for the year 1917 was adjudged. Pp. viii+293+v plates. (Cambridge: At the University Press, 1919.) Price 21s. net.

**I**N a well-developed science two branches are broadly to be distinguished. In the one, an existing state of things is investigated. The subject of research is events immediately connected, forms, functions, and the laws which govern them. The other branch generally marks a later stage, and, basing itself on the results of the first, seeks to reconstruct from the present as complete a picture as possible of the past and even of the future. As in the conception which underlies the theory of relativity, the present, which is the limited subject of experience, is merely a section in time from which a higher

manifold is to be deduced. When the subject-matter is biological, the outcome is a theory of evolution. When it coincides with the domain of astronomy, the result is more specifically recognised as a scheme of cosmogony.

There are at least three methods by which attempts have been made to formulate such a scheme. The first, and most trivial, is to seize on some remarkable phenomenon, like Saturn's rings or a spiral nebula, and to see in it a clue which can be followed up more or less plausibly with the help of an exuberant and unfettered imagination. Progress on that line is naturally as limited as it is precarious. The second method is illustrated in its highest form by the work of Sir W. Herschel. It is the way of comparison and classification. The Draper classification of stellar spectra by Pickering is an apt modern example. Without preconception, except such as readily vanished in the light of fuller experience, almost all the stars fell into an ordered sequence, which became more complete and continuous as the material accumulated. To connect the ascertained sequence with a time scale was natural. But the problem has not proved quite so simple as at one time it appeared. In general, when the process is exceedingly slow and the section of experience correspondingly thin, the very direction of the scale is ambiguous, and the method requires to be supplemented by some additional principle. A third method remains. This consists in the study of models having a definite specification as nearly as possible in accordance with cosmic examples, but always within the power of analysis to discuss. The behaviour and development of such a model are traced to their logical consequences with full mathematical rigour, and only after this has been done is an attempt made to find their counterparts in the actual universe. This is the profoundly difficult but promising method adopted by Sir George Darwin, by Poincaré, and by Mr. Jeans in the work under notice.

It is curious how great are the difficulties which surround problems capable of the simplest statement. Three balls are thrown in any given way in empty space. All the intractable difficulties of the problem of three bodies are involved in discussing the subsequent motion under their mutual attractions. Or again, to take the fundamental problem of the present subject, a mass of liquid is stirred into rotation and left to find its shape under its own attraction. What figure will it assume when isolated in space? The following quotation from Thomson and Tait may be worth recalling:—

"During the fifteen years which have passed since the publication of our first edition, we have never abandoned the problem of the equilibrium

of a finite mass of rotating incompressible fluid. Year after year, questions of the multiplicity of possible figures of equilibrium have been almost incessantly before us, and yet it is only now, under the compulsion of finishing this second edition of the second part of our first volume, with hope for a second volume abandoned, that we have succeeded in finding anything approaching to full light on the subject."

The full light, it must be admitted, was rather dim, especially as such results as had been obtained were published without proof. But it sufficed to lead Poincaré to write a celebrated memoir on the subject, and this, with the contemporary and independent work of Liapounoff, has been the germ of all subsequent advance.

The first step had been taken by Maclaurin, who showed that the spheroid was a possible figure of equilibrium. The second solution was found by Jacobi in the form of an ellipsoid with three unequal axes. In the cosmical problem the whole mass and the moment of momentum are given constants; the angular velocity increases as the state of contraction advances, but so slowly that the development follows a succession of equilibrium figures. Thus a body traces out the series of Maclaurin to the point where it meets the series of Jacobi, and where secular stability is interchanged between the two series. Proceeding along the second series, it comes to the first point, discovered by Poincaré, where another possible series intersects. Here the Jacobian series becomes unstable, and it was a question whether the stability passed over to the series of deformations, or whether it disappeared completely at this point, in which case the figures of statical equilibrium would come to an abrupt end and be followed by a rapid change under dynamical conditions.

It was not in Poincaré's nature to embark on the complicated arithmetic needed to solve the question; but this part of the work was supplied by Liapounoff and by Darwin, who arrived at opposite conclusions, the latter maintaining that the deformed figure was stable. These three writers all used Lamé's functions in the discussion, and carried the development to the second order. One cannot help feeling that, in spite of his courage, Darwin was in this instance trying to stretch a bow a little beyond his strength. At any rate, the important problem remained undecided for some years. Mr. Jeans began his attack on it by forging a lighter and handier weapon, described in chap. iv. of the present work, on the gravitational potential of a distorted ellipsoid. His next step was to show that no conclusion could legitimately be drawn from a development to the second order;

and finally, on proceeding to the third order, he proved definitely that the figure at the point where the series bifurcate is unstable, thus closing a dispute remarkable in the case of a definite issue between authorities so eminently qualified. After this signal achievement as regards the incompressible fluid mass Mr. Jeans extended his researches to rotating masses of compressible and heterogeneous fluid, hitherto an almost untouched field. In following out the development of such bodies as exemplified in different selected models, he has shown always the same originality, resource and power.

In the present essay, which will be warmly welcomed, Mr. Jeans brings together these and other related researches in a connected form, but at the same time he adds so much of the work of his predecessors that his own is seen in its proper setting, and the whole book forms a fairly complete treatise on the subject. The earlier chapters provide that firm mathematical foundation to which the author has contributed so largely, while the later chapters deal in turn with the different classes of celestial objects to which the theory can be applied—rotating nebulae, star clusters, binary and multiple stars. The origin of the solar system, the very point at which speculations of this order began, remains apparently more elusive than ever. The later part of the book can be read with profit by many to whom the power of appreciating the earlier mathematical chapters has been denied. It will be found exceedingly interesting, and will repay the most careful attention. Here the speculative element necessarily enters, and the permanent value which belongs to the abstract problems definitely solved cannot be assumed. But ingenuity and a wide knowledge are always in evidence, and the essay should have an immediate value equally in limiting the area of profitable speculation and in suggesting lines which can be controlled by observation.

Of the technical excellence of the production, which is always a point of real importance in a mathematical text, it is unnecessary to say more than that it is worthy of the Cambridge University Press. There is an obvious, and therefore harmless, misprint in equation (72) (p. 38), and "Meyers" (p. 248) for "Myers" betrays an unverified quotation. On p. 2, "parallaxes are less" should read "greater." But these are trifling exceptions to the rule of accuracy. Beautiful pictures like the photographs of selected nebulae included by Mr. Jeans are an unusual feature in a mathematical work. They have been supplied from the Mount Wilson Observatory, and are masterpieces of their kind.

H. C. P.

### Tropical Medicine.

*Fevers in the Tropics.* By Sir Leonard Rogers.

Third edition. Pp. xii + 404 + 9 plates. (Oxford Medical Publications.) (London: Henry Frowde and Hodder and Stoughton, 1919.) Price 30s. net.

THIS, the third edition of Sir Leonard Rogers's well-known work, has, in our opinion, been improved by the pruning process to which it has been subjected, but it may be doubted whether the process has been sufficiently drastic, and personally we should breathe a sigh of relief if the "Burdwan fever" and some other hardy perennials were finally laid to rest. The distinguishing character of the author's method is the great importance which he attaches to the study of temperature charts and to leucocyte counts as means of diagnosis, with the result that, perhaps unwittingly, he scarcely emphasises sufficiently that in diseases of a parasitic nature these can be only of secondary importance. Thus "a great leucopenia" may be "greatly in favour of kala-azar," but a diagnosis can be made with certainty only in one way, viz. by finding the parasites; and as it is not stated whether this has been done in the many examples, accompanied by charts, given of "this disease," we are uncertain whether they really are "this disease," or examples of another disease, possibly the 43 per cent. of "kala-azar" cases in which parasites are *not* found, and which, for all we know to the contrary, may also show "a great leucopenia."

The author's exposition of these indirect methods of diagnosis consumes, we think, too much space, so that pathological histology, which should form our only certain basis for the interpretation of symptoms, receives rather scant attention. Thus nothing is said of the changes in American trypanosomiasis, and those of malaria and blackwater fever, for example, are very incompletely described.

Again, although twenty-one pages are allotted to a discussion of pre-suppurative hepatitis, we ourselves do not know what a liver in this condition would look like, as no post-mortem descriptions are given.

Under blackwater fever it is stated that "the parasite most commonly met with is the malignant tertian, the other forms being rare." If the other forms are rare, as in a malaria district like West Africa, or the Duars in India, this is only what one would expect; consequently, the statement has little significance; but if we are considering a district like the Panama Canal, where the simple tertian parasite forms about 26 per cent. of the malaria cases, then this statement is not true, for

we find that about the same percentage—viz. 24 per cent.—of the blackwater cases show simple tertian parasites, and on the Madera River, Brazil, where simple tertian forms about 30 per cent. of the malaria cases, the percentage for the blackwater cases is 42 per cent.

On p. 66 we find a common error repeated—viz. that tsetse-flies in the resting position can be distinguished from all other flies by the wings "closed . . . like the blades of a pair of scissors"; and on p. 86, probably through a lapse of memory, it is said that tartar emetic is specific for American trypanosomiasis; unfortunately, it appears to have no action on it. Misprints are rather numerous: *Crintridia* for *Crithidia*, *Triomata* for *Triatoma*, *lenticularis* for *lectularius*, *sodia* for *sordida*, *tropical* for *tropica*, *galinarum* for *gallinarum*, etc.

Readers who do not already know the work will find something different from the ordinary textbook, but we think they would be glad if the author's well-known clinical enthusiasm could express itself more tersely and—dare we say it?—more critically.

J. W. W. S.

### Practical Chemistry.

- (1) *A Text-book of Quantitative Chemical Analysis.* By Dr. A. C. Cumming and Dr. S. A. Kay. Third edition. Pp. xv + 416. (London: Gurney and Jackson; Edinburgh: Oliver and Boyd, 1919.) Price 12s. 6d. net.
- (2) *A Course of Practical Chemistry for Agricultural Students.* Vol. ii. Part i. By H. A. D. Neville and L. F. Newman. Pp. 122. (Cambridge: At the University Press, 1919.) Price 5s. net.
- (3) *Chemical Calculation Tables: For Laboratory Use.* By Prof. H. L. Wells. Second edition, revised. Pp. v + 43. (New York: John Wiley and Sons, Inc.; London: Chapman and Hall, Ltd., 1919.) Price 6s. 6d. net.

THERE is always a tendency among students of analytical chemistry to value their work by its quantity and the nearness of their results to what is assumed to be correct, and in this they are often encouraged by those who have the direction of their studies. They do as they are told in their text-book—weigh out so much, dissolve in 200 c.c. of water, add 20 c.c. of a stock reagent, heat to boiling, wash three times by decantation, and so on; and in the end, though they get an excellent result, they have learned not so much chemistry as if they had made an apple dumpling by intelligently following the instructions of a cookery book.

There is only one way to learn practical chemistry, and that is to study the work as well as do it. A student should not pass from an estimation until he knows definitely the reason for every step in the process, how it can be proved to be complete, and why the operation is done in the way it is rather than in an alternative way. He should make a rule of proving that his product is what he means it to be, and that it is pure. In short, he should make a thorough study of every piece of work. He may get fewer results, but he will have learned more chemistry, and he will have gained the only true confidence, namely, that founded on knowledge.

We deprecate, as a rule, general instructions, such as that every precipitate should be ignited two or more times until it ceases to change in weight. Some products need it, some do not. The point for consideration is, What is present that it is desired to get rid of by the ignition, and what conditions are necessary to eliminate it with certainty? Unless the student knows this and concentrates his attention upon it, he is working by mere rule of thumb. As to purity of product, we have known a conscientious and careful worker to get a good result for one of the minor constituents of an ore, but when it was suggested that he should examine the product that he had weighed, he did so, and found that it did not contain even a trace of the compound of which he thought it consisted.

(1) The manual by Drs. Cumming and Kay is an excellent text-book for students. It includes a full course of mineral analysis, finishing with instructions for the analysis of several alloys and ores, gas analysis, water analysis, organic analysis, the determination of molecular weights, and various desirable tables. There are many helpful and practical hints, though we think that some parts might profitably be a little expanded on the lines indicated above. The method of igniting ferric hydrate without separation from the filter paper containing it is, of course, not original with the authors, but we think that it will be found generally to lead to a notably short weight, because the reoxidation of the reduction products is very uncertain.

(2) This "Part" of Messrs. Neville and Newman's course deals only with exercises on "pure organic chemistry." It covers the examination of many classes of organic bodies, finishing with proteins and enzyme action. It is a well-arranged course for students of agriculture. Like so many others who refer to the production of acetaldehyde for detection purposes, the authors describe its odour as characteristically fruity.

(3) The "Chemical Calculation Tables" include NO. 2628, VOL. 105]

a five-figure table of logarithms with a double thumb index that enables the user to turn immediately to any desired page either backwards or forwards. There are extensive tables of factors and weights, giving both the number and the logarithm, and tables referring to gas calculations and molecular weight determinations. It is exactly what one wants to facilitate calculations in the laboratory.

C. J.

### Botanical Guides.

- (1) *Applied Economic Botany: Based upon Actual Agricultural and Gardening Projects.* By Dr. M. T. Cook. (Farm Life Text Series.) Pp. xviii+261. (Philadelphia and London: J. B. Lippincott Co., 1919.) Price 7s. 6d. net.
- (2) *Some Familiar Wild Flowers.* Photographed by A. E. Sulman. Pp. ii+65. (Sydney: Angus and Robertson, Ltd., n.d.) Price 1s. net.
- (3) *Australian Wild Flowers.* Photographed by A. E. Sulman. Second Series. Pp. ii+61. (Sydney: Angus and Robertson, Ltd., n.d.) Price 1s. net.
- (4) *A Popular Guide to the Wild Flowers of New South Wales.* By Florence Sulman. Vol. ii. Pp. xxxi+249+71 plates. (Sydney: Angus and Robertson, Ltd., 1914.) Price 6s. net.

(1) THE title of Dr. Cook's book is misleading; from the preface we learn that it is intended as a guide to experimental work in the study of plants, such as should be carried on in any high school, and as a preliminary work to the agricultural studies which are now recognised in many high schools. These objects would be served by a good general practical introduction to the study of plant life, and this, we gather, is what Dr. Cook is attempting. Part i., "Plant Life," occupies nearly three-fourths of the volume. Beginning with the seed and seedling, the form of the various plant organs and their uses to the plant are described in successive chapters, and exercises for practical work are suggested at the close of each chapter. A short chapter on the anatomy of the angiospermous plant follows, then a brief description of the chemical composition and a chapter on plant food and growth, and finally very short chapters on the Gymnosperms, ecological relations, forestry, plant-breeding, weeds, Pteridophytes, Bryophytes, Thallophtes, and Bacteria.

The remainder of the book, part ii., entitled "Important Families of Economic Plants," is an account of a number of plants of economic value arranged in their families, with a short and often very inadequate description of the characters of each family. The general effect is scrappy. There

are a large number of figures, many of which are good, but others are poor, as, for instance, some of those in the chapter on flower-types. A photograph of two ripe ears of Indian corn is described as the pistillate flower. The use of the terms "endogenous" and "exogenous" for the stem of the monocotyledon and dicotyledon respectively is not helpful; and to describe the flower as consisting of "leaves which have been greatly modified in shape and colour" may be misleading. Annual rings are invariably referred to as annular rings. The introduction contains excellent advice on methods of studying botany, but the book as a whole is disappointing.

(2) and (3) The two little books by Mrs. Annie Sulman form a series of very fair reproductions of photographs of some of the common Australian wild flowers, and each is very well worth the shilling. There is no letterpress apart from the short preface and index; the botanical and, where such exists, the popular names are given below each plate, and the colour of the flower is indicated. There is little attempt at arrangement; generally the species of the same genus are brought together, but members of the same family appear in different parts of the books. If the author would arrange the plants in some definite sequence and indicate in each case the family to which the plant belongs, she would add to the usefulness of these little volumes.

(4) Miss Sulman's "Popular Guide to the Wild Flowers of New South Wales" is complementary to the volume previously issued. It forms a very handy and well-arranged working flora descriptive of a large number of New South Wales flowering plants, illustrated by clear, well-drawn, and eminently helpful full-page illustrations. The arrangement is that of Bentham's "Flora Australiensis." There are a useful illustrated glossary, a list of books of reference, a key to the families, twenty-nine of which are included, and, at the end of the volume, a colour index, by which a clue may be obtained to the name of a flower. The descriptions of the plants are clearly written, and a great deal of information is given in a small space.

### Our Bookshelf.

*Agriculture and the Farming Business.* By O. H. Benson and G. H. Betts. Pp. xvi + 778. (London: Kegan Paul and Co., Ltd., n.d.) Price 10s. 6d. net.

MESSRS. BENSON AND BETTS have essayed an ambitious task; it is no less than to make their volume a clearing-house for the mass of valuable scientific information about agricultural problems now accumulated at experiment stations and col-

leges, but not always wanted by practical farmers. Although the book emanates from a London publisher, it is entirely written for the American farmer.

The scope of the book is unusually wide; it deals with office equipment, crops, animals, manures, soil fertility, implements, motor-cars, roads, education, recreation and health, and finally there is a miscellaneous chapter including such diverse subjects as the removal of stains, the quantity of seed to sow per acre, a planting table, etc. Full information about all these things could scarcely be expected, and yet a vast amount of material is collected. Unfortunately, it is of very unequal value; there are few tables of figures and practically no references; the student wishing to check the data cannot do so, and the farmer seeking information is not told where he can obtain it. Thus, under "The Origin of Wheat," the only information given is: "Just where wheat came from none can say. Some think it originated in the Valley of the Nile or the Euphrates, or possibly that it may have come from Sicily. Wherever it originated, it seems to have developed from one of the wild grasses. Certain scientists think it descended from the lily; others tell us that it is probably a descendant of the wild ammer."

This statement is not very satisfying. Like many others in the book, however, it might serve to whet the farmer's curiosity, and some good would then be served by references to trustworthy specialised books or bulletins. If a second edition is called for, the authors might well seriously consider these points.

*A Geography of Asia.* By Joseph Martin. (Macmillan's Practical Modern Geographies.) Pp. viii + 298. (London: Macmillan and Co., Ltd., 1919.) Price 5s.

The tendency of school geography to embrace too much and so to fail in achievement has been avoided in this book, which is well proportioned and thoroughly geographical throughout. Mr. Martin has the courage to omit considerations of geological structure where it has no direct bearing on human activity. Physical explanations of climatic problems are generally omitted. The diagram of the planetary winds is an improvement on that produced in most text-books, but should have the polar high-pressure areas added. Asia is treated under the larger natural regions, but these are not allowed to obscure the political units which are an essential to a full understanding of world geography.

Each chapter is prefaced by some simple statistical matter on which is based a number of exercises designed in the main for oral answers. At the end of each chapter are a number of mapping exercises. The extent to which wide generalisations are admissible in school geography will always be a disputed point, but statements that certain climates are unhealthy to Europeans, if true, require explanation. Even a school geography should emphasise the part played by the mosquito.

More than fifty excellent black-and-white maps, most of which show relief, and as many finely reproduced illustrations add considerably to the value of the book. One or two small points might be corrected in the next edition. The number of emigrants entering Asiatic Russia was scarcely 250,000 a year immediately before the war. The figure given for Siberia on p. 264 is much too high. It would be more correct to say that the Kara Sea is navigable for two months than that it is ice-free for that period. The railways to Kuznetsk and Minusinsk should be noted. The use of a volume like this must result in raising the standard of geographical teaching, and, incidentally, in justifying full attention to the subject in the school curriculum.

*Submarine Warfare of To-day.* By Lieut. Charles W. Domville-Fife. (Science of To-day Series.) Pp. 304. (London: Seeley, Service, and Co., Ltd., 1920.) Price 7s. 6d. net.

THE Allied peoples, to whom the defeat of the German submarine campaign has meant so much, cannot fail to be interested in the means by which that defeat was consummated. Hitherto they have had to rely on scraps of information—perhaps true, perhaps not—whispered in the ear or appearing furtively in the Press. An urgent demand undoubtedly exists for a comprehensive statement of the case. Lieut. Domville-Fife has given us that—and more. His book is full of romance as well as of facts. The victory over the submarine was won, not by any sovereign remedy for their depredations, or by a single weapon invincible in attacking them, but by the cumulative effect of a multitude of devices, each itself imperfect, but employed systematically and in spite of numerous failures. To which must be added—and the author gives this its proper proportion by telling actual incidents in a fine literary style—the bravery and pertinacity of the men on the ships.

The only criticism which is permissible is that the book is somewhat lacking in detailed description of the instruments used—the directional hydrophone, for example. Possibly this omission is due to the continued maintenance of official secrecy in such matters. This probably also accounts for the lack of all reference to certain new devices which were used with considerable effect, or to the development of others which will in future render the action of the submarine increasingly difficult.

*Hidden Treasure: The Story of a Chore Boy who Made the Old Farm Pay.* By J. T. Simpson. Pp. 303. (Philadelphia and London: J. B. Lippincott Co., n.d.) Price 6s. net.

MR. SIMPSON has woven many of the features of modern farming into a story of an American college youth who went to a Pennsylvania farm owned by a very conservative uncle just about to marry and set up housekeeping. The young man's suggestions for improvements are received with the usual incredulity, the uncle even declining to oil the wheels of the grindstone, because he has

never done it before. But before the onslaught of the boy's "git up and git," and the insistence of the up-to-date wife, the uncle's prejudices slowly break down, and in one way and another the old run-out farm is gradually improved. New concrete buildings are put in, the tractor is introduced, the dairy herd is improved, and in course of time the farm becomes a completely modern establishment. The young man receives his reward; the local banker becomes interested in him, a desirable farm falls vacant, and in chap. xiii. (ominously enough) an eligible young woman turns up equipped with brown eyes and shy glances, and although the recorded conversations all relate to agricultural improvements, the perspicacious reader will have no difficulty in forecasting the end.

*Flora of the Presidency of Madras.* By J. S. Gamble. Part iii. *Leguminosae—Caesalpinioideae to Caprifoliaceae.* Pp. 391–577. (London: Adlard and Son, and West Newman, Ltd., 1919.) Price 10s. net.

THE third part of Mr. Gamble's handy little flora contains the remainder of the polypetalous dicotyledons. It includes the *Cæsalpinia* and *Mimosa* sections of *Leguminosae*, containing many forest-trees and shrubs, and, among others, the important families *Combretaceae*, *Myrtaceae*, *Melastomaceae*, and *Cucurbitaceae*. As in previous parts, descriptions are given of families and genera, but the determination of the species depends on the keys in which the characters of the principal organs are fully contrasted. No typographic distinction is made between native and introduced genera, such as *Parkinsonia* (tropical American) and *Eucalyptus* (Australian); *E. globulus*, the blue gum, is largely grown in forests on the Nilgiris and other hills, and is frequently found self-sown. Another alien genus appears under the name *Delonix*, an unnecessary revival from *Rafinesque*; it includes the familiar "flamboyant" generally known as *Poinciana regia*. As with the previous part, the author has been restricted in the preparation of the work to material available in the great herbaria in this country, but for future parts the Indian collections will again be available.

*La Théorie Atomique.* Par Sir J. J. Thomson. Traduit de l'Anglais par le Prof. M. Charles Moureu. Nouveau tirage. Pp. vi+57. (Paris: Gauthier-Villars et Cie, 1919.) Price 2.40 francs net.

THIS is a translation of the Romanes lecture of 1914, made during the war under the full inspiration of the Anglo-French comradeship in arms. The translator stipulated that the proceeds should go to the British Red Cross; Sir J. J. Thomson insisted that they should go to the French Red Cross; and, as neither would give way, they finally agreed that they should benefit the Belgian wounded. Prof. Moureu has given an excellent translation, which fully preserves the "intérêt passionnant" of the original lecture.



Letters to the Editor.

(The Editor does not hold himself responsible for opinions expressed by his correspondents. Neither can he undertake to return, or to correspond with the writers of, rejected manuscripts intended for this or any other part of NATURE. No notice is taken of anonymous communications.)

Gravitational Deflection of High-speed Particles.

MR. LEIGH PAGE has given a very simple method of treating the motion of high-speed particles in a gravitational field on Einstein's theory (NATURE, February 26, p. 692). In one respect his results differ from those which have been obtained by more laborious methods, and I think that some error must have crept in, either through a failure of his approximation or from some other cause. He finds that a particle travelling with the velocity of light would be undeflected, whereas a ray of light is deflected. It would be difficult to reconcile this with the principle of equivalence, which seems to require that the trajectory of a material particle should approach that of a light-pulse as the velocity approaches that of light.

The differential equation of the orbit of a material particle moving with any speed is [Report, Physical Society, p. 51, equation (31.2)]

$$d^2u/d\theta^2 + u = m/h^2 + 3mu^2, \quad (u = 1/r),$$

where the constant  $h = r^2 d\theta/ds$ . It is from this exact equation that the motion of perihelion of Mercury is obtained. For motion with the speed of light  $ds = 0$ , so that  $h$  is infinite, and the equation becomes

$$d^2u/d\theta^2 + u = 3mu^2.$$

The solution is

$$u = \frac{\cos \theta}{R} + \frac{m}{R^2} (\cos^2 \theta + 2 \sin^2 \theta),$$

neglecting  $m^2/R^2$ .

In Cartesian co-ordinates this becomes

$$x = R - \frac{m}{R} \frac{x^2 + 2y^2}{\sqrt{(x^2 + y^2)}}.$$

The asymptotes are found by taking  $y$  very large compared with  $x$ , giving

$$x = R \pm \frac{2m}{R} y.$$

Hence the angle between them is  $4m/R$ , agreeing with the result for the deflection of light rays.

I have verified by the usual methods the other principal result given by Mr. Page, that for radial motion the force (relative to the co-ordinates used) is a repulsion if the speed exceeds  $1/\sqrt{3}$  times the velocity of light.

With regard to the question whether the system of an atom on the sun can be identical with that of an atom on the earth, inasmuch as the warping of space-time is different in the two places, it is clear that the identity cannot be exact; but this loophole for escape from the predicted shift of the Fraunhofer lines does not seem to be very promising. If the "intervals" of vibration of the two atoms are not the same, the difference must depend on some invariant of space-time which differs at the two places. I do not think that any invariant of order  $m/r$  exists. The simplest invariant which does not vanish is

$$g^{00} g^{03} g^{0\gamma} g_{\rho\delta} B_{\alpha\beta}^0 B_{\gamma\delta}^0;$$

it is rather laborious to work out the actual value of this (since it consists of 65,536 terms), but it appears to be of order  $m^2/r^2$ . The Fraunhofer displacement depends on terms of the much greater order of magnitude  $m/r$ .

A. S. EDDINGTON.

Observatory, Cambridge.

Gravitational Shift of Spectral Lines.

THE assumption that the equations of motion in a gravitational field can be deduced from a condition of

the form  $\int ds = 0$  is in itself little more than a very natural way of expressing the principle of least action. The greatness of Einstein's theory really lies in the suggestion, made apparently on purely *a priori* grounds, that a certain set of six relations between the coefficients in the formula for  $ds^2$ , which are true when no heavy body is near, still hold near one. These are found to make the coefficients determinate, whereas previously they were quite arbitrary, and the observed motions of the planets, including the advance of the perihelion of Mercury, are at once deduced.

The displacement of star images during an eclipse is based on the further very plausible assumption that a light-wave moves like a material particle of zero mass starting from an infinite distance with the velocity of light there. Now that this displacement has become a result of observation, the data are just enough to make it possible to reverse the argument and deduce the fundamental assumption of the theory from observation, as I have done in a forthcoming paper in the Monthly Notices of the Royal Astronomical Society. Neither in Einstein's discussion nor in mine is any identification of  $ds$  with an invariable line element in four-dimensional space-time relevant to the theory; and as the application of the theory is purely physical, I think it undesirable that any such abstract idea should be made to appear as part of it. Physically, the invariance of  $ds$  means simply that the motion of a particle can be described in terms of any set of co-ordinates we like to choose.

In discussing these phenomena all positions and times are referred to an observer at the centre of the sun, and it is not necessary to determine the relations between his measures and ours, for the uncertainty in these would not affect the observed quantities appreciably. The problem of the shift of spectral lines, however, depends essentially on such a comparison. About part of the theory of it there can be no reasonable doubt, namely, the assumption that the vibration on the earth appears to any observer to have the same period as the vibration on the sun that causes it. What is doubtful is whether the atom on the sun vibrates in the same time as a similar atom on the earth. Einstein assumes that it does not, but that the increase in  $ds$  in a period is the same for both, and deduces the shift of the spectral lines.

There is nothing very bizarre about this; it only means that when we move about we must refer our observations to time standards in the place where these were originally used, and not expect that they will serve the same functions if we carry them about with us. An analogy from colour will illustrate this. Suppose we have a standard of redness in the form of a particular red body. We judge the redness of other bodies by comparison with this. Now suppose we go to a place where the prevailing illumination is green, but where our standard of redness is still visible through a window. We then say that none of the things in the room look red, but our judgments as to what outside bodies look red are the same as before. Our standard is now brought into the room. Are we going to say that it looks red still? If we do, we shall have to say that the red external bodies that have not been moved have been changed in colour by the motion of our standard, which is at least inconvenient, and which most people would call absurd. Therefore we say that our colour standard has been altered by its displacement, and choose another standard from among the visible external bodies.

Similarly, if an observer on the earth went to the

sun his time standard would not be that determined by bodies he had carried with him, but the standard found by observing from the sun similar bodies on the earth, and he would judge that his time standards were changed by being displaced. Of course, if they were not changed, the spectral shift would be zero. The colour analogy, however, shows that there is no special reason to believe that they are unchanged, and it certainly seems most likely that the invariable quantity in such a displacement is  $ds$ , for this is already known to be of fundamental importance in other problems. The shift, therefore, is probable, though if it were absent it would not be very difficult to construct a theory that would fit the fact.

If it were true that  $dt$  was the same for atoms on the sun and on the earth, we might expect our standards of length also to be the same; but this leads to a surprising result, for if they were, the measure of the wave-length of the emitted light would be proportional to  $(g_{44}/g_{11})^{1/2}$ , so that it would not be possible to continue to use the wave-length as a standard of length; thus such a hypothesis would lead, not to a simplification, but to an added complexity. It may also be noted that the spectral shift depends on the part of Einstein's law that agrees with Newton's, so that the two stand or fall together if this phenomenon is crucial.

Einstein's law, however, rests on firmer ground than the theory of the spectral shift. As to whether this shift exists, the available data on an average point to one of nearly the predicted amount, and are certainly much nearer this than zero. They show a great variation in the amount of the shift, which must be explained before the question can be regarded as solved. Many causes are capable of producing this variation, but what seems to me likely to be the chief does not appear to have received much attention. The prediction rests on the assumption that the vibrating atoms are in similar surroundings, which is plainly false. It is, indeed, required by the theory of stellar evolution that the whole constitution of a star must alter owing to successive types of atom becoming unstable and passing over into more stable forms. Instability demands that the slowest free vibration of the atom has its frequency reduced to zero, and in the process the other periods must be affected. The remarkable fact is not that there are shifts, but that the observed spectra are as much like terrestrial ones as they are.

HAROLD JEFFREYS.

Meteorological Office, S.W.7.

#### The Position of the Meteorological Office.

That the study of the atmosphere and the practical applications of meteorology should be supported and encouraged by the Government is a proposition so obvious that it is accepted in every civilised country. It does not, however, follow that the meteorological service of a country should be conducted as a branch of the civil service, still less of the military service, and British meteorologists must be grateful for the emphasis laid in the leader in NATURE of February 26 on the importance of scientific control of official meteorology.

I do not know enough of the present constitution of the Meteorological Office to offer any criticism of the Air Ministry in relation to it, but I am very strongly in agreement with the resolution of the Royal Meteorological Society as to the importance of full inquiry before changing the constitution of the Meteorological Office, which has led to such remarkable advances in meteorological science since 1905.

The transfer to the Department of Scientific and Industrial Research, which you state to have been contemplated at one time by a Committee of the Cabinet, would, it seems to me, have been a natural development of the constitution under the Meteorological Committee, and it would have been free from the dangers to scientific progress which are, not unnaturally, feared from a subordinate position in the Air Ministry. Had a full inquiry been held, I doubt whether the claims of the Air Ministry would have been preferred to those of the Board of Agriculture and Fisheries, the Admiralty, the Board of Trade, and, in particular, to those of the Ministry of Health. The union of the British Rainfall Organization with the Meteorological Office has altered its centre of gravity so far as to make its equilibrium less stable in the Air Ministry than it would be in either the Board of Agriculture and Fisheries or the Ministry of Health. As part of the Department of Scientific and Industrial Research the Meteorological Office would be in neutral territory, and could be equally serviceable to all the great Departments, each of which would naturally be represented on the Advisory Committee controlling the organisation. The position would then be analogous to that of the Geological Survey, which, perhaps, is the official scientific body most nearly akin to the Meteorological Office.

For scientific bodies of this kind freedom from all unnecessary trammels of officialdom is necessary in order to permit the expansion and development which are essential to healthy life and practical usefulness; and in a body of such universal usefulness as the Meteorological Office in its present expanded form some representation of the industrial and economic applications of meteorology upon the advisory committee or other controlling board is nearly as important as the representation of independent men of science.

HUGH ROBERT MILL.

Hill Crest, Dorman's Park, Surrey,  
March 2.

THE issue of NATURE for February 26 contained an account of the Royal Meteorological Society's resolution in reference to the transfer of the Meteorological Office to the Air Ministry, a leading article dealing with the same subject, and correspondence on the organisation of scientific work, part of which seems directly applicable to the same theme.

If it be true that the Meteorological Committee is no longer to exist, the society's protest appears amply justified. Otherwise the position of the Meteorological Office as a branch of the Air Ministry, with a scientific advisory committee, would appear not very dissimilar to that of the Natural History Museum; or perhaps a better comparison would be with the Royal Observatory, Greenwich, which is under the Admiralty, the Astronomer Royal being supported by a scientific advisory committee in the shape of the Board of Visitors, of whom only one, the Hydrographer, directly represents the Admiralty, the rest being either university professors of astronomy or else expressly nominated by the Royal Society or the Royal Astronomical Society.

The Meteorological Department at Greenwich, though now in its eightieth year, is too recent to expect direct representation on the Board, especially as its activities have not generally run in the direction of research, but the fact remains that the work at Greenwich has points of contact not only with the Admiralty, but also with the Board of Trade, the Post Office, the Meteorological Office, the Colonial Office, and other bodies. It ought not to be impossible to

give due attention from the Meteorological Office to the requirements of the Board of Trade and of the Board of Agriculture and Fisheries, even though for simplicity, and possibly for financial reasons, it is housed in the Air Ministry and its separate expenses included in the account of that Department.

WALTER W. BRYANT,  
Hon. Secretary.

Royal Meteorological Society.

### Organisation of Scientific Work.

THE fostering and development of the resources of India by means of scientific research is not a mere question of academic interest, but one on which the very economic existence of the country depends. Fortunately the Government of India has realised the danger of the situation, and is anxious to develop the vast potentialities of the country through the application of science, as Japan has already done with her far more limited resources. It is obvious that the success of the proposed scheme will largely depend on the encouragement of investigation among the Indian students and workers, who will necessarily be the principal recruits for the work of the utilisation of indigenous talent in the services of their own country. A quarter of a century ago, when science teaching was in its infancy in India, I ventured to predict that, through an ever-increasing ingenuity of devices necessary for extending the boundaries of knowledge, there would in the near future be seen in India an advance of skill and of invention among our workers, and that, if this skill could be assured, practical applications would not fail to follow in many fields of human activity.

My anticipations have since been fully realised; for example, the extremely delicate instruments which have enabled me to carry out all my investigations have been constructed entirely by Indian mechanicians, and I have been assured that the most skilled American instrument-makers could not have produced apparatus more delicate. As regards scientific advance in its various departments, it is generally recognised that the present period in India may truly be described as a renaissance.

With reference to the practical scheme now under the consideration of the Government of India, the leading article in NATURE of February 19 states very fairly the comparative merits of the two alternatives, namely, that of centralisation under a proposed Imperial Department, and that of decentralisation, under which research workers will be given as free a hand as possible. Under the centralisation scheme the work of an investigator would depend on the previous sanction of the head of the Service, who would probably not be of any scientific eminence, or might even be without scientific qualification; and, most serious of all, he would not be able to publish his results without the consent of the official head of his special department. The possible abuses of such conditions are sufficiently obvious to all.

Every real investigator is making a great adventure into the unknown, and all the initiative and all the risk must therefore be his own. Nothing could be so disastrous for the growth of knowledge as to place competent men under an incompetent machine.

Finally, who should be the judge of the value of the work accomplished? Such judgment should not be departmental or secret; the verdict should come from the open court of the scientific world itself, and this would effectively put an end to official or non-official incompetence.

I. C. BOSE.

33, Bloomsbury Square, London, March 6.

NO. 2628, VOL. 105]

### Photographs of Seven Vocal Notes.

DR. A. O. RANKINE, by means of the invention described by him in NATURE of February 5, has placed me under a great obligation in furnishing ocular confirmation, desirable for those whose hearing is undisciplined or poor, of observations made by the unassisted ear on the inherent pitches of vowel sounds. No one who can hear harmonics of a sustained note from the larynx reinforced successively by a continuous change in the pitch of the mouth-cavity acting as a resonator should remain in doubt as to their place in the tabature, for, the pitch of the voice being known, if a harmonic sequence is heard, such as 4:5:6:7, the vibration number of any one of these overtones is the product of a simple multiplication. The well-known spherical resonators, applied in turn to the ear, cannot be changed instantaneously, destroy the all-important contrast, and have failed. The late Lord Rayleigh's compound resonator (*Phil. Mag.*, 1907, p. 321) would do better service, but I do not know that anyone has used it for this purpose. The table in text-books of physics, physiology, etc., shows an extreme error of two octaves. The inherent pitches of the vowels of ordinary speech from *oo* to *ee* range from about  $f^{\text{ii}}$  to  $d^{\text{iv}}$ . Taking two octaves as the extreme compass of the mouth shaped for vowels, this supplies such "real characters" for vowel sounds as Bishop Wilkins and his friends looked for in vain, and the use of an alphabet thus rectified will make it unnecessary for English-speaking children to learn to spell, while the re-formed print writing will obviate spelling reform. I have explained this seeming paradox in a book now in the press.

The films were marked before exposure.

(1) "128 not, ?6." This means that a note *c* physical pitch is to be sung in which the singer hears the sixth harmonic intensified in the mouth, the vowel-quality more or less resembling the vowel in *not* prolonged. When the negative was changed back into sound by Dr. Rankine, the harmonic no longer in question (6,  $g^{\text{ii}}$ ) was clearly heard by him, and afterwards by myself. The octave comes out in the photograph surprisingly strong. I suspect that it may be largely a self-combination tone. I do not with certainty distinguish the octave in any quality of my voice unless it is strengthened in the mouth, as when the vowel *oo* is sung to a top note of chest register.

Six more films were exposed on February 16. Brief samples of all six are here shown.

(2) "192 not, ?4." The voice being raised a fifth, to *g*, the mouth-tone  $g^{\text{ii}}$  is now harmonic 4. The four light bands and four dark lines in each period are evident. The inequality of the spacing reminds us that the thing photographed is not a simple tone with the double octave imposed upon it, but a *voice* in which the fourth harmonic component is made especially prominent.

(3) "256 not, ?3." The voice at middle C, *c'* physical pitch, the overtone  $g^{\text{ii}}$  is now harmonic 3.

(4) "128 book, ?5." The pitch of the resonator is lowered to *e'* by an unusual protrusion and rounding of the lips. The pitch of the vowel in *book* as spoken in southern England is considerably higher than *e'*. One vibration in each periodic group is of the frequency  $128 \times 5$ . The rest appear displaced by the octave or the double octave.

(5) "256 book, ? high." The quality of the vowel is not affected, but now the pitch of the resonator is too remote from the nearest of the lower harmonics of *c', 2* and *3, c'* and  $g^{\text{ii}}$ ; and the only tone audible from the mouth is a very high, thin sound, noted more than once as undoubtedly a sharp F, harmonic

11 of  $c'$ ,  $f^{iv+}$ . No such frequency is visible on the film, which seems to have recorded only the fundamental and the octave. This vocal note might fairly be called a "dud." Though sustained with greater effort than (3) above, there is no *ring* in it, energy being wasted in the attempt to force a vibration in a mistuned resonator. When a singer happens upon a note of this kind he instinctively alters the oral configuration. Hence the endless complaints that some vocalists, no matter what language they sing, distort the vowels. It is impossible always to combine good resonance with purity of vowel sound, and the higher the voice, the more frequent the occurrence of such an unfavourable conjuncture as here illustrated. It is a matter of arithmetic.

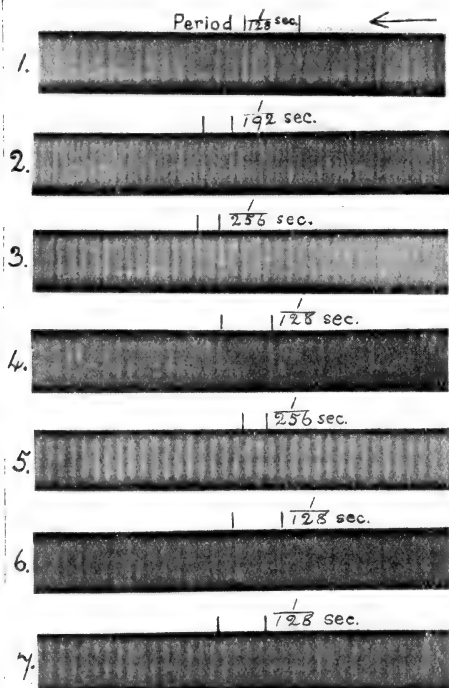

(16) "128 not, 26." The seventh harmonic was not on the programme. The proposal was to repeat (1) louder. The note began well, but while forcing the voice I became doubtful whether I could hold out until the one second which was to receive duration had come and gone, and listening anxiously for the click of the shutter lost ear-control of the harmonic. In fact, I have to confess to a facial lapse, as sometimes happens when one is having a photograph taken. A slight enlargement of the lip-opening in the direction of the vowel in *far*, a nearer approach to the vowel in *not* as I speak it naturally, introduces harmonic 7 of the fundamental 128. It would be easy to demonstrate this at another sitting. The earlier part of the film is all at sixes and sevens. The strip reproduced with its apparently lop-sided octave proves that the period has been correctly marked in (1).

(7) "128 Somerset R." It was hoped to discover why the Wessex or American  $r$  should sound harsh to unaccustomed ears. So far, the ear tells me more than the eye.

It would be interesting to try a longer film marked "128 we may, pa, all go too, ? 17 to 5."

W. PERRETT.  
University College, Gower Street, London,  
W.C.1, February 27.

#### Scientific Direction of Industrial Research.

EMBODIED in its rules, the National Union of Scientific Workers states that one of its objects is "to secure in the interests of national efficiency that all scientific and technical departments in the public service, and all posts involving scientific knowledge, shall be under the direct control of persons having adequate scientific attainments." The executive committee of this union realised that it had to overcome much prejudice existing against the application of this rule to the older Departments of State; but from the very circumstances which gave birth to the Department of Scientific and Industrial Research it imagined that the Department would adopt this rule as a cardinal principle, and enforce it in its relations with the many manufacturers' associations the co-operation of which was invited in the formation of research associations for the benefit of British industries.

Until the great war cut off supplies from Germany the British nation as a whole had realised neither its dependence upon that country for dyes, drugs, instruments, and glassware, among other things, nor the fact that great German industries had been founded upon the original work of British men of science. The war brought enlightenment; the nation discovered that its manufacturers, either from apathy or ignorance, had failed to exploit British brains for the benefit of the British communities; and it is safe to assume that the Department of Scientific and Industrial Research came into being to remedy this state of things and to bring the manufacturing interests into touch with the real scientific worker as distinct from the essentially "business" man.

The appointments of Sir Herbert Jackson, Prof. Crossley, and Dr. Slade as directors of research of different industrial research associations were welcomed by this union as an indication of the Department's acceptance of the principle laid down by all men of science, but later appointments have given rise to dismay, particularly that of Mr. R. L. Frink as director of the Glass Research Association, referred to by Dr. Travers in NATURE of February 5. Mr. Frink appears to have been successful as the head of a commercial organisation connected with the window-glass and bottle-glass trade, but careful inquiry has failed to provide evidence that by training or experience he can claim to be a man of science.

My union feels compelled, therefore, to protest with all its power against the appointment. It has sent its protest both to the Glass Research Association, which made the appointment, and to the Department of Scientific and Industrial Research, which approved it. From the former no reply has been received, although a month has elapsed since we made our protest; from the latter the following extracts from the reply are a confession of impotence to deal effectively with the matter:

"It is the intention of the Government that, so far as the conduct of the affairs of research associations is concerned, this shall be in the hands of the associations themselves. . . .

"Accordingly, the responsibility for the selection of a director of research and for the conditions of his

appointment rests in each case with the research association, and not with this Department."

In the case of the Glass Research Association the State contribution to its funds for the next five years is three-quarters of the total. In view of its relatively large contribution, the State should be able to exercise more than a merely nominal control over the appointment of the director; if it cannot do so, it should take immediate steps to remedy its position.

It is the opinion of the National Union of Scientific Workers that it is the subordination of the scientific worker to the "business man" which has been chiefly responsible in the past for the tardy development of scientific industry in this country. It feels that this appointment negates the aims outlined by the Department, and that the whole industry will suffer from the consequent neglect of the scientific aspects of glass research work and from the unwillingness of scientific workers to submit to such direction.

We firmly believe that the matter is one of the first importance, and that the result of our representation in this matter, not only with a commercial organisation, but also with the Department charged with the care of scientific interests in the country, may determine the relations of science and industry for many years to come.

A. G. CHURCH,  
Secretary.

19 Tothill Street, Westminster,  
S.W.1, March 6.

#### On Langmuir's Theory of Atoms.

The great objection to Langmuir's theory of atomic structure is the difficulty of accepting his hypothesis of stationary electrons. In view of the extraordinary power of the theory, it is important to inquire if

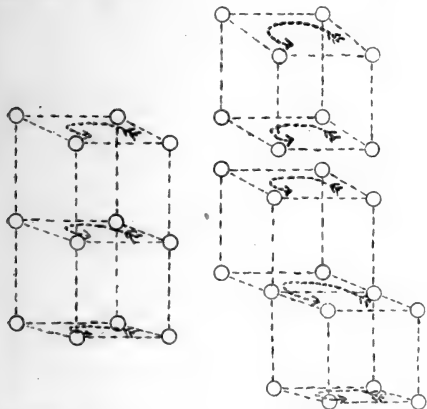

Langmuir's argument from the fixity of direction of the valency forces necessarily holds. There appear to be various ways in which the rotation can be imagined of the stable groups of electrons formed by the combination of atoms. The figures represent diagrammatically, according to Langmuir's system, rotating groups of electrons in the outer shells of molecules of neon, fluorine, and oxygen. In the case of the fluorine molecule the six electrons, forming two quartets with two electrons in common, may revolve as a whole. The same thing may happen in the oxygen molecule, or the electrons may revolve as three quartets. Revolution of the stable groups of electrons would add to the stability of the molecules formed by their combination and increase the directional steady-

ness of the valency forces. In this way it may be possible to reconcile Langmuir's theory with that of Bohr.

S. C. BRADFORD,  
The Science Museum, South Kensington,  
London, S.W.7, February 16.

#### Seconding of Officers for Study at Universities.

The War Office Memorandum recently issued rightly points with satisfaction to the arrangements made to allow Regular officers to take a full course of study at a university (A.O. 323 of 1919). Unfortunately, however, the conditions under which officers may avail themselves of this privilege are such that only the wealthy ones will be able to take advantage of it, for while seconded they will receive no pay or allowance from Army funds; indeed, it has not even been decided whether the whole or any portion of the period spent at a university will count towards pension.

I venture to suggest that pressure should be brought to bear on the War Office to secure that these privileges shall be open to officers of small means by allowing them to retain their pay and allowances during the time they are undergraduates.

J. WERTHEIMER,  
Merchant Venturers' Technical College,  
Bristol, March 8.

#### Scientific and Technical Books.

ONE part of the Descriptive Catalogue of the British Scientific Products Exhibition organised by the British Science Guild last year was devoted to selected lists of books on science and technology.

The guild has been asked to extend these lists, so as to include not only all branches of science, both biological and physical, but also the chief technical subjects. It has undertaken to do this, and a committee, of which I am chairman, has been appointed to prepare such a catalogue.

The lists will be limited to books of British origin actually in current catalogues of the publishers, so that they can be obtained in the usual way through booksellers. School books and elementary manuals will not be included, and the general standard will be that of college courses in scientific and technical subjects or of works libraries. Each list will be submitted to authorities upon the subject with which it deals, but in order to secure that no important work is omitted the committee invites the assistance of everyone interested in its task. Such aid may be afforded by sending (to the British Science Guild, 6 John Street, Adelphi, London, W.C.2) lists or single titles of British books of standard value or proved worth in any branch of science or industry. I shall much appreciate help of this kind which any readers of NATURE may be able to give.

R. A. GREGORY.

#### Daylight Saving and the Length of the Working Day.

SUMMER time this year is to begin on March 28 and end on September 27 (NATURE, February 26, p. 701). In this connection it may be of interest to point out one effect of the Daylight Saving Act which appears to have escaped notice.

During the six months when the Act is in operation the physiological working day is lengthened by one hour—that is to say, we are all practically compelled to be in active movement (of body or brain) for an hour longer than we normally should be. This lengthened day is accompanied by a curtailment of sleep, particularly in the case of working men who have to rise early, and children. It would be of interest to know the effect of these conditions on the worker's rate of production and the demand for shorter hours.

Hill House, Camberley.

ANNIE D. BETTS.

## Rainfall and Land Drainage.<sup>1</sup>

By DR. BRYSSON CUNNINGHAM.

THE problem of the economical disposal of surplus rainfall in cultivated districts is one which naturally engages the attention of the agriculturist and, as a consequence of his needs and interests, of the meteorologist, the engineer, and the lawyer. All three aspects of the matter have been dealt with recently in an article in *Engineering* and in two papers read before the Surveyors' Institution.

The precipitation of atmospheric moisture is counterbalanced in part by the processes of (1) evaporation, (2) transpiration, and (3) percolation, the residue forming the run-off which collects on the surface of the ground and ultimately finds its way to sea by watercourses, either natural or artificial. In cultivated areas it is essential that the soil should be drained promptly and effectively, and left in a "moist," as distinguished from a "wet," or saturated, condition. Ill-drained land is incapable of experiencing the full benefit of those seasonal physical and chemical changes which promote the growth and development of crops.

The article by Lt.-Col. Craster discusses the proportion of run-off to rainfall, and the author finds that it varies in this country, as also in America, roughly between the limits of 33 and 67 per cent. It has been found that 0.065 in. of water is required to wet a crop of rough grass about 5 in. in height, the aftermath in a hayfield, up to the point at which it commences to drip on to the soil. It may therefore be assumed that the amount of water required to wet vegetation and the surface of ploughed land is not less than 0.04 in. or 1 mm. The whole of this amount is lost by direct evaporation after every fall of rain. If the number of days with a rainfall of 0.04 in. or more be 127 (as in the North-East of England in 1918) and the number of days with less rainfall be 67, the direct evaporation for this area will be  $0.04 \times 127 + 0.02 \times 67 = 6.42$  in. As regards transpiration (*i.e.* absorption by vegetation), figures from German sources show that a beech wood transpires 14.2 in. of water per year; a crop of oats, 8.98 in.; and a crop of barley, 4.88 in. For an average of 9 in. per year this would be divided as follows: July, 25 per cent.; June, 18; August, 15; May, 12; April and September, 8 each; March and October, 5 each; and the remaining months, 1 per cent. each. Percolation is more difficult to estimate, owing to variable geological conditions, but, as a rough rule, may be taken at not less than 10 per cent. Summarising these figures for the North-East coast of England, there would be a residue, or run-off, of 8.7 in. out of an annual rainfall of 26.8 in., *i.e.* 32.5 per cent., and for Fort William, Inverness, a run-off of 52.67 in. out of an annual rainfall of 78.7 in., *i.e.* 67 per cent.

From a survey of the flood discharges in England and Wales, Mr. Clayton arrives at the conclusion that, while no general rule can be laid down, it is permissible to assume that in average areas the run-off to the sea is from 50 to 60 per cent. of the total rainfall. As the general average rainfall is about 32 in. per annum, this means that, roughly, 1800 tons of water per acre finds its way annually into rills, brooks, streams, and rivers. Taking into consideration the fact that about 60 per cent. of the whole rainfall occurs in the six months October to March, the general proposition is established that 36 per cent. of the total rainfall has to be received by watercourses during a period of 182 days, whence it follows that an average wet period run-off to sea is 0.0633 in. per day. In designing drainage channels and in order to cover reasonable cases of abnormal rainfall, Mr. Clayton advises that this figure should be multiplied by 5, and the result so nearly equals 1 per cent. of the total annual rainfall that he recommends the adoption of this standard.

The calculation is pursued further to the determination of the flow in tidal rivers necessary to discharge this accumulation of land water. Applying the rule to a catchment area of half a million acres, the total volume to be discharged within an ebb-tide period of fourteen hours per day is 576,000,000 cu. ft., or, say, 11,430 cu. ft. per sec., which for a distance to sea of twenty miles would necessitate a channel with a theoretical mean area of 2721 sq. ft.

The maintenance and deepening of these outlet channels are important considerations, but, unfortunately, the jurisdiction and supervision exercised over them are casual and unsystematic in the extreme. Before the railway era, river and canal navigation brought in revenues from tolls which enabled due regard to be paid to the drainage needs of the districts through which they passed, but the decay of inland navigation has resulted in the loss of these financial resources, and drainage conditions have, in many cases, become deplorable. This view is endorsed in Mr. Konstam's paper, which deals with the legal and administrative point of view. The startling assertion is made that it is doubtful whether there is a single river in England which is at present in a satisfactory condition as a means of draining water from agricultural land. Whether strictly or approximately true, the situation calls for earnest attention. Drainage authorities—known as Commissioners of Sewers in many parts of the country—date back to medieval times, and their powers and functions have, in many cases, become ineffective and obsolete. The Land Drainage Act of 1918, however, does something towards alleviating the situation by enabling the Board of Agriculture and the Ministry of Transport to sanction the transfer of a navigation undertaking to drainage functions. No doubt in process of time some degree of co-ordination and system will be established.

<sup>1</sup> "Estimating River Flow from Rainfall Records." By Lt.-Col. J. E. E. Craster. *Engineering*, January 2.

<sup>2</sup> "Land Drainage from the Engineering Point of View." By C. H. J. Clayton.

<sup>3</sup> "Land Drainage from the Administrative Point of View." By E. M. Konstam. The last two are papers read before the Surveyors' Institution on January 12.

## The Work of the Medical Research Committee.

WHEN a certain small fraction of the National Health Insurance funds was set apart for purposes of research, the experiment was regarded even by many scientific men with suspicion or indifference. It was suggested that the State aid, thus provided for research, would result only in creating a new class of Civil Servants, and might, indeed, lead to the sterilisation of such of the younger men as had earned appointment under the scheme by the excellence of their early researches. It was also objected that any concentration of State aid in a central institute or among a single group of workers would be effected only at the price of starvation of the work already being carried out with insufficient means in the various universities and research institutes of the country. The work of the Medical Research Committee during the first five years of its existence has brilliantly refuted such *a priori* objections, and has, indeed, justified the view that the action taken in 1914 represents the greatest advance in the organisation of scientific effort in the service of medical science that has yet taken place in this country. The Committee seized the opportunity afforded by the war, and initiated and supported numerous investigations urgently required for the effective treatment of our soldiers in the field. So well did it succeed that, by the end of the war, it had secured for practically all the men fitted for original inquiry not only the opportunity, but also adequate payment, either by way of commissions in the Navy, or Army, or Air Force, or by research grants.

As the report points out, the casualties and mortality of peace are not smaller and less painful, but only less conspicuous and more familiar, than those of war. For example, the epidemic of influenza killed during a few months more young people in their prime than fell in battle during the whole war. Fully justified, then, are the efforts made by the Medical Research Committee to create and maintain organised scientific work, which shall repeat and continue for the maladies of peace the same success as was effected for those of war. Taking the difficulties of the situation into account, the report is really a wonderful record of achievement.

The Committee carries out its work in two directions. In the first place, it maintains a small nucleus of workers in whole-time service. Most of these will pursue their researches in the central institute, located in the old Mount Vernon Hospital, which has been adapted for this purpose; though, where the object of the work requires it, these workers may be attached to hospitals or laboratories elsewhere. Thus during the past year both Dr. Lewis and Dr. Elliott were attached as whole-time workers to University College Hospital, and other whole-time workers pursue their researches at Cambridge, Oxford, and St.

Bartholomew's Hospital. In the second place, the Committee assists organised research already in progress at different universities and medical schools by means of grants made in payment for part-time work. We are glad to see that the Committee declares its desire to assist in this manner the work of the units which are being formed in London for higher clinical teaching and research.

The record of work for the past year must be regarded as highly creditable and a striking testimony to the value of the aid which the Committee has been able to render. Scarcely any aspect of medical science has been left untouched. Collective investigations have been undertaken on tuberculosis, on dysentery, on typhoid and paratyphoid, on the treatment of wounds, and on cerebro-spinal fever and influenza. Fundamental problems of nutrition have been attacked especially by the Committee on Accessory Food Factors, which has carried out researches not only in this country, but also in Vienna, and thrown much light on the causation of rickets and on the factors concerned in normal growth. The investigation of the disorders of the cardio-vascular system, including the causation of soldier's heart (in which such valuable results were attained during the war), has been continued, and a special department for this purpose has been instituted under the care of Dr. Lewis. The research into trench nephritis is being continued by Dr. MacLean and extended to include all forms of nephritis. The report records also the results of researches on the effects of oxygen lack, on chronic arthritis, on wound shock, on industrial fatigue, and on many other subjects.

The great value of the Committee's work is that in a time of transition, when the community is slowly awakening to the value and necessity of research in medicine, but has not yet provided the necessary organisation and support, it is making it possible for practically all provided with the necessary intellectual endowments to take up scientific work, at any rate for a time. No doubt many of these workers will later pass into practice; but the Committee by its action is creating a reserve of scientific workers, from which the country will be able to draw its teachers and teams of research workers, when once it recognises the need for them and is prepared to provide such salaries that a man can devote himself to the advancement of knowledge without taking vows of celibacy and poverty. There will always be a small handful of men in every country who will devote their lives to this cause. Faradays, however, are few and far between, and the vast majority of men of first-class intelligence are not prepared to make the supreme sacrifice. The country has need of these men to fill its depleted ranks of scientific workers, academic and industrial, but it will not obtain their services until it can provide a career in science equal in status and remuneration to that afforded by other professions.

<sup>1</sup> National Health Insurance. Fifth Annual Report of the Medical Research Committee, 1918-19. Pp. 90. (London: H.M. Stationery Office.)

### The Mariner's Compass.

MORE than 300 years ago William Barlow, writing of the compasses of his day, said that, though the compass needle was "the most admirable and useful instrument of the whole world," yet nothing was more "bunglerly and absurdly contrived." How little advance was made in the succeeding two centuries can be gathered from Peter Barlow's remark to the Lords of the Admiralty in 1820 that "the compasses in the British Navy were mere lumber, and ought to be destroyed." It was Barlow himself who made the first notable improvements in compasses during the nineteenth century, and his work was the prelude to the important investigations of Airy, Archibald Smith, Kelvin, and others. The practice of "swinging ship"—that is, turning a ship slowly round and noting the deviations of the compass in different positions by taken bearings—was introduced in 1810 by Matthew Flinders, who also invented the use of the "Flinders bar," a rod of soft iron placed near the compass to correct for changes in the magnetism of the ship due to the vertical component of the earth's magnetism.

The gradual increase in the employment of wrought-iron fittings in wooden ships; the use of iron cables instead of hempen; the placing aboard of ponderous iron boilers and engines; and, lastly, the construction of the vessel itself of iron, each in its turn added difficulties to the problems involved. Barlow, in his attempts in 1819 to find a remedy for the large deviation due to the extending use of iron in ships, made the first experimental investigation of the phenomena of induced magnetism. From his inquiry he was able to give a simple means of correcting ships' compasses by fixing soft iron discs in suitable places near the compass, and he afterwards introduced a type of compass having four or five parallel straight strips of magnetised steel fixed under a card, which remained the standard pattern until Kelvin brought out his famous patent in 1876.

The mathematical investigations of Poisson and Airy about 1838 led to the introduction of methods of correction by the use of permanent magnets, and also of the well-known soft iron spheres. Many of Airy's experiments were made in the iron vessel *Rainbow* off the old Woolwich Dockyard.

The story of Kelvin's share in the improvement of the compass has often been told. Asked in 1871, by his friend Norman Macleod, to write an article

for the newly founded magazine, *Good Words*, Kelvin chose as a topic the mariner's compass. The first part of his article appeared in 1874, and the second not until five years later. "When I tried," he said, "to write on the mariner's compass, I found I did not know nearly enough about it. So I had to learn my subject. I have been learning it these five years." The Admiralty standard compass, adopted in 1842, and in use when Kelvin took up the matter, had a card  $7\frac{1}{2}$  in. in diameter, and under it four needles, each of which was a long, straight bar of flat clock spring placed on edge. The card and the needles weighed about 1600 grains, and had a period of vibration of 19 sec. So considerable was the friction that the binnacle was often kicked by the sailors to make the card move. Kelvin's "gossamer structure" of eight small needles weighed about 170 grains, and had a period of about 40 sec. The cold reception Kelvin received from the then Hydrographer to the Navy, and Airy's remark on the compass, "It won't do," remind one of the reply made to Berthon in 1835: "The screw was a pretty toy which never would and never could propel a ship."

The ultimate adoption of the Kelvin compass was largely due to Lord Fisher, who had one on board the *Inflexible* at the bombardment of Alexandria in 1882. Torpedo craft, however, continued to be supplied with a form of compass in which the whole card floats in liquid, and improvements made in this type led to its being adopted as the standard compass about 1906. Since this has come the invention of, first, the Anschutz, then the Sperry, and, now, the Brown gyro-compasses, the introduction of which has taken place during the last ten years. As remarked by Mr. S. G. Brown in the Royal Institution discourse reproduced below, the gyro-compass is a necessity in a submarine, while in larger vessels it has the great advantages that it can be placed below the water-line more or less immune from gunfire, and lends itself to utilisation with fire-control apparatus and the torpedo director.

All the work on compasses for the Navy is to-day carried out at the new Admiralty compass observatory at Ditton Park, near Slough, where the work of the five departments—the gyro-compass branch, magnetic compass branch, optical branch, experimental branch, and air compass branch—is superintended by the director, Capt. F. O. Creagh-Osborne.

### The Gyrostatic Compass.

By S. G. BROWN, F.R.S.<sup>1</sup>

THE subject of this lecture is the gyrostatic compass, often called the gyro-compass. An engineer of my acquaintance was asked if he under-

stood what a gyro-compass was, and he replied, "Of course I do; it is a magnetic compass mounted upon a gyroscope." Now the gyro-compass has nothing to do with magnetism or the magnetic compass. The

<sup>1</sup> Discourse delivered at the Royal Institution on Friday, January 30.



only thing that these two instruments have in common is the property of pointing north and south. I am anxious that this should be clearly understood, because in a recent lecture I gave at Bournemouth on this very subject one of the audience asked me after the lecture how the gyro-compass was shielded from outside magnetic influence. I pointed out, as I had endeavoured to do during the lecture, that the gyro-compass had nothing to do with magnetism, and, therefore, did not require shielding. The magnetic compass and the gyro-compass are, in fact, two absolutely different instruments operated by entirely different laws, although they are for the same purpose.

As many people do not understand why a gyro-compass is needed when the magnetic compass is already available, it is worth while to describe briefly the magnetic or mariner's compass before attempting to explain the gyro-compass. The mariner's compass consists of a magnetic needle, or of several magnetic needles fixed side by side, and balanced upon a sharp point. A card divided into thirty-two (points of the compass) is attached to the needle, and swings round with it, so that the point marked N on the card always points to the north.

The earth, as we know, is a magnet, but not a very powerful one, and it has been calculated that if it were wholly of iron it would have an intensity of magnetism 17,000 times greater than it has. All the same, the magnetism is sufficiently strong to give a good directive action to a pivoted needle. The magnetic poles of the earth are not coincident with the geographical poles, but are situated some distance away. The north magnetic pole was discovered by Sir J. C. Ross to be situated in latitude  $70^{\circ} 5' N.$  and longitude  $96^{\circ} 46' W.$  in Boothia Felix, just within the Arctic Circle some 1000 miles away from the actual pole.

With this displacement of the magnetic poles we have an irregular distribution of the magnetism over the surface of the earth; and thus the magnetic needle does not point truly north and south at many parts of the earth's surface. In London, for instance, it points at an angle of  $16^{\circ} W.$  of the true north. This angle is called the deviation or variation of the needle. To enable ships to steer by the compass, magnetic charts have been prepared and the deviation at different places accurately measured. These magnetic charts have to be checked and altered from time to time, as the deviation slowly varies from year to year. Thus in London in 1650 the needle pointed true north, while in 1820 there was an extreme westerly variation of  $24\frac{1}{2}^{\circ}$ . Since then it has been slowly coming back to something like  $16^{\circ}$  at the present time.

On a wooden ship the accuracy of a good modern magnetic compass leaves little to be desired, but on an iron ship the case is quite different. The magnetic field of the earth tends to be weakened in the lengthwise direction of the iron ship, because a portion of the magnetism enters the ship, while across the ship the field is stronger; and as it is essential that the magnetism in which the needle lies should be uniform in strength in whatever direction the ship may happen to point, it is important that this stronger field should be reduced by some method of magnetic shielding. This is accomplished by fixing a pair of iron globes athwart the ship on the two sides of the compass. The effect of the iron of the ship and the corrections that have to be made to the compass is to reduce the directive force of the earth's magnetism, and thus the compass is rendered slow and sluggish in its action. This is particularly the case on board a battleship. In the interior of a submarine the force is still further reduced, so much so as to render the magnetic compass useless for this class of vessel.

It is quite possible on an iron ship to correct the

errors of a compass, but as the ship itself may be a magnet, and its strength a variable quantity, it is important that the navigator should test the readings of his compass at every available opportunity, and particularly at the commencement of each voyage. The ship's magnetism may quickly change through the hammering action of the waves, through the heating action of the sun on one side of the vessel, or through an earth on any of the electric wires that may be running near the compass; all these things together add to the anxiety of the captain, as he is never quite certain how far the compass is correct in its readings.

The swings of the modern compass are damped by immersing the needles and card in a liquid such as alcohol, but as this fluid is attached to the ship and turns with it, swinging the ship in any direction carries the liquid round and reacts on the needle and card, so that the compass has a tendency to be carried round with the vessel. This lag in the instrument renders it difficult to hold a ship dead on her course, and the path, as a consequence, is sinuous, and may oscillate, even in a calm sea, as much as  $7^{\circ}$  each side of the correct heading. As a ship has usually to steam entirely by the readings of the compass, any error is serious. For instance, if there is an error of  $1^{\circ}$ , and the ship is steaming at sixteen knots, she will move one English mile off her course every hour. It is obvious how necessary it is to have absolutely correct readings.

Lord Kelvin was the first seriously to study the errors of the magnetic compass. He started in 1871, and in 1876 produced his well-known instrument. Although it was a great advance on any compass in the British Navy, he had the greatest difficulty to get it adopted; finally, in 1879 he proposed to place an instrument at the disposal of the Admiralty at his own expense. This offer was accepted. In spite of this, it was only through the acquaintance of influential naval officers, particularly of Capt. (now Lord) Fisher, that the compass was ever adopted. In 1880, eighteen years after the commencement of his experiments, and long after it was in common use in commercial ships, he received official notification that his 10-in. compass was to be adopted in future as the standard of the Navy. It is fortunate that we have an alternative method of securing a north-seeking property in the gyro-compass, an instrument of much greater accuracy than the magnetic and with none of its errors; for if deviations do occur they are known deviations, and can therefore be allowed for.

Evans and Smith, in 1861, were the first to discover how important it was to mount the needles on the card so that the moments of inertia of the moving system should be the same about all directions—that is to say that the system should be in dynamic balance, otherwise the rolling of the ship would cause deviations in the reading. I have lately discovered that another deviation may be brought about, not by an oscillation in one direction, but by the card being set wobbling; the needles and card would then have a force applied trying to carry the moving system round in the direction of the wobble.

I have a magnetic compass here to demonstrate this. It consists of a heavy brass disc mounted on a vertical frictionless spindle. The needles are fixed to the disc, and the whole movable system is carried on a pendulous mounting, as in the gyro-compass. The disc and needles are in correct static and dynamic balance. Swinging the pendulum in any one direction produces no deviation, but by making it swing in a circular conical path, thus giving a wobble to the plate, a serious deviation is caused in the reading of the compass. The error is permanently maintained against the earth's attraction so long as the circular

motion of the pendulum persists. When the compass is carried round in a horizontal circular path without wobble, the plate still goes round, or tries to go round, with a circular movement. This should be of interest to mathematicians.

Before leaving the instrument I will set it spinning so as to demonstrate the frictionlessness of the vertical axis. It is rotating now entirely by means of the energy of the motion of the plate, and I think you will find at the end of the lecture that it is still revolving, but, of course, not so fast as at present.

The magnetic compass is a simple piece of apparatus, but it is complicated in its readings and corrections, and points to the magnetic north. The gyro-compass is a complicated instrument, but simple in its readings, and it points to the true north.

Before proceeding to describe the gyro-compass I wish to direct attention to the equipment here displayed. A gyro-compass is in full operation, and at the present moment is recording its movement upon a travelling strip of paper. About half an hour before the lecture started the compass was deflected from the north position, and it has since been left to itself. The record shows that it is engaged in swinging back

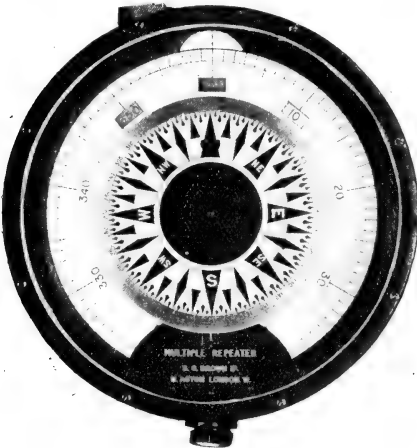

FIG. 1.

again to the north, recording a curve upon the paper strip, and this record can be followed during the whole of the lecture.

The compass is working two repeaters, which truly copy the reading of the master compass. Of course, any number of repeaters could be used on board ship if it were necessary. The steering repeater (Fig. 1) has a card that revolves four times to one of the master, and the divisions are, therefore, very much enlarged. The other is a correction repeater; it moves backwards and forwards very slightly, and this motion we term the "hunt." In the steering repeater the "hunt" has been cut out by providing the mechanism within the case with a requisite amount of slackness.

About sixty-eight years ago Foucault did what was thought a wonderful thing at the time; he gave a lecture-room proof that the earth was rotating on its axis—he looked through a microscope at a gyrost. He could not get a frictionless, free, vertical axis, so that the experiment could not last for long. I shall be able to show you a piece of apparatus which carries out Foucault's idea in a perfect way, and will be visible to this audience.

NO. 2628, VOL. 105]

A gyrost. consists of an accurately balanced spinning wheel, mounted with as little friction as possible, and in such a way that the axis of the wheel may point in any direction in space. Mere translation in space has no action on the instrument; carrying it about, for instance, does not alter the direction of the axis. On the other hand, the gyrost. is acted upon by any force that tends to tilt the axis or to give the axis a new direction in space.

The wheel (Fig. 2) spins round its axis; call the direction of this  $oa$ . If we impress a force upon the wheel tending to tilt or rotate it round another axis  $ob$ , then the rule is that the spinning wheel will "precess" or move in such a direction as to try to make the two axes  $oa$  and  $ob$  coincide, and the direction of spin of the wheel to coincide with the new direction of rotation that we are trying to produce by the applied force.

An electric circuit has similar mathematical laws to those of the gyrost., and may be used as an illustration. The circuit here used (Fig. 3) consists of

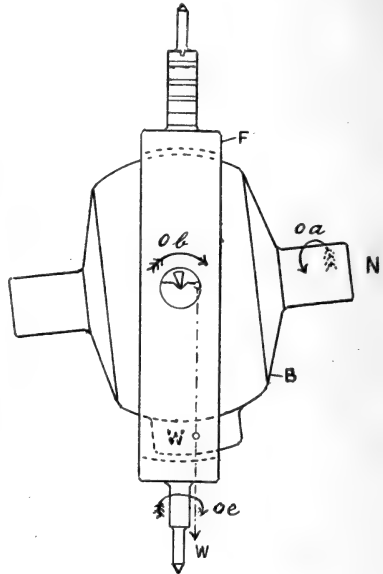

FIG. 2.

an outer fixed coil and a central suspended coil. A strong direct current indicated by  $a$  is kept flowing in the central coil; this corresponds to the spin of the wheel. If a direct current indicated by  $b$  is sent round the outer coil, then the central coil will move in such a direction as to make not only the axes of the magnetic fields of the two coils, but also the direction of the two currents, coincide. In fact, the coils will move, or try to move, in such a way as to make the self-induction of the whole circuit a maximum.

This is very much like the gyrost., or, in fact, any piece of mechanism which under impressed forces tends to move so as to make the whole moment of momentum a maximum. Suppose, therefore, a gyrost. has its axis  $oa$  fixed parallel to the earth's surface, but free to turn in "azimuth," as it is called, upon a frictionless vertical spindle; the earth will act upon such an instrument, and it would be a gyro-compass.

The earth as it rotates is continually tilting the axis of the wheel in space; the wheel will therefore turn

so as to set its axis of rotation as nearly as possible parallel to the axis of the earth. It is only when the two axes coincide that the wheel is free of any further tilting action—that is, when it is pointing true north; deviate the axis, however slightly, from this position of rest, and the action of the earth comes in again to precess the wheel back again to the north.

Here is a simple form of gyrostat with three degrees of freedom. If I hold it in my hand and revolve on my axis, this does not move the wheel, which still keeps pointing to the same part of the room. On the other hand, if I restrain or clamp one of its degrees of freedom so that I am able to tilt the axis of the wheel during my revolution, the wheel is caused to precess and to set its axis parallel to the axis on which I am revolving. Reversing the rotation, the wheel also reverses.

This is what takes place with the gyrostat on the earth's surface provided it is frictionlessly mounted. Such an instrument is before you, and I will try to demonstrate by its means the rotation of the earth. A wheel is rotating inside this case at 15,000 revolutions per minute. The case is constrained to move

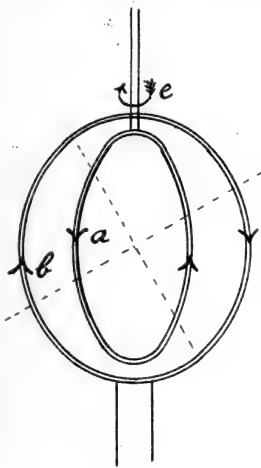

FIG. 3.

about this vertical frictionless axis. Mere motion of translation has no effect in changing the direction of the axis of the wheel, but if this room rotates the axis of the wheel tends to set itself parallel to the axis about which the room is rotating.

We all believe that this room is rotating about the axis of the earth; if so, the axis of the wheel must set itself parallel to the axis of the earth, but it must be kept horizontal, and, therefore, it will point north and south. Here it is pointing in an east-and-west direction; it is held by a string. I will now burn the string, and it will find for us the true north. Observe that it is really the true north direction, whereas that magnet points to the magnetic north. I set it away from the north, but on the other side, and repeat the experiment.

Such a simple form of gyro-compass could not be of any use on a moving ship, because the rolls of the ship would react too violently on the spinning wheel and cause considerable deviations in the readings of the compass. The use of a gyro-compass on land is very limited, and its great value at the present time is on board ship. The spinning wheel is acted

upon by forces which tilt the axis. Now, a rolling and pitching ship is about the worst place to put a gyrostat to act as a compass, because the ship's movements all tend to tilt the axis.

The problem, therefore, is to make the compass insensible to the movements of the ship and respond only to the slow angular rotation of the earth. To indicate the severity of the ship's movements, I may recall a recent trip of this gyro-compass on board a fast destroyer. During a severe gale the ship was recorded to roll more than  $50^\circ$  of total angle. Many of the crew were forced to lie on the decks, the lockers emptied their contents, and even some of the oil-lamps suspended from the ceiling were unseated by the pitching of the vessel; yet the gyro-compass maintained its accuracy, and allowed the ship to be steered safely into harbour, to which she had to run for safety. In all this whirlwind of movement the gyro-compass held, and only responded to, the still, small voice of the earth's rotation.

For use on board ship the compass must be mounted on a pendulum in gymbal rings, and its period of oscillation is lengthened to something like  $8\frac{1}{2}$ , which is usual in practice, so that the rolls, which are of the order of 7 to 15 seconds' period, shall have but small effect on the compass. In this case the rotation of the earth does not act directly upon the gyro-wheel, but by means of the force of gravity through the pendulous weight. Unfortunately, this form of mounting introduces troubles of its own.

Suppose we study our simple gyrostat and see what happens when we attach a weight to the end of the horizontal spindle; this will give us some idea of what occurs when the force of gravity is acting through the pendulum trying to tilt the gyro-wheel.

We know from our law that the wheel will precess under the tilting action, but the new direction of rotation that we are trying to produce by means of the weight, unlike that produced by the earth, which is always in one direction, is in this case continually carried round by the precessing wheel, and the precession is, therefore, permanently maintained. We also find that if we hurry the precession the spindle rises, lifting the weight; while, on the other hand, if we delay the precession, the spindle drops and the weight falls. The rate of precession is proportional to the weight. Halving the weight, for instance, halves the rate at which the wheel rotates round the vertical support.

Coming back again to our pendulous-mounted gyro-compass (Fig. 2); suppose the spindle is pointing west and is horizontal, then the earth as it rotates will leave the wheel pointing in this one direction in space, but the weight will try to follow the earth's rotation, and will start precessing the gyro towards the north. The rate at which the wheel comes to the north depends upon the weight  $W$  attached to the casing. All the time the wheel is coming to the north the earth is adding to the rate of the precession, and the spindle is, as a consequence, tilted, and deflecting the weight at the north position. Under these conditions the effect of the weight is to continue the precession, and the gyro-wheel will swing through the north position, and continue to move until the effect of the earth arrests and reverses the motion.

The compass will therefore continue to swing through the north position with constant amplitude backwards and forwards, undamped. To render the compass of use, some method of damping the swing must be introduced so that the compass may finally settle on the north. This damping can be carried out by means of friction, preferably fluid friction, between the vertical spindle and its support; but, although this will damp the swings, it is inadmissible because

the movements of the ship would react through the friction and cause errors in the reading.

Anschutz, in his early form of compass, by use of an air blast, gets rid of this connection with the ship. The air blast was arranged to oppose the movement in azimuth when the wheel tilted, and thus he obtained an effective method of damping. The strength of the air blast, which varies proportionally to the tilt, should be nothing when the compass is at rest on the north—that is, when the tilt is nothing—and this would be true with the compass on the equator.

In other latitudes, however, the compass rests at the north with a tilt still remaining. It does not come back to the horizontal position because the axis of the wheel is trying to set itself parallel to that of the earth. This leaves a residual air blast continuously acting, producing a permanent twist in azimuth and a constant error. It is, therefore, preferable to damp the swings of the compass by acting upon the tilt rather than upon its movement in azimuth, because in this case there will be no latitude error. The tilt is a maximum at the middle of each swing—that is, when it is moving through the north position—and it is the return of the weight to its truly vertical position that is responsible for the continuation of the oscillation; we therefore require some method of neutralising the action of the weight, not before, but after, the compass has reached the north. This I accomplish in the Brown gyro-compass by automatically moving a liquid from one bottle to another, and in such a direction as to counterbalance the weight, precessing the gyro-wheel, and I delay its action by means of a valve or constriction in the tube joining the two bottles.

The force with which the compass seeks the north is proportional to the product of the rotation (one revolution in twenty-four hours) and the spin of the wheel. The faster we can spin the wheel, the more do we obtain directive force. It is for this reason that the wheel is rotated at its maximum speed and strength consistent with the rise of temperature.

Taking the Brown gyro-compass as an example, the wheel, which is 4 in. in diameter and  $4\frac{1}{2}$  lb. in weight, runs at 15,000 revolutions per minute. The maximum directive force of the earth on this wheel—that is, when the spindle is pointing east to west—is only the weight of 30 grains, with a leverage of 1 in. This small force is continually diminishing in value as the axis approaches the north direction, and vanishes absolutely in that position. If the compass was deflected, say,  $1^\circ$  from the north, then the force of restoration is only  $\frac{1}{3}$  grain at a leverage of 1 in. It will therefore be seen how important it is to eliminate as completely as possible any friction on the vertical axis that would tend to oppose the directive action of the earth.

There are three forms of gyro-compass now in use: the Anschutz (German), the Sperry (American), and the Brown (British). In the Anschutz the vertical axis is supported by a bath of mercury, and in the Sperry by a suspended wire, the twist, if any, being taken out by a follow-up motor through an electric contact, which switches on the current to the motor; while the Brown is operated by a hydraulic system of support. The lower end of the vertical spindle acts as a ram and stands upon a column of oil. The oil is under great pressure, some 500 lb. per square inch, and is kept pumping up and down, and thus raising and lowering the vertical axis continually some 180 times every minute.

The continual movement of the spindle results in a practically frictionless vertical support, so that the total moving part, some 7 $\frac{1}{2}$  lb. in weight, can be carried round in azimuth by the smallest force, due to the earth's rotation; in fact, so small is the friction

that the compass, if deflected, will always come back again to its true north position, certainly within one-tenth of a degree. I think I am safe in saying that it is the most perfect frictionless support yet given to the vertical spindle of any gyro-compass, or, indeed, of any machine.

In an earlier part of this lecture it was stated that the period of oscillation given to a gyro-compass is of the order of 85'. I will now try to explain why this is so. The earth has no angular movement from south to north, but has one from west to east, due to the daily revolution on its axis. A ship, however, sailing to the north at, say, twenty knots an hour introduces an angular movement in that direction because it is moving over the curved surface of the ocean, and would complete a revolution of the globe in forty-five days.

If there were a gyro-compass on the ship the instrument would be sensible of these angular movements, set itself so as to make a compromise between them, and, as a consequence, point, not to the true north, but one or more degrees west of the actual pole. This division is termed the "north steaming error." Knowing the latitude, the speed of the ship, and its direction towards the north and south, the extent of the error can be accurately calculated, and speed-correction tables have been prepared so that this error can be determined for any latitude, speed, and heading of the ship, and can be allowed for.

Automatic means have also been devised to make these necessary corrections in the reading of the compass. For instance, my special form of repeater has been designed so that the card can be set eccentric, and, when once set, the correction will be automatically applied without any further reference to the tables.

When a ship is in harbour a gyro-compass on board points due north, but when the ship starts steaming to the north the compass begins an oscillation so as to bring the axis of the wheel into the new resting position to include the north steaming error in the reading. Getting up speed will, however, have another effect on the compass. We know that the gyro-wheel is acted upon by a pendulous weight. As the ship changes its speed the acceleration will act upon the pendulous weight and cause an oscillation to be started. This oscillation is termed the "ballistic deflection."

The permanent north steaming error and the transitory error due to the ballistic deflection are in the same direction, and mathematicians have calculated that with an undamped gyro-compass, if the time of its oscillation is set to 85' in any particular latitude, the ballistic deflection can be made exactly the same as the deflection due to the north steaming error; this being so, the compass should move into its new resting-place without further oscillation. This would be true if, as before indicated, the compass were undamped in its swings, but the mathematicians have overlooked the fact that all gyro-compasses are damped, and the ballistic deflection must, therefore, include a term due to the damping.

This damping term up to the present has been neglected, but in practice it is found that when a ship is steaming and turning to alter its course the compass does not come dead-beat to its new position, but has an oscillation started which is common to all existing gyro-compasses. The extent of this oscillation may be termed the "damping error." On a merchant ship the damping error is of little moment, but on a war vessel which is manoeuvring it may be serious, as it may swing the compass off its correct reading by several degrees.

(To be continued.)

## Obituary.

PROF. J. EMERSON REYNOLDS, F.R.S.

PROF. JAMES EMERSON REYNOLDS, whose death at seventy-five years of age was announced in NATURE of February 26, was born in 1844 in Booterstown, a suburb of Dublin. His father was a medical practitioner and proprietor of a medical hall, and it was while assisting his father that he first became enamoured of the study of chemistry. Destined to follow in the profession of his father, Reynolds studied medicine, and became a licentiate of the Royal College of Physicians and Surgeons of Edinburgh. Although he practised in Dublin for a short time, his great desire was to devote himself to chemistry, and his chance to discard medicine soon came when, in March, 1867, he was appointed "keeper of minerals" at the National Museum in Dublin, and in the following year analyst to the Royal Dublin Society. It was here that he made his first important contribution to chemistry. In 1869 he discovered thiocarbamide, the sulphur analogue of urea, which he obtained as a result of the isomeric transformation of ammonium thiocyanate. This was a discovery which attracted a good deal of attention at the time, since Liebig and, later, Hofmann had both been unsuccessful in their attempts to isolate the compound—in fact, Hofmann had previously suggested that ammonium thiocyanate was probably thiourea.

Two years later, in a paper communicated to the Royal Society, Reynolds described the preparation of an interesting compound of acetone and mercuric oxide, of the composition  $2(\text{CH}_3\text{CO}\cdot\text{CH}_3)_2\text{HgO}$ , which was the first example of a colloidal mercurial derivative. The conditions under which this body is formed constitute a very delicate reaction for the detection of acetone.

In 1875 Reynolds was appointed to the chair of chemistry in the University of Dublin in succession to the late Dr. Apjohn, having previously been for two years professor of chemistry at the Royal College of Surgeons of Ireland. He quickly established for himself a high reputation as a teacher and lecturer, and for a few years his energies were mainly directed towards the development of the teaching of chemistry on original lines. Shortly after his appointment he commenced the writing of his well-known "Experimental Chemistry for Junior Students," which was ultimately published in four small volumes. The first volume was a distinctly original work. By the aid of a progressive series of simple and well-tested experiments, the junior student was enabled to verify for himself the fundamental laws of chemistry by quantitative results. Whilst the quantitative method is now universally adopted in the early training of the student, Reynolds must be given the credit of having been the first to introduce it, now forty years ago. The experimental illustration of his

lectures was a matter to which Reynolds gave great attention and a good deal of his time. If, from one cause or another, an experiment failed, which was of rare occurrence, it was always successfully repeated on the following occasion. As a result, his lectures were very attractive, and the discipline which he maintained in his classes was proverbial in the college.

This, it can be understood, was not attained without the display of a certain amount of well-meant severity, and, though Reynolds always refused to nourish popularity at the sacrifice of a surrender of discipline, he was nevertheless held in high esteem by all young men who came under his tuition. Past students have many times spoken to the writer of their great appreciation of Reynolds as a lecturer, teacher, and disciplinarian.

Whilst his professional duties absorbed most of his time, Reynolds continued research, and, from a comparison of the specific heats of silver and beryllium (glucinum), which he had prepared in a nearly pure state, he showed that the atomic weight of the latter must be taken as 9, and that the element was a member of the family of alkaline earths.

In 1885 his researches on organic derivatives of silicon, in which this element was united to nitrogen, were commenced. The results were described in a series of more than a dozen papers published in the Transactions of the Chemical Society up to 1909. Amongst several new substances which were prepared, perhaps the most interesting was the beautifully crystalline silico-tetra-phenylamide,  $\text{Si}(\text{NH}\cdot\text{C}_6\text{H}_5)_4$ , the carbon analogue of which has never been obtained, and by the action of heat silico-diphenylimide,  $\text{Si}(\text{NC}_6\text{H}_5)_2$ , was obtained, the carbon analogue of which is well known. After twenty-eight years' occupation of the chair of chemistry in the University of Dublin, Reynolds retired in 1903, and went to live in London, where he continued work in the Davy-Faraday Laboratory.

Reynolds's last contribution to chemistry, published in the Proceedings of the Royal Society in 1913, was an interesting synthesis of the mineral anorthite,  $\text{CaAl}_2\text{Si}_2\text{O}_8$ , which he prepared by the combined action of oxygen and water vapour at a high temperature on the synthetic substance  $\text{Ca}(\text{SiAl})_2$ , which he had previously prepared. Reynolds had many honours conferred upon him during his career. He was elected a fellow of the Royal Society in 1880, and vice-president in 1901, president of the Chemical Society 1901-3, president of the Society of Chemical Industry 1891-92, and president of the chemical section of the British Association in 1893. Reynolds died suddenly on Tuesday, February 17, at his residence in London. He was an honorary M.D. and Sc.D. of the University of Dublin. He married, in 1875, a daughter of Canon Finlayson, of Dublin. He leaves two children, a son and a daughter.

E. A. W.

WE much regret to see the announcement of the death on March 9 of M. Lucien Poincaré, Vice-Rector of the University of Paris, at fifty-eight years of age.

DR. SAMUEL HATCH WEST, who died on March 2 at the age of seventy-one, was well known in London as a consulting physician. He was trained at Oxford under Rolleston and Acland, and as Radcliffe travelling fellow he studied in Vienna and Berlin. He was physician to the Royal Free Hospital and to the City of London Hospital for Diseases of the Chest, but his life's work was carried out at St. Bartholomew's Hospital, where he received his medical education, and held successive medical appointments until he became full physician. Dr. West was a successful clinical teacher, and many generations of students will be grateful to him for the thorough manner in which he taught them to examine a patient, system by system, so that no important organ could be overlooked. Dr. West deserved his high reputation as a careful clinical observer. Diseases of the lungs were his particular study, and on this subject he produced a monograph in two volumes which is a monument of industry and a veritable mine of information. He delivered the Lettsomian lectures at the Medical Society of London in 1900, taking as his subject "Granular Kidney," but it is by his teaching and his work on diseases of the lungs that he will best be remembered.

A CORRESPONDENT, "G. P. B.," writes:—"All zoologists who have ever worked at the 'Stazione Zoologica' of Naples will be grieved to read of the death of Prof. Eisig, whose obituary notice by Prof. R. Dohrn appears in the Zürich *Zeitung* of February 19. Hugo Eisig was born in Baden in 1847. When Anton Dohrn, aged thirty-one, decided to sink his whole fortune in the building of the Naples station, knowing that it would suffice to rear up only the ground story, his friend Kleinenberg went with him; Eisig, seven years their junior, offered himself also, and was accepted. Many years of great difficulty followed, and then many years of very great success. Through all Eisig continued the career which he had chosen as part and parcel of the *Stazione Zoologica*. His contribution to zoology is not to be measured by his published work, even though it includes his great 'Monograph of the Capitellidæ.' To all of us who worked at Naples he was a friend, loyal, sympathetic, unselfish, and gentle: In 1907 Eisig retired on a pension from his administrative post in the Zoological Station, but continued his own zoological work. Two years later Anton Dohrn died, and was succeeded by his able son, but in 1915 Prof. Reinhard Dohrn, with Eisig and others of the staff, had to leave Naples for the hospitality of the Zürich Zoological Museum and Swiss territory. There Eisig died on February 10 last from the after-effects of an operation which appeared to have been successful. He died in exile from his home of forty-four years, but in the warm memory of many friends all over the world."

## Notes.

A MEETING convened by the Chancellor of the University of Cambridge and the president of the Royal Society was held on Thursday, March 4, at the rooms of the Royal Society, to consider the question of a memorial to the memory of Lord Rayleigh. After a preliminary statement by the president of the Royal Society announcing the purpose of the meeting, speeches in favour of the proposal to erect a memorial were made by Mr. A. J. Balfour, Sir Charles Parsons, Dr. P. Giles (Vice-Chancellor of the University of Cambridge), Sir Arthur Schuster, Sir Richard Glazebrook, and Sir Joseph Larmor. It was agreed that a fund should be raised for the purpose of placing a memorial, preferably a window, in Westminster Abbey. A general committee was appointed, as well as an executive committee, to consider details, and also the further question of raising a fund in memory of Lord Rayleigh, to be used for the promotion of research in some branch of science in which Lord Rayleigh was specially interested.

A PUBLIC meeting was held in the University Museum, Oxford, on March 6, to initiate a memorial to the late Sir William Osler, Bart., Regius professor of medicine in the University for the past fifteen years. The Vice-Chancellor presided. Sir Clifford Allbutt, who introduced the proposal, paid a feeling and eloquent tribute to the memory of Sir William Osler, to the wide range of his intellect, and to the singular charm of his character. He referred to his international reputation and to the binding influence he had on the medical profession in many lands, to his love of peace and goodwill, and to the extraordinary power he exerted in diffusing without diluting friendship. The president of Magdalen, Sir Herbert Warren, mentioned the many-sidedness of Osler's interests and activities, the breadth and accuracy of his scholarship, and the clear and steady optimism with which he regarded life and its progress in all ages. Sir William Church, who introduced the specific proposal that the memorial should take the form of an Osler Institute of General Pathology and Preventive Medicine, stated that such a memorial as that suggested would be a singularly appropriate tribute to the outlook and ideals that Osler had kept before him in his life-work. Prof. Thomson emphasised the need of new laboratory accommodation in Oxford for teaching and research. The Dean of Christ Church and Sir Archibald Garrod also spoke. It was announced that the hon. secretary, Prof. Gunn, had received expressions of sympathy with the proposed memorial from a large number of people representing many interests, and that a collateral committee had been formed in America to aid in raising the memorial.

A MOVEMENT has been started to commemorate the life and work of the late Sir James Mackenzie Davidson by an appropriate memorial. The proposal is that steps should be taken to found a Mackenzie Davidson chair of radiology at some university, but, whereas nothing could be more fitting as a memorial to the work of one who devoted a large part of his

life to the development of the subject of radiology, it is urged by the thirty signatories of the appeal that, if the wider claims of the subject are to be met, there should be an X-ray institute. The applications of X-rays in medicine have vastly extended both in diagnosis and in treatment during the last ten years, but the new knowledge as to the properties of X-rays revealed by crystal analysis has opened out many new fields both of investigation and of application. If the subject is widening in these respects, there are signs no less clear of a growing need for improved teaching in the many fields of X-ray activity. The institution of a diploma in radiology by the University of Cambridge is but one indication of the demand that exists at the present day for instruction in the subject of X-rays. A well-equipped and well-organised institute seems the most likely way in which the multifarious interests of X-rays can best be welded into an efficient working whole, and it is hoped that the response to the appeal will ensure that the brilliant X-ray work done in this country may be augmented.

THE first post-war meeting of the International Council for the Exploration of the Sea was held in London last week, March 2-6. The countries represented were Belgium, Britain, Denmark, Finland, France, Holland, Norway, and Sweden. France sent a delegate for the first time, and the United States of America was informally represented. The British Government entertained the delegates and others at a dinner at Lancaster House, the Royal Society held a reception at Burlington House, and the Trustees of the British Museum and the Royal Geographical Society also received the delegates. The meeting resolved itself into a number of sections for the consideration of particular questions; these were the formulation of a scheme of research to enable the various Governments to make a convention for the better regulation of the North Sea fishing-grounds; the future conduct of the hydrographic and plankton researches; biological, statistical, and historical investigations with respect to the herring; the European eel fisheries; the fisheries of the seas to the south-west of the British Isles; a limnological survey; international fishery statistics; and certain basal physical and biochemical matters. Much interest was exhibited with regard to the "plaice problem," and the section concerned held several meetings. The hydrographic sectional meetings were very interesting, but it was clear that no immediate results were to be expected. The *personnel* of the Council had not undergone much change. In the death of Sir John Murray the organisation has suffered a great loss, but the genial and forceful personality of Dr. Johan Hjort is still an asset of much value. Prof. Otto Pettersson vacated the chair to Mr. H. G. Maurice, of the English Ministry of Agriculture and Fisheries, to whom the continued existence of the international investigations throughout the period of war is largely due.

ACCORDING to the *British Medical Journal*, Sir Frederick Banbury's Bill to Prohibit the Vivisection of Dogs is down for second reading on March 19. It

will be remembered that when the same Bill was introduced last year a Government amendment allowing experiments to be made on dogs under special certificates was carried. The title was also changed. Sir Frederick Banbury himself moved the third reading with these amendments. The Bill was, however, rejected. It is now brought forward again in the form in which it existed before the Government amendments—that is, prohibiting all experiments on dogs. Although there seems some hope that the prospects of its progress in Parliament are not very favourable, its unexpected temporary success last year must not be forgotten, and careful watch is imperatively necessary. It is inconceivable that the Government can allow a Bill of this kind to pass, nullifying, as it does, the activities of so many of their Departments. Sir Frederick Banbury admitted that he had "failed to mention" the safeguards against possible cruelty already existing in the Statute Book. The opinion of the medical profession is sufficiently shown by the unanimous vote of the clinical and scientific meeting of the British Medical Association in London last April. It was agreed that such prohibition of experiments on dogs would have a deplorable effect in hampering the progress of physiological and pathological investigation, since many important fields of research are only available when dogs can be used. They are the only large animals that can be kept in health and comfort under laboratory conditions.

THE admission of qualified medical women to the fellowship of the Royal College of Surgeons of Edinburgh reminds us of the fight waged in the late sixties and early seventies of last century for the admission of women to the classes and examinations of the faculty of medicine of the University of Edinburgh. The fight was lost by the gallant band of women—*septem contra Edinem*. It has been fought and won in the fifty intervening years, and this resolution of the Royal College marks the fall of the last barrier to equality of the sexes in medical education in this ancient seat of learning. Women medical students have recently been admitted to the complete courses in the faculty of medicine, and the extra-mural Edinburgh School of Medicine for Women has been merged into the University. It remains to be seen whether the new *régime* will justify those who have borne much anxiety and labour to promote it. We believe it will. The Scottish women proved their quality in the hospitals they equipped and staffed in the various seats of war. They have started a small hospital in Edinburgh staffed by women only. There is an increasing body of medical women and women students attached to the University, and among them will be found doubtless the same capacity for work and leadership which was so nobly exemplified by the late Dr. Elsie Inglis. With all the examinations open to women which lead to hospital staff appointments, it is hoped that an increasing number of highly qualified women will present themselves as candidates when vacancies occur, and that appointments will be open to merit irrespective of sex. Much of the work to be done in the future in the State-aided hospital is obviously of a character to

demand the services and judgment of qualified medical women.

THE twenty-sixth James Forrest lecture will be delivered at the Institution of Civil Engineers on Tuesday, April 20, at 5.30 p.m., by Sir Dugald Clerk, K.B.E., F.R.S., upon the subject of "Fuel Conservation in the United Kingdom."

PROF. A. FOWLER, professor of astrophysics, Imperial College of Science and Technology, South Kensington, and president of the Royal Astronomical Society, has been elected a corresponding member of the Paris Academy of Sciences, in the section of astronomy, in succession to the late Prof. E. Weiss, of Vienna.

PROF. J. STANLEY GARDINER has, at the request of the Deputy-Minister of Fisheries, undertaken temporarily the direction of the scientific work of the Fisheries Department of the Ministry of Agriculture and Fisheries. Prof. Gardiner's particular duty will be to restart fishery investigations, which have necessarily been in abeyance during the war.

THE Faraday Society has arranged a general discussion on "Basic Slags: Their Production and Utilisation in Agricultural and other Industries," to be held on Tuesday, March 23, from 7.30 to 10.30, in the rooms of the Chemical Society, Burlington House, London, W.1. Prof. F. G. Donnan, vice-president, will preside over the discussion, and there will be papers by Dr. E. J. Russell, Prof. C. H. Desch, Sir T. H. Middleton, Sir Daniel Hall, Prof. D. A. Gilchrist, and others.

THE U.S. National Research Council has received a gift from the Southern Pine Association of 10,000 dollars to meet the incidental expenses of a co-ordinated scientific study by a number of investigators of the regrowth of trees on cut-over forestlands, with the view of determining the best forestry methods for obtaining the highest productivity. The investigation will be conducted under the advice of the Research Council's special committee on forestry, and will not duplicate any present Government or other undertakings along similar lines.

It was announced at the ordinary scientific meeting of the Chemical Society on March 4 that the following had been proposed for election as honorary and foreign members, and that a ballot for their election would be held on March 18: W. D. Bancroft, V. Grignard, H. Kamerlingh Onnes, E. Paterno, P. Sabatier, J. B. Senderens, S. P. L. Sørensen, and G. Urbain. The annual general meeting of the society will be held at Burlington House on Thursday, March 25, at 5 p.m., to receive the address of the president, Sir James J. Dobbie, and to elect the officers and council for the ensuing year.

THE following officers and council of the Geological Society have been elected for the ensuing year:—*President*: R. D. Oldham. *Vice-Presidents*: Prof. E. J. Garwood, G. W. Lamplugh, Col. H. G. Lyons, and Prof. J. E. Marr. *Secretaries*: Dr. H. H. Thomas and Dr. H. Lapworth. *Foreign Secretary*: Sir Archibald Geikie. *Treasurer*: Dr. J. V. Elsdon. *Other*

*Members of Council*: Dr. F. A. Bather, Prof. W. S. Boulton, R. G. Carruthers, Dr. A. M. Davies, J. F. N. Green, R. S. Herries, J. Allen Howe, Prof. O. T. Jones, Prof. P. F. Kendall, W. B. R. King, Dr. G. T. Prior, W. C. Smith, Prof. H. H. Swinerton, and Prof. W. W. Watts.

THE first of the Chadwick public lectures on military hygiene was delivered by Gen. Sir John Goodwin, Director, Army Medical Service, on March 8 at the Royal Society of Arts, the subject being "Army Hygiene Prior to the Recent War." The lecturer dealt with the history of hygiene from the earliest times up to the period immediately preceding the war. The ravages wrought by disease during the various campaigns of the eighteenth and nineteenth centuries and their effects upon the armies in the field were detailed, and emphasis was laid on the lessons gained during the South African War in the prevention of disease. The various measures that have been elaborated to improve the health of the Army were outlined, and stress was laid on the good results accruing from education in hygiene of the Army as a whole. In India, during the years 1878-82, the number constantly sick among the European troops was 68.1 per 1000, with a mortality of 20.5; in 1912 the corresponding figures were 28.8 and 4.6 respectively. Immediately preceding the lecture Chadwick gold medals and prizes were presented to Surg.-Comdr. Edward L. Atkinson, R.N., and Brig.-Gen. W. W. O. Beveridge, A.M.S., for services in promoting the health of the men of the Navy and Army.

WE are authorised to announce that H.R.H. the Prince of Wales has been graciously pleased to become the patron of the new British School of Archaeology in Jerusalem, referred to in NATURE of December 18 last (p. 398). The school has been formed for the study of the wide and important field of archaeological research which has now been opened up in Palestine and the surrounding districts. The director, Prof. J. Garstang, of the University of Liverpool, is shortly proceeding to Palestine to complete the organisation of the school. As soon as the political destiny of Palestine has been fixed and a mandate formally assigned, it is hoped that a department of antiquities will be formed, under which the school looks forward to collaborating with the Palestine Exploration Fund in the excavation of an important site which has already been provisionally selected. Anyone who is interested in the school is invited to communicate with the secretary at 2 Hinde Street, Manchester Square, W.1.

THE Natural History Museum Staff Association opened its series of scientific reunions for the current year by holding a double reunion on March 2 and 3. At the first most of the members of the International Council for the Exploration of the Sea were present, and the exhibits arranged in the board-room included many specimens—some being classical type-specimens—collected during the voyage of the *Challenger*. At the second reunion other exhibits were added, so that the whole series was of wide interest, and there was an attendance of nearly fifty visitors, amongst whom may



be mentioned Lord Rothschild, Sir Ronald Ross, Prof. E. B. Poulton, Lt.-Col. Winn Sampson, Mr. F. E. Beddard, Prof. J. Stephenson, Dr. H. O. Forbes, Mr. R. F. Scharff, Prof. J. P. Hill, Dr. S. Kemp, Dr. B. Daydon Jackson, Prof. J. Graham Kerr, Mr. S. Monckton Copeman, Mr. G. T. Bethune Baker, Dr. E. J. Allen, Dr. H. H. Thomas, Dr. C. Christy, and Prof. J. E. Duerden.

THE half-yearly council meeting of the National Union of Scientific Workers, presided over by Mr. G. S. Baker, of the National Physical Laboratory, was held at University College on March 6. The rapid growth of the union has necessitated the appointment of a full-time secretary, and Major A. G. Church has been appointed to fill that office. The research committee in its report outlined the function of this body and that of the research council, which it is hoped will shortly be constituted. It will consider how best industry and public administration should be kept in close touch with the development of scientific knowledge, and ensure that the views and conditions of employment of scientific workers shall receive consideration from all bodies bringing forward schemes for research in science or for the administration of research. It was felt that the State should not subsidise industrial research associations unless such bodies display an anxiety to ensure that the direction of research shall be in the hands of those who have shown capacity for leadership in scientific work. A report on patent rights presented by Mr. A. A. Griffith emphasised the opinion "that the only satisfactory way of remunerating salaried inventors is to pay them adequate salaries; a salaried inventor receiving an adequate salary should have no claim whatever to any extra payment because his work proves unexpectedly remunerative." On the motion of Miss A. B. Dale, the council unanimously agreed to "protest strongly against the differential treatment of men and women as regards the method of recruitment to the Civil Service and the salary scales offered therein as recommended by the Reorganisation Sub-Committee of the Civil Service National Whitley Council."

FEBRUARY was unusually warm over the southern portion of the British Isles, and at Greenwich Observatory the mean temperature for the month was 43.9°, which is 4° above the normal; the mean, however, was higher in 1914, when it was 44.9°, and the means of both maxima and minima readings were also higher. There were four days with a shade temperature of 60° or above, whilst there is no previous February at Greenwich with more than two such warm days since 1841, and in all only seven days as warm during a period of seventy-nine years. Frost in the shade only occurred on four nights during the month, and the lowest temperature was 27°. The duration of bright sunshine was eighty-seven hours, which is thirty hours more than the normal, and there were three days at Greenwich with eight hours and more of sunshine. Rainfall was much below the normal, and in London there was no day during the month with a fall of 0.1 in.; the total measurement was 0.39 in., which is the driest February since 1895

and 1896. Rain was measured only on eight days. The whole winter, December, January, and February, has been unusually mild over England, and at Greenwich the mean temperature for the three months was 42.8°, which is 3.5° warmer than the average for sixty years. The winter of 1915-16 was slightly warmer, and the winter of 1898-99 was warmer by about 1°. The warmest winter during the last eighty years, 1868-69, was warmer than the winter just ended by nearly 2°.

In view of the prevalence of disease amongst honey-bees during recent years, it has become a matter of practical importance to be able to distinguish with certainty between individuals which have died from disease and those the death of which is merely the result of old age or exhaustion. Mrs. Pixell-Goodrich contributes an interesting paper on this subject to the *Quarterly Journal of Microscopical Science* (vol. lxiv., part 2). It appears that during the summer, when actively engaged in collecting honey and pollen, the worker-bees very soon wear themselves out and die a natural death at the age of about six weeks. Senescence—or perhaps one should rather say exhaustion from over-exertion—is accompanied by well-marked and easily recognisable changes in the nerve-cells of the "brain." The cytoplasm of these cells undergoes gradual reduction in quantity, until only a vestige remains around the nucleus. The examination of the nerve-cells appears to be the most trustworthy method yet proposed for determining the age of bees, but, unfortunately, it involves a considerable amount of labour in the case of each individual examined.

THE Bulletin of the Bureau of Standards for July 12, 1919, contains the results of the measurements of the index of refraction of air for wavelengths 2000 to 10,000 tenth metres at different temperatures and pressures made by Messrs. W. F. Meggers and C. G. Peters to meet the demands of modern accurate spectroscopy. The Fabry and Perot interferometer was used in the measurements, the plates being of glass or quartz 4.2 cm. in diameter and 0.6 to 0.8 cm. thick. They were rendered partially reflecting by films spluttered from a metallic cathode *in vacuo*. Iron or copper arcs and neon or argon tubes served as sources of light. The interference rings were photographed and the diameters of the first three measured. Between the limits of pressure used—73 to 76 cm.—the refractive index was found proportional to the pressure. The variation of the index with temperature between 0° C. and 30° C. is not sufficiently well represented by the usual  $\mu - 1$  proportional to density law. The index of refraction at normal temperature and pressure is given by the equation  $\mu^2 - 1 = \frac{0.0005738\lambda^2}{\lambda^2 - 595.60}$ , which shows no sign of an appreciable absorption band in the infra-red part of the spectrum.

THE annual report of the Institution of Mechanical Engineers gives particulars of the various researches which are being carried on under the direction of the institution. The following grants were made by

the council for the year:—Alloys, 220l.; steam-nozzles, 150l.; hardness tests, 150l.; and cutting tools, 100l. The alloys research has been carried on at the National Physical Laboratory, and the eleventh report will be presented at an early date. The construction of the experimental apparatus for the steam-nozzles research has been further delayed for lack of funds, but help has been promised by a grant of 500l. from the Turbine Blade Research Committee of the British Electrical and Allied Manufacturers' Association. It is intended to erect the apparatus at the Dickinson Street Power Station, Manchester, and the experiments will be conducted under the supervision of Prof. G. Gerald Stoney and Mr. S. L. Pearce. Hardness tests have been carried out at the National Physical Laboratory by Dr. T. E. Stanton, and it is hoped that reports will be presented this year. A bibliography on cutting tools is being prepared by Mr. G. W. Burley, and it is proposed to collect information from makers and users of cutting tools. The work of the wire-ropes research committee has been considerably delayed owing to the war; arrangements have now been made for experimental work to be carried out at Woolwich Polytechnic by Dr. W. A. Scoble. The work of the refrigeration research committee has been suspended since 1914; it is hoped that investigations may be made shortly into the physical properties of the substances used in refrigeration.

A CATALOGUE (No. 357) of rare books and manuscripts has just been issued by Messrs. *Bernard Quaritch, Ltd.*, 11 Grafton Street, W.1, and is worthy of perusal. It is of a fairly general character as to the subjects, but two sections will appeal especially to readers of NATURE, viz. those dealing with natural and physical sciences (21 pp.) and with periodicals (13 pp.). Many scarce volumes and long runs are to be found in these. The price of the catalogue is 1s. We notice that Messrs. Quaritch are about to begin the publication of the *Journal of Pomology*. It will appear at quarterly intervals under the editorship of Mr. E. A. Bunyard, who has secured the promise of assistance from many experts.

An illustrated book on "Weeds of Farm Land," the work of Dr. Winifred E. Brechley, of the Rothamsted Experimental Station, is to be published by Messrs. *Longmans and Co.* It will deal with various aspects of the weed problem, but especially with the relations existing between weeds and the soils and crops with which they are chiefly associated. A survey will be given in the volume of the present position with regard to the questions of prevention, eradication, and uses of weeds, also of their habits and method of distribution and the vitality of buried weed-seeds.

READERS OF NATURE who are interested in ancient herbs and old-time gardening and agriculture should see Catalogue No. 81 of Messrs. *Dulau and Co., Ltd.*, 34 Margaret Street, W.1, in which are to be found particulars of 1000 works dealing with these and other scientific subjects, many the property of the late Sir Frank Crisp. An unusual feature is a collection of volumes on sundials.

## Our Astronomical Column.

**BRIGHT METEORS.**—A fine meteor was observed on February 17 at 8h. 52m. by Mr. F. Wilson, Totteridge, and Mr. S. B. Matthey, Plumstead. It was brighter than Jupiter, and moved very slowly from a radiant at  $72^{\circ}+43^{\circ}$  near  $\alpha$  Aurigæ. The approximate height of the object was 67 to 30 miles, path 53 miles, and velocity 10 miles per second. It passed from over south-west of Needham Market to Woodbridge.

Another very brilliant meteor was observed on February 27 at 8h. 58m. by Mrs. Wilson and Miss Cook, and also by Mr. S. B. Matthey at Plumstead. The radiant was at about  $17^{\circ}+8^{\circ}$  near the horizon  $9^{\circ}$  north of west. The height of the object was 53 to 49 miles, path 95 miles, and velocity 12 miles per second. It passed from over Lydd, Kent, to about 50 miles east of Calais, France. Fireballs from Auriga and Pisces have been recorded in previous years at about the same dates as those of this year.

**TOTAL LIGHT OF THE STARS.**—The late Prof. Newcomb laid stress on the desirability of obtaining this observational constant, and several attempts have been made to do so. The latest is by Mr. P. J. Van Rhijn (Contributions from Mount Wilson Observatory, No. 173). This paper shows that there is illumination, which is probably due to (a) a faint extension of the zodiacal light, including the Gegenschein, and (b) faint auroræ. The amount of these was found by observing regions of the sky remote from the Galaxy and assuming that the starlight in these regions could be inferred from the observed number of stars of each order of magnitude. The amount of each of these is discussed, and it is concluded that the total amount of light received from all the stars in both hemispheres is equal to 1440 stars of magnitude 1.00, Harvard visual scale. The following are the values of extra-galactic sky brightness per square degree found by different observers, the unit being a star of magnitude 1.00:—Newcomb, 0.029; Burns, 0.050; Abbot, 0.075; Yntema, 0.140; and Van Rhijn, 0.130. The magnitude of the full moon is about  $-12$ ; it is, therefore, about 140,000 times as bright as a star of magnitude 1.00, or a hundred times as bright as all the stars together.

**STAR CLUSTERS.**—*Scientia* for March contains the fourth of a series of papers on clusters by Dr. Harlow Shapley. Dr. Shapley quotes a remark that distance introduces simplification in our study of the clusters; it makes apparent magnitudes equivalent to absolute ones, since all the components are at practically the same distance from us. He then proceeds to consider the local cluster to which the sun belongs, which he regards as defined by Dr. Charlier's research on the distribution of the B stars in space. The conclusion was that they form a flattened cluster, with greatest diameter 4000 light-years. This is supposed to be merely one unit out of many that go to make up the galaxy. Its equatorial region is marked by a zone of bright stars, to which attention was directed by Sir J. Herschel and Dr. B. A. Gould. Its plane is inclined some  $15^{\circ}$  to the medial line of the galaxy. Dr. Charlier puts the centre of the local cluster in Carina, some 250 light-years from the sun; while Dr. Shapley makes the distance only 150 light-years.

Since from analogy the cluster is likely to be moving with respect to its neighbours, the two star-drifts would appertain respectively to cluster and non-cluster stars. It is left an open question to which category the sun belongs. Viewed telescopically from the Hercules cluster, the local cluster would seem to be mainly composed of B stars, with a smaller number of giant M ones. The sun would be of the twentieth magnitude, too faint for visual observation, though it might be photographed.

### Meteorological Observations at Calcutta.<sup>1</sup>

THESE is a perpetual struggle between the advocates of continuity and of uniformity in such matters as meteorological observations. For a network of official stations under a central authority, the results of which have to be co-ordinated, uniformity is of very great importance. On the other hand, experiments with different methods are much less likely to be discouraged in an independent observatory, the work of which has a value of a totally different kind. In such a place continuity has a special significance, and it is refreshing to meet with a volume of data from a station that has been on the same site for fifty years, even though that site was criticised very soon after the beginning of the period.

The official observatory at Alipore is only two miles from St. Xavier's College, so that the latter is not required as a vital station for the Indian Meteorological Service, and the Jesuit Fathers, who have maintained their observatory for half a century, have received no special blame for departures from established practice, or any financial support. The Rev. E. Francotte, S. J., has been director for thirty-two years out of the fifty, and is responsible for the present volume of some 350 pages of very clear print with large figures not at all crowded. His full plan consists of four parts, of which the volume before us is the first. It contains for each day in the fifty years, 1868-1917, maximum, minimum, and mean shade temperature, with maximum solar radiation and minimum terrestrial radiation, barometric pressure, wind direction and velocity, relative humidity and rainfall; the monthly extremes in heavy type, with notes on absolute extremes where encountered. This is intended to show the mutual relations of climatic elements, and to further this object, in addition to the tables, some graphs are added. The original scheme was to publish at the end of forty-six years, and part of the volume is summarised for that period. The war, which held back publication, enabled four more years to be included in an appendix.

We have not space to consider in any detail the mass of data contained in the volume, but a few points of interest may be mentioned. In forty-six years the average number of days with at least 1 in. of rain was nineteen per annum. Daily falls of at least 10 in. occurred five times in the period, including one total fall of 14 in. The shade temperature reached 100° F. on 527 days in forty-eight years: 59 in March, 282 in April, 136 in May, 48 in June, and only 2 in July, both in 1897. Father Francotte examines some of the tables for periodicity, but is reserving a great deal more analysis for the second volume, the publication of which will be awaited with interest by those who have seen the first. W. W. B.

### The Road to Industrial Peace.<sup>2</sup>

FROM time to time the Advisory Council of Science and Industry in the Australian Commonwealth issues bulletins dealing with various industrial problems, and the latest of its publications is entitled "Welfare Work," though it is wider in scope than the title is usually taken to imply. The preface tells us that the bulletin is prepared for the benefit of all who are seeking for some road to industrial peace and the establishment of more satisfactory and har-

<sup>1</sup> "Meteorological Observations at St. Xavier's College, Calcutta. (With a Short. Course Discussion on the Same)." Part 1., Forty-six Years, 1868-1913. With Appendix, 1914-17. By E. Francotte. Pp. xiv+350. (Calcutta: St. Xavier's College, 1918) Price, unbound, Rs. 3 per copy.

<sup>2</sup> "Welfare Work." Bulletin No. 15 of the Advisory Council of Science and Industry. (Melbourne, 1919) Pp. 110. Price 6d.

monious relations between capital and labour. It points out that these relations are far wider than questions of wages and hours of labour. A comprehensive industrial policy considers the responsibilities which fall on the shoulders of employers, the effect of industrial conditions on the employee, his well-being outside working hours, the distribution of the wealth produced, and the participation of the employees in the management and control of industrial operations. The bulletin sets out what has been done on these lines in Great Britain, the United States, and other countries, and in order to encourage its circulation it is issued at a very low price. It is to be hoped that it will receive the wide publicity it deserves, not only in Australia, but in this country as well. It is, in fact, of more direct interest to us than to its country of issue, in that all reference to welfare work in Australia is reserved for publication in a later bulletin.

The bulletin is admirably written, and affords a most valuable and impartial summary, especially of the large body of information which has been acquired during the war through the activity of the Health of Munition Workers Committee and other bodies. It describes the motives, scope, and administration of welfare work, and the social life, recreation, education, and housing of the workers. It discusses wage-payments, profit-sharing and co-partnership, provision for old age and sickness, and it goes somewhat fully into what is being more and more recognised as the most important factor of all in the attainment of industrial peace, viz. co-operation between employers and employed in control. The health and safety of the worker and the provision of a healthy industrial environment are debated at some length, whilst there is an excellent summary of problems of industrial fatigue in relation to hours of labour, overtime, and rest pauses. An extensive bibliography is included. H. M. V.

### Wireless Telephony in Aeroplanes.

IN a paper read before the Wireless Section of the Institution of Electrical Engineers on February 18 Major C. E. Prince lifted the veil from the important results in wireless telephony from aeroplanes which were achieved in consequence of the stimulus of the necessities of war. Up to the summer of 1915, the author believes, wireless speech had not been received in an aeroplane, and, indeed, great were the difficulties that had to be surmounted before practical apparatus for working between ground and aeroplane or between aeroplane and aeroplane could be produced. In the earlier experiments, transmission from air to ground only was attempted by a small oscillation-valve set, but an aeroplane-carried receiving set, also of the oscillation-valve type, was successfully used in 1916. This, however, did not meet the immediate military requirements overseas, and attention was more particularly devoted to the urgent, but more difficult, problem of telephonic communication between machines in the air.

Major Prince gave a good idea of the difficulties encountered and the ingenuity with which he and his colleagues surmounted them. The crux of the problem is the method of controlling the radiation. Direct control was found to suffer from grave disadvantages. Placing a microphone in the grid circuit of the oscillation valve was tried with some success, but finally a method known as "choke" control, in which the modulation is applied to the anode circuit of a second or control valve, was employed. The grid of the control valve is acted on by the microphone transformer, the anode of which is in series with a one-to-one transformer, or choke coil, in the

anode circuit of the main valve. When variations take place in the control anode at speech frequency, very large surges are set up in that of the power valve, which may approximate to the original high-tension direct-current potential, and so sweep the output from nearly double its steady value to zero. The standard R.A.F. set is of the 20-watt size, with a high-tension supply of 600 volts direct current. A great advantage in the system for aeroplane work is that no critical adjustments are required. The arrangement of the apparatus is such that the set proper can be mounted in any convenient position, and only a very small control unit brought within reach of the user's hand. One switch makes or breaks the dynamo field, filament, and microphone circuits. A great deal of experiment was necessary before a suitable microphone was found, as it had to be almost insensible to sounds of "noise" intensity, but responsive to the powerful concentrated waves of a voice impinging upon it at a very short distance.

The receiving set depended upon high-frequency magnification, and was, in its first form, a three-valve arrangement. It consisted essentially of a detector valve with reaction and two note magnifications. The detector valve was not energised direct from the aerial, but through an aperiodic circuit, which was a circuit approximately syntonised by its self-capacity. The final adjustment for obtaining the best effect is made on a rheostat in the filament circuit carried on the "joystick" itself. These three-valve sets were employed to a considerable extent both before and after the armistice, but a five-valve receiver was developed later in which a choice was made of two high-frequency magnifications and two low, with a detector valve. This set was very much more sensitive than the three-valve arrangement, and enabled fixed aerials rigidly connected to the wings and fuselage to replace the trailing aerial, which latter was a great embarrassment in fighting. The normal safe range of the apparatus is about four miles from machine to machine, while the range to a ground station is from twenty to fifty miles or more. The author anticipates that in the future the wireless apparatus will be able to be plugged through on to the ordinary exchange lines, so that a man sitting in his office will be able to hold a conversation with a machine in the air.

### Magnetic Storm of March 4-5.

THE Director of the Meteorological Office has been good enough to send us the subjoined communication from Dr. Chree concerning a magnetic storm which occurred on March 4 and 5. It may be mentioned that on these days the sky was mostly overcast in Scotland, though there was very fine weather in the South of England. We are informed that the only aurora observation reported so far was made at Aberdeen at 1h. 30m. on March 4, i.e. ten hours before the "sudden commencement" of the storm:—

"A considerable magnetic disturbance was recorded at Kew Observatory on the night of March 4-5.

"There was a well-marked S.C. (sudden commencement) at about 11h. 40m. on March 4. This was of an oscillatory character both in D (declination) and H (horizontal force). The first, smaller, movement was a fall in H and an easterly swing in D, the range of the oscillation being about 45γ in H and 7' in D. H retained an enhanced value for four or five hours after the S.C., and no really large movements occurred until after 17h. on March 4. The most disturbed time was from 18h. on March 4 to 9h. on March 5. On the whole, H was falling from

17h. on March 4 until after 2h. on March 5, the maximum being recorded at about 16h. 20m. on March 4, the minimum at about 2h. 5m. on March 5, and the range being approximately 300γ. The H curve had become quiet before 10h. on March 5, but still showed a depression of about 75γ.

"The D trace was off the sheet, in the direction answering to easterly displacement, for fully twenty minutes between 22h. and 23h. on March 4; so the range recorded, 60', may have been considerably exceeded. The maximum westerly displacement occurred at about 18h. 35m. on March 4.

"From 12½h. to 17½h. on March 4 the D trace was practically normal except that the declination was 1' or 2' more westerly than usual. Thus the disturbance was rather a conspicuous example of the lull that not infrequently intervenes between the S.C. and movements that would be recognised as constituting a magnetic storm."

### University and Educational Intelligence.

CAMBRIDGE.—Mr. E. V. Appleton, of St. John's College, has been appointed an assistant demonstrator in experimental physics.

It is proposed to confer the honorary degree of D.Litt. on the Abbé Henri Breuil, professor of the Institute of Human Palæontology at Paris.

It is proposed to create a readership in the morphology of vertebrates and a lectureship in zoology in place of the present readership in zoology.

Besides additions and improvements to the chemical laboratory and the erection of the Molteno Institute for Parasitology, other building schemes are in view for engineering, physics, and also for the University library. The last proposal to meet the difficulty of finding room for books was to excavate a large underground chamber. The cost of this has been found to be prohibitive, and the Senate has recently discussed a revival of an old scheme to erect a new building akin to the Senate House and on the south side of Senate House Yard. If this scheme is adopted a public appeal will be made for subscriptions towards the erection of the building.

LEEDS.—Mr. W. E. H. Berwick has been appointed lecturer in mathematics in the University. Mr. Berwick was assistant lecturer in the University of Bristol for two years, and afterwards became lecturer in mathematics in University College, Bangor. For two years he was engaged on the technical staff of the Anti-Aircraft Experimental Section of the Munitions Inventions Department at Portsmouth, where he made important contributions to the experimental and computational theory of gunnery. He has published a long series of papers in the Proceedings of the London Mathematical Society and elsewhere.

OXFORD.—Prof. R. A. Sampson, Astronomer Royal for Scotland, has been appointed Halley lecturer for 1920.

THE governors and trustees of Tancred's studentships propose to elect a student in physic at Gonville and Caius College, Cambridge, at Whitsuntide. The annual value of the studentship is about 95l. Particulars are obtainable from Mr. E. T. Gurdon, 28 Lincoln's Inn Fields, W.C.2.

THE sixth annual report of the Carnegie United Kingdom Trust is an account of the work done by the Trust in 1919, and contains a statement of income and expenditure for the year. The committee had hoped that the coming of peace would have brought with it a great opportunity for institutions which

exist for philanthropic purposes. But the first year of peace has been a disappointment. Building operations, which form a very large part of the activities assisted by the Trust, are kept back because building is now so costly. The outstanding obligations already undertaken by the Trust are sufficient to absorb the greater part of the available income during the next five years. It is evident that further sums will be required to supplement grants already made for building libraries. The committee is, therefore, disinclined to consider new requests for grants in aid of library building. The committee considers that the assistance given to rural library schemes is among the most important and satisfactory of the Trust's activities. Under these schemes a box containing fifty books is sent to a small town or village and there used as a lending library until, the books having been read, it is time to exchange them for a fresh supply. Reports from those in charge of rural centres show that the scheme really provides a means for spreading education in thinly populated districts. The Carnegie Trust has made a grant towards the maintenance of the School of Librarianship recently established at University College, London. The highly trained students who pass through this school should do much to make our libraries more useful. The committee of the Carnegie Trust also reports on the part it has taken in physical welfare schemes and in the promotion of music.

An appeal has just been issued by the University of London through its Military Education Committee inviting subscriptions to the war memorial which it is proposed to raise to the former officers and cadets of the University of London Officers Training Corps who have fallen in the war. The services rendered by the Officers Training Corps during the war are too little known or appreciated. When war broke out the cadets came forward practically as one man, and to their heroism and the unremitting labours (often in the teeth of great discouragement and difficulties) of their pre-war instructors we owe the fact that what might have proved a most dangerous gap in the supply of officers during the earlier part of the war was successfully bridged. The record of the University of London contingent appears to be second to none. The number of past and present officers and cadets who served in the war as officers is 4197, of whom we have to deplore the loss of no fewer than 657. The number of distinctions gained is 1650, including five V.C.'s (the only two surviving V.C.'s, Major Cloutman and Major White, both graduates of the University, are honorary secretaries of the appeal). In particular the gratitude of Londoners should go out to Major Sowrey, who brought down a Zeppelin in flames, and later a Gotha aeroplane. The scheme is to include a memorial in London, and, in addition, a permanent hall in connection with the new standing camp of the University of London O.T.C. at Great Kimble, near Princes Risborough, where special memorials to individuals may be put up, of which the first will commemorate Lt.-Col. Arthur Egerton, Coldstream Guards, the first adjutant of the contingent, whom all the original officers and cadets mourn as a personal friend. The appeal committee is a strong one, and includes many honoured names outside the University itself—in particular, those of Marshal Foch and of Field-Marshal Lord French and Sir Henry Wilson. It is to be hoped that every patriotic person who realises the part played by the British universities in the great national struggle and the importance of maintaining this splendid tradition will contribute generously towards the 30,000*l.* asked for. Contributions should be sent to the hon. treasurer at 46 Russell Square, London, W.C.1.

## Societies and Academies.

LONDON.

**Royal Society**, February 26.—Sir J. J. Thomson, president, in the chair.—L. F. Richardson: Some measurements of atmospheric turbulence. The eddy-shearing stress on the ground is deduced from pilot-balloon observations. Values on land in any consistent dynamical units are found to range from 0.0007 to 0.007 times the value of  $m^2/\rho$ , where  $m$  is the mean momentum per volume up to a height of 2 km. and  $\rho$  is the density. Evidence is given to show that the eddy viscosity across the wind at Lindenberg increases with height, and, except near the ground, is much greater than the eddy viscosity along the wind. In parts iv. and v. the spreading of a lamina of smoke is considered. Osborne Reynolds's eddy stresses are studied. For one occasion an attempt was made to measure simultaneously all six components of stress by observing the motion of thistle-down. The three direct stresses are easily measured. Not so the shearing stresses; however, one was found to be 2.4 times its probable error. The theory of the scattering of particles is summarised, and numerical values are derived from scattering. The "turbulivity"  $\xi$  is estimated from the rising cumuli in calm weather and found to be  $10^6$ , applicable only in the sense of friction. Thus the whole range of  $\xi$  observed in the free atmosphere was from seven to a million, in contrast with 0.2 in perfectly still air. The eddy stresses observed have ranged in absolute value from 0.004 to 110 dynes  $cm^{-2}$ .—J. H. Hyde: The viscosities and compressibilities of liquids at high pressure. In the first place, experiments were made to determine the change in the value of the kinematical viscosity ( $\eta/\rho$ ) of the various oils, and after this investigation was completed apparatus was designed for the determination of the change in density with pressure. The apparatus used for the determination of the kinematical viscosity consisted essentially of a system of two horizontal (the upper one of capillary dimensions) and two vertical tubes forming a closed circuit of liquor under pressure, the lower half of the circuit containing mercury and the upper half the liquid under test. One end of the tubular frame rests on a horizontal knife-edge, and the frame is supported in a horizontal position by a spiral spring. On the mercury being displaced by a given amount, flow will take place round the circuit owing to the difference of head, and it is evident that if the spring be so designed that its rate of extension is equal to the rate of change of head of the mercury, flow of the liquid under test will take place through the capillary tube under a constant pressure-difference and at a velocity which can be calculated from the rate of extension of the spring. In this way all the data required for the determination of the absolute kinematical viscosity of the fluid were determined. The determinations of the variation in density under pressure were made by measuring the decrease in volume of known quantity of the liquid enclosed in a steel cylinder sealed at one end and closed at the other by a long steel plunger. The cylinder and plunger were enclosed in a pressure vessel and the motion of the plunger for any particular pressure was measured. The density was calculated from the decrease in the volume thus measured. From the values of the density ( $\rho$ ) and those of the kinematical viscosity ( $\eta/\rho$ ) obtained for the oils, the values of the absolute viscosity ( $\eta$ ) were calculated. The results show that the absolute viscosity of all the oils tested increases considerably with pressure.—A. Russell: The capacity coefficients of spherical conductors. It is proved that the capacity coefficient of a spherical

conductor equals its radius, together with the capacity of the condenser formed by the spherical surface on one side and the images in it of all external objects connected in parallel on the other. This theorem leads at once to relations between the capacity coefficients of a system of two spheres and the capacities of certain spherical condensers which lessens very appreciably the labour involved in computing the values of these coefficients which are required in practical work. The mutual coefficient also is given in terms of the capacity of a spherical condenser, and other relations between the various capacities used by engineers and physicists are proved. Finally, a method of finding the approximate value of the capacity between a sphere and distant large conductors is given.—C. **Cuthbertson** and Maude **Cuthbertson**: The refraction and dispersion of carbon dioxide, carbon monoxide, and methane. The refractivity of the above-named gases has been measured at eight points in the visible spectrum between  $\lambda\lambda 6708-4800$ . The work was undertaken with the object of ascertaining the refractive power of the carbon atom, on the assumption of the validity of the additive law. By deducting the refractivity of the oxygen or hydrogen atoms from that of the carbon compound values are obtained from which the refractivity of carbon can be expressed in the form

$$\mu - 1 = \frac{C}{n_0^2 - n^2}$$

For  $n=0$  the expressions obtained are:

From carbon dioxide	Carbon monoxide	Methane
$\frac{(\mu-1)}{\infty \text{ carbon}} = \frac{2'7705}{16042} = 0'000173$	$\frac{1'9885}{10213} = 0'000195$	$\frac{1'672}{10623} = 0'000157$

There are thus wide differences, not only between the quotients, which give the refractivity, but also between the numerators, which should be proportional to the number of "dispersion electrons," and the denominators, which give the squares of the hypothetical free frequencies. The result affords a further proof that the "additive law" is untrustworthy except as a rough guide.—A. A. **Griffith**: The phenomena of rupture and flow in solids. Difficulties which had been experienced in predicting the fracture of machine parts under certain types of loading suggested the desirability of a fundamental inquiry into the mechanism of rupture. A theoretical criterion of the rupture of an elastic solid, based on the "theorem of minimum energy," is enunciated in the paper. This has been shown experimentally to be true in the case of a glass plate which contains a crack when unstrained. The calculation involves the surface tension of the material. In the experiments the maximum stress in the glass was estimated to be more than ten times the normal tenacity of the material. It is shown that this result is compatible with the general criterion of rupture unless the material is weakened by discontinuities of flaws the dimensions of which are at least of the order ten thousand times the molecular spacing. Evidence is added to show that the strength of other substances, including metals and liquids, is governed by similar considerations, and that an enormous increase in the tenacity of materials would be possible if the flaws could be eliminated. Experiments are described showing how the elimination may be performed in the case of glass and fused silica, it having been found possible to prepare samples of these materials with nearly fifty times their normal tenacity. The strong phase of these materials is, however, unstable, and changes spontaneously in a few hours to the normal modification. It is shown that many of the phenomena associated with the mechanical properties of materials, including those described in the present paper, are

capable of explanation in general terms if it be supposed that intermolecular attraction is a function of the relative orientation of the attracting molecules. Some consequences of this theory are discussed in the paper. The paper concludes with a short discussion of the bearing of the work on engineering practice.

**Geological Society**, February 20.—Mr. G. W. **Lampugh**, president, in the chair.—Annual general meeting.—G. W. **Lampugh**: Presidential address: Some features of the Pleistocene glaciation of England. The address dealt principally with the changes brought about by the ice in the surface-features of our country. More than five thousand square miles of English land, or about one-tenth of the whole country, would vanish if the drifts were removed, as the "solid" rocks lie below sea-level in tracts of this extent. A further area of about ten thousand square miles is overpread by drift of sufficient thickness wholly to mask the "solid" land-forms, so that rather more than one-quarter of the country owes its present shape to Glacial and post-Glacial deposits. Another twenty thousand square miles was glaciated, and more or less modified, but without losing the dominating features of its rocky framework. The remainder of the country was affected only by the intensification of the atmospheric agencies, whereby its original features were accentuated. In a general sense, the hill-districts have not been greatly changed, but the lowlands have been in most parts completely altered. The source of the huge mass of material contained in certain of the lowland drift-sheets was considered, and the opinion was expressed that a large portion of this was an addition to the land, brought in by the ice from outside our present coastline. Comment was made on the curious rarity of peat or other land-detritus in Boulder Clay known to have been derived entirely from the land, and this was thought to indicate that the conditions for a long period before the actual glaciation had been unfavourable for the growth of timber or peat-producing vegetation.

February 25.—Mr. R. D. **Oldham**, president, in the chair.—H. C. **Sargent**: The Lower Carboniferous chert-formations of Derbyshire. The chert-formations occurring in the Carboniferous Limestone and associated rocks of Derbyshire may be classified under two heads: (1) Those which owe their silica to gaseous or aqueous emanations from igneous rocks. (2) Those which derived their silica from the land by means of chemical denudation. The author considers that in both cases the silica was precipitated direct, and did not, to any considerable extent, pass through an intermediate stage of secretion by organisms with subsequent solution and redeposition. He adduces evidence to show that simultaneous deposition of silica and calcium carbonate often took place, and it is believed that, in such cases, segregation ensued, and sometimes resulted in the formation of nodules and lenticular masses of chert. It is suggested that the bedded cherts of terrestrial origin resulted from heavier precipitation of silica, comparatively free from calcium carbonate, and spread over the sea-floor by gentle currents. Metasomatic replacement of limestone and calcareous organisms by silica has taken place at their contact with the chert. Impurities in the silica have tended to limit such replacement. Organisms existing in the sea or on the sea-floor would be entangled in the precipitated silica, and their presence in the chert is thus explained. The blackness of some chert is shown to be due to the presence of carbonaceous matter. Ferruginous iron may possibly have operated sometimes in the same way.

PARIS.

**Academy of Sciences**, February 10.—M. Henri Deslandres in the chair.—G. Humbert: The positive quadratic forms of Hermite in an imaginary quadratic body.—M. Hadamard: Certain solutions of a functional differential equation.—G. Bigourdan: Coordinates, instruments, and work of the Observatory of the Collège de France.—A. Râteau: The greatest range and maximum realisable velocities of aeroplanes.—M. Ciamician was elected a foreign associate in succession to the late Sir William Ramsay, and M. L. Bianchi a correspondent for the section of geometry in succession to M. Volterra, elected foreign associate.—G. Cerf: Remarks on a generalisation of Pfaff's problem.—B. de Fontvirolant: Calculation of circular bridges.—D. Pompiou: A condition equivalent to monogeneity and the demonstration of the fundamental theorem of Cauchy.—J. Boccardi: A diurnal variation of latitude.—A. Guillet and M. Aubert: An absolute bispherical electrometer. The numerical calculation of its characteristics.—S. Procopiu: Diffraction grating spectra in the case where the incident light is oblique with respect to the principal plane of the lines.—A. Pérad: A method for the comparison and measurement in absolute value of standards with plane ends by an interference method.—Ch. Boulin and L. J. Simon: The action of water on dimethylsulphate.—F. Canac: The determination of the parameters of a crystal by the X-rays.—M. Zell: The ascending movements of the earth's crust and the evolution of fossil remains.—G. Denizot: The existence of two penplains in the Paris basin.—P. Guerin and Ch. Lormand: The action of chlorine and various vapours upon plants. After one or two hours' exposure to an atmosphere containing 1/2000 of chlorine, bromoacetone, and other poison gases, most plants resist; they lose their leaves, but new ones appear, and the plants finish their normal growth.—H. Coupin: The production of chlorophyll by plants exposed to a discontinuous light.—J. Amar: The index of respiratory endurance. This is defined as the ratio of the volume of air entering the lungs at each inspiration to the body-weight.—H. V. Vallois: Evolution of the muscle system of the episode in vertebrates.—L. Mercier: Variation of *Corophium volutator* according to its place of origin.—E. Chatton: The existence in Radiolaria of parasitic Periclinians considered as forms of reproduction of their hosts.

### Books Received.

The Story of Milk. By J. D. Frederiksen. Pp. xx+188. (New York: The Macmillan Co.; London: Macmillan and Co., Ltd.) 9s. net.

The Handbook of Cyprus. Eighth issue. Edited by H. C. Luke and D. J. Jardine. Pp. xii+300. (London: Macmillan and Co., Ltd.) 12s. net.

A First-Year Physics for Junior Technical Schools. By G. W. Farmer. Pp. x+183. (London: Longmans and Co.) 4s. 6d.

Practical Hardy Fruit Culture. By R. Staward. Pp. 216. (London: The Swarthmore Press, Ltd.) 6s. net.

A First Book of School Celebrations. By Dr. F. H. Haywood. Pp. 167. (London: P. S. King and Son, Ltd.) 5s.

The Chemical Age. June-December, 1919. Pp. xi+750. (London: Benn Bros., Ltd.) 15s.

Mauka Polska Jej Pstrzeby, Organizacja i Rozwój. Tom I. Pp. xvi+558. (Warszawa.) Cena M.P. 15.

The Elementary Differential Geometry of Plane Curves. By R. H. Fowler. Pp. vii+105. (Cambridge: At the University Press.) 6s. net.

The Foundations of Einstein's Theory of Gravitation. By E. Freundlich. Authorised English translation by H. L. Brose. Preface by A. Einstein. Introduction by Prof. H. H. Turner. Pp. xvii+61. (Cambridge: At the University Press.) 5s. net.

Through Deserts and Oases of Central Asia. By Miss Ella Sykes and Brig.-Gen. Sir Percy Sykes. Pp. xii+340. (London: Macmillan and Co., Ltd.) 21s. net.

The Origin and Development of the Composite. By Dr. J. Small. Pp. xi+334+6 plates. (London: W. Wesley and Son.) 15s. net.

A Text-book on Machine Drawing for Electrical Engineers. By E. Blythe. Pp. vii+81. (Cambridge: At the University Press.) 20s. net.

La Molécule Chimique. By Prof. R. Lespiau. Pp. iii+286. (Paris: F. Alcan.) 3.50 francs.

L'Unité de la Science. By Prof. M. L. du Sablon. Pp. iii+284. (Paris: F. Alcan.) 3.50 francs.

The Examination of Materials by X-rays. Pp. ii+64. (London: Faraday Society.) 13s. 6d.

The Physiology of Vision: With Special Reference to Colour Blindness. By Dr. F. W. Edridge-Green. Pp. xii+280. (London: G. Bell and Sons, Ltd.) 12s. net.

### Diary of Societies.

THURSDAY, MARCH 11.

ROYAL INSTITUTION OF GREAT BRITAIN, at 3.—Lt.-Col. E. Gold: The Upper Air: (i) Results and their Interpretation.

INSTITUTE OF METALS (at Institution of Mechanical Engineers) (Annual General Meeting), at 4.—Eng. Vice-Admiral Sir George Goodwin: Inaugural Address.

ROYAL SOCIETY, at 4.30.—W. G. Duffield, T. H. Burbham, and A. A. Davis: The Pressure upon the Poles of Metallic Arcs, including Alloys and Composite Arcs.—J. H. Vincent: Further Experiments on the Variation of Wave-length of the Oscillations Generated by an Ionic Valve Due to Changes in Filament Current.—H. A. Daynes: (1) The Theory of the Katharometer; (2) The Process of Diffusion through a Rubber Membrane.

LONDON MATHEMATICAL SOCIETY, at 5.—G. S. Le Beau: A Property of Polynomials whose Roots are Real.—E. M. Sen: Double Surfaces.

ROYAL COLLEGE OF PHYSICIANS, at 5.—Dr. J. L. Clarke: The Principles of Medical Science as applied to Military Aviation (Goulstonian Lecture).

ROYAL INSTITUTE OF PUBLIC HEALTH, at 5.—Dr. H. M. Berry: X-rays in the Diagnosis of Tuberculosis.

ROYAL SOCIETY OF MEDICINE (Occasional Lecture), at 5.—Sir Jagadis Bose: Plant and Animal Response (with Demonstrations of Growth by the Magnetic Crescograph).

CHILD-STUDY SOCIETY (at Royal Sanitary Institute), at 6.—Dr. M. Jane Reaney: The Educational Needs of Adolescence.

INSTITUTION OF ELECTRICAL ENGINEERS (at Institution of Civil Engineers), at 6.—W. H. Pritchell: Operating a By-product Producer-gas Plant for Power and Heating.—S. H. Fowles: Production of Power from Blast-furnace Gas.

OIL AND COLOUR CHEMISTS' ASSOCIATION (at 2 Furnival Street), at 7.—J. B. Shaw: Various Points in the Manufacture of Lake and Pigment Colours.

OPTICAL SOCIETY, at 7.30.—A. C. W. Aldis: Portable Electric Signalling Lamps.

INSTITUTION OF AUTOMOBILE ENGINEERS (Graduate Section), at 8.—C. A. Chappell: Magneto.

INSTITUTE OF METALS (at Institution of Mechanical Engineers) (Annual General Meeting), at 8.—Dr. G. D. Bengough, K. M. Jones, and Ruth Griffith: Fifth Report to the Corrosion Research Committee.—R. Seligman and P. Williams: The Action on Aluminium of Hard Industrial Waters.

ROYAL SOCIETY OF MEDICINE (Neurology Section), at 8.30.—Prof. J. S. B. Stopford: Results of End-to-end Suture of Peripherial Nerves. SOCIETY OF ANTIQUARIES, at 8.30.

FRIDAY, MARCH 12.

INSTITUTE OF METALS (at Institution of Mechanical Engineers) (Annual General Meeting), at 8.30.—J. Neil MacLean: The Art of Casting in High-Tensile Iron.—H. Moore and S. Beckinsale: The Removal of Internal Stress in 70:30 Brass by Low-temperature Annealing.—Dr. W. Rosenbain, J. L. Haughton, and Kathleen Bin-cham: Zinc Alloys with Aluminium and Copper.—Dr. W. Rosenbain: A Model for Representing the Constitution of Ternary Alloys.—A. C. Vivian: Tri-phosphorus Alloy.—W. C. Hothersall and E. L. Khead: Some Notes on the Effect of Hydrogen on Copper.

INSTITUTE OF METALS (at Institution of Mechanical Engineers) (Annual General Meeting), at 2.30.—W. E. Alkins: The Effect of Progressive Drawing upon some Physical Properties of Commercially Pure Copper.—F. Johnson: The Influence of Cold Rolling on the Physical Properties of Copper.—J. L. Haughton: The Study of Thermal Electro-motive Force as an Aid to the Investigation of the Constitution of Alloy Systems.—H. H. Hayes: The Polishing and Etching of Zinc for Micro-examination.—W. E. Hughes: Idiomorphic Crystals of Electro-deposited Copper. ROYAL ASTRONOMICAL SOCIETY (at 21, Lincoln's Inn), Some Remarkable Properties of Diurnal Motion.—H. C. Plummer: The Nature of Short-period Variables.—L. Becker: (1) Capture Orbits; (2) The Capture Hypo-

thesis of Binary Stars.—T. C. Hudson: A Vectorial Theorem.—R. A. Sampson: Theory of the Four Great Satellites of Jupiter.—J. Jackson: The orbits of 20 Double Stars.—H. W. Newton: Note on the Sun-spot and Facular Disturbance in the Region of the Eclipse Prominence of 1919.—A. S. Williams: The Observed Changes in the Colour of Jupiter's Equatorial Zone.—A. R. Hinks: A Preliminary Account of the Geography of the 1922 September 20 Eclipse Track.

PHYSICAL SOCIETY OF LONDON, at 5.—F. W. Newman: Absorption of Gases in a Discharge Tube.—F. S. G. Thomas: A New Directional Hot-wire Anemometer of High Sensitivity, especially applicable to the investigation of Slow Rates of Flow of Gases.—Dr. Hans Pettersen: Exhibit of a New Micro-balance.

UNIVERSITY COLLEGE ENGINEERING SOCIETY (Annual Public Meeting), at 5.30.—Sir Dugald Clerk: Coal Conservation.

MALACOLOGICAL SOCIETY OF LONDON (at Linnean Society), at 6.

INSTITUTION OF MECHANICAL ENGINEERS (Informal Meeting), at 7.—A. J. H. Pitt and Others: Costing.

JUNIOR INSTITUTION OF ENGINEERS, at 7.30.—F. A. Simpson: Chain Helve Pumps.

HARVEIAN SOCIETY (at the Medical Society of London), at 8.30.—Sir Thomas Horsley: The Diagrammatic Significance of Nerve Symptoms in Acute Infections (Harveian Oration).

ROYAL INSTITUTION OF GREAT BRITAIN, at 9.—W. W. Rouse Ball: String Figures.

## SATURDAY, MARCH 13.

ROYAL INSTITUTION OF GREAT BRITAIN, at 3.—Sir J. J. Thomson: Positive Rays.

## MONDAY, MARCH 15.

VICTORIA INSTITUTE (at Westminster), at 4.30.—E. W. G. Masterman: The Walls of Jerusalem at Various Periods.

ROYAL SOCIETY OF MEDICINE (Occasional Lecture), at 5.—Dr. J. Fre-mant: Toxic Idiopathies: The Relationship between Hay and other Pollen Fevers, Animal Asthma, Food Intolerances, Bronchial and Spasmodic Asthma, etc.

INSTITUTION OF ELECTRICAL ENGINEERS (Informal Meeting) (at Chartered Institute of Patent Agents), at 7.—J. W. Beauchamp and S. M. Hills: Industrial Electric Heating.

ROYAL INSTITUTE OF BRITISH ARCHITECTS, at 8.—H. Austen Hall: The Planning of American Departmental Stores.

SURVEYORS' INSTITUTION, at 8.

ROYAL GEOGRAPHICAL SOCIETY (at Æolian Hall), at 8.30.—Prof. J. L. Myres: The Dodekanese.

## TUESDAY, MARCH 16.

ROYAL INSTITUTION OF GREAT BRITAIN, at 3.—Prof. A. Keith: British Ethnology—The Invaders of England.

ROYAL COLLEGE OF PHYSICIANS, at 5.—Dr. J. L. Bir'ey: The Principles of Medical Science as applied to Military Aviation (Goulstonian Lecture).

ROYAL SOCIETY OF MEDICINE, at 5.—(Special General Meeting of Fellows.)

ROYAL STATISTICAL SOCIETY, at 5.15.—M. S. Birkett: The Iron and Steel Trades during the War.

ROYAL SOCIETY OF CIVIL ENGINEERS, at 5.30.—Sir Alexander B. W. Kennedy: Lantern Exhibit on Views taken throughout the War Areas in France and Flanders.

INSTITUTION OF PETROLEUM TECHNOLOGISTS (at Royal Society of Arts), at 5.30.—M. A. Ockenden and A. Carter: Plant used in the Rotary System of Drilling Oil Wells.

MINE AND FUEL TECHNOLOGISTS (at Geological Society), at 5.30.—A. Russell: The Occurrence of Cottoni e, Angle-site, Leadhill lile, and Ga'ena on Fused Lead from the Wreck of the Fireship *Fire rands*, talmouth Harbour, Cornwall.—W. Campbell Smith: Riebeckite-rhyolite from Northern Kordofan.—Dr. G. T. Prior: The Meteoric Iron of Mount Ayliff, Grianalund East, South Africa.

ZOOLOGICAL SOCIETY OF LONDON, at 5.30.—R. I. Pocock: The External Characters of South American Monkeys.—Dr. C. F. Sonntag: The Comparative Anatomy of the Tongues of the Mammalia: I. General Description of the Tongue.

ROYAL PHOTOGRAPHIC SOCIETY OF GREAT BRITAIN (Lantern Meeting), at 7.—Maj.-Gen. W. S. Bancker: Bird's-Eye Views of London and other Districts in Eng'nd and from Aeroplane Photographs.

ROYAL ANTHROPOLOGICAL INSTITUTE, at 8.15.—N. W. Thomas: The Ovia Secret Society (Illustrated by Lantern Slides and Phonograph Records).—Surg.-Lt. R. Buddle: Exhibition of Film Implements from Russia.

## WEDNESDAY, MARCH 17.

ROYAL NUTRITION SERVICE INSTITUTION, at 3.—Major H. F. S. Huntington: The Physical and Ethical Value of Boxing.

ROYAL SOCIETY OF ARTS, at 4.30.—W. W. Beaumont: Street Passenger Transport of London.

ROYAL METEOROLOGICAL SOCIETY (at Royal Astronomical Society), at 5.—Capt. C. Douglas: Clouds as seen from an Aeroplane.

INSTITUTION OF ELECTRICAL ENGINEERS (Wireless Section) (at Institution of Civil Engineers), at 6.—Capt. P. P. Eckerseley: Duplex Wireless Telephony: Some Experiments on its Application to Aircraft.

ROYAL AERONAUTICAL SOCIETY (at Royal Society of Arts), at 8.—Major C. F. Abel: Airship Machinery.

ROYAL MICROSCOPICAL SOCIETY, at 8.

## THURSDAY, MARCH 18.

ROYAL INSTITUTION OF GREAT BRITAIN, at 3.—Stephen Graham: The Spirit of America after the War.

ROYAL SOCIETY, at 4.30.—*Probable Papers*.—W. B. Brierley: A Form of *Botrytis cinerea* with Colourless Sclerotia.—R. R. Gates: A Preliminary Account of the Mite-like Phenomena in the Pollen Mother Cells and Tapetum of Lettuce (*Lactuca sativa*).

ROYAL SOCIETY OF ARTS, at 5.

ROYAL COLLEGE OF PHYSICIANS, at 5.—Sir John R. Bradford: The Clinical Experiences of a Physician during the Campaign in France and Flanders, 1914-1919 (Lumleian Lecture).

INSTITUTION OF MINING AND METALLURGY (at Geological Society), at 5.30.—W. R. Jones: Tin and Tungsten Deposits: The Economic Significance of their Relative Temperatures of Formation.

INSTITUTION OF ELECTRICAL ENGINEERS (at Institution of Civil Engineers), at 6.—Adjourned Discussion on the Papers of W. H. Patehall and S. H. Fowles read at the Meeting on March 11.

CHEMICAL SOCIETY, at 8.—J. Masson and R. McCall: The Viscosity of Nitrocellulose in Mixtures of Acetone and Water.—H. Stephen, W. F. Short and G. Gladding: The Introduction of the Chloromethyl Group into the Aromatic Nucleus.—H. E. Cox: The Influence of the Solvent on the Velocity of Reaction between certain Alkyl Iodides and Sodium  $\beta$ -Naphthoxide.—H. Crompton and P. L. Vanderstichele: The Use of 1:2-Dichlorovinylethyl Ether for the Production of Chloroacetates and Acid Chlorides.

## FRIDAY, MARCH 19.

ROYAL SOCIETY OF ARTS (Indian Section), at 4.30.—Sir William S. Meyer: The Indian Currency System and its Development.

CONCRETE INSTITUTE, at 6.—Dr. O. Faber: The Practical Application of Reinforced Concrete.

INSTITUTION OF MECHANICAL ENGINEERS, at 6.—D. Brownlie: Exact Data on the Performance of Mechanical Stokers, as applied to "Lancashire" and other Narrow-fueled Boilers.

ROYAL INSTITUTION OF GREAT BRITAIN, at 9.—E. McCurdy: Leonardo da Vinci.

## SATURDAY, MARCH 20.

ROYAL INSTITUTION OF GREAT BRITAIN, at 3.—Sir J. J. Thomson: Positive Rays

PHYSIOLOGICAL SOCIETY (at University College), at 4.—J. F. Donegan and Others: Innervation of Veins.

## CONTENTS.

	PAGE
The State and the National Museums	29
Mathematical Cosmogony. By H. C. P.	31
Tropical Medicine. By J. W. W. S.	33
Practical Chemistry. By C. J.	33
Botanical Guides	34
Our Bookshelf	35
Letters to the Editor:—	
Gravitational Deflection of High-speed Particles.—Prof. A. S. Eddington, F.R.S.	37
Gravitational Shift of Spectral Lines.—Dr. Harold Jeffreys	37
The Position of the Meteorological Office.—Dr. Hugh Robert Mill; Walter W. Bryant	38
Organisation of Scientific Work.—Sir J. C. Bose	39
Photographs of Seven Vocal Notes. (Illustrated).—Dr. W. Perrett	39
Scientific Direction of Industrial Research.—Major A. G. Church	40
On Langmuir's Theory of Atoms. (With Diagram.) S. C. Bradford	41
Seconding of Officers for Study at Universities.—Prof. J. Wertheimer	41
Scientific and Technical Books.—Sir R. A. Gregory. Daylight Saving and the Length of the Working Day.—Annie D. Batts	41
Rainfall and Land Drainage. By Dr. Brysson Cunningham	42
The Work of the Medical Research Committee	43
The Mariner's Compass	44
The Gyrostatic Compass. (Illustrated). By S. G. Brown, F.R.S.	44
Obituary: Prof. J. Emerson Reynolds, F.R.S. By E. A. W.	49
Notes	50
Our Astronomical Column:—	
Bright Meteors	54
Total Light of the Stars	54
Star Clusters	54
Meteorological Observations at Calcutta. By W. W. B.	55
The Road to Industrial Peace. By H. M. V.	55
Wireless Telephony on Aeroplanes	55
Magnetic Storm of March 4-5	56
University and Educational Intelligence	56
Societies and Academies	57
Books Received	59
Diary of Societies	59

Editorial and Publishing Offices:  
MACMILLAN AND CO., LTD.,  
ST. MARTIN'S STREET, LONDON, W.C.2.

Advertisements and business letters to be addressed to the Publishers.

Editorial Communications to the Editor.  
Editorial Address: PHUIS, LONDON.  
Telephone Number: GERRARD 8830.



THURSDAY, MARCH 18, 1920.

## Science and the New Army.

THE memorandum of the Secretary of State for War relating to the Army Estimates for 1920-21, which has been recently issued by the War Office "in amplification of the speech of the Secretary of State introducing the Army Estimates" (Cmd. 565, price 3d.), is a notable document in both its national and scientific aspects. It represents the introduction of a new attitude towards military and medical science, as is shown by the following quotations:—

"We must continue to develop the power of our armaments, not by accumulating large stocks of weapons and stores for a great national Army in peace time of patterns that may become obsolete before they are used, but by scientific research and experiment which will lead to the design of the best types, and by preparation which will enable bulk production to commence without the unfortunate delays that had such a lamentable effect during the early stages of the Great War. . . . It is necessary to make adequate provision for research experiments and design in connection with war material. . . . We must, unfortunately, continue our studies of what is known as chemical warfare. . . . It is our policy to farm out to civil scientific institutions, such as the universities, the National Physical Laboratory, the Imperial College of Science and Technology, etc., all pure research that can be profitably farmed out, and, generally speaking, to restrict military institutions to applied research and the preliminary design of apparatus."

More could be quoted to encourage the belief that the Army has learnt its lesson; and, besides, there is the new Education Corps, as well as changes at Woolwich, Sandhurst, and the staff colleges, and new Army schools.

Those men of science who have served in the Army and were at times driven to despair by its patterns that have become obsolete in high places may be slow to believe in the seeming change of heart. With this memorandum before us, however, we are given reason for hope in improved conditions, and should assist in realising them. It is undeniable that, broadly speaking, early in the war, the Army was perilously out of touch and out of comprehension with respect to science, but it must also be remembered that the forces of science were not marshalled and led by any means so well as they might have been. The chemists, it is true, made an attempt to organise, but when they approached the Board of Trade

with the view of establishing something like a clearing house, they succumbed to a strange *non sequitur* in the form of an assurance that the Government was going to establish a Department of Scientific and Industrial Research. Before and after that, chemists drifted to their various posts under a variety of currents, which only too often put a wrong man in a place for which the right one was equally available.

No doubt wonders were done, but it is surely most desirable that, for the future, science should have some scheme of mobilisation ready. In saying this, it is not suggested that a rigid scheme could, or should, be attempted, but there is something between detachment and regimentation that is better than either, and this at least it should not pass the wit of man to design.

Over-organisation is one of the reactionary extravagances of the war, and it is evident to some degree in the memorandum before us. Some pride appears to be taken for the provision of Co-ordinating Boards, which among other things "should lead to the detection of overlap [in research] where such exists, and its elimination." Overlap is the bogey of the official mind, and co-ordination the blessed word. So far as the advancement of science for peace or war is concerned, let us hope that philosophers will go to the stake rather than be deprived of their right to overlap anybody or anything they may choose.

The overlap of chemistry and physics is maintaining the credit of our country in science; an equal overlap of the General Staff of the Army and the brotherhood of science, if it can be achieved, will do also much for the safety of the country. That is the vital thing for which there is perhaps some promise, but not yet adequate assurance. Science linked to the Army by fussy research co-ordinators acting under a nescient soldier will not solve the difficulty. It is perhaps too much to expect that all officers on the General Staff will have had a scientific education, but until it is made obligatory for a proportion of them to have had such a training, the fundamental reform will not have been effected, and science will not occupy its rightful position in the new Army.

The section of the memorandum which relates to the Royal Army Medical Corps is of noteworthy interest. An important feature is the reorganisation of the medical section of the Territorial Army under the supervision of a Territorial section of the War Office. In view of the fine work which was done by Territorial units during the war, it is

to be hoped that this branch of the Medical Corps will be given the opportunities it deserves. The proposal to form a dental corps is indeed excellent, and it might be advantageous to unite with this the plastic surgery which was so intimately associated with dental work in the late war.

In our opinion one of the best changes in the Army medical administration is the establishment of the new directorates of pathology and hygiene; an important consequence of this is that promotion to the highest rank is now open to the specialists who take up such work in the Army. Efficient collaboration with the civil profession and with other branches of State medical work will be ensured by the aid of an advisory committee of experts, both civil and military. It may be assumed that the work hitherto carried on by the vaccine department of the Royal Army Medical College will henceforth be taken under the directorates of pathology and hygiene. The figures given in the memorandum show how largely the work of the vaccine department aided in maintaining the health of the troops in the field, and with a very much smaller expenditure than would have been entailed in private purchase. More than 33,000,000 doses of vaccines of various types were prepared during the last five years; the value of the vaccines is well illustrated by the case of the protection afforded against the typhoid group of diseases. In the French Army, before full protection against typhoid, there were from the outbreak of the war until the end of October, 1915, 95,809 cases, with 11,690 deaths; after the adoption of treatment the French figures were comparable with our own—during the entire war we had 7423 cases, with 266 deaths, in our Expeditionary Force in France.

The future of gas warfare is briefly dealt with in the memorandum. This form of offensive has evidently come to stay, and it is stated that, owing to the fact that preparations for the use of gas can be made in peace time with great secrecy, it is necessary continually to study defensive measures capable of meeting such a form of attack. Defence against gas involves physiological, quite as much as chemical, measures, as is shown by the important part played by physiologists in the elaboration of the British box respirator, which is the most perfect and wearable defence against all gases hitherto employed in war. It is to be hoped that the War Office will continue to consult both physiological and chemical experts in problems connected with the construction of respirators, and also in the arrangements for training troops in such devices.

### The Roast Beef of Old England.

*Cattle and the Future of Beef-Production in England.* By K. J. J. Mackenzie. With a preface and chapter by Dr. F. H. A. Marshall. Pp. xi+168. (Cambridge: At the University Press, 1919.) Price 7s. 6d. net.

WITH the advent of peace, British agriculture, still harassed and bewildered by the vagaries of a "control," painful, like a tooth, in its going as in its coming, has entered upon a transition stage towards the establishment of a new equilibrium, the character of which must be a subject of anxious concern to all who believe that a prosperous and contented agriculture is the soundest basis upon which the national welfare can rest. At this juncture wise counsel is needed from those best qualified to give it, and it will find a more sympathetic hearing than was wont to be the case in the bygone days when farming was so generally looked upon more as a mode of life than as a complex industry of vital importance to the nation, and requiring the sympathetic and active support of the community.

The change in the direction of an increase of plough-land at the expense of grass-land, which was forced upon the industry by the necessities of war, is already in process of reversal, and this return to grass is likely to proceed at an increasing rate unless clear evidence is forthcoming that arable farming for some years to come is likely to give such enhanced profits as compared with grass farming as will compensate adequately for the greater worries and outlay it entails. The gain to national security which the increased supply of home-grown breadstuffs obtainable from an enlarged arable acreage can confer is obvious, and that this is at the same time consistent with a profitable system of agriculture is amply demonstrated in the practice of Germany, Belgium, and the Scandinavian countries, where systems designed essentially for the production of corn, vegetables, and milk prevail.

It must not be too readily assumed, however, that these systems are directly applicable to British conditions, which differ in many respects, and, Mr. Mackenzie would warn us, in none more vitally than in the more refined taste in meat, *par excellence* beef, which marks us out as a race apart. The German and the Dutchman are apparently condemned by their systems of agriculture to a beef mainly derived from the carcasses of worn-out milch cows and draught oxen, but who could forecast the consequences of a change in our agriculture which would restrict the British workman—and the British cook—to such fare! Mr. Mackenzie has no doubt that it would lead to "a

general fall in our national standard of life," and have "a very pernicious effect on the efficiency of our race."

He would postulate, therefore, that no system of agriculture can be sound for this country unless it provide for an abundant supply of prime beef. We must hasten to explain, however, that he is no advocate of reversion to grass farming, which, indeed, he condemns roundly as "stealing from the land." Nor is he satisfied with other current systems of beef production. Taking the various systems at present in vogue, he has no difficulty in demonstrating that on the average British farm even the best of them represents but a very inefficient use of the possibilities of the soil.

A great deal of our grass-land can be made far more productive by suitable ameliorative treatment, but more fundamental than this is the need for improvement of the general quality of our breeding stock. It cannot be denied that, despite the pre-eminence of our best stock, the general level of quality of cattle found on the majority of our farms is deplorably low. This is in some measure due to the great development of our export of cattle, which has given to the foreigner the pick, whilst leaving for the home farmer only the moderate animals and the outcasts of our pedigree herds. Moreover, the class of animal which the foreigner demands is not that which is best suited to the present home requirements.

The export trade must continue to be an important feature of our pedigree stock raising, but it is high time that organised effort should be made through State action with the co-operation of landed proprietors and agricultural associations to encourage the development of types of cattle especially suited for our own purposes and to ensure their distribution over the farms of the country. With an improved type of cow, capable of producing a good yield of milk and early-maturing, well-fleshed progeny, it will be possible to combine intensive cultivation with the production at reasonable cost of the milk, beef, cheese, butter, and veal which the maintenance of a high standard of living requires.

There are many signs that the line of reorganisation which Mr. Mackenzie indicates is the one which British agriculture is most likely to follow, and it is sincerely to be hoped that his book will circulate widely amongst the leaders of agricultural opinion and the farming community generally. Last, but not least, his exposition of the need for greater provision for research in animal husbandry must be warmly commended. Without this the improvement of live-stock must remain to a large extent a blind groping after ends incapable of precise definition.

C. C.

### French Text-books of Chemistry.

- (1) *Notions Fondamentales de Chimie Organique.* By Prof. Charles Moureu. Sixième édition. Pp. vii + 552. (Paris: Gauthier-Villars et Cie, 1919.) Price 16 francs.
- (2) *Cours de Chimie à l'usage des Etudiants P.C.N. et S.P.C.N.* By Prof. R. de Forcrand. Deuxième édition. Tome 1. *Généralités—Chimie minérale.* Pp. viii + 437. Tome 2. *Chimie organique—Chimie analytique; Applications numériques.* Pp. 527. (Paris: Gauthier-Villars et Cie, 1919.) Price 14 francs and 18 francs respectively.

(1) **A**S a science develops and facts multiply and group themselves into laws and theories, the system of imparting knowledge is greatly simplified by using these generalisations as pegs upon which to hang the facts. Whilst this process is of the very essence of scientific growth, it is important not only that the theories should clothe the facts, but also that the tight or loose parts of the garment should be clearly marked in sartorial fashion for future modification. Nothing is more misleading than the attempt to adjust a theory by implication or by omission of details to limbs it does not fit. How flabby many a theory has looked on close inspection!

Herein lies a danger into which present writers on organic chemistry may fall. The mere enumeration of compounds has been replaced by the description of a few typical examples, and broad generalisations have been illustrated and condensed into a few paragraphs. This system of condensation, whilst it affords a useful survey of the whole region of organic chemistry, may in the process omit those apparently insignificant exceptions which, like the minute foreign substances in metals, modify the whole character of the material.

We have been led to express these views in the perusal of Prof. Moureu's treatise.

The fact that it has reached a sixth edition is sufficient evidence that, whatever its merits or defects, the book has established itself as a popular text-book, and that it should have so established itself is easy to understand.

The number of compounds described, though sufficiently numerous, is not more than is necessary to illustrate some general process. Each chapter and section is introduced by a few paragraphs on *généralités*, admirably and lucidly explained. The weak point of these *généralités* is their brevity. They merely touch the fringe of the subject, and as there are no references, the student is not encouraged to bridge the gaps. Tautomerism, which finds a place under ketonic acids, is dismissed in less than three pages.

Each new subject is introduced by a string of names of distinguished chemists who have been concerned in its study (sometimes as many as eight are given), but there is no indication of the nature of their contributions, and again no references are given. Incidentally, it may be pointed out that the names of French chemists are much in evidence. Under "Valency," Frankland's name is not even mentioned. These are minor points.

The arrangement, though somewhat novel to English chemists, is finding favour both in France and in America. There is no division into aliphatic and aromatic compounds, but the two are combined. Thus chap. ii. includes all the hydrocarbons, saturated and unsaturated, aromatic and hydro-aromatic, and the same system is followed throughout. The nitrogen compounds have a chapter to themselves, and there are others on organo-metallic compounds, heterocyclic compounds, and colouring matters.

(2) Prof. de Forcrand's class-book of chemistry, which has reached a second edition, is written for students who are entering on a course for the P.C.N. and S.P.C.N.—that is to say, a certificate sanctioned by the Ministry of Public Instruction for advanced study in physics, chemistry, and the natural sciences, the P.C.N. representing a standard intermediate between the *baccalauréat* and the *licencié* in science, and the S.P.C.N. being the equivalent of the latter.

The course is divided into two parts, inorganic and organic, which are treated in separate volumes. The inorganic section is divided into *généralités*, metalloids, and metals. The book is not intended for, nor is it to be recommended to, beginners. The general principles laid down in the first section, which include such notions as reversible and isomeric changes, the phase law, mass action, displacement of equilibria, etc., would be almost meaningless unless the student were already acquainted with the phenomena upon which these generalisations are built. Moreover, the subjects are presented in a didactic manner, in which general statements are laid down without any attempt at adducing evidence for them.

It seems to the writer that the old method, which was so common formerly among authors of science text-books, of introducing general principles and definitions before any experimental facts had been discussed, though perhaps philosophically sound, is not the best way of applying the experimental method—that is, the method of reasoning from facts to generalisations—and not only so, but it is almost bound to lead, as in the present case, to didactic treatment.

The same criticism applies to the volume on organic chemistry. The linking of carbon atoms

by single and multiple bonds is assumed without evidence, and so also is the structure of the various organic groups.

Generally speaking, the book is somewhat old-fashioned in its arrangement, in spite of paragraphs on modern topics. It suffers, too, from a dearth of illustrations. Even if the student has studied his subject experimentally, and is acquainted with apparatus and methods, he is still ignorant of many practical operations of a technical character or special apparatus used in the preparation of rarer compounds which some good drawings would help him to grasp.

Having pointed out what seem to the writer the chief defects of treatment, it should be added that the information is well arranged, and covers the most important facts without unnecessarily multiplying the number of compounds. It is curious to find the subject of analytical chemistry, both inorganic and organic, relegated to the end of the volume on organic chemistry.

J. B. C.

### Indian Beetles.

*The Fauna of British India, including Ceylon and Burma. Coleoptera. Chrysomelidae (Hispaniinae and Cassidinae).* By Prof. S. Maulik. Pp. xi + 439. (London: Taylor and Francis, July, 1919.) Price 1 guinea.

THERE is evidence enough in this volume to show that many months of assiduous work must have gone to its preparation; but it leaves more than an impression that the author lacked experience to begin with, and had not quite mastered his subject. His descriptions are generally too long. An author of experience, using better judgment, would have confined his attention to essentials when describing species, and left out the rest, thus saving himself and his readers both time and trouble. It would have meant a lot in a volume like this, where 388 species altogether come under notice, and all but a few are described at length. Where the descriptions are long and the differential characters not clearly marked out, the keys to genera and species need to be well constructed and trustworthy.

Prof. Maulik's keys do not always answer to this description. His keys to species not infrequently contain diagnoses which, though fairly long, are not quite long enough to enable the text descriptions to be dispensed with altogether; and the key to his first group of genera is of so little service that the reader is left to decide which is the more to be trusted, the author or his artist, the key or the text. He has nowhere

explained why he has rejected certain characters made use of with great success by Chapuis in his grouping of the genera of *Hispinæ*; and it is to be noticed also that he has not stated why there is so very rarely any reference to sexual differences in his descriptions, either of genera or of species, which otherwise appear to show close observation.

About ninety of the species described are the author's own, and to many of these he has given names which, derived from the ancient language of his country, form a novel and interesting feature of the book. In a short introduction to each sub-family an account is given of the few larvæ and life-histories known, and a list of useful references to other works in which information about them may be found. Mimicry in the *Hispinæ* is touched upon, and Gahan's observations on the interesting stridulatory structures met with in the same sub-family are quoted almost in full, but without reference to the value they were expected to have for systematic purposes.

The volume is well illustrated, and the figures, all greatly enlarged, appear to be carefully drawn, with the exception of one on p. 86, which is not what it is said to be—the "mentum" of a genus which is unique amongst the *Chrysolmelidæ* in having no labial palpi. Were it not for defects of the kind pointed out, and frequent signs of carelessness in the text, the volume, on the whole, would deserve much praise, due regard being given to the fact that it is the author's first essay in systematic work on more than a small scale.

C. J. G.

### Mathematics: Pure and Applied.

- (1) *The Fundamental Equations of Dynamics and its Main Co-ordinate Systems Vectorially Treated and Illustrated from Rigid Dynamics.* By Frederick Slate. (Semi-centennial Publications of the University of California.) Pp. ix + 233. (Berkeley: University of California Press, 1918.)
- (2) *Projective Vector Algebra: An Algebra of Vectors Independent of the Axioms of Congruence and of Parallels.* By Dr. L. Silberstein. Pp. vii + 78. (London: G. Bell and Sons, Ltd., 1919.) Price 7s. 6d. net.
- (3) *Elements of Graphic Dynamics: An Elementary Text-book for Students of Mechanics and Engineering.* By Ewart S. Andrews. Pp. viii + 192. (London: Chapman and Hall, Ltd., 1919.) Price 10s. 6d. net.
- (4) *Differential Calculus for Colleges and Secondary Schools.* By Dr. Charles Davison.

(Cambridge Mathematical Series.) Pp. viii + 309. (London: G. Bell and Sons, Ltd., 1919.) Price 6s.

- (5) *The Analytical Geometry of the Straight Line and the Circle.* By John Milne. (Bell's Mathematical Series.) Pp. xii + 243. (London: G. Bell and Sons, Ltd., 1919.) Price 5s.

(1) **M**ANIFOLD adaptations of dynamical reasoning have given rise to specialised treatises of undoubted excellence. Prof. Slate sets himself the task of surveying the common foundation and the common stock of resources of these adaptations, as well as the trend of modern development in dynamics. Six quantities enter into the formulation of fundamental dynamical principles: force, power, and force-moment on one hand, momentum, kinetic energy and moment of momentum on the other. Each triad can be, and has been, used in the enunciations of dynamics. But the enunciations involve the use of reference-frames, leading to the question of the relativity of such frames and the transformation from one frame to another—both when the transformation is that of a mere translation, and when it partakes of the more general form of a shift and a rotation. The author considers these transformations and the chief kinds of co-ordinate systems. Euler's and Lagrange's equations, and their use in the study of the dynamics of a rigid body, conclude a presentation possessing considerable interest and originality. A number of notes are added containing references and further elucidations.

An objectionable feature of the book, and one that destroys much of its value, is the difficult English in which it is written. The most intelligible portions are those consisting of mathematical symbolism—the accompanying letterpress is often a puzzle. What is one, e.g., to make of the following?—

"In consequence it has not been displaced as a tenet of orthodox dynamical doctrine that standards by which to judge of the energy, momentum and force that ought to appear in its accounts will not stand on a par if adopted at random, however interchangeable they have proved in passing upon rest, velocity and acceleration by the mathematical criteria in the more indifferent domain of kinematics."

The impression one has in reading the book is that of a laborious progress over a succession of obstacles. Not every reader can be expected to persevere when so many of the obstacles are due to the guide whose function it should be to remove such difficulties as are inherent in the subject.

- (2) In Dr. Silberstein's book on "Projective

Vector Algebra" we have a very lucid exposition of a subject somewhat removed from the ordinary interests of the mathematical teacher or researcher. Vectorial representation is a common feature of many branches of physical science, and the author's share in the encouragement of the use of vectorial methods amply justifies his further contributions to the discussion of the nature and properties of vectors, whether as means of calculation and research, or as illustrative of fundamental geometrical properties of space. The present book aims at the construction of an algebra of vectors, based solely on the axioms of connection and of order. Only addition and subtraction of unlocalised vectors are dealt with in the book itself; in a subsequent paper in the *Philosophical Magazine* the treatment is extended so as to include multiplication and division.

Opinions may differ as to the utility of the system thus constructed; there does not seem to be any obvious application of the ideas to the discovery of new results in pure mathematics or in investigations of a physical character. But the methods are elegant, and the exposition is admirable. The proofs afforded of theorems on the projective geometry of rectilinear figures and conics amply repay the few pleasant hours spent in reading the book and its continuation in the above-mentioned paper. One may perhaps question whether the book is really adapted for "beginners in geometry."

It would have added to the value of the investigation if the book had been divided into chapters and a reasonable number of examples inserted for exercise in the methods developed. The construction for scalar multiples of a vector admits of some simplification.

(3) This is a useful account of the application of graphical methods to dynamical problems, especially such as are of an engineering character. The process of graphical integration is applied to work, to space, to velocity and acceleration, and to action, the auxiliary parabola being used for the last. Polar diagrams are used with special application to simple harmonic motion and to combinations of simple harmonic motions, to cams, etc. Velocities changing in direction are then considered with applications to rotating bodies and the turbine. Linkages and static forces in mechanisms are followed by the elements of fly-wheel design and the theory of the balancing of rotating parts. There are many diagrams and exercises.

Though primarily intended for the engineer, the book contains much that should be incorporated into ordinary elementary courses on dynamics. Actual live problems with their practical solutions

are far more valuable, pedagogically, than the numerous artificial exercises that are given in so many of the books written "for schools and colleges."

Mr. Andrews should take more pains with his notation; the needless use of  $x$  for ordinates must surely annoy the student. The statement

$$\text{mean effort} = \frac{\text{area below curve}}{\text{length of curve}}$$

(p. 14) needs obvious correction. The definition of work on p. 34 applies only to a force constant in magnitude and direction. On p. 47 simple harmonic motion is defined in the usual manner, but with the addition that the force acts in a direction opposite to the direction of motion of the body. This is not an oversight, for it is repeated on p. 64!

(4) This is not a book for beginners, although Dr. Davison follows the usual practice of indicating what might be omitted on a first reading. The whole book should be put aside on a first reading of the subject, and a more suitable presentation selected for the purpose.

But the student who has already mastered the elements of the calculus, and understands the meaning of a limit and the notion of differentiation and integration, is ready for Dr. Davison's book. It is brief, yet full. Part i. contains first principles—i.e. differentiation, successive differentiation, expansions, and indeterminate forms. Part ii. deals with the applications to maxima and minima, and to the theory of curves, including curvature, asymptotes, singular points, curve-tracing in Cartesian and in polar co-ordinates, envelopes, evolutes, and pedals. There are numerous examples, including sets of revision exercises. Two excellent features are the problem papers and the suggestions for a number of mathematical essays. The form of the book is pleasant, and the diagrams are well drawn and reproduced.

A few improvements are possible. Thus §§ 28 and 34 are ambiguously worded. There is a trap in the formulæ of § 61. In the chapter on polar co-ordinates nothing is said about the ambiguity inherent in polar equations, as mentioned in these columns in a recent review of another book. These are but a few blemishes in what is an excellent production on well-known traditional lines.

(5) There is much excellent matter in Mr. Milne's discussion of the analytical geometry of the straight line and circle. The treatment is lucid and such as will appeal to the beginner; the subject-matter is very well chosen, and presented in abundant detail with numerous illustrative exercises, both worked and unworked.

It is difficult, however, to recommend the book for general use in schools. Attention has been directed on several occasions to defective figures in elementary mathematical text-books. In Mr. Milne's book the fault exists in an accentuated degree. No attempt seems to have been made to co-ordinate the diagrams and the letterpress, whilst many of the diagrams printed on squared paper contain actual mistakes. These criticisms apply to diagrams on pp. 3, 34, 35, 36-37, 38, 53, 55, 58, 59, 63, 72, 74, 88, 92, 120, 123, 128, 129, 143 (a very bad case), 147, 148, 155, 157, 166, 179. It is surely not right to place such diagrams before young students.

If the book were re-issued with correctly drawn diagrams, it would constitute a valuable addition to school and college text-books.

S. BRODETSKY.

### Our Bookshelf.

*The British Journal Photographic Almanac and Photographer's Daily Companion*, 1920. Edited by George E. Brown. Pp. 912. (London: Henry Greenwood and Co., Ltd.) Price 1s. 6d. net.

ALTHOUGH this volume has not quite reached its pre-war bulk, it has gone a long way towards it, and appears to be now lacking only a little in its former plethora of advertisements. Unfavourable conditions still hold, but the editor has been able to restore the tables, formulæ, and other technical details that photographers have for so many years been in the habit of consulting in their daily work. The "Epitome of Progress" is a good summary of the novelties of the past year, and there is, we think for the first time, a "History in Brief of Photographic and Photo-mechanical Processes." The nine pages devoted to this subject will be of special interest to the student, for they give the dates of a very large number of important facts connected with the development of photography, starting from the very beginning. We notice that sensitol red and sensitol green are ascribed to Prof. Pope in 1917. We always thought that these were pinacyanol and pinaverdol, respectively, of German origin some years previously, and that to Prof. Pope was due the credit of preparing them in this country, and also of introducing sensitol violet, which, however, does not appear to be mentioned. The section on "Beginners' Failures in Photography," by the editor, deserves much appreciation. C. J.

*Toxines et Antitoxines*. By M. Nicolle, E. Césari, and C. Jouan. Pp. viii+123. (Paris: Masson et Cie, 1919.) Price 5 francs net.

M. NICOLLE holds such a high place among those who have made contributions of real importance to our knowledge of parasites that it seems a

pity he should put out this disorderly summary of some of the researches of himself and his collaborators. It reads like a bundle of notes that a man might make to define the current position of his investigations, and to settle which piece of work he should take up next. With trivial exceptions M. Nicolle reviews no facts but those of his own discovery, and it is impossible to distinguish between conclusions and hypotheses. He points out, for example, the similarity of symptoms and anatomical lesions produced by various toxins of different origins, and the diversity and specificity of the antibodies which result from their introduction into the animal economy. He therefore concludes that toxins consist of two parts, one poisonous and not an antigen, the other inactive and an antigen. This is no more than a possibly fruitful hypothesis on which to base further experimentation. Those who know the subject well might run through the book with advantage; others had better leave it alone. A. E. B.

*Some Wonders of Matter*. By the Right Rev. Dr. J. E. Mercer. Pp. 195. (London: S.P.C.K.; New York: The Macmillan Co., 1919.) Price 5s. net.

BISHOP MERCER writes for children, and in a manner in accordance with the Child's Guide of our grandparents rather than with modern educational ideals. His primary concern is to excite the naive wonder which he considers so valuable; so he makes no selection, but ranges apparently at random from Pharaoh's serpents to Brownian motion without giving any clue to the relative importance of the very varied matters at which he glances. So wide a range in so small a space would tax severely the highest powers of exposition, and Bishop Mercer has not the genius for happy analogy that is characteristic of all the most successful writers for the young. Again, though the work is free from serious error, we judge that its author has not a first-hand acquaintance with science. If he had, he would scarcely puzzle the brains of his small charges (and incidentally that of the reviewer) by raising questions no serious student of science would ask—those, for example, which give rise to the paradoxes of Berkeleyan idealism. On the other hand, some parents will welcome the definitely religious tone and be gratified that the Divine Intelligence is presented in a form sympathetic to the simplest.

*An Arithmetic for Preparatory Schools. With Answers*. By Trevor Dennis. Second edition, revised. (Bell's Mathematical Series.) Pp. xiv+376. (London: G. Bell and Sons, Ltd., 1919.) Price 4s. 6d.

MR. DENNIS'S "Arithmetic" well deserves the second edition which it has reached. The sequence is based on the syllabus of mathematical teaching for ages nine to sixteen, for non-specialists, issued by the Curriculum Committee of the Headmasters' Conference. Suitably chosen exercises and clear type make the book well adapted for the students for whom it is intended.

### Letters to the Editor.

(The Editor does not hold himself responsible for opinions expressed by his correspondents. Neither can he undertake to return, or to correspond with the writers of, rejected manuscripts intended for this or any other part of NATURE. No notice is taken of anonymous communications.)

#### Museums and the State.

I HAVE read with deep interest the leading article entitled "The State and the National Museums" which appeared in NATURE of March 11. As a zoologist my interest is chiefly centred in the Natural History Museum at South Kensington, and I most heartily agree with the statement that "the development of the Natural History Museum has been grievously hampered by the persistent attempt made to fit it to a system devised . . . especially for the great library [at Bloomsbury], which has, in fact, always tended to overshadow the rest of the museum."

Historically, as you point out, the museum at South Kensington is the offspring of the mother institution at Bloomsbury, but the daughter is now fully grown up, and should be completely free from parental control. It seems quite anomalous that a man chosen for his knowledge of antiquities and literature should be the supreme head over the greatest collections of animals and plants which exist anywhere in the world.

Few Englishmen have any adequate idea of the value of the asset represented by these collections. Most of them, like Lord Sudeley, whom you quote, regard the museum merely as an instrument of popular education. But this is only one of its lesser functions. Its main value lies in the fact that it is the repository of type-specimens of the majority of the determined species of animals and plants. In these days of the energetic development of newer lines of research in zoology, it must never be forgotten that systematic zoology is the basal science, the pre-requisite for successful advance in any other branch of the subject.

Just as it is necessary that standard measures of length, weight, etc., should be stored in some central repository, so it is necessary that there should be a central institution in which every biologist should be able to determine accurately the species with which he is working. The agriculturists of Mauritius are bothered by an insect pest which they regard as identical with one of the common insects of the island. Measures are taken for its extermination, and these prove unsuccessful. It is then discovered, on reference of the matter to South Kensington, that the pest is a foreign one accidentally imported from the West Indies! Examples of this kind could be multiplied indefinitely, but one more may suffice. The fishery authorities of South Africa desired to introduce the tering into their coastal waters, but the experts at South Kensington were able to point out that, although different species of herring exist in various parts of the world, in both northern and southern hemispheres and east and west, yet all these species are confined within the limits prescribed by two isotherms of annual temperatures, and that South Africa lies outside these limits; so that if herring were liberated near its coast, they would, if they survived, at once swim southward into cooler waters.

The supreme government of the two museums at Bloomsbury and South Kensington is vested in three principal trustees, viz. the Archbishop of Canterbury, the Chancellor of the Exchequer, and the Speaker of the House of Commons, not one of whom has any necessary connection with or knowledge of science.

The scantiness of this knowledge may, indeed, be gauged by the scornful remarks made by the Speaker during the war in reference to the alleged purely

academic interest of studies on Microlepidoptera at the very time that the War Office was imploring the aid of specialists in this department in fighting a pest which was destroying its stores of biscuits.

The article in NATURE advocates placing the museum under the control of a Government Department—"Timeo Danaos et dona ferentes." It seems to me that the ideal of the present Government, viz. a small committee of broad-minded men, is the correct one; only the *personnel* requires to be changed.

It has been cynically observed that the constitution of the present committee was chosen at a time when the Archbishop, the Chancellor of the Exchequer, and the Speaker were the three men in England least likely to be bribed. If for them were substituted the presidents of the Royal Society, of the Zoological Society, and of the Geological Society, the control of the museum would be in the hands of a committee of scientific eminence, and one peculiarly susceptible to the pressure of scientific opinion.

In view of the unique importance of the collections, it is surely essential to have a distinguished man of science presiding over each division of the collection, and for the services of such a man the museum ought to be in a position to pay generously. In the past the museum has been far better served than it deserved to be; it has, in fact, exploited the scientific enthusiasm of young men. In the long run, however, low pay will evoke inferior service. As the present holders of positions in the museum die or resign, clever men will be reluctant to step into their places if to do so means to embrace a life of poverty. A governing body such as I suggest would be in a far better position to estimate the real value of the services of these experts than one which is too much inclined to regard them as a set of obscure academic recluses.

E. W. MACBRIDE.

Royal College of Science, Zoological  
Department, South Kensington,  
London, S.W., March 12.

THE leading article in NATURE of March 11 on "The State and the National Museums" directs attention to a reform the need for which has been increasingly felt by those especially interested in our great national museums. Your summary of their haphazard history explains why their relation to the Government is out of date; why between them there is an overlap which, despite the advantage of competition, causes waste and inconvenience and is a hindrance to efficiency; and why our Museum of Natural Science is administered by a board of trustees planned—so far as it was planned and has not been a fortuitous aggregate of distinguished men—in reference to the library and departments at Bloomsbury. The titles of the museums are a product of this erratic growth and misleading to the public; the Natural History Museum is actually the British Museum of Natural Science, since, according to recent usage (*cf. e.g. Webster's Dictionary*), natural history is restricted to zoology, or perhaps to biology, while the adjacent museum is the British Museum of Physical Science.

Dissatisfaction with our museum administrative system has been clearly growing for years, but there has been no particular opportunity to secure reform or to organise a sufficient body of opinion to convince the Government of its need. Now, however, the establishment of the Department of Scientific and Industrial Research has provided an organisation to which the management of the scientific museums might be appropriately entrusted.

The suggestion, however, to extend that Department so as to include all learning and research requires cautious consideration, since it would throw on that



Department duties so dissimilar as the management of scientific and artistic collections, and would jeopardise its scientific position. One great advantage of that Department is that it provides one strong and influential organisation devoted to the development and utilisation of science; but if it had to control all literary and classical research its aims would be diffuse, and pure science, between the claims of the "humanistic" and industrial sections, might fare poorly.

To unite all our museums, artistic and antiquarian, classical and commercial, scientific and military, under one control would maintain the practice that a museum is a "raree" show, and be inconsistent with the modern principle that a museum is primarily a laboratory of which the general policy should be determined by the authorities in its own department of knowledge. To place a technical or research museum under the Board of Education is as anomalous as to place some other museums under a research department. There are museums in London—for example, that at Bethnal Green—which would be appropriately managed by the Board of Education or by the Education Committee of the London Country Council as the demonstration department of the East London schools.

The foundation and original endowment of the British Museum by a State lottery introduced into British museum policy a virus of chance, which has since been a potent factor in the development of the museums; but a commission of inquiry might now secure sufficient support to establish them on a firmer foundation and utilise the unique opportunities of London as the home of a well co-ordinated group of world-representative museums. The present medley, in spite of its unrivalled material, is being outclassed by the museums of America. J. W. GREGORY.

4 Park Quadrant, Glasgow.

THOSE who have long viewed with increasing irritation the waste of time, labour, and money involved in the present unco-ordinated condition of our national museums will welcome the leading article in NATURE for March 11, in which you have with such justice expounded the situation and indicated a possible solution of our difficulties. It is a little dangerous for a Civil Servant to express a candid opinion on the workings of Government Departments, but perhaps I may be allowed to go outside that taboo area and to point out that the duplication of work and the competition for specimens to which you have alluded affect all the museums (including art galleries) of the country. Some of us, therefore, have come to the conclusion that these also should be co-ordinated with the national institutions and knit into a single scheme. There need be no interference with the existing direction of each museum, but there could be much organised help.

We of the geological department of the British Museum do, in a small, disjointed way, try to help our colleagues of other museums, and we receive help from them. But this is just enough to let us imagine what could be done if such mutual aid were placed on a recognised footing; if, for instance, the small band of museum palaeontologists of Great Britain (and Ireland?) was so organised as to cover the field, and so employed that each specialist could help and advise on his own subject in all museums as part of his official duties. At the first meeting of the Museums Association in 1890 a committee was appointed to consider some such co-operation, but little practical result has ensued, not for lack of goodwill, but because existing conditions stand in the way. What applies to palaeontology applies to all other branches of knowledge. But this is only one of the improvements that might spring from a reform such as we have in view.

Many other good results there could be, among them, perhaps, a better training for curators. But that the results shall be good it is necessary for the directing board to be composed of men with museum sympathies and experience. Therefore, whether the Ministry be that of Education or some new Ministry of Learning and Research, it should exert its financial or other control over museums through a special museum board. In this way those branches of museum work which do not meet the public eye would run less risk of being overlooked. Any large natural history or other science museum is part of the armament employed by man in his unceasing warfare against the forces of Nature. Intellectually and economically that is its main purpose. As the Earl of Crawford, in replying for the Government on the debate raised by Lord Sudeley, rightly said: "It is not the popular guide-books, but the technical and specialised publications issued by museums which really count. They are of vital importance." Visits to a museum, like visits to a battleship, may be of high educational value, especially under the guidance of a qualified demonstrator, but—well, the inference is obvious. Only one point needs emphasis. Museums, no less than battleships, should be under the administration of those familiar with the principles and methods of the respective warfares.

F. A. BATHER.

Wimbledon, March 13.

THE relation of the State to the national museums, and of the latter to each other, discussed in NATURE for March 11, is a matter calling for very careful consideration at the present time. A Ministry of Learning and Research, such as is there suggested, would render very useful service if it could (1) see that the governing body of each institution was composed of persons duly qualified for their work; (2) define the scope of each institution, so as to diminish the risk of competition for desirable specimens, and to provide each with a definite piece of work for the benefit of the community; (3) provide each institution with a due proportion of financial assistance; and (4) arrange such a scale of salaries as would ensure the appointment and retention of the brains best adapted for the purpose in view. At this point central control should cease, and each governing body be left to do its own work, with the assistance of its staff.

The proposal to place museums and libraries under the Board of Education, to which the article alludes, has no reference, I believe, to national museums, but I should like to place on record my strong disapproval of such a step. A museum has many duties to perform, and education in the sense in which the Board deals with it is only one, and not the most important, of them. On the basis of a very extensive acquaintance with provincial museum curators, I have no hesitation in saying that they are fully alive to the educational possibilities of their work. Many of them have rendered valuable service to the education authorities of their localities, and many more would have done so had they been permitted; but this does not prevent them from seeing that their museums have other functions to perform which do not fall within the purview of education committees as at present constituted. In the first place, they are storehouses of material for enlarging the bounds of human knowledge; secondly, they provide objects of interest and beauty for the intellectual and aesthetic contemplation of the citizen; and, thirdly, they furnish material for the university student, post-graduate and undergraduate, as well as for children of school age.

May I say in conclusion that, in my opinion, the

chief thing that is wrong with museums, national and provincial, is (as Bernard Shaw says of the poor) their poverty?

WM. EVANS HOYLE.

National Museum of Wales, Cardiff,  
March 15.

In the timely and suggestive leading article on museums in NATURE of March 11 there are references to the Museum of Practical Geology that need explanation, not because they are incorrect, but because they are symptomatic of that forgetfulness of the fundamental purposes of this museum which has long been obvious in some quarters.

It is true that "the Museum of Practical Geology was a necessary concomitant of the Geological Survey," but this was not, and never has been, its sole *raison d'être*. It was founded as the Museum of Economic Geology—that is, of economic geology in its broadest aspects. It had, therefore, from its inception two functions to perform: (1) To serve as the storehouse and exhibition for all the concrete documentary material collected during the making of the geological maps—material of the greatest value as a demonstration of the facts of British geology and usefully employed for educational, industrial, and purely scientific purposes; and (2) to act as the national repository of material illustrative of all those mineral resources that form the basis of mining, metallurgical, and other industries.

The first of these functions is purely British in scope, the second is world-wide.

As regards overlapping with the Natural History Museum, there is none; and alternatively, as the lawyers say, if there is any it should cease, since the functions of the two institutions are clearly differentiated. The scheme of the geological and mineralogical departments of the Natural History Museum is academic, and that of the Museum of Practical Geology economic. On the other hand, the Imperial Institute in respect of its mineral exhibits does overlap the functions of the older institution. This is a question requiring attention in any scheme of reconstruction.

WILLIAM G. WAGNER.

March 15.

### Some Methods of Approximate Integration and of Computing Areas.

ENGINEERS and shipbuilders are continually requiring to find the area of a surface bounded by curved lines. If both the upper and lower boundaries are curved, it is a simple matter to divide the surface into two by a straight line, find the area of each part separately, and add them together.

Simpson's rule is almost universally used for this purpose, but a little consideration will show that a more accurate evaluation of the area can be obtained in most cases by using other rules.

We will consider an area contained by a base line, two vertical ordinates at the ends, and a number of intermediate ordinates placed at equal distances along the base line. If the base line be divided into  $m$  equal intervals, each of a length  $h$ , there will, of course, be  $m+1$ , or  $n$ , ordinates. When the height of these ordinates is known, and the value of  $h$  the interval also, an approximation to the value of the area can be obtained which increases in accuracy with the number of ordinates taken and measured, when the curve is of an anomalous shape.

(1) If the upper boundary be a straight line, an exact result will be obtained by merely the two end ordinates  $y_1$  and  $y_2$  and the length of the base line  $h$ :  
 $A = \frac{1}{2}h(y_1 + y_2)$ .

(2) If the upper boundary be a parabola, an exact

result will be obtained by bisecting the base line, and then

$$A = \frac{h}{3}(y_1 + y_3 + 4y_2),$$

where  $h$  is half the base line.

This is Simpson's well-known rule: If any odd number of ordinates be taken, say 7, it is considered as a succession of three areas bounded above by three parabolas, i.e. the area from  $y_1$  to  $y_3$  is added to the area from  $y_3$  to  $y_5$ , and this, again, is added to the area from  $y_5$  to  $y_7$ . The formula used is then

$$A \approx \frac{h}{3}[y_1 + y_7 + 2y_3 + y_5 + 4y_2 + y_4 + y_6].$$

If  $m$  denote the number of additional areas computed by this method, the general formula will take the form

$$A \approx \frac{h}{3}[y_1 + y_{3+2m} + 2y_{1+2m} + 4y_2 + y_{2+2m}].$$

It should be especially noted that this formula must be used only when the number  $n$  of ordinates is odd and the number of intervals even. In the second and third terms the values 1, 2, 3, etc., are assigned successively to the symbol  $m$ , ending with that value of  $m$  which denotes the number of additional areas that are to be computed. The formula is based on the assumption that  $y = a + bx + cx^2$ , and gives the best possible approximation to the true area if only three ordinates are given.

(3) If, however, four ordinates be given, we may assume that  $y = a + bx + cx^2 + dx^3$ , and the resulting formula based on this assumption,

$$A \approx \frac{3h}{8}[y_1 + y_4 + 3y_2 + y_3],$$

will give the best possible approximation if only four ordinates are given. This formula should be used only when the number of ordinates is  $4+3m$ , and it then becomes

$$A \approx \frac{3h}{8}[y_1 + y_{4+3m} + 2y_{1+3m} + 3y_2 + y_3 + y_{2+3m} + y_{3+3m}].$$

(4) If five ordinates be given, we shall obtain a more accurate result by assuming that  $y$  is a quartic function of  $x$ , and for 5, 9, 13, or  $5+4m$  ordinates the following formula may be used:

$$A \approx \frac{2h}{45}[7y_1 + y_6 + 4m + 14y_{1+4m} + 12y_3 + y_3 + 4m + 32y_2 + y_4 + y_2 + 4m + y_4 + 4m].$$

(5) Similarly, if 6+5m ordinates be given,  $y$  may be regarded as a quintic function of  $x$ , and the formula becomes

$$A \approx \frac{5h}{288}[19y_1 + y_6 + 6m + 38y_{1+5m} + 75y_2 + y_6 + y_2 + 5m + y_5 + 6m + 50y_3 + y_4 + y_3 + 5m + y_4 + 5m].$$

(6) Again, if 7+6m ordinates be given,  $y$  may be assumed to be a sextic function of  $x$ , and we then have the formula

$$A \approx \frac{h}{140}[41y_1 + y_7 + 6m + 82y_{1+6m} + 216y_2 + y_6 + y_2 + 6m + y_5 + 6m + 272y_3 + y_4 + y_3 + 6m + y_4 + 6m].$$

In all these formulæ the first term consists of the sum of the first and the last ordinate. In (2), (3), (4), (5), and (6) the values 1, 2, 3, etc., are assigned successively to the symbol  $m$  in the following terms according to the number of ordinates. Thus if in (6) nineteen ordinates are given,  $19 = 7 + 6m$ , so  $m = 2$ .

When  $m=0$ , the ordinates with  $m$  as a part of their subscript are omitted in all but the first term.

*Example.*—Suppose the base line be divided into six equal intervals ( $h=\frac{1}{6}$ ), and the value of the ordinates be

$$\begin{array}{ll} y_1=0 & y_2=0.5527708 \\ y_3=0.7453560 & y_4=0.8660254 \\ y_5=0.9428090 & y_6=0.9860133 \\ y_7=1 \end{array}$$

As seven ordinates are given, we may use any one of the rules (6), (3) which is adapted to  $4+3m$  ordinates, and (2) which can be used when  $3+2m$  ordinates are employed. We should expect to get a more accurate result when the higher-order formula is employed, and this we shall find to be correct. The values given refer to the quadrant of a circle, so that the true value is  $\pi/4$ , or  $0.78539816 \dots$

By method (6), putting  $m=0$ , the result is  $0.7791866$ , i.e.  $0.7972$  per cent. too small.

By method (3) the result is  $0.7758061$ , or  $1.342$  per cent. too small.

By method (2) the result is  $0.777531$ , or  $1.063$  per cent. too small.

This result is curious, and shows that a small arc of a circle approaches more nearly to a small arc of a parabola than to a small arc of any cubic curve, but it will be noted that method (6) gives a much more accurate result.

We may, however, use a combination of the above rules; for instance, we may take five ordinates by rule (4) and the remaining two intervals by rule (2). As the first three ordinates increase more rapidly than the last three, we should naturally leave the last three to be dealt with by rule (2). In this way a result of  $0.7784954$ , or a defect of  $0.0069027$ , or an error of only  $0.88667$  per cent. is obtained. Had we reversed the order and used Simpson's rule for the first two intervals, the defect would have been  $0.0078447$ , or an error of  $1.0102$  per cent.

In conclusion, it may be stated that if the nature of the curve is unknown a more accurate result will always be obtained by using the highest-order formula that can be used with the given number of ordinates. If two different formulæ are used, it has just been shown that the most accurate result is obtained when the higher-order formula is used for that part of the curve in which the variation of the ordinates is the greater. If the curve be a parabola, an absolutely accurate result is obtained by using only three ordinates by means of method (2).

It may be thought that plotting the curve and estimating its area mechanically by means of a planimeter will be always the best and speediest method to adopt, but this is by no means the case. It often takes far less time to calculate, say, thirteen ordinates and to use method (6) than to trace the curve.

A. S. PERCIVAL.

Westward, Newcastle-upon-Tyne.

**An Electronic Theory of Isomerism.**

THE interesting suggestions made by Mr. W. E. Garner in NATURE for February 19 with regard to a possible explanation of the isomerism of certain organic compounds may be examined from a different, but perhaps simpler, point of view by employing the "ring electron" or "magneton" of Mr. A. L. Parson. The electron is looked upon as a circular anchor ring of negative electricity rotating about its axis at a high speed, and therefore behaving like a small magnet. In connection with atomic and molecular

numbers 1 have directed attention elsewhere to the "rule of eight," according to which a difference of 8 or a multiple of 8 is frequently found between the numbers of the unit electric charges associated with analogous atoms or molecules. In the theory of the "cubical atom" put forward by Prof. Gilbert N. Lewis and developed by Dr. Irving Langmuir, one of the most stable configurations for the atomic shell is that in which eight electrons are held at the corners of a cube. The single bond commonly used in graphical formulæ involves two electrons held in common by two atoms (Fig. 1); the double bond implies that four electrons are held conjointly by two atoms (Fig. 2) Or if the pair of electrons be regarded as the most stable grouping of all, it may be, as Lewis and Langmuir suggest, that the pairs of electrons held in common by two atoms are drawn closer

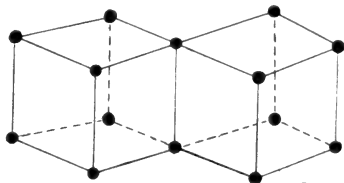

FIG. 1.

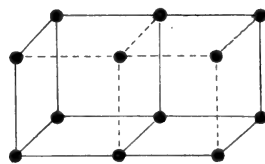

FIG. 2.

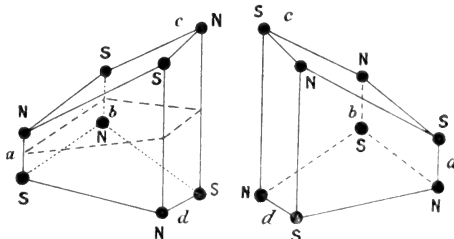

FIG. 3.

together by the magnetic attraction between them. Dextro- and laevo-rotatory forms of a compound might then be represented as mirror images as in Fig. 3. The letters N and S in this diagram may be taken to represent the polarity of the external face of the ring electron.

Mr. Garner suggests the possibility of the existence of a large number of optical isomerides amongst organic compounds, but the view here put forward does not lead to that conclusion; on the contrary, it seems to give exactly the same number of isomerides as the ordinary structural formulæ. It is true that it is possible to reverse in the diagram the magnetic polarity of one or more pairs of electrons, but even if the arrangements so obtained were stable, it is doubtful whether they would represent different isomerides. It would not be possible to explain the phenomenon of free mobility about a single bond

which is assumed in stereo-chemistry if such a reversal of the magnetic axis were accompanied by a change in the nature of the compound. Such modifications, however, might conceivably account for mutarotation. It was thought that in the case of a double bond, such as exists in cinnamic acid, it might be possible to have a larger number of isomerides than would be given by the ordinary theory, but a close examination of the structural formulæ based on the cubical atom has shown that (subject to the limitation already referred to) this is not so.

The view here suggested appears to afford an adequate basis for a theory of optical activity. Such activity arises from a difference effect, and can be manifested only when there is lack of compensation amongst the electrons associated with the various parts of the molecule. If the chemical bond is to be attributed to a pair of electrons, it is easy to understand how such compensation can be brought about in the great majority of chemical compounds. In the case of a single asymmetric carbon atom, the symmetrical arrangement of each of the four electron pairs is disturbed by the presence of the adjacent groups, resulting in only partial compensation. Thus in the compound *abcd*, the pair of electrons associated with group *a* is under the influence of the unlike groups *c* and *d*, and, therefore, cannot be symmetrical. But if *c* and *d* are made alike, the whole molecule will have a plane of symmetry indicated by the broken line in the left half of Fig. 3. Thus the molecule will be inactive through "internal compensation" with respect to the electrons which form the outer shell of the carbon atom. I may add that the ring electron, constrained to move backwards and forwards along its linear axis, is admirably adapted to replace the ordinary electron moving backwards and forwards along a spiral path postulated in Drude's theory of rotatory liquids.

It may be permissible in this connection to emphasise the remarkable success that has attended Langmuir's development of the "octet" theory, by means of which it is possible to predicate the physical and chemical qualities of a substance, and even its crystalline structure. Langmuir states that the theory seems to explain all the cases of stereo-isomerism with which he is familiar. "For example, in the amine oxides,  $\text{NR}_2$ ,  $\text{R}_2\text{N}_2\text{O}$ , nitrogen is quadrivalent, so that these substances exist as optical isomers, just as in the case of a carbon atom attached to four different groups." Such a compound is, in fact, represented by the diagram already given. H. S. ALLEN.

The University, Edinburgh, March 2.

### The Principle of Equivalence and the Notion of Force.

I SHALL be grateful to be permitted to make an inquiry in connection with the principle of equivalence through the medium of the columns of NATURE.

In the recent forms of the theory of relativity it has been asserted that in the neighbourhood of matter we may alternatively conceive the existence either of a field of gravitational force or of a distortion in the space-time continuum, the two conceptions being equivalent. The point then arises, however, as to whether, in arranging the body of ideas and propositions constituting physical science in logical sequence, the idea of force (at any rate, "force" in the sense of "action at a distance") or that of distorted space-time should be regarded as logically prior. The possibility of adopting the idea of distorted space-time as prior, and hence of finally dispensing with the notion of force from the physical scheme, evidently depends on a further generalisation of the principle

of equivalence. For a difficulty seems to arise in connection with other forms of action at a distance, such as the forces in a magnetic or an electrostatic field. Apparently we cannot regard these as equivalent to a space-time distortion, for they lack the universality of gravitation, seeing that only bodies of specific types of material are deflected by them.

I should therefore like to ask two questions:

(1) Is it possible to extend the principle of equivalence in any way so as to include all forms of action at a distance?

(2) If not, is there anything gained, even from a purely logical point of view, by discarding the notion of gravitational force while we are still unable to discard by the same method the notion of certain other forces which in many respects exhibit a close analogy to gravitation? C. A. RICHARDSON.

4 The Crescent, St. Bees, Cumberland,  
March 1.

### Expenses of Scientific Work.

A JOINT committee of the British Association of Chemists, the Institute of Chemistry, and the National Union of Scientific Workers is putting forward the claim that the following expenses should be allowed as a charge against income in arriving at the assessment of those who earn their living either by purely scientific pursuits or by the application of science to industry:—

- (1) Subscriptions to scientific and technical societies and libraries, and to scientific and technical periodicals.
- (2) Purchase and renewal of scientific and technical books, instruments, apparatus, chemicals, and other materials.
- (3) Rent and expenses of study or laboratory.
- (4) Travelling and other expenses incurred in attending scientific meetings.
- (5) Provision of special clothing for work and renewal of clothes damaged in the course of employment.
- (6) Other expenses incurred in the course of research.

A form of memorial to be presented to the Lords of the Treasury is being sent to all bodies representative of scientific workers for their consideration and support.

Some claims for abatements under the above headings have already been made by individuals with varying success. I should be grateful for any information available in support of the petition.

A. G. CHURCH,  
Secretary.

National Union of Scientific Workers,  
19 Tothill Street, Westminster,  
London, S.W.1, March 15.

### Scientific Reunions at the Natural History Museum.

I WRITE to correct a small error that has crept into the note on the meeting of the International Council for the Exploration of the Sea which appeared in NATURE for March 11. When the members of that council visited the Natural History Museum on March 2 they were entertained, not by the Trustees, but by the Staff Association, the occasion being a scientific reunion, as was, indeed, stated in a later note in the same issue. I may add that these reunions are held with the approval and permission of the Trustees.

G. F. HERBERT SMITH,

Hon. Secretary.

Natural History Museum Staff Association.

## The World's Production of Silver.

THE recent action of the Chancellor of the Exchequer in introducing a Bill into the House of Commons for the purpose of debasing the silver currency from 925 to 500 parts per 1000 has directed public attention to the acute shortage of silver which exists. This action is unavoidable if a silver currency is to be maintained, since the price of the metal has risen so much that coins are no longer tokens. They are, in fact, worth to-day considerably more than their face value, and there is, accordingly, a temptation to melt them down and sell them for the considerable profit that the transaction would bring in. Such a procedure is, of course, illegal. In the years preceding the war the market price of silver, while subject to fluctuations, was never far from 2s. per "standard ounce." This expression is rather unfortunate, since it is not the ounce that is standard, but the quality of the metal. Its real meaning is a troy ounce of silver alloy containing 92.5 per cent. of the metal. With standard silver at about 5s. 6d. per ounce, the coins reach parity. During recent weeks the market price has fluctuated between 7s. and 7s. 5d. per ounce, though it is true that a remarkable fall of 6½ in the price took place on March 5, and a further fall of 5½ on March 11, owing largely to the improvement in the exchange with the United States of America. As stated, however, the Chancellor's action is necessary, since the minting of silver coins is possible only at a heavy loss. Nevertheless, this Bill was opposed in the House, although the opposition was not carried to a division.

It so happens that in January this year the report and appendices of the Committee appointed by the Secretary of State for India to inquire into Indian exchange and currency were published and presented to Parliament. In vol. iii. will be found appendix xxx., which contains a report on the world's production of silver.<sup>1</sup> This is the work of Prof. C. Gilbert Cullis and Prof. H. C. H. Carpenter, who at the request of the Secretary of State for India undertook an inquiry more than a year ago into the output of silver during recent years in the various silver-producing countries; the prospects, so far as they could be estimated, of future output; and the causes by which it is likely to be influenced. Their report covers some sixty foolscap pages. The subject-matter is presented in five main sections dealing severally with the raw materials from which silver is obtained, the location and quantitative importance of centres where silver-bearing ores are mined, the processes involved in the extraction of the metal, the distribution and relative importance of the centres where refining is carried out, and the conclusions affecting the supplies and price of the metal.

It appears from this report that in 1860 the

world's production of "fine"—i.e. pure—silver was 30 million ounces. With some fluctuations this increased steadily until 1912, when the output was 233 million ounces, or nearly eight times that of more than half a century earlier. From that date, although a continuance of the upward trend was to be expected, a decline in production set in and continued down to the end of 1917, which was the last year for which complete figures are available. It is clear from the report that this reduction in output is assignable not to any sudden failure of the world's resources, but to an interruption in the winning of them.

The main source of the sunbly of silver ore is the American Continent, which in 1912 produced 82.5 per cent. of the total output. Approximately three-quarters came from North America and Mexico, the former furnishing 42 per cent. and the latter 32 per cent. Mexico was the largest single producer. A decrease in Canadian production had set in shortly before this, due to the progressive exhaustion of the Cobalt mines, but this was more than compensated by an increase in the production of the United States. The key to the shortage of the world's supplies is to be found in Mexico, where, owing to a series of political revolutions, the production fell from an average of close upon 74 million fine ounces for the years 1910-13 to an average of little more than 30½ million fine ounces for the years 1914-17, a reduction of some 43½ million out of a total reduction of 50½ million ounces in the world's output.

This serious diminution in the supply came at a time when, owing to the withdrawal of gold from circulation on account of the war, there was an unusually keen demand for silver, particularly for coinage purposes. The report of the Currency Committee points out that the coinage of the British Empire absorbed nearly 108 million ounces of fine silver in the years 1915-18, as against 30½ million ounces in the years 1910-13, and there is evidence that there have been similar increases in the coinage of other countries. Moreover, whereas China from 1914-17 was a seller of silver, and her net exports amounted to more than 77 million ounces, she has since become a persistent buyer, and the recent remarkable rise in the price of the metal is due to her purchases. India has for many years been a heavy buyer of the metal, and in times of normal trade was the largest importer of this commodity. War conditions have accentuated this, and in the three fiscal years April, 1916, to March, 1919, purchases for the purpose of liquidating trade balances amounted to more than 500 million ounces, which was probably very nearly the entire world's production for the period. These have been the chief (but not the only) factors in raising the price of silver to its extraordinary level.

It is clearly seen from the report that silver is mainly obtained as a by-product from mines which are worked for some other metal or metals.

<sup>1</sup> Vol. iii., Appendices to the Report of the Committee appointed by the Secretary of State for India to inquire into Indian Exchange and Currency. No. xxx., "Report on the World's Production of Silver." By Prof. H. C. H. Carpenter and Prof. C. Gilbert Cullis. Pp. 182-241.

Relatively few properties are worked solely or even mainly for silver, and only a small proportion of the world's supply has of late years been derived from them. It is therefore essentially a by-product. The more important economic metals with which it is most commonly associated are gold, copper, lead, and zinc. These five metals tend to be gregarious, and many deposits contain all of them. It is also found with tin, as in Bolivia, and with nickel and cobalt, as in Ontario, but such cases are uncommon. Although in different regions or in different parts of the same region the above five metals are found in a great variety of combinations, certain of these are particularly common. Thus gold and silver almost invariably occur together either with or without base metals. Again, lead and zinc nearly always accompany each other, and ores carrying these two metals, notably those in which lead predominates, are often richly argentiferous, the lead and silver forming an especially characteristic association. Copper in like manner is usually accompanied by small quantities of gold or of both gold and silver. The presence or absence of base metals in silver-yielding ores is of particular importance, since it determines the existing diversity in their metallurgical treatment and occasions their classification into two groups, known respectively as "milling ores" and "smelting ores," the former signifying those in which the values are entirely or mainly in precious metal. From the figures quoted in the report, it appears that, broadly speaking, about two-thirds of the world's supply of silver in 1912 was obtained from base metal, and one-third from precious metal, ores. Further, only one-fifth was obtained from mines worked exclusively for silver, while four-fifths was derived as a by-product from mines which were worked primarily for one or more of the metals—gold, copper, lead, and zinc—and would not have been in operation if their silver had been the only metal present. Formerly, the precious metal ores were the more important source of supply, but in the last few decades more and more of the metal has been won from base metal ores. It will be seen, therefore, that the authors, in endeavouring to estimate the future production of silver, have been forced to take into consideration the mining and metallurgy of four other important metals as well.

It is stated in the report that in 1912 the New World—i.e. the American Continent—furnished 82.5 per cent., and the Old World only 17.5 per cent., of the mine production of silver. The output in the British Empire was 21.7 per cent. Mexico led with 32.0 per cent., followed closely by the United States with 28.3 per cent. Towards the production of refined silver the New World contributed 73.0 per cent., and the Old World 27.0 per cent., the contribution of the British Empire being 18.2 per cent. The interesting fact emerges that the United States of America refined just about one-half the world's silver (49.6 per cent.), whereas Mexico refined only 14.2 per cent.

NO. 2629, VOL. 105]

More than half the Mexican mine production was refined in the U.S.A., and very nearly the same proportion of the Canadian output. It will be seen, therefore, that the position now held by the U.S.A., as the chief source of supplies of refined silver, is one of considerable importance. The same is true to an even greater extent for the metals copper and zinc.

The authors' view of the future is that if normal industrial conditions are restored in regions of curtailed production, a silver output at least as great as any yet attained may reasonably be anticipated. If, however, conditions affecting industry in general, and mining and metallurgical industries in particular, do not become favourable in these regions, a long period must elapse before the world's output can return to the previous high-water level, and a still longer one before the advance beyond that level interrupted since 1912 can be resumed. So long as the political conditions remain unsettled in Mexico, supplies from that country will continue to be small. This is particularly serious, because of the large dimensions of the normal Mexican output.

With the demand for silver more urgent than any previously experienced, the restoring of the mines and mills of Mexico to unhampered production has become a matter of pressing international importance. It must be borne in mind, however, that any extension in the mining of precious metal ores will take time, and that the mining of base metal ores is for the moment below normal, and will continue so as long as the surplus supplies of copper, lead, and zinc produced during the war remain unabsorbed. Silver production will probably, therefore, remain for a time at a low level. When, however, increased precious metal mining reaches the production stage, and the temporary check to base metal mining has been removed, the authors anticipate a steady increase in the output of the metal.

It is well to remember that, although silver has long occupied an important position as "second string" among metals suitable for currency, there are important industrial demands for it for other purposes. It is only necessary to mention two of these. First, in addition to the mechanical properties which make it valuable as a currency metal, there are others which have long been known and utilised in the silversmith's art. Standard silver lends itself readily to rolling, stamping, spinning, and mechanical operations employed in the manipulation of the metal in the arts, and upon them important industries giving employment to many workers are based. Secondly, the well-known sensitiveness of silver salts to light, made use of in photography, is being increasingly utilised in the "moving picture" industry, which in recent years has absorbed a considerable proportion of the total output of the metal. Both these industries are formidable competitors for silver produced to-day, and they will have to be reckoned with by future Chancellors of the Exchequer.

## Time-reckoning of the North American Indians.

UNDER the title, "Calendars of the Indians North of Mexico" (University of California Publications in American Archaeology and Ethnology, vol. xvi., No. 4), Miss Leona Cope has collected and arranged a large amount of information dealing with the divisions of time in use among the Indians of North America, including much linguistic material. The term "calendar" must be taken in a very elastic sense, for the Indian's power of keeping account of an interval of time is usually limited to two or three years, and never went so far, apparently, as even to fix the number of days in a month. The only general rule seems to be a complete absence of uniformity, variations of system being found even among the most closely related groups. The basic period is naturally the lunation, indicated by an expression which is related etymologically, without exception, to the moon, and reckoned generally from new moon, but in some cases from full moon. The month is sometimes divided into "weeks" roughly depending on the lunar phases, but very variable in length and number. In general, the seasons are vaguely marked periods not directly connected with the months, though the latter are sometimes divided into a summer and a winter series. When the wide range of latitude in the area is considered, a corresponding variety of practice is natural enough. Thus it is not surprising that the Greenland Eskimo find a convenient division of the day in the ebb and flow of the tides, or that a Point Barrow Eskimo should say that there are nine "moons," and after that no moon, but the sun only. But the varia-

tions within connected groups make the study a complicated one.

This appears especially in the attempts to connect the series of months with the year. For the most part, covering the whole of the eastern and central region, there is no astronomical foundation. There is no uniformity in the time of beginning the year. In general, twelve months are recognised and are designated by purely descriptive names associated with some seasonal event. Some tribes have thirteen or even more months, but the mode of adjustment is quite crude, a month being sometimes intercalated or omitted only when a palpable discrepancy with the seasons shows the need. Only in the south-west, along the Pacific coast, and among the Eskimo of the far north is an astronomical element introduced. This takes the form of observing the winter solstice; the equinoxes, if recognised, are never used for the purpose. A particular variation in the naming of the months takes a numerical form. This occurs on the Alaskan coast and further south; only two tribes have a complete system of this kind, while a third is unique in combining numbered months with a solstitial basis. Ritual ceremonies are also represented in the names of the months among western tribes. Apparently, the Kaniagmiut Eskimo are alone in naming months from the rising of the Pleiades or Orion. Altogether the astronomical element in this complex subject is small, and the present memoir, which contains three maps representing the regional distribution of different types or systems, has its chief interest on the linguistic side and as a study of primitive culture.

## Obituary.

DR. CHARLES GORDON HEWITT.

THE premature death of Dr. Charles Gordon Hewitt, Dominion Entomologist of Canada, who succumbed to an attack of pneumonia, following influenza, on February 29, is a serious loss to biological science. To an aptitude for field observation cultivated from his earliest youth, Dr. Hewitt added knowledge and skill in the latest laboratory methods. While eagerly devoting attention to the numerous economic problems which came before him, he always appreciated the necessity for constant purely scientific research. He worked, indeed, in the most favourable circumstances, and made the best use of his opportunities.

Born near Macclesfield in 1885, Dr. Hewitt passed from the local grammar school with a scholarship to the University of Manchester. After graduating with honours in zoology, he was appointed assistant demonstrator in that science, and when a new department of economic zoology was founded at Manchester, he became the first lecturer. During this period he hired a greenhouse and made an exhaustive study of the life-

history of the house-fly, which formed the subject of his thesis for the doctorate. He was a pioneer in such work in this country, and his general results were eventually published in the form of a Cambridge manual. At the same time he undertook researches on the large larch saw-fly, which was ravaging the plantations of the Manchester Corporation round Thirlmere. He was also interested in the feeding habits of certain insectivorous birds.

In 1909 Dr. Hewitt was appointed entomologist to the Dominion of Canada, and at once began to organise laboratory work on the lines which he had already proved successful. He also paid much attention to the improvement of the law relating to injurious insects. Gradually his interests widened, until in 1917 he increased his responsibilities by accepting the post of consulting zoologist to the Canadian Commission of Conservation. He took an active part in the work of the Commission, and contributed several papers on the protection of mammals and birds

to its annual reports. His advice was duly appreciated and considered in framing legislation.

Dr. Hewitt was a corresponding member of the Zoological Society of London, and he received the gold medal of the Royal Society for the Protection of Birds.

By the death of SIR ROBERT MORANT at the early age of fifty-seven the Civil Service loses one of its ablest and most remarkable members. His great powers of organisation found full scope for their exercise when he was, in 1902, appointed Secretary of the recently created Board of Education. The appointment was well merited, for it was to his indefatigable industry in supplying material, to his skill in dealing with details, and to his ingenuity in overcoming difficulties that the Education Bill of 1902 was safely carried through Parliament. As permanent head of the Board of Education his restless energy and ceaseless activity bore down all opposition, and made him ready at all costs to carry out his own ideas. Organisation was indeed with him a ruling passion, and the smooth working of a complicated machine tended to become more important than the purpose the machine was intended to serve. During the ten years that he held the post of Secretary he served under five different Presidents, and the rapid succession of his temporary chiefs was not altogether unconnected with his own remarkable tenacity of purpose and skill in carrying it into effect. While his undoubted talents and magnificent powers of work have thus left their mark on the educational system of the country, it still remains to be seen if the vast and expensive machinery he called into existence will be more of a help than a hindrance in the development of our national education. In 1912, on the appointment of Mr. J. A. Pease as President of the Board of Education, Sir Robert Morant was promoted to the chairmanship of the English Commission formed under the National Health Insurance Act. He lived to see the early opposition to this Act gradually die away, and the Act itself become part of a great scheme of health legislation. To this Commission he devoted the same power of organisation and intensity of effort, and his early death is probably largely owing to his unsparing use of these great talents in the public service.—C. A. B.

THE death is announced of the veteran Italian botanist, DR. PIER ANDREA SACCARDO, emeritus professor in the Royal University of Padua. Born at Treviso in 1845, Prof. Saccardo joined the Royal Botanic Garden of Padua in 1866 as assistant director, and in 1878 became director—a post which he retained for the remainder of his official life. He was also professor of botany in the Royal University. He is best known for his systematic work on the fungi; his "Sylloge Fungorum omnium hucusque cognitorum" has been, since the publication of vol. i. in 1882, the working handbook of systematic mycology. Succeeding

parts or volumes appeared at intervals, the last, vol. xxii., in 1913; other eminent mycologists have co-operated in this great work. Prof. Saccardo also published numerous separate memoirs dealing with the fungi. His "Notæ Mycologicae" was a series of descriptive papers in various journals devoted to mycology from 1890 to 1916, when series xx. appeared in the *Nuovo Giornale Botanico Italiano*. But his activities were not limited to the fungi. Under the title "La Botanica in Italia" (1895, 1901), an exhaustive compendium of Italian botanists and their work from the Roman epoch onwards, he made a valuable contribution to botanical bibliography. In 1909 he contributed a supplemental volume to the "Flora analitica d'Italia" (by Fiori, Paoletti, and Béguinot), entitled "Cronologia della Flora Italia," a systematic list of the earlier records of the species of ferns and flowering plants, native or naturalised in Italy. Prof. Saccardo was also the author of a pamphlet, "Chromotaxia," on colour nomenclature, for the use of botanists and zoologists. In recognition of his eminent services to botany he was elected in 1916 a foreign member of our own Linnean Society.

WE regret to note that *Engineering* for March 5 records the death of MR. WILLIAM RICHARDS WILLIAMS on February 23. Mr. Williams studied engineering at the Royal Engineering College, Coopers Hill, and was appointed in 1887 assistant engineer to the Public Works Department by H.M. Secretary of State for India. His work in India was chiefly connected with irrigation. In 1901 he was appointed to the Irrigation Service in Egypt, and ultimately became Inspector-General of Irrigation, Lower Egypt. Mr. Williams had been a member of the Institution of Civil Engineers since 1906.

WE have received from Dr. Angel Gallardo, now president of the Argentine National Council of Education, a copy of his obituary notice of DR. F. P. MORENO in *El Monitor de la Educación Común* (Buenos Aires, December 31, 1919). Dr. Gallardo gives some account of Dr. Moreno's later work for education, to which we briefly referred in *NATURE* for January 15, and emphasises especially the importance of his efforts to provide for the children of the poorer classes. Among other institutions, Dr. Moreno established the Boy Scouts in Argentina. The notice is accompanied by an excellent portrait, which is, however, a little blurred in the printing.

WE much regret to see the announcement of the death, on March 13, in his seventy-eighth year, of PROF. CHARLES LAPWORTH, for many years professor of geology and physiography in the University of Birmingham.



## The Gyrostatic Compass.

BY S. G. BROWN, F.R.S.<sup>1</sup>

I HAVE directed attention to several faults that have to be rectified if the compass is to be of use on a ship, and I shall now discuss the last, but by no means the least, of the errors that may arise if the instrument is not properly designed. This error was not known when the gyro-compass was first brought out, and it proved a most difficult fault to correct, while its elimination has had more to do with the design of the later forms of gyro-compass than any other factor.

If a gyro-wheel is precessed towards, and kept pointing to, the north by an ordinary pendulum weight, it will work well on board ship provided that the ship is steaming on a fairly smooth sea; but if the direction of the ship points anywhere in the quadrants—that is, north-west or north-east, south-west or south-east—and the ship rolls, the wheel will try to set itself so as to bring the rim of the spinning wheel in line with the roll; and in a long-continued and heavy roll the compass may show an error of 20° or more—a most serious fault, and one that would render the instrument quite useless in a heavy sea. This error is called the "quadrantal error." The extent of the error depends upon the violence of the ship's rolling and the direction of the axis of the wheel. If the ship points direct north, south, east, or west, the error is nothing, but it would be a maximum in any of the directions before mentioned.

I think Anschutz was the first to point out the error and suggest a cure. This I gather from one of his publications in the year 1911, in which, speaking of the tendency of the compass to wander when on board ship, he says:—"Theoretically, the influence of rhythmic turning movements on a gyroscopic apparatus must disappear completely if not only the real, but also the apparent, movements of inertia of the movable system become equal for each plane."

If we go back again and study our simple gyro-compass, we see that the movable system is not symmetrical. In the direction of the axis of the wheel the effect of tilting movement is more or less resisted by the spinning wheel—this may be termed the stabilised direction; while at right angles to this—that is, in the direction of the rim of the wheel—there is no resistance to tilting encountered, and this direction we term the direction of free swing. A simple form of gyro-compass pointing, therefore, in a direction, say, north-west on board a rolling ship has a force applied to it tending to turn it so as to bring its direction of free swing into line with the roll.

Anschutz gets rid of the error by multiplying the number of his gyro-wheels and by making the instrument as symmetrical as possible. In England the quadrantal error was first discovered and studied, I believe, by the Admiralty Compass Department. In the year 1914 the Sperry Co. claimed to have effected a cure for the error by attaching the pendulous weight, not directly to the gyro casing, but through a pin arranged to move in a slot in the casing. In order that the axis of suspension of the pendulum may remain vertical when the compass oscillates with the rolling of the ship, a small auxiliary gyro was employed to stabilise the pin connection between the pendulum and the gyro casing.

We therefore see in these applications of Anschutz and Sperry two general ideas. In the first case the idea is to make everything symmetrical, like a ball, so that there is no stabilised or free swing direction

to the wheel, and; therefore, no tendency to turn; while in the second a method is provided to prevent the point of application of the pendulum weight from moving and acting as a crank, and, by keeping the pendulum weight always vertical in the north-west direction, to destroy its power of turning the compass. In the Brown compass the quadrantal error is eliminated by making the weight operate completely out of phase with the roll—that is, at 90° displacement.

If a gyro-compass is worked by a weight which tends to precess the wheel in phase with the roll, then there must be a quadrantal error, but there will be no error if it is forced to operate completely out of phase with it. It is also essential, as Anschutz has remarked, that the real moments of inertia shall be the same in all directions of the movable system of the compass; that is to say, the moving system should be in dynamic balance, as it is termed.

If a child's hoop is suspended by a string and is swinging in one direction, the hoop tends to set itself lengthwise to the direction of the swing. On the other hand, if an exactly similar hoop be placed over, but at right angles to, the first, and suspended as before, then on swinging the hoops there will be no tendency for them to turn, as they are now in dynamic balance. It is for this reason that the mass distribution of the moving system of the gyro-compass should be in dynamic balance, and to carry this out adjustable weights are fitted, usually in the direction of the spindle of the wheel, to counteract the weight of the supporting ring of the gyro casing, and thus there is no tendency for the compass to turn, due to this cause, when under the action of rolling.

The Brown gyro-compass is shown diagrammatically in Fig. 4. A is the gyro-wheel in its casing B. This case is carried on knife-edges M in the vertical ring F, and is thus free to tilt under the action of the rotation of the earth. The vertical ring turns in azimuth on a frictionless mounting, consisting of an oil-pump at the bottom and a ball-bearing, *m*, at the top. XY is the three-phase motor that drives the oil-pump.

The gyro-wheel is the rotor of a three-phase motor, and current is led into the moving system through the three sets of iron contact rings R and S. These rings do not touch, but the outer set are hollow, and mercury fills the space between them, so that there is little friction. The vertical ring is dynamically balanced by two projecting weights D. Q is the pendulous mounting, supported by gymbal rings and by the outer row of springs to take up shock.

The gyro-wheel runs at 15,000 revolutions per minute, and thus acts as a powerful blower, giving an air-pressure equal to some 3 in. of water. Fixed to the vertical ring, but connected through the hollow bearing M to the inside of the case, is the air-jet L. This jet blows into the two halves of the air-box K, and thence through the pipes I; the air-pressure is thus transmitted to the oil in the two sets of bottles C and D. H is another air-jet similarly mounted, and employed to act upon a pair of contact-making vanes I.

The contacts I, through the agency of the controller, which is fixed on the switchboard, are to work the repeaters and the step-by-step motor V; this motor forces round the follow-up ring N to keep the contact-making vanes I always opposite the air-jet, and in doing this all the repeaters on the ship follow suit. U is the compass card fixed to the upper por-

<sup>1</sup> Discourse delivered at the Royal Institution on Friday, January 30. Continued from p. 48.

tion of the vertical ring, and O the lubber-line support.

By removing the four screws marked *n* the gyro-compass can be completely removed from the gymbal rings. The instrument thus removed is shown in Fig. 5.

To explain the action of the oil bottles I have introduced Figs. 6 and 7.

Fig. 2 illustrates the simplest form of compass, in which the wheel and case B are controlled by the pendulous weight W. When the case tilts, as shown, W is moved to one side of the vertical support, and the weight tries to bring the case again to the horizontal.

Suppose the wheel revolves in the direction of the arrow *a*, the righting torque is in the direction of the arrow *b*; then the wheel and case will turn in azimuth in the direction of the arrow *c*. Such a compass would

other. At the middle of swing of the pendulum the air-jet is at the middle of the air-box, and there is no difference of air-pressure, and, therefore, no movement of the oil; and when the swing is at the end of its path, and not moving, the air-jet is at one side of the air-box and producing the maximum movement in the oil; it will therefore be seen that the movement of the pendulum and that of the oil are out of phase with each other. It is for this reason, given good dynamic balance, that there is no quadrantal error whatsoever with this method of control.

Fig. 7 illustrates the method of damping the compass. Fixed to the same air-box K are the two damping bottles C, C, smaller than E, E, but the air here acts in the opposite direction to that in Fig. 6.

In one of these damping bottles is the adjustable needle-valve, and this valve has a constricted passage,

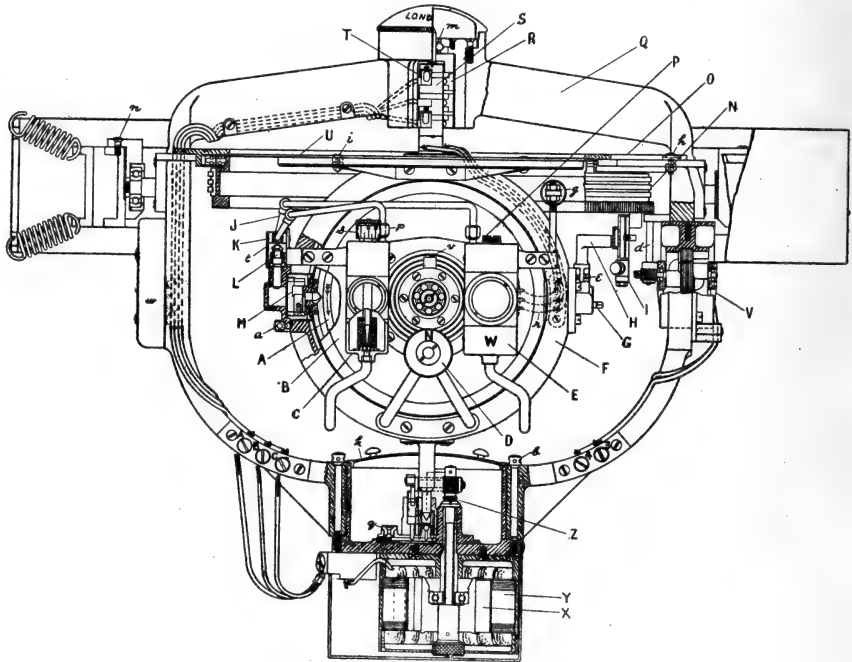

FIG. 4.

have a quadrantal error, because the weight W would produce stresses in phase with the roll.

Fig. 6 illustrates the method of control of the Brown compass. When the case B is horizontal the bottles E, E are half-full of oil, and the air-jet L is blowing equally into the two halves of the air-box K; but when the case tilts, as shown, then the air-pressure blows into one side of the box more than into the other, and in such a direction as to force the oil from the lower bottle into the one raised. There is, therefore, a considerable righting torque indicated by the weight of the oil W trying to restore the case back again to the horizontal.

When the pendulum swings under the action of the rolls of the ship, the air-jet L moves from one side to the other of the air-box in tune with the roll, blowing the oil periodically from one bottle to the

and thus the flow of oil from one bottle to the other is suitably retarded.

As regards the accuracy of the compass, I may mention that one on board a flagship in the North Sea during the war was observed with particular care, especially during very heavy weather, and it was reported that it was never more than  $1\frac{1}{2}^\circ$  from the true north position during the whole of the tests.

Trials on a commercial ship have demonstrated the fact that the employment of a gyro-compass resulted in the ship steaming every day more than 3 per cent. greater mileage; in other words, one day's steaming in thirty would be saved, resulting in a proportionate saving in coal and all other expenses.

I come now to a most important application of the gyro-compass, namely, its employment as a gun director.

The use of the gyrostat in the Whitehead torpedo has revolutionised naval strategy, and I believe the use of the same instrument in the form of a gyro-compass gun director may possibly produce profound changes in gunnery practice in the future.

It has been suggested that the day of the big battleship is over, but I am doubtful of this, as I

Modern naval warfare is entirely different from that of the past in the fact that the rival fleets come into action when separated by many miles; the guns have, therefore, to be worked and fired while the distant targets are invisible to the gunners.

The guns have to be directed by observers in an elevated position, these observers communicating the distance of the target and its direction in space.

The direction in space must be supplied by a gyro-compass on board the ship, and it is essential that the compass for this purpose should be of extreme accuracy.

Once the guns are properly trained, they may be joined up and controlled by the gyro-compass, and for this purpose the turrets would be designed to act as huge repeaters, keeping the guns pointing on the target, changing only on receiving new directions from the observer.

The compass would hold the guns pointing on the distant target quite independently of the movements of the ship, which may at the time be steaming at full speed and manœuvring. Such movements are

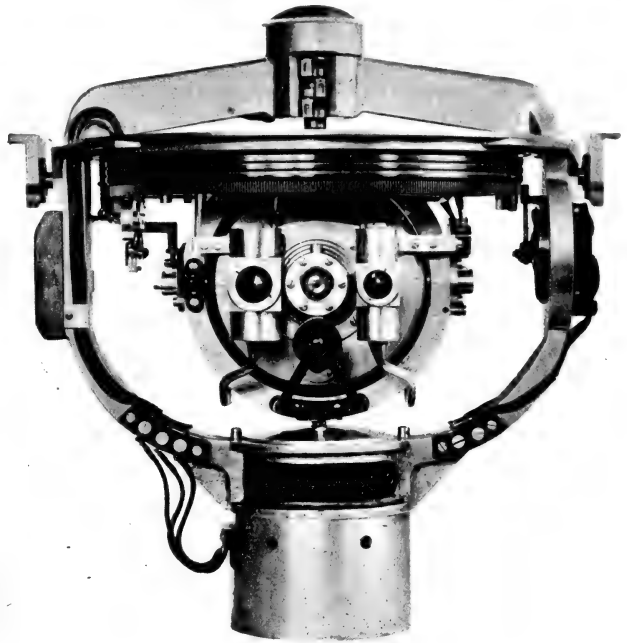

FIG. 5.

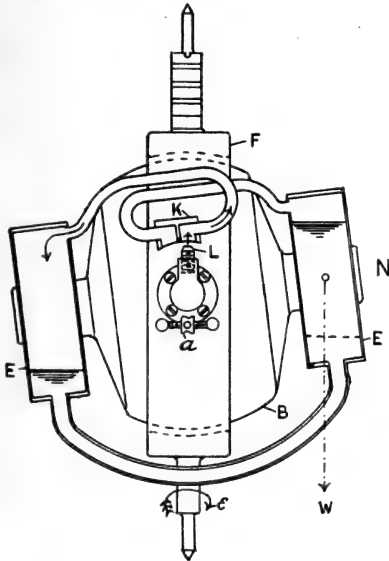

FIG. 6.

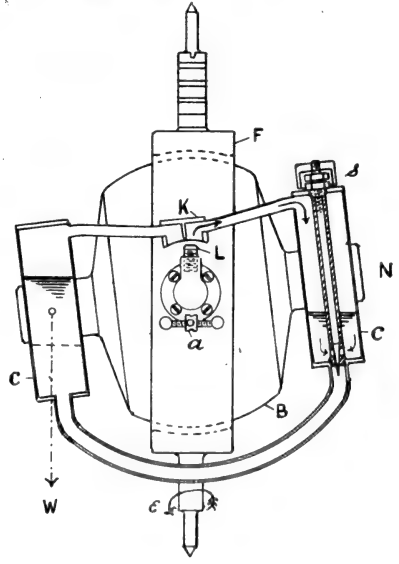

FIG. 7.

a great protection to ships against submarine and aerial attack.

understand that ships can be made proof against ordinary submarine attack by means of blisters filled

with oil, as in our Navy, or by coal-dust, as used by the Germans.

Working the guns with the ships at full speed, as I have just stated, will be an additional protection, while submarine craft will be more dangerous operating against fixed objects, such as harbour defences, etc., in which case they could be detected from the shore by submarine listening devices, such as my liquid microphone.

In closing this discourse, I should like to say that a good deal of credit is due to Anschutz for the courage he displayed in being the first to attempt a gyro-compass, knowing as he did the extremely feeble force that is likely to result from the earth's rotation, and in the fact that the instrument must be carried on a rolling, pitching, plunging vessel. With us who follow it is a question over again of Columbus and the egg. For myself, if I had known at the commencement of my acquaintance with the gyro-compass—some five years ago—all the difficulties that had to be encountered, I think I should have abandoned the pursuit.

### Notes.

At the meeting of the Royal Society on June 3 the Bakerian lecture will be delivered by Sir Ernest Rutherford on "The Nuclear Constitution of the Atom."

SIR JAMES DEWAR has been elected a corresponding member of the French Academy of Sciences in the section of general physics in succession to the late Prof. P. Blaserna.

THE Institute of Research in Animal Nutrition at Aberdeen has received a gift of 10,000*l.* from Mr. J. O. Rowett. The amount required from public sources for the establishment of the institution is 25,000*l.*

MR. A. A. CAMPBELL SWINTON, during his presidential address to the Wireless Society of London on February 28, reviewed, with the aid of experiments, advances in wireless telegraphy since 1914, and received, in full view of the audience, messages from Gen. Ferrié in Paris and from the Slough station of the Radio Communication Co. These messages were received, not on the usual external aerial, but on a simple loop of wire standing on the lecture-table.

In the course of a speech at a Conference of Provincial and Suburban Wireless Societies, held on February 27 under the presidency of Sir Charles Bright, Capt. F. C. Loring announced that the Post Office is in favour of granting wireless licences of about 10 watts where an amateur can prove that he thoroughly understands the apparatus and is a proficient operator, and that his transmitting station is to be used for genuine experimental work and not merely for communication between other stations in a general way.

WE are officially informed that Dr. Carlos Ameghino has been appointed director of the National Museum of Natural History, Buenos Aires, in succession to Dr. Angel Gallardo, who retired in 1916 to become Minister of Education. The new director is the younger brother of the late Dr. Florentino Ameghino,

the distinguished palæontologist, who held the same office from 1902 until his death in 1911. During the earlier part of his career Dr. Carlos Ameghino explored many parts of Patagonia and made the great collections of fossil vertebrate remains which were studied and described by his brother. During recent years he has been interested in the evidence for the association of man with extinct mammals in Argentina.

THE council of the Linnean Society has issued to the fellows a statement of the present financial position and outlook of the society, recommending them to increase the annual contribution from 3*l.* to 4*l.* The cost of publication is now so high that the Transactions have already been suspended, and the Journal is so much reduced that the issue of many valuable papers has to be postponed for an indefinite time. The due maintenance of the library and the preparation of an up-to-date catalogue are impossible in existing circumstances, and all establishment charges still tend to rise. If the difficulties appeared to be temporary some of the small invested funds of the society might be used, but as there is no prospect of a return to former conditions an increased income is absolutely essential. Nearly all the learned societies are at present faced with similar problems, and the time seems to have arrived when there should be some action in common to consider the possibility of help from public funds.

THE following are among the lecture arrangements at the Royal Institution after Easter:—Major G. W. C. Kaye, two lectures on recent advances in X-ray work; Prof. Arthur Keith, four lectures on British ethnology: The Invaders of England; Major C. E. Inglis, two lectures on the evolution of large bridge construction; Mr. Sidney Skinner, two lectures on (1) Ebullition and Evaporation, (2) The Tensile Strength of Liquids; Mr. R. Campbell Thompson, two lectures on (1) The Origins of the Dwellers in Mesopotamia, and (2) The Legends of the Babylonians; Mr. A. P. Graves, two lectures on Welsh and Irish folk-song (with musical illustrations); Prof. W. H. Eccles, two lectures on the thermionic vacuum tube as detector, amplifier, and generator of electrical oscillations; Prof. Frederic Harrison, two lectures on (1) A Philosophical Synthesis as Proposed by Auguste Comte, and (2) The Reaction and the Critics of the Positivist School of Thought; and Prof. J. H. Jeans, two lectures on recent revolutions in physical science, (1) The Theory of Relativity, and (2) The Theory of Quanta (the Tyndall lectures). The Friday evening meetings will be resumed on April 16, when Prof. J. A. McClelland will deliver a discourse on ions and nuclei. Succeeding discourses will probably be given by Prof. H. Maxwell Lefroy, Prof. F. O. Bower, the Right Hon. Lord Rayleigh, Prof. Karl Pearson, Prof. J. A. Fleming, Prof. W. L. Bragg, and other gentlemen.

ONE of the Industrial Research Associations formed in connection with the Department of Scientific and Industrial Research is the British Empire Sugar Research Association. If the association plans its

work on a sufficiently large scale, and raises 5000l. a year for the trade for five years, grants of the same amount and for the same period will be made from State funds. The offices of the association are in Evelyn House, 62 Oxford Street, W.1. The objects of the association are to establish, in co-operation with the Department of Scientific and Industrial Research, an Empire scheme for the scientific investigation, either by its own officers or by universities, technical schools, and other institutions, of the problems arising in the sugar industry, and also to encourage and improve the technical education of persons who are or may be engaged in the industry. A survey is being made of the field of research which is likely to be beneficial to the industry, and it is proposed to establish a bureau of information to which any member of the association can apply for assistance. In the first instance, the whole of the research undertaken will be carried out in existing institutions, and it will be necessary to enter into agreements with the bodies controlling these institutions for the use of laboratories and the services of skilled scientific investigators. With regard to the actual production of sugar, experiments on the cultivation of the sugar-cane and of the sugar-beet will be undertaken in suitable parts of the Empire. In this connection it is hoped that very close relations will be established with Colonial Agricultural Departments. The organisation and general supervision of the research work will eventually be entrusted to a director of research, and it is hoped to establish a Central Sugar Research Institute if and when it becomes necessary.

In Algeria most gun-owners are able to trim roughly the flints they require for the long-barrelled muzzle-loading guns and pistols which still form the principal armament of the nation. Mr. M. W. Hilton-Simpson, while engaged in collecting specimens for the Pitt-Rivers Museum, Oxford, came across a specialist who trimmed flints for sale. This worker's methods are fully described in the March issue of *Man*. He employed a rough stone for striking the flakes from the cone, and for trimming the flakes thus struck off he used a small tool resembling in outline the universal general-utility implement of the country, a combination of a hoe and pick. This man's features indicate an infusion of negro blood, but flint-chipping does not seem to be a special negro trade, the man being a resident of one of the oases where there is a negro strain in the population.

Of the eighteen species of ground-squirrels found in the State of California, four, inhabiting cultivated areas, have become pests. The life-histories of these four and of the harmless species have been very carefully described by Messrs. Joseph Grinnell and Joseph Dixon in vol. vii. of the Monthly Bulletin of the State Commission of Horticulture. In one district infested by the Oregon ground-squirrel the authors estimated that there were 112 adults to the acre or 70,000 to the square mile, and that these would consume in one day more than two tons of green forage, which would be sufficient to feed ninety head of cattle during the same time.

BIRD-LOVERS will read with no small pleasure Mr. J. H. Gurney's ornithological notes from Norfolk for 1919 in *British Birds* for March. Perhaps the most interesting of these notes are those referring to the bittern, which seems to be returning to the Broads in increasing numbers to breed. It is satisfactory to learn that, so far as can be ascertained, this year no nests were raided, though in one nest the brood, unfortunately, died. The little owl, he tells us, which up to 1914 was confined to a few districts in the west of the county, is quickly spreading throughout the whole of Norfolk. The prevailing prejudice against this bird he considers scarcely to be justified, since "the test of dissection is rather in its favour than otherwise." During the war vast quantities of a tar-like substance were spread over much of the North Sea for military reasons. One would have imagined that the need for this had now ceased, but in these notes are records of numerous divers and guillemots picked up in an exhausted condition owing to this compound clogging the plumage.

In the fourth part of his study of the Malacostracous Crustacea obtained by the *Ingolf* and other Danish expeditions from deep water in the seas round Iceland and South Greenland ("The Danish *Ingolf* Expedition," vol. iii., part 6, Copenhagen, 1920), Dr. H. J. Hansen describes the Cumacea and Phyllocarida. Of the former group no fewer than sixty-six species are enumerated, of which twenty-four are new—a surprisingly large proportion of novelties in view of the attention that has been given by G. O. Sars and others to the Cumacea of northern waters. Together with Dr. Hansen's previous memoirs on the Isopoda and Tanaidacea, this report serves to bring into prominence both the extraordinary richness of the micro-fauna of the sea-bottom and the imperfection of our knowledge of it even in the better-known regions of the ocean. From the point of view of systematic zoology, if not also from that of marine bionomics, a one-sided impression is apt to result from confining attention mainly to the more easily studied species of the plankton. In dealing with the Phyllocarida Dr. Hansen is able to throw new light on the structure of the limbs and mouth-parts of the long-known and much-studied *Nebalia*.

In the March issue of *Medical Science: Abstracts and Reviews* (vol. i., No. 6), one of the reviews is devoted to the subject of typhus fever. Owing to the war this disease has been very prevalent in Europe during the last four years; for example, in Poland 124,620 cases were recorded between January 1 and July 27, 1919. Lice are the agents by which the disease is transmitted, but the causative micro-organism is still unknown. The blood-serum gives agglutination with a *Proteus* bacillus, the *Weil-Felix* reaction, which is of considerable value for the diagnosis of the disease.

An interesting lecture on the history of electrotherapy by Dr. W. J. Turrell is published in the *Archives of Radiology and Electrotherapy* for February (No. 235). In England electrical treatment appears to have been first practised by the clerical profession.

In 1756 a book on the subject was published at Worcester by Richard Lovett, a lay clerk at the cathedral, in which he records the treatment of a number of diseases with electricity. In 1780 John Wesley, the great divine, anonymously published a book entitled "The Desideratum; or, Electricity made Plain and Useful." In this he appeals to the medical profession for a trial of the curative effects of electricity, and records many alleged cures.

WE have received the first number of a new British journal devoted to pathology, entitled the *British Journal of Experimental Pathology*. It is published bi-monthly under the editorship of a board of editors by Messrs. H. K. Lewis and Co., the annual subscription, post free, being 2*l*. The journal has been founded for the publication of original communications describing the technique and results of experimental researches into the causation, diagnosis, and cure of disease in man. Among the contributors to this first number are Prof. Bayliss ("Is Hæmolysed Blood Toxic?"), Dr. Crafer ("On Sympathetic Fever and Hyperpyrexial Heat-stroke"), Prof. McIntosh and Mr. Smart ("Determination of the Reaction of Culture Media"), and Mr. Fildes ("Serological Classification of Meningococci"). The journal is well produced, and, will, we believe, fill a lacuna in the means of publication of research work at the disposal of British pathologists.

MR. W. L. GEORGE, who gave evidence before the National Birth-rate Commission, has contributed to the *Fortnightly Review* for March a summary of the arguments he presented to that body, which does not appear yet to have arrived at a conclusion upon them. The line he takes is that a high birth-rate corresponds with a low degree of education, a low level of comfort, and poor foreign trade. He views, therefore, with calmness, and, indeed, with satisfaction, the recent decline in the birth-rate, and would take active steps in that direction by promoting the understanding of contraceptives and other preventive measures. Whether this could be done without leading to grave evils may be doubted. At any rate, Mr. George is justified in opposing proposals tending in the other direction, such as those for the endowment of motherhood, which would have the effect of encouraging imprudent marriages or illicit connections, and, as they involve an expenditure that he sees is financially impossible, must fall to the ground. He would have us base our quest for national prosperity on good births rather than on more births, on quality rather than on quantity. Like all difficulties that arise out of the passions and the instincts of mankind, the problem is soluble only by an appeal to reason and by a gradual education of the will in men and women. It should be noted that large families have given to the community many valuable members.

A SUPPORTING expedition for Roald Amundsen's trans-polar voyage has been organised by the Norwegian State. Some details from Scandinavian sources are published in *La Géographie* (vol. xxxiii., No. 1). The expedition which reached Greenland last summer is in charge of Lieut. G. Hansen, a Danish naval officer who accompanied Amundsen in the

voyage of the *Gjoa* in 1903-5. Lieut. Hansen is now wintering at Etah, in about 78° 15' N. This month he hopes to leave with a dozen sledges for Cape Colombia, the most northerly point of Grant Land, in 83° N. Stores and provisions for a year will be taken. Amundsen, who proposes to leave his ship, the *Maud*, at the most northerly attainment of its drift, is expected to make for Cape Colombia, and may arrive there in March, 1921.

At a meeting of the Royal Geographical Society on March 8, a paper was read by Miss E. M. Ward on "The Evolution of the Hastings Coast-line." We can scarcely agree that the Wealden dome stretches from Beachy Head to the North Foreland, as it does not extend beyond the Warren at Folkestone, where the chalk of the North Downs comes down to the sea, or that the North Foreland is in the Channel, as we might be led to believe. It may be pointed out that the eastward-flowing drift of flint beach is general on the South Coast, and that this has resulted in most of the southern-flowing rivers being turned to the east, whilst forming a spit of beach on the seaward side of the stream, this being the result of the conflict between the eastward-flowing tide and the southward-flowing stream. As the streams lost their velocity and carrying power they deposited their silt, and finally the conflict between sea and mud ended in the victory of the former, when the sea made its bold attack on the land, which is still going on, and against which engineers are fighting. The existence and continued growth of Dungeness have never yet been satisfactorily accounted for, but there is some reason to believe that the destruction of the Hastings headland let loose vast quantities of beach which had accumulated on its western side, and that this gave rise to the various low terraces still to be observed on the west side of the Ness. Miss Ward finds it difficult to believe that at Hastings there was a promontory in Neolithic times even so much as seven miles in length, but it is fairly generally believed that the passage between England and France was comparatively narrow in those times, and Prof. Boyd Dawkins even suggested that Neolithic man came across on dry land.

In the Proceedings of the American Academy of Arts and Sciences (vol. iv., December, 1919), Messrs. George F. McEwen and Ellis L. Michael deal with the functional relation of one variable to each of a number of correlated variables when the representation by linear regression is unsatisfactory. The basal idea is to assume that the dependent variable may be represented by a sum of functions of the independent variables, and to determine these functions by dissection of the material into a series of groups. If, for instance, a variable  $w$  is to be expressed in terms of  $x$ ,  $y$ , and  $z$ , a series of groups of ( $w$ ,  $x$ ), ( $w$ ,  $y$ ), and ( $w$ ,  $z$ ) are formed; a first approximation to the relation between  $w$  and  $x$  is obtained by taking the averages of the ( $w$ ,  $x$ ) groups; corrections are then derived from the averages of the ( $w$ ,  $y$ ) and ( $w$ ,  $z$ ) groups; from the second approximations third approximations are derived, convergence being ob-

tained to the values of  $w$  corresponding to variations of  $x$  alone. Similarly the other functional relations are obtained. The idea of defining a function by means of a series of corresponding values has been utilised by various mathematicians; the most obvious criticism of its statistical applicability is that an immense amount of arithmetic would be required to determine more than a very small number of corresponding values. The method, however, deserves further consideration.

THE *Meteorological Magazine*, an official publication of the Meteorological Office, was first issued under its new title about the middle of February. The journal incorporates *Symons's Meteorological Magazine* and the *Meteorological Office Circular*. For convenience in reference, the serial numbers of *Symons's Meteorological Magazine* are being carried on. The change has come about through the absorption of the British Rainfall Organization in the Meteorological Office. The cover of the new publication gives the portraits of four pioneers of meteorology, all of whom were associated with the Meteorological Office. Of these Admiral FitzRoy had charge of the Office at its initiation, when it was a branch of the Board of Trade, and Mr. Symons was an assistant sixty years ago, but left after a short period and devoted himself to the collection of rainfall returns, from which evolved later the British Rainfall Organization. Gens. Sabine and Strachey were successively chairmen of the Meteorological Office when controlled by the Royal Society. Little change has been introduced into the style and character of the publication, and it is evidently not intended to make any radical alteration. In addition to the interesting article on "Weather in the British Isles" for the preceding month, which has hitherto regularly appeared in *Symons's Meteorological Magazine*, an article is now given on "Weather Abroad" which will doubtless be valued by readers of the journal.

ON March 10 Lord Moulton delivered a lecture at University College on "The Training and Functions of the Chemical Engineer." The lecture was presided over by H.R.H. Prince Arthur of Connaught. Lord Moulton referred to the great importance of securing an adequate and suitable training for those who had to perform chemical operations on a large scale. In a research chemical laboratory work is carried out on small quantities of pure substances with every convenience at hand and regardless of cost and economy. In chemical industry, on the contrary, it is necessary to carry out operations on vast quantities of impure substances with no conveniences and with the greatest possible regard to the matters of cost and economy. The question of change of scale was all-important, since it was extremely difficult to secure on a large scale that uniformity of conditions easily obtained in a research laboratory and fundamental for the success of the operation. Lord Moulton laid great emphasis on the subject of costing and costs, since, as he pointed out, the success of an industrial

operation in the real world of chemical industry, as compared with the success of a chemical operation in the ideal world of the research laboratory, depended entirely on its cost. It was a noble and dignified business to make things cheaply so that they could be utilised by large numbers of people. In conclusion, Lord Moulton referred to the fact that the Ramsay Memorial Committee had given 25,000*l.* for the building of a laboratory of chemical engineering at University College. He earnestly hoped that the further sum of 50,000*l.* which was required would be forthcoming. A vote of thanks to Lord Moulton for his interesting lecture was proposed by Prof. F. G. Donnan, who referred to the great work Lord Moulton had done during the war as Director-General of the Explosives Supply.

Mr. James Thin, 54 South Bridge, Edinburgh, has just issued a useful and comprehensive catalogue of new and second-hand books on technical and scientific subjects. The prices named in the second-hand section are very reasonable. A laudable feature of the catalogue is the giving of the dates of publication of the volumes.

THE *Oxford University Press* will shortly publish an English rendering, by H. L. Brose, of "Space and Time in Contemporary Physics: An Introduction to the Theory of Relativity and Gravitation," by M. Schlick, with an introduction by Prof. F. A. Lindemann. The work is intended for the general reader. It deals with the problem of the structure of cosmological space, discusses the relation of psychological to physical space, and analyses the significance of measurements in physics.

THE *Reader's Index*—a bi-monthly magazine issued by the Croydon Public Libraries—for March and April contains much useful guidance for readers, including a reading list of books and periodical articles on the Einstein theory. We notice references to articles in *NATURE* of June 11, 1914; December 28, 1916; March 7 and 14, 1918; November 13, 1919; and December 4, 11, and 18, 1919.

A NEW series of books dealing with the textile industries has been arranged for by *Sir Isaac Pitman and Sons, Ltd.* The editor will be Prof. R. Beaumont, and one of the first volumes in the series to be published will be that by the editor on "Union Textile Fabrication," which will contain three main divisions dealing respectively with bi-fibred manufactures, compound-yarn fabrics, and woven unions. Another volume in the series will treat of "Flax Culture and Preparation." It will be the work of Prof. F. Bradbury.

MR. D. N. WADIA writes to say that the two illustrations from his "Geology of India" reproduced in *NATURE* of January 15 were not his own photographs, but from the collection of negatives at the offices of the Geological Survey at Calcutta. Acknowledgment of this was, unfortunately, omitted from the book, and our reviewer assumed, therefore, that the photographs were the author's.

### Our Astronomical Column.

THE TOTAL SOLAR ECLIPSE OF SEPTEMBER 20, 1922.—Mr. A. R. Hinks read a paper at the meeting of the Royal Astronomical Society on March 12 on the conditions along the track of totality in this eclipse. The nearest available station is in the Maldive Archipelago, where the sun's altitude is  $34\frac{1}{2}^\circ$  and duration 4m. 11s. It is recommended that an uninhabited islet be selected, as there is less risk of illness on one of these, the others having a bad reputation for Europeans. Also it should be an islet in the centre of a lagoon, as the outer ones experience vibration from the surf, which would spoil fine definition. The weather is likely to be clear but windy.

Christmas Island, south of Java, is near the noon point; the sun's altitude is  $78\frac{1}{2}^\circ$  and the duration 33m. at the south point of the island. There are a flourishing phosphate industry on the island, a monthly steamer from Singapore, and good jetties and cranes at Flying Fish Cove, whence there is a railway to the south coast. Much of the island is covered with forest (haunted by large land-crabs), so some clearing might be necessary to give enough sky room for adjusting the equatorial mounting which it is intended to use here. The weather conditions in September promise to be very good.

The west coast of Australia offers difficulties, the country being barren, and there being no port in the neighbourhood of the track. The east end of the track in Australia is in Queensland, just south of Brisbane. The sun's altitude here is only  $18^\circ$ , but it is possible to obtain an altitude of about  $26^\circ$  by travelling by rail into the interior.

The programme will include a repetition of the investigation of the Einstein shift; there is a fair field of stars round the eclipsed sun, though they are much less bright than those of the eclipse of May, 1919.

THE BINARY STAR  $\rho$  ERIDANI.—This southern binary star (R.A. 1h. 36m. 45s., S. decl.  $56^\circ 36'$ ) was first noted as double by Dunlop in 1826, and observed by Sir John Herschel at the Cape, 1834 to 1836. It was for some time doubtful whether the relative motion was not rectilinear, but curvature is now definitely established. Mr. B. H. Dawson gives a determination of the orbit in the *Astronomical Journal*. No. 762, as follows:—Period 218.9 years,  $T$  1806.14,  $e$  0.721,  $a$  8.025",  $\omega$   $301.40^\circ$ ,  $i$   $\pm 114.26^\circ$ ,  $\Omega$   $103^\circ$ . There is still much uncertainty, as only one quadrant has been observed. The large size of  $a$  makes the pair an interesting one. Apastron was passed in 1916, and the stars are now 9" apart. Both are of magnitude 6.2; the proper motion of the middle point between them is  $+0.0336s.$ ,  $+0.022''$ , according to Boss.

FAINT NEBULÆ.—Publications of the Yerkes Observatory, vol. iv., part 2, is occupied with an account of a research on faint nebulae by Mr. Edwin P. Hubble. Mr. Hubble took a series of photographs, with the 24-in. reflector at the Yerkes Observatory, of some rich nebulous regions, including seven well-defined clusters, containing more than five hundred nebulae. The measures for ascertaining their positions are given, but, owing to the bad figure of the images in the outer parts of the field, the precision is not considered very great. The exposures did not generally exceed two hours, as beyond that point very little seemed to be gained. The average diameter of the nebulae is about  $25''$ , but in certain regions, notably in Perseus, they are distinctly smaller, about  $15''$ . The question of the distance and status of these small nebulae is discussed at some length, but the evidence appears to be insufficient to decide whether they are in the remoter parts of the galactic system or altogether outside it.

### International Fishery Investigations.

THE first meeting since the autumn of 1913 of the International Council for the Exploration of the Sea took place in the Surveyors' Institution, Westminster, on March 2-6. The Council exists to consider and conduct investigations into the fisheries of the North Atlantic; to examine how far these fisheries are being depleted by fishing; to investigate natural methods, such as by breeding, etc., of keeping up the stock; and in cases of certain future failure of supply to suggest the necessary remedial measures. The Council has been conducting researches for nearly twenty years, but its operations during the war were brought almost to a standstill. For the most part it deals with the sea-fish common to all countries, but a special sub-committee considers the salmon, and a second the eel; shellfish are not investigated. The countries represented were France, Belgium, Holland, Denmark, Sweden, Norway, Finland, and Great Britain, each country having two delegates, with scientific experts from the fishery authorities of each. France was represented for the first time, but Germany and Russia dropped out of representation; the meeting was too hurriedly convened to allow of the U.S. Congress appointing delegates, and there was no representative of Canada, the eastern fisheries of which are mainly coastal. Great Britain was represented by Mr. H. G. Maurice and Prof. D'Arcy Thompson as delegates, Mr. Holt representing Ireland, while most of the scientific staffs of the three countries took part in the deliberations of the committees, including Prof. Stanley Gardiner (temporary Director of Fishery Research) and Comdr. Jones (of the Scottish Office).

March 2 was devoted to general business and the formation of committees, the whole body meeting together under the chairmanship of Prof. Pettersen (Sweden). After a telegram of respectful homage had been dispatched to the King, the chairman referred in sympathetic terms to the troubles of the last years and to the increased importance to Europe of safeguarding its supplies of fish. Commodore Drechsel (Denmark) and others spoke of the closure of the greater part of the North Sea as the most gigantic scientific experiment ever made in respect to the closure of areas, and one from which we might be able to draw the most important deductions in respect to the conservation of our fish supply. Mr. Maurice pointed out the difficulties under which all countries are at the present time labouring, and appealed to all to help in drawing up practical programmes of work such as each country could guarantee to carry out. The meeting then split into two committees for fishery investigations and fishery statistics and for hydrography and plankton (floating life in the sea).

The committees met twice daily during the next three days to draw up their programmes to be submitted on Saturday, March 6, to the whole body of delegates. The main deliberations of the Fish Committee were in respect to the plaice. All were agreed that the fishery statistics of Western Europe up to 1914 proved that there had been a most serious depletion of the stock of plaice on the fishing-grounds of Western Europe, particularly in the southern half of the North Sea. The apparently probable disappearance of this fish, from the point of view both of the industry and of the consumer, was felt to be so calamitous that even the strongest measures were thought to be justifiable. It was proposed that the Council should suggest to the diplomatists to negotiate a size-limit and the permanent closure of certain areas to provide a reserve, from which the young plaice might spread so as to restock the open grounds. It was pointed out that Denmark had already insti-



tuted a size-limit of nearly to in., but that Holland did not favour one of more than about 8 in. The representatives of Great Britain considered that the effect of the closure of areas on the industry had not been sufficient studied; that the closed areas must be as small as possible, consistent with the preservation of the plaice stock of the North Sea; and that the study of the effect of the war in having closed great areas would materially assist the Council in arriving at the most practical results.

The British view was finally adopted, and it was decided to undertake a year's intensive plaice investigation with the view of considering the whole question in 1921 and making recommendations. The committee then proceeded to draw up a programme of investigations. A thorough collection of statistics of plaice marketed was deemed essential. Furthermore, an accurate knowledge of the sizes of the fish both as marketed and as caught on commercial trawlers was recommended. The liberation after marking of a series of fish would be necessary to show their wandering during the year. Further experiments in the liberation of marked fish of small size on the Dogger Bank were recommended. The spawning-grounds should be more fully investigated and charted. The liberation of a large series of drift-bottles, both surface and bottom, was deemed essential so as to ascertain the drift of the eggs and young larvæ which float for many weeks in the water. The examination of numbers of eggs so as to ascertain the intensity of spawning in different areas was deemed advisable, as well as an investigation into the food on which the larvæ feed.

As most of the spawning areas of the plaice are off the east coasts of Great Britain, it was generally recognised that this country would have to concentrate in the present year mainly on these plaice investigations, but the hope was expressed that the examination of the life-history and wanderings of the lemon-sole would not be neglected, while the other fish occupying plaice grounds should be carefully recorded. The continued examination of the constitution of the herring shoals and of the other work on the life-history, growth, etc., of the herring was recommended, Great Britain being requested to collect samples and to send them to Norway, the representatives of which (Dr. Hjort, Prof. Gran, and Dr. Lea) undertook to examine them.

The Danish representatives described their plans for a second great expedition in the North Atlantic to search, among other objects, for the spawning-grounds of the fresh-water eel, which their previous work showed to be somewhere in the latitude of Madeira and at depths of at least 1000 or 1500 fathoms. They also gave an account of the commercial results obtained by the importation of the young eels (elvers) and their liberation in Danish rivers and lakes. Dr. Johansen (Denmark) and Dr. Rosen (Sweden) described the work of their respective countries on the movements of salmon and sea-trout, the ages of these fishes for spawning, the liberation of fry, etc., showing results of considerable economic importance—results capable of immediate application in many British rivers could the difficulties in respect to pollution be overcome.

The Hydrographical and Plankton Committee divided into sub-committees for its two subjects. The former is mainly concerned with the currents on the fishing-grounds in respect both to the movements of such fish as herring, mackerel, and pilchards, and to the drifting of fish-eggs and young. It was generally considered that the hope of foretelling the movements of the fish and the success or otherwise of the spawning year by year depended on a more extensive study of the movements of Gulf Stream

waters from Barents Sea to Iceland and down the European coasts to Mogador, with more intensive investigations in the North Sea. The nature of the spawning was deemed peculiarly important, as on this depends to a large degree the success of the fishing some years afterwards when the spawn has grown into fish of marketable size. Extensive temperature records and water samples from a series of transoceanic liners month by month were recommended, and the hope was expressed that the United States would co-operate by collecting samples on liners cutting the Gulf Stream nearer where it leaves the Straits of Florida.

A full programme of hydrographic work was recommended in the southern half of the North Sea in view of the plaice investigations. Here the sea is so shallow that the water is thoroughly churned up from surface to bottom, and, in consequence, surface samples only, mostly from passenger ships, were proposed. The drift-bottle programme was approved and somewhat extended in the hope of understanding better the isobaric, temperature, and salinity charts of the region in respect to the movements of fish, with the view of making them usable by fishermen.

The plankton sub-committee, under Prof. Gran, drew up a very small programme on account of present difficulties, but it decided to recommend researches on the physico-chemical conditions of sea-water in respect to the life in the sea. It regarded this basal research as impossible either to initiate or carry out under the Council, and so decided to record its opinion as to the necessity of such researches on living animals in respect to the water in which they live. It was pointed out that the acid or alkaline nature of the water affects the rate of growth of young fish, and that further knowledge here in respect to trout, salmon, and plaice might become at once of economic importance. Animals, too, show growth in the most carefully filtered sea-water—a matter of the greatest importance, the meaning and utility of which could not be foretold. It is well known that the blood of human beings can be replaced by sea-water, but not so effectively by artificial sea-water, which is made from distilled water by dissolving in it the various salts. The possible meaning of this was discovered by Dr. Allen (Plymouth) working on minute marine animals, and points to those mysterious substances "vitamines," of which so much has been heard in the last six years and so little is known. The searcher for economic results in fisheries must have the basal theory and knowledge in respect to his living fish duly developed as the foundation on which he has to build. Incidentally, an increase in knowledge of this soluble food, etc., should be rapidly applicable to oyster- and mussel-farming, and the sub-committee could only hope that the requisite genius to give further ideas would soon be found.

The development of lakes and rivers for the production of food was of special interest to Mr. Holt (Ireland), the Swedish and Finnish representatives, and Dr. Redeke (Holland), the last giving an account of the very great development of the freshwaters of his country. So far as fish were concerned—salmon is treated separately—the subject is of little importance to Great Britain, but the possibility of the development of a button industry by the cultivation of mussels was thought worthy of investigation.

France was represented by M. Kersoncuf (Director of Marine Fisheries), accompanied by M. Tissier, Prof. Behal, Prof. Joubin, and Dr. le Danois. A meeting with the English and Irish representatives resulted in the formation of a special committee to consider and report as to fisheries off the mouth of

the English Channel and in the Bay of Biscay and to the west and south. The chief fish of this region are the migratory mackerel and pilchard and the hake, which apparently is a great wanderer. It is hoped also to investigate the possibilities in respect to tunny, of which there should be an almost unlimited supply in the Atlantic. France undertook the preparation of a fishing chart of certain grounds, Ireland particular cruises to meet the French vessel, and England to continue and extend her investigations into the waters of the Channel. England was also asked to undertake, as soon as possible, regular cruises to the south-west to investigate the approach of the Gulf Stream waters in respect to mackerel, pilchards, and tunny.

At the full meeting on Saturday, March 6, the programmes of the committees were adopted, and Mr. H. G. Maurice was unanimously elected president for the ensuing year, the next meeting to be held in Copenhagen in 1921. The present writer believes that the fishery industry appreciates the vital importance of these very technical investigations, in the results of which the interests of the fisherman and the researcher are identical; he appeals to the industry to co-operate in every way in its power, and in particular to return drift-bottles and marked fish.

### Exhibition of Diseases of the Para Rubber-tree.

AN important exhibition illustrating the fungal diseases to which the Para rubber-tree (*Hevea brasiliensis*) is subject in Ceylon and Malaya was opened on March 10 in the Botany Department of the Imperial College of Science and Technology by the Marquess of Crewe in the presence of leading representatives of the rubber trade. The exhibition, which has been organised by Prof. J. B. Farmer, Director of the Biological Laboratories of the college, includes a large number of trunks of rubber-trees, specially shipped from the East, showing the diseases as they occur in the plantation, and forms a striking commentary on the optimism which obtained in the first years of the industry as to the probable relative immunity of Hevea from disease.

The warnings issued by botanists at the time that the Para rubber-tree would no more escape epidemic fungal disease than any other crop plant has, unfortunately, been justified by events. At the present time there are several diseases which, if not checked as the result of sound scientific knowledge, intelligently applied, may seriously affect the future of the plantation industry. The former optimism finds a present-day counterpart in the equally dangerous view held in certain quarters that "sanitation" is all that is necessary as a safeguard against disease, and that, in consequence, expenditure on mycological research is waste of money. The fact that the causative organism (if organism it be) of the most dangerous disease in the plantations at the present time ("brown bast") is as yet unknown is sufficient reply to so short-sighted a view. The exhibition comprises three main sections: (1) A series of rubber trunks affected by the chief diseases met with in the East, illustrated by admirable coloured wall-pictures of the diseases *in situ*; (2) cultures and microscopic preparations of living fungi isolated at the college from the trunks exhibited; and (3) a section devoted to the important bearing of a knowledge of the anatomy of the bark of the tree upon questions of latex yield. This section also includes trunks illustrating different systems of tapping. All the exhibits are accompanied by explanatory labels.

The principal diseases represented are as follows:

(1) *Brown Bast*.—This is by far the most important disease at the present time, and is rapidly increasing, certain estates in Java having as many as 60 per cent. of the trees attacked. It is an affection of the bark in the tapping area, and is of acute importance, since it quickly results in the complete cessation of latex flow. Later, the bark becomes discoloured and burrs appear over the affected area. The disease is met with on young and old and on vigorous and backward trees, and occurs in every type of soil. At present preventive measures are confined to disinfection and excision of the affected tissues, but successful treatment is hindered by ignorance of the real nature of the disease. Hitherto physiological disturbance produced by tapping has been held to be the cause, but recent work in Sumatra suggests a bacterial origin. Further research alone can settle this fundamental question.

(2) *Fomes lignosus*.—Next to brown bast this is the most serious disease of Hevea. It is a fungus of the familiar Polyporus type, attacking the cortex of the roots. In cases where it was neglected in the early stages it has since wiped out large blocks of rubber, and from the nature of the disease the replanting of such areas has been impracticable. The mycelium spreads to the Hevea roots from old jungle stumps, or from soil in which old jungle roots have been lying. From the infected Hevea roots it passes to all healthy roots in the vicinity, finally destroying the trees. Treatment consists in exposing the root-system and painting the diseased roots with Bordeaux mixture or other fungicide. The soil is also heavily limed to destroy the mycelium invariably present in it, and the whole infested area isolated by a trench.

(3) *Fomes pseudoferrous (Poria)*.—This fungus penetrates deeply into the wood of the Hevea roots, often leaving the cortex as a living cylinder until the wood is destroyed by a "wet rot." The tree thus shows little external signs of attack until the disease has reached the final stage. In consequence, measures of dealing with Poria are limited to preventing its spread. The treatment adopted is essentially the same as for *Fomes lignosus*.

(4) *Dry Rot (Ustulina zonata)*.—This fungus is a wound parasite, and gains entrance *via* lesions on roots, stems, and branches, killing the wood, which becomes soft and tindery. Owing to former neglect of wounds, the disease is greatly increasing in older plantations. The best preventive treatment is a periodical dressing of all wounds with tar. When confined to the branches the disease may be removed by pruning, but if on the base of the trunk or on the roots, the tree is usually found to be infected with Fomes in addition, and treatment is impracticable.

(5) *Patch Canker (Phytophthora Faberi)*.—This disease is increasing in all the rubber-growing countries of the East. The bark just below the surface becomes claret-coloured, and eventually dies off in patches. The disease can be controlled by early removal of the bark and coating the exposed surface with tar, but the chief difficulty is that the affected bark is freely entered by boring beetles which penetrate deeply into the wood, carrying with them spores of dry rot (*Ustulina*). In consequence, nearly every case of neglected patch canker is also infected with dry rot.

(6) *Stripe Canker (Phytophthora sp.)*.—This canker was a formidable menace during 1915-17, more than 70 per cent. of the trees in tapping on some estates being attacked. The disease first appears as narrow vertical stripes just above the newly tapped bark, and if tapping is continued during the wet season the whole of the tapping surface rots away. Fortunately, it is now almost completely preventable by daily disinfection of the tapping cut.

(7) *Pink Disease (Corticium salmonicolor)* has

caused much damage in the East. It rarely attacks very young trees, and develops most rapidly during periods of heavy rain. Manifestations of the disease are extremely variable, but a common form, viz. a pink encrustation on the branches or main stem, gives the disease its popular name. Once the bark is penetrated the fungus spreads rapidly, destroying the cortex, and frequently enters the wood, interrupting the water-supply to the branches, which turn brown and die. So far the best treatment has been the removal of infected branches, or by treating the diseased parts with tar. Except in special cases, spraying is not practicable.

In the section devoted to fungal cultures and preparations, the following fungi, among others, have been isolated and grown from the trunks exhibited: *Cyphella heveae*, a cause of "thread blight" disease; *Botryodiplodia theobromae*, a cause of "die-back"; *Fomes lignosus*; *Hypomyces* associated with *Botryodiplodia*. In addition to living cultures of these fungi on potato and banana agars, interesting experiments are in progress with the view of ascertaining the effect of the vitality of the host upon the potency of the parasite. The fungi have therefore been sown (on wounds) on apple-twigs respectively healthy, of low vitality, and dead, and the cultures kept in a saturated atmosphere and at 25° C.

The third section well illustrates by means of diagrams the important relationship between the anatomy of the rubber stem and the yield of latex. In high-yielding trees the bark shows a large number of rings of latex tubes and a high relative proportion of soft bast as compared with hard bast, which latter contains abundant groups of stone-cells interrupting the rings of latex tubes. In good yielders the stone-cells are more or less confined to the external part of the cortex; in low yielders they are distributed in depth. The well-known superior yield of tapping cuts made from left to right over cuts made from right to left is due to the oblique course of the latex tubes in the bark. This important fact is explained in a large diagram. Mr. H. Ashplant exhibits elaborate statistics showing individual daily tapping yields obtained by different coolies on one estate over a period of three years. The figures show that highly skilled tappers working a group of trees previously tapped by average or poor tappers may collect from 50 to 200 per cent. more latex than the unskilled men. This fact results from the variable depth of the cut made by the inferior tappers, who do not reach the more internal rings of latex tubes. A further interesting point is the favourable influence of a good tapper's work on the yield obtained by an average tapper succeeding him in the same block.

It is much to be hoped that efforts will be made to maintain and develop the present exhibition as a permanent museum of the economic mycology of *Hevea brasiliensis*. Such a museum, with its natural complement of an information bureau, would be of the greatest practical value to the home representatives of planting interests and to the industry generally. The exhibition demonstrates in the clearest fashion the supreme importance of scientific research in this vital aspect of rubber-planting. New diseases are bound to occur in the future, and it may be disastrous to wait until the plantations are seriously affected before taking steps to secure expert advice. Adequate scientific staffs should be continuously engaged in studying the complete biology of *Hevea*, so that in the advent of a new disease experienced specialists could be detailed at once to cope with it. It is, however, essential that such staffs should be composed of men of first-rate ability and training, for where so much is at stake

anything short of the best is worse than useless. Moreover, the best men afford the greatest chance of effecting the desideratum in combating all disease, viz. the stitch in time. The industry must be prepared to pay for such men, but there can be no question that money generously and wisely spent on these lines would be repaid times over.

### The Position of the Meteorological Office.

DR. C. G. KNOTT, president of the Scottish Meteorological Society, has sent us a copy of the following resolution passed by the council of the society with reference to the present position of the Meteorological Office:—

"The council of the Scottish Meteorological Society have had under consideration the information published regarding the future status of the Meteorological Office and its relation to various Departments of State. They recognise that an incorporation in one of the great Departments of State is desirable, and realise that meteorology has much to gain by an intimate connection with the Air Ministry. At the same time they have in view that the State Meteorological Office has many other departments and interests to serve, not the least of which are those of pure research. They feel that any system by which the policy of the Office was directed by the interests of only one Department might in certain circumstances hamper its proper development. The science of meteorology made notable advances in many directions under the liberty enjoyed by the Director of the Office with the administrative committee as constituted in 1905. The council urge that, whatever constitution it may be convenient to give to the Office, the public, departmental, and scientific interests of the science should be safeguarded by expressly and personally charging the Director with the care of meteorology in all its branches. Under such an instruction the Director could be relied upon to organise the service upon a scientific plan and to build up the administrative elements in accordance with the demands made upon him. The council also feel that any step which will modify the functions and responsibilities of the Meteorological Committee should be taken only after searching inquiry by a Departmental Committee into the necessity for any modification, and the probable effect of such modification on the work of the Meteorological Committee."

### Earthworks and Retaining Walls.

IT is admitted that our knowledge of earthwork problems is far from complete, and the information given in two papers read at the Institution of Civil Engineers on February 10 forms a welcome addition. Mr. Ponsoby Moore Crosthwaite has made experiments on the horizontal pressure of sand, and finds that the angle of internal friction is much less than the angle of repose. The experiments show that the pressures on a wall, as calculated from the Rankine and Colomb theories, are much too high, especially for surcharged walls. Further experiments show that the wedge theories which take account of the friction between the wall and its backing give correct results if the wall is not surcharged, but break down for surcharged walls. By modifying the wedge theory so as to neglect the friction on the back of the wall, and introducing the angle of internal friction instead of the angle of repose, marked agreement was found with the experiments for surcharged walls.

Experiments were made with the object of testing whether the friction between the wall and the backing was of importance, and these showed that this friction did not affect the horizontal thrust.

The second paper, by Mr. Angus Robertson Fulton, gives an account of experiments made on the overturning moments on retaining walls. The method of direct measurement of the moment was employed; the filling was of three kinds: (1) clean river sand, (2) gravel, and (3) garden soil. The total height without surcharge was limited to 7 ft., and with surcharge it reached 9 ft. The experiments without surcharge show that results calculated from the Rankine theory are greatly in excess of the observed values, while those obtained from the wedge theory approximate fairly closely to experiment. For surcharged vertical walls with unlimited slope the wedge and Rankine formulæ give values too great by 20 and 50 per cent. respectively. In the whole series of experiments the greatest discrepancy occurred with the 7-ft. levels (no surcharge) when gravel-filling was used, and was worst with the wall inclined outward. Low experimental values were also obtained in the sand tests at the lower level under surcharge. Mr. Fulton concludes that the wedge theory gives good results with material uncompacted for walls in which the inclination of the inner face is not greater than usually obtains in practice.

### Fellowship of the New Zealand Institute.

AT the annual meeting in 1919 of the Board of Governors of the New Zealand Institute it was decided to establish a fellowship of the institute, since—apart from Hutton and Hector memorial medals, which can be gained only by very few—there are no honours attainable in the Dominion for those engaged in scientific research, the number of whom has greatly increased in recent years, while more branches of science are pursued than formerly. This fellowship, which entitles the recipient to place the letters "F.N.Z.Inst." after his name, is limited to forty fellows, and not more than four are henceforth to be elected in any one year until the number is complete, after which only such vacancies as occur may be filled.

In order to make a commencement, and as there were many who well deserved recognition for their long and valuable services to science, it was resolved that, in the first place, twenty original fellows should be appointed, these to consist of the living past-presidents, together with Hutton and Hector medallists (ten in all), and of ten more members of the institute who were to be elected by the past-presidents and medallists from persons nominated by the various affiliated branches of the institute.

The fellowship is to be given only for research or distinction in science, and it is plain that the distinction even now is far from easy of attainment, and that, as time goes on, its value will greatly increase. The election and appointment of the original fellows took place at the close of 1919, and resulted as follows:—Mr. B. C. Aston, \*†Prof. W. B. Benham, †Mr. Elsdon Best, \*†Mr. T. F. Cheeseman, \*\*†Prof. Chas. Chilton, \*\*†Dr. L. Cockayne, †Prof. T. H. Easterfield, Prof. C. C. Farr, Mr. G. Hogben, Mr. G. V. Hudson, Prof. H. B. Kirk, ††Dr. P. Marshall, \*Dr. D. Petrie, †Sir Ernest Rutherford, Prof. H. W. Segar, Mr. S. Percy Smith, Mr. R. Speight, Prof. A. P. W. Thomas, \*the Hon. G. M. Thomson, and Dr. J. Allan Thomson. \* signifies past-president; † Hector medallist; and † Hutton medallist.

### The Proposed University of Reading.

LORD HALDANE'S conception of the division of the country into areas in each of which a "civic university" caps the provincial education scheme is coming to be recognised as not only wise and far-seeing, but also essential. In Georgian and Victorian days a university was looked upon as primarily an institution for the completion of the teaching work of public schools. The wider view is taken now of the university as a focus of the intellectual life of the community which it serves and as a centre for research.

When in 1902 it was proposed that the Victoria University should be split up into the Universities of Manchester and Liverpool, many regarded the multiplication of degree-giving bodies with apprehension. It was feared that it would lead to a competition downwards. The reverse of this has happened. Leeds, Sheffield, and Bristol have secured independent universities, and each of them fears, above all things, the imputation that its degrees are less desirable than those of any other.

Reading is now seeking a charter. This project is not new. In 1911 the college received great endowments from Mr. and Mrs. G. W. Palmer, Lady Wantage, and Mr. Alfred Palmer, given for the purpose of enabling it to qualify for a charter. The scheme was interrupted by the war, but has now been taken up again with the utmost vigour. Three or four only of our modern universities have so large a permanent source of income. Its students are now more numerous than were those of two chartered English universities before the war.

In the provision of residential accommodation Reading is unique. Its six hostels lodge upwards of four hundred students. The college has also certain definite claims to be regarded as a national institution. In addition to the faculties of letters and science and the departments of fine arts, music, and domestic subjects, its distinctive line of study is agriculture, horticulture, and dairying. In these subjects it is a most important centre of research. Students go to it, not only from the whole of the United Kingdom, but also from the Continent and the British Dominions overseas.

The desire for independence is most natural. As matters stand at present, its professors and lecturers have no voice in determining the conditions for degrees, in settling the syllabuses of teaching, in carrying out the examinations, or in marking their students' answer-papers.

### University and Educational Intelligence.

CAMBRIDGE.—Prof. Horace Lamb, Sir Thomas L. Heath, Prof. W. H. Bragg, and Dr. Henry Head have been elected honorary fellows of Trinity College.

Mr. A. Amos, Downing College, has been appointed University lecturer in agriculture, and Mr. G. U. Yule, St. John's College, re-appointed University lecturer in statistics.

A Smith's prize has been awarded to S. Pollard, fellow of Trinity College, for an essay on "The Stieltjes Integral and its Generalisations."

The following grants have been made from the Gordon-Wigan fund.—50*l.* for plant-breeding experiments, 50*l.* for an experimental gas chamber in the physiological laboratory, 50*l.* to assist in the provision and display of entomological specimens, 30*l.* to help in the study of Pleistocene deposits round Cambridge, and 50*l.* towards a deficit on the working of the botanical department.

The Secretary of the Royal Commission on Oxford and Cambridge Universities gives notice that all members of the University who desire to submit representations on matters falling within the terms of reference of the Commission should forward written memoranda in triplicate to him at 22 Carlisle Place, S.W.1, if possible by the middle of April.

Fresh regulations for the diplomas in agriculture and forestry have been drafted. It is proposed to establish a diploma in horticulture, and, further, to include horticulture in the subjects to be examined upon for the degree of B.A. in agriculture, estate management, and forestry.

THE Senate of the University of Dublin has decided to grant the following honorary degrees:—*D.Litt.*: Dr. William Crooke. *LL.D.*: Lord Bryce and Sir Donald MacAlister. *M.D.*: Sir Archibald E. Garrod, Regius professor of medicine in the University of Oxford. *D.Sc.*: Prof. W. H. Bragg, Quain professor of physics in the University of London, and Prof. R. A. Millikan, professor of physics in the University of Chicago.

A ROYAL COMMISSION has been appointed to inquire into the financial resources and working of the University of Dublin and of Trinity College, Dublin, and to consider the application which has been made by the University for State financial help. The members of the Commission are:—Sir Archibald Geikie, Sir John Ross, Dr. A. E. Shipley, Prof. J. S. E. Townsend, and Prof. J. Joly. Prof. G. Waterhouse is to be the secretary to the Commission.

THE governing body of the Imperial College of Science and Technology has made arrangements for the provision, partly from its own funds and partly from the gifts of donors for this special purpose, of six post-graduate scholarships for advanced work and research to be held in the coming year at American universities. It is hoped that arrangements may be made for interchange by the reception at the Imperial College of a corresponding number of university students from America. Lord Crewe, chairman of the governing body, has received the following letter from Viscount Grey:—"It is most desirable that young men of the rising generation, who will do much of the public work here and in America in the coming years, should get to know each other's universities. It will help both countries to realise how much the British and American peoples have in common, not merely in language, but in thought and in political views and aspirations. I am sure the interchange of students between British and American universities is most valuable both to individual students themselves and generally in promoting friendship based upon true understanding."

A WELL-ATTENDED meeting of teachers of the Incorporated Colleges and Schools of the University of London was held at King's College on Friday, March 12, under the chairmanship of Prof. W. A. Bone, of the Imperial College of Science and Technology, to consider the position of university teachers in relation to the Teachers (Superannuation) Act. The chairman pointed out that, as the Act is framed, university teachers are expressly excluded from its benefits. This exclusion will inevitably set up a barrier between the schools and the universities, and prevent the free transition of teachers from the one to the other, especially as the salaries of university lecturers compare most unfavourably with those in the better secondary schools. Financially, the benefits under the Teachers Act are much greater in almost all respects than under the existing contributory scheme for university teachers, which

makes no provision in respect of the years of service of a teacher prior to his joining the scheme, whereas the Act is retrospective and takes account of all years of recognised service. As the scheme was only instituted in 1913 this is a matter of serious concern to the older university teachers, for whom the provision on retirement is totally inadequate. The new scales of salaries and the Teachers Superannuation Act have made the school-teaching profession much more attractive than in the past, and unless the universities are placed in a position to offer salaries and retiring allowances at least comparable with those offered to teachers in secondary schools, they cannot maintain their efficiency and attract the abler graduates to their service. After discussion the following resolution was passed with only five dissentients:—"That this meeting of whole-time teachers in the Incorporated Colleges and Schools of the University of London hereby requests the Government to extend to university teachers and administrative officers all the benefits of the School Teachers (Superannuation) Act, 1918." A committee was appointed to take further action in conjunction with the Association of University Teachers.

## Societies and Academies.

### LONDON.

**Royal Society**, March 4.—Sir J. J. Thomson, president, in the chair.—Dr. F. F. Blackman: The protoplasmic factor in photo-synthesis. The centre of interest in problems of the photo-reduction of  $\text{CO}_2$  in green photo-synthesising cells is shifting from the chlorophyll to the protoplasm. The quantitative control of photo-synthesis in the normal green cell is determined protoplasmically. This is illustrated by the temperature relations, which are not those of a photo-chemical reaction, but of a dark reaction. The photo-synthetic activities of leaves of different varieties (green *v.* golden leaves) and at different stages of development show no relation to the amount of chlorophyll that they contain, as is brought out by the "assimilation numbers" of Willstätter. The relation between chlorophyll development and photo-synthesis development, described in the next communication, furnishes another instance of the dominance of factors other than the pigment. In many lower organisms we find the power of reducing  $\text{CO}_2$  to form organic matter by chemical energy in the absence of pigment or light. This chemo-synthesis may be the sole or only an alternative source of the carbon for the living cell. The process involves, of course, no cosmic gain of energy. In these cases the efficiency of energy transference from the oxidation of various substances to the reduction of  $\text{CO}_2$  seems to be as great as or greater than in the utilisation of light energy for photo-reduction of  $\text{CO}_2$ .—G. E. Briggs: The beginning of photo-synthesis in the green leaf. In young leaves development of the power of photo-synthesis is found to lag behind development of chlorophyll, so that a green leaf when young may exhibit very slight or zero photo-synthetic power. This means that photo-synthetic activity demands development of some other internal factor than chlorophyll. The potentiality of this other factor rapidly increases with age day by day, even when the leaf is kept in darkness continuously. By keeping a leaf in a very low partial pressure of oxygen, further development of chlorophyll can be completely arrested, even in continuous light. Here also, starting with a leaf of feeble green tint, there is similar day-by-day increase in photo-synthetic power, in spite of there being no further greening. Experiments were carried out by

means of a new apparatus designed by Dr. F. F. Blackman for measuring a small output of oxygen in photo-synthesis. The leaf is illuminated in a closed circuit in an atmosphere of hydrogen and carbon dioxide. In part of the circuit gases are carried over palladium black, so that oxygen produced unites with two volumes of hydrogen. The threefold reduction of volume resulting is measured by a gas burette in the circuit. In this apparatus oxygen pressure is kept so low that no further development of chlorophyll takes place, while photo-synthetic production of oxygen can be measured with great accuracy. If a leaf is cut from a seedling growing in the dark at an early stage of development, and then partially greened by exposure to light in air, its photo-synthetic activity when transferred to the apparatus will be very small or nothing. If exactly the same procedure is repeated a few days later, the photo-synthetic activity may be nearly as great as in the normally developed leaf.—Dr. B. Moore, E. Whitley, and T. A. Webster: Sunlight and the life of the sea. [Studies of the photo-synthesis in marine algae. (1) Fixation of carbon and nitrogen from inorganic sources in sea-water; (2) increase of alkalinity of sea-water as a result of photo-synthesis and as a measure of that process; and (3) relative photo-synthetic activity of green, brown, and red seaweeds in light of varying intensity.] The vernal outburst of green life which occurs at the spring equinox is occasioned by the rapid change in intensity of daily illumination. A study of the seasonal variations in plankton around Port Erin, Isle of Man, has now been carried on for many years by Prof. W. A. Herdman and his co-workers. In many years the great outburst of diatoms occurs before the temperature of the water has even begun to move from its winter level. It thus becomes clear that it is the longer, brighter day, with increased altitude of the sun, which is the primary factor in the sudden dawn of the life of the sea each spring. This is illustrated by a chart upon which are shown for each month (1) temperature of the sea, (2) number of diatoms, (3) hours of bright sunshine, (4) total radiant energy, and (5) the amounts of nitrogen peroxide present in the air (formerly called "ozone of the air" or "active oxygen"), as taken at Radcliffe Observatory, Oxford, by Schönbein's "Ozone" papers. A sudden rise in radiant energy in March is accompanied by (1) the diatomic outburst and (2) increased nitrite content. It has been shown that the growing diatoms capture this enormous increase of light, and utilise it for building both carbon and nitrogen into their organic substances. The source of the nitrogen is the atmospheric elemental nitrogen dissolved in the sea-water, and not ammonia, nitrites, or nitrates. The source of the carbon is the carbon dioxide of the bicarbonates of calcium and magnesium dissolved in sea-water. As this carbon is removed in photo-synthesis the sea becomes always more alkaline, and the change of reaction can be used as a rough measure of the marine crop. Although the increase of alkalinity is small, yet the volume of sea-water is so immense that, as has been pointed out by Moore, Prideaux, and George Herdman, supposing this to happen to a depth of 100 metres over the surface of the sea, then the crop of moist plankton per square kilometre would amount to about 1,500,000 kilograms. This corresponds roughly to about 10 tons per acre.

**Royal Microscopical Society, February 18.**—Prof. John Eyre, president, in the chair.—Dr. Agnes Arber: (1) Studies on the binucleate phase in the plant-cell. Rudolf Beer and Dr. Agnes Arber: (2) Multinucleate cells: an historical study (1879-1919). These two papers were read as one. It was pointed out that in

1844 Nägeli first stated that the plant-cell is essentially uninucleate. Those botanists who have from time to time directed attention to exceptions to Nägeli's rule, usually attributed little importance to them, but recent work has made it clear that a binucleate or multinucleate condition is a very constant character of young and active tissues. The authors' observations on the subject were then discussed, the case of the nuclei of the young inflorescence axis of *Eremurus himalaicus* being described in detail. It was shown that the binucleate condition arises by mitosis. The division is normal up to the formation of the daughter-nuclei and the initiation of the cell-plate. At this point the mechanism apparently breaks down, the cell-plate is resorbed, and the spindle-fibres and associated cytoplasm—the "phragmoplast" of Errera—become transformed into a hollow sphere which encloses the two daughter-nuclei, and eventually, by gradual expansion, merges with the cytoplasm lining the cell-wall. For this hollow shell, derived from the phragmoplast, the authors have proposed the term "phragmosphere" (Proc. Roy. Soc., B, vol. xci., 1919, p. 10). The question as to how the binucleate condition of these young cells passes into the uninucleate condition characteristic of mature tissues, was then considered. It was shown that, although bilobed nuclei often occur, which at first sight suggest that the two nuclei have fused together, more critical examination indicates that these nuclei are *single nuclei*, the lobing of which is an indication either of senility (axis of *Asparagus*) or, in some cases, of an effort by young and active cells to increase their nuclear surface (stelal parenchyma of roots of *Stratiotes*, leaf epidermis of *Hemerocallis*). The authors think it more probable that the uninucleate condition is restored by degeneration and resorption of one nucleus, than by the fusion of the two nuclei. The paper closed with a brief reference to the significance of the multinucleate phase.

#### MANCHESTER.

**Literary and Philosophical Society, February 3.**—Sir Henry A. Miers, president, in the chair.—Prof. E. Knecht: Alpine insolation effects on unprotected wood. Effect of direct sunshine on the wood of Alpine chalets. When exposed for about a hundred years the surface of the wood was sometimes charred or scorched to a uniform black, presenting under the microscope the appearance of coal. The changes were probably brought about more by thermo-chemical than by photo-chemical action. By prolonged heating of wood to 93° C. the author had produced incipient blackening of the surface. The temperature of decomposition of wood appeared to have an important bearing on the question of coal-formation.—W. Thomason and H. S. Newman: The behaviour of amalgamated aluminium and aluminium wire. Investigations on the fine feathery growths produced when aluminium wire is brought into contact with mercury. No such growths are obtained from amalgamated magnesium, although it undergoes oxidation more readily than aluminium at the ordinary temperatures of the air.—C. E. Stromeyer: The after-effects of cannibalism. Cannibalism would not be indulged in by people with vegetarian tastes, or by those who, having a craving for animal food, could satisfy it. Others who had this craving, but no animals to eat, would become cannibals. No State in which indiscriminate man-eating was indulged in could have flourished. Officials were therefore appointed who invented rites which became religious ceremonies. Human sacrifices were, to a certain extent, discontinued, but the rites were con-

tinued. Religious animal sacrifices of the ancients were an after-effect of human sacrifices, as is possibly our practice of saying grace before meat.

## PARIS.

**Academy of Sciences**, February 23.—M. Henri Deslandres in the chair.—M. L. Mangin gave an account of the life-work of Emile Boudier, correspondent in botany.—H. Andoyer: The method of Gauss for the calculation of secular perturbations.—L. Maquenne and E. Demoussy: The absorption of calcium by plants and its antitoxic properties towards copper. Calcium does not prevent the absorption of copper by the roots of plants, and copper does not prevent the assimilation of calcium. The antitoxic action of calcium, experimental proofs of which are given, is of a physiological order; it prevents a dangerous accumulation of the poisonous metal.—Y. Delage: Suggestion for the reason for the double force of certain birds of prey.—W. Kilian: The repartition of the facies of the Palaeo-Cretaceous in the structural units of the south-east of France.—J. Hadamard: Report on the works examined and retained by the Ballistics Committee during the period of the war.—Prof. Michelson was elected a foreign associate in succession to the late Lord Rayleigh, and M. Camille Viguier a correspondent for the section of anatomy and zoology in succession to the late Gustaf Retzius.—N. Sakellariou: The oblique linear and surface curvature of a surface.—H. Villat: Certain cyclic movements with or without vortices.—C. Rabut: Light concrete: the calculation of increase of power resulting from its use in building. Slag concrete is lighter than concrete made up with sand or gravel. A sketch of the theory of its application is given.—P. Le Rolland: The influence of the deformation of the knife-edge and of the plane of suspension on the time of swing of a pendulum.—H. Georges: A new alternating mercury arc. A description of a new quartz mercury lamp which with electromotive forces of more than 500 volts starts cold.—L. Guillet: The alloys of copper, zinc, and nickel. An account of the mechanical properties of alloys containing copper, 46 and 40.5 per cent.; zinc, 43.2 and 44.7 per cent.; and nickel, 10.4 and 14.4 per cent. Comparisons with brasses free from nickel are added. Compared with brass, these alloys possess advantages in colour, greater resistance to oxidation, and facility of forging at high temperatures.—C. Matignon and M. Fréjacques: The dissociation of ammonium carbamate. Dissociation pressures are given for temperatures ranging from 100° to 150° C.—M. Tiffeneau and A. Orekhoff: The transposition of the phenyl group in the tetrahydronaphthalene series.—R. Souèges: The embryology of the Chenopodiaceae. Development of the embryo in *Chenopodium Bonus-Henricus*.—L. Emberger: The evolution of the chondriome in the formation of the sporangium in ferns.—J. Pottier: The generality of the foliar asymmetry in mosses.—P. Dangeard: The evolution of the vacuolar system in Gymnosperms.—P. Portier and Mme. Lucie Randonin: The creation of vitamins in the intestines of rabbits receiving nourishment sterilised at a high temperature.

## Books Received.

Card Test for Colour Blindness. By Dr. F. W. Edridge-Green. 24 cards. (London: G. Bell and Sons, Ltd.) 25s. net.

The Development of the Atomic Theory. By A. N. Meldrum. Pp. ii+13. (London: Oxford University Press.) 1s. 6d. net.

The Social Worker. By C. R. Attlee. Pp. viii+286. (London: G. Bell and Sons, Ltd.) 6s. net.

Smithsonian Meteorological Tables. Fourth revised edition. Pp. lxxii+201. (Washington: Smithsonian Institution.)

The Summer Line, or Line of Position as an Aid to Navigation. By G. C. Comstock. Pp. vi+70. (New York: J. Wiley and Sons, Inc.; London: Chapman and Hall, Ltd.) 6s. net.

Blank Reduction Forms for Line of Position Observations (Marc St. Hilaire Method). By G. C. Comstock. (New York: J. Wiley and Sons, Inc.; London: Chapman and Hall, Ltd.) 2s. 6d. net.

Silvanus Phillips Thompson, D.Sc., LL.D., F.R.S.: His Life and Letters. By J. S. and H. G. Thompson. Pp. ix+372. (London: T. Fisher Unwin, Ltd.) 21s. net.

Wild Life in Canada. By Capt. A. Buchanan. Pp. xx+264. (London: J. Murray.) 15s. net.

Collected Scientific Papers. By Prof. J. H. Poynting. Pp. xxxii+768. (Cambridge: At the University Press.) 37s. 6d. net.

The Principles of Aerography. By Prof. A. McAdie. Pp. xii+318. (London: G. G. Harrap and Co.) 21s. net.

General Science: First Course. By L. Elhuff. Pp. viii+435. (London: G. G. Harrap and Co.) 5s. net.

Quantitative Analysis by Electrolysis. By A. Classen and H. Cloeren. Revised English edition by Prof. W. T. Hall. Pp. xiii+346. (New York: J. Wiley and Sons, Inc.; London: Chapman and Hall, Ltd.) 17s. 6d. net.

Practical Histology. By Prof. J. N. Langlev. Third edition. Pp. viii+320. (Cambridge: W. Heffer and Sons, Ltd.) 10s. 6d. net.

Fuel Production and Utilization. By Dr. H. S. Taylor. Pp. xiv+297. (London: Baillière, Tindall, and Cox.) 10s. 6d. net.

History of the Great War, Based on Official Documents. Naval Operations. By Sir Julian Corbett. Vol. i. Pp. xiv+470+vol. of 18 maps. (London: Longmans and Co.) 17s. 6d. net.

Nature and Super-Nature: A Key to the Spiritual World. By J. Leslie. Pp. 80. (Aberdeen: W. Jolly and Sons, Ltd.) 2s.

## DIARY OF SOCIETIES.

## THURSDAY, MARCH 18.

ROYAL INSTITUTE OF GREAT BRITAIN, at 3.—Stephen Graham: The

Spirit of America at the War.  
ROYAL SOCIETY, at 4.30.—W. B. Brierley: A Form of *Botrytis cinerea* with Colourless Sclerotia.—R. R. Gates: A Preliminary Account of the Meiotic Phenomena in the Pollen Mother Cells and Tapetum of Lettuce (*Lactuca sativa*).

LINEAN SOCIETY, at 5.—Dr. J. Small: The Chemical Reversal of Geopline Response in Roots and Stems.

ROYAL COLLEGE OF PHYSICIANS, at 5.—Sir John R. Bradford: The Clinical Experiences of a Physician during the Campaign in France and Flanders, 1914-1919 (Lumleian Lecture).

ROYAL INSTITUTE OF PUBLIC HEALTH, at 5.—Dr. S. V. Pearson: Suggested Reforms in the Campaign against Tuberculosis.

INSTITUTION OF MINING AND METALLURGY (at Geological Society), at 5.30.—W. R. Jones: Tin and Tungsten Deposits: The Economic Significance of their Relative Temperatures of Formation.

INSTITUTION OF ELECTRICAL ENGINEERS (at Institution of Civil Engineers), at 6.—Adjourned Discussion on the Papers of W. H. Pritchell and S. H. Fowles read at the Meeting on March 11.

CHEMICAL SOCIETY, at 8.—I. Masson and R. McCall: The Viscosity of Nitrocellulose in Mixtures of Acetone and Water.—H. Stephen, W. F. Short, and G. Gladding: The Introduction of the Chloromethyl Group onto the Aromatic Nucleus.—H. E. Cox: The Influence of the Solvent on the Velocity of Reaction between certain Alkyl Iodides and Sodium  $\beta$ -Naphthoxide.—H. Crompton and P. L. Vanderstichele: The Use of 1:2-Dichlorovinylethyl Ether for the Production of Chloroacetates and Acid Chlorides.

SOCIETY OF ANTIQUARIES, at 8.30.

## FRIDAY, MARCH 19.

ROYAL SOCIETY OF ARTS (Indian Section), at 4.30.—Sir William S. Meyer: The Indian Currency System and its Developments.  
CONCRETE INSTITUTE, at 6.—Dr. O. Faber: The Practical Application of Reinforced Concrete.

INSTITUTION OF MECHANICAL ENGINEERS, at 6.—D. Brownlie: Exact Data on the Performance of Mechanical Stokers, as applied to "Lancashire" and other Narrow-flued Boilers.

JUNIOR INSTITUTION OF ENGINEERS, at 7.30.—W. H. F. Robba: Shipbuilding and Ship Design (Geographical Society), at 7.—The Prehistoric  
ROYAL SOCIETY OF MEDICINE (Electro-Therapeutics Section), at 8.30.—  
Dr. A. E. Barclay and Others: Discussion on Radium-Theory and Radio-  
Therapy of Exophthalmic Goitre.—Dr. S. Russ: Vision by Ultra-violet  
Light.

ROYAL INSTITUTION OF GREAT BRITAIN, at 9.—E. McCurdy: Leonardo  
da Vinci.

#### SATURDAY, MARCH 20.

ROYAL INSTITUTION OF GREAT BRITAIN, at 3.—Sir J. J. Thomson:  
Positive Rays.

PHYSIOLOGICAL SOCIETY (at University College), at 4.—J. F. Donegan  
and Others: Innervation of Veins.

#### MONDAY, MARCH 22.

ARISTOTELIAN SOCIETY (at West W. 1), at 8.—C. C. J. Webb:  
Obligation, Autonomy, and the Common Good.

MEDICAL SOCIETY OF LONDON, at 8.30.—E. M. Little and Others:  
Discussion on the Re-education of the Amputated.

ROYAL GEOGRAPHICAL SOCIETY (at Philharmonic Hall), at 8.30.—Sir  
Ernest Shackleton: The 1914-1917 Antarctic Expedition.

#### TUESDAY, MARCH 23.

ROYAL ANTHROPOLOGICAL INSTITUTE AND PREHISTORICAL SOCIETY OF EAST  
ANGLIA (Joint Meetings) (at Geological Society), at 7.—The Prehistoric  
Societies of East Anglia.—Prof. J. E. Marr: Man and the Glacial Period  
(Presidential Address)—H. Dewey: Flat-based Celts from Kent, Hamp-  
shire, and Dorset.—Dr. A. E. Peake: Exhibit of Specimens found at  
Grime's Graves in 1919.

ROYAL HISTORICAL SOCIETY, at 3.—Rev. J. Jacob: Wandering down  
Old Garden Roads.

ROYAL INSTITUTION OF GREAT BRITAIN, at 3.—Prof. A. Keith: British  
Ethnology—The Invaders of England.

ROYAL COLLEGE OF PHYSICIANS, at 5.—Sir John R. Bradford: The  
Clinical Experiences of a Physician during the Campaign in France and  
Flanders, 1914-1919 (Lumleian Lecture).

INSTITUTION OF CIVIL ENGINEERS, at 5.30.—Col. D. Lyell: The Work  
done by Railway Troops in France during 1914-1919.

ROYAL ANTHROPOLOGICAL INSTITUTE AND PREHISTORICAL SOCIETY OF EAST  
ANGLIA (Joint Meetings) (at Geological Society), at 6.—Prof. A. Keith:  
How Far Can Character and Race Help in Estimating the Antiquity of  
Human Remains. (Lumleian).

ROYAL PHOTOGRAPHIC SOCIETY OF GREAT BRITAIN (Technical Meeting),  
at 7.—Dr. B. Glover: Factorial and Time Methods of Development  
applied to Bromide and Gaslight Papers; Theoretical Principles and  
Practical Demonstrations.

FARADAY SOCIETY (at Chemical Society), at 7.30.—General Discussion:  
Basic Slags: Their Production and Utilisation in Agricultural and other  
Industries. Prof. F. G. Donnan will preside over the discussion.—  
Dr. E. L. Russell will open the discussion and give a general survey of  
the subject.—H. H. Dewey will discuss the subject from the Physico-  
Chemical Standpoint.—Sir T. H. Middleton: The National Aspects  
of the Case for Increasing the Supplies of Basic Slag.—Sir A. Daniel Hall:  
The Demand for Basic Slag.—Prof. D. A. Gilchrist: Basic Slag and its  
Place in the Development of Agriculture.—G. Scott Robertson: A Compara-  
tion of the Effect of various Types of Open-hearth Basic Slag on  
Grassland.—Dr. J. E. Stead, F. Bainbridge, and E. W. Jackson: Papers  
on Solubility of Basic Slags.—D. Sillars: The Formation of Basic Slag  
in the Manufacture of Steel.—W. S. Jones: The Improvement of Low-  
grade Basic Slag.

#### WEDNESDAY, MARCH 24.

INSTITUTION OF NAVAL ARCHITECTS (at Royal Society of Arts), at 11.—  
The Earl of Durham: Presidential Address.—Sir Eustace D'Eyncourt  
H. M. S. Hood.—A. W. Johns: German Submarines.—G. S. Baker: Mode  
Experiments in Connection with Submarine Warfare.

ASSOCIATION OF ECONOMIC BIOLOGISTS (General Meeting) (in Botany  
School of the Imperial College of Science and Technology), at 11.30.—  
Short Communications and Exhibitions.—D. W. Cudger: The Relation  
of Protozoa to Soil Problems.—Wimfred E. Brenchley: Correlation  
between Seed and Crop.—At 2.15.—Dr. W. Lawrence Balls: The Nature  
and Scope of Biological Research in the Cotton Industry.—M. G. Rayner:  
The Calcicole Habit of *Linum catharticum* and other Erica-cous  
Plants.—H. Worsdell: Shoot Wilt of Plum Trees.

ROYAL SOCIETY OF ARTS, at 4.30.—L. Gaster: Industrial Lighting in its  
relation to Efficiency.

GEOLOGICAL SOCIETY OF LONDON, at 5.30.—Mrs. E. M. Reid: Two Pre-  
glacial Floras from Castle Eden, Durham, and a comparative Review of  
Pliocene Floras, based on the Study of Fossil Seeds.

PSYCHOLOGICAL SOCIETY (Industrial Section) (at Examination Rooms of  
the Royal College of Physicians, 8-11 Queen Square, W.C. 1), at 6.—  
Miss G. Broughton: The Psychological Causes of the Wastage of Labour  
in Factories employing Women.

#### THURSDAY, MARCH 25.

INSTITUTION OF NAVAL ARCHITECTS (at Royal Society of Arts), at 11.—  
Sir Alfred Yarrow: Notes on our Economic Position as a Shipbuilding  
Country.—J. Anderson: Further Notes on the Dimensions of Cargo  
S.eamers.—Dr. J. Bruhn: Freeboard and Strength of Ships.

INSTITUTION OF NAVAL ARCHITECTS (at Royal Society of Arts), at 3.—  
P. R. Jackson: The Stabilisation of Ships by means of Gyroscopes.—  
Prof. K. Suyehiro: Yawing of Ships caused by Oscillation amongst  
Waves.

ROYAL INSTITUTION OF GREAT BRITAIN, at 3.—Stephen Graham: The  
Hope for Russia.

ROYAL SOCIETY, at 4.30.—Probable Papers: Prof. A. R. Forsyth: Note  
on the General Differential Equation in the Relativity Theory of Gravi-  
tation.—R. D. Oldham: The Frequency of Earthquakes in Italy in the  
Years 1896 to 1914.—A. F. Dufton: A New Apparatus for Drawing Conic  
Curves.—Capt. J. W. Bishop: An Experimental Determination of the  
Distribution of the Partial Correlation Coefficient in Samples of 30.  
CHEMICAL SOCIETY (Annual General Meeting), at 5.—Sir James J. Dobbie:  
Presidential Address.

ROYAL COLLEGE OF PHYSICIANS, at 5.—Sir John R. Bradford: The  
Clinical Experiences of a Physician during the Campaign in France and  
Flanders, 1914-1919 (Lumleian Lecture).

CHILD-STUDY SOCIETY (at Royal Sanitary Institute), at 6.—Dr. E. Sloan  
Chesser: Adolescence and the Continuation School.  
INSTITUTION OF ELECTRICAL ENGINEERS (at Institution of Civil Engineers),  
at 6.—Discussion on:—(a) The Electrical Equipment of Artisan Dwell-  
ings (with Introductory Paper by L. Milne). (b) The Report of the  
Farthing Sub-Committee of the Wiring Rules Committee of the Insti-  
tution.

INSTITUTION OF NAVAL ARCHITECTS (at Royal Society of Arts), at 7.30.—  
C. I. R. Campbell and C. H. May: The Effect of Size upon Performance  
of Rigid Airships.—Prof. E. G. Coker and A. L. Kemball, jun.: The  
Effects of Holes, Cracks, and other Discontinuities in Ships' Plating.  
CHEMICAL SOCIETY (Informal Meeting), at 8.

#### FRIDAY, MARCH 26.

INSTITUTION OF NAVAL ARCHITECTS (at Royal Society of Arts), at 11.—  
Eng.-Com. H. B. Tostevin: Experience and Practice in Mechanical Re-  
construction in Warships.—J. J. King-Salt: The Balancing of Rotors  
and Determining the Position and Am of the Balancing Weights.—  
Prof. T. H. Havelock: Turbulent Fluid Motion and Skin Friction.  
PHYSICAL SOCIETY OF LONDON, at 5.—Prof. A. S. Eddington and Others:  
Discussion on Einstein's Theory of Relativity.

WIRELESS SOCIETY OF LONDON (at Institution of Civil Engineers), at 6.—  
Capt. L. A. T. Broadwood: Harmonics in Continuous Wave Transmissions  
(illustrated by Lantern Slides and Experiments).

INSTITUTION OF MECHANICAL ENGINEERS (Informal Meeting), at 7.—  
P. L. Young and Others: Discussion on Foundry Memoranda.

ROYAL INSTITUTION OF GREAT BRITAIN, at 9.—Sir J. J. Thomson: The  
Scientific Work of the late The Right Hon. Lord Rayleigh.

#### SATURDAY, MARCH 27.

ROYAL INSTITUTION OF GREAT BRITAIN, at 3.—Sir J. J. Thomson:  
Positive Rays.

## CONTENTS.

	PAGE
Science and the New Army	61
The Roast Beef of Old England. By C. C.	62
French Text-books of Chemistry. By J. B. C.	63
Indian Beetles. By C. J. G.	64
Mathematics: Pure and Applied. By Dr. S. Brodetsky	65
Our Bookshelf	67
Letters to the Editor:—	
Museums and the State.—Prof. E. W. MacBride, F.R.S.; Prof. J. W. Gregory, F.R.S.; Dr. F. A. Bather, F.R.S.; Dr. Wm. Evans Hoyle; William G. Wagner	68
Some Methods of Approximate Integration and of Computing Areas.—A. S. Percival	70
An Electronic Theory of Isomerism. (With Diagrams.)—Dr. H. S. Allen	71
The Principle of Equivalence and the Notion of Force.—C. A. Richardson	72
Expenses of Scientific Work.—Major A. G. Church	72
Scientific Reunions at the Natural History Museum.—Dr. G. F. Herbert Smith	72
The World's Production of Silver	73
Time-reckoning of the North American Indians	75
Obituary: Dr. Charles Gordon Hewitt	75
The Gyrostatic Compass. (Illustrated.) By S. G. Brown, F.R.S.	77
Notes	80
Our Astronomical Column:—	
The Total Solar Eclipse of September 20, 1922	84
The Binary Star $\alpha$ Eridani	84
Faint Nebulae	84
International Fishery Investigations	86
Exhibition of Diseases of the Para Rubber-tree	86
The Position of the Meteorological Office	87
Earthworks and Retaining Walls	87
Fellowship of the New Zealand Institute	88
The Proposed University of Reading	88
University and Educational Intelligence	88
Societies and Academies	89
Books Received	91
Diary of Societies	91

Editorial and Publishing Offices:

MACMILLAN AND CO., LTD.,  
ST. MARTIN'S STREET, LONDON, W.C.2.

Advertisements and business letters to be addressed to the  
Publishers.

Editorial Communications to the Editor.

Telegraphic Address: PHUSIS, LONDON.  
Telephone Number: GERRARD 8830.



THURSDAY, MARCH 25, 1920.

### Knowledge and Power.

**T**O-DAY, in almost every sphere of activity, as it is widely recognised, the majority of the important problems that have to be handled are largely technical in character; this is so whether these problems lie in the broad domain of national policy, in the narrower limits of administrative action, or in the restricted fields of executive performance. To this situation is due, as is well known, the need that has arisen in recent times for that high degree of specialisation in certain kinds of knowledge which has revolutionised the scheme of organisation of the *personnel* in the fields of commerce and industry, and is likewise responsible for the introduction, in many enterprises throughout the world, of the *régime* of the expert.

Being, comparatively speaking, a newcomer in the realms of officialdom, the modern technical expert has still to be assigned his place of precedence there, and at the same time to have the scope of his authority and the dignity of his status definitely determined and unequivocally declared. These are matters calling for early attention, for a suspicion exists, not without foundation, that, whilst in commercial and industrial circles the expert has been very generally permitted to occupy a position of influence compatible with the importance of his *métier*, in the governmental sphere the expert has, more often than not, been relegated to a position in which his every purpose is rendered more or less ineffectual, one, moreover, in which the exercise of his legitimate activities is barely tolerated by those occupying the clerical or controlling positions.

During the past few years the prevailing uneasiness regarding the unsatisfactory footing on which the technical staff in the public services finds itself has been quickened, owing largely to an appreciation on the part of the public of the fact that it was the failure in governmental quarters to give heed to the advice of the technical expert that was responsible for bringing the country to the brink of a dire catastrophe—one, indeed, which, at the crisis of the late war, threatened its continued existence as an independent people, one from which it escaped with but a very narrow margin.

The British public had been persuaded to believe that any deficiency in the military

establishments of the country was more than counterbalanced and compensated for by reason of the high perfection to which every detail connected with the Royal Navy had been brought. In the circumstances, the public may well be pardoned for the belief so firmly held by it before the Great War that the British Navy had nothing whatever to learn from either friend or foe.

That the popular conceptions on the foregoing matters were in many respects erroneous now stands out in cold print in the pages of Lord Jellicoe's "The Grand Fleet, 1914-16."<sup>1</sup> In the preface to this book it is stated in unequivocal terms that the Germans were "superior to us in material." The gallant Admiral does not limit himself to generalisations, but on many a page he particularises the specific matters in which the equipment or arrangements on our battleships were deficient, defective, or obsolete, and our defence works wanting. For example, he states: "The Jutland battle convinced us that our armour-piercing shell was inferior in its penetrative power to that used by the Germans." "Some delay occurred in improving our range-finders. . . . Our most modern ships were provided with range-finders 15 ft. in length, but the majority of the ships were fitted with instruments only 9 ft. long. During 1917 successful steps were taken to supply range-finders up to 25 ft. and 30 ft. in length; a series of experiments with stereoscopic range-finders was also instituted in the same year. It had become known that the Germans used this type of range-finders." "The use of smoke screens was closely investigated as a result of our experience of the German use of this device." "Neither our searchlights nor their control arrangements were at this time of the best type." The foregoing are but a few of the specific matters in which the foremost Navy in the world is recorded to have been outstripped, at a critical period of the war, by a rival of new creation.

In other directions, too, was Great Britain lacking in the matter of naval defence. For example, reference is made by Lord Jellicoe to the fact that harbour defences and obstructions were non-existent in the early days of the war. Again, it is stated that in the matter of gunnery and torpedo practices considerable leeway had to be made good. As regards the former, after the outbreak of war a great extension of the system of director firing, by which one officer or man can

<sup>1</sup> Published by Cassell and Co., Ltd. Price 31s. 6d. net.

lay and fire all the guns of a ship, was made (in August, 1914, only eight battleships had been fitted with this system).

In the face of the disclosures made in connection with the Battle of Jutland, it may well be asked whether the deficiencies and defects to which attention has been directed could have been foreseen in peace time and provided against. Little doubt on the subject can be left in the minds of those who read in a spirit of inquiry "Fifty Years in the Royal Navy," the autobiography of Admiral Sir Percy Scott<sup>2</sup>; the matters dealt with therein provide a direct answer to the foregoing question. In many of the pages of this autobiography will be found the story of the striving, over a long period of years, after progress and efficiency in relation to various details connected with the Senior Service, and of the obstinate opposition to all reforms which was constantly met with by those who were in pursuit of essential improvements. The remarks of Sir Percy Scott on every subject the theme of which relates to the attempt to introduce into the public service some new idea or device, or some improvement on existing apparatus, machinery, or methods, have all the same ring about them. In relation to every one of the matters to which the distinguished Admiral refers, the conduct of those in the controlling positions was consistent; in every instance the advice and assistance of the expert were ignored, either until it was altogether too late, or until considerable harm had been done and the waste of much public money, if not also the loss of valuable lives, involved.

Sir Percy Scott tells us that it was so long ago as February 10, 1909, that battle practice first took place, at Tetuan, with extemporised director firing. Yet it took the Admiralty two years to come to a decision as to its introduction into the Navy, and the Board waited for eight years—indeed, until the nation had for nearly three years been involved in a life-and-death struggle—before it adopted the system generally.

Another remarkable illustration of Admiralty methods mentioned by Sir Percy Scott is that connected with the depth charge, which ultimately turned out to be the antidote to the submarine. The design of a depth charge, actuated by a hydrostatic valve, was submitted by Capt. P. H. Colomb on October 1, 1914. The idea was so simple that these depth charges could have been

supplied in large quantities within a few weeks of the date mentioned, but it was not until 1916 that a decision was arrived at on the matter; meanwhile, the delay, it is stated, involved the nation in a loss of 200,000,000*l*.

A similar striking example of officialism occurred in relation to the Pomeroy bullet, which was eventually successfully used in attacking Zeppelins. This bullet had been first tried in 1908, and gave satisfactory results; it was submitted to the War Office in 1914, but rejected. In June, 1915, another trial was made of the bullet, and again it proved satisfactory; however, it was not accepted and brought into use until the autumn of 1916—that is to say, the country had to wait two years for the adoption of an essential missile which was urgently wanted, in spite of the fact that the efficacy of the invention had been unmistakably proved many years previously.

Instances of official ineptitude and bureaucratic formalism similar to those referred to in the foregoing examples, and others mentioned in Sir Percy Scott's autobiography, are, unfortunately, all too common in practically every Government Department in this country, and arise all from the same cause, the ignoring of the advice and opinions of the technical expert and a fixed distrust of him. Expression was given to this attitude a few years ago by an official of the administrative branch of a Government Department during an inquiry before a Select Committee of the House of Commons into an important engineering contract—a contract in which the technical staff had been entirely ignored at every stage connected with its negotiation. "I do not think," said this official, "these gentlemen, the highly technical experts, are suited, by their education or their environment and line of thought, and all that sort of thing, to decide very often what is the best thing to do. They jump to a conclusion." Yet the most superficial examination of the evidence that exists in relation to the measures and steps by which the technical expert has succeeded in providing man with the material comforts enjoyed by him, and by which there have been placed at the command of the business community the powerful aids to commerce and industry comprised in the domain of the public utility services, affords the most complete contradiction of the mischievous doctrine contained in the foregoing utterance.

It must not be imagined that it is alone in relation to questions of high policy, such, for

<sup>2</sup> Published by John Murray. Price 21*s*. net.

example, as the Dardanelles Expedition—with regard to which it is recorded in Lord Fisher's "Memories"<sup>3</sup>: "The Cabinet Council reached its conclusions without drawing the opinion of the expert thereat for its guidance"—that the technical experts are ignored; on the contrary, many examples can be given of instances when, in relation both to important technical aspects of departmental policy and to simple matters of executive detail, the advice of the technicians has been overruled or not sought.

The root cause of the mischief under discussion lies in the system of the Civil Service. A privileged class has been allowed to grow up there, a class which, by reason of its proximity to the Minister and of the long service of the individual members composing it in one particular office, has obtained too great an influence, and is thus enabled to exercise an ascendancy not only over Ministers, who flit through their Departments, but also over those officials whose early years are spent on executive and technical duties.

The remedy for the present unsatisfactory state of affairs as regards the position of the technical expert is not far to seek. As matters stand to-day, the technical staffs in the Government Departments have too little influence and authority, whilst the Civil Service clerk has too much influence and an excess of authority. The disparity between the powers of these two classes is a source of public danger, and the way to obviate it is by a thorough reorganisation of the Civil Service and its system. What is required is that the chief administrative posts shall forthwith cease to be a monopoly of the clerical staffs. A suitable organisation for the Civil Service would be one which provided that entrants into every branch of it should, as a rule, begin their careers in an executive grade, and be promoted to occupy administrative posts at the headquarters of a Ministry or Department only after giving proof that they were familiar with the practical aspects of the matters they might be called on to administer. By the introduction of such an organisation into the Civil Service, it would be possible to select the best qualified officers in each branch for the important administrative posts, and, in consequence, render possible the adoption of a system whereby all matters referred to headquarters on which decisions have to be passed would come invariably before those who were experts in the particular subject upon which action had to be taken.

## Aeronautical Research.

*Applied Aerodynamics.* By Leonard Bairstow. Pp. xii+566. (London: Longmans, Green, and Co., 1920.) Price 32s. net.

MPATIENTLY as we have waited for the publication of this book, we feel that its appearance could scarcely have been more opportune. For here, as we believe, will be found abundant evidence in support of those who, like the Committee for Education and Research in Aeronautics, have striven to resist the break-up of our aerodynamics laboratories and design staffs. Research is always costly, aeronautical research superlatively so; and a public whose ear has been somewhat dulled by the insistence with which its claims were urged—not always wisely—during the war is somewhat naturally deafened now, by strident calls for economy, to any temperate statement of its claims. It is not promises that are wanted at the present time, to justify further expenditure, but a record of things achieved; and although the tangible results of British science and invention, as applied to the construction of aircraft, have appealed, and by the glamour of long-distance flying are still appealing, to the popular imagination, yet it has resulted from secrecy necessary in war time that the foundations upon which these successes have been built—the patient, detailed investigations which have supplied our designers with the data they required—are familiar only to a very few, being for the most part contained in reports of which the circulation, no less than the appeal, has been limited to specialists.

Now, within one volume of reasonable dimensions and large type, we are presented with an authoritative review of the work achieved by our research organisations during five years of strenuous activity. We have no fears that impartial judgment will pronounce the time and expenditure to have been wasted. Most branches of applied science have developed rapidly under the stimulus of war conditions, but of applied aerodynamics it might without serious exaggeration be said that the science has been created. The pioneer work is done, but to those who read Mr. Bairstow's book carefully it will be evident that on every side lie fields for research of which scarcely the surface has been broken, and that no mistake could be more disastrous, if we acknowledge the importance of aeronautics, than a refusal now to avail ourselves of the experience acquired by those few men to whom its present state of development is due.

We do not, of course, imply that the book is

<sup>3</sup> Published by Hodder and Stoughton. Price 21s. net.

merely a record of war developments, still less an apologia for the aerodynamics laboratories. It is, both in intention and in effect, a handbook for the student, for the designer, and for the research worker, which assumes no previous knowledge in the reader, beyond the elements of hydrostatic theory, and illustrates the applications of aerodynamics in all its essential branches. Mr. Bairstow's qualifications for authorship are too well known to need description here. A leader in aerodynamic research at the National Physical Laboratory since the formation of the Advisory Committee for Aeronautics in 1909, his duties as expert adviser to the Air Board and Ministry during the war brought him into intimate contact with every side of aeronautical activity. Of great importance, in our opinion, is the fact that he has had first-hand acquaintance with research on both the model and the full-scale aeroplane, and so is entitled—whether we agree with his conclusions or not—to pronounce with authority upon the vexed questions which relate to "scale effect." But copious knowledge has not always, in the past, given us satisfactory text-books, and it is a real pleasure to find how well balanced is the structural scheme which Mr. Bairstow has devised. After touching lightly, but adequately, upon the early history of his subject, and having illustrated its present state of development by brief descriptions of typical modern aircraft and engines, he passes at once to a discussion of the principles of flight, and in his second chapter, within some fifty pages, the reader learns, by actual examples fully explained, how to make practically all the fundamental calculations required in estimating the performance and characteristics of aircraft.

In our opinion, this is one of the best features of the book. Aerodynamics is an empirical science, and design proceeds by the manipulation of experimental curves which, with rare exceptions, cannot be represented by mathematical functions; present-day developments consist almost entirely in refinement of the experimental data and of the methods of their manipulation, and thus have a tendency to obscure, for the general reader, the basic principles involved. By discarding all refinements, whilst extending his specimen calculations to cover a wide range of problems, Mr. Bairstow emphasises the fundamental principle that all design is conditioned by the experimentally determined properties of the wing section, and thus prepares his reader for an intelligent appreciation of the more detailed considerations which follow.

Chap. iii., which deals with experimental methods of measurement, as they have been developed in the aerodynamics laboratories, is

characterised by the same breadth of view and neglect of unnecessary refinement. In it the reader, now initiated into the problems which the science of aerodynamics has to solve, learns how these problems are attacked on the experimental side, and what order of accuracy may reasonably be expected in their solution. The account given on p. 115 of the theory of model experiments on non-rigid airship envelopes might seem to suggest that the model scale should be chosen so as to give (in theory) *equality* of fabric tensions, whereas actually, of course, it is easy to obtain *proportionality* in a model of any scale, and increase in scale has the advantage that it reduces the error introduced by the weight of the fabric. Again, we could have wished that some description had been included of the "cascade" experiment on aerofoils, which seems so promising a line of development for propeller theory; but from a footnote on p. 290 we gather that the technique of this experiment had not been fully worked out at the time of writing.

Considerations of space prevent us from dealing as we could have wished with chap. vii., an admirable *résumé* of the investigations which have been made—without very much result, so far, as regards their practical application—into the theory of fluid motion, and with chap. viii., in which the author states his present position on the question of "scale effect." Not long ago this was a question which divided aeronautical experts into two fiercely warring bands: but the heat of that battle has since died down, and we imagine that few will take exception to Mr. Bairstow's summing up of the position. Scale effect, or at any rate its possibility, is indicated by theory; it is proved beyond question to exist in many of the problems which can be investigated in wind-channels, and it may very well be present to a troublesome degree in many of the problems which concern the complete aircraft: but the order of accuracy hitherto attainable in full-scale work is too far below the ordinary standard of wind-channel work to justify us in attributing to scale effect every discrepancy which has been discovered in the comparison of model and full-scale data.

The remainder of the book, which analyses and applies the design data from the aerodynamics laboratories, scarcely affords suitable material for criticism on a first reading; ultimately these chapters must be judged by the service which they render, in daily use, to the design office and the laboratory. We shall content ourselves by mentioning one particular in which, as we believe, the book could be improved in a second edition. We do not think it is merely

a personal preference which has been disappointed by the scantiness of the references in this volume to original sources of information, and to authors; in our opinion, the more authoritative a book is, the more importance attaches to complete references, whereby the reader is assisted in pursuing his investigations into any particular question which interests him. We hold, too, that the mention of authors' names is important for other reasons than the mere gratification of their personal vanity; it is an aid to memory and to verbal discussion (how otherwise—to take examples at random—shall we attain to the definiteness of meaning which we associate with "Lenz's law," the "Rankine cycle," "Bernoulli's equation," or the "Willan's line"?); and it is of enormous assistance to the reader in helping him to fit each new fact or theory into his mental picture of the scientific structure. We might add that consistency demands either the suppression of all references to individuals (which is no longer thinkable) or the adoption of the course which we advocate: no one would accuse Mr. Bairstow of partiality (and if a refutation of the charge were wanted, it could be found in the entire absence of all reference to his own part in the work which he describes), yet we have been struck by the apparent arbitrariness with which authors' names have been included or suppressed. We are conscious that it would be very difficult to give complete references at the present time, mainly because of the unfortunate preference for anonymous reports which was so prevalent in the early days of the war; but this difficulty should be removed by the publication of the reports in their final form, and we shall hope then to see those additions which will make this book the standard work of reference in its subject.

The printing and paper of the book are good, and a special word of praise is due to the illustrative diagrams, which appear to have been re-drawn specially for this work. The book is thick and rather heavy, and those who will make it a work for daily reference will probably find it desirable to clothe it in rather stronger binding.

### Gymnospermic History.

*Fossil Plants: A Text-book for Students of Botany and Geology.* By Prof. A. C. Seward. Vol. iv. : *Ginkgoales, Coniferales, Gnetales.* (Cambridge Biological Series.) Pp. xvi+543. (Cambridge: At the University Press, 1919.) Price 1 guinea net.

TO every science, works which bring together the data of the subject are essential, and to none more so than to palæobotany, which is based

on the correlation of fragmentary remains from all countries and of all ages. Prof. Seward has served his science well in completing the almost Herculean task of writing a text-book covering the whole field of these plant remains. The first volume appeared many years ago, and this, the fourth, is the final one of the series.

This disappointingly closes with the higher Gymnosperms, the series of plant families treated, and the author does not propose to continue the work so as to deal with the flowering plants. This is perhaps scarcely surprising, as the data bearing on the flowering plants are very complex and of a fragmentary and unsatisfactory nature, and have, moreover, been little studied in this country. Some up-to-date handling of the Angiosperms is greatly to be desired, and students will await with some impatience the appearance of the independent work Prof. Seward promises, in which he proposes to deal with the generalities of plant distribution, taking the fossil Angiosperms into account.

Prof. Seward's text-book should be a useful tool, not only to palæobotanists in particular, but also to all students of either botany or geology in general. Somewhat lost sight of in the mass of fossil species, there are, prefacing each group, excellent accounts of the living representatives of each family.

In a volume of such laborious detail as the present one, which appeals to the specialist rather than to the average layman, there must, of course, be many comparative trifles which tend to sidetrack any critic by inducing an attempt to deal with minor controversial matter. To do this, however, in a general review would be both ungenerous and unfair, because the amount of public recognition and the gratitude which scientific authors receive is small and out of proportion to the labour and to the sacrifice involved in their tasks.

Misprints are remarkably few, and the general perspective of presentation is well preserved, although here and there the author has naturally indulged in rather longer descriptions of one or two individual species which are first published in this book than such specimens would be allowed had they been published separately at an earlier date. It is doubtful, as a matter of general policy, whether a text-book is the place to publish new species at all, although any research worker must have in his notes records of small and relatively unimportant species which scarcely deserve independent memoirs, and the temptation to put them in the text-book must be very great.

Knowledge of the higher Gymnosperms largely depends on petrified material of secondary timber, for although fragments of foliage impressions with a few cones are known, they are compara-

tively rare. The Mesozoic and Tertiary rocks, however, are rich in silicified and other petrified woods, many of which belong to the coniferous genera. The determination of these woods is a particularly difficult branch of palæontological research, demanding great patience and knowledge of the finer points of plant structure. Wood determinations are often—indeed generally—neglected, owing to the difficulty of mastering the technique; but, as Prof. Seward truly says, “the student cannot afford to neglect this line of inquiry if he desires to obtain a comprehensive view” of the essentials of palæontological plant history. In the present volume a considerable proportion of the space is allotted to the careful and critical consideration of the species based on secondary wood.

The terminology of this section is not entirely that adopted by other leading workers in this field, but tends perhaps to simpler grouping of the subject by the elimination of certain “genera” which are based on distinctions too subtle for secure determination, such, for instance, as the *Phyllocladoxylon* of Gothan. The elimination of doubtful genera, principally those which have names suggestive of affinities remote from those with which they properly are really to be associated, on the whole tends towards the clarifying of the science.

In conclusion, one can only urge every geologist and every botanist not only to possess himself of Prof. Seward’s text-book, but also to acquaint himself with its contents.

### The Nature of Musical Sound.

*The Foundations of Music.* By Dr. Henry J. Watt. Pp. xvi+239. (Cambridge: At the University Press, 1919.) Price 18s. net.

THE author unfolds a new theory to account for the fact that certain combinations of sound, called concords, are “pleasant,” while others, called discords, are “unpleasant.” In place of the ancient theory by which the “harmony of numbers” in the sense of proportions of string-length to pitch has dominated these questions since the days of Pythagoras, he considers that sound possesses “volume,” an attribute somewhat difficult to grasp at first sight. So far as we can understand the new theory, the volume of a low sound contains within itself the volumes of all sounds higher than itself; the proportions of the various volumes coincide with the well-known proportions of those of pitch. Hence the volume of the sound represented by C is exactly double that of the next C above it, and the volume of G, lying between the two, is two-thirds that of the lower C.

As the lesser volume is contained in the greater, there is “fusion” of volume when two sounds are heard together. This fusion being complete in the octave, the two sounds coalesce to such an extent as sometimes to be heard as one sound. We are to understand, then (so far as we can make out), that the octave is the “pleasantest” interval. Next come fifths and thirds as pleasant intervals; and the discords, the volumes of which do not fuse with the root volume, are classified as “unpleasant” (pp. 24 *et seq.*), or words to that effect. We confess that this theory is so novel that we find it hard to grasp. To the musician a discord is not an “unpleasant” part of his raw material; it is simply a chord that requires to be “resolved” into a succeeding chord. It has, therefore, the element of motion, while the concord suggests repose.

The theory of fusion raises the ancient question of the prohibition of consecutive fifths and octaves. The author discusses at great length all the well-known attempts at explanation, and adds his own. Probably the prohibitions are merely conventions, as suggested by Cyril Scott, quoted in a footnote on p. 132. In the tenth century Hucbald says of the ancient organum of his day: “If sung with suitable slowness, you will see that it produces a sweet concord.” The present reviewer, wishing to scoff at the notion that successions of fifths and octaves could “produce a sweet concord,” asked the choir of the Plainsong Society to sing a specimen of tenth-century organum. To his and their surprise they found Hucbald entirely vindicated. And Dr. Watt shows (p. 84) that Gevaert, making a similar experiment at Ghent in 1871, found exactly the same result: “The impression made on the audience was profound.”

The only example Dr. Watt gives in musical notation (p. 120) is a series of consecutive fifths by Karg-Elert, played very slowly on the softest organ stop. He offers an explanation of its “beauty”; we think, however, that the same passage, if sung or played rapidly and loudly, would be anything but beautiful.

Dr. Watt revives the old controversy as to whether the interval of the fourth is a concord or discord. We thought that musicians had long settled that the fourth from the bass, since it requires resolution, is a discord, while the fourth from any other voice is a concord, since it does not require to move.

The book ends with chapters on “The Objectivity of Beauty” and “Æsthetics as a Pure Science.” To those wishing to investigate the nature of sound, its new outlook should prove interesting.

## Science of Food.

- (1) *Bacteriology and Mycology of Foods*. By Dr. Fred Wilbur Tanner. Pp. vi+592+10 plates. (New York: John Wiley and Sons, Inc.; London: Chapman and Hall, Ltd., 1919.) Price 28s. net.
- (2) *Food: Its Composition and Preparation. A Text-book for Classes in Household Science*. By Mary T. Dowd and Jean D. Jameson. (The Wiley Technical Series.) Pp. viii+173. (New York: John Wiley and Sons, Inc.; London: Chapman and Hall, Ltd., 1918.) Price 6s. net.

THESE two books are very laudable attempts by our American cousins to place the important question of food on a scientific basis. The war brought home to people at large the importance of such study, but one hopes, in days of peace, not only that investigations will continue, but also that their application will be carried out to a greater extent.

(1) The first of the two books mentioned above is very complete, not only in the number of important foods dealt with, but also in the numerous methods of investigation described to detect impurities and prevent contamination with undesirable admixtures. It is the science of cleanliness in technical costume. The preface informs us that the work is written for those who wish to fit themselves for food control; but as it presupposes a thorough training in bacteriology and chemistry, we fear it will scarcely appeal to those who are food controllers here. What is really wanted is a book that he who runs may read, a book intelligible to the manufacturer, the packer, the tradesman, and the housewife. To present such with the graphic formulæ of, say, amino-acids and fats would be simply to terrify them. Still, the book should be useful to a more limited section of the population—namely, the analysts and bacteriologists. Its price strikes one as exorbitant even in these days of high charges.

(2) The second book is of a much more practical nature, and will be welcomed by all those engaged in the study of household science. It is an excellent chemical introduction to the science of intelligent cookery. The authors have taken care to provide themselves with a good preliminary knowledge of physiology and bio-chemistry, and if they go a little wrong in a few details, such as in their account of the vitamins, the slips are trivial, and do not affect their main arguments or their main endeavour, which is to rescue cookery from the domain of empiricism and ignorance.

W. D. H.

## Our Bookshelf.

*Petrology for Students: An Introduction to the Study of Rocks under the Microscope*. By Dr. Alfred Harker. Fifth edition, revised. (Cambridge Geological Series.) Pp. viii+300. (Cambridge: At the University Press, 1919.) Price 8s. 6d. net.

A HEARTY welcome must be extended to this new edition of one of our most widely known geological text-books, which has had considerable influence in securing systematic and accurate descriptions of rocks by British petrologists. The present edition contains a few pages less than the previous issue, but this has been accomplished by diminishing the space at the headings of chapters and by the excision of superfluous notes and references to occurrences of minor interest, so that the value of the book is in no way diminished. New illustrations have been added, and the chapters on metamorphism largely re-written.

As in previous editions, the author rejects names given unnecessarily to local varieties, which he distinguishes simply by reference to the places from which the names were formed. This process might with advantage have been carried very much further. There is, however, already so much diversity in petrological nomenclature, not only in different countries, but also among individual geologists, that the author is probably wise in refraining from attempting any far-reaching reforms.

Perhaps in another edition a certain number of analyses of the more important rock-species might be included, as well as their specific gravities, which afford a valuable means of checking the determination of rocks in the field. J. W. E.

*Chemistry and its Mysteries: The Story of What Things are Made Of, Told in Simple Language*. By Charles R. Gibson. (Science for Children.) Pp. 246. (London: Seeley, Service, and Co., Ltd., 1920.) Price 4s. 6d. net.

HERE is another of Mr. Gibson's wonderful books for children. This time Mr. Gibson treats of the elements of chemistry, the conception of chemical constitution, combustion and respiration, electrolysis, spectroscopy, and "queer things" such as radium and liquid air. The author has not lost his powers of stating scientific propositions in simple and attractive form without departing (except in quite minor details) from the strictest accuracy. We confess that we had thought modern children rather more sophisticated and apt to regard as ridiculous analogies drawn from nursery games; but in this matter we bow to Mr. Gibson's judgment. His success in what he has set himself to do is beyond question; criticism, if any were offered, would concern rather his objects. But this is not the place to inquire whether it is really useful, or even harmless, to present the complex and highly theoretical conclusions of modern science without any serious attempt to present also the evidence on which they are based.

*Neue Beobachtungen über den Erreger der Maul- und Klauenseuche: Die Entwicklung des Schmarotzers im Blut, speziell in den roten Blutkörperchen.* By Dr. Hrch. Stauffacher. Pp. 62 + plates. (Zürich, 1918.) Price 8 francs.

THE author describes and illustrates a number of curious linear and spherical bodies found in the red corpuscles of animals with foot-and-mouth disease, and works out a life-history for them along the lines familiar from the parasites of malaria. The difficulty in all such investigations is to be sure that the intracellular appearances represent the cause rather than the effect of the disease, and to distinguish between a parasite and some remnant of the nucleus of the erythroblast seems often to be impossible. Sometimes the nuclear remains are plain as such; sometimes by special methods they can be brought to take a basic stain in cells which by ordinary procedures would appear normal; it is quite possible that they may be thus unmasked in consequence of a parasitic illness. What curious objects may be found in red corpuscles is readily appreciated by examining the blood of a dormouse or of a new-born rat. The nail- or tadpole-like bodies shown very clearly in the first photograph are extraordinarily similar to those demonstrated some years ago by Braddon in (or on) the red cells in rinderpest.

*A Night Raid into Space: The Story of the Heavens told in Simple Words.* By Col. J. S. F. Mackenzie. Pp. 143. (London: Henry Hardingham, n.d.) Price 2s. 6d. net.

THIS book describes in a chatty, discursive way the elementary facts of astronomy. It is avowedly written for those who have absolutely no mathematical knowledge. Unfortunately, there is in many places an absence of the necessary precision of statement. Thus the description of precession suggests that it affects the earth's orbital motion, there being no mention of the equatorial plane. Moreover, the action is ascribed wholly to the sun, though the moon's contribution is twice as great. The description of sidereal time, and the explanation of the spectroscopic determination of radial velocity, are misleading. Also the erroneous statement is made that the Babylonian year contained 360 days, and had an intercalary month every sixth year. Its real length was 12 lunations, or 354 days, and there were 7 intercalary months in 19 years. Altogether the book needs careful revision; if this were carried out, it could be recommended as a simple handbook.

*Musings of an Idle Man.* By Sir R. H. Firth. Pp. xii + 359. (London: John Bale, Sons, and Danielsson, Ltd., 1919.) Price 7s. 6d. net.

THIS book comprises seventy-five readable and suggestive essays on the most varied subjects, ranging from "The Origin of Life" to "Good and Bad Form." In an essay on "The End of Life" the author envisages the final destruction of life by heat due to radio-activity.

## Letters to the Editor.

[The Editor does not hold himself responsible for opinions expressed by his correspondents. Neither can he undertake to return, or to correspond with the writers of, rejected manuscripts intended for this or any other part of NATURE. No notice is taken of anonymous communications.]

### Museums and the State.

THE old danger arising from the haphazard application of a name surrounds the public institutions which are called "museums." By a perversion of its ancient signification, the word "museum" is now used to designate a collection of natural history specimens, pictures, antiquities, machinery, wax-work or other articles (rarely libraries), as well as the building where it is exhibited to the public either with or without charge for admission. There are various so-called "museums" supported by public funds, either national or municipal. The proposal to create a new body of Government clerks (or to aggrandise an existing one) on the pretence that museums form a "genus" which all alike require central control of one and the same "tape and sealing-wax" type, and that the well-known ignorant, and therefore impartial, Civil Servant is to have new fields of plunder thrown open to him—as "administrator"—is not surprising. We are familiar with such schemes, but, none the less, this is one that all serious lovers of science and of art should resist to the uttermost! What is needed in regard to our existing national and other public museums is not the creation of highly paid posts for otherwise unemployable "administrators," but definite legislation after inquiry and report by a Royal Commission as to the specific purpose, scope, and method of work to be followed in each of those great museums which in this country receive support from public funds. "Overlapping" of collections and neglect of this and that department could be at once prevented by assigning to each museum its proper function and by making its income depend upon its doing what it is intended that it shall do. No central salaried body, no "committees" of delegates, trustees, or members of governing bodies are required. They certainly would prove incapable and obstructive, as such "committees" have generally shown themselves to be.

The defects in the working of our national museums have arisen from the fact that they have come into existence in obscure, surreptitious ways and by chance—witness the history of the British Museum, of the Victoria and Albert Museum, and of the new so-called Science Museum. They have no programme, no clear assignment of scope and purpose to guide them, and no attempt is made by successive Governments to define their functions and to ensure for each of them and for other "museums" supported by public funds a reasonable system of management and control designed so as to ensure their activity and development as efficient instruments of public service.

A central bureau of managing clerks pretending to deal under a heterogeneous "committee" with all the various branches of science and art concerned in the life and progress of all our museums would be an exaggeration of the worst features of the present management by irresponsible and incapable "trustees."

I am convinced that what is needed is the separation and independence of the chief departments now agglomerated in the national museums and their redistribution to form a series of independent institutions each under its own highly expert specialist as director, with no other interference than that of a visitatorial board assigned to each museum, approved



by the Government, and reporting annually on the work and requirements of its own particular museum. Such an institution is Greenwich Observatory. Limiting my suggestions to the natural history sciences, I would have a separate "museum" for zoology and animal palæontology; another for geology (the study of the history of the earth's crust, *not* merely palæontology) with mineralogy and petrology, uniting the museum of the Geological Survey with certain portions of the British Museum; another for botany formed by the removal to the great and flourishing establishment at Kew of the botanical department of the British Museum; and another for anthropology and human palæontology. There seems to me no reason, no advantage, in mixing up the administration of these great centres of special study and research with one another or with the museum of ancient art, or for associating any of these with the great national public library.

Our museums are liable to suffer from the erroneous notion that their *chief* purpose is to furnish ready instruction to school-children and "the general public." Speaking with special reference to natural history, I think it will be admitted that (as in the case of precious records, antiquities, books, etc.) the main and most important function of a museum is the acquisition, study, and safe and permanent guardianship of specimens—specimens which are often unique or of extreme rarity and value, and form the actual evidential basis of the natural history sciences. This guardianship is necessarily to be associated, with perennial study and development of the collections and abundant publication of finely illustrated monographs, catalogues, and descriptions by the museum director and his staff. These duties are, in spite of obstacles, performed in a highly creditable way by the present staff of the Natural History Museum, which, were it free from the dead-weight of an unsympathetic and irresponsible committee of trustees, would render even more abundant services to science and the nation.

In my judgment, the exhibition of the collections in galleries, through which the public may promenade or be personally conducted by itinerant lecturers, is a matter of *subordinate* importance. But it is one of great value to the public, and must be seriously taken in hand and dealt with wisely by the director of each museum. It is the simple fact that many (but not all) of the fine things in museums of natural history can readily be exhibited to the public so as to give pleasure and instruction, and it is desirable to enlist the sympathy and interest of the public by exhibiting with the greatest skill and judgment specimens so displayed and labelled as readily to attract attention and convey information suited to those who have no special knowledge of the branch of science in which the specimens have their place.

It is, however, of the utmost consequence that this kind of exhibition should be strictly limited in amount, and that what is done in the way of such exhibition should be the very best possible—the specimens most carefully chosen because they can be well seen and appreciated when in a glass case and without being handled, and because the information which they and others placed with them afford is of first-rate importance or of a specially fascinating character. It is a profound mistake to attempt to set out the mass of the contents of a museum in this way. Neither space nor skilful design and handiwork can be afforded for "exhibiting" huge collections in this style. The public is wearied and confused by too great profusion, and galleries which are needed for the preservation and study of collections by experts are liable to be sacrificed to the satisfaction of a mistaken demand for the setting out of a sort of high-class Noah's Ark

through which a visitor may wander in a state of dreamy contentment, hypnotised by the endless stream of queer or brilliant things appearing and disappearing before him without any effort or comprehension on his part!

In any case, it is, I think, important not to allow the great public museums to become class-rooms for ill-provided schools. I should like to see the system which is used in the American Museum of Natural History in New York introduced. There is a large lecture-room in the museum, and courses of lectures on the contents of the museum, illustrated by photographic lantern-slides, are given by highly qualified members of the museum staff. Copies of the lectures and the lantern-slides are also supplied by the museum to schools around New York, so that pupils can be prepared by them beforehand for recurring visits to the museum. Though the specimens in a museum may be very thoroughly and well labelled, as in Cromwell Road, it is the fact that no method of insisting upon attention to a label has yet been devised. The public seem to be scared by labels. Nothing is so certain to secure attention as a man standing up in front of the visitor and telling him all about a specimen whilst pointing to this or that part of it.

The Natural History Museum has more of its collections in quiet study-rooms and less of them paraded in bewildering rows in show-cases than has any other public museum in Europe, so far as I know. But it has, nevertheless (in my opinion), too many galleries and cases given up to public exhibition. Even now (after the heroic efforts of Sir William Flower, in whose footsteps I followed in this matter) many of the cases are overcrowded and many are hopelessly placed as regards lighting, and should be abandoned as public show-cases.

There appears to have been no attempt on the part of the architect of the Cromwell Road museum to erect a building with the lighting or height and shape of galleries necessary for such a museum. The trustees were neither consulted in the matter nor competent to give an opinion if they had been.

I should wish, in conclusion, to refer any readers of NATURE who may wish to see a little fuller statement of my opinions concerning the scope and methods of "museums" to the chapter on museums in my "Science from an Easy Chair," second series, 1913, pp. 310-29. E. RAY LANKESTER.

I CORDIALLY welcome the suggestion in the leading article in NATURE of March 11 that the Natural History and other science museums should be placed under the Department of Scientific and Industrial Research. For this Department to take over the Natural History Museum, the Science Museum, the Museum of Practical Geology (and the Geological Survey), and Kew Gardens there need be no change in its constitution. No Royal Commission need be invoked, for the Department would be merely undertaking duties for which it was formed, these institutions being the depositories of most of the basal collections, the facts, upon which much of science is founded. The administration of all could be carried out under one scheme, since the work of all is akin, and the men required to recruit their staffs are drawn from the same class of university men, having similar early training, with diverse specialisations later on.

The present condition in the above museums is most unsatisfactory in respect to differences in the pay and position of their staffs. Thus, according to Whitaker, the assistants at Kew and in the Science Museum start at 300*l.* a year, while geologists and naturalists with similar training start in the two others at 150*l.*; all have war bonuses at present. At Kew there are

eleven in the lower grade (300.-500.) and three above; in the Science Museum the numbers are three and six; and in the Geological Survey twenty and ten. In the Natural History Museum there are thirty-two graded up to 500. a year as against eight above. The position in the latter is so bad that there has been a constant leakage for many years from its highly specialised staff into university and other appointments, the salaries in which exceed those paid in the museum. There is no abundant field of men with private incomes and natural history tastes upon which to draw. The fact that only about one man in four or five who join the staff can hope ever to receive an income above 500. a year prevents any of the best students of universities from entering, while the museum, as the basal institute of several sciences in this country, demands the services of the best men, and of the best men only. The Natural History Museum is, furthermore, out of date in that, while the sciences it represents have advanced, it has taken little account of these advances; its staff has all the same duties as it had twenty or thirty years ago, and, still numbering the same, can undertake new duties only by neglecting older ones. It was never intended to be a museum solely for education and amusement, but the policy pursued in regard to it in the last twenty years has neglected its other sides in respect to research, and its assistants have become more and more the cataloguers, arrangers, and cleaners-up of specimens. The staff less and less takes part in the proceedings of scientific societies because it cannot afford to belong to them.

May I suggest that the pay, position, and grading of the staffs in all the above four institutions should be those of the Home Civil Service, and that the numbers in different grades should be the same as in that Service? The prestige and position of the Civil Service are such that it is an object of ambition to the boy, and no lower position will attract the picked students of science.

J. STANLEY GARDINER.

Zoological Laboratory, Cambridge March 15.

The timely leading article which appeared in NATURE of March 11 raises the very important question of the future administration of the national museums and art galleries of this country. With the main recommendations of the article I am in complete agreement. There is little doubt that the administration of the national museums and art galleries on federal lines from a central Government Department would make for greater efficiency and economy, obviate considerable overlapping, and lead to the fuller use and development of the unique collections housed within their walls. The Department of Scientific and Industrial Research has already assumed control of the Museum of Practical Geology, and the machinery, therefore, for the administration of the whole of our national museums is already in existence, and only requires adapting and expanding.

Such a central Museum Department could be of the greatest service to the provincial museums and art galleries of the country if extended to include them and link them all up in one comprehensive scheme. At present the provincial museums are isolated. There is a lack of co-ordination and co-operation in their work, and they need the advice and assistance of a central body to help them in their development. The national museums between them cover the whole field of museum activities, and their amalgamation into a federal scheme would provide a Department able to deal with any branch of museum work, and to render invaluable assistance to the provincial and private museums throughout the country.

The National Gallery and the Tate Gallery would supply the nucleus for fine arts, the British Museum (Bloomsbury) for pre-history, anthropology, antiquities, and numismatics, the British Museum (Natural History) for natural history, the Victoria and Albert Museum for industrial and applied art, and the Imperial Science Museum for applied and technological science.

It is sufficient to indicate one or two ways in which the assistance of such a Department would be of the highest value:

(1) In the development of a comprehensive system of circulating collections for all branches on the same lines as is now done for industrial art by the Victoria and Albert Museum. (2) The provision of a staff of experts in all branches who could be placed at the service of museums for specialist work on collections. (3) The provision and circulation of approved casts of important and rare specimens. (4) The standardisation of museum cases and fittings to allow of their production on a cheaper and more efficient scale.

A Department such as I have indicated, linking up all the museums into one comprehensive scheme, would lead to the co-ordination of museum work throughout the country. The resources of the museums for each and every available line of research would be accurately known. The provincial and private museums would benefit enormously by having their collections accurately identified and labelled, and be able to utilise and develop their collections to the best advantage. By means of the circulating collections the vast resources of duplicate and reserve material in the national museums would be rendered available and accessible to the nation at large.

The cost of such a scheme would not necessitate an undue burden being placed on the State.

(1) The Government museums are already provided for by direct appropriations. The extension of their work on the lines I have indicated would necessitate larger staffs, but the labours of each expert would not then be rigidly confined to the one museum to which he was primarily attached. While the plan would require organisation and co-operation, it does not seem to involve any drastic change in the present management or governance of such museums.

(2) The public museums of the country could remain, as at present, under the control of the local governing bodies, and their financial resources be provided, as now, by the levy of a rate.

(3) Private museums would need financial assistance from the State, and this might be given in the form of grants-in-aid based on the amount of money provided by the resources of such museums.

The institution of a central Government Department would naturally necessitate Government control and inspection of museums, but such control, wisely and judiciously exercised, would stimulate their development. The Department should clearly recognise that its function would be to help and advise museums, not to hinder them by the imposition of irksome regulations. Museums should be encouraged to preserve their individuality and to develop along their own lines.

It is, perhaps, scarcely necessary to add that a central Department should have as its chief executive officers men trained in the various branches of museum work, whose very training and experience would give them the necessary knowledge to deal sympathetically with questions of museum administration, and to foster that spirit of research which is fundamental to the proper development of museums.

W. M. TATTERSALL.

The Museum. The University, Manchester.

### Organisation of Scientific Work.

I HAVE not read the report of Sir Thomas Holland's Commission which has led to a discussion in the columns of NATURE, and I do not wish to express an opinion on its conclusions. Those who know something of the conditions of India and of the many economic problems awaiting attack will at least agree that the country offers a great field for the investigator, and a difficult one from the point of view of those engaged in the administration of funds for research.

My purpose in writing is to support Dr. Russell's views on the importance of team-work in scientific investigations (NATURE, March 4, p. 7). It seems to me that in discussing the proper relation of the State to scientific work our conclusions will depend chiefly on the precise meaning which we attach to "research."

Prof. Bateson writes (*ibid.*, p. 6): "Research, like art, literature, and all the higher products of human thought, grows only in an atmosphere of freedom." But should not the word used here be "science"? Is not "research" the art by which knowledge is advanced? And is it not the case that in this art there is need for the co-operation of men differently endowed? "Bricklayers" may be wanted as well as "architects" in the building up of knowledge, nor are delays in programmes, other than housing, necessarily due to the lack of a plan.

If by "research worker" one meant only the "master," then I should agree with Sir Ronald Ross (*ibid.*, p. 6) that the policy of organising institutes for scientific research and institutes for the writing of poetry might be considered together. But research workers are not all "masters." There are other grades essential to progress in certain branches of knowledge, never likely to make great discoveries, perhaps, but, since the State needs them, it must enable them to live; and it is the function of the "official" not to direct their work (that must be left to the "master"), but to see that they live under conditions likely to promote efficiency. I am not sure that I agree with Prof. Bateson. There may be danger in State action, but it seems to me to be safer than inaction.

While arguing for the recognition of the importance of co-operation in research, let me add that, whatever part the worker in a research laboratory may be called upon to fill, it is essential that he should recognise clearly that he is part of a team for the advancement of knowledge, and that he should regard himself as a potential discoverer. I welcome Dr. Russell's analysis of the functions of the staff of an institution maintained for research, as it brings out what seems to me a fundamental point in this discussion, but I feel sure that he would agree with me in deprecating any rigid classification of workers as tending to cause discouragement. Whatever the natural qualifications of the members of a team of workers may be, two are essential for real progress: the desire to learn more and the willingness to help others.

T. H. MIDDLETON.

6A Dean's Yard, Westminster, S.W.1,

March 19.

### Science and the New Army.

YOUR leading article of March 18 on "Science and the New Army" directs attention to some hopeful features in our future military organisation, but many will share with you the doubt whether any real fundamental reform has yet been effected. The new policy of "farming out" research work to civil institutions sounds suspiciously like the old policy, so well practised in the past, of getting technical work done and advice given without the obligation of paying anything for it.

Doubtless it may be argued that so long as scientific men are complaisant enough to work for nothing a Government Department which paid them would be guilty of extravagance. Ultimately, however, it will be found good policy and sound economy to recognise that skilled knowledge is worth its hire, and scientific men, in their turn, may perhaps learn that in attaching a low valuation to their own labour they help to confirm the widely held idea that expert training is a thing of small account. The Army would keep more closely in touch with all scientific progress in any remote degree affecting the conduct of warfare—and who can set limits to this qualification?—if it retained men of proved competence with the duty of posting the General Staff in all such advances of knowledge. These men need not, in fact should not, give their whole time to the work; it would be an essential condition that they should be in full activity as researchers, teachers, or professional engineers, chemists, etc., and it would be equally essential that they should be remunerated at adequate rates. No unpaid committee, however august the membership, will fill the want.

I must confess that I scarcely understand what is meant by "preliminary design of apparatus," stated to be part of the functions of the military institutions. Of what value is a preliminary design if the underlying principles are not understood, and wherein does it differ from a mere statement of what some un-instructed amateur thinks can be done by "electricity" or by "cog-wheels"? Furthermore, unless these military institutions are directed by trained specialists, the "applied researches" entrusted to them are not likely to be crowned with any conspicuous measure of success.

E. H. HILLS.

### Cotton-growing in the British Empire.

IN NATURE of February 26 Sir George Watt reviews in a critical spirit the report to the Board of Trade of the Empire Cotton-Growing Committee. Much of his criticism is based on an expressed aversion to committees, which has misled him into stating that we propose our central (cotton-growing) research institution should be staffed by a "committee of voluntary workers." This is quite erroneous. The report itself describes in some detail the permanent staff which is suggested.

Some of the criticisms are due to the reviewer not having realised that the Committee was dealing with cotton-growing alone, and that the British Cotton Industry Research Association is working in co-operation with the Empire Cotton-Growing Committee through a joint body (of which I happen to be chairman), so that his desire for the Cotton-Growing Committee to establish its central research institution in Manchester, where no cotton will grow, is invalid.

Nor do I think that his suggestion of a programme for the members of the research institution as being "research, education, and cotton production" makes a sufficiently clear discrimination between means and ends; but chiefly I regret that the reviewer has missed our main thesis, which concerns the need for knowledge, based on pure science, as the essential to progress in this matter. Indeed, he seems to be completely antagonistic to this view of ours when he states that "general principles of education must never be allowed to take the place of specific training and definite results." It is no little thing that a utilitarian body, representing all aspects of the cotton trade, from the native cultivators to spinners and manufacturers, should have come into the open with such a plea for the encouragement of pure science, as being the basis of useful development, and it is indeed un-

expected to find this plea condemned by a reviewer in the columns of NATURE.

Nevertheless, Sir George Watt makes a legitimate criticism when he says that our proposals "do not seem to resolve themselves into the promulgation of a concrete scheme of increased and improved production." I would like to explain why we deliberately avoided advancing such a scheme in this report.

The consideration of actual steps to be taken in cotton production is the next stage in the Committee's work, to which it has already settled down. When this report was issued we were penniless, and could not with any utility consider how money should be spent until we were assured of:—(a) Annual financial support from Lancashire. (b) Regular financial support from H.M. Government. (c) Approval of policy from the Governments of the Dominions, Colonies, and Protectorates.

Since our report was issued (a) the home industry has agreed to make a voluntary annual levy on itself; (b) our maintenance charges are assured, so that our executive can be built up, while the question of further support is under consideration; and official information as to (c) is awaited. A large income is already in sight, and the way is becoming clear for practical planning and guidance as distinguished from the enunciation of principles. It should be noted that the capital required actually to grow the cotton which this country now purchases outside the Empire is of the order of 250,000,000*l.*, being more than a thousand-fold the sum asked for in our report.

But those principles had to be settled first, and I for one regret that Sir George Watt should have missed their significance through misunderstanding the present stage of our development and our inability to be anything else hitherto but a "committee." if we were to represent the native peoples abroad as well as the operatives at home, with all the intervening stages of industry, of administration, and of knowledge.

W. LAWRENCE BALLS.

Edale, Derbyshire, March 8.

I AM obliged for the opportunity given me to read Dr. Lawrence Balls's reply to my review in NATURE of February 26 of the report issued by the Committee on Cotton-Growing, within the British Empire, appointed by the Board of Trade. Dr. Balls seems to me, in the main, to admit my contention, namely, that the Committee's report, as it stands, does not resolve itself into a concrete scheme of increased and improved production of cotton. In fact, it may be said to be unfortunate that the Committee did not anticipate such criticisms as mine by giving the public some hint of the possible future stages of its operations. The public were anxiously awaiting a full scheme, and one that would give distinct prospect of success, but in place of getting such we are now told we have only seen (as it were) the first instalment, and must look for better results in the future.

But, turning to some of Dr. Balls's observations on my review, I do not find that I have stated that the report contemplates the staffing of the central research institution by committees of voluntary workers. It is surely self-evident that there would have to be permanent officials appointed to the central research institution, as also to the branch institutions. But what I did object to was that these officials should be put under a panorama of six committees, as seemed contemplated by the authors of the report. I am old enough to recollect the great Cotton Commission in India. Indeed, my official connection with that country might be said to have commenced with having to try to pick up the dishevelled threads of that futile expenditure of public

money. The late Mr. C. B. Clarke, in the preface to his edition of Roxburgh's "Flora of India," alludes to the issue of one of the Commission's reports as follows:—"We have had plenty of Government and other reports, some very large and expensive ones, it is true, but we have very little economic work by persons competent as botanists; and with reference to one large and expensive report lately issued on an Indian economic plant it was discovered after it was printed that the Commission never learnt what the plant was."

The result of the great Cotton Commission of India was officialism, Cotton Frauds Acts, and other such follies. It is the knowledge of past failures having very largely proceeded from officialism that makes me urge with all the earnestness I possess that the staff of the central and branch research institutions should be as free and independent as the professors of a university. They need no supervision more than is exercised by Departmental control in the allocation of funds and in the laying down of general rules and political instructions. Official control should be by the principal or principals of the college or colleges of cotton, but with no one else.

I am at a loss to understand Dr. Balls when he says I have missed "our main thesis, concerning the need for knowledge, based on pure science, as the essential to progress in this matter." The Committee, as I understood the report, recommends that certain universities should be asked to establish lectureships and readerships; my scheme was that the research institution or institutions, in addition to conducting research, should undertake the entire education of both the experts and the practical planters, and thus have their own professors of plant physiology, plant genetics, mycology, entomology, and the like.

My recommendation is thus to concentrate all effort in the hands of a body of highly trained scientific and practical experts, to place all the funds available in their hands, and to hold them responsible not only to increase the supply, but also to improve the quality of the cotton produced within the British Empire.

GEORGE WATT

(Formerly Reporter on Economic Products  
with the Government of India).

Annandale House, Lockerbie, March 13.

### The Separation of Isotopes.

IN a recent discussion (*Phil. Mag.*, vol. xxxvii., p. 523, 1919) of a number of methods of separating isotopes Prof. Lindemann and Dr. Aston have shown that there is little prospect of effecting by the methods considered a separation which will yield pure samples of the isotopes in a reasonable time. Dr. Aston has recently announced the discovery that chlorine consists of a mixture of at least two isotopes having atomic weights 35 and 37. It appears that there is here a possibility of effecting a separation of the isotopes by a direct method which does not seem to be applicable in the case of most other elements. The method proposed depends on the assumption that in the absorption spectrum of chlorine, which contains a vast number of narrow lines, there is a difference between the wave-lengths of the absorption lines due to molecules containing different isotopes.

Supposing that ordinary chlorine contains the isotopes  $\text{Cl}_{35}$  and  $\text{Cl}_{37}$ , in the ratio 3 : 1, the molecules will consist of  $\text{Cl}_{35}\text{Cl}_{35}$ ,  $\text{Cl}_{35}\text{Cl}_{37}$ , and  $\text{Cl}_{37}\text{Cl}_{37}$  in the ratio 9 : 6 : 1. It follows that if white light traverses a column of chlorine of such a length that the radiations absorbed by  $\text{Cl}_{35}\text{Cl}_{35}$  are reduced in intensity by a factor  $1/10^8$ , the corresponding factors in the case of  $\text{Cl}_{35}\text{Cl}_{37}$  and  $\text{Cl}_{37}\text{Cl}_{35}$  will be  $1/10^{18}$  and  $1/10^{27}$  respec-

tively. Suppose that the light after passing through this column of chlorine enters a vessel containing a mixture of hydrogen and chlorine, which combine under the influence of the light absorbed by the chlorine, it would appear to follow that the initial rates of reaction for the molecules  $\text{Cl}_{35}\text{Cl}_{35}$ ,  $\text{Cl}_{37}\text{Cl}_{35}$  and  $\text{Cl}_{37}\text{Cl}_{37}$  should be in the ratio  $1:10^9:10^{18}$ . The hydrochloric acid thus formed should therefore consist almost entirely of  $\text{HCl}_{37}$  if the reaction is allowed to proceed for a suitable time.

If this experiment should prove successful, it would evidently be possible to prepare a "filter" from the chlorine thus obtained which would favour the formation of  $\text{HCl}_{35}$ . It is fully recognised that there are a number of factors which may affect the success of the experiment, which is now being tried; it is hoped that results will be obtained before long, but the method seems worthy of mention as involving principles which have apparently not been considered hitherto in this connection.

THOMAS H. MERTON.

HAROLD R. HARTLEY.

Balliol College, Oxford.

### Calendar Reform.

Vous avez cent fois raison de souhaiter un accord pratique entre les partisans de la réforme du calendrier, et je vous demanderai, pour ma part, la permission de répondre quelques mots à votre judicieuse invitation.

On peut lire dans mon Annuaire astronomique pour 1920 que la réforme radicale que j'ai proposée en 1879, en 1884 et en 1891 étant trop difficile à réaliser, et l'humanité étant incapable d'accepter des solutions rationnelles en quoi que ce soit, nous pourrions nous borner à la simplification suivante :

1° Douze mois partagés en 4 trimestres égaux de 30, 30 et 31 jours, le premier mois de chaque trimestre commençant un lundi et le dernier jour du troisième mois étant un dimanche.

2° Le 1<sup>er</sup> janvier étant voisin du solstice peut être conservé. Ce serait, tous les ans, un lundi.

3° La fête de Pâques pourrait être fixée au dimanche 7 avril.

4° Les quatre trimestres égaux de 91 jours chacun formant 364 jours, il y aurait un jour de fête = 0 pour les années ordinaires et deux pour les années bissextiles.

On aurait ainsi un calendrier perpétuel et universel.

CAMILLE FLAMMARION.

Paris, le 8 mars, 1920.

CALENDAR reformers will welcome M. Flammarion's alteration of his scheme to one which minimises the changes from the existing calendar, while it secures the removal of its anomalies and inconveniences. It would seem advisable to choose some day for the extra-week day that is already a public holiday. Christmas Day, New Year's Day, and Whit-Sunday have been suggested.

From the astronomical point of view the most important amendment is the placing of the leap-day at the end of the year, so that the interval from the beginning of the year to any calendar date is constant.

A. C. D. CROMMELIN.

### On Langmuir's Theory of Atoms.

MR. S. C. BRADFORD'S criticism in NATURE of March 11 of Dr. Langmuir's theory is scarcely justifiable, considering that the latter clearly states in his paper (Journ. American Chem. Soc., vol. xli., p. 868, 1919) that the equilibrium positions of the electrons are determined in part by magnetic, and in part by

electrostatic, forces, the former necessarily implying electron rotations.

The electrons are probably rotating (some right-handedly, others left-handedly) in very small orbits about certain fixed points, e.g. the corners of each cube, the centres of such orbits being the positions of Dr. Langmuir's "stationary" electrons. Such rotations are exactly what is required for the explanation of directed valencies and the paramagnetic or diamagnetic properties of the elements. From magnetic considerations, Mr. Bradford's suggestion as to the nature of the rotation is inconceivable, since the one he prescribes would make fluorine and a number of other elements paramagnetic, contrary to experimental data. Moreover, the frequencies of such rotations, which he suggests might be identified with Bohr's spectral frequencies, would be affected by temperature changes.

Electrons rotating right- and left-handedly about definite points, in small circles the radii of which are small compared with the accepted radius of the hydrogen atom, appear to be necessary; but there is little possibility of reconciling such small orbital motions with the coplanar ones of Bohr, the radii of which are, under normal conditions, essentially of the conventional atomic size, and under certain conditions far larger.

A. E. OXLEY.

University College, London, March 12.

### Fireball of February 4.

ON Wednesday, February 4, at 6 p.m., a very bright meteor appeared in the sky at Naini Tal (India). It travelled from west to east at an altitude of about 60°, and was visible for fully five seconds. The yellow fireball left a bluish-white trail, which remained hanging in the air for a considerable time, and then gradually dispersed. About half-way through its course a big puff of vapour came out of the meteor, which probably indicated the bursting. Half a minute later a thundering noise was heard, which continued to rumble for a quarter of a minute. It had been snowing an hour before, but the sky was perfectly clear at that time.

M. L. DEY.

Central Chemical Laboratory, Naini Tal,  
India, February 5.

It is curious that on the same date a large fireball was observed in England at 6.14 p.m., but in this case the object moved from east to west, i.e. in a contrary direction to the one seen by Mr. Dey. It is, however, by no means rare that two or more fireballs appear on the same night, though they are seldom members of the same meteoric system.

W. F. DENNING.

### Buzzards and Bitterns.

IN the *Times* of March 12 it is stated that "the Lakeland buzzards are extending their breeding range . . . and that a nest was detected in the Buttermere Valley."

It would thus seem that the buzzard was finding its way by instinct to a region where, in old times, it had obtained an easy prey in the bittern, which gave its name to the mere. The early name of the bittern was "butter," and a Buttermere is mentioned in a charter ascribed to A.D. 863 as occurring in Wiltshire. There are a number of place-names in the country involving the designation of the bird, although its "bump" is no longer heard, as by Tennyson's Northern Farmer.

EDMUND McCCLURE.

80 Eccleston Square, S.W.1, March 13.

## Ostrich Study in South Africa.

By PROF. J. E. DUERDEN.

THE domestication of the two-toed ostrich in South Africa has rendered available for observation and experiment large numbers of a creature in many respects worthy the attention of zoologists. While this bird's lack of intelligence and absence of any personal recognition may discourage the lover of animals who looks for some response for care and attention bestowed, its towering size, wayward strength, and nuptial viciousness yet engender a wholesome regard. The high industrial importance which attaches to its plumage has made necessary an intensive study of the physiological conditions which influence feather growth, as well as of the genetical considerations which determine its advance. It is true that, as the foundation of an industry appealing only to adornment and luxury, the bird fell on evil days during the war; but the outlook for the future is now encouraging.

Though in the wild state the ostrich is one of the most nervous of birds, its instinctive fear of man the unusual can be kept in abeyance on the farm by close association and constant handling from the chick stage onwards, and with intelligent control it is rendered amenable to all the necessary restraints of domestication. Should neglect occur, however, the wild nature asserts itself, and restraint is afterwards impossible, irresponsible as it remains to any "breaking" process.

During the past fifty years or so the farmer has worked out the main conditions necessary for the production of plumage of the highest excellence, without, however, any concern as to the physiological principles involved. As epidermal outgrowths, growing at the rate of a quarter of an inch a day, the unripe plumes are found to be extremely responsive to any variation in the condition of nutrition of the bird. Even the slight difference of blood-pressure between day and night is often found to leave its impress on the growing feather in the form of an alternation of denser and weaker annulations, while, should the bird be in a reduced state, a kinking of the feather sheath at a ring of night growth may result in the formation on the opened plume of the familiar defects known as "bars" (Fig. 1). Reduced nutrition may even result in complete stoppage of feather growth, particularly in the case of chicks, a new plume pushing out the old on the restoration of better conditions. Of all parts of the body, epidermal structures seem the first to suffer from insufficient nutrition and to retain a more or less permanent impress of it, as is so often exemplified in nails, hoofs, horns, wool, and hair; but in the rapidly growing ostrich plume the response appears more manifest, and an economic importance attaches thereto.

The clipping of the plumes is no more harmful to the bird than is the cutting of the hair or the trimming of the nails to ourselves. They are taken as soon as opened out for fear of deteriora-

tion, while the quills are allowed another two months in which to complete their growth. Several helpful facts are disclosed on the extraction of the quills. Thus, the drawing of the quill invariably serves as a stimulus to the germ below, and the new feather appears at the lip of the socket in about a month's time. All being drawn simultaneously, a full, even crop of plumes is secured, each regular and perfect in its growth, owing to mutual protection—a great contrast with a crop from a wild or uncared-for bird, which is made up of plumes at all stages of growth as a result of moulting irregularities. Before maturity of plumage is reached, a feather drawn out of time is intermediate in character between those of the



FIG. 1.—Ostrich plumes showing barring defects and sloping butts, results of reduced nutrition.

plumage before and those coming after. The time of quilling is the most critical of all the operations connected with the farming of the bird, as it determines largely the nature of the succeeding feather crop. The state of nutrition, sexual stage, period of the year, and climatic and food conditions have all to be considered. Where only a single clipping annually is secured, adult birds are, if possible, quilled at such a period as will bring the crop to ripeness about the beginning of the breeding season—that is, the middle of winter.

While the growing plume is highly responsive to changes of nutrition, the farmer soon discovered that the response was limited, and that with all his care only certain birds produced superior plumes. As in other domestic animals where much importance is attached to details of

form and production, great variations in the minutæ of feather structure were encountered, all of which have a big industrial bearing. Scarcely any two birds produced plumage alike in character, and the whole object of the breeder has been to bring together in a single plume the best of all the characteristics distributed among the original wild stocks. Without any knowledge of Mendelism or of the factorial hypothesis, the ostrich farmer has clearly grasped the genetic distinctness of the innumerable "points" of the plume, and the impossibility of procuring those desired except from birds already exhibiting them. The best plumage birds in South Africa to-day are the product of only two or three original strains; all the rest have been discarded as breeders, through not showing sufficient merit. No new character or mutation in plumage has ever occurred since domestication. Selection in breeding is based on plumage alone, no bodily characters having been found to be correlated with it. It is manifest that any ostrich of weak metabolic activity would necessarily produce a defective plume also and be discarded on performance alone, however desirable the plume factors of the germ might be known to be; hence the farmer is more justified in selecting his breeders on production than he would be in selecting on pedigree alone. It is not much that the geneticist can do for the practical breeder in cases of this kind; he can, however, expound to him the soundness of the principles on which he is working and thereby encourage him in his efforts.

Along with the other members of the ratite group, the ostrich has long been regarded as in many respects degenerate or as undergoing retrogressive evolution. The relative smallness of the wings and the presence of only two toes to the foot are manifest features, but a closer study reveals many other directions in which loss has taken place, particularly in connection with the epidermal derivatives, scales, feathers, and claws. The thousands of specimens available provide ample material for observing the various stages in the process and the manner in which the loss proceeds. In such studies it becomes important to distinguish between diminution in size and the loss of constituent parts of a structure. Thus, although the wings are so disproportionately small, structurally they are actually less degenerate than in any other living bird. The first and second digits bear claws, and the third digit has sometimes a free second phalanx and may bear feathers. The outer toe of the foot is far less in size than would be expected of the fourth in the sauripsoidan sequence, yet it retains all its five phalanges. Also, as showing the independence of the degenerative changes one of another, it may be observed that, though the wing is structurally less reduced than in other birds, the foot is unique in having only two toes; it is more degenerate than in any other living bird.

That a type has undergone degeneration in any respect can be established only by comparison with closely related members of the group to which it belongs, comparative anatomy affording us a safe

standard. On this basis there can be no question of the various lines of degeneration represented in the ostrich, and if among the multitude of specimens examined differences of degree are met with along these lines, it is a fair inference that they represent the various stages of the process, and reveal to us the manner in which evolution proceeds. Whether the occurrence of these intermediate stages within extremes proves that evolution is actually in progress to-day may be a reasonable inference in the case of such an animal as the ostrich; but, as Prof. Bateson has pointed out, it can be definitely established only by comparisons at long intervals of time showing a general average reduction.

Comparing, then, the various stages in the degeneration of any particular feature of the ostrich, it is found that wherever a sufficient number of

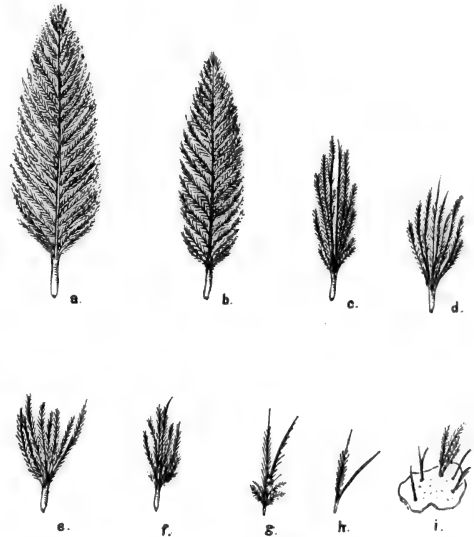

FIG. 2.—Series showing stages in degeneration of a feather.

individuals can be got together a continuous series is presented, linking up the extremes (Fig. 2). Thus birds are to be found with wing quills varying in number all the way from 44 to 33; the under-covering of down may be practically lacking, while all stages occur leading up to a feeble development over the greater part of the body; the under-surface of the wing may be naked with the exception of a much reduced single row of under coverts, but intermediate stages occur culminating in three rows of coverts; many degrees in reduction of the upper coverts are also encountered; the second phalanx of the third finger varies from a free distinct bone to a triangular vestige fused to the end of the first phalanx. On the little toe the claw varies from a stage where it is well developed to one where it is altogether absent, and the scutellation of the big toe may

either be continuous with that on the tarsus or show stages in "breaks" at one or two of the joints (Fig. 3). These and other facts of a like character go to prove that the degenerative evolutionary processes in the ostrich are all *orthogenetic* in their nature, and that a retrogressive change set up in any one direction is likely to be continued until final elimination of the part in question. The continuity is probably more apparent

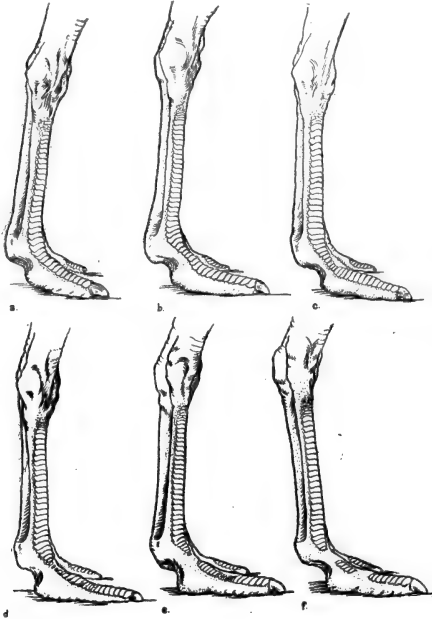

FIG. 3.—Series showing various stages in the loss of scales over the big toe.

than real; for if the somatic changes correspond with alterations in the germ plasm, it must be inferred that these are discrete in their origin, and apparent continuity is conferred mainly by intermixture and owing to the smallness of the changes. The stages must, however, be successional and represent a definite tendency in the germ plasm, in contrast to the haphazard nature of the mutations usually studied—a tendency which

is held to be wholly apart from any considerations as to the welfare of the bird, as well as from environmental influences.

To the highly contentious question of the inheritance of acquired characters, the ostrich would appear to have a contribution to offer. Owing to the loss of its second toe, the crouching bird, for mechanical reasons, no longer makes use of the symmetrical axial callosity at the ankle, but develops an accessory one to the side. This is formed anew with each generation, and must have done so ever since the second toe disappeared, though presumably this happened thousands and thousands of generations ago. No hint of the accessory callosity occurs on the newly hatched chick; it is not inherited, but has to be acquired anew each time. On the other hand, the hereditary axial callosity, though unused for the same period, shows no signs of reduction; it has persisted through the ages, though non-functional. Further, the ostrich rests upon its sternal and pubic projections, and a strong callosity is developed over each. These would unquestionably form as a direct response of the skin to the pressure and friction involved in crouching, but are found to be hereditary, showing on the newly hatched chick. Hence we are presented with an hereditary structure which would also be formed independently as a result of the ordinary activities of the bird were it not already provided, strongly compelling us to suspect that the presence of the former is in some manner directly connected with the latter; in other words, that a character originally developed as a result of external stimuli has in time become so impressed upon the organism that it now makes its appearance apart from the primary stimuli.

The question of the origin of the three or four species of ostrich also makes some appeal to the evolutionist. No one intimately acquainted with the northern and southern ostrich would dispute their specific distinctness, but the East African and Somali species appear to be founded on intermediates of the two. Moreover, the northern and southern birds freely interbreed, and their offspring are fertile, some of the characters blending and others showing Mendelian segregation. Unquestionably all the representatives of the genus *Struthio* are a common stock, continental in their distribution, in which mutations have occurred in certain areas and not in others, but not of such a nature as to prevent free interbreeding.

### The Conservation of Our Coal Supplies.<sup>1</sup>

By PROF. J. W. GREGORY, F.R.S.

COAL is the main material foundation of British industrial supremacy. The importance of coal is given by Mr. Justice Sankey as his first reason for its State ownership. The rapid British industrial progress at the end of the eighteenth

century was due to our abundant coal. Modern coal mining began in Belgium earlier than in Britain, but British mines soon had the greatest output in the world. In 1800 they produced two-thirds of the world's coal, in 1860 the proportion was 60 per cent., and in 1913 the United States,

<sup>1</sup> Address to the Philosophical Society, Glasgow, on March 10.



Britain, and Germany together produced 87 per cent. of the world's coal. It was not until 1899 that the British output was surpassed by that of the United States; but, in spite of the ease of working of the American fields, our yield per unit of coal area is sixteen times as great as that of America. The British output of nearly 300 million tons is irrefutable evidence of the skilful organisation of the British coal industry and of the courage and capacity of the British miner.

This drain of 300 million tons a year inspires disquietude as to how long it can last. The first authoritative estimate of our coal resources was that of the Royal Commission of 1865, which estimated them as roughly 150,000 million tons. Later estimates have increased this amount to about 200,000 million tons, which would maintain the 1913 output for 600 years; the United States supplies would be maintained for 1500 years, those of Germany for more than 1500 years, while the coal fields of China would last for several millenniums. The world is in no immediate danger of a coal famine, but the British industrial position is threatened by the continued rise in the price of coal, which may hamper competition with countries with cheaper supplies. Jevons in 1865 issued a warning of this danger, and his main prediction has been amply justified, for during the seventy years from 1834 to 1904 the price of coal almost doubled, while that of general commodities fell by about a quarter. The increased cost of coal cannot, therefore, be explained by such influences as variations in currency.

The maintenance of the British output at a price which will enable British manufacturers to compete with those of foreign coal-producing countries depends on the increase of our coal reserves by the discovery of buried coal fields, such as doubtless occur under the younger rocks of eastern and southern England, while an extension of the Scottish coal fields may occur in north-eastern Ireland under the lava sheets of Antrim. The coal field of South Yorkshire and Nottinghamshire has been enlarged since 1905 by the discovery of 400 square miles of coal-bearing country, most of which is already being worked or developed. The eastward extension of this field is less than was expected by the Coal Commission of 1905, but its eastern and southern margins are still undetermined. The Kent coal field was found, in consequence of a geological prediction, during boring operations at Dover in connection with the Channel tunnel. Private bores for water have thrown light on the possible range of the coal in the south-east of England, but there are large areas which are unlikely to be tested by private enterprise. It is deplorable that they should be left unproved, as a few bores between the Nottinghamshire and Kent coal fields, and between London and Bristol, might lead to the discovery of very important additions to the national coal reserves. Such bores should be put down at the national expense, the cost, if successful, being charged to the area benefited.

As much light may be thrown on the distribution

of concealed coal by private bores, the journals of all deep bores should be communicated to the Geological Survey and published either annually or, if desired by those who have paid for them, after an interval of ten years.

The national coal supplies will be increased by the working of deeper seams. The extreme limit of coal mining has been regarded as 4000 ft., but that depth has been greatly exceeded in metal mining, and 4900 ft. is the accepted Continental limit for coal mining.

The working of thinner seams is becoming practicable by the use of machinery and by working coal in conjunction with the adjacent clays; but the extension of thin-seam working would be hindered by a Government scheme for the nationalisation of coal. The nationalisation of all minerals, since clay and limestone often form the ground in large areas, would mean the nationalisation of the land. The nationalisation of coal alone would seriously hamper that combined working of coal with clay or limestone on which the development of thin-seam working is mainly dependent.

It may also pay the nation to arrange for the extraction of seams so thin that they cannot be worked at a profit, for if the labour be available the direct loss may be recompensed from the profits earned by the coal in other industries. It has often been suggested that to make our coal last longer the output should be restricted, but that policy, fortunately, appears now to have no advocates. The universal demand is for an increased output. Its restriction is opposed to the sound commercial principle, "Use an asset while you can." Unrestricted output is, however, justifiable only so long as coal is used economically. Great savings are possible. Sir George Beilby estimates that the average British consumption of coal per horse-power per hour is 5 lb., and that it should be no more than 1½ lb., thus saving 56 million tons of coal a year. Greater saving appears possible by economy in the use of coal than from the numerous alternative sources of power, though resort to them will become necessary if coal prices rise.

Economy in coal is the most promising method of reducing the drain on our coal reserves. The country has used only about 6 per cent. of its total coal. Our coal supply would maintain the 1913 output for centuries, but if the annual output increases until, as some authorities expect, it is trebled, the handicap of high price may be on us in less than a century. By economy in coal consumption great industrial expansion is possible on the present output.

The essential factors with regard to the coal question are that no other source of power is available in this country on a large scale; coal is still indispensable, while it is limited in amount and irreplaceable; and, owing to the exhaustion of the more easily worked seams, a steady rise in price will continue, and probably at an accelerated rate. Ultimately the nation must enforce economy in the consumption of coal, prevent waste in mining, and be prepared to work seams at a

direct financial loss. The coal industry can be conducted on those lines in accordance with three possible policies—nationalisation, one coal trust for all the British fields, or group working by a combine for each coal field, co-ordinated by national control. Which of these policies is best is not a geological question. The problem for geologists is whether one of these policies is necessary at once, owing to the diminution of our coal reserves. The recent rise in the price of coal has been due partly to a just increase in miners' wages, partly to the higher costs of supplies, and partly to some spontaneous hypertrophy of price in distribution. Compared with these influences, the contribution to the soaring of coal prices by the geological factors is trivial. The conditions of our coal supplies do not render immediately necessary any drastic action in the conduct of the industry. In countries such as India, where the total coal reserves relative to the area and population are small, nationalisation may be the soundest economic policy, but we are far from the time when the three great coal-producing countries—the United Kingdom, the United States, and

Germany—will find nationalisation necessary owing to the approaching exhaustion of their coal supplies.

The direct issue before the nation at present is between national ownership of the minerals with centralised Government control of mining—which may give us the drawbacks of nationalisation without its advantages, and is repudiated by both the miners and the mine owners—and a scheme of nationalisation combined with local administration of the industry by those engaged in it. The issue between nationalisation and the pre-war system may not be put to the nation unless as a result of the conflict between the nationalists who advocate central control and those who advocate local control. The pre-war system has no chance of permanence unless developed to give the miners better conditions and a share in the control and financial fluctuations of the industry, combined with regulations to enforce economy in the use of coal and to secure less waste in mining, and with the determination of the extent of the concealed coal fields on which the future of the country will ultimately depend.

### Obituary.

PROF. CHARLES LAPWORTH, F.R.S.

THE work of Prof. Charles Lapworth (who died on Saturday, March 13) in the sciences of geology and geography will continue to influence and inspire the growth of these sciences for many years to come. At the moment we can but mourn the loss of one worthy to be classed with the greatest of the old masters.

Gifted with a vivid and flexible imagination which he kept in his most brilliant excursions well under the control of his data, with unwearied patience in the collection of fact by his own observation or that of others, with an active and most orderly mind for grouping and arranging ideas, with the moral courage to hold his hypotheses in test until the survivors of them became proved theories, with a perfect genius for stratigraphy, an instinct for geometry, and the hand of an artist, Lapworth had the qualities requisite to bring the study of the older palæozoic rocks to the level of an exact science, to throw new light on the mechanism of earth-movement, and to forge the links between geology, "the geography of the past," and the geography of the present.

In 1864 Lapworth grasped the opportunity of work in the Southern Uplands, the country redolent of Scott, his favourite author. Spending every leisure moment in walking over ground thus made sacred to him, and possessing the gift of close and accurate observation, he could not help becoming interested in the landscape and the rocks; and he soon found himself studying the geology of the region in company with his friend James Wilson.

It happened that the landscape of this area concealed under an aspect of simplicity, but revealed to the eye of genius, a rock-structure of extraordinary complexity, to which there was apparently no clue except a few obscure pen-like markings, called graptolites, in the Moffat shales; and these had been tried for the purpose, but "turned down" as useless. Lapworth, however, determined to give them a second chance, and, as a result of systematic collecting, a keen eye for a country, and a retentive memory for minute, but significant, lithological variation, accompanied by a more elaborate piece of geological mapping than his predecessors had ever attempted, succeeded in proving that they could be used to unravel a rock-succession, even though it was more crumpled, inverted, and tangled than any other then known.

The rock succession and tectonic structure thus made out were tested against the simpler successions and relations and the more normal fossils of the Girvan area, and proved correct. At the same time, the graptolite zones that Lapworth had established were tested by comparison with successions made out partly by others, but mainly by himself at home, and by workers in Scandinavia, Bohemia, etc., proving that he had successfully performed at Moffat the double feat of working out the succession by means of the structure, and the structure by the succession.

The correct reading of the Uplands having shown that an apparently simple upward succession might be altogether misleading, and that this region gave support, and not contradiction, to general laws previously established in the organic and

inorganic world, suggested the probability that the varying interpretations of the Highland problem might admit of a like solution. While Lapworth was able to carry and apply his tectonic principles to the Highlands, definite organic succession now failed him, and he was driven to depend mainly on his stratigraphical methods applied to variations which were mainly lithological. Again, most elaborate mapping, and something akin to inspiration in the interpretation of it, came to his aid, and in a few months he had proved that the secret of the Highlands was that the region was the basal wreck of an ancient mountain chain exhibiting tectonic features akin to those worked out by Escher and Heim in the Alps. Lapworth was passing forward to the fuller study of the metamorphic area of the Highlands when his work was cut short by illness, and, in spite of his wish to do so, he was never able to take it up again.

The tectonic work, however, led on to the suggestive study of the rock-fold, which formed the subject of his address to the British Association at Edinburgh (1892), in which he passed from the structure of mountain chains to that of continents and oceans, and onward to the antilogous crests and troughs of the earth's crust as a whole, including that great "septum" the Pacific girdle of fire, the "wedding-ring of geology and geography." Later, Lapworth laid before the Geologists' Association his conception that a great continental wave sweeping round the earth would produce results analogous to those revealed by the succession of stratified rocks. In this, as in his other work, while possessing deep and sympathetic knowledge of the researches of such geologists as Suess, Heim, and Bertrand, he held steadily to the views of the mechanics of the earth's crust to which his independent thought had led him.

The success of his own graptolite work and the keenness with which it was being followed up by young observers led him to propose a new classification of the Rhabdophora, and to contemplate a monograph on the Order. This has now been completed by Miss Elles and Mrs. Shakespear under his guidance and editorship.

Although his duties at Birmingham, and the great amount of professional work involved by his position there, kept Lapworth fully occupied, his ideal diversion was always the discovery of new facts and their delineation on maps. Field classes, week-ends, and longer holidays were always devoted to this, resulting in the completion of large-scale maps of Nuneaton, the Lickeys, Dudley and the Coal-field, the Wrekin, the Longmynd and Caradoc, the Shelve country, and, last but by no means least, with his friend Dr. Stacey Wilson, the Harlech area. Little of all this work has been published. He loved to add to it, to improve and polish it, to fill in difficult corners in detail, and to show his treasures to his friends, delighting that they should realise some of the steps which led to his conclusions, and appreciate some of the labour of discovery.

As a great teacher Lapworth earnestly desired to

equip his students to take their share in furthering the advance of science and to remove anything that could retard its progress. It was only fitting that the man who had stilled the Lowland controversy, and wrested its secret from the Highlands, should give the law in the "Silurian" controversy and make the opponents sink their differences by the adoption of his term "Ordovician."

#### SIR THOMAS P. ANDERSON STUART.

It is with deep regret that we have to record the death, on February 29, in Sydney, of Sir Anderson Stuart, the well-known and highly respected professor of physiology in the University of that city, and the dean of its medical faculty. He had been in failing health for some months previously, but the fatal outcome of his malady was unexpected by his numerous friends.

Anderson Stuart was born at Dumfries in 1856, and was the son of Alexander Stuart, Dean of Guild. He received his early education at the Dumfries Academy, and later studied in Germany (Wolfenbüttel and Strassburg) and in the University of Edinburgh, where he graduated M.B., Ch.M. with honours in 1880. The next year he was appointed assistant of the professor of the Institutes of Medicine at Edinburgh, and later took the M.D. at that University, obtaining the gold medal.

It was in 1883 that Anderson Stuart went to Australia as professor of physiology at Sydney, which post he held until his untimely death. His was a forceful character, and he threw himself with enthusiasm into the work of teaching and research there. He will be remembered for many useful pieces of original work in connection with the circulation, the physiology of swallowing, and the eye. His various models and schemata, in which he manifested extreme ingenuity, are standard helps to teaching in all modern laboratories. His work as dean at a later stage in his career brought the medical school into high repute, and at the meeting of the British Association in Australia in 1914 he pointed out with justifiable pride the new buildings of the medical school, fully equipped with all modern appliances and accommodation for research and teaching, which formed the successful culmination of his efforts.

But Anderson Stuart was more than a professor, more even than a dean; he was a sagacious man of the world, and was appointed on many occasions delegate by his University to various international congresses, and consulted by the Government of New South Wales on many questions of public importance mainly related to educational problems. He was thus a well-known figure, not only in Great Britain, but also in other European countries.

In his adopted country Anderson Stuart's life was a long story of official appointments successfully discharged. He was twice president of the Royal Society of New South Wales. He was medical adviser to the Government of that colony,

and took a prominent part in all public health and educational movements; he was health officer to Port Jackson, president of the Board of Health, chairman of the board of the Royal Prince Alfred Hospital, trustee of the Australian Museum, and held many other public posts too numerous to mention. His activities in so many directions were recognised by the conferment of honorary degrees (M.D., Universities of Melbourne and Sydney; LL.D., University of Edinburgh; D.Sc., University of Durham), and finally by the honour of knighthood in 1914.

Anderson Stuart was held in high affection by his students, colleagues, and numerous friends in both hemispheres. He leaves a widow and several sons (who saw service in the recent war) to mourn his loss, and to them our heartfelt sympathy is offered.

By the death of Mr. J. S. MACARTHUR on March 16 industrial chemistry has lost a notable exponent. Mr. MacArthur's name will always be remembered in connection with the Forrest-MacArthur patent for the extraction of gold from its ores by means of cyanide. It is given to few men to discover a process which has had such a far-reaching effect in almost every branch of civilised life. The influence of an enormously increased quantity of gold available for mankind has been—as, indeed, it must be—profound, no matter whether it is for good or for evil. Compared with the huge sums of money involved, the amount accruing to Mr. MacArthur out of this patent was infinitesimal. His type was essentially a pioneering one. The initial work in connection with the extraction of gold was carried out with small funds in a laboratory which was in reality a cellar at the back of a Glasgow tenement house. After this work was completed, Mr. MacArthur engaged in many commercial ventures in connection with chemistry and mining, but, with the possible exception of his last, none of them seemed to possess the elements of permanent success. This was the extraction of radium from its ores, which he carried on first of all in Cheshire, and then practically on the shores of Loch Lomond, in order to avail himself of the purest possible water. He was proud of his works there, and delighted to feel that he was able to carry on his work in the midst of such beautiful surroundings. Mr. MacArthur's personality was delightful and genial. His travels had been world-wide, and to anyone interested in mineralogy and travel he was indeed entertaining.

MR. JAMES PROCTER, whose death occurred on March 6, was born in 1841. He took a prominent part in the design and manufacture of the engines required for blast-furnace work and iron and steel works, and is said to have been the first British engineer to construct blowing engines with mechanically controlled valves. Mr. Procter was a member of the Institution of Mechanical Engineers and of the Iron and Steel Institute.

## Notes.

As president of the British Association at its meeting in Cardiff on August 24–28 next, Prof. W. A. Herdman, of Liverpool University, will deal in his inaugural address with oceanography, of which he will give a general survey, and discuss in detail certain special problems and recent investigations, with particular reference to the sea-fisheries. The following presidents of sections have been appointed:—A (Mathematics and Physics), Prof. A. S. Eddington; B (Chemistry), Mr. C. T. Heycock; C (Geology), Dr. F. A. Bather; D (Zoology), Prof. J. Stanley Gardiner; E (Geography), Mr. J. McFarlane; F (Economics), Dr. J. H. Clapham; G (Engineering), Prof. C. F. Jenkin; H (Anthropology), Prof. Karl Pearson; I (Physiology), Mr. J. Barcroft; K (Botany), Miss E. R. Saunders; L (Education), Sir Robert Blair; and M (Agriculture), Prof. F. W. Keeble.

In the interests of physiological and medical research, we may congratulate ourselves that the debate on the mischievous and unnecessary Dogs Protection Bill of Sir F. Banbury was "adjourned" on Friday last. Owing to the length of the discussion on the really important Early Closing Bill, that on the former Bill was prolonged until the rising of the House. It may be pointed out once again that no other animal of the size of the dog can be kept under laboratory conditions in a healthy state, and that the general chemical changes in this animal are closely similar to those of man, mainly owing to its omnivorous nature. The letter by Dr. Thos. Lewis in the *Times* of March 19 shows how obstructive the exclusion of the dog would be to one branch of investigation of great practical utility; and an equally strong case could easily be made out for many others. The report of the last Royal Commission on Vivisection shows that adequate provision against any possible cruelty has already been made, even if it were necessary to do so.

HIS MAJESTY THE KING has approved the award of the Royal medals of the Royal Geographical Society as follows:—Founder's medal to Mr. H. St. John B. Philby, for his two journeys in south-central Arabia, 1917 and 1918; and Patron's medal to Prof. Jovan Cvijic, Rector of the University of Belgrade, for distinguished studies of the geography of the Balkan Peninsula. The council of the society has awarded the Victoria medal to Lt.-Col. H. S. L. Winterbotham, for his exceptional services to the country in the initiation and development of scientific methods of artillery survey and the production of high-class maps of inaccessible areas. Other awards are:—Murefison grant to Miss Czaplicka, for her ethnographical and geographical work in northern Siberia; Cuthbert Peek grant to Mr. A. W. Pearson Chinnery, to assist him in continuing his work in the unexplored parts of New Guinea; Back grant to Mr. J. M. Wordie, for his scientific work on the Antarctic Expedition of 1914–17; and Gill memorial to Mr. Reginald Farrer, for his journeys on the Chinese borders of Tibet.

SIR JOSEPH LARMOR has been elected a corresponding member of the French Academy of Sciences in the section of geometry.

At the meeting of the Royal Irish Academy on Tuesday, March 16, the following were elected honorary members in the section of science:—M. Henri Louis le Châtelier, Prof. George Ellery Hale, Prof. Augustus Edward Hough Love, and Sir Ernest Rutherford.

A COMMITTEE has been appointed to consider and report to the Minister of Transport on the question of the electrification of railways. The Committee is constituted as follows:—Sir Alexander Kennedy (chairman), Sir John Aspinall, Mr. A. R. Cooper, Mr. Philip Dawson, Sir Alexander Gibb, Mr. C. H. Merz, Sir Philip Nash, Sir John Snell, Sir Henry Thornton, and Major Redman.

THE Recording Secretary of the Nova Scotian Institute of Science has been good enough to inform us that at a meeting of the institute held at Halifax on March 8, on the motion of Mr. H. Piers, seconded by Dr. D. Fraser Harris, it was "resolved that the Nova Scotian Institute of Science convey to the publishers and Editors of NATURE, London, its congratulations on the occasion of the fiftieth anniversary of the establishment of that well-known scientific journal, and wish them continued success in the future." On behalf of the publishers, and for ourselves also, we thank the institute for its kind resolution of appreciation and trust.

A PROJECT for systematic exploration in Mediterranean oceanography was started at an international conference recently held at Madrid. According to *La Géographie* for January (vol. xxxiii., No. 1), the States represented were France, Italy, Spain, Greece, Monaco, Egypt, and Tunis. A commission was founded, with headquarters at Monaco and the Prince of Monaco as president. This commission will consider the methods to be adopted. Ships for the work are under construction or being planned by France, Italy, Spain, and Monaco. A beginning will be made this spring, France and Italy working in the Dardanelles and Monaco and Spain in the Straits of Gibraltar. The secretary of the central commission is Dr. J. Richard, Musée Océanographique, Monaco.

COL. VAN RYNEVELD and Capt. Brand arrived at Cape Town on March 20, and thus accomplished a flight along Africa from north to south. Three machines were used. The first left Brooklands on February 4 and was wrecked at Wadi Halfa on February 11. A new start was made from Cairo on February 22 with an aeroplane fitted with the engines from the first machine, and a flight was made so far as Bulawayo, where the machine crashed on March 6. On March 17 a machine was supplied by the Union Government to replace this, and with it Col. van Ryneveld and Capt. Brand completed their African air route of more than five thousand miles. Though not associated with scientific observation during the journey, the flight is a notable feat in the history of aviation.

DR. CHALMERS MITCHELL, in cablegrams from Dar-es-Salaam, published in the *Times* of March 15 and 16, graphically summarises his impressions on the physiography of the Nile basin as seen in his flight from Cairo to Tabora. His despatch depicts the unity of the processes which have moulded the surface of north-eastern Africa. The dominant features due to earth movements are being slowly smothered by sheets of sand and silt deposited in river deltas, in the marginal lakes formed where tributaries are barred entrance to the main river by the raising of its bed and banks, and in wide basins slowly being converted to plains by wind-borne dust. Dr. Chalmers Mitchell represents East Africa as having been cracked, whereas most other lands have been folded, and its vastest plains as due more to wind than to water. The lowlands are being filled by sub-aerial drift which buries the lower irregularities, and leaves the peaks rising abruptly out of the plains like reefs through the sand upon a shore. In the second part of his report Dr. Chalmers Mitchell refers to the beauty of the country, despite its aridity, and offers strong testimony to the progress which has been achieved in the Tanganyika territory, owing to "much ingenuity and vast expenditure of money, well laid out." His remarks on the elephants, giraffes, and antelopes observed during the flight show that the aeroplane would be of great service to sportsmen in the search for big game.

It has frequently been suggested that the very heavy cylinders used for compressed gases are now out of date, and that the advances made during recent years in the science of metallurgy, particularly in connection with steel and its alloys, should enable a vessel to be produced which is lighter as well as safe. In consequence of these suggestions the Department of Scientific and Industrial Research formed a Gas Cylinders Committee in 1918, the members of the Committee being Prof. H. C. H. Carpenter (chairman), Prof. C. V. Boys, Prof. E. G. Coker, Dr. J. A. Harker, Major Cooper-Key, Prof. F. C. Lea, Eng.-Capt. J. McLaurin, Sir Charles Parsons, Major C. J. Stewart, and Prof. J. F. Thorpe. Compressed gases were much used during the war for various purposes, such as, for example, in supplying oxygen for airmen flying at high altitudes and for poison-gas warfare. Industrially also, in war, as in peace, there has been an immense development in the use of oxygen and acetylene for welding, of carbon dioxide and ammonia for refrigeration, of hydrogen for ballooning, etc., which no doubt will be maintained. Arising from the necessity of war, very light cylinders have been manufactured for the purposes above mentioned, and slightly heavier cylinders were made to an Admiralty specification. The Gas Cylinders Committee, in conjunction with the leading tube manufacturers, has made a number of tests of cylinders based upon these war specifications, and it is hoped that as a result of this work it may be possible to recommend the adoption of cylinders considerably lighter than those now in general use.

THE first engineering school to be established in London was that at University College. Since 1828

a succession of engineers have been educated there under an eminent series of professors, and it would be a thousand pities if its work in this direction were now to be cramped for lack of funds. The case was ably put by Prince Arthur of Connaught at a lunch at the Savoy Hotel on Friday last. His Royal Highness explained that the present scheme of extensions of the engineering laboratories of University College had a pre-war inception, and he paid a tribute to the valuable anti-submarine and other electrical research work carried out during the war by the professors at the college. The war had made us realise the necessity for adequate provision for scientific education and research, and he urged the need for the laboratories opened twenty-seven years ago by his father to be modernised and brought up to date. Twenty-four thousand pounds out of the 100,000, which they were asking for had already been subscribed, including 10,000*l.* from Lord Cowdray in memory of his son, the Hon. F. G. Pearson, who lost his life during the war. Lord Cowdray had also promised a further 10,000*l.* when a total of 70,000*l.* had been collected. Dr. Russell Wells (Vice-Chancellor of the University of London) also emphasised the necessity for improved technological education for the future prosperity of the country, and announced further subscriptions aggregating more than 4000*l.* Sir Ernest Moir (honorary treasurer to the fund) supported the appeal, and Sir Robert Hadfield referred to the valuable research and educational work done at the college, which could not be continued without adequate funds. Sir Gregory Foster (Provost of University College) explained how important it was that the extensions should be put in hand without delay, and pointed out that, although the Government policy was to provide grants for maintenance purposes, capital expenditure had to be met entirely by voluntary subscription.

A PAMPHLET entitled "Currency Reform and the Need for a Nickel Coinage on a Decimal Basis," issued by the Decimal Association, directs attention to the recommendations in favour of decimal coinage which have been made from time to time by committees appointed by the Government to consider the question of currency reform. The simplification of account-keeping and of conversions of values into foreign equivalents which the introduction of a decimal coinage would necessarily secure is an advantage which would benefit the whole of our business community, and, in addition, effect a great saving of time in our schools. The Decimal Association is in favour of the pound-mil system, which retains our gold coins and replaces the present bronze coinage by new denominations of 4 per cent. lower value. The main objection to the alternative decimal systems is that they would impair the prestige of the pound sterling, which under the pound-mil system is retained intact. Proposed changes in the materials of our coins are now under consideration by the Government, and the pamphlet urges that the opportunity should be taken to get rid of our present inconvenient system and introduce a new coinage on a decimal basis.

THE second of the Chadwick public lectures on military hygiene was delivered by Gen. Sir John Goodwin, Director A.M.S., on March 15. The lecturer reviewed the Army hygiene during the recent war. The clothing served out to the troops was of the best, and special attention was devoted to feeding and rationing. The water-supply in large measure was subjected to chlorination in order to purify it, bleaching-powder being principally used for the purpose. Special measures were taken for cleansing purposes, bathing stations being established where the men bathed, and in the meanwhile their uniforms were sterilised and fresh underclothing was served out to them. Destructors were built, or extemporised out of biscuit-tins, etc., in which all the camp refuse was burnt. Special means were devised to prevent waste. Thus in the destructors all the solder from old tins was melted out and collected, and fat from the kitchens was saved and sent home for manufacture into glycerine and munitions. By these measures the health of the Army was preserved to a degree unknown in former campaigns. For example, in 1916, among a total strength of a million and a quarter of all nationalities, the number of cases of enteric fever was 0.2 per 1000 men, whereas in the Boer War the figure was 153 per 1000.

THE February number of the *Museums Journal* contains the report of a conference between Sir Amherst Selby-Bigge, Secretary of the Board of Education, and representatives of the Museums Association, headed by Sir Martin Conway, on the proposed transfer of museums to the local education authorities. The association presented a reasoned protest, laying stress on the fact that the educational activities of museums must necessarily be subsidiary to their primary function of collecting and preserving the works of Nature and of man, and to the study of this material in prosecuting "the highest aim of a museum . . . the advancement of science, art, and industry." It is the results of that study which eventually become available for the education of the public. The arguments in favour of linking up all the museums of the country with the national museums under the control of a separate museum board were advanced by Dr. Bather, who instanced among the prospective advantages of such an arrangement "the circulation of natural history and other objects from the British Museum, the provision of expert help, and the cataloguing of the wealth of our scattered museums." Sir A. Selby-Bigge, in his reply, claimed that the conception of education had recently widened so as to include the chief functions which the deputation assigned to museums. The previous number of the *Museums Journal* reprints, with comments, the recommendations concerning the staffs of the national museums made by a Royal Commission, the report of which (Cd. 7338), issued in April, 1914, was obscured by the smoke of war.

A "SPECIAL Report on the Prevention of Venereal Diseases," by Dr. A. Mearns Fraser, Medical Officer of Health for Portsmouth, has recently been addressed by him to the Health and Housing Committee of the

Borough Council, and is worthy of the careful consideration of all authorities concerned with national health. Dr. Fraser urges that the highest aim of a health authority should be the prevention, not the treatment, of disease, and that the necessity for extensive provision for treatment is evidence of the neglect or failure of prevention. He shows clearly that the successful prevention of venereal disease by scientifically accredited means can be achieved only by the adoption of certain sanitary measures which are readily available and easily applicable. These measures consist in the use of a solution of permanganate of potash immediately after exposure to infection and of an ointment containing calomel. The provision of these disinfectants by any local health authority is not suggested, but the authority is recommended to take such steps as are necessary to spread the knowledge of the means of self-disinfection, so that those who insist on satisfying their sexual appetites by promiscuous intercourse may be instructed how to protect themselves from diseases which, when contracted, are notoriously so often communicated to innocent women and children. Since it is far more easy to disinfect men than women, it is rightly urged by Dr. Fraser that it is of the first importance to prevent the infective germs from entering the body of the male, for if one sex can be protected from infection venereal diseases will be well on the way towards extinction. The report gives ample consideration and reply to various objections which have been persistently made against the inclusion of venereal diseases in the category of infectious and preventable diseases which can now be dealt with on scientific lines.

A CURIOUS case of stone worship is described by Mr. H. A. MacMichael among the Tungur-Fur tribe in the Sudan (*Sudan Notes and Records*, vol. iii., No. 1, January, 1920). The stone is known as the "Bride's Stone" or the "Custom Stone." Rites are performed on marriage, at the circumcision of a child, at a birth, and when a high official visits the place. But that at marriage is, as the name implies, the most usual. After the marriage rite the pair are made to rub some blood of a sacrificed animal on the stone in the form of a cross. If they are too poor to afford this, they offer a piece of cowdung. Then they are taken to a neighbouring well, where the officiant takes a piece of mud from the pool, daubs it on the foreheads, shoulders, waists, knees, and loins of the couple, and binds some green grass on their necks, ankles, and wrists—all doubtless intended as a fertility charm.

LAST year the Norfolk and Norwich Naturalists' Society attained its jubilee, and we congratulate its members on their fifty years of good work. The very name of "naturalist" is in danger of extinction. Our pursuits are so specialised that we have ornithologists, marine biologists, and protozoologists who yet could scarcely be called naturalists. Another peril to the name of naturalist was brought about by Mr. Arthur Balfour's use of the word "naturalism" to denote what other people call "materialism." It would be a thousand pities to lose familiarity with this most

honourable name of naturalist, or to pervert it to a false use. Happily, we are safe so long as the Norfolk and Norwich Naturalists' Society flourishes, and others like it. Its latest number of *Transactions* (vol. x., part v., 1918-19) is altogether admirable, with Mr. W. P. Pycraft's paper on "Some Neglected Aspects in the Study of Young Birds," Mr. Robert Gurney's "Breeding Stations of the Black-headed Gull in the British Isles," and Mr. W. G. Clarke's "The Fauna and Flora of an Essex Common." The whole issue is well illustrated and well edited; and Dr. Sydney Long, the society's hon. secretary and editor, says truly that new problems and new points of view continually arise. "It is to be hoped that members of our society may devote attention in the future to such questions as the limiting factors in the distribution of our flora and fauna, to the peculiar physical and biological features of our great asset, the Norfolk Broads, or even to such practical questions as the advancement of agricultural methods by the application of modern ideas on heredity and soil fertility."

THE Sumatran hare (*Nesolagus Netscheri*) is one of the rarest of known mammals. Hitherto only two specimens have ever found their way into a museum, and these are in the Natural History Museum at Leyden. Messrs. E. Jacobson and C. Boden Kloss are therefore to be congratulated on being able to describe four recently captured examples in the *Journal of the Federated Malay States Museums* (vol. vii., part iv.). The specimens were obtained by Mr. Jacobson after a long and almost hopeless search in south-west Sumatra. In its coloration this animal is remarkable, being broadly striped with dark brown on a "buffy or greyish" background, forming a striking pattern, which is admirably shown in two photographs of a living animal. The skin of this creature is so exceedingly thin that it was possible to prepare the specimens captured only after hardening in spirit. It is nocturnal in its habits, and haunts the remote parts of the forest at an altitude of from 600 to 1400 metres. Hence it is almost unknown, even to the natives. So far as can be ascertained, it would seem to live in burrows at the base of big trees or in holes in the ground made by other animals. Mr. Jacobson succeeded in keeping one of the specimens here described for more than a year, during which time it fed readily upon cooked rice, young maize, bread, and ripe bananas. But its favourite food in the wild state would appear to consist chiefly of the juicy stalks and leaves of different species of *Cyrtandra*, which plants form a large part of the undergrowth of the forests in which it lives. Repeated experiments showed that these plants were preferred to all others, and were consumed in large quantities.

THE *Philippine Journal of Science* (vol. xiv., No. 6) contains an account by H. A. Lee and H. S. Yates of the so-called "pink disease" which has recently appeared in the Philippines, spreading rapidly and causing serious stem- and branch-disease of citrus-trees. The organism is a well-known fungus, *Corticium salmonicolor*, which, though not previously reported upon citrus, is known to cause disease on rubber-trees (*Hevea brasiliensis*), cocoa, coffee, and

other plants, economic and wild, in the Orient, where it is now widely distributed, though in 1900 the disease was practically unknown.

THE Journal of the Franklin Institute for February contains the address on "Sound-ranging as Practised by the United States Army during the War" delivered at the meeting of the physics section of the institute in October last by Prof. A. Trowbridge, of Princeton University. The methods used were those developed by our own Sound-ranging Section, and are known to many of our readers. They depend on the differences of the times of arrival of the sound of a gun at six stations near the gun, and are both sensitive and instrumentally very accurate. The residual errors are almost all due to uncertain meteorological conditions at the time of observation. As compared with other methods of location of enemy guns, the American experience is summed up in the following numbers:— During a three weeks' rapid advance sound-rangers accounted for 21 per cent., and flash-rangers for 79 per cent., of the guns located. During the two following weeks, when the advance had been checked, sound was credited with 54 per cent., and light with 46 per cent., of the locations. These records are characteristic, and show that the Sound-ranging Section required a little longer to get into efficient action than the Flash-ranging Section.

We have received a copy of the first volume of the *Chemical Age* (June-December, 1919). Besides more or less ephemeral matter, the volume contains a number of important articles possessing a permanent interest. Among these may be mentioned "The Chemist's Place and Function in Industry," by Sir Robert Hadfield; "Recent Developments in Industrial Catalysis," by Dr. H. S. Taylor; "The Commercial Synthesis of Organic Compounds from Acetylene," by Mr. M. J. Marshall; and "The Synthesis of Ammonia," by Dr. E. B. Moxted. A useful feature of the journal is the weekly account, with illustrations, of patent literature; this keeps the reader early in touch with advances made both in this country and abroad, and will be of value to the industrial chemist and the chemical engineer. It is satisfactory to find that the promising standard of the early numbers is well maintained in the later issues.

It is more than a hundred years since Sir Humphry Davy first described his wire-gauze safety lamp to the Royal Society (1818). The chief use of the lamp has, of course, been in the coal-mining industry. Danger of gaseous explosions also exists, however, in various chemical works where inflammable liquids are dealt with, a frequent cause being the use of naked lights in the repair or cleansing of large holders in which such liquids have been stored. Even at some distance from the liquid a naked light may be dangerous, as vapour given off may render the atmosphere capable of propagating flame. Attention is directed to this fact in the Journal of the Society of Chemical Industry (February 28) by Mr. W. Payman, who advocates the use of some form of safety lamp where artificial illumination is required in such circumstances, and describes various forms of lamp suitable for the purpose.

ENGINEERS who have to solve problems based on the properties of steam, and especially those connected with steam turbines, will welcome a new alignment diagram constructed by Mr. D. Halton Thomson, and published in *Engineering* for March 5. The principal part of the diagram is based on Callendar's equations for the properties of steam, and by applying the principle of duality Mr. Thomson has succeeded in producing an alignment diagram which represents not only the simpler of the Callendar equations, but also the others not hitherto amenable to this treatment. The diagram has scales showing (a) the total heat of superheated or supersaturated steam, and also the total heat of wet steam; (b) the amount of superheat; (c) the dryness fraction; (d) the total entropy; (e) the hydraulic efficiency for multi-stage turbines during superheated or supersaturated expansion; (f) the specific volume of superheated or supersaturated steam, and also of wet steam; (g) the absolute pressure; and (h) the saturation temperature. An auxiliary scale gives the relation of the heat drop and the steam velocity, and the Wilson point is marked on the chart. A straight-edge laid across the scales gives the whole of the required properties at once. As an example of the kind of complex problems which can be answered in this way, we quote the following from the article:— In a four-stage turbine the steam expands in thermal equilibrium from 200 lb. per sq. in. absolute and superheat 100° F. to 1.5 lb. per sq. in. absolute; the stage efficiency is 0.65 and the reheat factor 1.045. Required the pressure, specific volume, and quality at the end of each stage. By no means the least interesting part of the article is an appendix showing the methods employed by Mr. Thomson in transforming the equations to the form desired.

DR. GRIFFITH TAYLOR, the Australian meteorologist, delivered during the war courses of lectures on meteorology to the Commonwealth Flying School and at the University of Melbourne, and as a result he is now publishing, through the *Oxford University Press*, "Australian Meteorology, with Sections on Aviation and Climatology." The volume will include chapters on the study of the weather chart, work at a small station, the peculiarities of the Australian rainfall, the special storms and hurricanes of Australia, actual procedure in upper-air research, the discussion of long-distance forecasting and the application of meteorology to aviation, etc.

IN the *Veterinary Review* for February (vol. iv., No. 1) Mr. Fred Bullock contributes an instructive article on the compilation of bibliographies. Full details are given of the proper manner of compiling a bibliography, and a number of examples of correct and incorrect references to journals and other publications are given and criticised.

MESSRS. CROSBY LOCKWOOD AND SON, 7 Stationers' Hall Court, London, E.C.4, have just issued a new select list of books published by them on chemical technology. A copy will be sent to any reader of NATURE post free upon application to this well-known firm of publishers of modern scientific, industrial, and technical books.



### Our Astronomical Column.

THE TOTAL SOLAR ECLIPSE OF 1918 JUNE 8.—Vol. VIII., No. 4, of the Proceedings of the American Philosophical Society is entirely taken up with a discussion of the observations made during this eclipse. The photographs taken by the Lowell Observatory Expedition at Syracuse, Kansas, bring out very clearly the connection between the prominences and the coronal arches. It is pointed out that this connection is much easier to trace at sun-spot maximum than at minimum. Dr. Slipper's photographs of the coronal spectrum indicate that coronium is much more abundant in the equatorial than in the polar regions. Messrs. Jakob Kunz and Joel Stebbins were stationed at Rock Springs, Wyoming, and measured the total light of the corona by photo-electric cells. Comparison was made with the full moon through the intermediary of standard candles. Allowing for absorption by the atmosphere, the total light of the corona was 1.07 candle-metres, just half the value found for the full moon. Comparison of the corona with the sky near the sun before and during the eclipse showed that the corona gave 1/10th of the sky light (same area) in full sunshine, and six hundred times the sky light during totality. It is obvious that most of the illumination of the landscape during totality comes, not from the corona, but from the distant regions of the terrestrial atmosphere, which are outside the shadow. Endeavours are being made by Prof. Hale at Mount Wilson to detect the corona in daylight by the use of photo-electric cells.

Mr. John A. Miller, of the Sproul Observatory, describes some researches to detect motion in coronal streamers by comparing plates taken at different stations. Recessions from the sun of 90, 60, and 15 miles per second were indicated for three different streamers. Mr. Miller also states that the forms of many of the streamers can be explained on the supposition that they are projected matter acted on by a repulsive force.

A NOON REFLECTOR.—Prof. C. V. Boys describes in the *English Mechanic* for March 5 an ingenious little instrument which he states to be capable of determining apparent solar time within a second. It is essentially a transit instrument; a small mirror,  $\frac{1}{2}$  in. in diameter, is mounted on an axis about 2 in. long, with cylindrical ends which rest in two Y's, mounted on a stand which is capable of being firmly fixed in a window of southern aspect. Full details and drawings of the various parts are given in the article, with instructions which should enable any person with a mechanical bent to construct it. Small movements for fine adjustment in level and azimuth are allowed for in the design. Some protecting cover and some means of fixing firmly after adjustment is secured are also demanded, as it is somewhat tedious and troublesome to adjust it with high accuracy. The mirror is so small that the reflection of the sun on the opposite wall is fairly well defined, like a pinhole image, and the author states that he has frequently been able to see large sun-spots clearly. There is a certain amount of penumbra, but by practising uniformity in observing either the inside or the outside of the penumbral fringe the time of transit of the sun's centre may be determined to a second. The meridian is marked by a line on the north wall of the room; the noon image of the sun may be brought to the same point at all times of the year by rotating the mirror axis in the Y's.

### American Fossil Vertebrate Animals.

AMERICAN palæontologists are making good progress with their detailed studies and descriptions of the original type-specimens of the various species of extinct vertebrate animals found on their continent. Most of the first descriptions were necessarily hurried and superficial, often unaccompanied with figures, and they are scattered in numerous small publications. Later discoveries have indicated more clearly the features that are of special significance and need particular attention in each case, so that new descriptions are of fundamental importance for exactitude in the science. Realising this, Prof. H. F. Osborn has just completed a valuable work by bringing together a series of up-to-date technical descriptions and figures of all the type-specimens of fossil horses from the Oligocene, Miocene, and Pliocene formations of North America (Memoirs of the American Museum of Natural History, new series, vol. ii., part I.). He not only deals with every species on a uniform plan, but also discusses in ample detail the correlation of the various formations from which the fossils were obtained. Besides reproducing the original figures already published, he adds many more, and among these the pencil drawings by two Japanese artists are especially noteworthy. A series of new drawings collected to illustrate the evolution of the upper and lower molars of the horses is a welcome compendium.

Other fossil mammals are described and discussed in the sixth volume of papers on vertebrate palæontology extracted from the Bulletin of the American Museum of Natural History, 1915-17. We noticed some of these contributions at the time of their publication, and we are glad to have them so conveniently collected. Several notes on the mammalian remains of the Lower Eocene by Messrs. W. D. Matthew and W. Granger add to our knowledge of the type-specimens by comparison with later discoveries, which are described and illustrated in detail. The paper on the Eocene *Notharctus* by Messrs. W. Granger and W. K. Gregory is also fundamentally important for a discussion of the origin of the Primates. In another valuable memoir Dr. Gregory pursues this subject, and reviews our present knowledge of the fragmentary fossils which seem to afford some information as to the origin of man.

The skeleton of *Diatryma*, a heavy running bird 7 ft. high, from the Lower Eocene of Wyoming, is described by Messrs. Matthew and Granger as representing a new order of uncertain relationships. Some of the Cretaceous Dinosaurs described by Prof. Osborn are also remarkably bird-like; and the wonderfully preserved *Corythosaurus* described by Mr. B. Brown, though evidently an amphibious Dinosaur related to *Iguanodon*, has a bony crest which would make the outward shape of its head like that of a cassowary.

In the volume from the American Museum there are also some notes on the gigantic Dinosaurs related to *Diplodocus*, but a still more important contribution to our knowledge of these reptiles is Prof. R. S. Lull's detailed description of *Barosaurus* in the Memoirs of the Connecticut Academy (vol. vi., pp. 1-42, pls. i-vii.). *Barosaurus* seems to have a longer neck and shorter tail than *Diplodocus*, but is otherwise very similar to the latter. The gigantic *Sauropoda*, indeed, are not easily classified, and we still need many more technical descriptions like that before us.

Some of the type-specimens of the Permian and Triassic reptiles are also redescribed and discussed by Baron von Huene and Mr. D. M. S. Watson in the Bulletin of the American Museum; but the most

striking recent addition to our knowledge is a fine skeleton of *Dimetrodon* from the Permian of Texas, described by Mr. C. W. Gilmore in the Proceedings of the U.S. National Museum (vol. lvi., pp. 525-39, pls. 70-73). Mr. Gilmore has restored the reptile as shown in the accompanying figure, and none of the proportions are hypothetical except the length of the thin end of the tail. The total length is about 7 ft., while the greatest height at the middle of the dorsal crest is nearly 5 ft. It must have been an agile reptile, and the serrated sabre-shaped teeth would be very effective for the capture and tearing-up of its prey. The feet have sharp claws. The remarkable crest on the back is formed by the projection of the greatly elongated neural spines of the vertebrae, as in the existing little lizard, the basilisk, of tropical America, shown in the upper corner of our figure.

of the largest, wealthiest, and most active of the associations under the Department. The annual income, apart from special donations and interest, is nearly 12,000*l.*, and it is hoped that ultimately the association will embrace the two thousand firms engaged in wool manufacturing in the British Isles. The outstanding feature of the year covered by the report has been the appointment of a director of research, Major H. J. W. Bliss having taken up his duties on March 24 last year.

Among the interesting matters dealt with in the report are the seven reports on researches or investigations undertaken by the association; the partial engagement of two specialists and the appointment of two investigators; the development of consulting work; the dissociation from the larger educational institutions—particularly the University of Leeds and

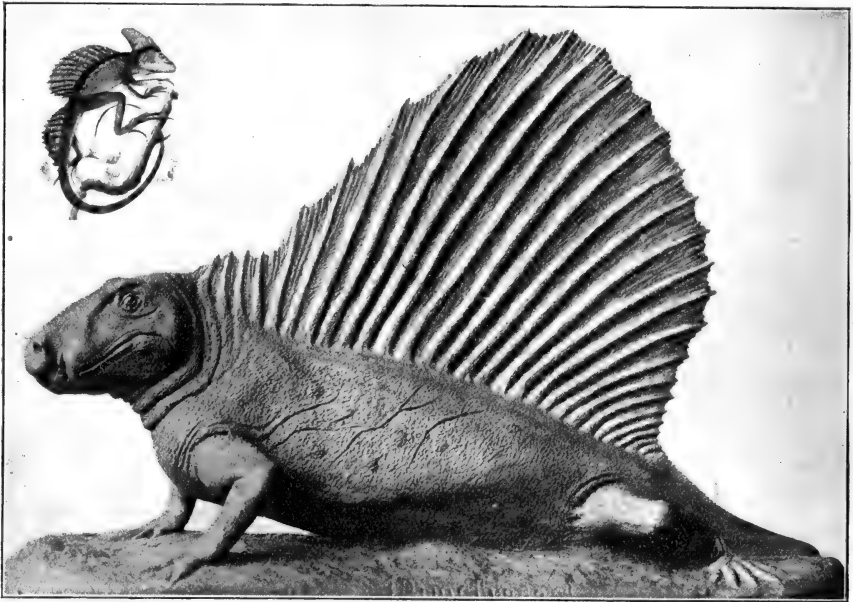

FIG. 1.—Restoration of a primitive carnivorous reptile, *Dimetrodon gigas*, from the Permian of Texas, made by Mr. Charles W. Gilmore for the U.S. National Museum, Washington; about one-twelfth natural size. Inset, the existing lizard, *Basiliscus plumifrons*, from Central America, showing dorsal crest formed by projecting neural spines.

The use of this crest is uncertain, but the most plausible suggestion seems to be that the reptile lived among scrubby vegetation, and the outgrowths, protectively adorned, may have helped to conceal it.

A. S. W.

### Research in Textile Industries.

RECEIVING its initial impetus from the activities of the University of Leeds, later aspiring to wider activities in the West Riding of Yorkshire, the British Research Association for the Woollen and Worsted Industries has now attained to full status under the Department of Scientific and Industrial Research, and, according to the report for 1918-19 of the council, just published, may claim to be one

the Bradford Technical College—and the start on the development of private laboratories at Frizinghall, Bradford; the institution of a library and information bureau and the indexing of past textile publications and research; the formation of two joint committees, one to deal with woollen carding and spinning, and the other with sheep-breeding; the receiving of deputations; and the formation of five local committees for England, Scotland, and Wales.

Reference is also made to the progress of research, especially in the United States and in Germany, attention being directed to the large sums of money spent and the large staffs engaged by individual firms, and the inference drawn that, large as the resources of the British Research Association are, they will have to be much augmented if the requirements of the wool industry are to be satisfactorily met. A little homily

is then given on "The Effect of Neglect in the Past," "Remedying the Neglect," "The Basis of Research," and "Research: What it is not."

It is to be regretted that the report shows a certain lack of appreciation of the conditions under which scientific research and investigations may be conducted. The appointment of a director who comes fresh and unbiased to the wool industry is an experiment well worth watching in view of future developments. But how comes it that the actual laboratories are to be divorced from the Yorkshire University of Leeds? This action appears all the more strange when it is noted that of the seven researches and investigations undertaken, five have been carried out in the University of Leeds; of the four appointments made to the staff, three are from the University of Leeds; and of the two large researches conjointly undertaken, both originated in the University of Leeds, the second being started by drawing upon the University's unique flock of Soay sheep.

It is further somewhat strange to read that "in the simplest matters it is not possible to find information in a correct and authoritative form," in view of the fact that the country which has been specially commended in the report for its highly developed research activities (the United States of America) adopts a Yorkshire text-book as its standard work of reference, and that Australia similarly regards Yorkshire publications on wool. We hope that the tendencies here indicated are only a passing phase, and that ultimately credit will be rendered to those institutions, particularly the University of Leeds and the Bradford Technical College, and individuals who by their labours in the past have made possible the development of this association.

Research work on wool presents such remarkable difficulties that apparently the only possibility of sound progress in the future lies in the closest and most amicable association of all institutions and individuals specially qualified to assist in introducing science and scientific method to the greatest possible extent throughout the wool industries. It may be that the secrecy insisted on by this association is essential in the interests of subscribing members, but the broader interests of research are represented by an approximately equal Government contribution, and it is obvious that these broader interests can best be fulfilled by a well-considered scheme of association between the educational institutions in question and the Research Association.

### Climatology of North-west Russia and France.<sup>1</sup>

THE withdrawal of the British Forces from Archangel and Murmansk, the climate of North-west Russia has become a matter of less interest to the average Englishman than was the case six months ago, but to the meteorologist the district remains one of importance. The climatic features of the area in winter must be considered in relation to its intermediate position between the relatively warm waters of the Arctic Ocean and the intense cold of Central Asia. The effect of these two influences is seen in the approximate equality of temperature in January at Alexandrovsk, near the mouth of the Kola River, in the north, and Petrograd in the south, notwithstanding a difference of nearly 10° in latitude between the two stations.

<sup>1</sup> (1) "The Climate of North-west Russia." Pp. 26+4 plates. (London: Meteorological Office, 1910.)

(2) "Études sur le Climat de la France." Deuxième Partie: "Région du Sud-Ouest et du Sud." By A. Angot. Pp. 114+13 plates. (Rézime des Puisse.)

The comparative warmth of the Arctic coast is likely to become a matter of considerable economic importance, as it enables the recently developed port of Murmansk to be used for navigation throughout the year. The dates of the forming and breaking-up of ice on the Nova, Dvina, and Onega Rivers and on Lake Onega are shown in a table in the work under notice, where are given not only the mean date, but also the periods within which the date will occur on the average, (a) once in two years, and (b) once in five years, thus indicating the degree of variability experienced. This may be a matter of nearly as much importance as the actual mean value.

The climatic conditions of North-west Russia are presented in a series of tables giving data for seven stations, while letterpress directs attention to the more important features. It may cause surprise to learn that a temperature of 85° F. has been recorded at Archangel, while the average highest reading for July is 80° F. The percentage of cloudy skies in North Russia is high even in the summer—a feature which is well brought out by diagrams of a novel type, which show the frequency of fog, precipitation, and over-cast, cloudy, and clear skies for Archangel and Kola.

Upper-air temperatures are presented for Petrograd, where trustworthy means are available, and also for Kiruna, in Swedish Lapland, where the number of observations is less satisfactory. In the two tables in which these data are set out, increasing height runs in one case up the page, and in the other down. It seems desirable that one or the other of these methods should be standardised. There is much to be said for reversing the older method and following the more natural way by running increasing heights up the page, so that the greater heights are above the smaller. The paper does not aim at being a complete treatise upon the subject of the climate of North-west Russia, but within a small compass a good deal of interesting information is put together.

The second of the two publications under notice is of a different and more specialised type, dealing with but one branch of climatology, namely, rainfall, for the southern and south-western districts of France. This forms the second part of a larger work which is to cover the rainfall of the whole of France, and, as the discussion of the data is left over until the publication of the whole is complete, the present volume contains little but tabulated matter. The region embraced is bounded by the Rhone on the east and by the Pyrenees on the south, while northward it stops somewhat short of the Loire.

The thirty Departments included in the area are represented by some 950 rainfall stations, the mean "density" varying in general in the different regions from  $\frac{1}{2}$  to 1 station per 10 km. square. In the main tables each Department is dealt with separately in the following manner:—First are set out brief particulars of the different stations giving height above sea-level and the period covered by the observations. Next are given the mean monthly and annual fall in millimetres for each station reduced to the common period 1851–1900. Finally, for selected stations the proportionate fall in each month of the year is shown. The means from these selected stations show the annual march of rainfall for the Department as a whole, and in this case correction is made for the unequal lengths of the months.

At certain stations, more numerous in some Departments than in others, the rain-gauge is placed upon a roof, which leads to an unsatisfactory exposure. It is pointed out that the errors introduced by such an exposure are proportionately greater in winter than in summer, so that the annual curve is distorted. It is worth noting that the normal height of the rim

of the gauge above the ground is 1.5 to 1.8 metres in France, so that a correction would be necessary before making comparison of the results with British records.

An excellent series of charts at the end of the volume indicates the rainfall distribution in each month and in the year as a whole. In the study of these charts one misses a contour map of the country. The annual fall varies from 500 mm. in two small areas on the shores of the Mediterranean to more than 1500 mm. in the mountainous regions. It is noteworthy that, after the Mediterranean seaboard, parts of the Atlantic coast take a high place among the driest regions of southern and south-western France. This is particularly the case in the summer months. A wise discretion has evidently been used in rejecting stations of doubtful accuracy in the preparation of the district means, and in other ways it is evident that trouble has not been spared to render the results as trustworthy as possible. J. S. D.

### Volumetric Testing of Scientific Glassware.

ACCURATE work in the chemical and physical laboratory depends not only on the worker, but also to a large extent on the trustworthiness of his glass measuring apparatus, such as burettes, pipettes, and calibrated flasks. Whilst it is no doubt true that every operator who is master of his craft should be able, on occasion, to verify the accuracy of his measuring instruments, it is also true that both time and practice are required to do it well, to say nothing of the fact that special equipment is necessary for some of the verifications. Hence it is important, both to makers and to users, that facilities should be available for the testing of such instruments by experts, upon whose testimony reliance can safely be placed.

At the National Physical Laboratory apparatus of the kind in question has been tested, in respect of its accuracy, for the past fifteen years, but on a small scale only. Such instruments were mainly obtained from abroad in pre-war days, and it is only within the last two or three years that the making of them has developed appreciably in this country.

With the growth of the industry here it became necessary to make arrangements for testing and certifying glass volumetric apparatus on a larger scale than heretofore. Facilities were therefore provided and regulations drawn up, in co-operation with manufacturers and users of scientific glassware, for carrying out systematically what are known as "Class A" tests—that is, tests on apparatus required to be of the highest degree of accuracy. A pamphlet describing the arrangements and regulations was issued in July, 1918, and a new building has just been completed, with special equipment for dealing with this class of work on a large scale.

Instruments required to be only sufficiently accurate for commercial purposes are designated as "Class B." A permanent scheme for commercial testing of such articles by State institutions, or by other approved bodies, is now under the consideration of the Government. Pending the settlement of this scheme, manufacturers may note that the National Physical Laboratory is prepared to undertake "Class B" tests, which for the present will be carried out at Teddington. It is hoped eventually to arrange for this work to be done at local centres.

A full account of the methods of testing, limits of error allowed, details of construction, and fees charged is given in a new edition of the laboratory pamphlet, "Volumetric Tests on Scientific Glassware." Copies of this pamphlet may be obtained free of charge on application to the Director.

The "Class A" tests are designed for instruments

intended to possess the highest degree of accuracy required in scientific use. Whilst the "Class B" tests are less stringent, the limits of error assigned are such as all graduated apparatus of good commercial quality should comply with, and are necessary for obtaining satisfactory results in ordinary routine analysis.

It is very desirable that the scientific glass-making industry developed in this country during the war should remain as a permanent asset. To attain this end the graduated apparatus produced should be not only well made, but trustworthy in respect of accurate calibration. From the maker's point of view, the advantage of having apparatus guaranteed by an impartial institution is invaluable for establishing a reputation for accuracy. As regards users, they will no doubt be glad to know that it is now possible to obtain apparatus the correctness of which has been impartially verified. The monogram of the National Physical Laboratory is the hall-mark of British scientific glassware so far as accuracy of measurement is concerned.

### University and Educational Intelligence.

ABERDEEN.—Mr. W. G. Craib, formerly assistant at Kew, and now of the botanical department, Edinburgh University, has been appointed to the chair of botany vacant by the death of Prof. J. W. H. Traill.

BIRMINGHAM.—Mr. A. A. Dee has been appointed an assistant lecturer in physics.

CAMBRIDGE.—The governing body of Emmanuel College offers to research students commencing residence at the college in October, 1920, two exhibitions, each of the annual value of 50l. and tenable for two years and, on the recommendation of the student's director of studies, for such longer period as the degree course may require. The governing body may also make additional grants to students whose means are insufficient to cover the expense of residence at Cambridge or whose course of research may entail any considerable outlay in the provision of apparatus or materials. The exhibitions will be awarded at the beginning of October, and applications should be sent so as to reach the Master of Emmanuel (The Master's Lodge, Emmanuel College, Cambridge) not later than September 18.

The new statute authorising the degree of Doctor of Philosophy for Research has been approved by His Majesty the King in Council, and regulations giving effect to the new statute will be offered for acceptance at the first Congregation in the Easter term.

Mr. F. B. Smith, of Downing College, has been appointed reader in estate management.

Vacancies are announced in the Cayley lectureship in mathematics and in the University lectureships in physiology and zoology. Candidates must apply to the Vice-Chancellor by April 20.

EDINBURGH.—In consequence of the appointment of Mr. W. G. Craib, of the botanical department, to the chair of botany in the University of Aberdeen, it has been arranged as a matter of urgency that Sir George Watt, formerly professor of botany in the University of Calcutta, deliver the course of lectures on Indian forest trees during the summer term.

Mr. James Templeton has been appointed lecturer in botany in succession to Mr. Pealling (resigned), and Dr. Bella D. MacCallum full-time assistant in the same department.

With the assistance of the Scottish Committee of the Royal Aeronautical Society, the services of four lecturers had been obtained to give a series of lectures

on aeronautics in connection with the engineering classes at the Universities of St. Andrews, Glasgow, and Edinburgh. The University Court voted a grant of 50*l.* to defray the cost of the lectures in Edinburgh, and suggested that the lectures should be open to the public.

M. l'Abbé Breuil, of Paris, has been appointed Munro lecturer on prehistoric archæology for the academical year 1920-21.

**LIVERPOOL.**—The University, through its Chancellor, Lord Derby, has just issued an appeal to its constituency, the counties of Cumberland, Lancashire, Cheshire, and North Wales, for funds that will enable it to come abreast of present needs. Some of the laboratories have been in existence since 1881, and are obviously inadequate, while all of them are now too small; thus the practical course in elementary physics is being repeated eleven times each week. The library needs to be extended; the chemical laboratories are so overcrowded that work is being carried on in Army huts; new departments are contemplated and interesting developments are being thought out. A chair in the mathematical theory of statistics, a ship-model tank, a department of colloidal chemistry, and a department of marine food industry are among the "futurist" ideas that make this appeal so relevant to a great industrial and commercial centre. It is hoped that the sum of a million pounds may be obtained, and of this about 500,000*l.* is urgently required for pressing expansions. Already about 200,000*l.* has been promised.

ON Saturday last, March 20, the third annual dinner of the metallurgy department of the Sir John Cass Technical Institute was held, Mr. G. Patchin, the head of the department, being in the chair. Dr. C. A. Keane, the principal, replying to the toast of the institute, stated that at the present time there are more than a thousand individual students attending the various courses. In 1904 there were three courses and twenty-two students in the metallurgy department, and this year there are eleven courses and one hundred and twenty students.

ONE of the most valuable provisions of the new Army scheme is that which relates to the education of the rank and file. The intention is to provide men in the Army with an educational training equal, or even superior, to what is available in civilian life. Every officer in command of a company will be held responsible for the instruction of his men, not only in drill and discipline, but also in the class-room and workshop, and the result will certainly be increased intelligence and efficiency. For the introduction of this substantial reform Col. Lord Gorell, who since 1918 has been Deputy Director of Staff Duties (Education) at the War Office, Sir Henry Hadow, and Mr. P. A. Barnett are largely responsible, and they are to be congratulated cordially that the scheme of Army certificates of education is to come into operation on July 1, 1921. Four classes of certificates are to be awarded on the results of examination. For the third-class certificate candidates must be able to read intelligently a selected piece of English prose, write a simple letter, work simple sums up to and including vulgar fractions in reference to concrete examples, and answer questions on a course of citizenship and history. The second-class certificate will apparently require a standard of attainment comparable with those of the former Preliminary Local Examinations of Oxford and Cambridge; and the first class, involving English, mathematics, geography and map-reading, and (optional) an ancient or modern language, approximately that of the First School Examination.

By taking, in addition, two or three single subjects from different groups, a special certificate may be obtained. Various practical subjects may be taken for the second-class certificate, and the groups for the special certificate include mechanics, chemistry, physics, botany, zoology, geology, physiology, civil, mechanical, and electrical engineering, agricultural chemistry, and commerce. We shall watch with close attention the application and results of this educational scheme.

## Societies and Academies.

LONDON.

**Royal Society, March 11.**—Sir J. J. Thomson, president, in the chair.—W. G. Duffield, T. H. Burnham, and A. A. Davis: The pressure upon the poles of metallic arcs, including alloys and composite arcs. In a previous communication (Phil. Trans., A, cccxx., p. 209, 1919) the authors showed that the poles of a carbon arc behaved as though they repelled one another, and methods were described by which the pressure upon each pole could be measured. Reasons were given for attributing this effect to the reaction consequent upon the emission of electrons from the poles under the influence of thermionic or photo-electric action. The present experiments relate to arcs between iron, copper, and silver terminals, the rate of variation of the pressure with current density being measured for the anodes and cathodes. The pressures were greater than in the carbon arc, that within the copper arc being the largest. Assuming that the pressure is due to the projection of electrons, a comparison between the kinetic energy of the electron and that of the metallic atom at the temperature of the poles showed sufficient agreement to suggest that the electrons before projection were in thermal equilibrium with the metal of the pole. The reactions upon electrodes composed of an alloy of silver and copper were also measured, likewise those within an arc between a silver and a carbon pole. In this case the pressure was determined mainly by the material of the pole under examination. The problem of the mechanism whereby a gas may be heated is briefly discussed. Some account is also given of the variation in the potential difference between the poles when the material of one is altered.—J. H. Vincent: Further experiments on the variation of wave-length of the oscillations generated by an ionic valve due to changes in filament current. Eccles and Vincent have found that in an oscillatory circuit maintained by a thermionic valve with a grid coil coupling, the wave-length has a maximum value for a certain filament current. This effect is studied further in this paper. In order to vary the filament current, rheostats were designed and used in which the change of resistance was unaccompanied by any sensible change in the self-induction of the filament circuit. The methods of measuring the change of wave-length due to the variation of filament current were different from that employed by Eccles and Vincent, but it was found that the results obtained were independent of the particular method by which the wave-length was studied. It is suggested that changes in several of the variables of a valve-maintained circuit produce effects of the same sign on the wave-length and the amplitude of the oscillations. The wave-length and amplitude decrease with the decrease of the grid voltage or of the plate voltage. They also decrease when the coupling of the grid coil with the main oscillator coil decreases. Increasing the resistance in either the condenser branch or the induction branch of the main oscillating circuit lessens the amplitude and wave-length; while altering the filament current

in either direction from that giving the maximum wave-length gives also a decreased amplitude.—**H. A. Daynes**: The theory of the katharometer. A historical introductory note by Dr. G. A. Shakespear gives a description of the katharometer and an account of its development by him for hydrogen purity measurements and similar work in connection with lighter-than-air craft. The paper discusses the conditions which determine the temperature of the hot wire in the katharometer cell, and shows that loss of heat by conduction through the gas is the most important factor, convection and radiation being quite unimportant. Equations are given expressing the experimental law of heat loss in a single katharometer wire, and these are applied to the case of two wires in parallel in the arms of a Wheatstone bridge. These equations are then used to show what are the conditions for greatest sensitiveness and precision in various cases arising in practice.—**H. A. Daynes**: The process of diffusion through a rubber membrane. The nature of diffusion of gases through rubber membranes is discussed in the light of some recent work. This all points to a simple process, determined by the case of diffusion through the rubber, and by the absorption of the gas by the rubber. This is introduced mathematically into the problem of diffusion through a membrane. The unsteady state is considered, in which the membrane, after being exposed to air, is suddenly exposed on one side to, say, hydrogen, and the rate of emission of hydrogen from the other side calculated. The passage of gas through the material is treated purely as a diffusion problem, the boundary conditions only being determined by absorption. It is shown that measurements of the permeability of a membrane and of the lag on reaching a steady state are sufficient for the determination of both absorption and diffusion constants. Experiments are described in which these conditions are fulfilled. The measurements of the diffusion are made by means of a katharometer. From these experiments the constants of diffusion and absorption for hydrogen, nitrogen, oxygen, carbon dioxide, nitrous oxide, and ammonia are determined. Temperature coefficients for the constants are given for hydrogen, and the high temperature coefficient of permeability of rubber is shown to be due chiefly to the high temperature coefficient of the diffusion constant. The extraordinarily high permeability of rubber to carbon dioxide, ammonia, etc., is shown to be due entirely to the high absorption. A relation is also suggested between absorption and critical temperature of the gas.

**Physical Society**, February 27.—**Prof. W. H. Bragg**, president, in the chair.—**T. Smith**: The balancing of errors. In calculating functions from Taylor expansions or otherwise, the results obtained by summing any finite number of terms will differ to a greater or less extent from the true results. It is shown in the paper that by suitable modifications of the coefficients the results obtained, even when comparatively few terms of the expansion are taken, can be made to approximate very closely to the true results for all values of the variable between selected limits.—**Dr. N. W. MacLachlan**: Notes on the testing of bars of magnet steel. The paper describes the results of experiments with the Ewing double permeameter. It is shown that the assumption underlying the theory of the method, viz. that the end effects are the same with the long and short bars, is not justified, and that the value of  $H$ , as found by calculation on this assumption, is in error. The error did not, however, exceed 1 per cent. for any of the bars tested, but the author concludes that the method is inferior as regards accuracy and convenience to the differential-

coil method.—**G. D. West**: The forces acting on heated metal-foil surfaces in rarefied gases. The present paper arises out of two previous papers by the author on the pressure of light (Proc. Phys. Soc., xxv, p. 324, 1913, and xxviii, p. 259, 1916), and consists of an experimental investigation of the nature of certain peculiar movements of strips of thin metal foil surrounded by rarefied gases and exposed to radiation. The experiments deal chiefly with phenomena at gas pressures below 1 cm. of mercury, and it is shown that the apparently diverse results obtained can be connected by a theory based on the work of a previous paper (Proc. Phys. Soc., xxxi, p. 278, 1919). The author concludes that at the highest rarefactions the pressures on the strips arise from the fact that, if differences of temperature exist in an enclosure, the pressure of the gas is not uniform, but varies approximately as the square root of the latter's absolute temperature. The simple conditions that exist at low gas pressures are complicated at the higher pressures by gas currents which differ fundamentally from convection currents, but are closely connected with the phenomena of thermal transpiration.

March 12.—**Prof. W. H. Bragg**, president, in the chair.—**F. H. Newman**: Absorption of gases in the electric discharge tube.—**J. S. G. Thomas**: A directional hot-wire anemometer. The instrument consists of two fine platinum wires mounted close together, and forming two of the arms of a Wheatstone bridge. These are heated by the current in the bridge. When a stream of gas moves in a direction perpendicular to the wires, but parallel to the plane containing them, the leading wire is cooled, while the second wire, being shielded by the first, is not cooled so much, and may actually be heated on account of the air flowing past it being warmed by the first wire. A deflection of the galvanometer is obtained, therefore, which is reversed if the flow of gas is in the reverse direction. The instrument is much more sensitive than the non-directional hot-wire anemometer.

**Linnean Society**, March 4.—**Dr. A. Smith Woodward**, president, in the chair.—**R. H. Compton**: A contribution to our knowledge of the botany of New Caledonia. The subject of this communication is the collection made by Mr. Compton in New Caledonia and the Isle of Pines during 1914 with the aid of money grants from the Royal Society, the Percy Sladen Trust, and the Wort's Travelling Fund of Cambridge University. The specimens collected have been presented to the British Museum, and the greater part have been worked out in the department of botany at that institution. Dr. Rendle gave a short account of the position and physical character of the island, and referred to previous work on its flora and its general characters. Important features are the igneous rocks which form a mountain chain of gneiss in the north-east, and the serpentine formation which covers the southern portion and occurs in larger or smaller areas throughout the island. The flora is rich, and the proportion of endemic forms exceptionally high. The main affinities of the flora are with Indo-Malaya and South-East Australia, the former represented chiefly in the forest regions and the latter in the scrub and savannah regions; and a study of it suggests that New Caledonia is a very ancient land mass which has been isolated for a very long period. Dr. Rendle also gave a *résumé* of Mr. Compton's account of the ferns and gymnosperms. The latter are of great interest; they number about twenty-seven, and are all endemic. Mr. Baker referred to a number of interesting specimens among the dicotyledonous flowering plants, which included

many novelties. Miss Lorrain Smith gave an account of the lichens, which include a new genus and a fair proportion of new species. Miss E. M. Wakefield referred to the fungi, the geographical distribution of which showed points of interest; and Miss G. Lister described the small collection of Mycetozoa.

**Geological Society**, March 10.—Mr. R. D. Oldham, president, in the chair.—Prof. A. H. Cox and A. K. Wells: The Lower Palaeozoic rocks of the Arthog-Dolgelley district (Merionethshire). This paper gives an account of the geology of the country between the Cader Idris range and the Mawddach Estuary. The physiography of the district was described, and a summary of the work of previous investigators given.

#### MANCHESTER.

**Literary and Philosophical Society**, February 17.—Sir Henry A. Miers, president, in the chair.—Dr. T. Graham Brown: The function of the brain. The activity of an animal, as seen by an observer, consists in movements of its limbs, changes of its attitude, changes in its expression, and so on. This activity is usually called "behaviour." In itself the action is a physiological one, and may be analysed and described in terms of physiological mechanism. It is also used as an *index* of the mental processes. The separate movements of the parts of the body are *integrated* by the nervous system in the total behaviour. This integration may occur at different levels in the central nervous system. The great brain must be present if the animal is to exhibit all the finer shades of behaviour which characterise the normal animal. The two general methods of examination were described and illustrated by experimental observations. Brain injuries and their results in men and animals, with consequential paralysis, and the theory of the "cerebral localisation of functions" were discussed.

**Literary and Philosophical Society** (Chemical Section), February 27.—Mr. R. H. Clayton, chairman, in the chair.—J. Allan: Engineering as applied to the buildings and plant in chemical works.

#### DUBLIN.

**Royal Dublin Society**, February 24.—Dr. F. Hackett in the chair.—Prof. Wm. Brown: Note on the decay of magnetism in bar magnets. Twenty-one bar magnets of different chemical composition were re-tested for magnetic moment per gram after being laid aside for ten years. The most retentive were found to be magnets with about 1 per cent. of C. and those with about 3 per cent. of Cr. The general results show that in ten years the manganese group lost about 25 per cent. of their magnetism, the tungsten group 20 per cent., and the chromium group about 28 per cent.—T. G. Mason: The inhibition of invertase in the sap of *Galanthus nivalis*. The inversion of sucrose in the sap extracted from the leaves of *Galanthus nivalis* takes place with extreme slowness, so that at the end of five days, at a temperature of 29° C., it is still incomplete. The delay is observed whether the sap is pressed from untreated leaves or from leaves the cells of which have been rendered permeable by exposure to intense cold or to toluene vapour; but the delay is least marked in the sap extracted by the first method. It is shown that inversion such as occurs is due neither to the acids of the cell-sap nor to the enzymes of organisms external to the cells, and hence the presence of invertase in the sap seems established. Efforts were made to demonstrate the presence of an invertase-inhibitor by dialysis, and by testing the effect of the sap on yeast-invertase, with negative results. Possibly the

greater part of the invertase of the sap is thrown down with the colloids coagulated by extraction, especially during exposure to cold or to toluene vapour. The inversion of the sucrose was traced by thermo-electric observations of the depression of freezing point of the sap. These observations usually showed a comparatively rapid inversion during the first few hours, followed by a slight reversal or suspension of the process for the next few hours, and then a steady inversion at a very slow rate. The reversal is remarkable, and may be attributed to a condensation of hexoses to form sucrose or to oxidation of the hexoses.

#### Books Received.

Spring Songs. By T. J. W. Henslow. Pp. 54. (London: Electrical Press, Ltd.) 1s. 6d. net.

The Propagation of Electric Currents in Telephone and Telegraph Conductors. By Prof. J. A. Fleming. Third edition. Pp. xiv+370. (London: Constable and Co., Ltd.) 21s. net.

The Arctic Prairies. By E. Thompson Seton. Pp. xii+308. (London: Constable and Co., Ltd.) 8s. 6d. net.

Paper Making and its Machinery. By T. W. Chalmers. Pp. xi+178+vi plates. (London: Constable and Co., Ltd.) 26s. net.

Mathematical Papers for Admission into the Royal Military Academy and the Royal Military College, and Papers in Elementary Engineering for the Royal Air Force for the Years 1910-1919. Edited by R. M. Milne. (London: Macmillan and Co., Ltd.) 10s. 6d.

Annual Reports on the Progress of Chemistry for 1919. Vol. xvi. Pp. ix+234. (London: Gurney and Jackson.) 4s. 6d. net.

A Manual of Elementary Zoology. By L. A. Borradaile. Third edition. Pp. xviii+616+xxi plates. (London: Henry Frowde and Hodder and Stoughton.) 18s.

The Ghost World: Its Realities, Apparitions, and Spooks. By J. W. Wickwar. Pp. 158. (London: Jarrolds, Ltd.) 2s. 6d. net.

Treatise on General and Industrial Inorganic Chemistry. By Prof. E. Molinari. Second edition. Translated from the fourth Italian edition by T. H. Pope. Pp. pix+876+2 plates. (London: J. and A. Churchill.) 42s. net.

Industrial Organic Analysis. By P. S. Arup. Second edition. Pp. xi+471. (London: J. and A. Churchill.) 12s. 6d. net.

Electricity: Its Production and Applications. By R. E. Neale. Pp. viii+136. (London: Sir Isaac Pitman and Sons, Ltd.) 2s. 6d. net.

Aviation: Theoretical-Practical Text-book for Students. By B. M. Carmina. Pp. ix+172. (New York: The Macmillan Co.; London: Macmillan and Co., Ltd.) 11s. net.

The Link between the Practitioner and the Laboratory. By C. Fletcher and H. McLean. Pp. 91. (London: H. K. Lewis and Co., Ltd.) 4s. 6d. net.

A Memorial Volume containing an Account of the Photographic Researches of Ferdinand Hurter and Vero C. Drifffield. By W. B. Ferguson. Pp. xii+374. (London: The Royal Photographic Society of Great Britain.) 25s.

Common Diatoms. By T. K. Mellor. Pp. 16+ plates. (London: W. Wesley and Son.) 6s. net.

Legal Chemistry and Scientific Criminal Investigation. By A. Lucas. Pp. viii+181. (London: E. Arnold.) 10s. 6d. net.

A Map of Europe and Africa (on Mercator's Projection), having Special Reference to Forest Areas

and the Distribution of the Principal Timber Trees. By J. H. Davies. (Edinburgh: W. and A. K. Johnston; London: Macmillan and Co., Ltd.) 8s. net.

A Map of South America, Central America, and the West Indies (on Mercator's Projection), having Special Reference to the Principal Forest Regions and the Chief Timber Trees. By J. H. Davies. (Edinburgh: W. and A. K. Johnston; London: Macmillan and Co., Ltd.) 8s. net.

Cytology, with Special Reference to the Metazoan Nucleus. By Prof. W. E. Agar. Pp. xii+224. (London: Macmillan and Co., Ltd.) 12s. net.

Tuberculosis and Public Health. By Dr. H. Hyslop Thomson. Pp. xi+104. (London: Longmans and Co.) 5s. net.

Macmillan's Geographical Exercise Books: Key to Physical Geography. With Questions by B. C. Wallis. Pp. 48. (London: Macmillan and Co., Ltd.) 4s. 6d. net.

The Sea Fisheries. By Dr. J. T. Jenkins. Pp. xxxi+299. (London: Constable and Co., Ltd.) 24s. net.

The Flora of Chepstow. By W. A. Shoolbred. Pp. x+140. (London: Taylor and Francis.) 10s. 6d. net.

Type Ammonites. By S. S. Buckman. The Illustrations from Photographs mainly by J. W. Tutchter. Part xxi. Pp. 9-16+14 plates. (London: W. Wesley and Son.)

## Diary of Societies.

THURSDAY, MARCH 25.

INSTITUTION OF NAVAL ARCHITECTS (at Royal Society of Arts), at 11.—Sir Alfred Yarrow: Notes on our Economic Position as a Shipbuilding Country.—J. Anderson: Further Notes on the Dimensions of Cargo Steamers.—Dr. I. Bruhn: Freeboard and Strength of Ships.

INSTITUTION OF NAVAL ARCHITECTS (at Royal Society of Arts), at 3.—P. R. Jackson: The Stabilisation of Ships by means of Gyroscopes.—Prof. K. Suyehiro: Yawing of Ships caused by Oscillation amongst Waves.

ROYAL INSTITUTION OF GREAT BRITAIN, at 3.—Stephen Graham: The Hope for Russia.

ROYAL SOCIETY, at 4.30.—Prof. A. R. Forsyth: Note on the Central Differential Equation in the Relativity Theory of Gravitation.—R. D. Oldham: The Frequency of Earthquakes in Italy in the Years 1896 to 1914.—A. F. Dutton: A New Apparatus for Drawing Conic Curves.—Capt. J. W. Bishop: An Experimental Determination of the Distribution of the Partial Correlation Coefficient in Samples of 30.

CHEMICAL SOCIETY (Annual General Meeting), at 5.—Sir James J. Dobbie: Presidential Address.

ROYAL COLLEGE OF PHYSICIANS, at 5.—Sir John R. Bradford: The Clinical Experiences of a Physician during the Campaign in France and Flanders, 19 4 1919 (Lumleian Lecture).

CHILD-STUDY SOCIETY (at Royal Sanitary Institute), at 6.—Dr. E. Sloan Chesser: Adolescence and the Continuation Schools.

INSTITUTION OF ELECTRICAL ENGINEERS (at Institution of Civil Engineers), at 6.—Discussion on—(a) The Electrical Equipment of Artisan Dwellings (with Introductory Paper by L. Mite); (b) The Report of the Farthing Sub-Committee of the Wiring Rules Committee of the Institution.

CONCRETE INSTITUTE, at 7.30.—E. L. Hall: Steelwork in the new London County Hall.

INSTITUTION OF NAVAL ARCHITECTS (at Royal Society of Arts), at 7.30.—C. I. R. Campbell and C. H. May: The Effect of Size upon Performance of Rigid Airships.—Prof. E. G. Coker and A. L. Kembell, jun.: The Effects of Holes, Cracks, and other Discontinuities in Ships' Plating.

CHEMICAL SOCIETY (Informal Meeting), at 8.

FRIDAY, MARCH 26.

INSTITUTION OF NAVAL ARCHITECTS (at Royal Society of Arts), at 11.—Eng.-Comr. H. B. Toslevin: Experience and Practice in Mechanical Reduction Gears in Warships.—J. J. King-Salter: The Balancing of Rotors and Determining the Position and Amount of the Balancing Weights.—Prof. T. H. Havoclock: Turbulent Fluid Motion and Skin Friction.

PHYSICAL SOCIETY OF LONDON, at 5.—Prof. A. S. Eddington and Others: Discussion on Einstein's Theory of Relativity.

WIRELESS SOCIETY OF LONDON (at Institution of Civil Engineers), at 6.—Capt. L. A. T. Broadwood: Harmonics in Continuous Wave Transmissions (Illustrated by Lantern Slides and Experiments).

INSTITUTION OF MECHANICAL ENGINEERS (Informal Meeting), at 7.—P. L. Young and Others: Discussion on Foundry Memories.

JUNIOR INSTITUTION OF ENGINEERS, at 7.30.—W. A. Tookey: The Future of the Gas Industry.

MEDICAL OFFICERS OF SCHOOLS ASSOCIATION (at 11 Chandos Street, W.), at 8.—Dr. G. H. Lock and Others: Discussion on Care of Minor Ailments in School Children.

ROYAL SOCIETY OF MEDICINE (Epidemiology and State Medicine Section), at 8.30.—Dr. S. Monckton Copeman: The Relationship of Smallpox and Alastrim.

ROYAL INSTITUTION OF GREAT BRITAIN, at 9.—Sir J. J. Thomson: The Scientific Work of the late 1st Right Hon. Lord Rayleigh.

SATURDAY, MARCH 27.

ROYAL INSTITUTION OF GREAT BRITAIN, at 3.—Sir J. J. Thomson: Positive Rays.

MONDAY, MARCH 29.

INSTITUTION OF AUTOMOBILE ENGINEERS (Graduate Section), at 8.—W. D. Pile: The Use of Benzol.

ROYAL INSTITUTE OF BRITISH ARCHITECTS, at 8.—Delissa Jones: Higher Buildings for London.

ROYAL GEOGRAPHICAL SOCIETY (at Eolian Hall), at 8.30.—Commander D. G. Hogarth: War and Discovery in Arabia.

TUESDAY, MARCH 30.

TECHNICAL INSPECTION ASSOCIATION (at the Royal Society of Arts), at 5.—Annual General Meeting.

ZOOLOGICAL SOCIETY OF LONDON, at 8.30.—Sir Frank Colver: Exhibition of Skulls of *Macacus lewis*.—Dr. C. F. Sonntag: Abnormalities of the Abdominal Arteries of a Young Panda.—A. Loveridge: Notes on East African Lizards collected 1915-1919, with Descriptions of a new Genus and Species of Skink, and a new Subspecies of Gecko.—A. M. Alston: The Life-history and Habits of Two Parasites of the Blowfly.

ROYAL PHOTOGRAPHIC SOCIETY OF GREAT BRITAIN (Lantern Meeting) at 7.—E. W. H. Piper: Gloucester Cathedral.

ILLUMINATING ENGINEERING SOCIETY (at Royal Society of Arts), at 8.—J. W. T. Walsh and Others: Discussion on Motor-car Headlights in relation to Traffic Requirements.

Röntgen Society (in X-ray and Electrical Departments, St. Bartholomew's Hospital), at 8.15.

## CONTENTS.

	PAGE
Knowledge and Power	93
Aeronautical Research	95
Geognospermic History	97
The Nature of Musical Sound	98
Science of Food. By W. D. H.	99
Our Bookshelf	99
Letters to the Editor:—	
Museums and the State.—Sir E. Ray Lankester, K.C.B., F.R.S.; Prof. J. Stanley Gardner, F.R.S.; Dr. W. M. Tattersall	100
Organisation of Scientific Work.—Sir T. H. Middleton	103
Science and the New Army.—Col. E. H. Hills, C.M.G., F.R.S.	103
Cotton-growing in the British Empire.—Dr. W. Lawrence Balls; Sir George Watt	103
The Separation of Isotopes.—Dr. Thomas R. Merton and Brig.-Gen. Harold Hartley	104
Calendar Reform.—Camille Flammarion; Dr. A. C. D. Crommelin	105
On Langmuir's Theory of Atoms.—Dr. A. E. Oxley	105
Fireball of February 4, 1919. By W. F. Denning	105
Buzzards and Bitterns.—Rev. Canon Edmund McClure	105
Ostrich Study in South Africa. (Illustrated.) By Prof. J. E. Duerden	106
The Conservation of Our Coal Supplies. By Prof. J. W. Gregory, F.R.S.	108
Obituary	110
Notes	112
Our Astronomical Column:—	
The Total Solar Eclipse of 1918 June 8	117
A Noon Reflector	117
American Fossil Vertebrate Animals. (Illustrated.) By A. S. W.	117
Research in Textile Industries	118
Climatology of North-West Russia and France. By J. S. D.	119
Volumetric Testing of Scientific Glassware	120
University and Educational Intelligence	120
Societies and Academies	121
Books Received	123
Diary of Societies	124

Editorial and Publishing Offices:

MACMILLAN AND CO., LTD.,

ST. MARTIN'S STREET, LONDON, W.C.2.

Advertisements and business letters to be addressed to the Publishers.

Editorial Communications to the Editor.

Telegraphic Address: PHUSIS, LONDON

Telephone Number: GERRARD 8830.



THURSDAY, APRIL 1, 1920.

### The Anti-dumping Bill.

THE Bill to prevent dumping and to establish a Special Industries Council to advise as to the promotion and assistance of special industries has just been introduced into the House of Lords by Lord Balfour of Burleigh, and, as might have been anticipated, met with a somewhat dubious reception from certain noble Lords who, faithful among the faithless, still bow the knee to the old gods of Manchester. *Autres temps, autres mœurs.* We seem to remember a time when the present sponsor of the Bill made the "happy despatch" rather than obey the behest of the chief apostle of Tariff Reform and Imperial Preference to follow the path he is now treading. But we live in changeful times, and events are apt to play havoc with principles. Lord Balfour of Burleigh is not by any means the only citizen who recognises that the altered economic conditions of the Empire and of the world are nowadays inconsistent with the *credenda* of the Cobden School.

It cannot be said, however, of the new departure that the Bill, after all, deals with a measure of any very great magnitude. Even if it becomes law it is not likely to have any immediate or world-wide consequence. As regards dumping, it is primarily aimed, of course, at our late chief adversary. The Germans, no doubt, would dump again if they could, or saw any advantage in so doing. But from all accounts they are not now in a position to consign any class or kind of goods at prices at which goods of the same class or kind are sold by them at home in the ordinary course of business. It is, therefore, in the highest degree unlikely that the Board of Trade would be called upon for many months, or even years, to come to prohibit their importation from Germany under the powers of the Customs Consolidation Act of 1876.

The present political and economic condition of that prostrate nation forbids any hope that she can for a long time yet, if ever, resume her old position as a great trading community. Her proletariat has now tasted power as never before, and conditions of production are altogether changed. It is certain that in the case of some commodities, sugar, for example, there is nothing to dump, and the prospect that there ever will be is very remote. But it must never be forgotten that Germany is not the only nation that might conceivably resort to dumping in the future,

and after our bitter experience we cannot afford to let the future take care of itself.

The provisions of the Bill are very elastic, and the Board of Trade is to be entrusted with a fairly wide discretion as regards prohibition of entry. If the imported goods are shown to be necessary in the national interest they may be admitted under such conditions as the Board may order, and any such order must be brought to the notice of both Houses of Parliament. This would not preclude the Board from taking prompt action when necessary; but the Minister would of course be responsible ultimately to Parliament. As an interference with freedom of trade, even the reasonable safeguards involved in this measure will no doubt be fiercely opposed; and it remains to be seen what power the doctrinaires of the old school still retain. The plain man will find it difficult to see the snake in the grass.

The sections of the Bill dealing with the establishment of the Special Industries Council for the promotion and assistance of special industries are, however, of immediate and pressing importance, and it is to be hoped that, whatever may be the fate of the clauses directed to the prevention of dumping, this portion of the measure will not be sacrificed. It is concerned with matters which may be said to have originated out of and in consequence of the war, and to have been forced upon us in great measure by the action of our late enemies. It is notorious that for years prior to the outbreak of war Germany had by divers arts and cunning contrivance sought to hamper and restrain the development of our industries and to thwart the expansion of our commerce. Her methods at times, especially in foreign markets, had violated every principle of fair trading. Her practices were part of her policy of world-wide aggression—*Deutschland über alles*—no matter at what cost or at what sacrifice of commercial rectitude. It was that policy which produced, and probably precipitated, a war which practically every element of German nationality had conspired for a generation past to bring about. It was only on its outbreak that the extent and character of that conspiracy were realised, and that this country fully recognised how it had been tricked, and with what subtlety one after another of the things that count in the struggle which was contemplated had been "cornered" and appropriated. Chagrined as Germany was by our entrance into the war, it was untrue to say, as she alleged, that jealousy of her impending commercial supremacy was at

the bottom of our action. However disquieted and perturbed we might be with Germany's repeated acts of aggression and with the truculence and arrogance of her methods, strained trade relations would never have induced this Empire to draw the sword. That was not the issue which welded the English-speaking world together. But that Germany should have so imagined is intelligible. She had at least good cause for the supposition.

The special industries which the Bill seeks to promote and assist have originated, so far as this country is concerned, in great measure through and by reason of the war. We were compelled to take them up by sheer necessity. Certain of them were among the things of which the Germans had gradually acquired practically complete control for years past. All of them were necessary to our national welfare, and some of them, under the conditions of modern warfare, were essential to our national existence. Our late experience ought surely to have burnt the lesson into the national mind. Never again must we be dependent on outside sources for our medicaments and dyes, certain metals, magnetos, glassware, and optical instruments. These special industries—enumerated in the second schedule to the Bill—were in great measure started during the earlier years of the war. They are defined to be industries supplying commodities which are essential to the national safety, as being absolutely indispensable to important industries carried on in the United Kingdom, and which formerly were entirely or mainly supplied from countries outside these islands. They cannot be said to be firmly established as yet. Some of them, like the manufacture of synthetic dyes, have made extraordinary progress, and their permanence is only a question of time. Others are being developed with more or less rapidity. But every one of them is the subject of continued scientific inquiry and research, and it is the purpose of the projected measure to foster and protect them during this incubatory period.

To this end it is proposed to create a Council of not fewer than five and not more than nine persons of commercial and industrial experience, to be appointed by the President of the Board of Trade. Its duties will be to watch the course of industrial development and, in consultation with the Department of Scientific and Industrial Research and any other Government Department interested in any special industry, to advise the Board as to the promotion and assistance of the special industries named in the schedule to the

Bill, and any other industry which, in the opinion of the Council, is a special industry in the sense already defined. It is required to examine any proposals made as to the promotion and assistance, or any suggestions as to the better organisation or management, of any special industry on the application of any Government Department interested, or any firm or person engaged, in any such industry, to advise the Board as to what steps, if any, should be taken by way of assistance to conserve or promote any special industry, and to indicate the terms upon which, in its opinion, such assistance should be given. It is further required to make an annual report to Parliament stating what has been the progress of any special industry to which State assistance has been given, and what recommendations have been made in respect to it. Lastly, any application made to the Board for State assistance by any firm or person engaged in a special industry shall be referred to the Council, together with any information in the possession of the Board as respects that industry, and the Board may require any firm or persons engaged in that industry to furnish any information which the Council may deem necessary under pain of fine or imprisonment:

These, no doubt, are somewhat drastic powers, but, it must be remembered, they are asked for in the interests of national security, and it is unlikely that in operation they will prove to be inconsistent with the proper interests of private trading. As the Council will be associated with the Department of Scientific and Industrial Research, we assume that it will exert a nurturing influence upon scientific work through which industries are created and developed. No one desires to assist an industry which is not itself endeavouring to grow by the use of knowledge, but when this intention is clearly manifested, the State may very well exercise the function of stimulating it or of removing obstacles to expansion. We are faced with the necessity for doing whatever is within our power to promote the establishment of new industries as a means of increased production, not only because our national position demands the use of progressive methods, but also to enable us to meet the vast expenditure which the war has entailed. We have regained in a measure the control of raw materials, and for their profitable use science must co-operate with industry, and both must be the objects of the fostering care of the State. The new measure seems to have been conceived in this spirit.

## Science and Scholasticism.

*Medieval Medicine.* By Prof. James J. Walsh. (Medical History Manuals.) Pp. xii+221. (London: A. and C. Black, Ltd., 1920.) Price 7s. 6d. net.

PROF. WALSH has written an attractive and most readable account of the course of medieval medicine. He has painted a good, even a speaking, picture, but it is not a likeness which most first-hand investigators of his material will easily recognise, nor is the voice with which it speaks that which is familiar to them. As to his learning and competence for his task, no question can be raised, but the method he elects to adopt is one which has brought much work on the history of science into not unjustified contempt. There are authors, less well equipped than Prof. Walsh, who occupy their time in ransacking the printed masses of ancient literature and abstracting passages which seem to show traces of practices similar to, yet quaintly different from, those of our own time. This of itself, though neither history nor science, is an entertaining and harmless antiquarian diversion. But it is a different matter when such extracts, riven from their context, are gravely pieced together and presented as an account of medieval science to a public necessarily ignorant both of the original material and of the method of research. If an expert, such as Prof. Walsh undoubtedly is, adopts this method, he leaves no alternative but protest to a reviewer with first-hand knowledge.

Prof. Walsh's attitude towards the medieval past may perhaps be illustrated by a single critical sentence: "We have come," he says, "to know more about Aristotle in our own time, and as a consequence have learned to appreciate better medieval respect for him." This, we submit, is not an attitude with which many Aristotelian scholars or many men of science will be found in agreement. It is undoubtedly a fact that at the present time the reputation of Aristotle stands very high indeed as an observer of animal life; but that was *not* the cause of his appreciation in the Middle Ages. In the scholastic centuries his reputation in physical science,—we omit discussion of his position in other departments,—was based chiefly on his view of the form of the universe and of the nature of matter and of man. His first-hand and very valuable observations on the habits, structure, and development of animals were either neglected or they were misunderstood and placed in series with his oracular utterances on the circular motions of the heavenly bodies, the sub-celestial character of comets, the existence of

the outer æther and of the *primum mobile*, the intelligences of the stars, and the continuous nature of matter. It was these conceptions that earned for Aristotle his position in medieval science, and on the errors involved in them Prof. Walsh is content to be silent.

Prof. Walsh similarly places in the forefront of his argument that "the most interesting feature of the work of the North Italian surgeons of the later Middle Ages is their discovery and development of two specific advances of our modern surgery . . . union by first intention and *anæsthesia*." Now, since the days of Hippocrates, and doubtless before, the medical attendant, both for his patients' sake and for his own, has never been reluctant to prescribe narcotic drugs to those in acute pain. The medieval physician was accustomed to use far more drugs than are contained in the modern pharmacopœia, and he included in his long list many sedative and narcotic substances. The very vices of the nations will tell of this, for there was never a time when men did not seek oblivion from care and pain in that form of unconsciousness which is brought by poppy and mandragora and all the drowsy perfumes of the East. Such devices were as freely used by medical men in medieval as in pre-medieval or in post-medieval times; in the nineteenth century they were partly superseded by the advent of chloroform and ether, though many surgeons even yet give a dose of belladonna or opium in addition to the inhaled *anæsthetic* as a routine in major operations. Prof. Walsh, however, seizes on the practice of narcotisation before operation in medieval times, and, directing attention to a few references to the administration of anodyne drugs by *inhalation*,—a generally unsatisfactory procedure with such substances,—he boldly writes:

"Hugh [of Lucca] seems to have been deeply intent on chemical experiments, and especially anodyne and *anæsthetic* drugs. . . . A great many of these surgeons of the time seem to have experimented with substances that might produce *anæsthesia*. . . . With *anæsthesia* combined with *antiseptis*, it is easy to understand how well equipped the surgeons of this time were for the development of their speciality."

The facts are that Hugh wrote nothing on surgery, or if he did his work is lost; that the evidence, such as it is, of his use of *anæsthetics* is at best but second-hand; that among all the tens of thousands of medieval medical MSS.—there are some fifteen thousand in this country alone—perhaps some dozen have a single sentence referring to this process of *inhalation*; that *inhalation* is a measure ill-adapted to the drugs said to

have been used; and lastly, that the principal author who mentions it—Guy de Chauliac—gives no indication that it was a method that he either approved or had ever employed.

This is the general character of the book. History written on these lines has ceased to be scientific, and, however attractive, learned, or entertaining, cannot be regarded as a serious attempt to interpret the past in the light of present knowledge.

CHARLES SINGER.

### Ancient Camps in Gloucestershire.

*The Ancient Entrenchments and Camps of Gloucestershire.* By Edward J. Burrow. Pp. 176. (Cheltenham and London: Ed. J. Burrow and Co., Ltd., n.d.) Price 21s. net.

AN observer who casts his eye over one of the most delightful landscapes in England, the view of the Severn Valley as seen from the escarpment of the Cotswolds, with the Malvern range and the Welsh mountains in the far distance, must have noticed the numerous ancient fortifications which stud the Cotswold glacia. Wave after wave of conquest and armed occupation has broken against this hill rampart. Goidel and Celt, British, Roman, Saxon, Dane, and Norman in succession occupied these uplands, and gradually brought the rich valley lands under the plough. The camps remain as evidence of these struggles in the distant past, down to the time when Cromwell drew his entrenchments on Churchdown Hill at the siege of Gloucester.

We have little trustworthy history beyond Neolithic flint implements and similar remains of the builders of these fortifications, until some of them, like Chipping Norton and Landsdown, near Bath, were occupied by the Romans probably before they reached the stage of constructing fortified cities on the model of the camps of their legionaries, like Glevum (Gloucester) or Corinium (Cirencester). When Christianity replaced paganism, some of these camps, like those at Churchdown and Oldbury, became the sites of Christian churches.

The oldest form of camp seems to have been the hill-fortress, generally consisting of a strong bank and ditch, either cutting off a projecting headland from the downs, or marking off an area with an irregular oval line of entrenchments, the two ends resting on the escarpment of the hill. But the more developed types are infinitely varied, often showing considerable strategical skill in the selection of the site, the alignment of the ramparts, and the provision of a water supply. Others, again, were not designed for permanent occupation, being merely temporary shelters for human beings, cattle, and grain in the event of a sudden

raid by the Silures or other formidable tribes of the West Country.

Much information regarding these camps was collected by the late Mr. G. B. Witts in his "Archæological Handbook of Gloucestershire," by the local historians, and in the Proceedings of the local societies. Mr. Burrow, though not a trained antiquary, has done useful work in compiling this monograph. After an introduction dealing briefly with the ethnographical and historical aspects of the question, he describes in alphabetical order more than a hundred encampments, and he is careful to give references to the authorities on which his notices have been based. A distinguishing feature of the book is the series of excellent illustrations from sketches by the author of all the encampments described. The format of the book is creditable to the local printers, and the monograph, as a whole, is a good example of careful field work and artistic taste.

### Principles of Glass-making.

*Glass Manufacture.* By Dr. Walter Rosenhain. Second edition, largely re-written. Pp. xv + 258. (London: Constable and Co., Ltd., 1919.) Price 12s. 6d. net.

THIS volume is very welcome, because there are so few English books on glass-making. It brings the author's 1908 edition up to date. It is easy to read and interesting throughout. The preface states that the book is intended for those who are users of glass, and makes no claim to be an adequate guide or help to glass manufacturers; this makes the book rather a disappointment to a glass-maker, who, from the title, would expect more explicit information.

The author invariably keeps to general principles, and does not give any practical particulars, and in some cases just stops when there is no need to do so. For example, on p. 17 he states that results serve to show that chemical composition has a profound influence on the mechanical strength of glass, and on p. 18 that the modulus of elasticity was largely dependent on the chemical composition of the glass—then why not say in general terms in which direction the mechanical strength and the modulus of elasticity vary with the chemical composition? On p. 36 the pure sands are stated to contain 0.2 to 0.3 per cent. of iron; this is evidently an error, and should read 0.02 to 0.03 per cent.

The chapter on "Raw Materials" is instructive, but the author overlooks the fact that dolomite is by far the cheapest form in which to introduce magnesia into common types of glass. The remarks on dimension and height of tank furnace crowns

on p. 76 are very good, but the statement on p. 81 that from four to eight fillings are commonly given to pots is not a fact in practice. The principles of annealing discussed in the latter half of chap. vii. are most useful, and confirm the conclusions arrived at by Mr. F. W. Twyman in his paper read before the Society of Glass Technology at Sheffield in February, 1917.

Bottle glass, rolled or plate glass, sheet glass, and crown glass are well explained in general principles in chaps. ix., x., and xi. Chap. xii., on "Coloured Glasses," is good on the whole, but the author has entirely missed the real function of arsenic and antimony in glass-making. The important question of optical glass is treated in chaps. xiii. and xiv., and the requirements are very lucidly explained, but only old methods are detailed; modern developments in manufacture in this branch of the industry are not even mentioned.

The book is well indexed, and will be read with much interest by both users and makers of glass.

### Physical Chemistry.

- (1) *Introduction to Physical Chemistry*. By Prof. James Walker. Eighth edition. Pp. xiii+433. (London: Macmillan and Co., Ltd., 1919.) Price 16s. net.
- (2) *Stereochemistry*. By Prof. Alfred W. Stewart. Second edition. (Text-books of Physical Chemistry.) Pp. xvi+277. (London: Longmans, Green, and Co., 1919.) Price 12s. 6d. net.
- (3) *La Tension de Vapeur des Mélanges de Liquides: L'Azéotropisme*. By Dr. Maurice Lecat. Première partie: *Données expérimentales; Bibliographie*. Pp. xii+319. (Gand: Anct. Ad. Hoste, S.A.; Bruxelles: Henri Lamertin, 1918.) Price 45 francs.

(1) **P**ROF. WALKER'S "Introduction to Physical Chemistry" has, since its first appearance in 1899, been recognised in this country as the standard work for beginners in this branch of science. No great changes from previous editions appear in the present one; the "selected chapter" method of treatment is employed, each branch of the subject being treated from the point of view of showing how physico-chemical principles are applicable to the student's own practical work in inorganic and organic chemistry. Its past success is no doubt due to this and also to the sound and thorough manner in which the explanatory portions are dealt with.

The arrangement of the subject-matter is much the same as in previous editions; two new chapters have, however, been added, one dealing

with "Atomic Number," and the other with "Atoms and Electrons." Several of the chapters have been revised, and a number of additions made with the object of bringing the work up to date. Such additions include brief accounts of Ghosh's equation (1918) to account for the abnormality of strong electrolytes and of Dieterici's equation of state, while mention is made of recent work on specific heat at low temperatures and also of the isotopic elements. A useful feature of the book is a list of important references to the appropriate literature at the end of each chapter. This is a book which can be warmly recommended to students of chemistry.

(2) The author states in the preface to the new edition:

"In general I have tried to condense and re-write the material in such a way as to convert what was, perhaps, too much of a reference book into a more readable text-book. At the same time, by the retention of the references given in the previous edition, the volume still maintains its value as a guide to the literature."

"Certain reviewers of the first edition criticised adversely the amount of space devoted to steric hindrance, and in preparing the new edition I have come to the conclusion that they were right, the more so since this subject now attracts less attention than other branches of stereochemistry do. The portion of the volume devoted to steric hindrance has therefore been markedly diminished."

The plan of the first edition has been followed throughout; two new chapters have been added, one being allotted to the Walden inversion, and the other to "The Arrangement of Atoms in Space," a short account of the X-ray work of Profs. W. H. and W. L. Bragg. The book contains three appendices, the first being an interesting account of the relation between physiology and stereochemistry, the second giving directions for making solid models, the employment of which is a great aid to following the subject, and the third containing references to literature on the subject of steric hindrance. The author has succeeded in giving a critical survey of his subject, including recent important work. The book is well got up and illustrated, but contains a few misprints, which, however, are of a minor character.

(3) This book, which was published in Belgium during the German occupation, deals with a very specialised branch of physical chemistry. Azeotropic mixtures are defined as liquid mixtures which, under constant pressure, distil at a constant temperature, their composition corresponding to a maximum or a minimum in the vapour pressure-composition diagram. The work is a

sort of handbook of the subject, and is arranged in three divisions. The first comprises sixty pages, devoted to a theoretical introduction enunciating general laws applying to binary and ternary mixtures. The author gives empirical rules for predicting whether azeotropism will occur in a given binary mixture and for roughly calculating the azeotropic composition and temperature. This portion is concisely written, but rather spoilt by the frequency and length of the footnotes. The second division, which is the largest portion of the book, consists of tables giving experimentally observed data for about 2500 liquid mixtures, mainly binary. As a result of his own experiments, the author points out that azeotropism occurs fairly frequently, some 1000 new binary systems possessing this property having been discovered. In the third division is given a very complete bibliography, and the book concludes with an appendix containing notes on the preparation, in a state of purity, of some of the organic substances employed in the course of the author's researches.

### Soils and Manures.

- (1) *Soils and Manures in New Zealand*. By L. J. Wild. (New Zealand Practical Handbooks.) Pp. 134. (Auckland, Melbourne, and London: Whitcombe and Tombs, Ltd., 1919.) Price 2s. 6d.
- (2) *A Student's Book on Soils and Manures*. By Dr. E. J. Russell. Second edition, revised and enlarged. (The Cambridge Farm Institute Series.) Pp. xii + 240. (Cambridge: At the University Press, 1919.) Price 6s. 6d. net.

IT is one of the special charms, as it is also one of the special difficulties, of agriculture to the student that it offers such infinite possibilities of variation in its manifestations of the working of the fundamental laws of Nature, not only from country to country, but also from farm to farm, and even often within the confines of the same field.

How desirable it is, therefore, that the cultivator of the soil shall be doubly armed, on one hand with a sound grasp of the basal principles underlying the relationship of crops to soils, and on the other with a knowledge of the characteristic local environmental factors the resultant effect of which determines the level of crop production attainable on the particular area on which his efforts are concentrated! Yet how can the wonderful complex of chemical, physical, and biological relationships involved in the growth of plants in the soil be so simply resolved that he who ploughs may read!

farmer unversed in science, yet engaged in an occupation which represents in its fundamentals perhaps the very acme of complexity in applied science, is a task of the utmost difficulty, and has rarely been accomplished with even moderate success. The common weakness of books of this class, written professedly for the practical farmer, as distinct from the college student, is a failure of the author to keep consistently down to the educational level of his intended reader, to adhere closely to essentials, and to repress the natural inclination to demonstrate his own familiarity with the latest developments of agricultural research, all-important and of absorbing interest to himself, but apt to divert the attention of the reader from the simple essentials which afford him ample material for digestion.

(1) Mr. Wild is fortunate in having in the New Zealand farmer a reader probably on the average better equipped by general education for serious study than the main body of farmers in the home country, and for the particular body of readers to whom he appeals his book is but little open to the foregoing criticisms, so far, at any rate, as the simplicity and clearness of his exposition are concerned. Within the compass of this small book he has condensed a large body of information, much of which will be readily assimilated and found of practical utility by his readers. This applies particularly to his outline of the characteristics and manurial requirements of the various soils of New Zealand. In the exposition of underlying principles to which the first half of the book is devoted, however, we should have ruthlessly eliminated all but the absolute essentials and devoted the space thereby gained to a more leisurely and more fully illustrated discussion of the nature and the mode of action of the latter. Unless we can assume an elementary knowledge of chemistry, physics, and biology in the reader, it is surely better frankly to avoid the attempt at scientific exposition and to concentrate upon implanting firmly in the reader's mind a knowledge of those simple but important conclusions from scientific reasoning and investigation without which he must surely often go astray in his practice.

(2) It is a pleasing indication of the "revival of learning" in British agriculture that a second edition of Dr. Russell's book should have been called for so closely upon its first issue. This work is specifically intended for the young farmer taking a course of instruction of intermediate grade in the type of institution which is now being developed in most counties under the designation of farm institutes. With the teacher's hand to guide him through the more difficult portions, the young

farmer will derive inspiration, together with a useful fund of information, from this book, which is written with the clearness of exposition and forcible reasoning which are so characteristic of all Dr. Russell's writings. The opportunity of a new edition has been taken to embody in the section on fertilisers and manures the new materials and the new points of view which the difficulties of war-time have introduced into British agriculture, whereby the book equips the student with a comprehensive epitome of the resources now at his disposal.

C. C.

### Our Bookshelf.

*Mathematics for Collegiate Students of Agriculture and General Science.* By Prof. A. M. Kenyon and Prof. W. V. Lovitt. Revised edition. Pp. vii+337. (New York: The Macmillan Co.; London: Macmillan and Co., Ltd., 1918.) Price 10s. 6d. net.

"THIS book is designed as a text in freshman mathematics for students specialising in agriculture, biology, chemistry, and physics in colleges and technical schools" (p. v). Whatever may be the needs of the American student, the book would scarcely be of use in this country. Originality is not expected in a small book designed to be "the entire mathematical equipment of some students" (p. v), but the chapter on statics would surely be much improved if it contained some account of simple machines. The section headed "Mendel's Law" on p. 282 is defective and misleading; witness the following exercises (p. 284): "A farmer buys two different kinds of thoroughbred chickens, but allows them to mix freely. How many different kinds of chickens will he have at the end of (a) the first, (b) the second, (c) the third year of hatching? Ans. (a) 3, (b) 5, (c) 9."

R. A. FISHER.

*The Elements of Descriptive Astronomy.* By E. O. Tancock. Second edition, revised, with additional matter on practical work for beginners with small instruments. Pp. 158. (Oxford: At the Clarendon Press, 1919.) Price 3s. net.

MR. TANCOCK is the secretary of the committee appointed by the British Astronomical Association for the purpose of encouraging the teaching of astronomy in schools. This book is based on courses of lessons which he gave to junior forms. A large portion of it is descriptive of the aspect and nature of the various orbs, of which excellent photographs and drawings are reproduced. The remainder is devoted to explaining the celestial motions, which is done in a lucid manner. Instructions are given for making a model of the celestial sphere on the surface of a spherical flask that is half filled with some dark fluid. A useful series of questions and exercises is appended, also a set of passages relating to astronomy, selected from English literature, on which explanation or criticism is invited.

NO. 2631, VOL. 105]

An erratum occurs on p. 55. The time of revolution of Saturn's outer ring should be 137 hours, not 137.

*Vital Statistics: An Introduction to the Science of Demography.* By Prof. George Chandler Whipple. Pp. xii+517. (New York: John Wiley and Sons, Inc.; London: Chapman and Hall, Ltd., 1919.) Price 18s. 6d. net.

THIS manual is intended for American public health officials who, in the author's words, have forgotten most of their arithmetic—not to mention algebra. A good deal of space is consequently devoted to the details of tabulation and the making of diagrams. The census and the statistics of births, marriages, and deaths are fully treated. The absence of uniform laws in the different States of the Union, and the mixed character of the population, are sources of many pitfalls for the student. General rates are of little value in dealing with a population of native-born whites, foreign-born whites, and negroes, and the author duly emphasises the need for care in such cases. The more theoretical parts of the book touch on frequency curves, correlation, and the structure of a life table. In the chapter on correlation, a coefficient 0.54 is described as *low*, and cited as an example of the use of the coefficient as "an admirable weapon for exploding false theories." A public health official would need more technical knowledge than is provided in this book to justify him in rejecting a coefficient of this magnitude.

*Insect Life on Sewage Filters.* By Dr. W. H. Parkinson and H. D. Bell. Pp. viii+64. (London: Sanitary Publishing Co., Ltd., 1919.) Price 3s. 6d. net.

THE title of this little book is rather misleading. The original matter deals almost entirely with one species of insect, *Achorutes viaticus*, in relation to the efficiency of the sewage filters where it is very frequently found in large numbers. The authors seek to prove that *Achorutes* attack and consume the colloidal matter and fungoid growths which often choke the upper layers of the filters, and in this way enable a larger volume of sewage to be purified than is possible when these insects are not present. Experiments were made with two filters; in one precautions were taken to exclude *Achorutes*; in the other the insects were encouraged to develop. Analyses of the effluents produced by these filters showed that where *Achorutes* was absent the purification effected was less than in the other filter, but when the insects were added to the first filter nitrification improved at once. Although the authors' conclusion seems to be justified, their interesting experiment is scarcely worthy of publication in book form. The biological details appear to be mostly from Haig Johnson's work on the subject.

*The Transmutation of Bacteria.* By Dr. S. Gurney-Dixon. Pp. xviii+179. (Cambridge: At the University Press, 1919.) Price 10s. net. This small book deals with certain variations, morphological and physiological, which are

encountered amongst pathogenic bacteria. The word "transmutation" is employed by the author to indicate the transformation of members of one recognised species into those of another, and he refers in detail to the arbitrary methods hitherto employed by bacteriologists for the differentiation of bacterial species. Apart from two or three pages in which the author's own experimental work is briefly described, the book is mainly a study of bacteriological literature in the English language. A large part of the abundant publications in foreign languages is either not dealt with at all, or is analysed from English abstracts. There is a good deal of reiteration, certain observations, often obsolete, being utilised again and again in different parts of the book. The use of the apostrophe in "Aertryck's bacillus" seems to indicate that the name is that of a man instead of that of a place. The last chapter, entitled "The Enzyme Theory of Disease," deals with the idea that most of the attributes of pathogenic bacteria can be referred to the activities of ultra-microscopic bodies of the nature of enzymes, and the author considers that this may be the means by which bacteria may exchange many of their characters and functions without themselves undergoing transformation.

*The Examination of Materials by X-rays. A General Discussion held by the Faraday Society and the Röntgen Society, Tuesday, April 29, 1919. Pp. 88+64. (Reprinted from the Transactions of the Faraday Society, vol. xv., part 2, 1919.) (London: Faraday Society, 1919.) Price 13s. 6d.*

THE Faraday and Röntgen Societies did good work when they held a joint meeting in April last year and thrashed out the position as regards the achievements, possibilities, and limitations of the method of the examination of materials by X-rays. The present volume will form a most useful jumping-off point for the investigator or manufacturer who desires to know what had been achieved in industrial radiology up to 1919. The contributors to this "symposium number" include many of the leading radiographers in this country who have not confined their interests to medical radiology. Not all the noteworthy work achieved during and since the war was, however, available for publication when the discussion was held.

The first paper, by Prof. W. H. Bragg, forms a delightful introduction to the subsequent papers and discussions, which deal with such varied subjects as steel, light alloys, aircraft timber, carbon electrodes, X-ray plates, etc. There are many excellent reproductions of radiographs.

One realises, from a close reading of the volume, that we stand only on the threshold of radiology, and big and unexpected developments are probable during the next ten years. Both the Röntgen and Faraday Societies are to be congratulated on the results of the meeting. We understand the volume is procurable from the secretary of either society.

*Commercial Oils: Vegetable and Animal. With Special Reference to Oriental Oils. By I. F. Laucks. Pp. viii+138. (New York: John Wiley and Sons, Inc.; London: Chapman and Hall, Ltd., 1919.) Price 6s. net.*

THIS is a handy little book, intended, not for the oil chemist, but for those persons concerned in the oil industry who have no knowledge of chemistry, or at least no knowledge of it as applied to oils. There are no doubt many such who will often desire to understand what is meant by the various analytical tests and terms used in the specifications on which large users of oil base their contracts of purchase. For example, on p. 70 of the book there is a specification for oil to be employed as a lubricant for aircraft engines; this stipulates that the oil must have (*inter alia*) a certain iodine number, saponification value, flash point, and so on. The author describes in simple terms what these and similar phrases mean, and how they are employed as criteria of the purity and quality of the oil. He gives also short descriptions of the principal oils and fats met with in commerce, and has some very useful advice to offer on methods of taking samples. Even the expert may peruse this part of the volume with advantage, and the non-technical reader should at least have an intelligent idea of the whole subject after studying Mr. Laucks's book.

*The Birds of the British Isles and their Eggs. By T. A. Coward. First series. Comprising Families Corvidæ to Sulidæ. Pp. vii+376+159 plates. (London and New York: Frederick Warne and Co., Ltd., 1919.) Price 12s. 6d. net.*

THIS volume of "The Wayside and Woodland Series" of handy pocket-guides affords a popular account of our British birds. Such a work, especially if embellished with good coloured plates of the various species and their eggs, and accompanied by trustworthy letterpress, has long been a desideratum. The figures of the birds are reproductions, much reduced in size, of those in the late Lord Lilford's much-prized book. They are 159 in number, and most of them are decidedly good; but others are disappointing from the fact that the three-colour process has not been equal to doing them justice. The figures of the eggs, which are from one of the editions of Hewitson's well-known book, are disappointing for the same reason, and will mislead the tyro who attempts by their aid to name many of his specimens. There is also an acceptable series of black-and-white illustrations devoted to nests, etc.

Mr. Coward's letterpress, as one would expect, is good, but it is questionable if his excellent descriptions of habits have not been awarded too much space at the expense of other sections, among them the British distribution of the more or less local species. Given a knowledge of the bird and where it is likely to be found, its various activities may be observed by those who care to devote their attention to the delights of bird-watching. This neat and useful little volume—the first of the series on birds—will, no doubt, be



much appreciated by those who desire a popular book at a moderate price.

*Practical Exercises on the Weather and Climate of the British Isles and North-west Europe.* By W. F. Stacey. Pp. vii+64. (Cambridge: At the University Press, 1919.) Price 2s. 6d. net.

MR. STACEY has produced an excellently planned little book, a model of the way in which a specific inquiry into a subject of relatively narrow compass should be conducted. But, although the methods he adopts are suitable for school work, the subject-matter under consideration is not geography, and is not necessary for all or perhaps for any of the forms of a secondary school. Mr. Stacey has selected a typical set of weather data for the British Isles from the Daily Weather Reports, and has based thereon exercises in which the pupils construct and interpret weather maps. Naturally enough, the work is based upon the records of pressure observations, and his titles include the terms "cyclone," "depression," "wedge," "col," and "anticyclone." The exercises deal with weather records, but not with climate. It is fairly certain that the study of pressure, as distinct from the study of isobars, is out of place in a school geography course unless carefully correlated with a well-developed course in physics, and it is to be feared that Mr. Stacey's efforts will lead to a juggling with words and symbols rather than to a comprehension of atmospheric conditions.

*Alternating Current Work. An Outline for Students of Wireless Telegraphy.* By A. Shore. Pp. ix+163. (London: Wireless Press, Ltd., 1919.) Price 3s. 6d. net.

As shown by the sub-title, this work is addressed to students of wireless telegraphy. It outlines, without very elaborate mathematics, the general principles of alternating currents and their generation, transformation, etc., in a way readily intelligible to those having already some general knowledge of electricity and magnetism. As the book advances, the treatment specialises more and more in the direction of wireless working. Discussions of the influence of inductance and capacity lead up to a consideration of resonance, and high-frequency resistance is given a prominence justified by its importance in this class of work. A few typical measuring instruments, as used in wireless installations, are briefly described at the end. A reviewer, on turning over the leaves for the first time, might receive a false impression from the presence of an illustration in the chapter on alternating-current generators of an obsolete, although historically interesting, type of machine. This is, however, not unduly enlarged upon in the letterpress. The book is clearly written throughout, and should save those for whom it is intended much trouble and waste of time in picking out the parts of the subject that they require from the many more complete and general works on alternating-current working.

## Letters to the Editor.

[The Editor does not hold himself responsible for opinions expressed by his correspondents. Neither can he undertake to return, or to correspond with the writers of, rejected manuscripts intended for this or any other part of NATURE. No notice is taken of anonymous communications.]

### Science and the New Army.

THE leading article on "Science and the New Army" in NATURE of March 18 raises a number of points of fundamental importance with regard to the future relations between science and the Services. The whole subject may conveniently be considered under two heads: (a) The utilisation of the results of scientific research for military purposes; and (b) the direct employment in times of emergency of scientific workers themselves.

With regard to the first, the difficulty has been the lack of real contact. The university worker is necessarily largely withdrawn from the problems of everyday life; and this, not through either mental incapacity or unwillingness on his part, as many people seem to think, but mainly because his time is usually fully occupied with teaching or university routine. Thus he is not, in many cases, even aware of the problems which need solution, and some organisation is required to bring them to him. More, however, than this is wanted if he is to give active help, and attention will have to be carefully given to the following points:—

(1) There is a great disinclination among reputable scientific societies to publish work (even though it may be of considerable practical value) which does not constitute a definite advance in science itself. Now, the solutions of many Service problems are, from the scientific point of view, trivial, though laborious. Nevertheless, it is of great importance that they should be *explicitly* worked out and reach the people interested. On the other hand, technical journals often look askance at what they would probably call "academic" contributions. There is here a gap to be bridged.

(2) Even a scientific worker will expect either remuneration or credit for his work; if the Services expect his collaboration, they must be prepared to pay for it. It has frequently happened that scientific men have given their time and efforts without stint and received little beyond mere thanks (if as much), whilst the credit has been monopolised by some administrative official.

(3) It must also be made clear that scientific workers are not wealthy amateurs, and that the sum (sometimes considerable) necessary to finance preliminary experiments must be provided. Further, the Services must be willing to take the worker into their confidence and to let him observe for himself the actual conditions to which his work will apply. Most Service men cannot even state a problem to a researcher, and are incapable of distinguishing between data which are essential and those which are not. It is entirely useless to expect a scientific man to work in the dark, on second-hand statements from them. For example, one cannot work on submarine detection without submarines at one's disposal. Facilities (which may involve the temporary use of a ship, of aircraft, or of troops) are necessary if results are to be obtained.

In this connection I feel doubtful as to the wisdom of the policy quoted in your leading article from the memorandum of the Secretary of State for War of separating what is called "pure research" (query: Does this mean "research in pure science"?) from

"applied research," which latter it is proposed to restrict to military institutions. This seems an unfortunate distinction. If a research is initiated in view of a definite application, then that application must never be lost sight of, and the whole should be co-ordinated by the same brains, or else the "pure" and the "applied" researchers will be at cross-purposes. The co-ordination should be done by the research worker himself, not by semi-scientific officials appointed for the purpose.

(4) The creation and development of firms willing to carry out experimental work ought to be encouraged and subsidised. Even during the war, and with the backing of a Government Department, it was often a matter of the very greatest difficulty to get firms not to neglect experimental work in favour of mass production.

(5) It would be well if officials would understand that a scientific man does not work in the same way or under the same conditions as, say, an orderly officer or a clerk, and that he should be given the utmost freedom of movement and of hours; that he should not be continually bothered with reports and returns or unnecessary official correspondence; and that usually he does his real work, not in an office, but in the solitude of his study, and sometimes during wakeful hours in the night. They will also have to realise that research work is individual, and that one cannot hand it over from one person to another every six months, as one does a platoon.

(6) Finally, the Services must be prepared to put up with negative results without making a wry face or putting a black mark against the worker. The trail of science is dotted with the bones of dead theories and the remains of unsuccessful attempts, yet it is largely by means of these that science has been built up.

Coming now to the other side of the question, namely, the employment of scientific workers in the Services in an emergency, this is a problem needing urgent and careful attention. Undoubtedly the treatment of it during the war left much to be desired. The only co-operation which the War Office apparently looked for from the universities, previous to the outbreak of war, was that, through the Officers Training Corps, they should provide a proportion of Reserve officers—chiefly infantry—with a minimum of military training of the normal pre-war type. The idea of using the specialised knowledge of the universities for the technical services of the Navy, Army, and Air Force took shape only very slowly, as the development of the actual fighting made it plain that science would play an increasing, perhaps eventually a predominant, part in modern warfare. By that time much of the promising human material which the universities might have supplied had already been wasted. The main difficulty, however, which was then encountered (and still exists) was that the regular military or naval officer upon whom devolved the choice of persons for appointments of a quasi-scientific nature had not, in general, a suitable education or training for estimating scientific ability. The inevitable result was that large numbers of young men with little or no qualifications got taken on in a hurry at their own valuation, while the best use was not made of such real experts as were available.

I feel that the writer of the article in NATURE has hit the right nail on the head when he says: "Until it is made obligatory for a proportion of them [the General Staff] to have had such a training [in science], the fundamental reform will not have been effected." The same, of course, applies even more strongly to the Air Force and the Navy. In the latter the scientific tradition is much more powerful, and there, on the whole, far better and more intelligent co-

operation was obtained. I would suggest, however, that what is most urgently needed for General Staff officers is a course of scientific classification and organisation where they would be taught the real meaning of scientific qualifications and the names of living authorities in various subjects. This would enable the military administrator at least to make an intelligent selection.

I also agree that "it is surely most desirable that, for the future, science should have some scheme of mobilisation ready." What is wanted is a mobilisation register of all scientific workers, carried out under the auspices of a committee on which the various scientific bodies and the universities should be represented. This mobilisation register would indicate, from the scientific side, the age, qualifications, and grade of the worker, the nature of the work which may be expected from him, and the remuneration which he is entitled to expect. The Service authorities could then add medical category, arm or branch of Service to which assigned, rank (if it be desired to give a commission), unit, and place of mobilisation.

So far I have dealt purely with the technical side of the Services; but brains are not unnecessary on the executive side, and the suggested register might well be extended to cover men with high intellectual (not necessarily scientific) qualifications who happened also to have had an adequate amount of military training, so that on the outbreak of war they might be ear-marked for Staff appointments. In 1914 we had a highly trained, if small, General Staff; unfortunately, most of them (to their own great honour, but the nation's loss) rushed to the front line, and a large proportion never returned. Their places and the new vacancies created by the expansion of the Army were necessarily filled in an unsystematic way, as emergency dictated. Many of the junior Staff appointments had to be given to men who had had an inadequate general education and no pre-war military training.

The War Office might well consider the possibility of instituting a General Staff Reserve, largely drawn from among university men. The officers of this Reserve should (by expanding the Officers Training Corps organisation or otherwise) be kept in constant touch with the growth of military thought and practice; they might be called up at fairly frequent intervals for courses, or attachments to Regular units, or manoeuvres on a large scale, and they should be adequately remunerated for the time they gave.

L. N. G. FILON.

University of London, University College,  
March 20.

I HAVE read the leading article on "Science and the New Army" in NATURE of March 18 with great interest but with mixed feelings. The meaning of the word "research" and the value of the investigator who researches have, in my opinion, never been fully appreciated by the official or military mind.

The attitude of repression and discouragement so general at the beginning of the war was particularly depressing for those of us actually in one of the Services, and therefore not free agents. Towards the end, however, there certainly was a distinct and gratifying change of front—a change which, at any rate in the section I knew best, produced excellent results. Yet, with the best intentions in the world, the authorities in their experimental establishments must needs call into existence a bewildering and unnecessary maze of organisation, or rather over-organisation, in which ten men did badly the work of one, and the few true investigators and designers, for whom presumably all this had been arranged, found

themselves so tied and hobbled as to be practically helpless.

It does not seem feasible, in fact, usefully to organise research on such lines. Research—and design, for that matter—speaking again of the little corner I knew, has been almost invariably the result of the strenuous effort of individuals, and not the fruit of the organisation in which these particular individuals happen to have been embedded at the time. It is not meant to imply that there should be no organisation in Government experimental establishments, but, speaking from experience, I feel most strongly that capable investigators and designers will not produce their best if compelled to work in an atmosphere of over-organisation.

What must surely be a matter for congratulation to the body of scientific workers in the country is the fact, which the article referred to brings out, that the Army (and presumably also the Navy and the Air Force) has learnt its lesson, and hastens to admit that there is something to be gained even in peace from the universities and other scientific and technical institutions. Yet here again one seems to detect—perhaps in pessimism—a touch of misunderstanding. The Government's policy (expressed in the following rather unfortunate words) is "to farm out to civil scientific institutions, such as the universities, the National Physical Laboratory, the Imperial College of Science, etc., all pure research that can be profitably farmed out." The universities will surely be only too willing to give the most sympathetic consideration to a co-operative scheme of this sort, provided that the subject-matter of the researches to be "farmed out" is sufficiently interesting and important.

Presumably the Department of Scientific and Industrial Research will be largely responsible for the allocation of these researches, but if at the same time the smallest step is taken towards "the detection of overlap [in research], where such exists, and its elimination," a feeling the reverse of sympathetic will be set up.

Investigations worthy of the name should surely be carried out in all freedom of both thought and action; even the suspicion of interference would be intolerable. The official interest now taken by the Army in scientific research is a great sign of regeneration—if, indeed, it is more than a surface interest, as we all hope. Let us pray that over-organisation of the Government experimental establishments and unsympathetic treatment of civil scientific institutions will not dwarf the growth of the new scheme.

R. WHIDDINGTON.

The University, Leeds, March 23.

THE leading article in NATURE of March 18 directs timely attention to the need for action by men of science if the lessons of the war are not to be forgotten in the Army of the future.

It was impossible in the war to scrap the old machine; years and experience are essential if a better new one is to be made. But no memorandum or paper policy, or even consultation with experts, will make a good machine unless the right material is used.

In peace-time the new Army should have technical education (in the broad sense) and scientific research as its two main functions; they are the only sound bases upon which an efficient fighting machine can be built. That appears to be accepted. But these functions can only be performed by an Army with an educated staff, led by scientific men who combine originality with administrative capacity. If the main body of the staff consists of men without the rudiments of a scientific education, who will "administer"

the men of science and control the allocation of funds, then there will be a largely unnecessary sacrifice of the Army if a great emergency arises.

With regard to the co-ordination of research, it is true that a good deal of duplication must inevitably occur if the independence essential for great discoveries is to be maintained. But there is much unnecessary waste which can be avoided without real restriction of independence. The direct economy is, however, of minor importance; the greatest advantage comes from forming the habit of consulting the right department or the right expert; and this is as necessary for the man of science as for any other man. The late Lt.-Col. W. Watson, whose untimely death deprived the nation of an expert with an almost unrivalled knowledge of the applications of science in war, once related how a board of chemists spent half a day discussing a meteorological problem which could have been solved in half an hour by a single meteorological expert.

E. GOLD.

March 22.

ALL scientific workers whose research has brought them into contact with military authority during the war must appreciate the leading article on "Science and the New Army" in NATURE of March 18, especially the sentences in which it is urged that "science linked to the Army by fussy research co-ordinators acting under a nescient soldier will not solve the difficulty," and that "science will not occupy its rightful position in the new Army" until the General Staff includes a due proportion of officers who are endowed with a scientific spirit and have received a scientific training. Until then some of the outstanding defects manifested during the war will continue. These defects are:—

(1) *The unthinking application of scientific research.*

A good instance of this occurred in the issue of the ridiculously excessive diet (based on research under active marching conditions) to our soldiers in Flanders who were unexercised in the trenches, whilst wholly inadequate rations were being supplied during the period of the soldiers' strenuous training in England.

(2) *The delay in seeking expert advice.* Too often G.H.Q. failed to realise how expert advice could help it, and did not trouble to seek it until too late.

(3) *The choice of expert.* The truly scientific worker rarely asserted himself spontaneously during the war; he waited until his advice was asked. The man who forced himself to the notice of the General Staff as an expert was usually unscientific. Thus G.H.Q. was "taken in," and came to rely too often on those whom the scientific world considered as being pretentious in greater or less degree. Their one source of strength was that they were usually "practical" men, whereas the men of science in some cases offered suggestions which could scarcely be carried out during service in the field. But in the long run the Army suffered.

CHARLES S. MYERS.

30 Montagu Square, W.1, March 20.

**Knowledge and Power.**

THE leading article "Knowledge and Power" in NATURE of March 25 strikes a resonant chord. I am a newcomer into the realms of officialdom, but my experience relates to a Department of State which is of new growth and not yet rooted in tradition. Aeronautics in Britain has had its foundations laid on a scientific basis, and technical staffs have been able to build on trustworthy data. In view of the fact that British aircraft obtained an absolute ascendancy over the craft of any other country, Allied or enemy, and that Britain was the only country with this scientific

foundation, it is not unfair to regard the two facts as being, in some measure, cause and effect.

The scheme which led to the scientific basis was announced in 1909 by the then Prime Minister, and was the result of advice from scientific and technical men, of whom it is sufficient to mention the late Lord Rayleigh as leader. Throughout the vicissitudes of air developments—separate naval and military Forces, Air Board, and Air Ministry—the Advisory Committee for Aeronautics maintained a steady course and steady output of fundamental data. It was, unfortunately, not responsible for the conduct of full-scale research at the Royal Aircraft Factory, and the lack of any definite policy on the part of those in control has led to the reduction of the full-scale experimental side to relative insignificance.

During the war large developments in aviation were called for, and scientific and technical men devoted their efforts to make the best of a very difficult situation. The Technical Department was not attached in an advisory capacity to the Royal Air Force, but was subordinated to the Department of Aircraft Production. As a consequence of this it would appear that the responsible advisers of the Secretary of State too frequently found themselves in the position of children crying for the moon. The effect during the war was minimised by the absence of rigid organisation, and has been fundamentally modified by the recent absorption of the Department of Supply and Research by the Air Ministry, whereby the technical side is directly represented on the Air Council. It can now be pointed out at their inception that certain policies are technically unsound.

The result of relegating the Technical Department to a position of inferiority during the war has been little short of a disaster. Within a few weeks of the armistice both the Controller and Deputy Controller had left; they were followed by the three Assistant Controllers and the great majority of the senior members of the staff. It is true that many had only entered aeronautics in view of the war emergency, but the rapidity with which the offices became vacant was, I think, an indication that the atmosphere was one in which scientific and technical ability could not exist.

The process of attrition is not ended, and the best British business firms are attracting the picked men. Aeronautics, from the business point of view, has been a testing-ground of a man's capacity and adaptability, and as the science and practice of the subject are still young it appears to be better for the individual to abandon his special knowledge and to return to general engineering rather than to remain in a profession which has no openings or prospects for those in it. It is no exaggeration to say that the policy adopted by the State towards scientific and technical knowledge in aeronautics has brought this side of the profession to a condition in which its continued existence is doubtful.

The man of science and the technician, particularly the former, is in large measure himself responsible for this state of affairs. He has been content to recognise the importance of the work he has been doing as justification for acceptance, in spite of a non-commercial salary. The conditions now prevailing have brought home to him the fact that he cannot maintain himself in a reasonable standard of life on this basis. In an age when the value of a man's work is estimated in terms of the money he earns, it is not wise to neglect the criterion applied, although all should help in the search for the sounder basis towards which the industrial world is groping its way. As a scientific man I regret that we are not taking the lead, but are considerable laggards in the search for a just method of payment by results.

March 28.

L. BAIRSTOW.

### Museums and the State.

In the recent correspondence on this subject the opinion has been expressed that a lack of co-operation between the various national museums has diminished their efficiency. In this connection it may be useful to recall the report of a Committee upon the Science Museum and the Museum of Geology in Jermyn Street of which the first part was issued in 1911 and the second in 1912; the former was discussed in *NATURE* at the time (May 4, 1911). This Committee, on which science was strongly represented, was appointed by the President of the Board of Education, and consisted of Sir Hugh Bell, Sir James Dobbie, Sir Archibald Geikie, Sir Richard Glazebrook, Mr. Andrew Laing, the Hon. Sir Schomberg McDonnell, Sir William Ramsay, Prof. W. Ripper, and Sir W. H. White. They were asked to advise as to the educational and other purposes which the collections could best serve in the national interests, the lines on which the collections should be arranged and developed, and as to the new buildings to be erected in order to house and exhibit them suitably.

The report therefore deals with the work and functions of the museums, and does not discuss the form of control most suitable for their administration. Here the Committee makes definite recommendations on many sections of the collections, and wherever these connect with other national institutions it insists upon the importance of co-operation, besides commenting upon any cases where overlapping may possibly occur. Thus there already exists a definite scheme governing the relation of these museums to the Natural History Museum, the Museum at Kew, the Imperial Institute, and the map collection of the Royal Geographical Society; and, but for the war, its results would doubtless by now have been apparent.

In concluding its report the Committee notes with satisfaction the arrangement for providing accommodation for the Museum of Practical Geology at South Kensington contiguous to the Natural History Museum and the Science Museum as contributing materially to that co-operation which it had recommended.

The whole report well repays careful study by all interested in museum organisation. F.R.S.

### The Magnetic Storm of March 22-23 and Associated Phenomena.

A VIOLENT magnetic storm occurred on March 22-23. It had an S.C. ("sudden commencement") about 9h. 10m. on March 22. This was not outstanding, except that the initial increase in H was immediately followed by a reverse movement, bringing the element below its normal value for the next two hours. The normal value was sensibly exceeded from 12½h. to 14h., and again most of the time from 16½h. to 19h. The maximum occurred just after 17h. In the course of twenty-five minutes, from about 16h. 50m. to 17h. 15m., H rose 280γ and fell 360γ. The trace was off the sheet on the negative side for about six minutes near 1h., eight minutes near 1h. 30m., and thirteen minutes shortly after 4h. It was rising rapidly after each reappearance, so that the range shown on the trace, 810γ, was probably considerably exceeded. The largest movements were from 16½h. to 19h. on March 22, and from 0h. to 6h. on March 23. There was a comparatively quiet interlude from 19½h. to 23h. on March 22. The times of greatest disturbance in declination synchronised fairly with those in H. The extreme westerly position was recorded about 17h. 8m. on March 22, and the extreme easterly position near 1h. 40m. on March 23, when the trace was off the sheet for twelve minutes. There were several exceptionally large rapid move-

ments. In the course of about five minutes from 17h. 8m. to 17h. 13m. there was a swing of  $1^{\circ} 35'$  to the east, immediately following a somewhat less rapid swing of  $44'$  to the west. In the course of about twelve minutes from 1h. 9m. to 1h. 21m. on March 23 there were swings of  $76'$  to west and  $59'$  to east, and after a minute's pause the latter swing continued, so that declination at 1h. 28m., when the trace went off the sheet, was  $1^{\circ} 35'$  less westerly than it had been nine minutes before. The range actually shown on the sheet,  $2^{\circ} 1'$ , has seldom been equalled at Kew, and as the trace was off the sheet for twelve minutes it was probably sensibly exceeded.

The vertical force trace was complete, the range of disturbance being about 820y. The disturbance in that element was fairly normal, the value being enhanced on the afternoon of March 22 from 13h. to 23h., and correspondingly depressed on the morning of March 23 from oh. 30m. to 7h. The times of maximum and minimum were respectively about 18h. 20m. on March 22 and 4h. 10m. on March 23.

The outstanding features of the disturbance were the size and rapidity of the largest movements, and the separation of two very highly disturbed periods by a comparatively quiet interlude lasting several hours. The disturbance was preceded twenty-seven days before (February 24) by a considerable, but much smaller, disturbance, which was in some respects the antithesis of the later one. It lasted only about ten hours, and the largest movements occurred in the course of the first three hours. C. CHREE.

Kew Observatory.

This storm was one of exceptional violence. It commenced suddenly at 9h. 6m. G.M.T. on March 22. The H.F. magnet experienced a sharp positive movement of 37y, followed immediately by a decrease in force of  $41y$  ( $1y=10^{-8}$  C.G.S. unit). Similarly, the D. magnet swung sharply to the west and then to the east, the range being  $8'$  of arc.

After three oscillations on the negative side of the normal, a steady rise of value commenced in the H.F. magnet at 10h. 26m., which lasted until 19h. 10m., when the spot of light began to fall steadily towards the normal value of the force. The general character of the movement was that of one long wave with oscillations superposed upon it, the storm being most violent between 16h. and 19h. 10m. During this period the spot of light passed beyond the limits of registration in a series of rapid oscillations between 16h. 24m. and 16h. 30m., 16h. 46m. and 17h. 12m., 17h. 54m. and 18h. 14m., 18h. 41m. and 18h. 47m., and 18h. 47m. and 18h. 51m. The oscillations became less violent and rapid after 19h. 37m. At 23h. 5m. the spot of light had fallen to a value close to that of the base line, so that the extreme range in this sweep of the curve was from a value greater than 550y to 52y.

At 23h. 16m. a rapid oscillatory recovery and increase of value took place, which attained a maximum of 376y at 23h. 36m. The spot of light then went off the recording drum on the negative edge, crossing the base line on March 23 at oh. 24m. During the next four hours it was several times beyond the limits of registration on the negative side in a series of rapid oscillations, in which the greatest range exceeded 260y.

The extreme range in H.F. during the storm was greater than 700y. This value may be compared with the range on the quiet days during January and February, which had a mean value of 18y.

At 4h. 20m. the spot of light returned to a positive value, when a series of very rapid shiverings of the needle took place, similar to those which terminated

the violent magnetic storm of August 11-12, 1919. These oscillations had a range of about 130y, and lasted until 8h. 50m. This may be regarded as the end of the violent storm, though the needle continued to be disturbed moderately until midnight of March 25.

The general character of a sinuous S-like curve is well shown on the trace from the vertical force magnet. It crossed the base line at oh. 44m. on March 23. There was a very rapid oscillation of the needle at 1h. 0m. The spot of light remained below the base line until 6h. 0m., when it gradually rose, with a shivering movement of small amplitude, to its normal value. On the negative side the spot of light was off the recording drum from 1h. 20m. to 2h. 40m. and from 2h. 40m. to 4h. 0m. The extreme range was greater than 900y, and the greatest positive value was 642y.

Corresponding to the gradual increase in force in the H.F. and V.F. elements, the declination magnet gradually swung to the west. The maximum disturbance consisted of some rapid swings of the needle between 16h. 24m. and 18h. 48m. The greatest of these was at 17h. 0m., the range being  $90'$  of arc.

A very remarkable rapid double swing of the needle occurred on March 23 at 1h. 12m. The range of this oscillation was  $130'$ . This corresponds to rapid oscillations in the force elements. The spot of light was now, on the whole, below the base line until 4h. 0m., when there was a rapid movement east and then west between 4h. 15m. and 5h. 0m., with a range of  $120'$ . A series of shivering oscillatory movements then supervened until the end of the storm. The greatest total range in D. during the storm was  $160'$ .

Judging from the three elements, the general movements both in force and in direction were rising with reference to the base line during the daylight hours and falling during the night hours.

The storm was coincident with the appearance of a very great sun-spot group on the sun's disc which appeared between March 16 and 29, and was passing the central meridian on March 22-23. Its mean heliographic latitude was  $-6^{\circ}$ , and it extended from longitude  $114^{\circ}$  to longitude  $150^{\circ}$ . It was the biggest group of sun-spots observed since August, 1917, and its disc area, in units  $1/5000$ th of the visible disc, was 34 on March 22.

It was a revival of a similar extended group of spots of large area observed from January 21 to February 3. At the next rotation, February 17-27, this group appeared as an insignificant small spot and dots amidst extensive faculae. But the magnetic elements began to be disturbed during this second rotation of the spot-group on February 16-17.

Through the kindness of Lt.-Col. Penny, R.A.M.C., the O.C. Queen Mary's Military Hospital, Whalley, in the immediate neighbourhood of Stonyhurst College, I have received the following account of the aurora borealis observed by him in the early morning of March 23:—

"On going out of doors at about 3.15 a.m. I noticed this display, but I do not know how long it had been visible. It was a clear, starlight night at the time. The aurora was exceedingly fine when I first saw it, the best I have ever seen. It consisted of about eight broad beams of light, most of which, except the extreme west and north ones, extended to within  $5^{\circ}$ - $10^{\circ}$  of the zenith. The lights extended over about  $90^{\circ}$ - $100^{\circ}$  from approximately north-north-east to west by north.

"The beams became pale and brilliant again several times, besides constant slighter variations in intensity. On two or three occasions, within about twenty minutes, most of the beams, more than three-quarters,

disappeared, leaving one or two longish ones. The colour was mostly white, but sometimes reddish in parts, especially nearly due north.

"A curious feature was an oblique band of light, which came and went across near the summits of the vertical beams. I do not think this was a belt of illuminated cirrus, as its brightness seemed to vary independently of the vertical beams, but it is possible it may have been. The lights had diminished considerably by about 3.45 a.m., but had brightened again, though slightly, when I looked out a few minutes later. I do not know what time the display ended."

A. L. CORTIE.

Stonyhurst College Observatory, March 29.

### Some Methods of Approximate Integration and of Computing Areas.

THE formulæ which Mr. Percival gives in NATURE for March 18 for approximate integration are well known, but there are one or two points in connection with them which are frequently overlooked, especially by writers of books on mathematics for engineers.

(1) The areas bounded by curves the equations of which are of the form

$$y = a + bx + cx^2 + \dots + kx^n$$

can be obtained from the values of  $2m+1$  equidistant ordinates, not only when  $n=2m$ , but also when  $n=2m+1$ . That this is so is seen most easily by taking the origin at the centre of the range of integration and noting that

$$\int_{-h}^{+h} x^{2m+1} dx = 0.$$

For example, Simpson's first, or three-ordinate, rule gives the area of the cubic

$$y = a + bx + cx^2 + dx^3$$

with perfect accuracy, and for this purpose his second, or four-ordinate, rule is in no way superior.

(2) By a very small change in one of the coefficients Weddle threw the seven-ordinate formula (No. 6 in Mr. Percival's letter) into the very convenient form

$$A = \frac{3h}{10} [y_1 + y_3 + y_5 + y_7 + 5(y_2 + y_6) + 6y_4].$$

The loss of accuracy which the change involves is exceedingly small.

(3) Formulæ based upon the assumption that the boundary curve can be represented by an equation of the form above stated give unsatisfactory results when the actual boundary has tangents at right angles to the  $x$ -axis. This is really the reason why none of the results obtained by Mr. Percival in applying his formulæ to the quadrature of a circle possess a higher degree of accuracy than that represented by the admission of errors of the order of 1 per cent.

If we suppose the curve to cut the axis of  $x$  at right angles at the origin, it is better to assume that it can be represented by  $y = ax^2 + bx$  in the neighbourhood of that point.

If  $y_1, y_2$  be the ordinates at  $x=h, x=2h$ , the area bounded by the curve, the axis of  $x$  and the ordinate  $y_2$  is given by

$$A = \frac{4h}{15} [4\sqrt{2y_1} + y_2].$$

The much higher degree of accuracy resulting from the employment of this formula may be illustrated by applying it to Mr. Percival's example of the quadrant of a circle.

The seven ordinates are:—

$$\begin{array}{ll} y_1 = 0 & y_4 = 0.9428090 \\ y_2 = 0.5527708 & y_5 = 0.9860133 \\ y_3 = 0.7453560 & y_6 = 1 \\ y_7 = 0.8660254 & \end{array}$$

Using the above formula to find the area between the ordinates  $y_0$  and  $y_7$ , and Simpson's first formula for the part between  $y_2$  and  $y_6$ , we obtain the value 0.7853871. The true value is 0.7853982; hence the percentage error is only 0.0014, which compares very favourably with the errors ranging from 0.8 to 1.34 per cent. obtained by using the usual formulæ for the whole range.

Mr. Percival's example clearly shows that when the curve has a tangent at right angles to the axis, no material reduction in error is attained by using formulæ with a larger number of ordinates. The use of Simpson's formula over ordinary ranges and of the formula given above in the neighbourhood of such tangents will prove much less laborious and far more accurate.

J. B. DALE.

King's College, Strand, March 22.

IN NATURE of March 18 Mr. A. S. Percival gives an example (the quadrant of a circle) in which Simpson's rule (sometimes called his first rule) is more accurate than the "three-eighths" rule, and he remarks: "This result is curious, and shows that a small arc of a circle approaches more nearly to a small arc of a parabola than to a small arc of any cubic curve." Permit me to point out that this inference is not valid, and is based on the almost universal illusion that Simpson's rule is correct to the second order only, i.e. for the parabola

$$y = a + bx + cx^2.$$

It is easy to show by simple integration that Simpson's rule holds to the *third* order, i.e. for all cubics of the form

$$y = a + bx + cx^2 + dx^3,$$

passing through the three chosen points. It is thus precisely accurate, not only for the parabola, but also for a singly infinite number of curves passing through the three points, even if an inflexion occurs.

One would therefore expect (which I believe to be the case) that where both rules can be applied (e.g. if there are seven ordinates) Simpson's rule would be more accurate than the "three-eighths" rule, which is precisely true only for a single curve passing through four consecutive points.

In some cases, when the gradient is not rapid, Simpson's rule is highly accurate. Dr. Lamb ("Infinitesimal Calculus," p. 278) gives an example in the evaluation of  $\pi$  to six decimal places from the equation

$$\int_0^1 \frac{x^2}{1+x^2} dx = \frac{\pi}{4}$$

by taking ten equidistant values for  $x$ , but he does not notice the illusion to which I refer. I am surprised that such a simple and easily tested truth should so long have escaped the notice of many expert mathematicians.

R. A. P. ROGERS.

Trinity College, Dublin, March 20.

### Gravitational Deflection of High-speed Particles.

THE result mentioned by Mr. Leigh Page and verified by Prof. Eddington (NATURE, March 11, p. 37), that the gravitational effect on a particle travelling radially is a repulsion if the speed exceeds  $1/\sqrt{3}$  times the light-velocity, is given by Hilbert in the *Göttinger Nachrichten* for 1917. The same paper contains interesting remarks on the path of a particle or light-speed moving spirally round the gravitation centre.

Hymers College, Hull.

H. G. FORDER.

## Colouring Matters of Plants.

IN view of the fact that many of Nature's most striking colour effects are produced as the result of harmonious groupings of highly coloured plant life, and that it is to the various plant pigments that these fine tints owe their origin, it is not surprising that chemists have striven, from quite early days of the science, to elucidate the chemical structure of these colouring matters, and botanists to discover their relationship to the vital activities of plant life.

During recent years our knowledge concerning plant pigments has been rapidly and greatly enlarged, and observations have been made that are of great significance to chemist and botanist alike, whilst the horticultural possibilities which they seem to indicate should be of interest to even the most casual lover of Nature's beauties.

When referring to plant colouring matters it must be borne in mind that it is necessary to distinguish between the plastid pigments (chlorophyll, carotin, etc.) and the water-soluble sap-pigments. The present article will deal only with the latter group—sap-pigments—but it must not be imagined that this indicates that progress has not been made in the researches upon plastic pigments; indeed, much knowledge concerning them has resulted from the extended and intricate work of Willstätter and others.

The sap-pigments may be divided into two main classes: (i) Derivatives of flavone or of flavonol—sometimes called anthoxanthines—which are pale yellow or colourless when in faintly acid solution, but bright yellow when dissolved in alkalis; and (ii) the anthocyanins, which are red when in acid solution, violet to red-violet when neutral, and of varying tints from dull red, or red-brown, to purple and pure blue when in solution in the form of alkali salts. In both groups the individual pigments differ from each other in the amount of oxygen which they contain in the form of phenolic hydroxyl groups and the arrangement of these groups in the molecule.

We owe most of our knowledge of the distribution in Nature of the yellow sap-pigments—which usually occur in plant life in chemical combination with various sugars—to the work of A. G. Perkin, whilst the actual synthetic production of a number of these colouring matters by Kostanecki has confirmed our ideas concerning their chemical structure. How widely these pigments are distributed in Nature will be gathered from the fact that members of this group have been isolated from the following sources: Heather, wallflower, clover flowers, cotton flowers, delphinium flowers, onion skins, violas, poplar buds, parsley, etc. Although yellow sap-pigments derived from flavone have been isolated from a large number of plants and flowers, it is quite certain that pigments of this group are present in a very much larger number of plants than those from which they have up to the present been isolated.

When we turn to consider the pigments of the anthocyan class—the purples, reds, and blues of

plant life—the fact of their extremely wide distribution is obvious to everyone. Their presence in petals or leaves is noticeable even where only a small fraction of 1 per cent. of the pigment exists in the flower. That this is so will be fully realised when the fact is considered that the blue cornflower contains only about 0.75 per cent. of its dry weight of the blue pigment cyanin. In contrast with this is the case which has come to light in recent investigations, where as much as 25 per cent. of the flower's dry weight of a yellow sap-pigment was present in a yellow viola, yet this large quantity was completely masked by a mere fraction of 1 per cent. of a plastid carotin colour that was present in the same flower.

The great beauty of the anthocyan pigments has given rise to very numerous attempts to obtain an accurate knowledge of their chemical structure and also of their function in plant life. The name "anthocyan" dates back to 1835, and appears to have been introduced by Marquart. Despite the very numerous attempts that were made to isolate these pigments in a pure condition, it was not until 1903 that an anthocyan pigment (the colour of the pelargonium) was obtained in a crystalline condition by Griffiths. In 1913 Willstätter and Everest described their investigation of the pigment of the blue cornflower—which they called cyanin—and laid the foundation of the fuller investigation of the anthocyan pigments that has been developed since that date. It is to Willstätter, to his collaborators, and to Everest that we owe most of our knowledge of these pigments. The identity of a considerable number of the anthocyanins has now been established, and pigments of this group have been prepared synthetically. Among others, the colouring matters of the cornflower, rose, pelargonium, viola, peony, hollyhock, cherry, and grape have been obtained in a pure condition and investigated. In almost every case these pigments occur in Nature chemically combined with sugars.

As the result of these chemical investigations the relationship that exists between the yellow sap-pigments derived from flavone and the anthocyan colouring matters has been made clear. This relationship has been the subject of much study by botanists, particularly by Keeble, Armstrong and Jones, and Wheldale, and it is interesting to note that, whilst botanical work appeared to point to the anthocyan colours being oxidation products of the yellow sap-pigments of the flavone series, chemical investigations have proved that the relationship is the reverse of this—the anthocyanins are reduction products of the yellow sap-pigments.

Very interesting in connection with the function of these sap-pigments in plant life is the fact that, whilst chemical investigations have made it clear that the anthocyan pigments are reduction products of the yellow sap-pigments, botanical work strongly points to the conclusion that these very anthocyan pigments occur in plant life in positions that are the seat of oxidising influences.

It has been noticed by many who have investigated the anthocyan pigments that there is always at least a trace of yellow sap-pigment present alongside the red, purple, or blue of the anthocyan. From this has arisen the belief that the anthocyan is produced in Nature *via* the yellow sap-pigments, and recent work has shown that there is very considerable ground for thinking that this belief may prove to be correct.

To even the most uninitiated, the chemical formulæ representing a typical anthocyan [e.g. delphinidin (I.)] and the corresponding yellow sap-pigment [myricetin (II.)] make it obvious that a relationship exists between them—

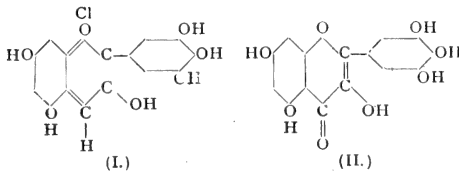

Naturally, to the horticulturist the interrelationship of the various sap-pigments to one another is of great interest; also the effect of these colours upon the tints produced by the plastid pigments that occur with them in plants and flowers. The proof, by chemical investigation, that the blue cornflower owes its colour to the same pigment as the red rose is of the greatest interest, for does it not raise hopes of success in the endeavour to produce a pure blue rose? In the rose the colour is red because the sap is acid, whereas the cell-sap in the cornflower is in such a condition that the pigment can take up enough alkali to form its blue alkali salt. Can the latter condition be reproduced in the rose?

It is often erroneously stated that the yellow sap-pigments are responsible for the yellow tints in flowers and berries, but in reality the bright yellows are almost exclusively due to plastid colours related to carotin, whilst the orange and brown tints are produced by combinations of these colours with those produced by pigments of the anthocyan group. In some few instances, however, it is probable that sap-pigments give rise to fairly strong yellows, but, in general, members of this class of compound produce pale yellow tints such as the colour of the primrose, or are present in an almost colourless condition in the acid cell-sap of white- or cream-coloured flowers. It is exceedingly difficult, even for one who has studied the pigments minutely, to be certain by mere observation which of the anthocyan pigments is present in any flower that may be examined. Chemical work has shown that plants of the same botanical group may produce different pigments, and, indeed, that more than one anthocyan, or yellow sap-pigment, may be present in the same flower.

Very naturally the clothing of Nature in such beautiful tints, as the result of the presence of these colours, led to the desire on the part of

man to use them for the colouring of garments and other textile materials. Many of the members of the yellow sap-pigments are capable of industrial use as mordant dyes, and were largely so used before the synthetic colours became available. Some of them—e.g. fustic—are still employed in considerable quantities even in European countries. In the East quite a number remain in use. Concerning the dyeing properties of the anthocyan pigments, much doubt seems to have existed, but it appears certain that in 1850-60 the colour of the hollyhock was largely used in Bavaria for dyeing purposes. Quite recently these colours have been more fully investigated in respect of their dyeing properties, and it has been found not only that they dye wool, but also that they are capable of giving very fine shades when used on cotton with a tanning mordant. Although they have considerable tinctorial power, and the dyeings produced by them are fast to light, they do not stand washing sufficiently to make it possible for them to hold their own against synthetic colours.

Apart from the two main groups of sap-pigments, with which the above remarks have been concerned, there are quite a considerable number of coloured compounds that exist in plants in some soluble form—usually as glucosides. It should be noted that, whilst flavone or flavonol derivatives are very widely distributed, and the anthocyan pigments almost equally so, the remaining colours are much more restricted in their distribution. What rôle the flavones, either alone or accompanied by anthocyan, play in plant life, other than that of decoration, has not yet been discovered. Wide distribution is no indication of commercial importance as regards plant colouring matters, and some colours that are by no means widely distributed are of considerable importance. Furthermore, the question of plant colouring matters does not end with the consideration of those colours that exist ready-formed in the plant. Indigo, the most important of all plant colouring matters, exists in plant life as a soluble, colourless glucoside called indican, which produces indigo only when it loses the sugar with which it is chemically combined, and is oxidised by contact with air or other oxidising medium. The archil or cudbear group constitutes another class of colours that were formerly of commercial importance, and are produced from soluble colourless products present in various lichens. In conclusion, the important dye alizarine should not be omitted; this product was formerly obtained exclusively from plant sources—chiefly madder-root, in which it occurs partly as the glucoside ruberythric acid—whereas almost all the alizarine that is now used is prepared synthetically from the coal-tar product anthracene. It would appear that the time is not far distant when all plant pigments that are used for technical purposes will be displaced by synthetic products, but the recent shortage of synthetic dyes has certainly somewhat prolonged the commercial life of the various natural colouring matters.



Geodetic Survey in North America.<sup>1</sup>

THE United States Coast and Geodetic Survey has long had in progress an arc of primary triangulation along the 98th meridian of longitude. This arc was completed to the north, up to the Canadian boundary, in 1907. To the south there is a similar arc along the same meridian through Mexico, originally surveyed by the "Commission Géodésique Mexicaine" between 1906 and 1910, terminating to the north at the international boundary on the Rio Grande and extending southward to the Pacific Ocean.

It was obviously desirable that these two arcs should be connected, and it was accordingly arranged to make the connection in 1913, when the last section of the work in the United States was done. The internal condition of Mexico, however, did not permit any joint operations at that time, and a postponement was necessary. Opportunity was taken of the improved condition of the country in 1915 to revive the question. The arrangements proceeded without hitch and the final observations were successfully made in May, 1916. The publication under review gives an account of the southern end of this arc in Texas, surveyed in 1913, the junction with the Mexican arc in 1916, and a general summary of the progress to date of the lines of first order triangulation in the United States.

Since 1901 the Coast and Geodetic Survey has reduced all its work to a common datum and computed all positions and azimuths upon Clarke's 1866 spheroid. These, both datum and spheroid, have been accepted, on one hand by the Canadian, and on the other by the Mexican, Geodetic Surveys, so that they are now common to the whole of North America. An inspection of the index map of the triangulation lines in the United States computed to these data shows, however, that there is still a considerable block of triangulation in the Eastern States not yet re-adjusted. When this readjustment is made and when certain lines in the Central and Western States, now in progress, have been completed, the network over the whole area will be so close that no point will be situated at a greater distance from a main triangulation line than about 170 miles. In fact, even this distance will be rarely attained, and over almost the whole area the maximum distance will be under 150 miles.

Such a network of absolutely first-class work is amply sufficient to satisfy the most exacting geodesist and is, of course, more than a sufficient basis for any possible map upon any practical scale. We may, therefore, congratulate the U.S. Coast and Geodetic Survey upon the now not distant completion of one of the main sections of its great task.

The execution of the small section of triangulation under review was marked by no special technical advances; but as exhibiting a high level of technical efficiency and as being of possible use for future guidance in similar work that may be planned in British territories, we may briefly advert to one or two practical points. One question of considerable importance is to decide whether it is desirable to restrict observations to the night or whether day observations should be included. The U.S. Survey adopts the principle of allowing only night observations, for the stated reason that experience has shown that there is less deviation in the geodetic azimuths of the lines when this restriction is enforced than when the observing is done by day or is a combination of day and night work. In other words, the atmospheric conditions are more stable at night and observations of angles, therefore, more accurate. This is in accordance with general experience and practice. It has, however, been argued, not without a certain show of plausibility, that though undoubtedly the apparent errors are thus reduced, this may be at the risk of introducing systematic errors, due, let us say, to unsymmetrical atmospheric refraction operating only when observations are made upon a falling temperature, which might be eliminated if observations under different atmospheric conditions were combined. Though plausible, this argument is, we think, not tenable, or, perhaps more correctly, not applicable to the case of a triangulation.

The ultimate test as to whether, in deriving the most probable mean of any set of observations, systematic errors are likely to be diminished by the inclusion of observations of an inferior degree of accuracy but differing in their conditions can be decided only by experience. Now in this case the "experience" is immediately available, being, in fact, implicitly contained in the figure expressing the closing error of the triangle. Any method of observation and any system of combining the results of the observations into a mean value which reduce this closing error *ipso facto* increase the probable accuracy of the finally derived figures of position and azimuth. Night observations, preferably between, say, three hours after sunset and one hour before sunrise, fulfil this condition and are therefore rightly accepted as ideal.

The U.S. Survey, operating over a huge area with a necessarily limited budget, has perforce to pay attention to the question of cost. Survey is, in fact, on exactly the same basis as other engineering operations. The problem is to get the maximum output of work of a strictly defined and practicable degree of precision at the minimum cost, and not, as has sometimes been assumed, to reach the highest attainable precision regardless of cost.

The standard for first order work in the United States is an average triangular error of one second of arc and a maximum error of under three

<sup>1</sup> Department of Commerce, U.S. Coast and Geodetic Survey. Geodesy. Serial No. 97. Report on the Connection of the Arcs of Primary Triangulation along the Ninety-eighth Meridian in the United States and in Mexico, and on Triangulation in Southern Texas. By William Rowie. (Special Publication No. 51.) Pp. 93. (Washington: Government Printing Office, 1919.) Price 10 cents.

seconds. This already high degree of precision was, however, surpassed in the particular section under notice. Thus over a total of sixty-eight triangles the average closing error was  $0.63''$  and the maximum error of any one triangle  $1.86''$ . This pitch of excellence was moreover attained without any increase of time spent at the stations; indeed, it is claimed, we think with justice, that the arc establishes a "record," both technically and financially. The average cost per point occupied was, in fact, lower than has been attained with any previous work of the same class, and as, owing to the nature of the country, high and expensive signal scaffolds were necessary, it seems that the reduction made in the cost of the actual observing was even more notable than appears on first inspection.

This conveys a lesson which may be taken to heart by those responsible for future survey operations. It seems clear that the difference in method of execution between what we are accustomed to call first order or primary triangulation (*i.e.* triangular error under  $1''$ ) and secondary work (triangular error under  $3''$ ) lies mainly in the nature of the signals. If lamps only are used it is a matter of indifference as regards rate of progress,

and hence as regards cost, whether a large instrument capable of first order precision or a smaller one capable only of second order is used. In either case one observer can complete the observations at a station in one night, and no reduction in size of instrument, in number of rounds taken, or in order of accuracy will enable him to do more. The difference in cost of transport between the two instruments is in most cases negligible. The only extra cost involved is that caused by the necessity of providing five lampmen or lamp parties and moving them from point to point. In rough country this might undoubtedly prove a formidable addition, but in the case of future boundary commissions or land surveys in Africa it is anyhow worth serious consideration whether a backbone or net of primary triangulation, planned so as to fit in with a comprehensive geodetic scheme, cannot be undertaken without a prohibitive increase in expenditure.

This is the sort of question for which the coordinated experience and authority of a geodetic institute would prove invaluable, and it is to be hoped that it will not be long before such an institution, long overdue, is established in England for the British Empire. E. H. H.

### Science and Research in the Air Service.

THE Air Estimates for the year 1920-21, recently presented to Parliament, show a total estimated expenditure of 21 million pounds compared with 54 million pounds in the previous year. The apparent saving in cost is 33 millions, but it is really greater, for in the year 1919-20 the cost of the experimental and research services was borne jointly by the Admiralty and the Ministry of Munitions, and is now wholly included in the Air Ministry vote.

As regards the Royal Air Force, the number of officers, warrant officers, non-commissioned officers, airmen, and boys provided on the establishment (exclusive of those serving in India) has fallen from 150,000 in 1919-20 to rather less than 30,000 in 1920-21—a striking reduction. The 21 million pounds for the new financial year includes rather under a million for civil aviation and two and a half millions for experiment and research. This latter sum would have been more than three millions (3,177,000*l.*) had not an "appropriation in aid," due to the sale of certain airships for 600,000*l.*, come to the relief of the vote. The actual figures are as follows:—

	£
Liquidation of war liabilities ... ..	1,334,000
Works, buildings, and lands ... ..	140,000
Aeronautical inspection ... ..	80,300
Airship constructional establishment ...	315,000
R.A.E., Farnborough ... ..	401,200
Technical equipment and materials ...	844,300
Salaries and wages ... ..	48,800
Miscellaneous ... ..	13,850
	3,177,540

An expenditure of more than three millions for research alone in a single year would appear to be a generous provision, but an examination of the foregoing figures shows that much of the expenditure will not be employed for this purpose.

The air vote for meteorological services has risen from 12,000*l.* in 1919-20 to 77,629*l.* in 1920-21, and part of this will doubtless be used in research work of some kind, though these services are not part of the research directorate, but come under the civil aviation side of the Air Ministry. The sum of 77,629*l.* includes the provision of only 358*l.* for "experimental stations," which is such a very modest amount that we assume experimental research in meteorology is provided for by other aid. In any event, the amount cannot represent the degree to which attention is given to research, since in meteorology there is ample scope for original work based upon the observations from what may be termed routine stations.

The printed Estimates convey the intention of the Government to make liberal provision for research in aeronautics, but it is impossible to determine precisely what sum of money is thereby devoted solely to "experiment and research," since such work is sometimes carried on at the ordinary air stations. Moreover, 40,000*l.* for the National Physical Laboratory is not borne on the Air Estimates at all, but on those for the Civil Service. The Estimates do, however, include the sum of 20,340*l.* for research "grants to scientific bodies," and 600,000*l.* as an encouragement to invention.

## Obituary.

MR. SEDLEY TAYLOR.

THE long life of Mr. Sedley Taylor, who died recently at the age of eighty-five years, nearly all of which were spent in public activities at Cambridge, was in many ways notable. Theology, mathematics, physical science, practical economics, and pre-eminently music, occupied his attention. His withdrawal from active theological pursuits (in 1863 he was ordained to a curacy near Birmingham) was not merely a personal event; it was also linked up with the movement for greater academic freedom at Cambridge. About the same time Henry Sidgwick (1869) and Leslie Stephen (1862) gave up their fellowships. So early as 1862 appeared the first edition of Helmholtz's classical treatise on the sensations of tone. A translation into English, published by A. J. Ellis in 1875, increased its reaction in this country both on the physical theory of sound and on the æsthetic principles of music, which it for the first time brought into detailed, reasoned connection. Its influence was much forwarded by Sedley Taylor's book, "Sound and Music," which appeared in 1873, and was the earliest general exposition in short compass by a writer competent on both sides of the subject. An event which his characteristic energy rendered prominent was his invention of an apparatus which he named the phoneidoscope. It consisted essentially of a resonant cavity, with an aperture over which a soap-film was stretched: when the operator sang to it a note nearly in unison with the cavity, the aerial vibrations revealed themselves visibly in whirling movement of the coloured striations of the liquid film.

In these days perhaps such phenomena, now more fully understood, would be regarded as bearing more closely on the properties of the very remarkable structure exhibited by bubbles, being too complex to reveal direct knowledge of the constitution of sound waves.<sup>1</sup> But Sedley Taylor's enthusiasm was infectious. As a testimony to his zeal in connecting up music with acoustics, and also to the relevant state of things in Cambridge at this period, an extract from Clerk Maxwell's Rede Lecture of 1878 on the telephone (then newly discovered) is worth quoting:—

Helmholtz, by a series of daring strides, has effected a passage for himself over that untrodden wild between acoustics and music—that Serbonian bog where whole armies of scientific musicians and musical men of science have sunk without filling it up.

We may not be able even yet to plant our feet in his tracks and follow him right across—that would require the seven-league boots of the German Colossus; but to help us in Cambridge we have the Board of Musical Studies vindicating for music its ancient place in a liberal education. On the physical side we have Lord Rayleigh laying our foundation deep and strong in "Theory of Sound." On the æsthetic side we have the University Musical Society

doing the practical work, and, in the space between, those conferences of Mr. Sedley Taylor, where the wail of the Siren draws musician and mathematician together down into the depths of their sensational being, and where the gorgeous hues of the Phoneidoscope are seen to seethe and twine and coil like the

"Dragon boughts and elvish emblemings"

on the gates of that city where

"An ye heard a music, like enow

They are building still, seeing the city is built

To music, therefore never built at all

And therefore built for ever."

The special educational value of this combined study of music and acoustics is that, more than almost any other study, it involves a continual appeal to what we must observe for ourselves.

The facts are things which must be felt; they cannot be learned from any description of them.

The economic side of Sedley Taylor's work can be illustrated by a conversation with a younger friend of his who was accustomed to see him in his rooms in Trinity College during his last years of feeble health. The talk turned upon profit-sharing, which was introduced by a question about a French statuette on the mantelpiece. To his surprise the younger man, who had to probe for his information, found that Sedley Taylor had been a pioneer, had even been the inventor of that term, and had written a book on the subject, for which he had been decorated for his services towards industrial co-partnership by the French Government, which was at the time closely interested in such matters.

Sedley Taylor was a pioneer in at least two other directions. One of them was the higher education of women. He promoted the foundation of Girton College, and was afterwards its constant benefactor. Towards the end of his life, in 1911, he received the honour of the freedom of the borough of Cambridge for establishing and endowing the first dental clinic that was founded in England. His musical activities pervaded Cambridge, and are too widespread to be discussed here. His generosity, kindness, and humour endeared him to a wide circle, and in particular to many generations of musical undergraduates. CYRIL ROTHAM.

WE regret to note that the death of Mr. ANTHONY GEORGE LYSTER is announced in *Engineering* for March 19 as having taken place on March 17 at sixty-eight years of age. Mr. Anthony Lyster was the second son of Mr. G. F. Lyster, of Liverpool, and father and son between them were responsible for the greater part of the port developments on the Mersey over a period exceeding fifty years. Mr. Lyster was educated at Harrow, and served his pupilage under his father. After holding the position of assistant engineer to the Mersey Dock Board for some time, during which he was responsible for the

<sup>1</sup> The writer is indebted to Sir Joseph Larmor for assistance on this subject.

construction of important new works, he succeeded to the position of acting engineer-in-chief, and became engineer-in-chief in 1898. He resigned this post in 1913, and then became a partner in the firm of Sir J. Wolfe Barry and Partners, but remained consulting engineer to the Mersey Dock Board until the time of his death. Mr. Lyster became a member of the Institution of Civil Engineers in 1882, and was president in 1914. He served as a member of the International Technical Commission for the Suez Canal, and was consulted with regard to improvements of the harbours at New York, Bombay, Port Elizabeth, Shanghai, etc. He was also a member of the Admiralty Committee on Naval Works at Doon and Rosyth, and associate professor of engineering at Liverpool University.

By the death of MR. W. A. E. USSHER, which occurred on March 19, many British geologists will lose an old friend who, whether in his usual mood of breezy optimism, or in a rarer phase of boisterous pessimism, was always good company. Mr. Ussher joined the Geological Survey in 1868 and was engaged in the mapping of various parts of England, but his name will always be associated with the Devonian, Carboniferous, and New Red rocks of Devon, Cornwall, and Somerset, where he spent most of his official career. His principal contributions to the literature of these formations appear in the Memoirs of the Geological Survey, in the Journal of the Geological Society, and in the Transactions of the Devonshire Association. In his study of the West Country rocks it was his constant endeavour to secure correlation with their European equivalents, and thus he was brought into close association with many Continental geologists of note. In 1914 he was awarded the Murchison medal of the Geological Society in recognition of his labours. Mr. Ussher retired from the Survey in 1909; unfortunately, ill-health since then kept him in almost complete retirement.

By the comparatively early death of DR. R. C. MACLAURIN on January 15 last, the United States have lost an accomplished and energetic immigrant. Dr. MacLaurin was born at Lindean, Scotland, in 1870, and in 1897 was placed in the first division of the first class of the advanced part of the Mathematical Tripos. It was an unusually good year, the candidates including Grace and Bromwich. Dr. MacLaurin was also equal for the second Smith's prize. After graduating, he at first turned his attention to law, but before very long became professor of mathematics in the University of New Zealand. This post he left in 1907 to occupy the chair of mathematical physics at Columbia, N.Y., and two years later became president of the Massachusetts Institute of Technology. He published one legal treatise, and two on the theory of light; besides this, he contributed various papers to the Philosophical Transactions and other periodicals.

## Notes.

A LIST of 5604 promotions in and appointments to the Civil Division of the Order of the British Empire "for services in connection with the war" was published on March 30 as a supplement to the *London Gazette*. We notice the following names of men of science and other workers known in scientific circles:—*Knight Grand Cross (G.B.E.)*: Dr. A. E. Shipley, F.R.S., Vice-Chancellor of Cambridge University. *Knights Commanders (K.B.E.)*: Prof. I. Bayley Balfour, F.R.S., University of Edinburgh; Prof. W. H. Bragg, F.R.S., University College, London; Dr. S. F. Harmer, F.R.S., Director of Natural History Departments, and Keeper of Zoology, British Museum; and Dr. J. E. Petavel, F.R.S., Director of the National Physical Laboratory. *Commanders (C.B.E.)*: Prof. H. L. Callendar, F.R.S., Imperial College of Science, London; Dr. C. C. Carpenter, chairman, South Metropolitan Gas Co.; Mr. F. H. Carr, Chief Chemist, Messrs. Boots Pure Drug Stores; Prof. F. G. Donnan, F.R.S., University College, London; Mr. W. P. Elderton; Mr. A. P. M. Fleming; Prof. P. F. Frankland, F.R.S., University of Birmingham; Dr. F. W. Edridge-Green; Prof. W. A. Herdman, F.R.S., University of Liverpool; Prof. J. C. Irvine, F.R.S., University of St. Andrews; Mr. J. G. Lawn; Prof. T. M. Lowry, F.R.S.; Mr. W. Macnab; Dr. R. A. O'Brien, Director, Wellcome Physiological Research Laboratories; Mr. J. E. Sears, National Physical Laboratory; Mr. F. J. Selby, National Physical Laboratory; Dr. T. E. Stanton, F.R.S., National Physical Laboratory; Mr. G. Stubbs, Government Laboratory; Lieut. J. R. F. Wild, member of Sir E. Shackleton's Antarctic Expedition; and Dr. Dawson Williams, editor, *British Medical Journal*.

THE impending retirement of Sir Napier Shaw, who has been the Director of the Meteorological Office since 1905, and as president of the International Meteorological Committee occupies a unique position, marks an epoch in the history of British meteorology. Trained primarily as a physicist, Sir Napier has been able to approach meteorological problems in a scientific spirit. His academic experience brought him into contact with younger men, and by the encouragement he extended to them he raised the level of his subject. As a consequence, there are at the present moment a greater number of men in the British Empire capable of dealing with intricate meteorological problems than in any other part of the world. A heavy responsibility rests on the authorities on whom the duty of nominating Sir Napier's successor falls. When the Meteorological Office was taken over by the Air Ministry last year the change was looked upon with grave misgivings. The near future will show whether the anxiety then felt regarding the wisdom of a step that was taken against the advice of all competent authorities is to be relieved or intensified. It would be an irretrievable calamity if administrative rather than scientific qualifications were to determine the choice. Unless the whole future of British meteorology is to be

jeopardised, the Director of the Office must be a man of high scientific standing who will maintain the leading place which the Office now takes among the nations of the world. For the credit of the nation and in the interests of science we trust that the new Director will be a worthy successor of the one who has given so much scientific honour to the post.

MR. C. E. GROVES, F.R.S., for some years lecturer in chemistry at Guy's Hospital, consulting chemist to the Conservators of the River Thames, and vice-president of the Chemical Society from 1899-1902, who died on February 1, left estate of the gross value of 33,022*l.*, of which amount 20,000*l.* is left in trust for his five sisters for life, and on the death of the survivor of them 10,000*l.* to the Royal Institution for the Groves Endowment Fund for the promotion of scientific research.

Two scholarships, each of the annual value of 300*l.*, are being offered by the Grocers' Company, the object being the promotion of original research in sanitary science. In addition to the sum named, there will be an allowance to meet the cost of apparatus and other expenses in connection with the work. The scholarships will be tenable for one year, but may be extended for a second or third year under certain conditions. The elections will take place in June next, and applications have to be made, on a special form provided, before May 1 to the Clerk of the Grocers' Company, Grocers' Hall, Princes Street, E.C.2.

IN spite of the fact that no regulations have been issued concerning standard time in Finland, Helsingfors time (1*h.* 40*m.* fast on Greenwich time) has been almost generally adopted in the country. The inconvenience of following a time which differs from the international zone system based upon Greenwich time was the principal cause of a proposal, made last autumn by the Geographical Society of Finland, to fix Greenwich time +2*h.* as the standard time of the Republic. A correspondent, "H. R.," informs us that on March 12 the President arrived at a decision in accordance with this proposal. The new standard time of Finland will be adopted by the railways from May 1, 1921, and the calendars for 1921 will introduce it from the beginning of the year. The question of adopting the twenty-four-hour day is under discussion.

THE Works Council Bill has now passed into law in Germany. It provides for the formation of a works council in every works having at least twenty employees (operatives and office staff). Representation then proceeds *pro rata* up to a works employing any number. All male and female workers from the age of eighteen who are in possession of citizen rights are entitled to vote. Among the various provisions of the Act mention may be made of the obligation of the councils in assisting the management by advice with the view of obtaining the greatest economy in carrying out manufacturing operations. They must also co-operate in the application of new methods and in preventing disputes, and assist in the welfare work, etc. These provisions presuppose considerable technical and industrial knowledge on the part of the

members of the council—which, it may be added, must not exceed thirty in any one establishment.

At the annual general meeting of the Chemical Society, held at Burlington House on March 25, the following were elected officers and council for the ensuing year:—*President*: Sir James J. Dobbie. *Vice-Presidents*: Prof. J. B. Cohen, Prof. F. G. Donnan, Dr. H. J. H. Fenton, Prof. S. Smiles, Prof. J. Walker, and Prof. W. P. Wynne. *Treasurer*: Dr. M. O. Forster. *Secretaries*: Dr. J. C. Philip and Dr. H. R. Le Sueur. *Foreign Secretary*: Dr. A. W. Crossley. *Ordinary Members of Council*: Prof. A. J. Allmand, Dr. E. F. Armstrong, Julian L. Baker, Francis H. Carr, Prof. A. Findlay, Prof. F. E. Francis, J. A. Gardner, Prof. J. C. Irvine, Dr. C. A. Keane, Sir Robert Robertson, Prof. J. M. Thomson, and E. W. Voelcker. It was announced that, the supplementary charter now having been granted, an extraordinary general meeting of the fellows would be held at Burlington House on April 29 at 5 p.m. to consider the alterations in the by-laws proposed by the council.

WE have on several recent occasions referred to the advances which were made during the war in wireless telephony to and from aeroplanes. There is also another important use to which electric waves have been put in connection with aerial navigation, in the wireless direction-finding apparatus, which has likewise been brought to a considerable degree of perfection. An interesting demonstration of both these applications was given under the auspices of the Marconi Co. on a Hardley Page machine on March 25, when conversations were held with the Marconi establishment at Chelmsford, and messages were picked up and transmitted to the *Times* office in London. The direction-finding apparatus, which was also demonstrated, is apparently a development of the "wireless compass" used at sea, founded on the radio-goniometer of Bellini and Tosi, in which the angular relation of two coils connected respectively to two independent aerial systems at right angles is varied. By rotating a pointer carrying one of these coils a position is found where the signals received reach a maximum loudness and the direction of the incoming waves is ascertained. By plotting cross-bearings of two stations obtained in this way on a chart, the true position can be found. The Marconi form of the apparatus has a working range of 200 to 300 miles when used in conjunction with low-power coast wireless stations. The converse process was used during the war for finding the position of enemy craft from more than one home station, and it is well known that the Zeppelins used a wireless position-finder extensively for navigation during raids. The principle on which this worked is, however, believed to have been somewhat different.

THE report of the Royal Commission on Decimal Coinage has just been issued. The majority report, which represents the views of about two-thirds of the members of the Commission, is not in favour of making any change in the denomination of the currency and money of account in order to place them

on a decimal basis. It maintains that this decision is justified by the following considerations:—(1) In any scheme for reducing the existing system to a decimal basis the pound should be retained. (2) The pound and mil scheme is the only strongly supported scheme which complies with this condition. (3) The advantage to be gained by a change to the pound and mil scheme as regards keeping accounts is in no way commensurate with the loss of the convenience of the existing system for other purposes. (4) Grave difficulties will be created by any alteration of the penny. (5) The scheme cannot be tried as an experiment or on a voluntary basis. There are two minority reports in favour respectively of the decimalisation proposals of Lord Southwark and Lord Leverhulme. The investigation makes it clear that many of the difficulties now regarded as insuperable would disappear if our system of weights and measures were such as to familiarise the general body of the community with decimal calculation. This fact will, no doubt, stimulate the advocates of the metric system to renewed efforts to bring about this useful and necessary reform.

DR. R. C. SMITH states in the *Scientific Monthly* for February that there is in the popular mind a surprisingly large amount of misinformation and misconception concerning many forms of natural history, and this is not confined to exotic, but extends to well-known plants and animals. As instances he quotes the belief that the beaver uses its tail like a trowel; that the porcupine shoots its quills at enemies; that certain squirrels and fish fly; that snakes swallow their young in times of danger; that cats suck the breath of babies, and so on. The prevalence of these beliefs is due largely to the fact that a considerable portion of the people do little or no reading, or it is confined to trashy literature. These misconceptions are due to various causes—to hasty acceptance of the opinions of others, to mistaken observation and misinterpretation of the facts involved, but mostly to the fertility of imagination. All this points to the necessity of serious and efficient Nature-teaching in schools, by the agency of which misinformation about well-known objects of natural history can be corrected.

WE congratulate the Hunterian Museum at Glasgow University on its year's record of steady progress. In the Reports on the Hunterian Collections for the Year 1918-19 just received we note especially the growth of the collections of insects of economic and sanitary importance, through the enthusiastic work of Mr. R. A. Staig. The long list of acquisitions in this department bears witness both to Mr. Staig's energy and to the admirable lines upon which he is developing the collection. The geological collections have received a valuable acquisition through the purchase of the balance of the important Leeds collections of fossil reptiles and fishes from the Oxford Clay. The honorary curator of the coin cabinet reports that the resumption of international communication has been responsible for a considerable increase in the number of requests for casts from workers abroad, and the list of consignments dispatched is eloquent at once of the world-wide fame

of this museum and of what the war has meant to research workers at home and abroad.

AMONG early palæolithic flint implements found in the river gravels of the South of England there are certain specimens with the point slightly turned to one side. These are regarded as intermediate between the still older rostro-carinate flints and the ordinary palæoliths by Mr. J. Reid Moir, who describes several examples in detail and discusses them in a recently published part of the *Philosophical Transactions* (vol. ccix., B, pp. 329-50, pls. 51-57). According to this explanation, the makers of the rostro-carinate implements eventually began to increase the efficiency of their tools by extending the ridge of the beak progressively further towards the butt end, while they chipped the edges of the great flat face until it also became a longitudinal ridge similarly extended. The rostro-carinate implement, triangular in cross-section, thus passed into the palæolithic implement of the "river-drift type," rhombic in cross-section; the two opposite flat faces of the former having been chipped away, and the two opposed great surfaces of the latter being in planes at right angles to them. As the cross-section of a rostro-carinate resembles that of a dog-fish, while the cross-section of an ordinary palæolith corresponds with that of a plaice, Sir Ray Lankester suggests that the latter should be described as *platessiform*. Other early palæoliths in which one face is flat may have originated from the rostro-carinate type simply by the extension of the ridge of the beak and the simultaneous thinning of the flint, thus resulting in a skate-like or batiform shape.

In the *Philippine Journal of Science* (vol. xiv., No. 4) Mr. E. D. Merrill continues his work on new or noteworthy Philippine plants. The present contribution contains descriptions of one hundred new or presumably new species, and eighteen new records for the islands. Of the nine genera which are for the first time recorded as Philippine, two are of special interest from the point of view of geographical distribution. One, *Cloezia*, a genus of Myrtaceæ, has hitherto been known only from New Caledonia, where it is represented by six species. The discovery of a representative in Mindanao, in forest at an altitude of 1700 metres, adds another genus to the remarkable list of genera that are known only from the Philippines and the islands to the south and south-east of the archipelago. The second, *Citriobalus*, is a small Australian genus of Pittosporæ, with one species from Java, the range of which is now extended to Luzon. Another Australian species, *Ipomoea polymorpha*, previously known only from Australia and Formosa, has also been found in Luzon.

ABSTRACTS of scientific papers, when giving full bibliographical details and fully indexed, are evidently of greater utility than mere catalogues. An excellent series of abstracts has for many years been prepared by the Chemical Society, and *Science Abstracts*, issued by the Institution of Electrical Engineers and the Physical Society, is a well-known publication. The abridgments of the Patent Office point to the use of abstracts for purposes of search. Within the last

few years the question of abstracting and cataloguing scientific literature has been much discussed, and has become acute. The Mineralogical Society has, on its own initiative, made a start in this direction, and has recently issued the first number of a series of *Mineralogical Abstracts*. This will give notices of papers and books dealing with purely scientific mineralogy and crystallography, and will also direct attention to matters of mineralogical interest in original papers bearing more on petrology, ore-deposits, and economics. The work of abstracting is being carried on by voluntary helpers, but even with this help it is evident that the cost of printing will be more than a small society can bear. It is hoped, if this venture proves to be of some general use, that it may lead to an increased membership of the society.

Much attention has been given in recent years to the question of manufacturing alcohol within the Empire for use as motor spirit. In the current number of the Bulletin of the Imperial Institute the possibility of utilising the mowra flowers of India for the purpose is discussed. These flowers possess thick, juicy petals rich in sugar. They are used by the natives as a foodstuff, and especially for the preparation by fermentation of an alcoholic liquor called daru or mohwa spirit. A single tree will yield as much as 200-300 lb. of flowers in a year. The tree also produces a valuable oil-seed, which is exported in fairly large quantities to Europe. During the war the flowers were used in India for the production of acetone, the yield being said to be ten times as much as that obtained by distilling wood, which is the usual source of this substance. The demand for acetone in India in peace times, however, is not great, and large quantities of the flowers would be available for the manufacture of alcohol, and would appear to be an exceptionally cheap source of this material, as the yield is high compared with that from potatoes and other materials commonly used, about 90 gallons of 95 per cent. alcohol being obtainable from one ton of dried flowers. It has been estimated that in the Hyderabad State alone there are already sufficient mowra-trees for the production of 700,000 gallons of proof spirit per annum, in addition to that necessary for the local liquor requirements.

In the Weekly Service for February 21, issued by the Ministry of Agriculture and Fisheries, there appears some interesting information on the prospective yields of cereals for the season 1919-20. From this information, obtained from the International Agricultural Institute of Rome, it seems that the world is faced with a considerable reduction in its wheat supply. In Australia the yield of wheat for 1919-20 is estimated at 54.4 per cent. of the previous year's production, and this is only 38.3 per cent. of the average of the five preceding years. Similarly, the estimated wheat yield is much lower than last year's average in the Union of South Africa, the United States of America, Rumania, and Argentina. Before the war the average exports of wheat from Russia and India were together equal to the quantity imported into the United Kingdom from all sources,

but it will be some time before India can recover from the famine conditions of 1919, while it is highly probable that Russia will not rank as a wheat-exporting country for the next few years. There is, therefore, a vital need for an increased wheat production in the United Kingdom. Not only for this reason, but also because the scheme is thoroughly sound from the practical point of view, the Ministry advises the sowing of spring wheat, and gives practical advice as to varieties, soils, etc.

The Journal of the Royal Statistical Society for January contains an interesting summary of the growth of Canada (1867-1917), "Fifty Years of Canadian Progress," by Mr. Ernest H. Godfrey, of the Dominion Bureau of Statistics, Ottawa. While Prince Edward Island and the North-West Territories show an absolute decline in population in the period 1871-1911, the total population was nearly doubled, and that of Manitoba increased from 25,228 to 455,614. More than a third of a million immigrants entered Canada in each of the three years 1912-13-14. The acreage and yield of wheat were more than doubled in the decade 1900-10, those of oats increased by two-thirds, and these rates of development were maintained until 1917. In 1870 Ontario produced 85 per cent. of the wheat, 82 per cent. of the barley, and 52 per cent. of the oats of the Dominion; since 1900 the main farm crops have been obtained further west, Saskatchewan producing in 1917 56 per cent. of the wheat, 28 per cent. of the barley, and 34 per cent. of the oats. While the numbers of sheep have steadily declined (1871-1911), those of horses have doubled and of cattle have increased by 50 per cent. Canadian cheese factories produced annually from 1½ to nearly 2 million cwt. (1893-1917), nearly all of which was exported to the United Kingdom. In 1867 there were 2288 miles of railway line; in 1881, 7331; and in 1917, 38,604. The mineral census of 1911 was of so different a character from those of earlier years that it is not possible to quote details of the progress in mineral wealth. The paper is worthy of close attention by all who are interested in Canada.

GEOGRAPHERS are not likely to overlook the continuous exploration and illustration of Alaska by the officers of the United States Geological Survey, further evidence of which is seen in Bulletins 683 and 687, dated 1918 and 1919 respectively. The former contains a number of new maps, where much still remains a blank, of country stretching in from the coast north and west of the Lower Yukon River. The latter provides excellent photographic views, notably plates v. and vii., of the Kantishna region, north of Mount McKinley, where the only population consists of some forty whites engaged in mining.

It is a pleasure in these times to handle and read so well printed a report as that which inaugurates the "Scientific Survey of Porto Rico and the Virgin Islands" (vol. i., part 1, issued by the New York Academy of Sciences, 1919). The origin of the survey of this outpost-island of the United States is given by Mr. N. L. Britton, and Mr. C. P. Berkey furnishes an introduction to the general geology. The

rocks of Porto Rico divide themselves into an older series, mainly volcanic, which is regarded as Cretaceous or a little earlier, and a sedimentary Cainozoic group, determined by marine fossils to be of Eocene, Oligocene, and Miocene age, Oligocene beds largely predominating. Though it is not mentioned on the cover of the part, a good map of the island, by Messrs. Reeds and Briesemeister, faces p. 30. The scale is 1:950,400, and red contours are sketched at 100 ft., 500 ft., 1000 ft., and 1500 ft. In his detailed account of the geology of the San Juan district Mr. Douglas R. Semmes describes the very interesting and very annoying topography of the Tertiary limestone belt, where "pepinos"—we prefer this term, meaning "cucumbers," to Mr. Berkey's "haystack hills" adopted in the paper—give rise to a remarkably broken country. This topography is due to the irregular falling-in of waterways in the Cainozoic limestone, complicated by the occurrence of beds of shale. In the petrographic section we welcome the appearance of Vogelsang's term "vitrophyre"; but the German spelling that is retained, even in a plural, which is written "vitrophyrs," makes us fear that this useful word is here limited as Rosenbusch desired.

AERIAL navigation has become of such vast importance that any aid which meteorology can afford is welcomed, while, on the other hand, the meteorologist looks with much expectation to the airman for observations which may advance our knowledge of the general movements of the atmosphere. The Meteorological Office has just issued "An Analysis of Cloud Distribution at Aberdeen during the Years 1916-18" (Professional Notes No. 9, price 4d. net). The analysis is by Mr. G. A. Clarke, assistant at Aberdeen Observatory. It is practically a first effort at averaging the number of days in each month on which certain cloud characteristics are predominant, and from this deducing by the estimated average height of the cloud the occasions when air was cloud-free below certain heights. The number of occasions upon which flying would have been handicapped on account of the lowness of the cloud is 31 per cent. of the total, and of the remainder rather more than one-third show no cloud below 7000 ft. The weakness of the analysis is that the cloud-heights have been worked on average results deduced from altogether different observations. It is recognised by meteorologists not only that the heights of clouds may vary at different stations, but also that they are subject to diurnal and seasonal variations.

In a paper on operating a by-product producer-gas plant for power and heating, read recently at the Institution of Electrical Engineers, Mr. W. H. Patchell gives particulars of the running of a plant belonging to the Hoffmann Manufacturing Co., Ltd. The gas plant is on the Lymn system, and the power units consist of four-cylinder horizontal Premier engines of about 500 brake-horse-power at 190 revs. per min. Each gas engine is fitted with an exhaust boiler, and the boilers were installed with water-heaters. The dynamos were supplied by Messrs. Crompton, and are open type direct-current shunt-wound interpole 360-kw. machines running at 190 revs. per min.; the

first two machines work at 110 volts, and in the second instalment of plant, machines working at 220 volts are used. The figures obtained for a period of six months' running show a consumption of 1.51 lb. of coal per kw.-hour, and a thermal efficiency of 19.9 per cent. on the units delivered to the feeders. The best figure quoted by Mr. David Wilson (Technical Adviser to the Controller of Coal Mines) for electric power stations in the South of England is a consumption of 2.32 lb. of coal per unit and a thermal efficiency of 13.05 per cent. The best station in the Northumberland district gave 1.80 lb. of coal per unit and a thermal efficiency of 18 per cent. Mr. Patchell considers that the large-cylinder high-power gas engine will be developed in this country as it has been abroad—an opinion in which he appears to differ from some other gas-engine authorities.

A PAPER read to the North-East Coast Institution of Engineers and Shipbuilders on March 19 by Dr. W. H. Hatfield, of the Brown-Firth Laboratories, and Mr. H. M. Duncan, of Messrs. C. A. Parsons and Co.'s Research Laboratory, deals with the mechanical properties of turbine steels. Unfortunately, the authors were unable to obtain specimens of turbine steel which had done good service in severely stressed parts, and a standard with which they could compare other steels was therefore lacking, but the conclusion is reached that design has probably more to do with the life of turbine parts than the quality of the steel. One disc which failed in practice, however, proved to be weak when tested in a radial direction, and the defects of structure are illustrated by means of photomicrographs. The paper contains a number of tests by different methods, the conclusions as to the relative value of impact, bending, hardness, and tensile tests being, in the main, the same as those reached by Dr. Hatfield in his paper read before the Institution of Mechanical Engineers. An investigation of the Sankey test is included, the relation between the length, diameter, and resistance of the test piece being examined. A formula is given which yields a rough approximation to the values which would be obtained under standard conditions. Formulæ are also given for the Stanton repeated impact test, and the data collected should be of interest to engineers who are concerned with testing.

SOME interesting particulars regarding the use of mechanical reduction gears between the turbines and the propeller in the Royal Navy were given in a paper read at the recent meeting of the Institution of Naval Architects by Eng.-Comdr. H. B. Tostevin. By 1916 it was considered that enough progress had been made to warrant a complete change-over to this type of driving, and at present there are installed or on order 612 sets of gears of a total horse-power of 7,828,000. The largest set transmits 36,000 shaft-horse-power, and there are four sets on this ship, totalling 144,000 h.p. In all naval work the turbine spindles, pinions, and gear-wheels are supported on rigid bearings, and the alignment is determined by accurate machine work in boring the gear housings and fitting the bearings. In general, a gearing ratio



of 8 or 9 to 1 is not exceeded in naval practice of moderate and high power. Of the 556 sets in service, some extending up to nearly six years, it has only been necessary to remove three for refit due to misalignment; no actual breakdown occurred, and the gears, after dressing up, were afterwards re-utilised. Two cases of fractured teeth occurred; the broken or cracked portions were removed and the damaged teeth were smoothed up. There is a great saving in the blading of the turbine by the adoption of mechanical gearing, amounting in the case of a destroyer to 70,000 ft. of blading in a direct drive, against 7720 ft. in the geared drive. The increase in efficiency is 16.1, 17, and 20 per cent. respectively for light cruisers, flotilla leaders, and torpedo-boat destroyers at full power; at one-fifth power the increases in efficiency are 16.5, 20, and 20 per cent. respectively.

MESSRS. THOMAS MURBY AND CO. are publishing shortly two books likely to interest geological readers, viz. "An Introduction to Palæontology," by Dr. A. Morley Davies, and "Petrographic Methods and Calculations," by Dr. A. Holmes. In the first-named work the "type-system" of Huxley is applied. A limited number of fossil species are described in detail, the relation of the structure to the animal's mode of life being pointed out, as well as the effects of fossilisation. Each such description is followed by a general account of the group of which the "type" is representative. The volume will contain appendices dealing with rules of nomenclature and methods of extracting and preserving fossils. In Dr. Holmes's volume the following subjects receive attention: Specific gravity and porosity of rocks—examination of crushed rocks and loose sediments—mineral analyses by heavy liquid, magnetic, and electrostatic methods—mechanical analysis of sands—preparation of thin sections and their examination by staining, micro-chemical, and other methods—chemical analyses of rocks and their interpretation—representation of analyses by diagrams—suggestions for the description of rocks.

MESSRS. W. HEFFER AND SONS, LTD., Cambridge, have just circulated a miscellaneous catalogue (No. 186) of secondhand books which will doubtless be of service to many readers of NATURE. The more strictly scientific portion contains 100 items ranging over most of the branches of scientific knowledge; a lengthier section gives particulars of works on folklore, mythology, psychical research, comparative religions, etc. The Sanskrit collection of the late Dr. A. F. R. Hoernle, comprising about 400 volumes, is also listed. The catalogue may be had upon application.

READERS OF NATURE interested in biography and desirous of obtaining books relating to this subject at small cost should obtain a copy of Catalogue No. 400 just issued by Mr. F. Edwards, 83 High Street, Marylebone, W.1. The list is not particularly strong in science, but it contains lives of Charles Darwin, Sir Joseph Banks, J. J. Audubon, Thomas Bewick, Sir Colin Scott-Moncrieff, and others. There is also a section of works on genealogy and family history. The catalogue will be sent on request.

NO. 2631, VOL. 105]

## Our Astronomical Column.

APRIL METEORS.—Of April generally and its special meteoric display it can scarcely be said that they often possess features of striking interest from a spectator's point of view. The fact is that the spring months are usually all deficient in abnormal phenomena of this kind, and observers are sometimes sadly disappointed with the result of their observations; for if meteors from Lyra are absent or few, there is little else to engage the student, as meteors may fall not more abundantly than three or four in an hour.

There are periodic returns of grandeur attached to the Lyrids, but the uncertainty of the periodic time renders it a non-predictive feature. Hence the observer must needs take up his stand with a very doubtful prospect before him.

But the stream of Lyrid meteors has important historical associations, and the shower can boast of a known cometary parentage. These facts, combined with the possibility of a bright and abundant display in any year, lure observers to look for it with an interest and anticipation sometimes amply justified.

SPECTRUM OF  $\eta$  ARGUS.—As Mr. Baxandall and Miss Cannon suspected changes in the spectrum of this interesting star, Dr. Joseph Lunt took two photographs in February and April, 1919. Each was exposed on three nights with a total exposure of nine hours. The spectrum consists mainly of bright lines; there are dark lines, but they cannot be identified with known lines, and may be merely interspaces between bright bands. The results for radial motion differ according to the lines employed. The enhanced iron lines give  $-30.7$  and  $-28.2$  km./sec. from the two plates. The chromium lines are in fair agreement with this, but the hydrogen bright lines give  $+46.5$  and  $+48.7$  km./sec., a difference of  $77$  km./sec. from the other lines. On the other hand, hydrogen dark lines give  $-19$  excluding  $H_{\beta}$ , or  $-33$  including it.

Dr. Lunt suggests in explanation the settling down of an extensive outer hydrogen atmosphere on to the central body. He refers to Mr. Innes's discovery of a faint companion, and notes that hitherto no certain sign of variable radial velocity has been detected. He emphasises the importance of keeping the star under constant watch, both visual and spectroscopic, as the light curve gives expectation of another brightening about the present time. The star is a curious link between novæ and variables, Miss Cannon noting a strong resemblance between its bright-line spectrum and that of Nova Aurigæ on 1892 February 17 (Monthly Notices, vol. lxxix.).

INFRA-RED SPECTRA OF NEBULÆ.—Investigations are being carried out at the Lick Observatory by Dr. K. Burns with the object of securing photographic plates of great sensitivity to infra-red radiations, and some plates prepared by him have been utilised by Mr. W. H. Wright for exploring the spectra of nebulae in this region. In the Publications of the Astronomical Society of the Pacific, No. 185, Mr. Wright gives an account of his preliminary attempts in this direction, with the results obtained in the case of the planetary nebula N.G.C. 7027. The 36-in. refractor of the Lick Observatory was used with a single-prism spectrograph giving the rather small dispersion of 1 mm. to about 600 Å.U. on the plate. The focus was not good in the region required, but fair definition was obtained between  $\lambda 6700$  and  $\lambda 8500$ , and his photographs show four lines in the extreme red not previously reported. The corrected wave-lengths are given as approximately 7009, 7065, 7138, and 7325, and in addition to these lines there are others at  $\lambda 6678$  and  $\lambda 6730$  which have been measured previously with other apparatus.

### Hydrographical Studies.<sup>1</sup>

HYDROGRAPHY is a backward science, and the very ocean, scientifically speaking, is a neglected field. Mr. J. Y. Buchanan, an oceanographer himself, tells us in his new book of "Accounts Rendered":—"It seems almost incredible that the men of all nations, burning with scientific and exploring zeal, should have entirely overlooked, and apparently despised, this large portion of the world." Our *Challenger* Expedition had two faults: it cost a great deal of money, and it was done too well. It has led two generations of Englishmen to believe that the thing was done and need not be repeated, and must on no account be asked for again. Yet, in spite of this great old expedition of ours, and the various scientific exploring voyages of the *Travailleur*, the *Gauss*, the *Siboga*, the *Albatross*, the *Thor*, and all the rest which have followed it (in other hands than ours), we know perfectly well that our knowledge of the ocean, both physical and biological, is in its merest infancy. Its fauna we know as we knew that of the shore fifty years ago, a handful here, a handful there, of its physical and physico-chemical phenomena we know a great deal less.

Nor is this true only of the wide oceans. Twenty years ago we knew, to all intents and purposes, absolutely nothing of the hydrography of the North Sea itself with the one exception of its tides. Its temperatures and densities had never been mapped, their seasonal fluctuations (save at a few shore-stations) were unknown. Even in regard to the tides, and in spite of the great men who have devoted themselves to this favourite subject, we know that we have still a vast deal to learn in theory, and that in practice our tide-tables fall short of the accuracy which modern conditions demand. Things are beginning to mend. The University of Liverpool has established, not only a chair of oceanography, but also a special institute for the study of the tides; and, under the stimulus of international co-operation, a certain aspect of hydrography has come to be an intrinsic part of the scientific work of our fishery departments.

All this is to the good, though not yet nearly enough. The fishery departments are working on imperfect material, with inadequate staffs and still more inadequate laboratories; but better days are coming. Even in these hard times the work will go on, and under much better conditions than before, but we shall scarcely be satisfied! For the physical study of the sea is a very great thing indeed. Of its problems many are scarcely formulated, many others doubtless are still unforeseen. There is no end to them; they range, let us say, from the study of the tides to that of hydroxyl-ion concentrations, from the movements of the great ocean currents to the coefficients of absorption of the sun's rays in the surface-waters of the sea—nay more, they may involve the most fundamental questions of chemical physiology, in relation to the life and the nutrition of one grade of organisms after another. They call, or ought to call, for the widest physical and chemical knowledge and high mathematical skill. Not only must the officials of a department do their daily task, but still wiser and more learned heads must play their part.

There is not one of these problems which has not its practical side—its influence, direct or indirect, on the lives of fish and the lives of men. But the prac-

tical outcome of our knowledge lies, for the most part, a good long way off. The tanner, the dyer, or the brewer, the maker of soap or of glass, even the farmer and the gold-digger, come straight to the chemist with their troubles, for they have learned at last that it is worth their while; yet even now when they do so, as often as not the questions they put only suggest a new line of investigation, instead of finding an answer to hand. And chemistry is all but the oldest of the sciences, while hydrography is a thing of yesterday—or rather of to-morrow.

But I have left myself no room, after all, to discuss as they deserve those of Dr. Jee's papers published by the Department of Agriculture and Fisheries. They form a diligent and meritorious contribution to the necessary statistics of hydrography. They set forth fully and clearly (1) the variations of temperature and of salinity during a considerable number of years at the Seven Stones Lighthouse, a station of very obvious importance in the neighbourhood of the Scilly Isles; (2) the same phenomena on a cross-section of the English Channel, from the Isle of Wight to St. Malo; and (3) the same again for the surface-waters of the North Atlantic, in a particular area where warm currents appear to branch off for the ultimate supply of the southern and the northern portions of the North Sea. The data, which are very numerous, are furnished by captains of ships and the keepers of the lighthouse; and Dr. Jee's business has been to reduce to order, to analyse, and, above all, to discuss this large mass of observations. The phenomena so elucidated, and the deductions drawn from them, are too numerous to be discussed here.

On one curious point, and one only, we may say a word. Dr. Jee pays a good deal of attention to a favourite theory of certain meteorologists (Dr. Otto Pettersson among them) that there is a marked alternation of temperatures between the "odd" and the "even" years; that there is at least a *tendency* for the years of even number to be warmer than the odd. Dr. Jee finds considerable support for this theory in the surface-waters of the sea, but subject to curious limitations. He tells us that "it is a fact of undoubted significance that, for a very wide stretch of the Atlantic extending from the coast of Cornwall at least as far as 35° W., the November means are in the aggregate of substantially higher value in the years of even number, and that this value culminates in the area of maximal temperature. . . . This periodicity is a general feature of the waters of the Atlantic east of 35° W., and the persistence of its occurrence is amply demonstrated by the zonal means, which *regularly alternate* high in the November of an even year and low in the year following."

There is here, in short, some definite evidence adduced bearing on the important question of a regular two-year "pulse" of the Gulf Stream. But during other parts of the year exceptions become perplexingly numerous, and Dr. Jee himself tells us that "examination of the monthly means . . . shows that only in November do they exhibit any appreciable conformability to the odd and even rule." Even if the phenomenon were only clearly manifested in November (in this particular region), it might still be of great importance, and we should like to know a great deal more about it. The fact that we are left without a firm hold of the thing is not Dr. Jee's fault at all, but depends on the fact that he is still only able to deal in detail with a particular and limited area. A similarly detailed account of the surrounding areas would soon, I imagine, convince us whether we were dealing with a real phenomenon or not, and if it confirmed would begin to help to explain it.

D'ARCY W. THOMPSON.

<sup>1</sup> Board of Agriculture and Fisheries: Fishery Investigations. Ser. III. Hydrography. Vol. I., "The English Channel," Part ii.; Vol. II., "Lighthouse Observations," Part I.; Vol. III., "The Atlantic Ocean," Part I. By Dr. Edwin C. Jee, Hydrographer on the Staff of the Board. (H.M. Stationery Office, 1910.)

## Public Health and Welfare.

THE forty-eighth Annual Report of the Local Government Board, containing the report of the Medical Department for 1918-19, is noteworthy in many respects. It is the last of what may justly be called a famous series; it is addressed, not, like its predecessors, to the President of the Board, but to the Minister of Health, and its introduction is written by the First Medical Officer of the Ministry of Health. Its contents are noteworthy too, dealing with matters that no one probably even ten years ago would have dreamed of seeing referred to in the Board's report, and with subjects that the early Medical Officers of the Board never thought of in relation to the work of the Board.

The introduction, written by Sir George Newman, takes the form of an interesting little historical note on the origin and growth of the Medical Department of the Local Government Board. To Sir John Simon, who was the first Medical Officer, to Dr. Seaton, who succeeded him, to Sir George Buchanan, to Sir Richard Thorne Thorne, to Sir William Power, and to Sir Arthur Newsholme, the last of the famous line, he pays due tribute. They were all great men in the eyes of the Public Health Service, but Sir John Simon was the greatest of them all. As the English Parliament is the mother of Parliaments, so English public health is the mother of all public health, and this is due almost entirely to Sir John Simon. That the English public health organisation is what it is to-day, the finest in the world and adopted as the model by every civilised nation, is largely thanks to him. This Sir George Newman acknowledges. He recognises also the greatness of the task before the new Ministry, and admits, though many hard things have been said of it, that the Local Government Board did work of tremendous value to the country and the people, and, "with all its limitations of machinery, proved itself a body in search of truth and having humanitarian ends."—One precious possession it gave was the gift of method—"a method formulated by practice and experience, which consists of a combination of scientific work and common-sense administration, both associated with a wide and comprehensive vision." As to the future medical plans of the Ministry Sir George Newman has little to say except that steps have been taken to reorganise the medical arrangements by enlarging the staff and differentiating its functions. For the report itself Dr. G. S. Buchanan, Dr. R. J. Reece, and the Medical Inspectors of the Board are responsible, the first-named providing a general survey, as well as dealing, like each of his colleagues, with certain of the special conditions or subjects he was called upon to investigate during the year.

The bulk of the articles included relate to epidemic disease, and the outstanding feature of the year in this connection having been the pandemic of influenza, not unnaturally much space is devoted to this disease, the duty of reporting upon it being imposed upon Dr. Carnwath, who acted as secretary of the special committee set up to investigate the subject. This report contains an admirable and concise description of the outbreaks experienced here, and contains much most useful information with regard to the natural history of the disease. Reference is made to a number of investigations, bacteriological and epidemiological, carried out in various parts of the country during the epidemic. So far as the former are concerned, it cannot, as Dr. Carnwath states, "yet be stated that unequivocal conclusions have been reached." Serious doubt, however, was cast upon the claims of the bacillus of Pfeiffer, which for years had been held to be the causative organism, to continue to be so

regarded. So far as epidemiological investigations were concerned, attention is directed to those carried out in Leicester by Dr. Arnold, one of the Medical Inspectors, and in certain public schools by Dr. MacEwen, also a Medical Inspector. In Leicester Dr. Arnold made more or less of a general inquiry with the view of eliciting information as to age incidence, while in the schools Dr. MacEwen went into the question of immunity in influenza. Neither investigator appeared to succeed in obtaining any information of practical value.

For a section of the report dealing with epidemic diseases associated specially with war conditions Dr. Buchanan is responsible; while Dr. Reece and Dr. MacNalty treat of encephalitis lethargica, the condition which the Press at first insisted upon regarding as botulism, and now persistently and, for some reason or other, jocularly refers to as "sleeping sickness." Of the war-diseases those specially dealt with are typhus and trench fever, malaria and dysentery. The fact that the first two are louse-borne diseases is stressed, and in regard to malaria it is pointed out that, though a few cases of indigenous origin have been brought to light, only in Kent was there any considerable spread of the disease. In the report on encephalitis lethargica Dr. Reece deals with prevalence, and Dr. MacNalty with the general features, of the disease. By both observers a number of references are made to instances of multiple cases in families and institutions, but both quite definitely hesitate to class the condition as infective. Dr. MacNalty's explanation of the sporadic distribution, that it belongs to the group of maladies, including such conditions as cerebrospinal fever (spotted fever) and acute poliomyelitis (infantile paralysis), in which the agent is present commonly in the body and inactive until immunity breaks down, is one likely to be generally accepted.

Apart from reports upon diseases, there are some others dealing with more general matters. Of these, two calling for special reference are that by Dr. Wheaton on maternity and child welfare, and that on the work of the inspectors of food by Dr. MacFadden. Both chronicle advances and improvements. Dr. Wheaton shows that there is a steady increase in enthusiasm for welfare work amongst local authorities, as evidenced by the appointment of more and more health visitors and by the establishment of more and more centres, consultations, crèches, and day nurseries. The work of the food inspectors on behalf of the Army and the people, Dr. MacFadden states, was carried out with great activity, and, if it did nothing more, showed many openings for reforms. Of two important, long-overdue reforms, one has relation to the inspection of home-killed meat, which is inadequately done, because only just over a hundred local authorities have established public abattoirs, and much slaughtering is still done in private slaughterhouses. The other matter calling for attention is the supervision of places where food is prepared or stored. In most districts there are many places in which food is dealt with where the conditions are undoubtedly very bad. From time to time such places are discovered and efforts made to deal with them, but, as Dr. MacFadden shows, proper supervision is impossible for the reason that the powers granted by the Health Acts are inadequate and unsuitable for controlling them, and, more important still, the local inspectors are too few in number and too much overloaded with work of other kinds.

The whole report is exceedingly interesting, and in no sense inferior to those of former years. As it was the last of the series, no doubt those responsible for it desired to see it maintain the high level of excellence already attained, and they have succeeded.

### Education of Engineers.<sup>1</sup>

THE report on the education and training of electrical engineers is a really important and instructive pronouncement. The industry is a comparatively new one, and the committee has been able to formulate recommendations in advance of the prejudices and customs of older branches of engineering. An attempt is made to lay down a uniform system for manual and technical workers of various grades, and it is pointed out that industry should be represented on all committees concerned with primary, higher, and technical education and with after-care and juvenile employment. The committee recognises four classes of apprentices, namely:

(1) *Trade Apprentices*, who enter works between fourteen and sixteen and are to be trained to become skilled workmen. They should be selected at an interview and given a trial period. The committee suggests that they should be placed under the supervision of a trained officer responsible for their selection, who should keep records of their progress.

(2) *Engineering Apprentices*, who enter works between the ages of sixteen and eighteen, chiefly from the higher secondary schools. These should be trained by practical experience and technical education, up to the age of twenty-one, for junior staff positions. Before entering works they should have attained a standard equivalent to that of a university matriculation examination. They should be selected after an interview and examination of school records, and appointed for a probationary period. Their practical training should be directed not so much to making them skilled workmen as to giving them a knowledge of various manufacturing processes and of design, testing, and workshop organisation. Their technical education should be continued during apprenticeship by part-time courses.

(3) *Student Apprentices*, preferably graduates in engineering, who enter the works between the ages of nineteen and twenty-two, and should be definitely trained for senior positions on the staff. The committee has reached the conclusion that the need for attracting men of ability makes it imperative, not only to abolish the premium system, but also to give during apprenticeship a maintenance allowance. Student apprentices should, if possible, have graduated in honours in engineering, and be taken systematically through a group of related departments.

(4) *Research Apprentices*.—Research is now an essential factor in industrial progress, and it is necessary to make definite provision for the training of research workers. University graduates who have shown special aptitude for scientific investigation should be selected, preferably from those who enter as student apprentices. In the last year of apprenticeship they should devote attention to investigations arising in practice, and then return to the university for a year of post-graduate work or obtain equivalent experience in a works laboratory.

The report concludes with a discussion of the need for more scholarships from primary to junior technical and secondary schools, and from these to the technological faculties of the universities; also for post-graduate research.

The report of the Institution of Naval Architects is briefer and less systematic. So far as it goes, it is on the same lines as the electrical report. It states

<sup>1</sup> "Education and Training for the Electrical and Allied Industries." Being a Report of a Committee of the British Electrical and Allied Manufacturers' Association. 64 pp. (London: Edward Arnold.)

Institution of Naval Architects. Report of the Committee on the Education and Training of Apprentices in Shipyards and Marine Engineering Works.

that an apprenticeship, or at least a clear understanding binding on both sides between employer and lads entering works, is desirable. It suggests selection on results of school work and the need for a supervisor of lads learning their business. An appendix contains information obtained from the principal shipbuilding firms as to the opportunities afforded by them to lads entering the works, and especially as to the inducements held out to them to improve their educational equipment. An interesting part of the report is an account of the admirable system of training established by the Admiralty in H.M. Dockyards.

W. C. U.

### Tropical Control of Australian Rainfall.

IT would appear probable that the Australian continent, extending well within the tropical belt, of approximately symmetrical shape, and free from disturbance by large land masses, especially to the east and west, is the very best place to study the mechanism of tropical rain control. Certainly such a control, if proved and reduced to a system, should very greatly assist the forecasting of the all-important Australian rainfall. Bulletin No. 15 of the Commonwealth Bureau of Meteorology is devoted to a study of this subject by Mr. E. T. Quayle, Supervising Meteorologist of the Melbourne Bureau.

It must be admitted that the period dealt with, largely confined to the six years 1911-16, seems to demand very strong evidence to justify a general conclusion. This objection is partly met by an addendum dealing to some extent with longer periods—up to twenty-four years in one instance—but one would be inclined to wait for confirmation of the great improvement in rain-forecasting claimed by Mr. Quayle. His chosen "argument" is the minimum temperature in the tropical regions of Australia. If this is high, it may be attributed to cloudiness, extra humidity, or north-east wind, and of these three the second is suggested as the most important. In any case, the idea is that this high minimum, which is usually persistent for a few weeks at a time, causes such a flow of air to the southern parts of the continent that the approaching cyclonic "lows" are compelled to part with rain.

The stations on which Mr. Quayle lays most stress for his prediction are Darwin and Mein, the latter being on the north-east coast of Queensland. The influence does not travel directly southward, but Mein corresponds more closely with the Darling district of New South Wales and North Victoria; while Darwin corresponds with South Australia and, to a much less extent, with Western Australia. Inasmuch as the Darwin temperatures are inclined to follow those of Mein after about three days, the inference is that a longer forecast can be made from the Mein figures, or possibly from figures further eastwards in New Guinea.

Mr. Quayle gives figures to show that the average daily rainfall over the southern inland areas during the months April to October (the wheat-growing period) is more than twice as great during periods of high minimum at Darwin as during periods of low minimum. He considers that the slowness of the changes at Darwin justifies forecasts twenty days ahead. He discredits barometer readings as quite untrustworthy for this purpose. The behaviour of the lines of influence is not the same in dry years, but is nearly north to south in wet years. The exceptional years 1914 and 1916 happen to be included in the short period under consideration, and these certainly

show up in the diagrams connecting tropical temperatures with rainfall in New South Wales, South Australia, and the Upper Darling. Tinted diagrams are given showing for the whole continent the monthly departures from mean minimum temperature and mean rainfall, except for the summer months when rain is inappreciable.

W. W. B.

### Prehistoric Man and Racial Characters.

THE annual meeting of the Prehistoric Society of East Anglia was held on March 23 at the rooms of the Geological Society, the members of the Prehistoric Society being the guests of the Royal Anthropological Institute. The chair was taken by Prof. J. E. Marr, who delivered his presidential address. His subject was "The Relationship of the Various Periods of Prehistoric Man to the Great Ice Age." He regarded the existence of Pliocene man in East Anglia as proved, and also accepted Mr. Reid Moir's views that the "Mid-Glacial" implements of Ipswich were of Lower Palaeolithic age, and that Lower Mousterian implements were incorporated in the Chalky Boulder Clay. He brought forward confirmatory evidence of this from the drainage area of the Great Ouse basin, and regarded the Chelles-Archeul period as intermediate between the two glaciations marked by the Cromer Till and Chalky Boulder Clay respectively. After the formation of the latter clay there seemed to be a recession of ice followed by a readvance in Magdalenian times, but, as O. Holst argues, this need not indicate an inter-glacial period. If there was a Pliocene glaciation in this country, the evidence seems to point to two succeeding glaciations in Pleistocene times, the last being marked by a period of ice-recession in Aurignac-Solutrè times, in which case Lower Palaeolithic man lived between the second and third glaciations, and the men of the periods from Mousterian to Magdalenian inclusive during the period of the third glaciation, with its interval of temporary ice-retreat. The questions of earth movements and diversions of river drainage during the periods under consideration were briefly considered.

The presidential address was followed by a paper by Mr. H. Dewey entitled "Flat-based Celts from Kent, Hampshire, and Dorset," dealing with a group of implements that were found lying on the surface in various parts of those counties. They differ in outline from one another, but agree in possessing flat bases. Some of the bases were produced by the removal of a single flake, and retain the terminal cone of percussion. Others resulted from the removal of a number of flakes from the sides of the implement, with the obvious intention of making the base level and flat. Most of them are pointed at one end, and have a horizontal chisel-edge at the opposite extremity. In their general form they resemble fat slugs or caterpillars. Sir John Evans figures some examples. Their age is unknown, but would by most archaeologists be assigned to the Neolithic period. The discovery, however, in gravels of similar forms renders hasty classification hazardous.

A very fine collection of stone implements from Grime's Graves was exhibited by Dr. A. E. Peake.

In the evening, at a joint meeting of the Royal Anthropological Institute and the Prehistoric Society of East Anglia, Sir Everard im Thurn in the chair, Prof. Arthur Keith gave an address entitled "How Far can Osteological Characters Help in Fixing the Antiquity of Human Remains?" Certain characters of the nose, orbit, palate, and lower jaw have never been seen in British skulls belonging to any period

older than the Roman occupation, and become increasingly frequent as we approach the present time. These characters consist of (1) the "margination" or flanging of the lower border of the nasal opening; (2) the retreat of the incisor part of the alveolus of the upper jaw, leaving the nasal spine and lower margin of the nose as an overhanging jib and ledge; (3) the reduction in size of the malar bone, leading to the lower margin of the orbit being depressed in a downward and outward direction; (4) the arching of the upper margin of the orbit; and (5) a reduction in the development of the angular part of the lower jaw. If these characters are found in a British skull, the conclusion may be drawn with certainty that it is of a Roman or post-Roman date. Contraction of the palate was also a character unknown in Britain until a Late Celtic date. The rounded type of head found in graves of the beaker period in Britain were not known in England before Late Neolithic times, but pure representations of this type of skull are still to be seen in our modern population. A type of skull was found in the deeper deposits of the Thames bed which were identical with the skulls found under the Neolithic pile-dwellings of the Swiss lakes. So far as our knowledge of Neanderthal man will take us, we are justified in regarding him as confined to the Mousterian period of European culture. If any characteristic part of the skull or skeleton of this race were discovered in an undisturbed deposit, that deposit may be safely assigned to the period of the Mousterian culture.

### A College of Tropical Agriculture.<sup>1</sup>

A STRONG Committee was appointed in August last to report to the Secretary of State for the Colonies upon the desirability of establishing a tropical agricultural college in the West Indies and upon matters connected therewith. Its report has just appeared, and is one which may be fraught with important results for the future of agriculture in our extensive tropical Dependencies, more especially in the West Indies, where, thanks to the work of the Imperial Department of Agriculture, general agricultural prosperity has in the last two decades been placed upon a much sounder footing. It is significant of the trend of modern practice that a Committee like this, composed of planters, commercial magnates, and scientific men, as well as administrative officials, should have reported unanimously in favour of the establishment of such a college.

The selection of a site affords much ground for discussion, and after careful consideration Trinidad was chosen as being near to the headquarters of the Imperial Department, and having good communications with the other islands, besides a great variety of crops in cultivation. Incidentally, in view of the growing importance of oil in that colony, a subsidiary school of oil technology is proposed. A postscript to the report, however, suggests that the last word may not yet have been said on the subject of location.

A governing body of about twenty-three, representing all the different interests involved, is proposed, and a staff of ten professors (agriculture, mycology, entomology, agricultural chemistry, organic chemistry, agricultural bacteriology, agricultural and physiological botany, genetics, sugar technology, and agricultural engineering and physics), besides lecturers in stock and veterinary science and in bookkeeping.

Considerable interest attaches to a curriculum sug-

<sup>1</sup> West Indies. Report of the Tropical Agricultural College Committee. (H.M. Stationery Office, 1920.) Price 2d.

gested by Sir Francis Watts, the Imperial Commissioner of Agriculture for the West Indies, with which the Committee expresses itself as in general agreement. It includes (a) a junior course of two or three years, suitable for boys leaving the Colonial secondary schools and intending to follow ordinary agricultural pursuits, usually in the colonies from which they have come; (b) a senior course of similar instruction of not less than four years; (c) a two years' course, practically the same as the last two years of the previous course, for students who have already undergone a training in agriculture in a university or agricultural college, and thus intended to meet the case of students going out from Europe to work at agriculture in the tropics, whether on their own account or as officials; and (d) post-graduate study of special agricultural subjects, such as mycology or genetics, or the study of special crops such as sugar or cacao. It is incidentally recommended that a special school for the study of sugar should be established.

This is a very interesting and practical programme, and it is to be hoped that it may soon be translated into reality. The only criticism that occurs to one is to ask whether it is not just a trifle too ambitious for a commencement and too great a change from the customary methods of learning the work of tropical agriculture, and whether it may not tend to make the tropical student at least, and especially him who must work under seniors trained in the old way, a trifle unpractical. Great care will have to be exercised to make the instruction as practical as possible, and for this reason we note with pleasure the insistence upon making the new college work as much as possible in connection with the Imperial Department.

Finally, it is suggested that a fund of at least 50,000*l.* be raised by private subscription for the establishment of the college, and that for maintenance annual contributions be invited from the various Colonial Governments, and also from the Imperial Government, to which the proper development of the great tropical lands of the Empire is of such paramount importance.

### Duplex Wireless Telephony.

ANOTHER of the interesting series of papers on wireless developments connected with the war before the Wireless Section of the Institution of Electrical Engineers was that of Capt. P. P. Eckersley, read on March 17, describing experiments by Major Whiddington and himself on the application of duplex wireless telephony to aircraft. The advantages of being able to converse freely and simultaneously both ways, as is done in a true duplex system, over using a change-over switch are obvious, but the electrical difficulties in the way of its successful accomplishment are considerable. The main problem lies in devising a form of circuit which will protect the receiver, without detriment to its efficiency, from the effects of the relatively powerful high-frequency alternating currents generated by the transmitter.

Two general principles have been adopted. In one, two separate aerials with different frequencies for transmission and reception are placed at right angles and spaced more than a quarter of a wave-length apart. In the other, which may employ a single aerial, the "earth" connection is split, and the branches are tuned so that the transmitter current passes through one and the receiver current through the other. Both these systems present difficulties, and have been used only to a limited extent. A compromise system, in which the transmitter oscillates only when the operator is actually speaking, with what is

called a "quiescent aerial" was also experimented with, but the speech was found to be much improved by allowing a small permanent oscillation, increased sympathetically with the voice. Such an arrangement, called an "augmented oscillation transmitter," has certain practical advantages, as well as incidentally presenting some interesting theoretical points, but forms only a "partial duplex" system, as an interruption during speaking cannot be heard. The author's experiments have progressed well on the way towards the evolution of a practical and trustworthy system of duplex wireless telephony for aircraft, and form a valuable groundwork for future development.

### University and Educational Intelligence.

ABERDEEN.—At the spring graduation ceremony Principal Sir George Adam Smith announced a gift of 20,000*l.* from Sir Thomas Jaffrey, head of the Aberdeen Savings Bank, for the establishment of a chair in political economy in the University. There has been a lectureship in this subject for a number of years.

The University has just conferred on Sir Jagadis Chandra Bose the honorary degree of LL.D.

BIRMINGHAM.—Mr. Arthur R. Ling, consultant in applied chemistry and lecturer in brewing at the Sir John Cass Institute, London, has been appointed to the Adrian Brown chair of brewing.

A bronze memorial tablet in memory of the late Prof. Adrian Brown has been erected in the Brewing School by past students.

A gift has been received from the Asiatic Petroleum Co. of a model drilling equipment, which will be exhibited at the forthcoming Petroleum Exhibition at the Crystal Palace.

Mr. Frank Shaw has been appointed assistant lecturer in electrical engineering, and Mr. Raymond B. H. Wyatt lecturer in bacteriology.

CAMBRIDGE.—Mr. G. E. Briggs, St. John's College, formerly University Frank Smart student in botany, has been elected to the Allen scholarship.

The new Statute of the University which gives the degree of Ph.D. to research students in the University is the result of the work of a syndicate appointed in December, 1917, "to consider the means of promoting educational collaboration with the universities of the Empire and foreign universities." The chief points of interest in the proposed regulations for working the Statute are as follows:—Research students, who must be at least twenty-one years of age on admission, must have graduated at some university (Cambridge itself included), or must satisfy the University as to their general educational qualifications. Before admission their proposed course of research must have been approved, and they must show that they are qualified to enter upon the course proposed. Students must pursue research for three years before submitting for a degree the dissertations embodying the results of their research. Those who are graduates of Cambridge need only spend one of the three years at Cambridge; others must spend at least two years at Cambridge. The remainder of the time must be spent at some place or places of study approved by the University. Research students who are candidates for degrees at other universities and who spend at least two terms in Cambridge may receive certificates of regular study and industry to cover the time spent in Cambridge. A Board of Research Studies is to be formed to supervise the carrying out of the new scheme. The proposals show a welcome movement away from the old spirit of "splendid isola-

tion" which has in the past too often been attributed to Cambridge University.

LONDON.—Mr. William Neilson-Jones has been appointed as from May 1 next to the University chair of botany tenable at Bedford College. Mr. Neilson-Jones was foundation scholar of Emmanuel College, Cambridge, and obtained a first class in part i. of the Natural Sciences Tripos and a second class in part ii. (Botany). He has carried out research work at Cambridge and for the Health of Munition Workers Committee of the Medical Research Committee. In 1909 Mr. Neilson-Jones was appointed lecturer in botany at University College, Reading, and in 1913 assistant lecturer in botany at Bedford College; since 1916 he has been head of the department at this college.

It has been resolved by the Senate that the following posts should be established in connection with the recent benefaction of 150,000*l.* made by the Sir Ernest Cassel Trustees:—(1) Sir Ernest Cassel chairs of accountancy and business methods, of commercial and industrial law, and of banking and currency; (2) three Sir Ernest Cassel readerships in commerce, dealing specially with (a) foreign trade, (b) the organisation of industry and trade in the United Kingdom, and (c) the influence of tariffs and taxation respectively; and (3) three University lectureships in commerce, with special reference to commercial geography, business methods, and transport respectively.

An offer from the Worshipful Company of Vintners to provide, for a period of five years in the first instance, two scholarships, each of the annual value of 150*l.*, for students for the degree in commerce has been accepted by the Senate with thanks. The thanks of the Senate have also been accorded to the relatives of the late Capt. G. D. Harvey-Webb, formerly of University College, for their gift of his collection of shells for the department of zoology at that college; and to Prof. Graham Wallas for his gift of another collection of shells for the same department to supplement that of Capt. Harvey-Webb.

The following doctorates have been conferred:—*D.Sc.*: Mr. F. J. North, an external student, for a thesis entitled "On Syringothyrus, Winchell, and Certain Carboniferous Brachiopoda referred to Spiriferina, d'Orbigny." *D.Sc. (Economics)*: The Rev. A. W. Parry, an external student, for a thesis entitled "Education in England in the Middle Ages."

Keddey Fletcher-Warr studentships, each of the value of 300*l.* a year for three years, have been awarded to Dr. Agnes Arber, for post-graduate research in botany, and to Miss Margaret McFarlane, for post-graduate research in psychology. These studentships were established under the benefaction founded by Mrs. du Puy Fletcher.

The annual report of University College has just been issued. The total number of students for the session 1918-19 was 2048, an increase of 977 on the previous year. This increase took place after the armistice, and mainly in January, 1919, and consisted almost exclusively of ex-Service men. The total revenue of the college for the year 1918-19 was 75,781*l.*, of which 26,304*l.* was from fees. The total expenditure was 77,824*l.*, causing a deficit of 2210*l.* This deficit arises from the increase in salaries that has become necessary, and generally from the increased cost of running the college. The report contains a summary of the main work of the year. The new departments of Scandinavian studies and of Dutch studies have already made a good start. The new school of librarianship, which has been instituted with money provided by the Carnegie Trust, and of which

Sir Frederic Kenyon is the honorary visitor, began with an enrolment of eighty-eight students. The student body included 253 post-graduate and research workers. The fifth appendix of the report gives a list of the papers and publications issued by them during the past year. Nine new fellows are elected to the college biennially. The list for this year is remarkable in that it includes the first Chinaman to be elected to the fellowship and two distinguished members of the Slade School of Fine Art. The full list of fellows is as follows:—F. J. Fitzmaurice Brington, W. C. Clinton, Ethel M. Elderton, Brig.-Gen. Sir Alexander Gibb, his Excellency Yuen Hsu, Augustus E. John, Major Sir William Orpen, Dr. T. H. C. Stevenson, and Dr. Ethel N. Thomas.

MANCHESTER.—In connection with the Ellis Llywyd Jones lectureship for training teachers of the deaf recently established at the University through the benefaction of Sir James E. Jones, the Carnegie United Kingdom Trust has granted to the University the sum of 2500*l.* for the foundation and maintenance of a library for deaf education. It is intended to make this library as comprehensive as possible, and to include in it works dealing with the various systems of teaching the deaf, speech training, psychology of speech and of hearing, phonetics, acoustics, anatomy, physiology, and diseases of the ear. The books are to be available to all individuals, societies, and institutions throughout the United Kingdom interested or concerned in the education and training of the deaf, and they will be ready for consultation and borrowing immediately after Easter. No charge beyond the cost of carriage is to be made for the loan of books, but intending borrowers will be required to fill in a form of application to be obtained from the Librarian, Library for Deaf Education, The University, Manchester.

OXFORD.—The Romanes lecture for 1920 will be delivered by the Very Rev. W. R. Inge, honorary fellow of Hertford College, Dean of St. Paul's, on Thursday, May 27. The subject will be "The Idea of Progress."

## Societies and Academies.

LONDON.

**Aristotelian Society**, March 8.—Prof. Wildon Carr in the chair.—**M. Ginsberg**: Is there a general will? The term "general will" has been used in many different senses. Especially important are the view of Wundt based on an analysis of the mutual implications of presentation and will, and leading to a theory of a series of will-unities of varied complexity, and the doctrine of a "real" will worked out by Prof. Bosanquet and other idealists. All the theories, in varying degrees, involve a confusion between the act of willing, which must always be individual, and the object of will, which may be common. Prof. Bosanquet's view in particular is based upon a hypostatisation of contents, and a tendency to deny the reality of acts, of experience. Generally, in so far as the psychological forces operative in society are general they are not will, and in so far as there is present self-conscious volition it is not general. The State and other associations exhibit a kind of unity, but this unity is a relation based on community of ideals and purposes, and must not be spoken of as a person or will. For the purpose of social theory, what is required is not a common self, but a common good. The latter is an ideal and not an existent, and must not be identified with a general will.

**Mineralogical Society**, March 16.—Sir William P. Beale, Bart., president, in the chair.—A. Russell: The occurrence of cotunnite, anglesite, leadhillite, and galena on fused lead from the wreck of the fireship *Firebrand*, Falmouth Harbour, Cornwall. The specimens were obtained in 1846 from the wreck of the fireship *Firebrand*, which was burnt in Falmouth Harbour about the year 1780. They were found under the lead pump, most of which appeared to have been melted and mixed with charcoal, and consist of slag-like masses of lead, which has evidently been fused, and upon the surface and interstices of which are numerous well-defined and brilliant crystals of cotunnite and anglesite, and more rarely small crystals of leadhillite and galena. The cotunnite crystals, which are colourless and transparent, with brilliant faces, are nearly always elongated in the direction of the  $a$  axis, and attain a length of 3 mm. The habit is somewhat variable owing to the very unequal development of the faces. The forms observed were 010, 001, 021, 011, 012, 101, 111, and 112. The anglesite crystals are of rectangular habit, and exhibit the forms 100, 001, 110, 102, 122, and 113. The leadhillite crystals, thin six-sided plates in shape, are of a brown colour, and show the forms 101, 201, 101, 201, 112, 111,  $\bar{1}12$ , and  $\bar{1}11$ . The galena occurs in minute cubo-octahedra. An occurrence of cotunnite formed under almost exactly similar conditions has been described by A. Lacroix. Similar occurrences of lead oxychlorides at Laurium and of leadhillite in Roman slags from the Mendip Hills were referred to.—W. Campbell Smith: Riebeckite-rhyolite from North Kordofan, Sudan. A rock found by Dr. C. G. Seligman at the base of Jebel Katul, 350 miles south-west of the Bayuda volcanic field, was described.—Dr. G. T. Prior: The meteoric iron of Mount Ayliff, Griqualand East, South Africa. This meteoric iron, found about 1907, is a coarse octahedrite similar in character to Wichita County (Brazos River) and Magura (Arva). On polished and etched surfaces it shows nodules of graphite and troilite, and abundant cohenite crystals arranged parallel to the octahedral bands. It contains about 7 per cent. of nickel.

### Books Received.

British Antarctic Expedition, 1910-1913. Meteorology, vol. 1., Discussion, by Dr. G. C. Simpson. Pp. x+326+v plates. Vol. ii., Weather Maps and Pressure Curves, by Dr. G. C. Simpson. Pp. 138+23 plates. (Calcutta: Thacker, Spink, and Co.)

The Theory of Determinants in the Historical Order of Development. By Sir Thomas Muir. Vol. iii.: The Period 1861 to 1880. Pp. xxiv+503. (London: Macmillan and Co., Ltd.) 35s. net.

Inbreeding and Outbreeding: Their Genetics and Sociological Significance. By Drs. E. M. East and D. F. Jones. Pp. 285. (Philadelphia and London: J. B. Lippincott Co.) 10s. 6d. net.

The Physical Basis of Heredity. By Prof. T. H. Morgan. Pp. 305. (Philadelphia and London: J. B. Lippincott Co.) 10s. 6d. net.

Psychology from the Standpoint of a Behaviorist. By Prof. J. B. Watson. Pp. xiii+429. (Philadelphia and London: J. B. Lippincott Co.) 10s. 6d. net.

The Theory and Practice of Aeroplane Design. By S. T. G. Andrews and S. F. Benson. Pp. xii+454. (London: Chapman and Hall, Ltd.) 15s. 6d. net.

Science and Theology: Their Common Aims and Methods. By F. W. Westaway. Pp. xiii+346. (London: Blackie and Son, Ltd.) 15s. net.

Monarch: The Big Bear of Tallac. By E. Thompson Seton. Pp. 215. (London: Constable and Co., Ltd.) 7s. 6d. net.

Animal Heroes. By E. Thompson Seton. Pp. 363. (London: Constable and Co., Ltd.) 8s. 6d. net.

Farm Management. By J. H. Arnold. Pp. vii+243. (New York: The Macmillan Co.; London: Macmillan and Co., Ltd.) 7s. 6d. net.

Cement. By B. Blount. Assisted by W. H. Woodcock and H. J. Gillett. Pp. xii+284. (London: Longmans and Co.) 18s. net.

### Diary of Societies.

TUESDAY, APRIL 6.  
RÖNTGEN SOCIETY (at Medical Society of London), at 8.15.  
WEDNESDAY, APRIL 7.  
ROYAL UNITED SERVICE INSTITUTION, at 3.—Lieut. W. S. King-Hall: The Submarine and Future Naval Warfare.  
SOCIETY OF PUBLIC ANALYSTS AND OTHER ANALYTICAL CHEMISTS (at Chemical Society), at 8.  
THURSDAY, APRIL 8.  
OPTICAL SOCIETY, at 7.30.  
INSTITUTION OF AUTOMOBILE ENGINEERS (Graduates Section), at 28, Victoria Street), at 8.—W. D. Pile: The Use of Benzol.  
FRIDAY, APRIL 9.  
ROYAL ASTRONOMICAL SOCIETY, at 5.  
CONCRETE INSTITUTE, at 6.—T. J. Clark: The Uses of Concrete.  
MALACOLOGICAL SOCIETY OF LONDON (at Linnean Society), at 6.  
INSTITUTION OF MECHANICAL ENGINEERS (Informal Meeting), at 7.—C. H. Woodfield and Others: Discussion on Cranes: Their Use and Abuse.

### CONTENTS.

	PAGE
The Anti-dumping Bill	125
Science and Scholasticism. By Dr. Charles Singer	127
Ancient Camps in Gloucestershire	128
Principles of Glass-making	128
Physical Chemistry	129
Soils and Manures. By C. C.	130
Our Bookshelf	131
Letters to the Editor:—	
Science and the New Army.—Prof. L. N. G. Filon, F.R.S.; Prof. R. Whiddington; Lt.-Col. E. Gold, F.R.S.; Dr. Charles S. Myers, F.R.S.	133
Knowledge and Power.—L. Bairstow, F.R.S.	135
Museums and the State.—"F.R.S."	136
The Magnetic Storm of March 22-23 and Associated Phenomena.—Dr. C. Chree, F.R.S.; Rev. A. L. Cortie, S.J.	136
Some Methods of Approximate Integration and of Computing Areas.—Prof. J. B. Dale; R. A. P. Rogers	138
Gravitational Deflection of High-speed Particles.—H. G. Forder	138
Colouring Matters of Plants	139
Geodetic Survey in North America. By E. H. H.	141
Science and Research in the Air Service	142
Obituary: Mr. Sedley Taylor. By Dr. Cyril Rootham	143
Notes	144
Our Astronomical Column:—	
April Meteors	149
Spectrum of $\eta$ Argus	149
Infra-red Spectra of Nebulae	149
Hydrographical Studies. By Prof. D'Arcy W. Thompson, C.B., F.R.S.	150
Public Health and Welfare	151
Education of Engineers. By W. C. U.	152
Tropical Control of Australian Rainfall. By W. W. B.	152
Prehistoric Man and Racial Characters	153
A College of Tropical Agriculture	153
Duplex Wireless Telephony	154
University and Educational Intelligence	154
Societies and Academies	155
Books Received	156
Diary of Societies	156

Editorial and Publishing Offices:

MACMILLAN AND CO., LTD.,

ST. MARTIN'S STREET, LONDON, W.C.2.

Advertisements and business letters to be addressed to the Publishers.

Editorial Communications to the Editor.

Telegraphic Address: PHUSIS, LONDON.

Telephone Number: GERRARD 8830.



THURSDAY, APRIL 8, 1920.

**The Universities and the Army.**

**M**ORE than a year ago—on February 20, 1919—an article on "Education in the Army" was published in these columns in which urgent reasons were advanced for a new policy. During the intervening period, numerous contributions have been made to various newspapers and reviews on the same subject, and book has succeeded book animadverting on the educational defects of the Army organisation as revealed by the war. Great disappointment will be felt that these sincere representations have so far produced no more useful result than the Memorandum on the Army Estimates of 1919-20, recently published by the War Office "in amplification of the speech of the Secretary of State in introducing the Estimates." That speech, delivered by Mr. Churchill on February 23, was able and serious within somewhat exiguous limits, but it contributed nothing to the question of educational reform in its military aspects. We are forced, therefore, to turn to the amplifying Memorandum in the anxious hope of finding the question discussed on broad lines and in a scientific spirit. It proves to be a Mother Hubbard cupboard containing only a schoolboy essay freely embellished with mixed metaphors. Thus:

"One of the important lessons of the war has been the extent to which the Army is dependent on the Universities. Great strides were made in this direction before the war, with the result that the Universities responded to the call for help in a splendid manner."

This belated recognition of the valuable work of the Universities in connection with the war is well and fair so far as it goes, but it affords no guarantee to the British public, whose ears are still attuned to the sad diapason of the war's tragedies, that the reorganisation of the Army on its educational side is to be taken seriously in hand. The fact that the Secretary of State, in his speech, found the subject unworthy of even a passing reference is surely disconcerting.

We pointed out recently that the Memorandum deserves to be commended for the proof it affords of the recognition by the Army of the importance of scientific research conducted both under its direct supervision and in our Universities and colleges. Every science and every scientific

worker can make some contribution to national defence.

To give Mr. Churchill his due, he appears to realise the economy of men and money which may result from new applications of science. He quoted in his speech, as an example of the possibilities of the Air Force, the case of the recent Somaliland campaign, which, at a cost of 30,000*l.*, achieved much more than an expedition before the war which cost 2,500,000*l.*; and he described a new form of tank, which, so far from damaging the roads, actually improved them, and possessed an engine which, instead of overheating the interior, exercised a refrigerating effect. But what we ask, and what we shall insist on knowing, is whether this new spirit is to permeate the whole Army, or whether, when the wounds of war are healed and its bitter memories pass into subconsciousness, the Army will revert to its old traditions.

Fortunately for the Army and for the nation, one of the root causes by which these traditions were fed has been effectively removed. Before the war, officers were not paid a living wage, and that system was deliberately perpetuated in order to maintain the tradition of the officer as a gentleman of means and leisure who did half a day's work for half a day's pay. As a writer in the *New Statesman* observed (January 25, 1919):

"It is no use pretending now that the system gave us an efficient Army. One does not gather grapes from thorns. The ablest boys in the country's schools went almost invariably into other callings. Some few officers, with the German menace before their eyes, did indeed work with most praiseworthy, unpaid energy in the years immediately preceding the war. But no gratitude to the 'Old Contemptibles' should blind us to the fact that, however devoted their officers were, they were clearly outclassed as professional men, both by their German opponents and by their French Allies; and that in spite of the unique opportunities afforded by Colonial and Indian war experience."

Under the revised rates of pay of Army officers, a junior subaltern receives pay and allowances amounting to 320*l.* a year if unmarried, or 394*l.* if married, and is able to look forward to generous increments on promotion and to an adequate pension. It will be a breach of trust if, under these conditions, the Army Council does not propose far-reaching reforms as regards standards of education and training for the commissioned ranks.

There is no reason why a standard of professional training at least equal to that required by other professions, such as medicine and engineering, should not be required by the Army, and the only imaginable obstacle to this reform are the protests of old Regular officers, who think that the system which produced them must be the best possible. That particular obstacle has been overcome more than once in the history of the British Army, and it should not deter Mr. Churchill if he will devote to this reform some of the energy which he expends so generously on more forlorn objects.

To pass from destructive to constructive criticism, we would urge that the standard of education represented by three years' study at a University should, as a general rule, be demanded of all Army officers; in other words, that the raw material for the commissioned ranks should be University graduates rather than public-school boys. The military colleges at Woolwich and Sandhurst should no longer be used as seminaries for the elementary education of adolescents.

A great economy of public money would be effected by this simple reform. According to the Estimates for 1919-20, Sandhurst for 700 cadets will cost a gross amount of 195,350*l.*, being 279*l.* 1*s.* 5*d.* per cadet per annum, while Woolwich for 280 cadets will cost 86,850*l.*, or 310*l.* 3*s.* 7*d.* per cadet per annum. It is "pure" education which these young men chiefly require; they should obtain it in the Universities, which can offer a wide variety of curriculum and abundant facilities for social intercourse with all types of student. The University contingents of the Officers Training Corps are admirably adapted for providing elementary military training, which could be supplemented within the Army before and after the student takes his commission. Incidentally, the Army would be able to select for its commissioned ranks mature men possessing a livelier sense of vocation than can be expected from schoolboys.

If the quality of the raw material were improved in the way suggested, there should be no ground for nervousness as to the finished product. Methods could easily be devised of advancing and specialising the military training of these young University graduates. In time a *corps d'élite* would be formed able to study the art of war in all its aspects and to apply new scientific ideas and discoveries to national defence.

### Woods and Water Supply.

*Forests, Woods, and Trees in Relation to Hygiene.* By Prof. Augustine Henry. (The Chadwick Library.) Pp. xii + 314. (London: Constable and Co., Ltd., 1919.) Price 18*s.* net.

PROF. HENRY writes of forests, woods, and trees with an enthusiastic appreciation of the beneficent part they play in the economy of Nature and in the service of man. He has devoted great energy to the study of his subject, and collected data of much value which will prove very useful to those engaged in projects of afforestation in this country. The importance of the subject is, we believe, fully realised by the Government, and Prof. Henry adduces so many instances of local authorities which have begun to move in the matter that we may hope to see the restoration of the woods on waste lands making steady progress year by year.

The book before us is an amplification of the Chadwick Lectures delivered by Prof. Henry at the Royal Society of Arts in 1917, and the author no doubt looks upon it in large measure as propaganda in the cause of tree-planting on a national scale. The first three chapters, however, deal with matters of profound scientific importance—the influence of forests on climate, the sanitary influence of forests, and forests as sites for sanatoria. These are difficult matters, as Prof. Henry fully realises, and some of them have agitated students of physical geography for generations. The difficulty of the question of the influence of forests on climate arises in great measure from the fact that climate has a great influence on forests, so that in wooded areas the interplay of cause and effect becomes extremely complicated.

Prof. Henry has read up the subject widely, but the nature of his book makes it impossible for him to focus the results sharply enough. He abundantly justifies the thesis that an increase of forest growth is of national importance for improving the hygiene and the economic condition of this country; but he scarcely attempts a scientific demonstration of the mechanism by which the beneficial effects are produced. He does, indeed, direct the attention of his readers to many recent investigations which it is most useful to have brought together, and for this guidance the student who wishes to go farther should be sincerely grateful.

We cannot, however, accept the results of some of the series of observations referred to without a more critical discussion of the methods employed and the data recorded in different parts of the world. In particular we agree with Prof. Henry in his opinion that the effect of afforestation in

increasing—the general rainfall is probably negligible in the British Isles.

The greater part of the volume is devoted to a question of national importance—the afforestation of water-catchment areas, with particulars of the extent to which the work has already proceeded. This is timely, for the whole question of the water resources of the country is now under investigation by a Committee appointed by the President of the Board of Trade and the Minister of Health. Prof. Henry shows clearly that the gathering grounds for the reservoirs of water supply by gravitation are well fitted in almost every case for planting with timber-trees up to an elevation of 1000 ft., and he adduces some evidence to show that covering a certain proportion of the surface with forest growth, so far from being detrimental to the yield of the areas, is even helpful. Curiously enough, he does not refer to the important influence of high vegetation, and especially of trees, in precipitating moisture from mist, a phenomenon which is shown very strikingly when one is traversing a road through a wood in a thick mist. The road remains perfectly dry, while the drip of water from the branches on either side gives out the sound of abundance of rain, and the ground beneath the trees soon becomes saturated. As Dr. Marloth proved on Table Mountain many years ago, even such inconspicuous growths as a bed of reeds can draw liquid streams from a cloud drifting along mountain slopes which would deposit nothing on a bare stretch of soil or rock. No doubt a certain amount of water is in this way added to a forest-covered catchment area without being recorded in properly exposed rain-gauges.

On the other hand, if, as certain experiments made in Germany and quoted on p. 3 seem to suggest, the transpiration of forest trees is greater than the evaporation from an exposed water surface, the net result may be to reduce the amount of water reaching a reservoir, and this might be a serious matter in a dry summer. Even if we admit that afforestation does not appreciably increase the available run-off, it seems unlikely that it can seriously diminish it, and the balance of probability is that planting a water-catchment area is beneficial. A wide belt of woodland surrounding a reservoir must reduce the wash of surface material into the streams, and so retard the silting up of the reservoir. But, what is more important, the value of the forests when once established will justify the acquisition of the whole drainage area of their water supply by authorities which could not otherwise justify the expense of such a step; and it is only on ground

which is the property of the water authorities that it is possible to keep the area free of population or of farm stock, and so secure the water absolutely from all sources of pollution.

This is scarcely the place to criticise the list of catchment areas for water supply in the United Kingdom, which fills 135 pages, and appears to be based on official figures; but one cannot help regretting that the data quoted are not more homogeneous. Rainfall figures, for instance, are given only in some cases, and even then they are often misleading from the lack of information as to how the average was computed. The responsibility for this is on the local authorities themselves, and we can only thank Prof. Henry for his diligence in bringing so many facts together that the room for improvement in the form of statement stares one in the face. No remedy for these ill-assorted statistics can be found until some central water authority comes into existence which can co-ordinate all the local efforts in accordance with one national and scientific system. One slip, however, should be corrected—the allocation of Haweswater to the supply of Penrith on p. 175 and on the map on p. 173. This should be Hayeswater, a small tarn lying between Haweswater and Ullswater.

HUGH ROBERT MILL.

### The Wilds of South America.

- (1) *In the Wilds of South America: Six Years of Exploration in Colombia, Venezuela, British Guiana, Peru, Bolivia, Argentina, Paraguay, and Brazil.* By Leo E. Miller. Pp. xiv + 428. (London: T. Fisher Unwin, Ltd., 1919.) Price 21s. net.
  - (2) *University of Pennsylvania. The University Museum Anthropological Publications.* Vol. ix., *The Central Arawaks.* By William Curtis Farabee. Pp. 288 + xxxvi plates. (Philadelphia: The University Museum, 1918.)
- (1) **M**R. MILLER'S well-illustrated book is the attractively written personal narrative of seven exploring expeditions to South America, all but one sent out by the American Museum of Natural History, mainly to collect mammals and birds.

There are few wild countries left which have not been ransacked with the hope that the amassed specimens may include some species "new to science," but there are still fewer the fauna and flora of which have been correlated intelligently with scientific observation of the prevailing environmental conditions. Several American museums stand in the front rank of such

enterprises, well planned, with, perhaps, restricted but intense purpose. Mr. Miller, of the American Museum of Natural History, was a member, or the leader, of these expeditions, which from the spring of 1911 to the beginning of 1916 covered an enormous amount of ground: Colombia, in which faunistic paradise alone he spent nearly two years; Venezuela and British Guiana; Bolivia and Argentina; and Roosevelt's famous journey. It is worth noting that our active author finished this book in an aviation concentration camp preparing to "do his bit."

This narrative contains no tedious itineraries. It is a condensed account of, in the aggregate, five years' travelling, with many hundreds of episodes, observations, and reflections, which cover a very wide field, from old churches to local industries, people and scenery, plants and creatures, just as he happened to come across them. There are no blood-curdling incidents, although he had his fair share of danger. Since we are taken through steaming-hot tropical lowland forests, over rivers by raft, canoe, or steam launch, across desert plateaux on to snow-covered mountains, to wild natives and modern towns, a few bare samples or headings must suffice to indicate the range of the work:

A successful search in the highlands of Colombia for the "Cock-of-the-Rock," of which beautiful bird's home life, nest, and eggs little was known. Humming-birds becoming intoxicated with the sap of some tree tapped by woodpeckers. A study of the different modes of feeding of various birds as observed side by side: the parrots climbing to the tip of the fruit-laden branch; the large-billed toucans are enabled to reach a long distance for the coveted morsel, whilst the trogons, with short neck, delicate feet and bill, hover about the fruit. Whilst one river was muddy and potable, another, close by, had clear red water, unfit for drinking, and it contained only a few kinds of fish, but no crocodiles, sandflies, or mosquitoes were about.

Mr. Miller suggests that monkeys may keep the malaria infection alive in districts which, because of this plague, are practically uninhabited by human beings.

In some parts of Bolivia vampires were so common and so little shy that the author was able not only to watch their biting and sucking, but also to sweep them off the mule with a butterfly-net—a feat which frightened the suffering beast so much that it sank to the ground with a groan.

The Sirionó tribe in the same country use bows so powerful that the hunter has to lie down, to grasp it with the feet, and to draw the cord with both hands. They are fierce savages, not "Indios reducidos"—i.e. not yet broken and cowed—and

no wonder. They had fixed some *protégés* of a mission station to trees by means of numerous long thorns. The padre in turn had seven captives tied to posts, and after four of them had died from starvation and sullenness, the priest took pity upon the remaining three and released them.

As usual, the Indian's mind is rather perplexing. A woman asked the exorbitant price of 4 pesos for a fowl, which she said was a first-class game-cock; when told that the bird was wanted for food only, she at once parted with it for 60 centavos.

On a sandstone plateau, at an elevation of 13,400 ft., was growing the gigantic "Puya," one of the Bromelia family, and humming-birds (*Patagona gigas*) hovered over its numerous flowers.

Monstrous lies grow sometimes from a grain of truth, and so do colossal horned snakes in Brazil. Their size at least is proved by a cunning mixture of circumstantial evidence and further reflection: for instance, the discovery by trustworthy hunters that the so-called horned snakes are really not horned creatures, but such as have swallowed an ox tail foremost, the spreading horns ultimately lodging crosswise in the corners of the mouth—quite a sufficient explanation in countries where anacondas are said to grow to 40 metres in length. But there are also very many observations and valuable reflections by the author himself, frequently concerning the supposed working of natural selection. For example, if the struggle for existence is as keen as is often thought, how can the female insectivorous bat, encumbered with her baby fully three-quarters as large as herself, compete successfully with the unhampered males?

There is also an important account of the cowbird's (*Molothrus*) parasitic habits, compared with which those of our own cuckoo seem insignificant, dozens of eggs being dropped into a single nest of the Owen-bird (*Furnarius*), so that the latter deserts it.—That human curse of the tropics, the plume-hunters, in Paraguay and elsewhere, now scatter poisoned fish over the egret's feeding-grounds during the breeding season.

(2) Mr. Farabee's work on the Arawaks is one of the volumes containing the results of an expedition, from 1913-16, sent to South America by the Museum of the University of Pennsylvania. It deals in detail with the Arawak tribes, their somatic characters, mode of life, traditions and beliefs, ornaments, weapons and other implements. One hundred pages are devoted to the language.

The general account is most interesting reading, but the book is really intended for the specialist.

There are, however, no fewer than thirty-six plates of excellent photographs, notably those which represent the people and their mode of life. The greater number of Arawaks inhabit the savannahs of southern British Guiana and the neighbouring parts of Brazil. The largest of the tribes is that of the Wapisianas, and they number only about 1200. Others amount to fewer than one hundred each, all rapidly decreasing.

Mr. Melville, magistrate and protector of Indians, has lived amongst them for twenty-five years, guarding them from the unscrupulous exploiter. "No traders or missionaries have yet established themselves amongst them, hence their natural honesty, their simple purity, and their primitive religious ideas have not been destroyed."

The author says that the coincidence between our classical and the Wapisiana interpretation of the zodiacal and other constellations is not to be wondered at. To call Orion the warrior is obvious enough. But the Pleiades are "the turtle's nest full of eggs and father of the rains," the beginning of the June wet season. Spica is the corn-planter; Scorpio, the anaconda; and Antares, the scorpion's heart, a red macaw swallowed by the snake.  $\alpha$  Cygni is the kingfisher.  $\alpha$  and  $\beta$  Centauri are a hunter with his wife.

### Life and Temperature.

*Action de la Chaleur et du Froid sur l'Activité des Êtres Vivants.* By Georges Matisse. Pp. ii + 556. (Paris: Emile Larose, 1919.)

**M.** G. MATISSE has brought together in book form researches made by him on the influence of cold and heat on living organisms. He reminds us of the famous experiments of the Abbé Spallanzani, prince of biologists, who showed that dry rotifers could be submitted to temperatures far below zero and up to  $62.5^{\circ}$  C., and yet return to active life on wetting. Pouchet tells of the strange views which were mooted concerning the death and resurrection of these animals and others experimented upon by Spallanzani, and how Fontana, for fear of the Inquisition, experimented in secrecy, while the Abbé fearlessly published his results and speculations. Spallanzani crushed frozen eggs of insects with the finger-nail and found that small drops of liquid exuded. Life is preserved in this fluid, a "superfusion" of the colloids and electrolytes of protoplasm, the water freezing out. He found seventeen was the greatest number of freezings and thawings which any rotifers, Tardigrades, or Anguillula withstood. Gradual thawing is essential for the preservation of life. Pictet successfully

froze and thawed frogs and fish. Spallanzani was the first to sterilise infusions by heat.

M. Matisse recalls Ehrenberg's observations on oscillaria, infusoria, and rotifers living in hot springs in Ischia at  $81-85^{\circ}$  C.; life in similar conditions, he says, is found in the Yellowstone Park, Wyoming, U.S.A.

We now know that spores of bacteria withstand  $100^{\circ}$  C. more than sixteen hours,  $115^{\circ}$  C. from thirty to sixty minutes, and  $140^{\circ}$  C. one minute. Not only does temperature count, but also time. Claude Bernard found that pigeons and guinea-pigs died in six minutes when put in a dry oven at  $90-100^{\circ}$  C., rabbits in nine minutes, and dogs in eighteen to thirty minutes. A woman stayed twelve minutes in an oven at  $132^{\circ}$  C. without being strongly incommoded. Pouchet mentions a man who, at the old Cremorne gardens, walked through a perforated metal tunnel which was surrounded with burning brushwood.

Adaptation to temperature is of considerable interest. Paul Bert found that fish, raised quickly from  $12^{\circ}$  to  $28^{\circ}$  C., died, but that, raised slowly  $2^{\circ}$  C. a day, they survived up to  $33^{\circ}$  C. Tadpoles, kept a month at  $15^{\circ}$  C., died at  $40.3^{\circ}$  C.; others, kept at  $25^{\circ}$  C., died at  $43.5^{\circ}$  C. (Davenport and Castle). Snails survive exposure to  $-110^{\circ}$  to  $-120^{\circ}$  C. for weeks. Spallanzani showed that their respiratory exchange and circulation cease entirely in the cold. Protozoa survive  $-200^{\circ}$  C.; bacteria,  $-250^{\circ}$  C. for ten hours (MacFadyean).

Seasonal polymorphism depending on temperature is of interest—e.g. aphids are wingless, and reproduce parthenogenetically in the summer; it becomes winged, and male and female in form, with sexual reproduction, in the autumn. Papilio *Vanessa porosa*—*levana* has spring and summer forms. Salamanders, on the high Alps, are small and black, and have only two young, which are born without branchiæ; those on the plains are large, blotched with yellow, and have many young born with branchiæ. Inversion of the climatic conditions reverses the characteristics of these two forms (Kammerer). Tower submitted Coleoptera (*Leptinotarsa decemlineata*) at the time of formation and maturation of sex elements to  $35^{\circ}$  C. and dry conditions. The eggs hatched in normal conditions showed eighty-four mutations in the ninety-eight individuals which reached adult age.

A gasteropod, *Lymnea stagnalis*, reproduces its kind in water cooler than  $12^{\circ}$  C., but the progeny are small. In water at  $15-18^{\circ}$  C. the progeny are larger. The character of smallness becomes fixed; small individuals transported from cold to warmer water continue to have small progeny (Semper).

The main part of Matisse's book deals with the consideration of the law of van't Hoff and

Arrhenius concerning the acceleration by temperature of the velocity of chemical reactions, and the relation of this law to biological functions. The author has carried out a large amount of experimental work and correlated it with that of others.

There is an increase, an optimum, and a decrease of many biological functions with temperature, and in several cases the increase over a certain range is comparable with that of a chemical reaction—e.g. the segmentation of an ovum, the beat of the heart, or ferment action. The reactions of the living animal are, however, too complicated to come under any simple law.

### A University Course in Botany.

*Botanical Memoirs.* No. 4: *Elementary Notes on Structural Botany.* By A. H. Church. Pp. 27.  
No. 5: *Elementary Notes on the Reproduction of Angiosperms.* By A. H. Church. Pp. 24. (London: Oxford University Press, 1919.) Price 2s. net each.

CONSIDERABLE interest has been shown during the past two years in the reconstruction of botanical teaching at the universities, and it seems opportune, therefore, that one of the older universities should publish in some detail the plan on which its instruction in botany is based in so far as it relates to the elementary courses in this subject. We gather from the concluding note of Memoir 4 that the notes have been written as schedules to accompany, and not to replace, lectures, it being assumed that the lecturer can add explanatory emendations and enlargements on special points. No doubt every teacher will have his own views as to the arrangement of the subject-matter of an elementary course, and will desire to give special emphasis to certain aspects, which he will do by the prominence assigned to such parts of the subject. A somewhat general feeling has been expressed in the recent correspondence on botanical teaching in the pages of the *New Phytologist* that physiological botany has not always received adequate attention or treatment in botanical teaching.

From that point of view it will be noted with interest that the Oxford course of instruction begins and ends in biological features, and is well permeated with physiological considerations. On the whole, however, it may be considered a morphological treatment of the subject, as, indeed, the title "Structural Botany" indicates, though it is apparent that, as in most elementary courses, structure is considered in the light of the functions

which the various organs have to perform. Occasionally this mode of treatment might be more closely adhered to. On p. 6, for instance, in dealing with the stem of *Helianthus*, it is mentioned that the endodermis is "in this stem curiously the only layer with starch," and no reason for this phenomenon is advanced or even suggested at this stage, though much later in the course (p. 24) "falling starch" is referred to as popular since 1900 as hypothesis of statocyte nature.

In connection with the palisade mesophyll no allusion is made to the function of this tissue, nor are any special reasons adduced for the shape and arrangement of its cells. The same criticism applies to the paragraph dealing with the spongy mesophyll. The main criticism, however, which anyone familiar with the difficulties of instructing students within a severely limited time will level against the course is that it attempts too much within the period indicated by the author as available. Considerably shortened, the course might gain in thoroughness of treatment what it would lose in extensiveness. Interesting and enlightening, for example, as are the leaves of *Ficus* and *Nymphæa*, the structure and function of a leaf may be learnt from the cherry laurel alone. Similarly in Memoir 5, some of the seeds mentioned, like those of *Aucuba*, *Æsculus*, *Juglans*, and *Hedera*, are not essential to the proper understanding of the structure of a seed in addition to the two or three more common types. These are only a few of many passages which might be curtailed. No doubt the better plan would be to retain the fuller course and to demand a longer period for instruction, and we heartily sympathise with the author's difficulties when required to supply what he calls "minimum botany" for his students. Possibly under the new régime at Oxford this may be remedied. If the facts are as stated in the concluding paragraph of Memoir 5, it is, as the author says, remarkable that in a university of primary importance the teaching of plant biology should be of such a meagre description. We fully share the author's conviction that a knowledge of life in some form should be part of the mental equipment of every educated person.

### Recent Mathematical Text-books.

- (1) *Unified Mathematics.* By Prof. L. C. Karpinski, Prof. Harry Y. Benedict, and Prof. John W. Calhoun. Pp. viii+522. (Boston, New York, and Chicago: D. C. Heath and Co.; London: George G. Harrap and Co., Ltd., 1918.) Price 10s. 6d. net.

- (2) *Elementary Calculus*. By C. H. P. Mayo. (With answers.) Pp. xx + 345 + xxxix. (London: Rivingtons, 1919.) Price 10s.
- (3) *Mensuration for Marine and Mechanical Engineers*. (Second and First Class Board of Trade Examinations.) By John W. Angles. Pp. xxviii + 162. (London: Longmans, Green, and Co., 1919.) Price 5s. net.
- (4) *School Mechanics. Part 1. School Statics*. By W. G. Borchardt. (Without answers.) Pp. viii + 266. (London: Rivingtons, 1919.) Price 6s.

(1) THIS text-book by three American authors is best described as an elementary mathematical *mélange*. It ranges over a variety of topics, but does not deal explicitly with the calculus, though the fundamental process of the latter is used. Great pains have obviously been expended on the compilation, but it can scarcely be described as an inspiring volume, and is not likely to find favour in British schools and colleges. The authors state in the preface that they desire to emphasise the fact that mathematics cannot be artificially divided into compartments with separate labels, and that they aim at showing the essential unity, harmony, and interplay between the two great fields into which mathematics may properly be divided—namely, analysis and geometry. It is to be feared that those who are to become competent mathematicians must continue to study the subject in compartments, carrying on, of course, several sections simultaneously, leaving familiarity and time to show the inter-relationship. None but the finished scholar can fully appreciate and realise the intertwining of the branches. Only those who reach the hill-tops see the harmony of the landscape and the trend of the watercourses. There are several interesting diagrams and historical references, and also a number of good examples. The volume is well got up and printed.

(2) Mr. Mayo's well-printed and finished book is meant for beginners, for general use in schools, to be within the capacity of the average boy, and also to meet the first requirements of those who intend to specialise in mathematics. That the book will realise all these aspirations is unlikely. So early as p. 6 it presents the beginner with the

expression  $\lim_{x \rightarrow 1} \frac{x^2 - 1}{x - 1} = 2$ , and discusses arithmetical approximations and negligible quantities. The introduction to the subject is of that kind which always leaves the student with the uneasy feeling that the calculus is not quite all right, and gives results just a little out. It is the belief and experience of the reviewer that the opening pedagogics of the calculus must be simple and not over-refined. The easy processes of finding the

gradients of chords of curves of the system  $y = x^n$  and of deducing therefrom the gradients of the tangents are about all that the average boy can grapple with for a considerable time. The notation can be explained concurrently, and a few easy steps lead on to simple integration and easy applications. Geometry and intuition must be relied on to give the start. The philosophy of the limit is beyond the ordinary pupil. From the school point of view the book covers a fairly wide range, including triple integrals, singular points, partial differentiation, and differential equations. There are many good examples in it, derived from geometry, physics, mechanics, etc., all likely to stimulate a smart boy. In fact, it will probably succeed much better as a second than as a first course.

(3) This is a book on mensuration intended for the use of engineering students of various kinds, as, for example, marine engineers preparing for the First and Second Class Board of Trade Examinations and for the Extra First Class Examination. It deals in a thorough way with the ordinary elementary areas and volumes, such as those of the rectangle, circle, ellipse, sphere, cone, and cuboid, refers to the planimeter, explains Simpson's Rule, and discusses valves, specific gravity, flow of water, etc. It includes also some calculus and the theorems of Pappus. There is an abundance of good examples in the book, both worked and to be worked, so that any student who goes through it conscientiously should conclude his examinations successfully.

(4) Mr. Borchardt's book is part 1 of a School Mechanics, and deals with statics. It is intended for the use of pupils preparing for the higher mathematics, for entrance to Woolwich and Sandhurst, and for the Senior Cambridge Local Examination. The matter is arranged under the following heads, according to the sequence given: the lever, the parallelogram of forces, friction, work and machines, centres of gravity, couples, and general equilibrium. Then follow laboratory problems and test papers. There are plenty of illustrative examples in the text, and a copious supply for the exercise of the student, mostly of a numerical type. If the treatment of the subject presents no fresh or original features, the book is one which can safely be used. J. M.

#### Our Bookshelf.

*The Romantic Roussillon: In the French Pyrenees.*

By Isabel Savory. Pp. xii + 214 + xxvi plates by M. Landseer Mackenzie. (London: T. Fisher Unwin, Ltd., 1919.) Price 25s. net.

THE author of this excellently printed work will not mind our saying at the outset that one of its chief charms is the series of pencil drawings by

M. Landseer Mackenzie. In architecture they give exactly what the trained eye would have us see; in landscape, as in "The Harbour at Callioure," an exquisite sense of atmosphere is conveyed—and, unfortunately, this is the only landscape in the book. The travellers had no high aim in art, history, or geography. They went to this inlet of the eastern Pyrenees because it appeared romantic at a distance. They found it less romantic, but full of charm, the charm that is rarely absent in provincial France. They wandered on foot, and made a spirited ascent of Canigou; but their real interest lay in the old-world villages, the hospitable reception at inns that treat the visitor as a friend, and the general air of remoteness in a land where Catalan is common speech. In history the Roussillon has had no special voice as to whether it should belong to France or Spain. To-day it may well be proud that its lot has lain with France. Was not Marshal Joffre, *le grand-père*, born at Rivesaltes, where the wind blows in across a great lagoon upon the frontier, a relic of the Pliocene sea that once stretched up among the hills? From Roussillon also came Commandant Raynal, the hero of the Fort de Vaux at Verdun, and many a stout defender of the northern lines.

The author, however, is not concerned with such modernities. We gather that her pleasant pilgrimage was made before the war turned all minds to other fields in France; but now the land lies once more open to adventure, and conditions of travel, as we are assured by high authority, are already settling down on their old attractive lines. Naturalists are also artists, and they may well practise their art among the eastern spurs of the Pyrenees.

G. A. J. C.

*The Journal of the Institute of Metals.* Vol. xxii. No. 2. 1919. Edited by G. Shaw Scott. Pp. xii + 428 + 31 plates. (London: The Institute of Metals, 1919.) Price 31s. 6d. net.

THE new volume of this journal opens with a report of the May lecture delivered by Prof. Soddy dealing with the subject of radio-activity. The remainder consists of the papers read at the Sheffield meeting of the institute. Of these the most discussed was one by Dr. Hatfield and Capt. Thirkell on season-cracking, in which a different view is taken from that recently put forward by Rosenhain and Archbutt, and experiments are made to determine the intensity of the internal stress in the case of cold-worked brass. The conclusion is drawn that such stresses approach very closely to the maximum stress which the material is capable of resisting. The mercury salt method has been found very useful for revealing the presence of internal stress. Some very remarkable alloys are described by Dr. Stead. Alloys of tin, antimony, and arsenic, within certain limits of composition, have the habit of forming spherical segments of striking regularity. Dr. L. J. Spencer gives a summary of the information as to the occurrence of strongly curved crystals

in minerals, but no satisfactory explanation has yet been given of the conditions under which such curved growth takes place.

The second report to the Beilby Committee on the solidification of metals describes the isolation of crystal grains from certain metals, and a comparison of their form with that of foam cells, the facts pointing to the importance of the share taken by surface tension in determining the grain boundaries. The remaining papers deal with the early history of electro-plating, the properties of standard silver, and the structure of bearing metal, Britannia metal, nickel silver, and duralumin, and the characteristics of moulding sands for non-ferrous work.

C. H. D.

*Applied Botany.* By G. S. M. Ellis. Pp. viii + 248. (London: Hodder and Stoughton, 1919.) Price 4s. 6d. net.

This book is one of a "New Teaching Series" of which the publishers state: "The Series has been written by Teachers possessing valuable practical experience and gifted with the inspiration of the hour's occasion." The "secrets of plant life" are said to be "the substance of this extraordinarily interesting volume." On p. 84 the author informs us that "clover is liable to clover-sickness. Turnips suffer from the finger-and-toe disease. These diseases are caused by bacteria"; and later we learn that Desmids and Conjugate Plants are without chlorophyll. Treating of the enemies of plants, the author writes: "Bacteria turn the living tissue to a slimy and often smelling pulp. The effect is very similar to decay." The problems of potato blight have apparently been solved, for we are told that the hyphae "penetrate the stem and reach the tubers," and "during the winter resting spores of the fungus remain in the ground and attack the next season's crop." Wart disease is a simple matter, infected soil merely being "treated with sulphur and gas lime." Potato-leaf curl is still due to *Macrosporium solani*, and winter rot to *Nectria solani*.

These are but a few of the "secrets of plant life" which are "the substance of this extraordinarily interesting volume." In addition, however, there are many sentences such as the following: "Free-swimming plants, like Chlamydomonas, must have water in which to swim"; and it is with a sorrowful interest that we read: "Very attractive and useful work may be done by studying the development of fruit, and how the seed is in the end successfully disseminated. The student who undertakes this kind of inquiry becomes at last a worthy biologist." The rest of us must learn to bear our cross with resignation.

W. B. BRIERLEY.

*Rückläufige Differenzierung und Entwicklung.* By Adolf Cohen-Kysper. Pp. 85. (Leipzig: Johann Ambrosius Barth, 1918.) Price 3 marks. This book is a further attempt to reduce all life phenomena to mechanical principles. It announces an "ontogenetic law" worded as follows: "The part returns to a phase from which the whole is developed anew."



### Letters to the Editor.

[The Editor does not hold himself responsible for opinions expressed by his correspondents. Neither can he undertake to return, or to correspond with the writers of, rejected manuscripts intended for this or any other part of NATURE. No notice is taken of anonymous communications.]

#### Knowledge and Power.

THE question raised in the leading article on "Knowledge and Power" in NATURE of March 25 is of great interest and importance. It is nothing more nor less than the question of using experience as a guide to action, which is the whole purpose of education. The suggestion that its solution requires a fundamental change in the organisation of the Civil Services in order that the best advantage may be obtained for the country from the special knowledge and training of the expert brings to a focus the essential difficulty of the subject. I suppose that the real function of any Department of the Services, civil or military, is to carry out the policy of the Government as formulated or approved by the responsible Minister; and the staff of the Department is recruited in such a way as to secure that object. The knowledge in the light of which the Minister's policy is formed is another matter. It may be taken for granted that if it is well advised, the Government will utilise all the best technical knowledge available. A Minister may find it in special sections of his own Department, or he may try to acquire it from outside. No doubt he is largely guided by his chief permanent officers, and they in turn must use their own knowledge and that of their subordinates or obtain what they can get from outside. How effectively to provide a Minister with all the pertinent experience about technical problems is not an easy question. It is made still harder by the fact that even for experts the recognition of the value of new knowledge is not necessarily automatic. The reception that was given to Thomas Young's theory of light is a reminder for all time that new ideas require favourable environment for assimilation. Consequently, some knowledge of what the world is made of is necessary for all executive authorities. But that, as Kipling says, is another story.

Suppose we picture to ourselves the difference between a youth's progress in the Civil Service and in the career of an expert in science. The Civil Servant is selected by open competition in subjects which may include literature or science; but from the time of his joining the Service the pursuit of either ceases to be a part of his working life, though either may be followed as a hobby. He must leave even his political opinions at home and begin to learn the art of giving expression to the policy of the Department which he joins. He learns from his immediate superiors how things are done. Why they are done does not concern him. He learns also the discipline of a public office and the art of formulating documents for his superior to sign. His opportunity is to make himself so loyal and so efficient in carrying out the policy that any chance of promotion that comes his way is not lost. If he has lofty ambitions beyond his own steps in the Service, he must postpone them until he reaches a position in which he can gain the Minister's ear. Up to that time his life is a life of self-effacement.

The history of the expert is altogether different. His training leads him to begin his career in research, and if he is successful he attains the unspeakable satisfaction of having discovered for himself something of real importance. Thereafter he has always

ideas of his own which he strives to realise, and as his experience grows he forms lines of policy for himself, and is not very tolerant of others. His career is one of continuous self-assertion from the beginning. He may derive his ideas from instruction or inspiration, but the expression of them is his own; and what may be only the natural expression of his genius may look like disloyalty to his superiors in the world of red tape.

The positions of the two types with regard to finance are equally diverse. The Civil Servant has no difficulty in establishing the position that as the Minister wants things done he will, of course, be prepared to provide adequate remuneration for those who carry out his wishes. Money is therefore forthcoming. But the expert has to convince the Minister, or persuade someone else to do so, that his projects are worth trying in the public interest and can be justified in Parliament. He has to ask for permission and facilities for research, the results of which are, *ex hypothesi*, unknown; to ask for pay in addition is to invite refusal of everything.

Moreover, the discipline of a body of experts is quite different from that of a public office. What is wanted from an expert is his own spontaneous opinion as a guide to action—a something which a Civil Servant is not expected to possess. It seems to follow that experts and Civil Servants are as different as oil and vinegar, and the endeavour to mix them promiscuously in one organisation will not work. They belong to different atmospheres; what stifles one gives buoyancy to the other.

Somehow or other an advisory side for formulating policy ought to be organised on different lines from those of the administrative side which carries out the policy. But if there is a separate organisation on the technical side it ought to have direct access to the Minister finally responsible, and not be fenced off from him by a secretariat trained on different lines. There are sure to be misunderstandings and ultimate despair if all the work of a professional technical staff has to pass upwards and downwards through the refracting and distorting medium of an inexperienced secretariat. The scheme of organisation must be in sectors reaching continuously from the Ministerial centre to the circle of recruitment. The technical staff itself will want the assistance of "civil servants" content to follow out the policy which is indicated. The mischief begins when the Civil Service forms a complete belt in the inner regions of the organisation. In that case an inexperienced Minister is completely surrounded by inexperienced advisers, and then power is cut off from knowledge.

F.O.I.

THE vast conflagration of the late war rendered conspicuous many truths that were little suspected by the majority, and not the least of these was the importance, the necessity, of organised and accurate scientific knowledge and research for national success. Unfortunately, this is already in danger of being forgotten while we are engaged in the strenuous task of preserving for our country its due and fitting place in the industries and activities of the world, and the leading article in NATURE of March 25 has sounded a very necessary note of warning. It rightly emphasises the need that the ultimate administrative authority should be vested in men with technical knowledge and experience, and not in Civil Service officials appointed originally, for the most part, on the basis of purely literary attainments. This authority will, however, never be conceded to the man of science until the scale of his remuneration corresponds to the importance of his work. It was repeatedly

demonstrated during the war that scientific men who from motives of patriotism accepted a low scale of salary for their services in Government Departments were accorded an equally modest official status.

The ultimate basis on which an adequate recognition of the importance of the scientific technical expert must rest will be the estimation in which science and scientific research are held by the great mass of intelligent men and women. It must be realised, in the first place, that a training in science on the right lines and under the right men will be as efficient in broadening the outlook on the world and stimulating the imagination of the student as a detailed study of the vicissitudes of ancient wars or the eccentricities of Greek and Latin irregular verbs. It must also be recognised that no course of science can be considered complete unless it has included a session at least spent in scientific research, humble though it may be and directed by more experienced workers. But it must be genuine research, not merely a "heuristic" imitation of the real thing.

The more science graduates who have learnt to understand what research means there are scattered about the country—in factories, in counting-houses, in Government offices, in educational establishments of every kind, and, most important of all, in municipalities and legislative bodies—the wider will be the recognition of the value of science.

Unfortunately, scientific studies are seriously handicapped in the competition for university students by the fact that the fees are, as a rule, distinctly higher than those for arts. There is, therefore, a strong pecuniary inducement for parents to select an arts rather than a science curriculum for their children. Such a handicap is obviously opposed to the national interest, and should not be allowed to continue.

In view of the urgent reasons for associating research with higher scientific education, it is to be regretted that the general tendency of Government policy should be to divorce industrial research from the universities and to place it in the hands of associations of commercial firms. The discoveries that open up new lines of development in great manufacturing industries are arrived at by processes essentially similar to those that lead to advances in pure science, and if we are to get the best results it will be by the co-operation of the vigorous university life which has sprung up in recent years at so many centres in busy industrial districts with the commercial enterprise in its vicinity.

Finally, if we are to secure to science its full weight in the councils and policy of the country, we must not confine our propaganda to the "governing" or upper classes, or to the ranks of professional workers, or to those engaged in commercial pursuits, but we must develop by all the means in our power a love of science in the great army of the manual operatives, whom it would seem that in a not distant future we shall, willingly or unwillingly, have to acknowledge as our masters. With their increased leisure there should be no difficulty in enlisting a large contingent of men and women who will be interested in science, either for its own sake or for its value in enabling them to understand the meaning of the work in which they are engaged. Some of them will in all probability definitely embrace a scientific career, and in this they should receive every assistance and encouragement, while others will render no less service as amateurs and as missionaries of science among their fellows. Already, I am told, a great deal is being done in this direction in connection with University College, Nottingham, and no doubt much is being accomplished on similar lines at the Midland and Northern universities. At present the operations of the Workers'

Educational Association are largely confined to the somewhat restricted domains of constitutional law and history and political economy, but a few years may see a great development of more stimulating and attractive studies in the broad realms of science.

March 31.

JOHN W. EVANS.

### The Secondary Spectrum of Hydrogen.

THE recent investigation by Dr. Merton of the effect of an admixture of helium on the intensity distribution in the hydrogen spectrum appears to have given a very strong clue towards the elucidation of that spectrum. On the photographs taken by Dr. Merton (reproduced in part in Proc. Roy. Soc., October, 1919) the spectra appear completely different in the cases of pure hydrogen and of hydrogen mixed with helium. Many lines, in the first case quite strong, are totally absent in the second; others remain practically unaltered in intensity; while a third set appears in the second case, though practically or completely invisible in the first. Such results seem, at first sight, to point to the existence of at least three classes of lines which are mutually independent, one class being unaffected by helium and the others affected in opposite senses.

A somewhat exhaustive investigation which I have made recently in regard to these photographs, kindly lent to me by Dr. Merton, and the previously published tables of the spectrum has convinced me, however, that this interpretation is not the correct one. It was known already that the secondary spectrum of hydrogen contained two sets of lines, one showing, and the other not showing, the Zeeman effect. A third and doubtful set were abnormal in regard to the Zeeman effect. Dufour examined many of the strong lines in the spectrum, and, although his investigation needs still to be extended much further, a considerable amount of exact knowledge of individual lines is available.

Fulcher also had previously investigated the low-potential discharge in hydrogen, and isolated two band spectra peculiar to this discharge, which spectra we may call the Fulcher bands. They differ from more ordinary bands in their large component separations, and their most important part is in each case a set of triplets which recur towards the red end. Although they do not readily fit the Deslandres type of formula, I have been able to establish a mathematical relationship between the two bands, from which it appears that they must be considered jointly as one band. In addition to the triplets there are many associated sets of single lines, which Fulcher considered, on experimental grounds, to belong to the same band system.

Dr. Merton's results have made a valuable contribution which enables us to isolate these Fulcher bands completely from the rest of the spectrum.

The conclusions at which I have already arrived may be summarised as follows:—

The secondary spectrum of hydrogen consists of a set of band spectra—how far divided into sets which are mutually independent in the mathematical sense is uncertain, but at least partially so divided—together with a superposed spectrum of single lines. The band lines are those which show no Zeeman effect, and the lines of the superposed spectrum all show the Zeeman effect. This general statement still requires considerable experimental work to establish its complete truth, but the evidence so far available is sufficient to leave little doubt in the matter.

Dr. Merton's spectra, taken in the presence of helium, preserve what I have called the superposed

spectrum without much change of intensity, and it is undoubtedly due, on all grounds, to a different atomic or molecular mechanism from that producing the bands. This supposed spectrum exhibits very pronounced "constant frequency difference" effects, and there is good reason to believe that sets of series spectra of the ordinary Kyrberg type may be included in it and form the basis of the constant differences of wave-number. The series spectra of hydrogen would then be no longer confined to the Balmer series.

On the photographs the behaviour of the "band" lines is peculiar. The "head"—a word not used in the ordinary sense, but as denoting the strongest line of the band and the one most remote from the red end—is preserved in intensity in helium, or even enhanced, while all the other members disappear. A line in pure hydrogen may be weak, but if it is really a band-head in this sense, it is prominent in the presence of helium—the head is not always the strongest line in a band in pure hydrogen. This consideration is the real clue to the interpretation of the photographs, and it has been found possible to isolate the entire Fulcher band, which is of a remarkable structure and accounts for the great majority of lines between  $H_{\alpha}$  and  $H_{\beta}$ , in part of which region the previous measures have been very incomplete and misleading. Other strong bands of similar character occur in other regions, and it is already clear that the complete analysis involves only a few such individual bands showing no Zeeman effect, together with a line spectrum showing Zeeman effect, and apparently capable of arrangement in constant frequency differences.

These investigations will shortly be published, but in view of the importance this spectrum has now assumed in relation to atomic structure a preliminary statement of its nature appears to be desirable.

J. W. NICHOLSON.

University of London, King's College,  
March 21.

#### International Council for Fishery Investigations.

A PERUSAL of the programme of the International Council for Fishery Investigations, as outlined in NATURE of March 18, substantiates the criticisms published in 1902 and 1903, as well as later. In the interests of the fisheries and of the public in these critical times it is imperative to direct attention once more to the position. In the original programme of about twenty years ago the Council were to discover whether the yield of the sea-fisheries was increasing or diminishing, and especially to demonstrate the impoverishment of the sea (as if the myriads of ova on the fishmongers' slabs every year afforded no lesson); to show to what extent fishing-grouns could be depleted without danger; to point out what fishing apparatus was destructive; to investigate the small fish grounds; to make discoveries of practical importance to the fisheries; to publish annual results; and finally to produce data (even within two years) on which British and foreign legislation could be based.

Now, after sixteen to twenty years' labour and a great expenditure of public money (for salaries went on during the war), it is found that the impoverishment plea is dropped, along with most of the heads just mentioned as requiring solution. The new scheme, to take the heads in the order in which they appear (see NATURE, March 18, p. 84), includes an inquiry into the result of "the most gigantic scientific experiment ever made in respect to the closure of areas." It is unlikely that the fisheries of the North Sea will be to any extent altered by the partial closure caused through the operations of the

Grand Fleet. The ways of Nature are not so simple. Then comes the old phantom of the diminishing plaice and the protection of the race by a size-limit, an impracticable idea so far as the security of the younger plaice goes. The larval, post-larval, and smaller forms are in prodigious numbers, and are safe. Nor is confidence in the Council increased when the ten years' work of the Scottish Fishery Board's ship, *Garland*, in the closed areas is now regarded as ineffective, and the subject not sufficiently studied! In other words, the deliberate conclusions of the Scottish Board, so resolutely upheld, and on which the closure of the Moray Firth and other areas was based, are null and void. That is one way of escaping from an untenable position. The Council may well spare the "intensive study" of the plaice so far as the prosperity of the British fisheries is concerned, and so with further experiments on plaice-marking and drift-bottles, as well as on the food of the young. Nothing important on these heads can result from continued expenditure. The lemon-dab requires little attention, for, like other doomed fishes of the kind, it has re-asserted itself. There is no urgent need for studies on the herring, though this was supposed to be one of the diminishing fishes not long ago. Yet a word must be said in favour of the Danish exploration of the North Atlantic, where, and in the Mediterranean, Dr. Johs. Schmidt carried out such excellent work on the life-history of the eel.

The hydrographical and plankton work of the Council has hitherto borne little fruit in the matter of the fisheries, and it is unlikely that, after twenty years' probation, more will be accomplished.

The revival of the bathybius-myth in the form of the supposed "vitamines" in sea-water may give point to a sentence, thus: "The searcher for economic results in fisheries must have the basal theory and knowledge . . . as the foundation on which he has to build," but that is *vox et praeterea nihil* unless a practical acquaintance with the whole details of the life-history of the sea-fishes is possessed by him. Mere collation of statistics without such a check is of little avail in the complex problem of the sea-fisheries, which, however, now as heretofore, hold their own against the combined attacks of their own kind, as well as of man, seals, whales, birds, and invertebrates. Marine animals have been kept in pure sea water without food for years, yet the suggested application of the "vitamine" theory to the oyster and mussel does not offer much scope. The best *parcs* for fattening the oysters have much more than "vitamines," and even the *ejectamenta*, etc., of the mussels in the estuaries will by and by raise mounds several feet above sea-level.

Four French names are given as members of the Council, but they are less familiar than those of Fabre-Domergue, Canu, Cligny, Raveret-Wattel, and Pellegrin. Again, one British name is conspicuous by its absence, viz. that of Dr. A. T. Masterman, a highly trained and talented fisheries expert. It is to be hoped that no interference by officialdom, as dealt with in the leading article in NATURE of March 25, is connected with his retirement. Those who remember the case of Sir Joseph Hooker and Mr. Ayrton have reason to be jealous of the official status of experienced men of science in carrying out their researches for the benefit of the country.

Finally, there can be little doubt that Britain would be better and more economically served by competent workers in its marine laboratories, where, moreover, young zoologists could acquire a competent knowledge of the marine fisheries.

W. C. McINTOSH.

### The Plumage Bill and Bird Protection.

THE protection of beautiful and interesting birds is the object of Col. Yate's and Lord Aberdeen's Bill now before Parliament. The chief end is to close Great Britain (and presumably all parts of the British Empire controlled from London) as a market in which the plumage of wild birds (excepting eider down and ostrich feathers) may be bought and sold. The reasons for excepting the down of the eider duck and the plumes of the ostrich need scarcely be explained. The eider duck strips herself of the downy feathers she develops during the breeding season and lines her nest with them. This down can be obtained without injuring the bird, or even without depriving her nestlings, who leave the downy nest soon after birth. Such a large proportion of ostrich plumes is obtained from tame birds (and the wild ostrich chicks are so easily domesticated) that it is scarcely worth while pursuing the wild bird for its feathers. Moreover, the plumes can be removed from the tame birds painlessly.

The Bill is drawn so as to protect wild birds from persecution by closing to the trade in their feathers the very important British market, which, together with the strong action of the United States and Canada, will go far towards extirpating this commerce. We should protect beautiful, useful, interesting, and harmless birds—adjectives which include all the avian class except, perhaps, the house-sparrow, the tree-sparrow, and the wood-pigeon, because:—

(1) They are beautiful in shape, in plumage, in their manner of life, or in their voice, and they always add to the æsthetic charm of a landscape.

(2) The majority of birds feed upon insects, ticks, land mollusca, small rodents, or carrion. They are our principal allies in keeping the insect hosts at bay and destroying the sources and disseminators of germs which breed disease in man, beast, and plant. They save our food crops and our timber-trees from destruction by insects, snails, and slugs; they attack snakes; and they assist to maintain the balance of creation in favour of man.

(3) Sea-birds—especially gulls, auks, petrels, gannets, frigate-birds, cormorants, and penguins—are the producers of guano useful in agriculture and horticulture.

(4) Many fruit-eating birds are great distributors of the seeds, stones, and nuts of valuable timber-trees or trees producing spices, dyes, drugs, or fruits of value to humanity.

*Ergo*, all birds, save the sparrows and the European wood-pigeon (which is very destructive to crops, and is believed to spread the germs of diphtheria), should be protected from attacks which are not necessitated by some real human need. What would be such a need? The preservation of the bulk of a food crop, or the necessity for the bird's flesh, or the requiring of its under-plumage as a material for warding off cold. The last-named requirement does not affect the tropics or sub-tropics. Most insect-eating or guano-producing birds are unfit for food, and are disliked from that point of view by the savage quite as much as by the white man. Penguins and a few other sea-birds yield a valuable oil, but there is no reason why penguin rookeries should not be established for that purpose provided the species is properly preserved from serious diminution. Yet the amount of oil thus obtained is trifling in comparison with the yield from whales, porpoises, seals, and fish; and these inhabitants of the seas and oceans are more protected by their habitat from devastating attacks than are birds resorting to a terrestrial life during the breeding season. At any rate, the extermination of marine mammals or of fish is not such a loss to landscape beauty or to the economics of human life as is the destruction of sea-birds.

What is the offset against this argument for wild-bird preservation? What quality do beautiful and interesting wild birds possess that they should be attacked, pursued, and destroyed until in many cases they become extinct? They produce feathers and plumes of great beauty in colour or of exquisite outline or texture which are desired as a personal adornment by certain European—not Asiatic, American, or African—women, who stick these trophies in head-coverings or as a trimming on their corsage. There is also in about half a dozen instances a further use of wild birds' plumage in the making of artificial fies used by anglers.

All that European women or anglers can in reason require in the way of plumes, wings, tails, or skins of birds for their decoration or other purposes can be obtained without cruelty from the domesticated or preserved birds that are killed for food or kept for egg production—ostriches, the domestic fowl in a hundred varieties, the common pheasant and other pheasants bred in aviaries, pea-fowl, turkeys, guinea-fowl, pigeons, grouse, partridges, ducks, geese, certain kinds of wild duck sufficiently preserved to be in no danger of dying out, and so forth. Trade in such feathers is in no way restricted by the Plumage Bill. It is not right that rare and beautiful or exceedingly useful wild birds of the tropics and sub-tropics should be destroyed, eliminated from the landscapes for the sole purpose of decorating the persons of European women. We are told that the disuse of this practice would throw out of employment four or five thousand persons in England, France, and Holland; but surely they could find work in dealing with the feathers of domesticated birds.

H. H. JOHNSTON.  
St. John's Priory, Poling, Arundel.

It is desirable in a discussion on the Plumage Bill to ensure that knowledge is not controlled by sentiment, and that the solid facts of the matter are borne definitely in mind. Supporters of the Bill give three main reasons for it. They claim that the Bill will stop (1) the extinction of rare birds; (2) cruelty in that it will stop the killing of breeding birds, and so preserve their young; and (3) cruelty in the actual slaughter of birds at all. Against the Bill are the statements that it effects nothing in regard to these points (in that it has no action in the places where the birds occur); that it stops a great deal of perfectly harmless and legitimate trade; and that the real protection of birds must be an international matter, which was being quite easily brought about by voluntary effort, which effort will be killed by the Bill.

The important points are to consider (1) whether there is cruelty, (2) whether birds are being made extinct owing to the plumage trade, (3) whether the present Bill will prevent cruelty and extinction, and (4) whether any alternative proposal can be suggested. In regard to cruelty, it is extremely difficult to secure real evidence apart from unsupported statements. In a letter to the *Times* a few days ago Mr. H. J. Massingham produced a private letter detailing horrible cruelty in China with getting egret plumage. There is an American bulletin that details the killing of 150,000 or 300,000 "albatrosses and noddies." One may admit the first as "cruelty," but scarcely the second so long as hunting and shooting are carried on in England. The Right Hon. Sir C. E. H. Hobhouse in the House of Commons referred to an auction of 75,000 herons, and to another of 77,000 herons, 22,000 crowned pigeons, 25,000 humming-birds, and 162,000 Smerinian kingfishers. But is this wrong? No one could say that this trade was making any bird extinct.

The trade wants them in thousands, and would not seek a bird so rare that it was available only in hundreds.

I think there is no evidence of any bird being made extinct by acts of the plumage dealers, whose interest lies in birds being abundant, but the Bill allows the scientific collector to bring in the rarest plumage. In this connection some persons emphasise the destruction of insectivorous birds as being a pity; but an insectivorous bird may itself destroy beneficial insects—say, dragon-flies, which themselves feed on mosquitoes.

Mr. C. W. Mason and I have published a very careful analysis of the food of birds in India, and we decided that herons were injurious (see *Memoirs of the Agricultural Department of India*, vol. iii., 1911). I have before me three such memoirs, all by entomologists, relating to England, Australia, and India; and it is necessary to distinguish very clearly what the value of a bird is. Apart from this, no one interested in Nature could desire the extinction of any species of bird or other life at all, and we need not restrict our precautions solely to beneficial birds.

The third point is whether the proposed Bill will protect the birds. It will not, because it simply prohibits importation into England of all plumage except ostrich and eider down, unless it is worn or is personal property. The plumage goes just the same to Paris, and no bird is protected at all. The same amount of plumage will come to England, only it will be all made up in Paris.

The fourth point is: What can be offered in its place? I suggest the Bill should prohibit the import of scheduled birds, and that if evidence is brought of cruelty or of approaching extinction, the importation of the bird from that locality should be prohibited by simply adding it and its locality to the schedule. There might well be a Standing Committee attached to the Board of Trade to hear representations and to vary the schedule.

The egret is greatly mentioned. It is said to be destroyed for its plumes while the young birds are still helpless in the nest; but I have photographs of an egret farm in Sind, and there are hundreds of such farms. The egrets' plumes are taken without cruelty, and the birds are not killed. Why, then, indiscriminately forbid egret plumes and destroy an industry in India? Why not exclude Chinese egret, and represent the matter to the Chinese Government? Why bar also the possibilities of farming emu, rhea, marabout, lyre-birds, pheasants, etc.?

The Committee for the Economic Preservation of Birds up to August, 1914, endeavoured to put this matter right. It is a fact that this Committee had secured the co-operation of the plumage trade of Paris, Vienna, Berlin, and London, and that the whole trade voluntarily stopped the import and use of the plumage of a number of birds which were thought to be in danger of extinction or to be beneficial. This was the only effort to secure the real remedy, international co-operation; and the present Bill completely wins out that possibility.

Perhaps the present discussion will produce the solid evidence (apart from opinion) on which the supporters of the Bill rest; up to the present there has been little other than sentiment.

One last point that has a scientific bearing is that the Bill allows the importation of plumage for scientific purposes and for museums. The scientific collector specialises on rarities which the museums need, and it is exactly this type of collector who needs to be stopped; but the Plumage Bill is backed precisely by the ornithologists who want rare skins, and so can get them.

I think the Bill needs a great deal of reconsideration, that a reasonable Bill can be drafted which will protect birds, and that the present one allows for the collection of the nearly extinct birds and does nothing to protect the cases where there is cruelty.

H. M. LEFROY.

If I were still in Parliament I should give as cordial support to the Importation of Plumage (Prohibition) Bill as I would have done to the late Lord Avebury's Bill had I been in the House of Lords when he introduced it. But I recognise that if the measure is to receive support from men of science, it must be based mainly on scientific rather than on humanitarian or sentimental grounds.

I notice that Prof. H. M. Lefroy, in a recent letter to the *Times*, seems to assume that the advocates of prohibition are actuated by sentiment only. He asks whether they consider it less cruel to kill spring chickens for their flesh than pretty birds for their plumage. If this is meant for argument, it seems particularly feeble, unless the whole question of the ethics of consuming animal food is to be raised. If it were as easy to rear egrets, birds of paradise, rifle-birds, etc., for the sake of their plumage as it is to rear cattle, sheep, and domestic fowls for their flesh, probably none but extreme humanitarians would raise serious objections, even if the birds had to be killed, which is not necessary in ostrich-farming. From a scientific point of view, the matter seems to resolve itself into the question whether the extinction or drastic reduction of the most beautifully clad birds can be viewed with indifference. I cannot speak at first hand about the extent to which reduction has been carried, but the evidence on this subject has proved sufficient to convince the Legislature of the United States that restriction of the plumage trade was necessary if some of the choicest species were to be saved from extinction.

I cannot but hold the conviction that the true functions of naturalists are not limited to the mere work of collecting, recording, and classifying, and that it is incumbent upon them to aid in resistance to the extermination of such existing species as do not interfere with the welfare of human beings. But, after all, I can claim no higher standing than that of a field-naturalist, setting more store on a bird in the bush than two in a glass case or on a lady's hat!

HERBERT MAXWELL.

Monreith.

THE subject of the Importation of Plumage (Prohibition) Bill now before Parliament is one in which all zoologists, and, indeed, all lovers of Nature, should take a lively interest. It seems almost certain that much cruelty is involved in the operations of plume-hunters, and it is difficult to see how it could be otherwise, especially when the plumes are collected during the breeding season. This question, however, I leave to others who have the necessary evidence at hand, together with the important problem of the part played by the birds in the destruction of noxious insects.

The point I wish to emphasise is the irreparable loss, not only to science, but also to mankind in general, which will result from the extermination of many of the most interesting and beautiful creatures that exist. Unfortunately, there appears to be no limit to the lust of personal gain. Were it possible to pluck a star from the heavens and sell it for the decoration of a lady's headdress, star-hunters would doubtless be as active as plume-hunters in destroying man's rich inheritance.

It is clearly our duty to preserve for future generations, as well as for our own enjoyment and edifica-

tion, the wonderful products of Nature by which we are still surrounded. The destruction of a work of art would be condemned as vandalism by all educated people, and it is difficult to believe that any intelligent woman would willingly be a party to the destruction of some of Nature's finest masterpieces. It has taken many millions of years to produce a humming-bird or a bird of paradise, and what work of art can compare with these living gems? Their destruction, once accomplished, would be irrevocable, and future generations of zoologists, with all their science of genetics, might strive in vain to produce anything to replace them.

Should such wantonness be permitted merely to satisfy the greed and vanity of a few human beings? I think not, and therefore I hope the Plumage Bill now before Parliament will be passed, and that other nations will follow our example in endeavouring to put a stop to a practice which is a dark blot on civilisation.

Possibly an even more hopeful method of accomplishing this aim would be by the formation of women's societies for the express purpose of discountenancing the fashion of wearing plumage derived from wild birds, except in the case of those the destruction of which is demanded for other and sufficient reasons. Such societies might do much useful work in enlightening the ignorant and thoughtless and in fostering a wholesome public opinion. Possibly they exist already; if so, now is their opportunity.

ARTHUR DENDY.

#### The Magnetic Storm of March 22-23 and Associated Phenomena.

THE magnetic storm of March 22-23 was one of the most considerable recorded at Eskdalemuir during the last nine years throughout which continuous records have been obtained. It began with the abrupt disturbance known as a "sudden commencement" at 9h. 12m. G.M.T. on March 22, the rapidity of the change in the horizontal components at that time being so great that the photographic impression of the moving light-spot was too faint to enable its details to be traced. The main features, however, began to develop immediately afterwards. On the traces recording the changes in declination and the westerly component there were no very large motions in the interval between the sudden commencement and 14½h., but there occurred the intense agitation due to oscillations of short period. At the same time the northerly component of force gradually rose, having superposed upon it several large, slow motions as well as numerous short-period oscillations.

The larger motions of both horizontal components began soon after 16h., and by 17h. the declination trace had passed beyond the edge of the recording sheet. At this time, when the extreme westerly declination was reached, its value must have been at least  $1^{\circ} 43'$  beyond its undisturbed value. The north component trace was similarly off the sheet upwards (*i.e.*, with increased value) from 16h. to 20h. From 20h. until midnight the disturbance in the horizontal field was on a lesser scale, but during the four hours after 0h. 30m. there occurred a series of large and rapid oscillations. For example, in six minutes from 1h. 20m. to 1h. 26m. the declination shifted eastwards through  $2\frac{1}{2}^{\circ}$ . The northerly component fell rapidly in value after midnight, and the trace was off the sheet downwards several times between 0h. and 4h. The total range of this component must, therefore, have exceeded 700γ—an unusually high value. From 4h. to 10h. on March 23 the motions were smaller, but extremely rapid, the period averaging about four minutes. After 10h. no further considerable disturbance occurred, but a

notable sudden change, in a direction north-east-downwards, took place with its maximum at 19h. 17m.

The vertical force magnetogram for the storm is of more than usual interest. So far as this component is concerned, the ordinary course of events during a magnetic storm which begins before midnight includes a gradual increase in downwards force towards a maximum which is reached before midnight, followed by a fall for an hour or more; then a check, followed by a further fall, and a gradual recovery to nearly normal value, which may be reached about 8h. In the present case four prominent maxima are shown before midnight—at 14h. 27m., 17h. 24m., 20h. 10m., and 23h. 49m. The range of disturbance between the second and highest maximum and the second minimum (at 19h. 6m.) was 565γ. Soon after midnight there occurred an extremely rapid fall in value which sent the trace off the sheet for nearly six hours. The subsequent recovery was characterised by well-marked pulsations the period of which was irregular, but averaged about five minutes, and were of unusually large amplitude. The occurrence of these pulsations in vertical force at the end of a storm is a feature requiring attention in any theory attempting to explain magnetic storms.

The disturbance was accompanied by an auroral display, including the "curtain" form at a considerable altitude, and extending, at 0h. 50m. on March 23, to within  $30^{\circ}$  of the southern horizon. There was little cloud at the time, but low mist made observation of details difficult.

A. CRICHTON MITCHELL.

Eskdalemuir Observatory, March 26.

#### Science and the New Army.

NATURE of March 25 publishes a leading article "Knowledge and Power," a letter from Col. E. H. Hills, and a paragraph in the "University and Educational Intelligence," all dealing with related subjects. A sentence in the last-named paragraph throws light on the other communications. It reads: "Every officer in command of a company will be held responsible for the instruction of his men." The paragraph neglects to state, however, that the majority of these officers entered Sandhurst or Woolwich at an immature age, probably without competition, and are almost as ignorant as the men whose education they are to supervise.

During the war the lack of scientific knowledge and of habits of exact thought of these officers was shown not only by their persistent attempts to prevent the use of scientific means, but also by their child-like faith in a formula or parrot-cry. "Follow the barrage," "Counter-attack," "Defence in depth," are some that come to mind—formulae passed down through the official channels to be applied without thought to all possible situations.

In this country war is still looked upon as an art, whereas it is rapidly becoming an exact science.

The firing of millions of projectiles, involving an enormous expenditure of energy, not only in lives, but, what counts almost as much in the long run, also of labour, is a matter for exact calculation if the maximum probable results are to be obtained. At the present time such problems are solved by intuitive methods, and will be so whilst the present system of officering the Army obtains.

All hope of any real progress must be abandoned until a change is made; then, perhaps, we shall no longer see directors of research absolutely ignorant of the problems that are being solved or await solution.

A. R. RICHARDSON.

Imperial College of Science, South Kensington, S.W.7, March 31.

### An Electronic Theory of Isomerism.

I HAVE read with considerable interest the suggestion of Dr. H. S. Allen in NATURE for March 18 that the Langmuir atom could be applied with advantage to the study of organic compounds. Dr. Allen is, however, doubtful if the "cubical atom" of Langmuir will explain the existence of isomerides of the type of the three malic acids, the glutamic acids, the cinnamic acids,  $\alpha$ -,  $\beta$ -, and  $\gamma$ -sugars, etc.; and it is certainly difficult to give formulæ for the triple linkage on the cubical atom. These difficulties disappear with the Bohr atom (NATURE, February 19, p. 661) and the modification of the Langmuir atom proposed by Major A. E. Oxley (*ibid.*, March 25, p. 105). With both theories  $n$  and  $s$  valencies are obtained, and, so far as a qualitative examination of valency in organic chemistry is concerned, it is difficult to decide between the two models. Major Oxley has, however, shown that his theory can give an adequate explanation of the magnetic properties of organic compounds, and equal success may be obtained with a theory of optical activity.

The crucial test appears to lie in the calculation of the optical activity of substances in the crystal form, for it is probable that in the liquid condition a large number of isomeric forms exist.

The alterations in optical activity which occur with change of solvent and the phenomena of mutarotation and of racemisation appear to be connected with changes in the direction of rotation of electrons. These changes could, perhaps, be more easily explained by the small orbital motions demanded by the Langmuir theory than by the larger orbital motions in the theory of Bohr. W. E. GARNER.

University College, London.

IN view of Dr. A. E. Oxley's remarks in NATURE of March 25, I should like to point out that the object of my letter was to inquire whether the supposition of stationary electrons is essential to Langmuir's theory. Langmuir himself expressed the hope that it would be possible to reconcile his theory with that of Bohr, "which has had such marked success in explaining, and even in predicting, new facts." I ventured to suggest that electrons revolving round the nucleus could form stable groups as required by Langmuir without needing to be stationary.

The difficulty of explaining diamagnetism on the theory of the astronomical atom is well known. Possibly the difficulty may disappear when the nucleus is better understood. If electrons are considered as point-charges, the supposition that they revolve in very small orbits without any constraining force seems arbitrary. Dr. Allen's theory of ring electrons is preferable, and undoubtedly removes certain difficulties. It appears, however, that to account for spectral lines the diameter of the orbits must be comparable with that of the atom, which implies that the electrons revolve round the nucleus.

Since the structure of the atom is still uncertain, would it not be preferable to avoid, if possible, in a chemical theory a statement as to the immobility of the electrons? S. C. BRADFORD.

Science Museum, South Kensington, S.W.7.

### Percussion-Figures.

C. V. BAMAN describes in NATURE of October 9, 1919, percussion figures in isotropic solids. These figures are known in geology, and are found on rounded boulders of compact, homogeneous rocks, such as flint and quartzite. Albert Heim<sup>1</sup> described in 1871 the "percussion-cones" (Schlagconus) brought forth artificially on pieces of flint by a powerful short

blow with a hammer. F. Mühlberg,<sup>2</sup> of Aarau (Switzerland) was perhaps the first geologist who described the percussion-figures (Schlagfiguren) on rounded boulders (1885). On some of the quartz-boulders from the River Aar, near Aarau, he found from hundreds to thousands of circular cracks, which he explained by the abrasion of boulders which formerly received coniform cracks through the numerous impacts during their transport through the river-bed.

These percussion-figures must be intersecting figures of cones and the surface of the boulder, and, therefore, will form, on sufficiently great boulders, nearly circles, ellipses, and parabolas. Mühlberg described thus percussion-figures arising from torrent-action, whereas A. Bigot<sup>3</sup> (1907) emphasised that the "figures de percussion" arise from wave-action. He noticed them on the beaches of Basse-Normandie, particularly on quartzite boulders. Finally, P. N. Peach<sup>4</sup> (1912) gave a very fine picture of the "bulbs of percussion" found on a rounded stone (chalk flint) dredged by the *Michel Sars* about 230 miles southwest of Mizen Head, Ireland. He pointed out that these figures indicate that "the stones had originally been dashed against each other by torrent- or wave-action."

Besides the term above-mentioned, Peach also uses the term "chatter marks," which seems to me less commendable, because this expression is also used by T. C. Chamberlin<sup>5</sup> for a special type of glacial striæ on the rock-bed. These curved figures were also described by Hagenbach in 1883, and afterwards called "arcs de Hagenbach" by L. Rollier.<sup>6</sup>

Batavia, Java, February 11.

B. G. ESCHER.

### A Peculiar Halo.

ON March 16 I observed a peculiar halo here; its form is best shown by a rough sketch. The angles were taken with a pocket slide-rule held at arm's length, and are, therefore, only approximations, but the relative values are probably fairly correct. The halo was brightest at the point above the sun, and faded off somewhat on each side; it ended rather abruptly at the points shown in the sketch. The

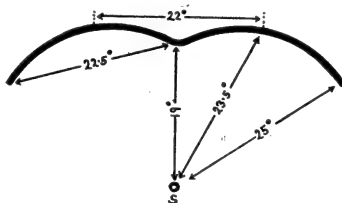

colours, with red nearest the sun, were not very pure, but they were purer in the arms than in the centre. The phenomenon was visible from 14.45 to 15.40, with intervals of disappearance when a sheet of alto-stratus became so thick that nothing could be seen through it but the glare of the sun. It was not possible to see any higher layer of cloud, but the halo probably had its origin in a layer of cirro-stratus. The measurements were taken at 15.40; a few minutes later the halo disappeared for the last time. C. J. P. CAVE.

Sherwood, Newton St. Cyres, Devon,  
March 20.

<sup>1</sup> Programm der Aargauischen Kantonschule, Aarau, 1885; *Die heutigen und früheren Verhältnisse der Aare bei Aarau*, p. 4.

<sup>2</sup> *Bull. tin de la Soc. géol. de France*, 4e série, tome iv (1904), p. 598.

<sup>3</sup> Proc. Roy. Soc. Edin., 1912; also Murray and Hjort, "The Depth of the Ocean," p. 205.

<sup>4</sup> 7th Ann. Rep. U.S. Geol. Survey, p. 218.

<sup>5</sup> *Bulletin de la Soc. Belgoiraine d'Emulation*, No. 27, 1908.

## Sea-birds: Their Relation to the Fisheries and Agriculture.

By DR. WALTER E. COLLINGE.

**D**URING the past few years there has been a growing opinion on the part of the general public and those connected with our fisheries that the enormous number of sea-birds on our coasts are inimical to the fisheries and to a less extent to agriculture. This view has been fostered to a large degree by the public expression of irresponsible statements and by the fact that we do not possess any exact and trustworthy knowledge of the nature of the food of these birds. Even amongst ornithologists and other students of wild-bird life widely divergent views are held.

Hitherto no investigation sufficiently comprehensive has been made, and in those cases where the birds of a restricted area have been studied, or where an insufficient number of specimens has been examined, the results have proved inconclusive, and, owing to the methods employed, to some extent misleading.

About two and a half years ago, under the auspices of the Carnegie Trust for the Universities of Scotland, an investigation was commenced in which it was proposed to examine large series of each species from numerous localities during each month of the year, and to estimate the food by the volumetric method. Although this research is not yet complete, sufficient data are in hand to warrant an expression of opinion upon this subject, and it is felt that such is highly desirable at the present time, when so many erroneous views are being circulated.

Up to the present, fourteen species have been examined, represented by upwards of three thousand specimens. The species are cormorant, shag, common gull, herring gull, great black-backed gull, lesser black-backed gull, black-headed gull, kittiwake, common tern, razorbill, guillemot, little auk, puffin, and great northern diver. Whilst it is not possible here to reproduce the numerous percentage tables showing the nature of the food for each species during the various months of the year, or those illustrating the seasonal variations or the percentages of the different species of fish destroyed, it is possible to make a general statement which we believe future work will more fully amplify and confirm.

First, we would point out that the importance and amount of fish that has been generally regarded as forming the diet of most of these birds are not borne out by an actual examination of their crop and stomach contents. Fish does not (with such exceptions mentioned later) constitute the bulk of their food or anything like the major portion of it. Indeed, one has only to watch carefully such species as the black-backed gull, the herring gull, and the lesser black-backed gull on the shore after the ebb of the tide to realise how essentially these birds are the scavengers of the shore. If they turn landwards, then injurious insects, earthworms, frogs, and carrion are greedily fed upon. Further, if one confines one's

observations to birds drowned in the fishermen's nets, entirely misleading ideas are obtained, for these few birds constitute but the merest fraction of the huge bird population frequenting our coasts.

The above-mentioned fourteen species may be divided into three classes, viz.: (i) Purely fish feeders; (ii) largely fish feeders, but most of the fish are not utilised by man as food; (iii) fish feeders to less than 20 per cent. of the total bulk of their food. Most of the species fall into class (iii). In class (i) is placed the cormorant and shag, for, so far as observations go, their food consists entirely of fish, and chiefly of food fishes. In class (ii) is placed the common tern. The remaining eleven species must all be placed in class (iii).

From information obtained from various sources, there is a general consensus of opinion that the cormorant and the shag do an enormous amount of harm to the fisheries. Nothing can be advanced in their favour, though it is open to question whether our fish supply would show any increase even were these birds exterminated. Respecting the common tern, sand eels constitute fully 50 per cent. of its fish diet; the gunnel or butter fish, gobies, young gurnard, herring, and haddock are also taken.

It is not possible here to give the details of the analyses for all the remaining species; we shall therefore select one, the black-headed gull. More than five hundred specimens of this species have been examined, obtained from various localities and during each month of the year. This species is selected because it has increased enormously during the last twenty years, and is now generally regarded as one of the most injurious both to the fisheries and to agriculture.

Of the total bulk of food consumed in a year, 96 per cent. consists of animal matter, and 4 per cent. of vegetable matter. Of the former the actual amount of food fishes found was 11.5 per cent., and of other fishes (not utilised by man as food) 9 per cent., or a total fish diet of 20.5 per cent. Edible crustacea are present to the extent of 4 per cent., and other forms, non-edible, to that of 10 per cent. Marine worms constitute 18.5 per cent., molluscs 4 per cent., echinoderms 2.5 per cent., injurious insects 22 per cent., other insects 1.5 per cent., earthworms 10 per cent., and miscellaneous animal matter 3 per cent. Of the vegetable matter, 2.5 per cent. consists of cereals, and 1.5 per cent. of miscellaneous matter (Fig. 1).

If the huge bulk of food from which these figures have been obtained means anything at all, it indicates clearly and definitely that this species is a highly beneficial one. By no reasonable deduction can it be shown to be otherwise, for nearly two-thirds of its food is of a neutral nature, viz. 60 per cent. (38 per cent. of which consists of shore refuse.) Only 18 per cent. is injurious, and 22 per cent. is highly beneficial. We



feel certain that no one who has had experience in work of this character will for a moment question whether this percentage of food, which is conferring a benefit upon agriculture, balances the injury that is inflicted upon an inexhaustible and ever-increasing fish supply.

Very similar figures might be advanced for the remaining species, none of which are taking more than 20 per cent. of fish per annum of their total bulk of food. Is the sea so impoverished that we cannot afford these birds this amount of fish-food in exchange for their beneficial action in destroying more than 20 per cent. of injurious insects (of which 7.2 per cent. consist of wireworms in the case of the black-headed gull)?

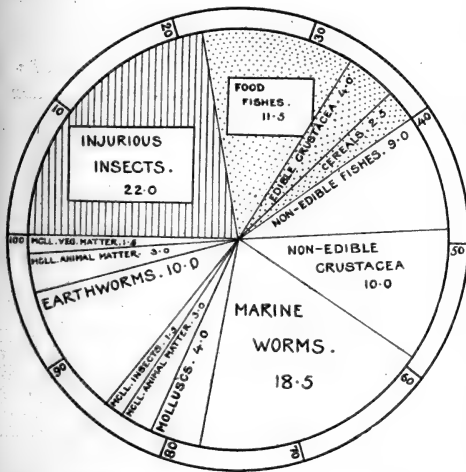

FIG. 1.—Diagrammatic representation of the percentage of food of the black-headed gull. The portions shaded by longitudinal lines represent food that it is beneficial the birds should eat; those stippled, food that it is injurious they should eat, and the blank portions food of a neutral nature.

The records, both individually and collectively, show that the bulk of the food of these birds is not fish, but animal matter of a neutral nature. Of course, if one classes all annelids, non-edible crustacea, and molluscs as fish food, then very different figures may be obtained; but those who are acquainted with the abundance and the nature of the marine life cast up on the shore will agree with us in regarding these as a neutral factor.

If the figures are summarised for all the species in class (iii) (so far as our investigation has gone),

the verdict is certainly in favour of these birds. It is very easy to condemn a species because at some particular season of the year or in some district a certain number have been found to be feeding upon food fishes; but, as has been frequently pointed out, such partial records do not give a true estimate of the food as a whole. It must not for one moment be thought that we are endeavouring to explain away the injuries inflicted, but we contend that it is unfair to judge any species of wild bird upon a local or partial record; the nature of the food generally throughout the United Kingdom and over the whole year is what we have endeavoured to learn.

Very interesting results have been obtained as to the seasonal changes of food and the variations in different localities. Sex and age also influence the quantity of food taken, and although the figures are yet incomplete, they point to the fact that the males take a larger quantity of food than the females, and the young birds more than the old.

It is not within the province of this inquiry to discuss the question of the impoverishment of the sea, but it will be impossible to conclude it without taking cognisance of the leading views on the subject and their bearing upon this question.

Finally, all the work goes to show that with a few exceptions—e.g. the cormorant and the shag—the food of each species is partly beneficial, and, even if for the moment we admit that the percentage of the fish destroyed is an injury, we must take into consideration the benefits derived by reason of the nature of the remaining food. This varies in different seasons of the year and according to the nature of the locality, but if an average is taken of the eleven species in class (iii), we find that the total percentage of injuries is less than that of the benefits, and that the bulk of the food is of a neutral nature.

It is obvious that, after examining upwards of three thousand specimens, with the results obtained, the question of the food of our commoner sea-birds and their effect upon the fisheries and agriculture can no longer remain where it was; and, whilst not advocating any special protection, except in one or two cases, any agitation for their destruction cannot be condemned too forcibly, for, altogether apart from sentimental reasons, it is extremely unlikely that our fisheries would benefit or show any marked improvement, even were hundreds of thousands of these birds destroyed annually, whilst agriculture would certainly be the sufferer by such a loss.

### The Imperial College of Science and Technology.

THE Chancellor of the Exchequer, speaking in the House of Commons on March 16, expressed concern at the extraordinary expansion of business in the promotion of companies, and said he was convinced that the time had come when part of the money thus called for only creates increased competition for the limited

supplies of labour and material which are all that are available. Few of us can doubt that this concern of the Chancellor is more than justified, but it is not only for purely industrial enterprise that appeals to the public at large are being made daily for large sums of money. Owing to the universal rise in prices, educational institutions

find themselves seriously handicapped in their endeavours to fulfil the functions assigned to them. In the case of such educational institutions as the schools and colleges maintained wholly, or almost wholly, from rates and taxes, the solution is less difficult, and may be found in an increased education rate combined with an increased Government grant. For the universities which have to depend largely upon fees and endowment, and can rely only partly on Government grants, the difficulties created are very serious. It should, however, be borne in mind that money expended on education is one of the most productive forms of national expenditure, and, whatever may be the dangers of the inflation of industrial capital, the nation is not yet within remote danger of educational inflation. Rather is it suffering grievous detriment from the semi-starvation of its higher educational institutions.

Among the higher educational institutions which are in need of financial help, the Imperial College of Science and Technology holds a prominent place, and an appeal issued some months ago by the governing body makes clear the magnitude and urgency of this want. The Imperial College of Science and Technology was incorporated under Royal Charter in July, 1907, and was established "to give the highest specialised instruction and to provide the fullest equipment for the most advanced training and research in various branches of science, especially in its application to industry." The governing body was also required to carry on the work of the Royal College of Science, the Royal School of Mines, and the City and Guilds (Engineering) College, institutions previously existing, but which in 1907 became associated as integral parts of the new institution.

The Imperial College is thus an association or federation of colleges, deliberately charged by the terms of its charter to afford facilities for the highest work in pure and applied science, especially in its application to industry. As an indication of the magnitude of its work, it may be noted that in the year 1907-8 there were 665 students, including 20 engaged on post-graduate work, and the annual expenditure on maintenance approximated to 50,000*l.* In the year 1913-14—the year before the war—the number of students was 943, including 185 engaged on post-graduate work, and the annual expenditure on maintenance approximated to 90,000*l.* During the war the numbers of students were reduced by about two-thirds, but in May last year there were 841, including 110 post-graduates, and as the numbers are rapidly increasing there is every indication that the college will soon be busier than ever before. On the basis only of the pre-war annual expenditure, the Imperial College is as large as Manchester University, larger than Liverpool University, and twice as large as Bristol University. Its rank in science and technology, whether viewed from the range and standard of its teaching and research,

or from its equipment, is at least as high as that of any existing university in Great Britain.

In order that the college may rise to the height of its responsibilities and fulfil the functions assigned to it by its charter, the governing body estimates that for new buildings and equipment at least 600,000*l.* is required, and for the adequate development of the work of the college a further annual income approximating to 100,000*l.* The capitalised value of the total additional requirement has been put in round figures at more than 2,000,000*l.* It is large, but much less than the amount required for a modern battleship, and is not incommensurate with the importance to the nation and the Empire of the work which the college has to do.

From a quarter to one-fifth of the total number of students are carrying on original investigations under the direction of their respective professors, and this, together with the research work of the staff, results in considerable additions to knowledge annually. The investigations range over a wide area of science, especially in its application to industry. The contributions thus made to increased industrial efficiency are no mean factor in the national development and prosperity. At the same time, in the course of these investigations the relevant researches in pure science are not neglected, and thus much is done continually to widen the bounds of knowledge as knowledge.

The teaching work carried on in the college may be divided into (a) associateship and (b) post-associateship. The former consists of courses, approximately of honours graduate standard, leading respectively to associateships of the Royal College of Science (A.R.C.S.), the Royal School of Mines (A.R.S.M.), and the City and Guilds Institute (A.C.G.I.); and the latter of courses of study and of research, comparable in standard with M.Sc. and D.Sc. work, leading to the diploma of membership of the Imperial College (D.I.C.).

Styled "Imperial" from the first, the college has constantly to bear in mind the growing industrial needs not only of the Kingdom, but also of the Empire, and to do this it must possess a flexibility and an adaptability suitable to the ever-changing conditions of industry. To take one example, the war disclosed, as in a flash, the perilous condition of the optical glass and optical instrument industry in this country through the dependence for many years on foreign supplies, particularly from Germany. A new department of technical optics has been established by the governors of the Imperial College, which, by research, by the supply of trained technologists in this field, and by the education of the users of optical instruments, must go far to second the efforts of the manufacturers to build up and stabilise this important and essential national industry. At no time was the need for an intensive and extensive development of science, both pure and applied, more needed than at the present time of national reconstruction after five

years of a devastating world war, and in this task of extending our knowledge of pure science and its application to the whole field of industry the Imperial College is called upon to play a vital and predominant part.

The recognition of how great and important are the responsibilities thus cast upon the Imperial College has led to a movement for obtaining for the college the status of a university with the power to confer degrees in its own subjects or faculties. The movement is backed by the unanimous support of the rector and professors of the

Imperial College, and it is supported, so far as can be ascertained in any organised way, by the overwhelming majority of the past and present students of the college. The issue raises, no doubt, questions that are novel and complicated in relation to university education in general and to the University of London in particular. Nothing but good can come from a free and frank examination of the proposition in all its bearings, undisturbed and unprejudiced by lesser interests than that of increasing the efficiency of university education and especially of scientific education.

### Magnetic Disturbances and Geological Structure.<sup>1</sup>

THE research described in the report before us was undertaken at the instigation of the Iron Ores Committee of the Conjoint Board of Scientific Societies. Certain lines and centres of magnetic disturbance had been noted in Britain so long ago as 1890 by Rücker and Thorpe, and a new magnetic survey by Mr. G. W. Walker in the years 1914 and 1915 confirmed the existence of these disturbed areas. It is well known that iron is the only element which gives rise to magnetic effects of considerable intensity, and it was therefore of importance to determine whether any relationship could be established between the location of these disturbances and the distribution of iron ores.

The detailed magnetic survey of (1) the proved sheet of iron ore, mainly in the state of ferrous carbonate, round Irthlingborough, and (2) the known areas of magnetic disturbance about Melton Mowbray, was therefore undertaken by Mr. Walker. At the same time, Dr. Cox reviewed the geology of the areas and collected specimens of rocks which promised to afford evidence in the matter, while the magnetic susceptibilities of these materials were determined by Prof. Ernest Wilson.

The results of the magnetic and petrological examination of the rocks confirm the opinion that the magnetic susceptibility of rocks depends scarcely at all upon the percentage of metallic iron they contain, but upon the condition—i.e. state of oxidation—of that iron; and that, although rocks composed of ferrous compounds show higher susceptibilities than those constituted of fully oxidised ferric compounds, only those rocks in which the iron occurs as the mineral magnetite have notable magnetic susceptibility. It was shown that parts of the granite of Mount Sorrel have a susceptibility more than four times as great as that of the most magnetic of the local Jurassic iron ores, and ten to fifteen times as great as certain basic igneous rocks, which, though high in iron, contain no appreciable amount of magnetite.

Another point of some interest is the variability of magnetic properties shown by samples taken from one continuous rock mass. The outer part

<sup>1</sup> "A Report on Magnetic Disturbances in Northamptonshire and Leicestershire and their Relations to the Geological Structure." By Dr. A. H. Cox. Phil. Trans. Roy. Soc., Series A, vol. ccxix., pp. 73-135; plates App. 1-4p. iii.

of the dolerite sill proved in the Owthorpe borehole was a fine-grained rock having a glassy base; its iron ore occurs as magnetite, and the magnetic susceptibility of the specimen examined was  $472 \times 10^{-6}$  C.G.S. units. The coarse-grained rock from the centre of the intrusion, however, in which the iron ores crystallised as ilmenite, gave a susceptibility of only  $10.3 \times 10^{-6}$  C.G.S. units. A like low susceptibility was noted also in the basalt from the Southwell borehole.

The magnetic phenomena of the Irthlingborough district are adequately explained by the presence of such a large, flat-lying sheet of feebly magnetic rock as the Bajocian iron-ore bed, but in the Melton Mowbray district the proved limits of the marlstone iron-ore bed bear no relation to the observed magnetic phenomena. Moreover, the consideration of the magnetic irregularities obtained in the Melton Mowbray district shows that the source of the disturbance cannot be less than 3000 ft., and may be as much as 10,000 ft. beneath the surface. The only rocks in this region which have the requisite magnetic susceptibility and may be expected to occur at these depths are dolerites, such as are found intrusive into the Coal Measures throughout the Midland coalfield area, or possibly granites like those which have invaded the old pre-Carboniferous rocks in Charnwood Forest.

Mr. Walker's observations show that, near to Melton Mowbray, there are two main magnetic disturbances, and that the line joining them ranges north of west and south of east from Melton Mowbray towards Rempstone, passing a little south of the latter place. This line agrees with that of a known fault of small throw which cuts the Mesozoic rocks, and may be expected to have a much larger throw in the Palæozoic and older strata underground. Similar magnetic disturbances are noted near certain large faults in the Nottingham district. Rücker and Thorpe showed that magnetic disturbances are always to be expected where a sill or dyke of highly susceptible rock is displaced by a fault, and that, if any rock containing magnetite is intruded as a dyke among non-susceptible rocks, similar magnetic disturbances must occur. It is known that in many districts the place of intrusions has been determined by faulting, and it is pointed out by Dr. Cox that the concealed coalfield of Notting-

hamshire should end off at an anticline, probably faulted, in the region about Melton Mowbray. Such an anticline has an east-and-west trend, and carries round the strike of the Coal Measures from its general north-east-and-south-west to an east-and-west direction. The Rempstone-Melton Mowbray magnetic disturbances, therefore, are interpreted as additional evidence of the existence of a fault which in the underlying Palaeozoic rocks may have a considerable throw; and it is regarded as probable that a sill of dolerite is displaced by this fault, or that an irregular mass of dolerite is intruded along it.

### British Crop Production.<sup>1</sup>

By DR. EDWARD J. RUSSELL, F.R.S.

CROP production in Britain is carried on in the hope of gain, and thus differs fundamentally from gardening, which is commonly practised without regard to profit and loss accounts. Many poets from times of old down to our own days have sung of the pleasures to be derived from gardening. But only once in the history of literature have the pleasures of farming been sung, and that was nearly two thousand years ago.

Ah! too fortunate the husbandmen, did they but know it, on whom, far from the clash of arms, earth their most just mistress lavishes from the soil a plenteous subsistence.—"Georgics," Bk. II., l. 458 et seq.

"Did they but know it!" Even then there seem to have been worries!

This seeking for profit imposes an important condition on British agriculture: maximum production must be secured at the minimum of cost. This condition is best fulfilled by utilising to the full all the natural advantages and obviating so far as possible all the natural disadvantages of the farm—in other words, by growing crops specially adapted to the local conditions, and avoiding any not particularly well suited to them.

From the scientific point of view the problem thus becomes a study in adaptation, and we shall find a considerable interplay of factors, inasmuch as both natural conditions and crop can be somewhat altered so as the better to suit each other.

It is not my province to discuss the methods by which plant-breeders alter plants; it is sufficient to know that this can be done within limits which no one would yet attempt to define. The natural conditions are determined broadly by climate and by soil. The climate may be regarded as uncontrollable. "What can't be cured must be endured." The scheme of crop production must, therefore, be adapted to the climate, and especially to the rainfall.

The rainfall map shows that the eastern half of England is, on the whole, drier than the western half. In agricultural experience, wheat flourishes best in dry conditions and grass in wet conditions; the vegetation maps show that wheat tends to be grown in the eastern and grass in the western part. The strict relationship is that seed production is appropriate to the drier, and leaf production to the wetter, districts.

The great soil belts of England south of the Trent run in a south-westerly direction; north of the Trent, however, they run north and south. A heavy soil, like a wet climate, favours grass production; a light soil, like a dry climate, is suitable for arable crops. The great influence of climate is modified, but not overridden, by the soil factor.

The arable farmer grows three kinds of crops: corn, clover or seeds hay, and fodder crops for his

The hope is expressed by the author that a like method of attack may prove to be of use as a guide to the divining of the position of faults beneath a cover of unconformable strata in other districts—e.g. in concealed coalfields, where dolerites or other rocks containing a high proportion of magnetite are present. Unfortunately, however, or fortunately from the point of view of the coal miner, dolerites are not an invariable concomitant of coal seams, and it therefore follows that the use of the method in determining the limits of concealed coalfields would appear to be somewhat restricted.

animals or potatoes for human beings. The same general principles underlie all, and as corn crops are of the most general interest (though not necessarily of the greatest importance), they will serve to illustrate all the points it is necessary to bring out. We have seen that wheat is cultivated more in the eastern than in the western portion of the country. The figures for consumption and production are as follows:—

	Consumption in United Kingdom	Production in England and Wales			Production in United Kingdom		
		Before war 1914	1918	1919	Before war 1914	1918	1919
Wheat ..	7.40	1'0	2'3	1'8	1'7	2'0	2'0
Barley ...	1.96	1'2	2'0	1'1	1'6	1'5	1'3
Oats ...	4.30	1'4	2'0	1'6	3'0	4'5	4'2

During the war very serious attention was paid to the problem of reducing the gap between consumption and production. A working solution was found by lowering the milling standard, retaining more of the offal, and introducing other cereals and potatoes; a very considerable proportion of the resulting bread was thus produced at home. But the war-bread did not commend itself, and disappeared soon after the armistice; since then the consumption of wheat has gone up, and the divergence between consumption and production has again become marked. There is no hope of reducing consumption; we must, therefore, increase production. Additional production may be obtained in two ways: by increasing the yield per acre, and by increasing the number of acres devoted to the crop.

The yield per acre is shown in the following table:—

	Measured Bushels per Acre. <sup>2</sup>		A good farmer expects	Highest recorded yield
	England and Wales	Scotland		
Wheat ...	31.0	39.9	40 to 50	96
Barley ...	31.9	35.4	40 to 60	80
Oats ...	39.3	38.9	60 to 80	121

The average results include bad farmers and bad seasons; the good farmer expects to do considerably

<sup>2</sup> Unfortunately the terms "bushel" and "quarter" (8 bushels) lack definiteness, being used officially in three different senses and unofficially in several others also. The following are some of the definitions of a bushel:—

Official Statistics.	Corn Returns Act.	Grain Prices Order.	Frequent Practice.
A definite volume having the following average weight	Volume occupied by following weight	Volume occupied by following weight	Volume occupied by following weight
lb.	lb.	lb.	lb.
Wheat ... 61.9	60	63	63
Barley ... 53.7	50	55	56
Oats ... 39.3	39	42	42

<sup>1</sup> Discourse delivered at the Royal Institution on Friday, February 20.

better, but he has many things in his favour: superior knowledge, greater command of capital, and possession of good land; he will, therefore, always stand above the average. Even his results can be improved; the highest recorded yields show what can be done with present varieties and present methods in exceptionally favourable circumstances. The figures give the measure of the scientific problem, which is to discover what changes would be necessary in order to bridge the enormous gap between the average and the best. In three directions progress is possible; we may modify the plant or the soil, or we may mitigate the effects of unfavourable climate.

Before the soil can be brought into cultivation at all it is necessary to carry out certain major operations—draining, enclosing, etc.—which have to be maintained in full order. These lie outside our present discussion; we must assume that they are properly carried out, which is by no means always the case. Given adequate drainage, soil conditions are profoundly modified by cultivation, which has developed into a fine art in England and Scotland, and is, indeed, far better practised here than in most other countries. But it is an art, and not yet a science; the husbandman achieves the results, but no one can yet state in exact terms precisely what has happened. A beginning has been made, and a laboratory for the study of soil physics has been instituted at Rothamsted and placed under Mr. B. A. Keen, where we hope gradually to develop a science of cultivation. For the present cultivation remains an art, and, further, it is essentially a modern art. The medieval implements, as shown in the Tiberius MS. (eleventh century) and the Luttrell Psalter (fourteenth century), were crude, and left the ground in an exceedingly rough condition. Great advances were made throughout the nineteenth century. Robert Ransome, of Ipswich, took out his first patent in 1785 to improve the plough; he was followed in 1812 by Howard, of Bedford, and later by Crosskill, Marshall, Rushton, Fowler, and others, who have made British implement-makers famous throughout the world. Given time and sufficient labour, the good British farmer using modern implements can accomplish wonders in the way of cultivation.

Unfortunately, neither time nor labour is always available. Ploughing is possible only under certain weather conditions, and there are many days in our winters when it cannot be carried out. Unless, therefore, a large staff of men and horses is kept, the work often cannot be done in time to allow of sowing under the best conditions.

The early days of the life of a plant play almost as important a part in its subsequent history as they do in the case of a child. Illustrations are only too numerous of the adverse effect of being just too late for good soil conditions. One from our own fields is as follows:—

Work completed	Seed sown	Yield of wheat 1916 1917 Bushels per acre
Just-in time ...	Nov. 24, 1915	26.8
Just too late ...	Feb. 17, 1916	19.3

The farm-horse will not be speeded up, but maintains an even pace of 2½ miles per hour. According to the old ploughman's song still surviving in our villages, an acre a day is the proper rate:—

We've all ploughed an acre, I'll swear and I'll vow,  
For we're all jolly fellows that follow the plough.

But under modern conditions it is impossible to get more than three-quarters of an acre a day ploughed on heavy land, and the scarcity of teams threatened to bring arable husbandry into a hopeless *impasse*. Fortunately for agriculture, the internal-combustion engine appeared on the farm at a critical moment in

the shape of the tractor, and has brought the promise of a way out.

The tractor has two important advantages over the horse. First of all, it works more quickly. Its pace is 3½ miles per hour instead of 2½ miles. It turns three furrows at a time instead of one only; on our land it ploughs an acre in four hours instead of taking nearly a day and a half, as required by horses. There is no limit to the work it can do; even an acre an hour is no wild dream, but may yet be accomplished. It therefore enables the farmer to get well forward with his ploughing during the fine weather in late summer and early autumn, and thus to obtain the great advantages of a partial fallow and of freedom to sow at any desired time. On our own land our experience has been as follows:—

Dates of Completion of Sowings of Wheat and Oats.

Year	Wheat	Oats	} Horses only
1916	February 17	October 16	
1917	March 16	" 17	
1918	January 26	" 27	
1919	November 26	" 5	Tractor

Further, if the plough is correctly designed and properly used, the tractor does the work fully as well as horses—even the horse-ploughman admits that. It therefore increases considerably the efficiency of the labourer, which, as we shall see later on, might advantageously be raised. The cost of working is apparently less, though it is difficult to decide this until one knows what the repairs bill will be. In our case the cost is:—

	Cost of Ploughing per Acre, Autumn, 1919.	
	By tractor s. d.	By horses s. d.
Labour ... ..	7 7	10 2
Maintenance ... ..	—	22 6
Oil and petrol ... ..	7 8	—
Depreciation and repairs ...	6 3	—
	21 6	32 8
Time taken ...	4 hours	1½ days

The internal-combustion engine is only just at the beginning of its career on the farm, and no one can yet foresee its developments. It is being used at present simply like a horse, and is attached to implements evolved to suit the horse. But it is not a horse; its proper purpose is to cause rotation while it is being used to pull, and in some cases, indeed, this pull is reconverted into rotary motion.

The second great method of improving soil conditions is to add manures and fertilisers. Farmyard manure is more effective than any other single substance; it is likely to remain the most important manure, and if available in sufficient quantity it would generally meet the case. Realising its importance, Lord Elveden generously provided funds for extended investigations at Rothamsted into the conditions to be observed in making and storing it. This work is still going on, and is leading to some highly important developments.

Farmyard manure, however, is not available in sufficient quantities to meet all requirements. The chemist has long since come to the aid of the farmer; he has discovered the precise substances needed for the nutrition of the plant, and prepared them on a large scale. Like cultivation, this is largely a British development; it was in London that the first artificial manure factory was established in 1842, and for many years the industry was centred in this country. The fertilisers now available are as follows:—

**Nitrogenous**—Nitrate of soda, nitrate of lime, sulphate of ammonia, and cyanamide (nitrolim).

**Phosphatic**—Superphosphate, basic slag, mineral phosphate, guano, and bones.

**Potassic**—Sulphate of potash, muriate of potash, and kainit.

Agricultural chemists have worked out the proper combinations for particular crops, and obtained many striking results.

Without using any farmyard manure they have maintained, and even increased, the yield of corn crops, fodder crops, and hay; and in the two latter cases there has been an increase, not only in yield, but also in feeding value per ton. In spite of seventy years' experience there is still much to be learned about the proper use of artificial fertilisers, and they may still bring about even fuller yields from the land.

The yield of corn crops can be increased by artificial fertilisers, but not indefinitely; the limit is set by the strength of the straw. As the plant becomes bigger and bigger, so the strain on the straw increases, until finally, when the plant is some 5 ft. high, it cannot stand up against the wind, but is blown down.

Little is known about the strength of straw. It is a property inherent in the plant itself, and differs in the different varieties. It is affected by the season, being greater in some years than in others. It is affected also by soil conditions. At present the strength of the straw is the wall against which the agricultural improver is pulled up. The problem can undoubtedly be solved, and the plant-breeder and soil-investigator between them may reasonably hope to find the solution.

Another great effect of artificial fertilisers which has not yet been fully exploited is to mitigate the ill-effects of adverse climatic conditions. Phosphates help to counteract the harmful influence of cold, wet weather; potassic fertilisers help the plant in dry conditions. The combination of a suitable variety with an appropriate scheme of manuring is capable of bringing about considerable improvement in crop production.

A demonstration with the oat crop on these lines was arranged last year in a wet moorland district, and the crops when seen in August were as follows:

Local variety, local treatment ...	Estimated crop		Harvest late
	Bushels.		
" " phosphatic manuring ...	45-54	"	earlier
Special variety "Yielder," phos- phatic manuring ... ..	54-66	"	earlier, stands up well

The potato crop is governed by the same general principles as corn crops. It furnishes more food per acre than any other crop, but it is much more expensive to produce, and therefore is grown chiefly in districts where the conditions are particularly well suited to it: the Fens, Lincolnshire, the plains of Lancashire, and the Lothians, though smaller quantities are grown in almost every part of the country. The production and consumption are as follows:—

**Potatoes: Annual Production and Consumption.**

Consumption	Production					
	In England and Wales			In United Kingdom		
	Pre-war 1914	1918	1919	Pre-war 1914	1918	1919
6.5	3.0	4.2	2.7	7.5	9.2	6.3
Millions of acres	0.46	0.63	0.43	1.20	1.51	1.22

We are thus self-supporting in the matter of potatoes. We do, however, import about half a million tons per annum of early and other potatoes; we also export seed potatoes and some for food—in all, about one million tons per annum.

(To be continued.)

## Notes.

We regret to announce the death, on April 3, at eighty-four years of age, of Capt. E. W. Creak, C.B., F.R.S., formerly Superintendent of Compasses, Hydrographic Department, Admiralty.

The following names were inadvertently omitted from the list of Commanders of the Order of the British Empire (C.B.E.) announced in last week's issue of NATURE:—Mr. C. E. Fagan, secretary, British Museum (Natural History); Sir W. H. Hadow, Vice-Chancellor of the University of Sheffield; and Mr. A. R. Hinks, F.R.S., secretary of the Royal Geographical Society.

LORD SUDELEY has given notice of the following motion which he proposes to bring before the House of Lords on April 21:—"To call attention to the decision of his Majesty's Government to discontinue the appointment of an official guide at Kew Royal Botanical Gardens; and to move to resolve, That the Government be requested to carry out at these gardens the system of free popular guide-lectures on the same plan as adopted with marked success in the Government museum and picture galleries of the Metropolis, and to take such further steps as after inquiry may be found desirable for developing the resources of these gardens to the fullest extent in the interests of scientific and popular education, together with the recreation of the public."

THE RIGHT HON. F. D. ACLAND recently asked in the House of Commons whether the Lord President of the Council "is aware that dissatisfaction is being expressed by scientific workers with the appointment of a man without scientific qualifications as director of research to the Glass Research Association; whether, as the Department of Scientific and Industrial Research provides four-fifths of the funds of the association, the Department was consulted before the appointment was made; and does he approve of the appointment as giving a guarantee that State funds devoted to scientific research will be wisely expended?" Mr. Fisher replied to the question, and his answer included the following statements:—(1) The successful candidate has a wide and successful experience of scientific research into the problems of the glass industry, and is considered by the association to be the man best suited for organising and directing the research needed by it. (2) The responsibility for the selection of a director of research rests in each case with the research association concerned, and not with the Department of Scientific and Industrial Research, which has no power to approve or disapprove the appointment of any individual. (3) The Department guarantees three-quarters of the expenditure of the research association up to a certain limit, but payment of the grant is conditional, among other things, on the approval by the Department of the programme of research and of the estimate of expenditure thereon. (4) The Advisory Council of the Department, after considering all the relevant circumstances with great care, recommended the approval of the expenditure involved in this director's appointment.

MR. B. D. PORRITT has been appointed director of research by the Research Association of British Rubber and Tyre Manufacturers.

THE annual meeting of the Iron and Steel Institute will be held at the Institution of Civil Engineers, Westminster, on Thursday and Friday, May 6 and 7, and will be adjourned from May 7 to May 14, when a final session will be held at the Mappin Hall, Sheffield. On the opening day the retiring president, Mr. Eugène Schneider, will induct into the chair the president-elect, Dr. J. E. Stead, the Bessemer gold medal for 1920 will be presented to Mr. Harry Brearley, and the president will deliver his inaugural address. The autumn meeting of the institute will open at Cardiff on September 22.

THE World Trade Club, of San Francisco, which is conducting an active propaganda in favour of the compulsory adoption of the metric system of weights and measures, both in this country and in the United States, has issued under the title "Metric Literature Clues" a list of references to books, pamphlets, documents, and magazine articles on standardisation in terms of metric units. Although far from being a complete bibliography of the metric system, it includes most of the best-known works on the subject, and contains a fairly full list of the publications of the United States Government and of the Bureau of Standards. In some cases the title of a book or article is followed by a brief summary of its contents, sufficient to indicate to those interested in weights and measures whether it is worth while consulting the work in question. This is the most practical and useful publication of the World Trade Club with regard to the metric system that has yet come to our notice.

At a meeting of the Association of Economic Biologists held on March 24 the following papers were read: (1) Mr. D. W. Cutler, "The Relation of Protozoa to Soil Problems"; (2) Mr. J. F. Martley, "The Resin-Galls of the Wood of the Sitka Spruce (*Picea sitchensis*)"; (3) Dr. W. Lawrence Balls, "The Nature and Scope of Botanical Research in the Cotton Industry"; (4) Dr. M. C. Rayner, "The Calcifying Habit in Ling (*Calluna vulgaris*) and other Ericaceous Plants"; (5) Dr. H. Wormald, "Shoot Wilt of Plum Trees." Perhaps the outstanding feature of the meeting, emphasised alike in papers and discussion, was the necessity of pure research as a basis for all economic applications of biology. Not only is it impossible to conduct investigations into any applied aspect of a biological problem in which at the same time equal attention is not given to the more fundamental considerations, but more usually it is also not possible to separate the economic from the pure issues. A further point of importance, arising particularly in the discussion on Dr. Balls's paper, is the great shortage in this country of young botanists competent to undertake research on industrial problems. With the expected development of research associations and the partial recognition by manufacturers of the vital place of the botanist in industry, this factor will become increasingly apparent and be a serious menace to progress.

THE Port Erin Biological Station will be occupied during the Easter vacation (March 20 to April 20) by nine or ten professors, each with a group of senior students, including Profs. Doncaster, Harvey-Gibson, Johnstone, and Herdman (Liverpool), Prof. Gamble (Birmingham), Dr. Tattersall (Manchester), Mr. Douglas Laurie (Aberystwyth), Prof. Benjamin Moore (London), Prof. Cole (Reading), Prof. Stephenson (Lahore), and Prof. Dakin (Western Australia). There are also groups of other post-graduate workers and senior students from Cambridge, Nottingham, Liverpool, and other centres, as well as a large botany class in the earlier part of the vacation, to be followed by a zoology class later. The laboratory accommodation is strained to the utmost capacity, and additions to both building and staff are urgently required. The usual excursions for shore-collecting and plankton work and dredging are being arranged, and the fish-hatching is in full swing. The season is an early one at sea. The phyto-plankton has consisted for the last ten days of March mainly of *Coscinodiscus* and *Biddulphia*, and the plaice in the spawning-pond have produced fertilised eggs at least a month earlier than usual—the first hatched larvæ were noticed on February 9—and herring are being caught each night in the bay. The Bill transferring the biological station and fish hatchery from the Manx Government to the Oceanography Department of the University of Liverpool has now passed through the House of Keys, and the University takes over the control of the institution and the work as from April 1 last. The director wishes it to be known that this makes no change in the use of the biological station by researchers from other universities.

THE Ministry of Agriculture and Fisheries last year purchased an estate of more than 1500 acres of typical heath-land at Methwold, in Norfolk. This estate is to be a National Demonstration Farm, and one of the chief objects for its existence is to show what can be obtained from poor heath-land by the adoption of good husbandry methods. The Weekly Service for March 20 from the Ministry of Agriculture gives a short account of the work to be undertaken at this farm. Two hundred acres of the estate have been reclaimed from bracken land, so that at the present time 1043 acres are under arable cultivation, 43 acres under grass, and 441 acres are waste heath. The chief part of the scheme will be the building up and improvement of the land by chalking and by the addition of organic matter. Tobacco-growing on a comparatively large scale will also be a feature of the cultivation. By encouraging the growing of this crop the Ministry hope to supplement the experimental work carried out during the past six years by the British Tobacco Growers' Society, Ltd., and also to assist those smallholders in the neighbourhood who may be inclined to try tobacco-growing when there is a central station at hand to supply the necessary information and to provide for the treatment of the crop. The scheme also includes stock-rearing, poultry-keeping, and pig breeding and rearing on the open-air system. The result should prove very valuable both for large-scale farmers and for smallholders, since the

fields are of a good size and well adapted to the use of implements of a large, up-to-date form, while the light and early character of the land should render it specially suitable for small arable dairy holdings.

The revival of Oriental research is happily marked by the reappearance of Prof. Flinders Petrie's admirable journal, *Ancient Egypt*. Great changes have occurred since the outbreak of hostilities. In Egypt the main actors are gone—Sir Gaston Maspero, his son Jean Maspero, Legrain, and Barsanti. On the English side the losses have been equally severe—Sir A. Ruffer, H. Thompson, I. Dixon, and K. T. Frost, all victims of the war; and at home the early death of Prof. Leonard King has left history and archaeology crippled. But, so far as was possible, work has gone on, particularly under the new conditions in Palestine, where a school of archaeology, under the superintendence of Prof. Garstang, is being founded. The British School in Egypt is starting work with a large staff, and in the United States, under Prof. Breasted, the Oriental Institute of the Chicago University has been opened. But funds are badly wanted both in Egypt and in Palestine, and though this is an unfavourable time for such an appeal, there is good hope that British archaeologists will provide the necessary assistance.

In the *Museum Journal* (vol. x., No. 3, September, 1919) Mr. H. V. Hall discusses the question of African art. So much has been said, Mr. Hall remarks, about the uniformity of African culture that the variety which exists tends sometimes to be overlooked. The people of eastern and southern Africa are chiefly interested in the products of the animal, those of central and western Africa in the products of the vegetable kingdom. Speaking broadly, the region east of the lakes and south of the Zambezi-Congo watershed is the home of pastoral tribes, and the Congo and the Lower Niger races practise agriculture. Hence the latter have more leisure to devote to art-work. The question of foreign influence on the negro is of great importance. There are at least four routes from the north and north-west by which the dark heart of the continent can be reached. A growing mass of evidence points to the conclusion that, even in historic times, these routes have never been quite barred to civilising influences; especially in the expansion of old Egypt the solution of many problems of culture apparently indigenous in Central Africa must be sought.

A COMMITTEE appointed by the Royal Anthropological Institute is engaged in collecting information regarding megalithic monuments. As an example of the scientific method of conducting such a survey, Messrs. J. S. Wilson and G. A. Garfitt, in the March issue of *Man*, supply a map of the Eyam Moor circle in Derbyshire. This work is important in connection with Sir Norman Lockyer's investigations. "In the survey of the Eyam Moor circle several large stones were noted on the near horizon towards the N.E. and E. The path of the sun at sunrise for the latitude of the circle, after making allowances for refraction, was

calculated for different declinations of the sun and plotted on the chart. It will be seen that the position of prominent stones plotted on the diagram appears to mark the position of sunrise at midsummer and at the equinox. On the diagram the position of sunrise is shown for the present obliquity of the ecliptic, or sun's apparent declination of  $23^{\circ} 27'$ , also for an obliquity of  $23^{\circ} 57'$ , which, according to the estimates of astronomers, would have been correct 2000 years before the Christian era. The small difference in the position of the sun indicates the difficulty of fixing the age of a monument by this means."

THE Department of Agriculture, Federated Malay States, in view of the necessity for an increased local production of foodstuffs, has issued a special Bulletin (No. 30) on "Food Production in Malaya," compiled by Mr. F. G. Spring and Mr. J. N. Milsum. The booklet contains 112 pages and 12 plates, costs one dollar, and brings together a large amount of useful information. It includes sections on seasons and rainfall, types of land (whether coastal or inland), soils, tillage, agricultural machinery, rotation of crops, manures, and insect pests and other diseases. Suitable cereal, pulse, and root crops are described, and their cultivation, harvesting, yield, and economic uses considered in some detail. The principal cereals are ragi (*Eleusine coracana*) and rice; various millets and sorghum form subsidiary crops; the chief pulses are green and black gram, cow-pea, and the ground-nut; and the chief root-crops sweet potato, yams, and manihot (tapioca).

A SYSTEMATIC enumeration of the palms of the Philippines is given by Dr. O. Beccari in the *Philippine Journal of Science* (vol. xiv., No. 3). One hundred and twenty species are at present known to be indigenous, which, with the exception of about a dozen species of relatively wide geographic distribution, are endemic forms. In discussing the relationships of the palm-flora, Dr. Beccari concludes that the Philippine species have in great measure originated in the archipelago, but their phylogeny may be traced to species growing chiefly in Borneo, Celebes, the Moluccas, and Indo-China, excluding about a dozen species which, possessing adaptations for easy dissemination, have a rather wide distribution. A small Polynesian element is represented by *Adonia*, the only genus peculiar to the archipelago, and *Heterospatha*. In the Philippines a few large genera have given rise to numerous species, whereas in Polynesia monotypic or oligotypic genera are numerous, and no genus contains a great number of species.

THE *Meteorological Magazine* for March gives a short notice of the work of the International Meteorological Conference held in Paris in October last, taken from the account of the conference published in Paris by the Bureau Central Météorologique. Further details will be welcomed when they are published by the meteorological authorities in our own country. The preceding meeting of the body was held at Innsbruck in 1905, so that much advance in the



science had to be reported and new methods of working arranged for, especially with regard to aviation. The magazine contains a reproduction of a photograph of the members of the conference.

THE Meteorological Office chart of the North Atlantic Ocean for February contains some notes on the origin and distribution of ice in these waters, and some account of the ice patrol of the United States Government which was resumed in 1919 after several years' interruption during the war. Two coastguard cutters have been detailed for the purpose of locating icebergs and pack-ice in the vicinity of trans-Atlantic steamship routes. During the months of April, May, and June the two vessels alternate on patrol, each taking fifteen days in the ice region, exclusive of the time taken in going to and from Boston for coal and supplies. Movements of ice are reported by wireless at fixed hours daily. At 6 p.m. (75th meridian time) ice information is sent broadcast with a 600-metre wavelength. The message is repeated three times. At 6.15 p.m. the same information is sent out, using a 300-metre wave-length. At 4 a.m. a message defining the native and southern limits of the ice is sent to the New York Hydrographic Office. Ice information is also sent at any hour to any ship with which the patrol vessel can communicate. It will be recalled that this is the work which was initiated by the *Scotia* subsequent to the loss of the *Titanic*. The chart also bears an interesting map showing the drifts on the east coast of Greenland, in Baffin Bay, and in Davis Strait of various ships that have been imprisoned in the ice, and of castaway crews during the last hundred years. The March chart gives an account of the relation of the North Atlantic ice to currents and fogs.

CHERRAPUNJI, in the Khasi Hills in India, is often cited as having the greatest known annual rainfall. According to the Indian Meteorological Department, the mean annual rainfall there is 426 in. The greatest precipitation is said to have occurred in 1861, when a rainfall of 905 in. was recorded, though doubt has been expressed as to the accuracy of this record. It appears, however, that the Cherrapunji rainfall is surpassed by records on the mountains in the Hawaiian islands. Thus Mount Waialeale is the peak (5080 ft.) of the Island of Kauai, but is inaccessible except to the most expert mountaineers. On this account it was very difficult to maintain the station, and the record has finally had to be discontinued. According to the *Monthly Weather Review* (U.S. Dept. of Agric.), vol. xlvii., No. 5, during the periods August 2, 1911-March 26, 1914 and May 31, 1915-August 13, 1917, a total of 1782 days, there was recorded on Mount Waialeale a total precipitation of 2325 in., or an average of 1.3047 in. per day. In a 365-day year this would amount to an annual precipitation of about 476 in. No records were obtained during the years 1914 and 1918, but these years were considered the wettest since the local Weather Bureau Office was established in the Hawaiian islands. Comparative estimates from trustworthy records obtained at nearby stations indicated that the rainfall at Waialeale must have exceeded 600 in. From May 21, 1915-

May 30, 1916, the recorded rainfall of Mount Waialeale was 561 in. The Hawaiian islands are known for other very damp spots. Thus Puu Kukui, 5000 ft., on the Island of Maui, had a seven-year average of 369 in. (maximum 562 in. in 1918). On the Island of Hawaii, at a certain spot of 4000-ft. elevation, the rainfall in 1914 amounted to 504 in. At at least a dozen other spots, all more than 1000-ft. elevation, the rainfall in each of the years 1914 and 1918 exceeded 350 in.

TECHNOLOGIC Paper No. 123, by Mr. D. W. Kessler, of the Bureau of Standards, Washington, is devoted to the tests of the physical and chemical properties of fifty of the commercial marbles of the United States. Marble has been selected as the first stone to be tested, but the whole of the deposits of stone in the country are to come under test in course of time in order to provide the knowledge required by architects in designing structures. The tests are of tensile and compression strengths, specific gravity, porosity, absorption of water, effect of freezing, chemical composition, electrical resistivity, expansion with heat, and liability to warping. The trade name and origin of each sample are given, and the tabulated results of the tests fill twenty pages. The properties of the samples differ widely, although the specific gravities do not differ more than about 5 per cent. from each other. On heating, each sample expands, and on afterwards cooling fails to regain its original dimensions. In consequence of this, marble subjected to frequent heating and cooling is liable to warp.

SCIENTIFIC Paper 352 of the Bureau of Standards, Washington, gives the results of the measurements of the expansion of forty samples of porcelain, about the same number of samples of bakelite and similar materials, and about a dozen samples of marble and limestone, made by Messrs. W. H. Souder and P. Hidnert, of the Bureau. The samples were in the form of rods 30 cm. long and 1 cm. square section, and were heated in a horizontal electric furnace. The expansions were measured by a pair of microscopes mounted on a bar of invar. For the porcelain samples the coefficients per degree Centigrade between 0° C. and 200° C. vary from 2 to 20 millionths, according to the composition, and between 200° C. and 400° C. from 3 to 11 millionths. Beryl porcelains have the smallest coefficients. For bakelite and similar materials no values can be given, as there is so much contraction on again bringing the material to its original temperature. The marbles up to 100° C. have coefficients between 5 and  $15 \times 10^{-4}$ , and at higher temperatures larger values. On cooling to their original temperature they show a permanent expansion. When cooled to -80° C. marble expands to nearly the same extent as when heated to 80° C., so that it has its maximum density in the neighbourhood of 0° C.

THE Science Reports of the University of Sendai, Japan, for December, 1919, contain a paper by Mr. S. Konno on the heat conductivities of metals below and above their melting points. The metals were tested in

the form of circular discs about 2 cm. thick and 2.5 cm. in diameter enclosed in a porcelain tube between iron cylinders of the same diameter. In the upper iron cylinder heat was generated by a measured electric current. The fall of temperature through the disc was determined by means of thermo-couples. For tin, lead, zinc, and aluminium the heat conductivity decreases gradually up to the melting point. At the melting point the conductivity decreases abruptly, but in the liquid state its rate of decrease with increase of temperature is slight. Bismuth increases in conductivity on melting, but change of temperature has little effect on the conductivity in either the liquid or the solid state. Antimony has its maximum conductivity at the melting point. In all cases the electrical and heat conductivities change in the same direction on melting, but neither above nor below the melting point does their quotient agree with electronic theories.

THE trouble of working gelatine plates under tropical conditions seems at last to have been overcome. In the *Journal of the Royal Photographic Society* for March, Mr. A. P. Agnew, of Messrs. Ilford, Ltd., describes the "Ilford tropical hardener" that is now supplied by Messrs. Johnson and Sons. Mr. Agnew found that a "quite weak solution of formalin" became very effective when certain salts were dissolved in the solution. Many sodium salts were found useful, while potassium and magnesium salts are not so effective, and ammonium salts are unsuitable. Some salts have no effect, while chlorides, bromides, and nitrates in general have an opposite action—that is, they soften the gelatine. The exposed plate is put into the suitably diluted hardening solution for three minutes, then rinsed and developed, etc., as usual. Plates so treated at temperatures varying from 100° to more than 140° F., then fixed in a plain hypo solution at 40° F., and finally washed for two hours at more than 100° F. remained firm and did not even show signs of reticulation. Such trying conditions as these would never occur in practical work.

A PHOTOGRAPHIC developing agent must be able to reduce silver bromide that has been changed into the developable condition, as by exposure to light, while under the same conditions it is unable to reduce silver bromide that has not been so changed. There are many reducing agents that make no distinction between these two states of silver bromide. Some twenty years ago Messrs. A. and L. Lumière found certain details of chemical constitution that appear to confer developing power, and since then they and others have extended the investigation. In the *British Journal of Photography* for March 26 there appears a translation of a paper by Dr. Seyewetz (of Lumière's) in which the author summarises our present knowledge of this matter. Knowing the necessary constitution, a very large number of developers have been introduced and actually put upon the market, but the greater number have commercially disappeared, because in some way or other they were inconvenient to use. Dr. Seyewetz says that it is improbable that new developers will displace those now in common use. As in the case of dyes, it seems difficult

to make sensational discoveries, and there is so far no indication of the direction in which to seek for new developers that would prove acceptable, as, for example, by permitting a reduction in the period of exposure.

BESIDES the paper on H.M.S. *Hood*, read at the recent meeting of the Institution of Naval Architects by Sir Eustace d'Eyncourt, there are important articles in the *Engineer* and *Engineering* for March 26 dealing with this ship. The building was commenced in April, 1916, at the Clydebank yard of Messrs. John Brown and Co., Ltd., the first of the main belt armour-plates (32 tons each) reached the yard in June, 1918, the ship was launched on August 22, 1918, and the fitting out was completed in January of this year, when the huge ship passed down the Clyde to the open sea. On the trial trips the turbines developed 157,000 shaft-horse-power, the speed attained being 32 knots. The overall length is 860 ft., the extreme breadth 104 ft., the mean load draught 28.5 ft., and the displacement at load draught 41,200 tons. The hull is fitted with a bulge or blister for securing the ship against effective attack by torpedo. The armour ranges from 12 in. thick amidships to 5 in. aft. The deck over the magazines is 3 in. thick. There are eight 15-in. guns, all on the middle line, each pair being mounted in an armoured barbettes. The secondary armament consists of twelve 5.5-in. guns, and there are four 4-in. anti-aircraft guns mounted on the superstructure. The ship is fitted with six torpedo tubes for 21-in. torpedoes. There are eight electric generators, four of which are driven by reciprocating engines, two by geared high-speed impulse turbines, and two by eight-cylinder Diesel oil engines. About 360 electromotors are installed, ranging from  $\frac{1}{2}$  to 140 brake-horse-power.

SIR ALFRED EWING is bringing out almost immediately, through the Cambridge University Press, a treatise on "Thermodynamics for Engineers," in which the author aims at making readers familiar with the physical bearing of the fundamental ideas of the subject by means of an elementary introduction and by dealing with practical problems in the theory of heat-engines and of refrigeration. A more mathematical treatment of general thermodynamic relations follows. There will also be an appendix sketching in outline the molecular theory of gases, with special reference to internal energy and specific heat. Another book on the list of the Cambridge University Press is by Prof. A. S. Eddington, entitled "Space, Time, and Gravitation." It is promised for the coming summer.

A FORTHCOMING addition to Sir Edward Thorpe's series of Monographs on Industrial Chemistry is of current interest, seeing that it will treat of "The Manufacture of Sugar from the Cane and Beet." It will be by T. H. P. Heriot, of the Royal Technical College, Glasgow, and give special attention to the principles underlying factory operations.

ERRATUM.—On p. 138 of NATURE of April 1, col. 1, line 15 from the bottom of the page,  $bx$  should be  $bx^2$  in the equation  $y = ax^3 + bx^2$ . The fractional index was broken during paging of the issue.

### Our Astronomical Column.

**CAPELLA.**—A knowledge of the parallax of Capella is of special interest owing to the close resemblance of this star's spectrum to that of the sun and the fact that it is a spectroscopic binary with a period of 104½ days. Prof. F. Schlesinger and Mr. Z. Daniel have made a new determination at the Allegheny Observatory (*Astr. Journ.*, No. 765). They observed both the principal star and Fuhrehjelm's distant companion. The weighted mean parallax (absolute) is  $0.068'' \pm 0.006''$ . Earlier results are: Elkin,  $0.079''$ ; Jost,  $0.051''$ ; and Adams and Joy,  $0.105''$ .

The star B.D.+61° 2068, the proper motion of which is  $0.77''$ , was also measured for parallax at Allegheny, the large value  $0.139'' \pm 0.007''$  (absolute) being found. The corresponding absolute magnitude is 9.3 visual and 10.5 photographic.

Attempts were made some twenty years ago to detect the duplicity of Capella telescopically. It was considered for a time that the 28-in. equatorial at Greenwich gave an elongated image, but, in view of the failure of the great American refractors, little reliance was placed on this. A letter from Prof. Hale dated January 6 last (*Observatory*, March) announces that success has been obtained by interferometer methods with the 100-in. reflector. It was deduced that the separation on December 30, 1919, was  $0.042''$ , and the position angle  $148^\circ$  or  $328^\circ$ . It is hoped that a continued series of such observations will give a determination of the inclination of the orbit, and hence of the masses of the components. There is even a prospect that the diameters of such giant stars as Sirius, Antares, and Betelgeux may be determinable with the interferometer.

**CAPE OBSERVATIONS OF THE SUN, MERCURY, AND VENUS.**—The Cape observations of these bodies, made with the new transit circle and the travelling-wire micrometer during the five years 1907–11, have just been distributed, together with a discussion of results. The corrections to the equinox derived from the three bodies are in good accord, and indicate that Newcomb's system of right ascensions needs the constant correction  $-0.05s$ . The corrections to Newcomb's longitudes of perihelia of Mercury, Venus, and the earth are  $-0.78''$ ,  $+6.8''$ , and  $-7.4''$  respectively. These are of interest in relation to the Einstein controversy. Newcomb applied the corrections to the centennial motion of the perihelia given by the Asaph Hall hypothesis, according to which gravitation varies as  $r^{-2.000000012}$ . This formula gives  $+43.37''$ ,  $+16.98''$ , and  $+10.45''$  for Mercury, Venus, and the earth, whereas Einstein's formula gives  $+42.9''$ ,  $+8.6''$ , and  $+3.8''$ . It will be seen that the adoption of Einstein's law of gravitation by the Nautical Almanac would mean a movement towards Newton's law, not a departure from it.

The following semi-diameters of Mercury and Venus at distance unity were deduced from the observations:—Mercury (latitude observations)  $3.36'' \pm 0.03''$ , (longitude)  $3.79'' \pm 0.17''$ ; Venus (latitude)  $8.67'' \pm 0.03''$ , (longitude)  $8.97'' \pm 0.04''$ . The tabular values are  $3.34''$  and  $8.40''$ . As these depend to a considerable extent on observations made during transits, they are likely to be somewhat too small.

The Cape results may be too large owing to irradiation, but, since all the observations were made in daylight, this is not likely to be excessive. But as the mass of Venus is only five-sixths that of the earth, it is probable that its diameter is also smaller, whereas the Cape figures make it equal to the earth.

### Basic Slag and its Uses in Agriculture.

**A**N important discussion on basic slag and its uses in agriculture, organised by the Faraday Society, at which a number of leading representatives of the steel makers and of agriculturists were present, was held in the rooms of the Chemical Society on March 23. Prof. F. G. Donnan presided over the meeting.

The discussion was opened by Dr. E. J. Russell, who gave a general survey of the subject and indicated the nature of the problems concerned. The basic slag produced by the basic Bessemer process had earned a high reputation as a potent agent in the improvement of poor pastures. The effect is indirect, and results from a stimulation of the white clover—whether the action of the phosphate is on the clover plant or on the nodule organism is not yet certain. But whatever the reason, the effect on pasture land is very marked, and British agriculturists could absorb some 300,000 or 400,000 tons a year if this could be produced. Unfortunately for agriculturists, however, the Bessemer process is in danger of supersession, and the basic open-hearth process is taking its place. This new process gives two kinds of slag, both poorer than the Bessemer slag in phosphates.

One of these slags is made by the use of calcium fluoride, and in consequence is less soluble than the other. The great problem before the investigator at the present time is to enrich the low-grade slags so as to make them better worth grinding and transport than they now are.

Open-hearth slag made without fluorspar has hitherto proved practically as effective as the old Bessemer slag when compared on the basis of equal amounts of phosphorus. Fluorspar slag has proved to be of less value, although considerably better than was at first thought.

It is usually assumed, though by no means proved, that the phosphate is the only effective constituent in the slag. At various times it has been suggested that lime, manganese, or iron might be useful; it is also possible that slag contains a silico-phosphate which might have more value than the ordinary phosphate.

The enrichment of the slag cannot apparently be brought about by any change in the pig iron, owing to the great disparity in price between steel and slag; fractionation is, however, possible, or the addition of ground mineral phosphate to the molten slag. Further experiments would be necessary before any decision can be made.

Sir Thomas Middleton gave an account of the place of basic slag in the agricultural system of this country. British farmers tend more and more to produce animal rather than human food. The two main human food-crops—wheat and potatoes—occupied no more than 3,000,000 acres before the war, while 36,000,000 acres were devoted to the crop requirements of cattle and sheep. The value of the wheat and potatoes was about 27,000,000*l.*, while the live stock brought in some 125,000,000*l.* The supreme importance of basic slag arises from the fact that it helps to produce animal food; it is essentially a pasture fertiliser. In the Cockle Park experiments the untreated pasture yielded about 20 lb. of lean meat per acre per annum; after treatment with basic slag the yield rose to 105 lb. of meat per acre. The results of many other experiments show that on thousands of acres in this country the yield of meat might be increased by the use of basic slag. Nor are the advantages of slag confined to grass land. By ploughing up more grass, valuable additions could be made to the tillage land, and if the remaining grass were treated with basic slag there

would be no falling off in total yield, in spite of the diminished area.

Mr. Bainbridge gave an account of the experiments by Dr. Stead and Mr. Jackson on the solubility of basic slag in citric and carbonic acids. The reason why fluorspar makes the phosphoric acid in slag insoluble is that a reaction occurs between fluoride and phosphate, producing an artificial apatite, which, as regards insolubility, resembles natural fluorapatite. Even the most soluble phosphatic slags undergo this change and become insoluble on melting with fluorspar. Carbonic acid, after long-continued attack, generally dissolves out more phosphoric acid than a single attack by the standard citric acid.

Mr. G. Scott Robertson gave details of the field tests made to compare the effect of various types of open-hearth basic slags on grassland. These experiments were made in Essex on London clay, Boulder clay, and chalk. They show that all the phosphatic slags are effective fertilisers; but there are important differences in the agricultural effects, which are not connected with solubility according to the citric acid test; indeed, this test affords no indication of the fertilising value of open-hearth slags. Details of the botanical examination of the plots showed the striking effect of the basic slags in reducing the amount of bare space and in increasing the amount of clover.

Mr. Daniel Sillars made an important contribution from the metallurgical side, discussing the formation of basic slag in the manufacture of steel. The phosphide of iron,  $\text{Fe}_3\text{P}$ , in which state of combination phosphorus exists in molten iron, is oxidised by reactions of the type—

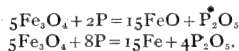

The  $\text{P}_2\text{O}_5$  formed may combine with  $\text{FeO}$  to form  $\text{Fe}_3(\text{PO}_4)_2$ , which, however, is unstable in the presence of a large excess of iron, and a reaction such as  $\text{Fe}_3(\text{PO}_4)_2 + 11\text{Fe} = 8\text{FeO} + 2\text{Fe}_3\text{P}$  results, and it is in consequence of this reaction that the acid process of steel-making is unable to remove phosphorus. In the basic process the presence of lime affords an opportunity to the phosphoric acid to form a stable body by the reaction—

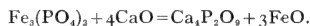

The calcium phosphate formed is only feebly attacked and decomposed by the metallic iron, but manganese and carbon attack it more vigorously and cause the phosphoric acid to be reduced and the metal to be re-phosphorised. These reactions are, of course, proceeding concurrently, and it is necessary to maintain a certain concentration of ferrous oxide in the slag to minimise, so far as possible, the tendency to re-phosphorisation. Re-phosphorisation is probably due to the reaction between ferrous phosphate and lime being slightly reversible, whereby a small concentration of ferrous phosphate is always present, which is reduced by the carbon unless a source of oxygen is supplied by ferrous oxide in the slag.

In ordinary practice the open-hearth process is carried out by allowing the slag formed by the oxidation of the silicon, phosphorus, and manganese to flow over shutes made in the fore-plates into slag-pots under the furnaces, and no attempt is usually made to remove more slag than that which flows out naturally when the level of the slag in the furnace is higher than the level of the fore-plate. The slag left behind is carried on, and forms part of the finishing slag, which latter is therefore much greater in volume, and therefore lower in phosphoric acid, than the slag

removed in the middle of the process. By this method of operation the time spent in tapping the furnace for separation of the slag and for the formation of a new slag is saved, but the slag is inferior both in richness and in citrate solubility if that still forms a criterion of excellence to the agriculturist.

Mr. Ridsdale took part in the discussion, and exhibited specimens of slags examined in the classic investigations by Stead and Ridsdale; and Mr. W. S. Jones contributed a paper on the improvement of low-grade basic slags.

As a result of the discussion it was decided to ask the Ministry of Agriculture to form a Committee which should study possible practical steps to effect improvement in quality and in quantity of the phosphatic slags.

### Verification of Screw Gauges for Munitions of War.

THE *Bulletin de la Société d'Encouragement pour l'Industrie Nationale* (November–December, 1919, No. 6) contains an article by M. Cellerier, of the Conservatoire des Arts et Métiers, on the verification of screw gauges, with particular reference to the methods advocated by Mr. Bingham Powell, who was engaged in the United States during the war as Inspector of Gauges and Standards for the British Ministry of Munitions. These methods related chiefly to the measurement of the full, effective, and core diameters; the verification of pitch was neglected until quite a late period of the war, owing to the lack of instruments possessing the requisite precision and rapidity.

Extreme accuracy is of the highest importance in measurements of pitch, as any error in the pitch makes it necessary for the maximum limit of effective diameter to be reduced by double the amount of this error if the gauge is to be accepted as correct. Where the permissible deviations are very small, an error in pitch of a few ten-thousandths of an inch may thus completely annihilate the tolerance on effective diameter. Inaccuracies of pitch are often regarded as essentially progressive; but this is not always the case, as deformations due to hardening may introduce variable errors of quite appreciable magnitude. The method frequently adopted of verifying the pitch by measurements made on a length comprising a number of threads is accordingly much less trustworthy than the practice, long in vogue in France, of testing separately a number of consecutive threads.

For the latter process measuring machines of the pattern used at the National Physical Laboratory are particularly suitable, but at the time when the demand for extreme accuracy in screw gauges for war-work first became pressing it was impossible to obtain one of these machines in America without considerable delay, and accordingly Mr. Powell found it necessary to devise an instrument on the spot. He dispensed with the optical contrivance which forms an essential feature of the laboratory machine, and substituted for the spherical contacts a lever terminating in a small sphere which rests freely in the screw and can be guided conveniently in the axial plane from one thread to another. The lever consists of a very light needle, arranged in such a way that the apparatus can also be used for testing internal screws or nuts by means of appropriate casts taken by an ingenious and delicate method, but only a small segment of the internal thread can be obtained in this way for testing purposes.

As regards the measurement of diameters, although an ordinary micrometer will suffice for the external dimension, it is not suitable for determining either the effective or the core diameter. Before testing the effective diameters it is necessary to know the errors of the pitch, in order that the appropriate reductions may be made in the maximum limit of tolerance. A micrometer with point contacts should never be used alone for the effective diameter, as it bears only on projecting parts, and, further, the points wear down quickly. Even when new, its contacts for screw-threads rarely have the correct angle. It is, however, a useful check on results obtained by the aid of wire contacts, especially for investigating anomalies which may be apparent in these results.

Mr. Powell has made a special study of wire contacts for testing effective diameters. He employs systematically two series of wires for each pitch of screw. One series is such that the wire bears exactly on the theoretical effective diameter of a perfect screw; in the other series the wire bears on the sides of the screw not far from the outer edge, but so as to avoid the rounded-off part in Whitworth threads. The correct diameters for the series are calculated from a simple formula. The wires, which are finished by grinding, must be perfectly cylindrical, and their diameters have to be ascertained to an accuracy of 0.0001 in.; any error in the diameter of the wire is multiplied threefold in the result obtained for the effective diameter. They are made of hardened steel, and are about 2 in. in length, or longer for very large screws; but their exact adjustment is only necessary over about half an inch in the centre of the length.

The verification of internal screws may be effected simply by employing either an external screw having the correct dimensions for external, effective, and core diameters, or a screw correct for maximum and effective diameters, but slightly small for core diameter. A plug is also used in this case for verifying the minimum diameter of the internal screw. If these gauges enter the nut, the test is regarded as satisfactory; but, in reality, this is not always the case, as the external screw may appear to give a good result even if it bears on only one diameter of the nut; while the other diameters may be far outside the limit of tolerance. A large number of different gauges are necessary in order to verify separately every diameter of an internal screw.

Mr. Powell has drawn up a list of equipment required in the verification of screw gauges. This includes a pitch-measuring machine, an apparatus for obtaining casts of internal screws, a projecting arrangement, an instrument for measuring the three characteristic diameters of external screws, a collection of suitable wire contacts, small triangular prisms for verifying core diameters, standardised micrometers, Johansson gauges, and a complete set of standards for measuring diameters, pitch, and form of internal threads.

A theoretical explanation of the principles of the methods employed would have been of interest. In its absence some doubts arise, for example, as to the practical value of profiles of screw-threads projected on screens. Again, the contacts of small cylindrical wires on the helicoidal surfaces of threads cannot be regarded as the same as that of a circle and two intersecting straight lines, although the formulae employed, which are stated without proof, appear to be founded on a consideration of this kind. In conclusion, Mr. Powell's methods are by no means entirely novel, but they were very successful during the war, and will no doubt be found instructive by all those engaged in the manufacture and verification of screw gauges.

## The Composition of Salvarsan.

WHEN salvarsan was first introduced for use in medicine the German manufacturers stated that it contained "about 34 per cent. of arsenic," which is the percentage calculated for a pure dihydroxydiaminoarsenobenzene dihydrochloride,  $C_{12}H_{13}O_2N_2As_2 \cdot 2HCl$ . This statement was afterwards altered to "the arsenic content of the preparation corresponds to the formula  $C_{12}H_{12}O_2N_2As_2 \cdot 2HCl \cdot 2H_2O$  as a result of Gabel's observation that the drug loses 7.6 per cent. by weight on drying, and contains only 31.5 per cent. of arsenic." Last year Kober, in the United States, ventured the opinion that the combined solvent in salvarsan is not water, but methyl alcohol, and suggested that the latter might be the cause of variable toxicity in salvarsan—a suggestion which is rather far-fetched in view of the fact that, even on Kober's assumption, a maximum normal dose of salvarsan could contain only 0.04 gram of methyl alcohol.

This and other questions connected with the composition of salvarsan have been investigated in the Wellcome Chemical Research Laboratories, and in a paper contributed to the meeting of the Chemical Society on March 18 Messrs. Fargher and Pyman showed that the combined solvent in salvarsan is water; and though small quantities of methyl alcohol may also be present, due to the use of this alcohol in the liquid from which the drug is precipitated, the amount never exceeds 1.4 per cent., and is frequently nil. It was also found that the sulphur always present in commercial salvarsan as a result of the use of sodium hyposulphite as a reducing agent in its preparation, occurs in at least two forms: (1) as a sulphamic acid, probably "salvarsan" monosulphamic acid hydrochloride, and (2) attached directly to arsenic; whilst a third portion may be in physical association with salvarsan, which has certain colloidal properties.

These results support the conclusion expressed in the recent Special Report (No. 44) of the Medical Research Committee, that though salvarsan is not a chemically pure substance, there is no known chemical impurity with the presence or proportion of which its varying toxicity can be brought into relation. In this connection it is interesting to note that a specially pure salvarsan free from sulphur, prepared by Messrs. Fargher and Pyman, was tested by the Medical Research Committee and shown to be more than normally toxic. Chemical testing alone is, therefore, insufficient to determine whether any particular batch of salvarsan is suitable for medical use, and it is on this account that the Medical Research Committee has elaborated the system of biological testing, described in the Special Report already referred to, to control the issue of salvarsan in this country. It is satisfactory that the Committee is able to report that, from the point of view of permanence of effect, the British and French salvarsan preparations are therapeutically as good as the German.

## University and Educational Intelligence.

THE governors of the Huddersfield Technical College have received a gift of 2000l. from Mrs. Mary Blamires, widow of Alderman Joseph Blamires, in memory of her late husband, himself a former student, and afterwards a governor, of the college. The scholarship is to be used for the promotion of research in chemistry.

THE headquarters of the Yorkshire Summer School of Geography, now being organised by the University of Leeds, will this year be the County School, Whitby,

the school buildings having been kindly lent by the governors for this purpose. The object of the Summer School is to provide theoretical and practical instruction in the methods of geography and to furnish opportunities for the discussion and elucidation of problems connected with the teaching of the subject. The course will consist of lectures, laboratory work, field work, and demonstrations. Lectures will begin on Morning morning, August 2, and the course will end on Saturday, August 21. Among the lecturers will be Prof. Kendall (professor of geology in the University of Leeds), Dr. A. Gilligan (lecturer in economic geology), Mr. C. B. Fawcett (lecturer in geography), Dr. W. G. Smith (lecturer in agricultural botany at the Edinburgh and East of Scotland Institute), and Mr. W. P. Welpton (lecturer in education and master of method in the University of Leeds). Applications for tickets should be made to the Secretary of the Yorkshire Summer School of Geography, The University, Leeds.

BEDFORD College for Women, a constituent college of the University of London, and the largest and oldest university college for women in England, has issued an appeal for funds. At the moment, when there is an overwhelming demand by women for higher education and training, the college must either refuse admission to highly suitable students and starve or close down certain departments, or it must enlarge its buildings and increase its endowments. Seven hundred students now crowd into buildings adapted for four hundred and fifty, with the result that in many cases classes have to be triplicated and classrooms and apparatus shared between different departments. A sum of 100,000*l.* is needed for additional lecture-rooms and laboratories. A second 100,000*l.* is required for endowment, notably for scholarships, the various departments of science, the department of social studies, and the training department. A third 100,000*l.* is badly needed for a hostel. An opportunity for acquiring an admirable site just outside Regent's Park has presented itself. Whether the college can take advantage of this must depend on the generosity of the public. It should, perhaps, be emphasised that, apart from such developments, the income of the college is by no means sufficient for its present needs in view of the enormously increased cost of maintenance and the necessity for raising all salaries. The work of universities in the past could never have been done had there not lived generous men and women who believed they could render no greater public service than by endowing colleges and thus furnishing opportunities for rich and poor to acquire sound learning. May we hope that a like generosity and a like belief exists to-day? The Queen's interest in the college is well known, and has taken the practical form of giving a donation. Subscriptions should be sent to Viscountess Elveden, hon. treasurer of the Bedford College Endowment and Extension Fund, Bedford College, Regent's Park, N.W.1.

## Societies and Academies.

LONDON.

**Royal Society**, March 18.—Sir J. J. Thomson, president, in the chair.—W. B. Brierley: A form of *Botrytis cinerea* with colourless sclerotia. A form of *Botrytis cinerea* with colourless sclerotia is described. This was obtained by the isolation and growth of a colourless sclerotium, which was formed in a culture of a normal strain derived from a single spore. The primary origin of the change resulting in the albino form is located in the hyphal mother-cell from which

the initial colourless sclerotium arose. Lotsy's dictum that "certainty of purity is a *conditio sine qua non* to obtain proof of the existence of mutation in living beings" is accepted, and it is shown that such a state is possibly not realisable in the fungi. It is suggested that somatic fusions resulting in a change of genotypic values are the mechanism whereby evolution in the fungi has taken place.—R. R. Gates: A preliminary account of the meiotic phenomena in the pollen mother-cells and tapetum of lettuce (*Lactuca sativa*). In a preliminary study of meiosis in the pollen development of lettuce, several points have appeared which have a general bearing on cytological conceptions and the problems of genetics. The exceptional condition has been found in lettuce, in which every intergrade occurs between pollen mother-cells and tapetal cells. Even synapsis has been observed in binucleate tapetal cells, which emphasises the physiological aspects of the synaptic contraction. The tapetal cells are peculiar in being often very much elongated and lying lengthwise of the anther. Ultimately they break down and form a plasmodium surrounding the pollen-grains. Cytomyxis also occurs, though rarely, during the stage of synapsis in the pollen mother-cells.

March 25.—Sir J. J. Thomson, president, in the chair.—A. R. Forsyth: Note on the central differential equation in the relativity theory of gravitation. The critical equation in Prof. Einstein's theory is—

$$\left(\frac{du}{d\phi}\right)^2 + u^2 = \frac{c^2 - 1}{\lambda^2} + 2\frac{m}{\lambda^2}u + 2mu^3,$$

so that  $\left(\frac{du}{d\phi}\right)^2 = 2m(u - \alpha)(u - \beta)(u - \gamma)$ ,

where  $\alpha, \beta, \gamma$  are proved to be real and positive for the known planetary bodies in the solar system, and are arranged so that  $\alpha > \beta > \gamma$ .

There is no need for initial approximation. The equation can be integrated exactly, in terms of elliptic functions. The integral is—

$$u = \gamma + (\beta - \gamma) \frac{1 + cn \{(\phi - \omega)/\rho\}}{1 + dn \{(\phi - \omega)/\rho\}}$$

where  $\phi = \omega$  at perihelion; the modulus of the elliptic functions is given by—

$$k^2 = \frac{\beta - \gamma}{\alpha - \gamma} \text{ and } \rho = \{2m(\alpha - \gamma)\}^{-1/2}.$$

Further, the advance of the perihelion in one revolution is—

$$4\rho K - 2\pi,$$

where  $K$  is the complete first elliptic integral with the modulus  $k$ . These expressions are accurate (and not approximate) in relation to the initial equation. For approximations in connection with the known members of the solar system,  $k^2$  is small, so that  $K$  is slightly greater than  $\frac{3}{2}\pi$ , and  $\rho$  is slightly greater than unity. The advance of the perihelion is  $2\pi \cdot 3m^2/\lambda^2$ ; and the value of  $u$  is—

$$\frac{m}{\lambda^2} \left\{ 1 + e \cos(\phi - \omega) + \frac{m^2}{\lambda^2} e^2 \sin^2(\phi - \omega) + 3 \frac{m^3}{\lambda^3} e(\phi - \omega) \sin(\phi - \omega) \right\}.$$

—R. D. Oldham: The frequency of earthquakes in Italy in the years 1806 to 1914. The paper is an attempt to discover whether there is any variation in the frequency of earthquakes which can be attributed to the stresses set up by the gravitational attraction of the sun and the moon. In addition to some small and more or less doubtful variations, there was found to be a very marked maximum frequency about the time of the new moon, when the declinations of the sun and moon were of the same sign and at the full

when they were opposite, together with an equally marked minimum frequency at the full when the declinations were the same, and at the new when they were opposite. At the quarters the frequency is about average; at the times of minimum the frequency is about one-third, and at the maximum about five-thirds, of the average. The magnitude, no less than the fact that it is continuously recognisable throughout the record, shows that the variation is a real one, and it is difficult to find any other cause than the effect of the stresses set up by the gravitational attraction of the sun and the moon.—A. F. Duffin: A new apparatus for drawing conic curves. With the apparatus described in this paper the conic is drawn as the polar reciprocal of a circle. A four-bar linkage constrains a pen to trace the locus of the pole of a fixed straight line enveloping a circle upon paper pinned to a rotating drawing-board. The instrument draws conics with precision. It traces the curves at one sweep, and is applicable to all conics.—Capt. J. W. Bipham: An experimental determination of the distribution of the partial correlation coefficient in samples of 30. The distributions are described of the observed values of the partial and total correlations from 1000 samples of 30 each. The three attributes of the sampled (artificial) population are uncorrelated, so that observed values of the correlations are departures from the true value, which is zero in each case. The three groups of 1000 total correlations observed are shown to be nearly Gaussian in form, and to be in very close accord with the distributions predicted in general form by R. A. Fisher, and evaluated in detail in an important co-operative study described in *Biometrika*. The distribution of partial correlations is compared with the Gaussian, the Pearson Type II., and the theoretical distribution of total correlations referred to above. It is found to be closely fitted by the latter, and not to show significantly higher dispersion than is indicated by the usual expression for the standard deviation of total correlations, viz.  $1 - \rho^2 / \sqrt{n - 1}$ . Some important practical bearings of the result are indicated.

## PARIS.

Academy of Sciences, March 1.—M. Henri Deslandres in the chair.—G. Humbert: The number of classes of positive quadratic forms of Hermite, of given discriminant, in an imaginary quadratic body.—Em. Bourquelot and M. Bridel: A new glucoside capable of hydrolysis by emulsin, scabiosin. This glucoside was extracted from the root of *Scabiosa succisa* (devil's bit scabious). Details of its isolation and hydrolysis by dilute sulphuric acid and by emulsin are given.—A. Rateau: The flight altitude which corresponds to a minimum consumption of petrol per kilometre, and the calculation of the best propeller for a given aeroplane.—A. Righi: The experimental bases of the theory of relativity.—A. Mesnager was elected a member of the section of mechanics in succession to the late Marcel Deprez, and A. Fowler a correspondent for the section of astronomy in succession to the late Edmund Weiss.—N. E. Nörlund: The convergence of certain series.—A. Rosenblatt: A theorem of A. Liapounoff.—M. T. Huber: A rational theory of pugging in reinforced concrete, considered as thin plates.—Ch. Fremont: The resistance of steels to cutting by tools. It is well known that steels possessing the same resistance to fracture by tension may differ greatly in the ease with which they can be cut by tools. Instead of the usual calculation, maximum load divided by initial cross-section, the author proposes the term "final resistance," obtained by dividing the maximum load by the actual cross-section of the broken test piece.—J. Guyot and L. J.

Simon: The combustion of methyl esters with a mixture of sulphuric and chromic acids. Analytical figures are given for the wet combustion of sixteen methyl compounds of different types, and the carbon dioxide produced is shown to be practically theoretical.—A. Mailhe and F. de Godon: The preparation of fatty acids by the catalytic oxidation of the primary alcohols. With reduced copper as catalyst, and at temperatures between 260° C. and 270° C., the primary alcohols with air give substantial yields of the corresponding acids. Aldehydes are always produced at the same time, and in some cases more aldehyde than acid is produced.—C. Schlumberger: Attempts at the electrical prospecting of the subsoil.—Mme. Z. Gruzewska: Contribution to the study of laminarine from *Laminaria flexicaulis*. Laminarine cannot be considered as belonging to the dextrin group, having regard to its laevorotatory power and its resistance to the action of acids and alkalis. Its digestibility by the plant diastases shows it to be a reserve material in the marine algæ.—A. Sartory: A new fungus of the genus *Aspergillus* isolated from a case of onychomycosis.—H. Piéron: The variation of energy as a function of the time of stimulation for foveal vision.—A. Vernez and R. Douris: The action of certain precipitates on the solution of the red blood corpuscles.—R. Anthony: The exorchidia of Mesoplodon and the re-ascend of the testicles in the course of the phylogeny of the Cetaceans.—J. L. Lichtenstein: The parasitism of *Aphiochaeta (Phora) fasciata*.—E. F. Gallano: Some histological details of the arterial heart of *Sepia officinalis*.—G. Riquotr: Colloidal complexes and sera. A preliminary injection of a colloid, followed after an interval by an injection of a curative serum, may produce beneficial effects in cases where the serum injection alone has proved to be without effect. Several examples are detailed.—A. Trillat: The influence of the variation of the barometric pressure on the microbial droplets in suspension in the atmosphere.

## Books Received.

A Geographical Bibliography of British Ornithology. By W. H. Mullens, H. Kirke Swann, and Rev. F. C. R. Jourdain. Part iii. Pp. 193-288. (London: Witherby and Co.) 6s. net.

Aristotle. By Dr. A. E. Taylor. Revised edition. Pp. 126. (London and Edinburgh: T. C. and E. C. Jack, Ltd.) 1s. 3d. net.

Wireless Telegraphy and Telephony. By H. M. Dowsett. Pp. xxxi+331. (London: The Wireless Press, Ltd.) 9s.

Wireless Transmission of Photographs. By M. J. Martin. Second edition. Pp. xv+143. (London: The Wireless Press, Ltd.) 5s.

Selected Studies in Elementary Physics. By E. Blake. Pp. viii+176. (London: The Wireless Press, Ltd.) 5s.

Volumetric Analysis. By J. B. Coppock. Revised and enlarged edition. Pp. 100. (London: Sir I. Pitman and Sons, Ltd.) 3s. 6d. net.

A Map of the World (on Mercator's Projection), having Special Reference to Forest Regions and the Geographical Distribution of Timber Trees. Prepared by J. H. Davies. (Edinburgh: W. and A. K. Johnston, Ltd.; London: Macmillan and Co., Ltd.) 8s. net.

A Foundation Course in Chemistry. By J. W. Dodgson and J. A. Murray. Second edition. Pp. xii+240+Answers. (London: Hodder and Stoughton, Ltd.) 6s. 6d. net.

## Diary of Societies.

## THURSDAY, APRIL 8.

INSTITUTION OF AUTOMOBILE ENGINEERS (Graduates' Section) (at 28 Victoria Street), at 8.—W. D. Fife: The Use of Benzol.

ROYAL SOCIETY OF MEDICINE (Obstetrics and Gynaecology Section), at 8.

## FRIDAY, APRIL 9.

ROYAL ASTRONOMICAL SOCIETY, at 5.—E. E. Barnard: Naked-eye Observations of Nova Aquilæ 111.—Col. E. H. Hills: The Suspended Zenith Telescope of Durham Observatory, Part I.—Rev. A. L. Cortie: The Great Sub-spot Groups and the Magnetic Storm, 1920 March 22-23.

CONCRETE INSTITUTE, at 6.—T. J. Clark: The Uses of Concrete.

MALACOLOGICAL SOCIETY OF LONDON (at Linnean Society), at 6.

INSTITUTION OF MECHANICAL ENGINEERS (Informal Meeting), at 7.—C. H. Woodfield and Others: The Cranes: Their Use and Abuse.

JUNIOR INSTITUTION OF ENGINEERS, at 7.30.—A. H. Howe: The Development and Manufacture of the Thermionic Valve.

ROYAL SOCIETY OF MEDICINE (Anaesthetics Section), at 8.15.—(Annual General Meeting), at 8.30.—Mrs. D. Berry and Others: Discussion on Anæsthesia in Operations on the Thyroid Gland.

## MONDAY, APRIL 12.

VICTORIA INSTITUTE (at the Central Hall, Westminster), at 4.30.—Rev. Dr. J. F. H. Thomson: The Pentateuch of the Samaritans: When They Got It, and Whence.

ROYAL GEOGRAPHICAL SOCIETY (at Lower Lodge), at 5.—Col. Sir Sidney Burrard: A Brief Review of the Evidence upon which the Theory of Isostasy is Based.

ROYAL INSTITUTION OF GREAT BRITAIN (General Meeting), at 5.

SOCIETY OF ENGINEERS (at Geological Society), at 5.30.—Prof. E. R. Matthews: (1) Flood Prevention Works at Tron, Ayrshire; (2) The Action of Sea Water on Concrete.

SURVEYORS' INSTITUTION (Junior Meeting), at 7.

ROYAL INSTITUTE OF BRITISH ARCHITECTS, at 8.

ANGLO-ITALIAN SOCIETY (at 74 Grosvenor Street), at 8.—J. W. Scott, Dr. G. E. Moore, Prof. H. Wildon Carr, and Prof. G. Dawes Hicks: Symposium on Is the "Concrete Universal" the True Type of Universality?

ROYAL SOCIETY OF ARTS, at 8.—Dr. W. Rosenhan: Aluminium and its Alloys (Cantor Lecture).

SOCIETY OF CHEMICAL INDUSTRY (at Chemical Society), at 8.—Dr. Winifred E. Brenchley and E. H. Richards: The Fertilising Value of Sewage Sludges.—Dr. E. P. Perman: A New Test for Incorporation.—Prof. T. M. Lowry and L. P. McHutton: Experiments on Deception.

INSTITUTION OF ELECTRICAL ENGINEERS (Students' Meeting) (at Institution of Mechanical Engineers), at 8.—Joint Discussion with the Graduates Association of the Institution of Mechanical Engineers on The Six-hour Working Day and its Effect on Industry.

## TUESDAY, APRIL 13.

ROYAL HORTICULTURAL SOCIETY, at 3.—Dr. A. B. Rendle: Plants of Interest in the Day's Exhibition.

ROYAL INSTITUTION OF GREAT BRITAIN, at 3.—Major G. W. C. Kaye: Recent Advances in X-ray Work.

INSTITUTION OF CIVIL ENGINEERS, at 5.30.—Lt.-Col. J. K. Robertson: Richborough Railway Transporter, Sept.—Major F. O. Stanford: The War Department Cross-Channel Train-Ferry.

ZOOLOGICAL SOCIETY OF LONDON, at 5.30.—Arthur Willey: An Apodous *Amia calva*—H. A. Baylis and Dr. Clayton Lane: A Revision of the Nematode Family Gnathostomidae.—Dr. W. J. Dakin: The Onychophora of Western Australia.—A. M. Alston: The Life-history and Habits of Two Parasites of the Blowfly.

ROYAL PHOTOGRAPHIC SOCIETY OF GREAT BRITAIN (Scientific and Technical Group), at 7.—A. C. Banfield: Prisms.—A. J. Munro: Machinery used in the Manufacture of Photographic Plates.

QUEKETT MICROSCOPICAL CLUB (at 20, Hanover Square), at 7.30.

ROYAL ANTHROPOLOGICAL INSTITUTE, at 8.15.—A. O. Neville: The Western Australian Aborigines; Their Treatment and Care.

## WEDNESDAY, APRIL 14.

ROYAL UNITED SERVICE INSTITUTION, at 3.—Lt.-Col. J. Shakespear: Recent Events on the Assam Frontier.

ROYAL SOCIETY OF ARTS, at 4.30.—J. Thorp: The Fundamental Basis of Good Printing.

BRITISH PSYCHOLOGICAL SOCIETY (Education Section) (at London Day Training College), at 6.—C. A. Barendse: The Factoring of the Will: A Suggested Application of Herington's Work on Reflexes.

ROYAL AERONAUTICAL SOCIETY (at Royal Society of Arts), at 8.—Capt. P. D. Acland: Trans continental Flying.

INSTITUTION OF AUTOMOBILE ENGINEERS (at Institution of Mechanical Engineers), at 8.—Dr. W. H. Hatfield: The Most Suitable Steels for Automobile Parts.

SOCIETY OF PUBLIC ANALYSTS AND OTHER ANALYTICAL CHEMISTS (at Chemical Society), at 8.—A. E. Parkes: The Turbidity Temperature of Fats, Oils, and Fatty Acids, Part I.—Dr. G. W. Monier-Williams: The Interpretation of Milk Records.—Dr. A. F. Joseph and G. A. Frank: The Loss of Free Ammonia from Drinking-Water Samples.—E. Sinkinson: A Decanting and Filter-Washing Machine.

## THURSDAY, APRIL 15.

ROYAL INSTITUTION OF GREAT BRITAIN, at 3.—S. Skinner: Ebullition and Evaporation.

ROYAL SOCIETY OF ARTS (Indian Section), at 4.30.—Sir George Buchanan: The Ports of India: Their Administration and Development.

LINEAN SOCIETY, at 5.—Capt. F. Kingdon Ward: Natural History Exploration on the North-east Frontier of Burma.—R. Paulson: Exhibition of Lantern-slides illustrating Definite Stages in the Sporulation and Gonidia within the Thallus of the Lichen *Evernia prunastri*, Ach.

ROYAL SOCIETY OF MEDICINE (Dermatology Section), at 5.

INSTITUTION OF MINING AND METALLURGY (Annual General Meeting) (at Geological Society), at 5.30.

CHILD-STUDY SOCIETY (at Royal Sanitary Institute), at 6.—Prof. W. Ripman: 2632 Reform.

INSTITUTION OF ELECTRICAL ENGINEERS (at Institution of Civil Engineers), at 6.—Dr. C. V. Drysdale: Modern Marine Problems (Kelvin Lecture).

OPTICAL SOCIETY (at Imperial College of Science and Technology), at 7.30.—J. Weir French: The Unaided Eye, Part III.—R. R. Walls: The Rock Crystals of Brazil.

CHEMICAL SOCIETY, at 8.

## FRIDAY, APRIL 16.

CONCRETE INSTITUTE, at 6.—E. Fiander Etchells: Submission of Plans to Local Authorities.

INSTITUTION OF ELECTRICAL ENGINEERS (Students' Meeting) (at Faraday House), at 7.—J. Scott-Taggart: The Vacuum Tube as a Transmitter and Receiver of Continuous Waves.

INSTITUTION OF MECHANICAL ENGINEERS (Informal Meeting), at 7.—J. E. Baty and Others: Discussion on Planing vs. Milling.

TECHNICAL INSPECTION ASSOCIATION (at Royal Society of Arts), at 7.30.—F. R. Wade: Labour Unrest (Electro-Therapeutics Section), at 8.30.—Sir Ernest Rutherford: Development of Radiology (Mackenzie Davidson Memorial Lecture).

ROYAL INSTITUTION OF GREAT BRITAIN, at 9.—Prof. J. A. McClelland: Ions and Nuclei.

## SATURDAY, APRIL 17.

ROYAL INSTITUTION OF GREAT BRITAIN, at 3.—Prof. W. H. Eccles: The Thermionic Vacuum Tube as Detector, Amplifier, and Generator of Electrical Oscillations.

## CONTENTS.

PAGE

The Universities and the Army	157
Woods and Water Supply. By Dr. Hugh Robert Mill	158
The Wilds of South America	159
Life and Temperature	161
A University Course in Botany	162
Recent Mathematical Text-books. By J. M.	162
Our Bookshelf	163
Letters to the Editor:—	
Knowledge and Power.—"F.O.I.," Dr. John W. Evans, F.R.S.	165
The Secondary Spectrum of Hydrogen.—Prof. J. W. Nicholson, F.R.S.	166
International Council for Fishery Investigations.—Prof. W. C. McIntosh, F.R.S.	167
The Plumage Bill and Bird Protection.—Sir H. H. Johnston, G.C.M.G., K.C.B.; Prof. H. M. Lefroy; Right Hon. Sir Herbert Maxwell, Bart., F.R.S.; Prof. Arthur Dendy, F.R.S.	168
The Magnetic Storm of March 22-23 and Associated Phenomena.—Dr. A. Crichton Mitchell	170
Science and the New Army.—Prof. A. R. Richardson	170
An Electronic Theory of Isomerism.—W. E. Garner; S. C. Bradford	171
Percussion-Figures.—Dr. B. G. Escher	171
A Peculiar Halo. (With Diagram.)—Capt. C. J. P. Cave	171
Sea-birds: Their Relation to the Fisheries and Agriculture. (With Diagram.) By Dr. Walter E. Collinge	172
The Imperial College of Science and Technology	173
Magnetic Disturbances and Geological Structure	175
British Crop Production. By Dr. Edward J. Russell, F.R.S.	176
Notes	178
Our Astronomical Column:—	
Capella	183
Cape Observations of the Sun, Mercury, and Venus	183
Basic slag and its Uses in Agriculture	183
Verification of Screw Gauges for Munitions of War	184
The Composition of Salvarsan	185
University and Educational Intelligence	185
Societies and Academies	186
Books Received	187
Diary of Societies	188

Editorial and Publishing Offices:

MACMILLAN AND CO., LTD.,

ST. MARTIN'S STREET, LONDON, W.C.2.

Advertisements and business letters to be addressed to the Publishers.

Editorial Communications to the Editor.

Telegraphic Address: PHUSIS, LONDON.

Telephone Number: GERRARD 8830.



THURSDAY, APRIL 15, 1920.

### The Encouragement of Discovery.

**D**URING the past few years much has been done by the State to provide facilities for research, but it is not too much to say that even now neither the public nor our statesmen understand the debt they owe to the peculiar and rare geniuses to whom the greatest discoveries are due, or that any attempt has been made to discharge it. Grants for research expenses or for the maintenance of research workers are available from various sources, and much valuable work is being carried on through this aid. What is wanted to complete the scheme is a fund from which pensions or other substantial money grants could be made for scientific discoveries of an epoch-making character, somewhat in the manner of the award of the Nobel prizes. We referred a few weeks ago (March 4, p. 18) to a deputation which waited upon Mr. Balfour, Lord President of the Council, to urge that a sum of about 20,000*l.* should be set aside annually for this purpose; and we trust that this modest provision for the encouragement of genius will be forthcoming.

The January number of the *Journal of the British Science Guild* contains a carefully prepared report on the subject of awards of this nature, with particular reference to medical discovery. The committee which presented the report consisted of eleven men of scientific distinction—five representing the British Medical Association and six the British Science Guild; and the members of it formed the deputation to Mr. Balfour, with the addition of several members of the House of Commons. Two cardinal proposals were made—first, that medical discoveries, even when made accidentally and not as a result of designed investigation, should be encouraged by direct pecuniary reward; secondly, that for losses or outlays incurred by private investigators engaged in medical discovery the State should recognise the principle of compensation.

These two proposals rest on the fundamental fact that, owing to the peculiar nature of medical service and the necessity for carefully adjusted ethical sanctions, the individual medical investigator has often to sacrifice the welfare of himself and his family, although his investigation may have the highest social value. The capacity for discovery, including invention, is very unevenly distributed, but in every field of science rewards, both financial and honorary, act as powerful

evocatives of faculty. In any sphere except medicine, an invention or a discovery has at least a "business" chance of bringing a direct reward, for the investigator can patent his invention or protect himself in some other way. In medicine he cannot patent a new microbe or a new method. The attempts to patent or protect serums or similar products are usually failures, and may end in the removal of a name from the register "for infamous conduct in a professional respect." Probably in this matter the medical profession is too exacting, but there are obvious good reasons for maintaining on the highest ethical level the sanctions of a profession that touch so nearly the private life of the subject. These sanctions, therefore, must continue to be a serious handicap to the medical investigator, who cannot employ the ordinary business methods to secure for himself any profit from his invention, or discovery, or new method of treatment.

If medical discovery is thus shut out from normal commercial reward, there is good ground for the view that the State should establish a system of compensation. To a certain extent, medical research is itself a career, and in the future development of medicine research will offer more and more openings for talent. But meanwhile it is certain that the medical inventor or discoverer has much less chance of making even a respectable living than the clinical medical practitioner. Of this it would be easy to give sufficient proof, but it is not seriously disputed.

Within the medical schools there are many forms of award, such as honorary degrees, money prizes, and the like; but their distribution is largely accidental. Further, the inventor or discoverer has so to specialise his energies that he may positively disqualify himself for the more lucrative administrative or clinical posts. This is more or less true of every branch of applied science, not to speak of pure science; it is overwhelmingly true of medical scientific investigation.

The joint committee and the deputation have uncovered an important scientific area where the State might well recognise a duty to compensate. How profoundly the economic motive operates to increase the production of inventions the Courts for the war awards have abundantly shown. It would be to the ultimate advantage of the State to pay for medical and other scientific discoveries which bring no financial gain to the men who made them: the method of payment is a detail and need offer no more difficulty than that involved in making other awards. The principle is so sound that it ought at once to be conceded.

### English Cytology.

*An Introduction to the Study of Cytology.* By Prof. L. Doncaster. Pp. xiv+280+xxiv plates. (Cambridge: At the University Press, 1920.) Price 21s. net.

THE publication of this volume is to be regarded as an event in the progress of cytology. Prof. Doncaster's new book is not intended to serve as a text-book on cytology, though it contains a wealth of facts; but its aim is to interest the senior student in the subject by pointing out the way in which cytology is related to the great fundamental problems at the root of all biological research. Quite recently Paul Buchner, of Munich, published a new "Handbuch" of cytology, and it is with pride that we compare the work before us with its German prototype. A great deal of the material in Prof. Doncaster's book is new, and the work is as strictly up-to-date as is possible when one is dealing with a vast and changing subject such as cytology.

The author's conception of the cell is very broad; he recognises the important part played by the nucleus, but pays due attention to the Golgi apparatus and mitochondria, which he considers may be of special importance in the life of the cell; useful discussions on the structure of protoplasm, such as are illustrated by Hardy's work, and on Hertwig's conceptions of the "karyoplasmatic ratio," are added to this part of the book. The question of the origin and relationships of the centrosome has been treated in a masterly way, and the author shows how J. W. Jenkinson's work on the fertilisation of the Axolotl can provide a middle way between the divergent views—that centrosomes arise from pre-existing centrosomes, and that they may be formed *de novo* in the cytoplasm.

Prof. Doncaster steers a careful course through the troubled waters surrounding the various questions with regard to astral rays, spindle fibres, and "mitokinetism." He gives a fair and lucid *exposé* of the various ingenious hypotheses brought forward to explain mitotic division, but concludes that, at present at least, no really satisfactory explanation of the phenomenon of mitosis has been given.

Students of cytology are often turned away from entering into the various problems associated with the behaviour of the chromosomes in the germ-cell cycle by the fact that the whole question is obscured by a multitude of ill-digested descriptions, theories, and hypotheses. Prof. Doncaster has written an exceptionally clear and able

account of the typical behaviour of the chromosomes. Never polemical, he gives a straightforward account which includes on a broad basis all the most modern work on the chromosomes. His first description of maturation is written with an eye to his later accounts of the chromosomes in sex and Mendelism, but he is careful not to confuse his preliminary survey by bringing in debatable matter. Here the student will find a conveniently introduced *résumé* of the Chiasmotypy hypothesis of Janssens, which has gained such prominence among Mendelians.

The modern work on the behaviour of the cytoplasmic inclusions during spermatogenesis has been the subject of careful descriptions. Prof. Doncaster has treated the matter in an able manner, and the worker unacquainted with the Golgi apparatus and mitochondria will find in this book a readable and accurate account of the present state of our knowledge. The various questions surrounding the formation of egg yolk are not treated at length, and should be included in a future edition; we refer especially to the work of Weigl, Hirschler, Rio Hortega, etc. The author exhibits a commendable scepticism with regard to the specificity of the so-called "chromatin" dyes, and points out in several parts of the book that cytoplasmic bodies unrelated to chromatin may stain basophil, and yet not be true chromatin.

In his chapter on segmentation Prof. Doncaster succeeds in bringing out the fact that we have really proceeded a very short distance in the elucidation of the great problems surrounding even the first stages of animal development. In a later part of the book the author discusses some of these problems.

The subject of parthenogenesis is treated at length, and the author draws freely from his own researches on this fascinating subject. He recognises four main sections with regard to the behaviour of the chromosomes in naturally parthenogenetic animals. We are sorry to see that he has not adopted Sir Ray Lankester's suggestions as to the nomenclature of parthenogenesis. In his treatment of the subject of artificial parthenogenesis Prof. Doncaster points out that there are numbers of problems which are still unsolved with reference especially to the determination of sex. The question of the restitution of a diploid chromosome number in some artificially parthenogenetic animals is also peculiar, and its mechanism ill-understood. A special chapter on the chromosomes in sex-determination has been added, somewhat on the lines of the author's "Deter-

mination of Sex." The peculiar position of Lepidoptera and Aves with regard to these matters is emphasised.

A welcome section on "Germ-cell Determinants" gives clearly the main facts which have been ascertained. The author is commendably cautious in his discussion of this interesting subject, and recognises that "although these bodies are evidently strictly correlated with the germ-cells, there is no absolute certainty that they are the cause of the differentiation of germ-cells from body-cells."

Most cytologists will concur with Prof. Doncaster in his view that the weight of evidence is in favour of the main theory of the individuality of the chromosomes; the author emphasises the fact that the chromosome itself is in all probability divisible into smaller units, which may have an individuality more fundamental than the chromosome as a whole, and he suggests that the individuality theory should be extended so as to regard these granules (microsomes) as the fundamental units.

The chapter on the mechanism of hereditary transmission introduces a discussion on the most recent work on *Drosophila* and *Abraxas*. Prof. Doncaster is here dealing with a subject which he has himself studied specially, and though he treats the question with impartiality, he comes to the conclusion that not only does the behaviour of the chromosomes in the maturation divisions of the germ-cells provide the mechanism required for Mendelian segregation of characters, but also that the work of Morgan on *Drosophila* carries us a step farther and gives us some idea how the groups of characters may be related to special chromosomes. The author recognises the difficulties with regard to our full acceptance of the theories of Morgan and his colleagues relating to the mechanism of "coupling" and "crossing over," but states that no other hypothesis which has been brought forward fits the main facts so well. He concludes his book with an essay on the rôle of the cytoplasm in heredity, and gives a good account of the organ-forming substances.

Arranged and written as it is, this book is certain to stir up interest in the subject of cytology. By pointing out the perfections and defects of our present-day basic cytological theories and hypotheses, the author has succeeded in emphasising the lines along which fruitful research may be followed. We hope that this book will mark the beginning of greater activity among English cytologists. Prof. Doncaster is to be congratulated warmly on this excellent work. J. B. G.

Matrices.

University of Calcutta: Readership Lectures: *Matrices and Determinoids*. By Prof. C. E. Cullis. Vol. ii. Pp. xxiii+555. (Cambridge: At the University Press, 1918.) Price 42s. net.

THE history of the mathematical term "matrix" is likely to be very interesting. Its original meaning was an array of symbols ( $a_{mn}$ ) forming a rectangle of  $m$  rows and  $n$  columns, out of which determinants were selected by picking out columns (or rows) of the array. A square matrix gives only one associated determinant, but a square matrix is not the same thing as a determinant.

When we change from one set of variables to another by linear relations

$$y_j = \sum_i a_{ij} x_i \quad (i=1, 2, \dots, n; j=1, 2, \dots, m),$$

we have an associated matrix ( $a_{mn}$ ), or  $A$ , which is square only when the number of variables is the same in each set. In practice this is the most usual case, and it will be simpler to confine ourselves to this for the present. If we take a new set of variables  $z_i$  such that

$$z_j = \sum_i b_{ij} y_i,$$

we have a matrix  $B = (b_{mn})$ , and by eliminating the symbols  $y_i$  we deduce

$$z_j = \sum_i c_{ij} x_i,$$

where the symbols  $c_{ij}$  are derived from  $A$ ,  $B$  by a process of "composition," and form a new matrix  $C$ . We write  $C = AB$  symbolically, and thus start the theory of the multiplication of matrices. There are many analogies with the theory of groups; for instance,  $BA$  must be distinguished from  $AB$ , multiplication is associative, and so on.

Cayley seems to have been the first to develop the theory of square matrices from this point of view (Phil. Trans., vols. cxlviii., clvi., and elsewhere); other English mathematicians, such as Sylvester, Buchheim, and Tait, took up the subject later on. It may be specially noted that H. Smith's memoir on linear indeterminate equations and congruences contains a great deal of the fundamental theory of matrices, both square and rectangular. In particular, there is a complete and, we believe, original statement of the existence and properties of the elementary factors of a determinant the elements of which are ordinary integers. Weierstrass, Kronecker, and Frobenius, especially the last-named, have made important contributions to the subject.

It will be seen that a matrix is now not merely a scheme of symbols used to specify a set of deter-

minants, but a kind of entity of a very abstract and comprehensive type. A large part of group-theory and many complex linear algebras can be expressed in terms of matrices, and this absorptive property of matrix-theory will probably become more evident in course of time. Matrices occupy a special section in the International Schedule, and the Royal Society Index contains about sixty titles under that heading. Papers under other headings (especially determinants) have also more or less bearing on the subject. Prof. Baker's works on Abelian functions show the importance of matrices in the general theory of theta functions. Some knowledge of the subject is becoming essential in connection with various branches of pure mathematics.

Prof. Cullis's second volume, if we understand the author aright, seems to be a continuation rather different from that which he originally planned. This is not to be regretted, because in this portion we have statements and proofs of well-known and important theorems in the author's own notation, and a large number of illustrative examples. Among the subjects treated are ranks of matrix products and factors, equigradient transformations, certain matrix equations of the second degree, and various properties of a pair of matrices ("paratomy," "orthotomy," and so on). Much of the argument is put into a quasi-geometrical form. The outstanding feature of the work, which the author properly emphasises, is the detailed discussion of rectangular, as distinguished from square, matrices. For this reason alone the work ought to give a great stimulus to the subject, and we hope that the publication of the whole treatise will not be long delayed. Until it is finished, it will be difficult, if not impossible, to give a proper appreciation of it, especially as the author introduces so many new symbols and technical terms. One thing, however, is certain: we now have the outlines of a calculus of matrices in which the operations of addition, subtraction, and multiplication are definite. It may be conjectured that some of the most important applications will be to problems connected with a compound modulus, arithmetical or algebraical as the case may be.

As a matter of curiosity it may be noted that one or two of the very first problems in the theory of rectangular matrices occur in Gauss's "Disquisitiones Arithmeticae"; for instance, in connection with the theory of composition of quadratic forms, we have the problem of finding a matrix ( $a_{2,4}$ ) the six determinants of which are to be six assigned integers, subject to a certain relation.

G. B. M.

### The Chemistry of Animal Products.

*The Essentials of Chemical Physiology: For the Use of Students.* By Prof. W. D. Halliburton. Tenth edition. Pp. xi+324. (London: Longmans, Green, and Co., 1919.) Price 7s. 6d. net.

THE fact that this well-known and appreciated text-book has reached its tenth edition is sufficient evidence that it satisfies adequately the need for a short practical course in the chemistry of the substances found in and produced by the activity of living tissues. This object is excellently attained. It is not to be expected that a detailed account of the chemical processes occurring during the life and functional action of the organs of the body is to be found therein. Indeed, it would be impossible to separate the chemical from the physical aspects of any of these physiological processes. Such a separation appears to be an unfortunate necessity in a great part of the teaching of the subject, but a more intimate union between the chemical side and what is sometimes called the "experimental" side of the student's work is very desirable, and might be arranged without much difficulty.

There are some important questions which are apt to fall out in the present arrangement; such are those of permeability, osmotic pressure, hydrogen-ion concentration, and the properties of colloidal solutions. In a future edition Prof. Halliburton might find it possible to include a few simple exercises in these problems. An intelligent grasp of the principles involved is not to be attained by the mere reading of statements about them, while even a small number of experiments have great value. On account of its importance in physiological phenomena, some experiment showing the synthetic aspect of the action of enzymes might well be inserted.

A general criticism which applies to most text-books on practical chemistry, especially to those on biological chemistry, is that a number of the tests given suggest cookery recipes rather than scientific experiments. A student is very little the better for performing Molisch's sugar test if he is ignorant of what the result is due to. And how many understand, when they make the tests, why some sugars reduce copper salts, while others do not; or why tartrates are added to Fehling's solution? It would often be better to curtail the recital of what is to be found in general text-books in order to explain the reasons for the results of the actual experiments made.

In the book before us the theoretical part is, on the whole, brought well up to date. In view of

recent work, however, the statements with respect to anti-enzymes might well have been more critical. Some of us might demur to the statement on p. 83 that margarine-makers have learned to make this fat palatable. W. M. B.

### Physics: Theoretical and Practical.

(1) *A Handbook of Physics Measurements.* By Ervin S. Ferry, in collaboration with O. W. Silvey, G. W. Sherman, jun., and D. C. Duncan. Vol. i. *Fundamental Measurements, Properties of Matter and Optics.* Pp. ix+251. Vol. ii. *Vibratory Motion, Sound, Heat, Electricity and Magnetism.* Pp. x+233. (New York: John Wiley and Sons, Inc.; London: Chapman and Hall, Ltd., 1918). Price 9s. 6d. net each vol.

(2) *Notes on Magnetism: For the Use of Students of Electrical Engineering.* By C. G. Lamb. Pp. viii+94. (Cambridge: At the University Press, 1919.) Price 5s. net.

(1) IN the two volumes forming "A Handbook of Physics Measurements" are given the theory and manipulation of those experiments which experience has shown to be most important in pure and applied science. The work is designed for college and industrial laboratories, and forms a self-contained manual. Each chapter consists of two parts; the first includes definitions, a description of the apparatus, and the general theory of the methods, while in the second each determination is described in detail, the more important sources of error are pointed out, and means are indicated by which these errors may be minimised or accounted for. Most of the experiments require no mathematics beyond trigonometry and algebra, but the authors have rightly decided to employ the calculus methods wherever these would result in economy of time and mental effort.

No student except one specialising in physics would perform all 108 experiments included in the two volumes. Other students, after performing the necessary experiments on the properties of matter, would limit themselves to the groups bearing directly upon their principal study. Thus the chemist would do the work on indices of refraction, using various forms of refractometer, such as the Pulfrich, the Zeiss, the Abbe, the Féry, or the more recent instrument designed by Dawes. He would also make use of spectrosopes and spectrophotometers, and learn that "spectrocolorimetry"—the estimation of the concentration of solutions by means of the intensity of the absorption bands of their spectra—is a method

which may be both more speedy and more precise than chemical analysis. The electrical engineer would do the work on damped vibration and harmonic analysis, in addition to the usual experiments on the determination of resistances, capacities, or inductances. The mechanical engineer will be interested in the methods for the determination of the economy effected by steam-pipe coverings and of the thermal value of both coal and gas. The work as a whole is to be recommended as giving a thoroughly up-to-date account of most of the important physical instruments and experimental methods.

(2) For the use of students in the engineering laboratory, Cambridge, Mr. Lamb has drawn up a convenient set of notes dealing with the essential parts of the subject of magnetism. Starting with fundamental facts and principles, such portions of magnetic theory are outlined as are required in order to read the ordinary technical text-books with intelligence. The work has been well done, and the latter part of the book, dealing with magnetic hysteresis and alternating-current tests, will be of special service to both students and teachers, who will welcome the admirable diagrams and the lucid descriptions. H. S. A.

### Minerals and Metals.

(1) *Zinc and its Alloys.* By Dr. T. E. Lones. (Pitman's Common Commodities and Industries. Pp. ix+127. (London: Sir Isaac Pitman and Sons, Ltd., n.d.) Price 2s. 6d. net.

(2) *Asbestos and the Asbestos Industry: The World's Most Wonderful Mineral and other Fireproof Materials.* By A. Leonard Summers. (Pitman's Common Commodities and Industries.) Pp. ix+107. (London: Sir Isaac Pitman and Sons, Ltd., n.d.) Price 2s. 6d. net.

(3) *Tin Ores.* By G. M. Davies. Pp. x+111.

(4) *Manganese Ores.* By A. H. Curtis. Pp. x+118. (Imperial Institute: Monographs on Mineral Resources, with Special Reference to the British Empire.) (London: John Murray, 1919.) Price 3s. 6d. net each.

THE first two of these little books are two of the volumes in a series issued with the object of giving general readers an account, in language as untechnical as possible, of the origin, mode of production, and uses of a number of the essential articles employed in industries. The object is an excellent one, for it is knowledge of a kind that the user and even the merchant of these materials rarely possess, though the advan-

tage of having such information is sufficiently obvious.

(1) The volume on zinc is an excellent example of what such books ought to be; it gives, first, a brief history of the metal, then a description of the various ores from which it is extracted, and of the processes employed in dressing these ores or rendering them marketable, including, it may be noted, a very fair summary of the modern flotation processes. The next chapters give a good and quite up-to-date account of the methods employed in smelting the metal or extracting it from the ores, and a final chapter is devoted to the alloys of which it forms an important constituent. It is a pity that the author did not keep clear altogether of chemical equations, which he might easily have done in a purely popular treatise, as he has been somewhat unfortunate in their use; it is difficult to understand how he ever came to write such an equation as

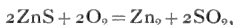

for the context shows that he knows well enough that no such reaction ever takes place. Again, he would have done better to omit the equation  $2\text{ZnO} + 2\text{CO} = \text{Zn}_2 + 2\text{CO}_2$ , because although oxide of zinc can be reduced by carbonic oxide, the reaction can take place normally only in the presence of excess of carbon, which at once again reduces the carbonic anhydride to carbonic oxide. The author's equation would suggest that carbonic anhydride is evolved in the process of zinc smelting, whereas, in fact, the evolved gases consist almost entirely of carbonic oxide. In a future edition the author might with advantage devote a little space to the galvanising of iron, seeing that about half the world's production of zinc is used for this process.

(2) The volume on "Asbestos" decidedly suffers by comparison with its companion volume, as the author does not take care to avoid a number of errors, which, though common enough in the trade, ought not to find their way into a book of this description. He does not by any means make it clear, as he should have done at the outset, that the trade name "asbestos" is applied to several different minerals; the name was apparently given originally to tremolite, actinolite, and other varieties of amphibole, but it is also applied to fibrous forms of pyroxene, to the very different mineral crocidolite, distinguished by the large proportion of ferrous iron that it contains, and, lastly, to chrysolite, a fibrous variety of serpentine, which differs from all the foregoing in that it is a hydrated silicate, whereas all the others are anhydrous. Again, no serious work should contain such statements as: "Next to coal, asbestos

is now undoubtedly the most important of the non-metallic mineral products of the world," or "older than anything in the animal or vegetable kingdom"; surely the author cannot suppose that asbestos is of more importance than salt, for example, and surely he would not question the inclusion of, say, Silurian trilobites in the animal kingdom. His statement that the works of the United Asbestos Co., Ltd., at Harefield, Middlesex, are alongside a coal-pit is unintelligible; there are certainly no collieries in that part of England. When he deals with the manufacture of asbestos into cloth, yarn, packing, boiler coverings, and the numerous patented materials of which it forms an essential constituent, he is on safer ground, and supplies much useful information in a convenient form.

(3) and (4) The Imperial Institute is doing excellent service in issuing the handy monographs on the mineral resources of the British Empire, two of which have recently appeared. There is, of course, nothing new in either of these works, they being careful compilations of well-known information and statistics; this does not imply that the production of such compilations is at all an easy task, or that the compiler has not done good service in carrying it out. On the contrary, the collection of the large mass of material which has here been brought together requires a laborious and painstaking search through many and various sources of information, not all of which are readily accessible to the general reader, as a glance at the very useful bibliographies appended to both volumes will at once show. In one respect the two mineral substances discussed in the respective volumes show a marked contrast: workable tin ores occur in relatively few localities, whilst ores of manganese are very widely distributed, and to be found in most parts of the world, although it is true that large deposits of manganese ores are far from plentiful; but in other respects the tasks of the authors have been very similar.

The general scheme of both books is identical. The first chapter is devoted to the uses and applications of the metal and its compounds, and to the nature and general characters of the ores; the second deals in some detail with the occurrences of the ores within the British Empire; and the third reviews briefly the main sources of supply in other parts of the world. In both cases the work has been carefully and thoroughly done, and the handbooks may be looked upon as giving trustworthy information upon the subjects treated in a compact and convenient form.

### Our Bookshelf.

*The Engines of the Human Body: Being the Substance of Christmas Lectures Given at the Royal Institution of Great Britain, Christmas, 1916-1917.* By Prof. Arthur Keith. Pp. xii+284+ii plates. (London: Williams and Norgate, 1919.) Price 12s. 6d. net.

WORKS on physiology commonly appeal either to the usual types of student, or else to those engaged in teaching or research work. The work before us claims to appeal in the first place to the general reader "who desires to know what modern medical teachers think of the marvellous contrivances of the human machine." The title of the book, with the foregoing quotation, indicates the spirit in which the author has approached the subject. Prof. Keith's fertile imagination has sought analogies between the various functions of the organs on one hand, and divers mechanisms of human design on the other, and he certainly never seems at a loss for them. In so far as the general reader has no previous knowledge of the subject, the method of treatment by analogy alone seems calculated to give rise to an abundant harvest of grotesque misconceptions, as all those who have taught elementary physiology are well aware; but the book should be truly welcome to a teacher who, while having some acquaintance with the subject, is yet lacking in the knowledge or imagination necessary to evolve instructive analogies to help to fasten in the pupil's mind what he wishes to impart.

Many of the mechanical analogies are quite new and should be worth adopting, but others seem superfluous or misleading; for example, the comparison of muscular tissue with an internal-combustion engine is a sound and generally recognised conception, up to a certain point; but to refer to tendons as "piston cords," or to arteries and veins as supply and exhaust pipes, is pushing a good analogy to the point of whimsicality. For the first thirteen chapters, however, in spite of this, the reader should go along smoothly enough, but after this point, when analogies fall thick as autumn leaves, the general reader is likely to lose sight of the track. There are some inexactitudes in the book which do not fall in the category of bad analogies; for example, the statement that the velocity of the nerve impulse is four miles a second, that nerves are "living and pulsating," and that nerves are subject to fatigue (p. 263). The historical fragments which are frequently introduced are of considerable merit, partly on account of the relief experienced by the reader in meeting plain, unveiled fact, but chiefly because they are exceedingly well chosen.

C. L. E.

*A Class-book of Organic Chemistry.* By Prof. J. B. Cohen. Vol. ii.: For Second-Year Medical Students and Others. Pp. vii+156. (London: Macmillan and Co., Ltd., 1919.) Price 4s. 6d.

THE average medical student is inclined to regard

chemistry as a subject which has to be studied in order to pass certain examinations, and having passed these, he dismisses the subject from his mind. This is in large measure due to the fact that the text-book he has come across has failed to stimulate his interest, and the probability is that he will get rid of the book at the earliest opportunity.

The little volume under review, however, is one that we venture to think the student will not be likely to part with, as it gives a very clear, concise, and readable account of the subject, which may stand him in good stead in his future studies; it is divided into ten chapters, as follows: Synthesis, The Oils and Fats, The Carbohydrates, Some Natural Organic Bases, The Pyrimidine and Purine Groups, The Proteins, Fermentation and Enzyme Action, The Essential Oils, The Alkaloids, and Synthetic Drugs. Each of the sections is thoroughly up-to-date, and we know of no book which, within so small a compass, deals with such varied subjects as, for example, the Grignard reaction, the synthesis of disaccharides, the origin of uric acid in the animal organism, and the theory of alcoholic fermentation, besides giving the constitutional formulæ, so far as they are known, of yeast-nucleic acid, hæmin, ætiophyllin, and the more important alkaloids, such as strychnine and morphine. The last chapter, in addition to giving the constitution of many of the better-known synthetic drugs, contains a short account of the more recent antiseptics, such as chloramine-T, and the dyestuffs malachite green, acriflavine, etc., as well as a brief sketch of the trypanocidal action of the organic arsenic compounds.

The first volume, published in 1917, was meant to serve as an introduction to organic chemistry, and the two volumes together can be thoroughly recommended as a most excellent and handy little compendium, which should find great favour among students and teachers alike.

*Examples in Electrical Engineering.* By J. F. Gill and F. J. Teago. Pp. 173. (London: Edward Arnold, 1920.) Price 7s. 6d. net.

A book of this kind, which consists of a collection of model examination papers, followed by model replies, should be not without its uses to those who are obliged to study the art of passing examinations, as well as the principles of electrical engineering, as a careful perusal of its contents will enable the student not only to practise his knowledge of the various parts of the subject, but also to form good habits in the way of presentation of the solution of the problems in a clean form and logical sequence. The drawing of good diagrams and the frequent use of graphical methods are very rightly insisted on, and admirable conciseness is observed. The papers cover both "intermediate" and "advanced" standards, and relate on the whole to practical applications rather than to theory.

### Letters to the Editor.

*[The Editor does not hold himself responsible for opinions expressed by his correspondents. Neither can he undertake to return, or to correspond with the writers of, rejected manuscripts intended for this or any other part of NATURE. No notice is taken of anonymous communications.]*

#### The Plumage Bill and Bird Protection.

At the present time there is a measure before the House of Commons known as the Importation of Plumage (Prohibition) Bill, the object of which is "to prohibit the importation of the plumage of birds and the sale or possession of plumage illegally imported," excepting the plumage of ostriches and eider ducks, but "the prohibition or importation imposed by the Act shall not apply to any plumage imported in the baggage or as part of the wearing apparel of a passenger." The Bill further provides for the granting of a licence, subject to certain conditions and regulations, authorising the importation of plumage for natural history museums, for the purpose of scientific research, or for any other special purpose.

In connection with this measure numerous conflicting interests are threatened and grave misunderstandings exist, due very largely to lack of knowledge of the actual facts. Whilst yielding to no one in my love of wild birds and all the æsthetic interests associated with wild-bird life, I cannot shut my eyes to the fact that a considerable amount of sentimentalism, misrepresentation, and exaggeration has been put forth by supporters or well-wishers of this measure, and similarly by the opposers respecting trade losses, the extent of the employment the trade ensures, the absence of cruelty involved in the trade, etc. Neither of these views helps us to understand the situation or calmly and dispassionately to form an unbiased opinion, for both of them are far from the actual truth.

There is now ample evidence to show that a considerable trade is done in the plumage and skins of wild birds which are largely utilised for the decoration of women's hats, etc. In different centres, such as London, Manchester, Paris, Berlin, Vienna, and elsewhere, this trade affords employment to a number of workers. The "horrors and barbarities of the traffic" have been luridly described by one set of writers and denied by another. Without accepting either of these sets of exaggerated statements, information in my possession shows that gross cruelty is frequently committed. Prof. E. H. Forbush states that brutal savagery is characteristic of this phase of bird destruction, and points out that this "has been well illustrated in the extermination of the egrets of the United States." No unprejudiced mind can exonerate or satisfactorily explain away this highly objectionable side of the question.

Of the species of birds sought after, we are constantly being assured that they are injurious, that they are "as common as rooks," or that we do not possess any exact information as to the effect this trade has had upon their numbers. The fact is that the majority of the species are beneficial so far as agriculture or horticulture is concerned, and only a very few injurious. There is exact and incontrovertible evidence that where thirty-five or forty years ago millions of birds existed, they are now practically extirpated. A single "rookery" of egrets was estimated by a well-known ornithologist to contain three million birds in 1878; in 1888 they were rare, and in 1908 almost extinct.

It is pointed out by supporters of this Bill that prohibition laws exist in America, Australia, India, and elsewhere, but it is not mentioned that, in the opinion of many competent judges, in consequence of such laws certain beneficial species of birds have suffered and injurious ones unduly increased.

Again, it has been suggested that such birds as egrets might be cultivated in natural reserves, and their plumes or "aigrettes" collected as the birds moult. The most perfect of such feathers, so we are informed, fetch as much as 2*l.* apiece. That the farming of these birds is a practicable scheme is proved by the fact that the National Association of Audubon Societies in the United States has established such a colony on a small island in the Stono River, near Charleston, and in 1917 it was tenanted by more than four hundred birds. Again, on Avery Island, Louisiana, U.S.A., there is a "rookery" of snowy egrets which in 1916 was carefully examined by Prof. J. S. Huxley, and reported to contain between eight and nine hundred nests. It may be well, perhaps, to remind the advocates of such schemes that, like all members of the family Ardeidae, herons and egrets subsist very largely upon fish, and there is little doubt that the establishment of a series of large rookeries would have a disastrous effect upon fresh-water fisheries.

Whilst in no manner advocating opposition to this Bill, we must face the question: Supposing that it is placed upon the Statute-book, shall we have done anything to stop the trade in the skins and plumage of wild birds? Personally, I have grave doubts whether the object desired can be obtained by this measure. As an Act of Parliament its example and influence may be for good, but it will certainly not put a stop to the plumage trade. It must be realised that if we prohibit this trade in London, it will still flourish in Paris, Berlin, and elsewhere. The Bill will simply move the venue of the market; it will not bring about a smaller demand. To put an end to this we must educate the public, not by giving currency to wild and often inaccurate statements, but by teaching the rising generation "to view the question of the preservation of wild-bird life from a higher and much truer standpoint than heretofore. That wild birds have a utilitarian value no one can deny, but they also have an æsthetic value far outweighing all others. . . . Surely the general public have some rights where beautiful natural objects are concerned. . . . Posterity will undoubtedly regard us—and who shall say not rightly?—as stupid people, dull of apprehension and procrastinating in nature, in that we have permitted various species of wild birds, one after another, to disappear from our land; and our children's children will rise up and ask why we did not secure to them the natural pleasures which their forefathers could have enjoyed had they had eyes to see with and minds tuned beyond the din and bustle of the highways and byways of commerce" (*National Review*, 1920, p. 95).

Whilst the decoration of the person with wings and feathers may be regarded as the vulgar and depraved fancy of a day, the fact cannot escape us that there is a large section of the general public who are willing to pay high prices for these goods; and so long as this demand continues, so long will a supply be forthcoming.

By making the Plumage Bill a law of the land we can say that in this country we will have nothing to do with the trade and that it shall be prohibitory to carry on the trade in the United Kingdom. That it will have any effect on the destruction of wild-bird life, however, is certainly most unlikely. A plentiful supply



of the goods will be forthcoming so long as a demand exists, but once it is regarded as offensive—or shall we say indicative of a lack of good taste?—to wear such things as the wings, heads, feathers, or bodies of birds, the demand will cease and the trade, so far as this country is concerned, disappear. Herein, we think, lies a remedy far more effective than any Act of Parliament.

WALTER E. COLLINGE.

The University, St. Andrews, March 27.

### The Physiology of Migrations in the Sea.

THE flat-fishes of Northumberland in the immature condition migrate more or less inshore in summer and offshore in winter. Flounders are relatively static, plaice migrate offshore to the north-east and dabs to the south-east. The migration is not, as a rule, conspicuous, and, so far as the young stages are concerned, might be regarded as not taking place.

With approaching maturity, however, these three species migrate far to the north. The flounders for the most part reach the coast of Fife, and the plaice deeper water off the Forth and the Scottish coast to the north. The dabs do not appear to migrate so far to the north as the plaice, but we have a record of one that migrated so far as St. Andrews Bay. Fulton has shown that the Moray Firth plaice migrate to the north, and even to the Atlantic.

The migrations may be said, therefore, to be a series of seasonal inshore and offshore movements, followed by a marked contranantant journey for spawning. After spawning the spent fish resume the seasonal migrations, and become then, more obviously, summer inshore migrants.

We have thus plainly two factors at work: one external, which may be associated with temperature, the other internal, which we at once conclude to be due to the action of an internal secretion. The seasonal migrations are obviously independent of the spawning migration, and may be said to be produced by hydrographical conditions and the contranantant ability of the fish. Under the influence of the spawning impulse fish migrate usually to a great, and sometimes to an immense, distance. The effect is strong enough to force the eel to descend from fresh water to the sea, and thence to mid-ocean, and to impel the salmon from the sea to the river, and, in spite of difficulties, to the spawning-ground.

The spawning migration is not always so plainly marked, but these considerations go to show that all fish migrations are of a similar character, a general seasonal series of movements affecting all, and a special migration under the dominating influence of an internal secretion or hormone, which, proceeding from the developing gonad, is carried by the blood to the nervous system. With reference to the species referred to above, it can be said that the hormone begins to exert its influence about autumn or the later months of the year, and continues its effect during the whole period of ripening. It is periodic in its manifestations, and the call, when it comes, is imperative. Only in special circumstances, as lack of water, say, in the river, can the spawning migration be said to be modified by hydrographical or other physical conditions. The distinction between the two kinds of migration must be clearly kept in view if we are to understand and appreciate the results of marking experiments. From, say, November to the spawning season mature plaice are contranantant migrants; after spawning they are denantant, or usually so, until the winter. The large number of records which have been accumulated, resulting

from the investigations of past years, should be reconsidered with this in mind.

It is interesting to observe that the only invertebrate of the migration of which we have direct proof behaves almost exactly like the plaice and the flounder. The common edible crab (*Cancer pagurus*) migrates inshore in summer and offshore in winter with the greatest regularity. Maturity impels the female to become a contranantant migrant. The females migrate from the Northumberland coast to the southern coast of the Firth of Forth, some of them still further to the north, even to the Moray Firth, the general results indicating a direct relationship between size and distance. The hormone is therefore secreted in the crab by the developing ovary, and it reacts in exactly the same way as that of the fish. The experiments have clearly proved that the migration does not occur until the winter before the season of spawning, and in this respect the crustacean and the fish are in agreement. It takes place during the offshore winter migration and in deep water, but the effect is differential, the male not migrating. It is not necessary for the male to migrate, as the migration takes place after pairing, even a year or two years after. This appears to indicate that the internal secretion is under control or may be withheld in response to evolutionary necessity.

Dr. Gurley, in the *American Journal of Psychology* (1902 and 1909), brought under review the indications of the intoxication of the central nervous system by internal secretions as explaining the spawning migrations of fresh-water fish in North America; so that the point is not new. We do not know very much about the internal secretions, but we know enough to be able to say that they act directly and quickly as an intercommunication between organs with or without reference to the nervous system. In the sea the effects are indicated by migration in the case of such animals as are capable of making migrations, but it is obvious that in many cases the internal secretions derived from the gonad have somatogenetic as well as mental effects, as in the development of secondary sexual characters.

The developing gonads of fish and the crab offer interesting material for the investigation of internal secretions by a biochemist. My main object, however, is to indicate that we already know the general facts and laws of migration, that marking must be done intelligently and the results read with due consideration of the laws, and more especially that the spawning migration is due to an intoxication of the central nervous system, and brings about a migratory result independent of temperature, salinity, and every other hydrographical condition.

ALEXANDER MEEK.

Armstrong College, Newcastle-upon-Tyne,

March 30.

### Muscular Efficiency.

WHEN muscular force is exerted, power is expended and fatigue is produced, even when the muscle remains stationary. Again, when no external force opposes the contraction of the muscle, physiological causes set a limit to the speed at which contraction can take place. In both cases the whole power expended is lost in so far as the production of useful work is concerned. When there is no velocity the power is used in maintaining the stress, and when there is no resistance, in maintaining a constant velocity.<sup>1</sup>

In all ordinary muscular operations both these sources of power leakage act simultaneously but in

<sup>1</sup> This loss is independent of any power lost in the acceleration of the parts.

different degrees, and it becomes a definite problem to determine for any muscle or combination of muscles the relation between the speed of muscular contraction and the muscular force which will yield the greatest external power. The problem may be solved by means of the diagram in Fig. 1.

It is assumed that the muscular machine has a constant output of power which is represented by the product  $xy$  ( $x$  pressure,  $y$  velocity) of the co-ordinates of the hyperbola AB. Also, that the pressure available for producing exterior power is less than  $x$  by some quantity  $\psi(y)$  depending on the velocity, and represented in the figure by the abscissa of the curve DD', the effective velocity in the same way being less

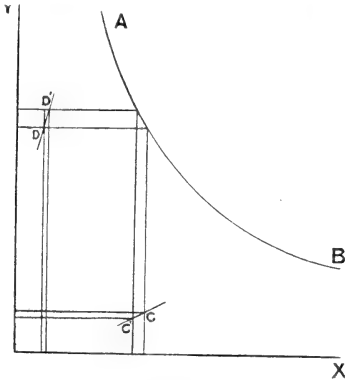

FIG. 1.—X, Y, co-ordinates of hyperbola AB.  $\phi(x)$ , ordinates of CC'.  $\psi(y)$ , abscissa of DD'.

than  $y$  by some quantity  $\phi(x)$  depending on the pressure, and represented by the ordinate of the curve CC'. The useful power is evidently  $(x - \psi(y))(y - \phi(x))$ , and the loss of power is  $x\phi(x) + y\psi(y) - \phi(x)\psi(y)$ .

If the co-ordinates for  $x + dx$  and  $y + dy$  are drawn as in the figure, it is plain that the loss is a minimum (and the useful power, therefore, a maximum) when  $(x - \psi(y))d\phi(x) + (y - \phi(x))d\psi(y) = \psi(y)dy + \phi(x)dx$ .

I know of no experiments which would determine the form of the functions  $\phi$  and  $\psi$ —that is, what power is lost in sustaining a load or in keeping a uniform speed. Both these subjects are worthy of investigation, and, with the facilities offered by some

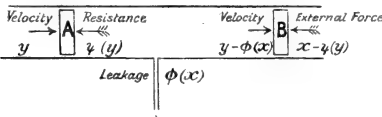

FIG. 2.

of the modern laboratories, ought not to present any great difficulties.

If  $\phi(x)$  and  $\psi(y)$  were simply proportional to  $x$  and  $y$ , the most economical speed would make, if  $\phi(x) = ax$  and  $\psi(y) = by$ ,  $y/x = b/a$ ; and if  $a = b$ , the most economical speed would be the mean between that where  $\psi(y) = x$  and  $\phi(x) = y$ .

In reality, however,  $\psi(y)$  is, I believe, much less than  $\phi(x)$ , but this remains for experimental determination. It may be noticed that as  $\psi(y)/\phi(x)$  decreases, the most economical speed increases.

A close analogy to the conditions of the problem may be found in a fluid contained between two pistons A and B (Fig. 2), between which there is a leak governed by the fluid pressure. A constant power urges A towards B, and A itself is subject to a frictional resistance depending on its speed. The useful work is represented by the velocity of B against an exterior force, while the leak stands for  $\phi(x)$  and the frictional resistance of A for  $\psi(y)$ .

A. MALLOCK.

**A Dynamical Specification of the Motion of Mercury.**

If we assume that the modified Lagrangean function for two mobile and massive particles is of the form

$$L = \frac{1}{2}m_1(\dot{x}_1^2 + \dot{y}_1^2 + \dot{z}_1^2) + \frac{1}{2}m_2(\dot{x}_2^2 + \dot{y}_2^2 + \dot{z}_2^2) + \frac{\gamma m_1 m_2}{r} \left[ 1 + \frac{\lambda}{C^2} \{ (\dot{x}_1 - \dot{x}_2)^2 + (\dot{y}_1 - \dot{y}_2)^2 + (\dot{z}_1 - \dot{z}_2)^2 \} \right]$$

where the symbols have the usual meaning, C being the velocity of light and  $\lambda$  a pure number, then the principle of least action  $\delta \int L dt = 0$  leads to the following conclusions:

- (1) The motion of the centre of mass is constant.
- (2) The orbits of the two particles about their centre of mass are similar and similarly described plane curves, and independent of the motion of the centre of mass.
- (3) For the orbital motion the modified Lagrangean function is:

$$L^1 = \frac{1}{2} \frac{m_1 m_2}{m_1 + m_2} \left\{ 1 + \frac{2(m_1 + m_2)\lambda\gamma}{rC^2} \right\} (\dot{r}^2 + r^2\dot{\theta}^2) + \frac{\gamma m_1 m_2}{r}$$

Hence the equations:

$$\left\{ 1 + \frac{2(m_1 + m_2)\lambda\gamma}{rC^2} \right\} (\dot{r}^2 + r^2\dot{\theta}^2) - \frac{2\gamma(m_1 + m_2)}{r} = \text{const.} = -\frac{\gamma(m_1 + m_2)}{a}$$

and

$$\left\{ 1 + \frac{2(m_1 + m_2)\lambda\gamma}{rC^2} \right\} r^2\dot{\theta} = \text{const.} = h$$

Writing  $r = 1/u$ , we have:

$$\left( \frac{du}{d\theta} \right)^2 + u^2 = \frac{2\gamma(m_1 + m_2)}{h^2} \left( u - \frac{1}{2a} \right) \left\{ 1 + \frac{2(m_1 + m_2)\lambda\gamma u}{C^2} \right\}$$

From this we may deduce

$$\frac{d^2u}{d\theta^2} + u \left\{ 1 - \frac{4\lambda\gamma^2(m_1 + m_2)^2}{C^2 h^2} \right\} = \frac{\gamma(m_1 + m_2)}{h^2} \left\{ 1 - \frac{\lambda\gamma(m_1 + m_2)}{C^2 a} \right\}$$

or the solution in the form

$$u = \frac{1}{l} \left\{ 1 + e \cos(\mu\theta + \eta) \right\}$$

where

$$\mu^2 = 1 - \frac{4\lambda\gamma^2(m_1 + m_2)^2}{C^2 h^2}$$

These equations are exact.

In applying this argument to the observed apsidal progress of the planet Mercury, it is to be noted that the interpretation of  $a$  and  $h$  differs slightly from what it would be if  $\lambda$  were zero; but to a sufficient degree of

approximation we find that the apsidal progress per revolution is

$$\frac{4\pi\lambda^2(m_1 + m_2)^2}{C^2\mu^2}$$

The observed value requires that  $\lambda$  should be nearly  $3/2$ , and if  $3/2$  is taken, we get the result obtained by Prof. Einstein by his new specification and principles.

It may be observed that the above specification by the Lagrangean function could be generalised for any number of particles, and that it involves no departure from recognised dynamics or the normal views of space and time. It does, however, involve the conclusion that the interaction of bodies through the æther, vaguely called "gravitation," is to a very slight degree not exactly in accordance with Newton's specification. Whether such conclusion is really necessary seems still a matter of doubt.

I have not seen any discussion of the problem of two bodies on Prof. Einstein's specification, but it appears to me that an exact determination of the relative orbit when  $m_1$  and  $m_2$  are comparable quantities is very desirable.

GEORGE W. WALKER.

Portsmouth, March 29.

### The Construction of a Magnetic Shell Equivalent to a Given Electric Current.

ACCORDING to Ampère's theorem, the magnetic field due to an electric current flowing in any circuit is equivalent at external points to that due to a simple magnetic shell the bounding edge of which coincides with the conductor, and the strength of which is equal to the strength of the current.

It is generally understood that any surface having the circuit as its boundary will serve as the surface of an equivalent magnetic shell, and the fact that there is a restriction on the nature of the surface does not appear generally to be recognised.

Thus, for example, in Maxwell's treatise (vol. ii., p. 142) we find the following:—"Conceive any surface  $S$  bounded by the circuit and not passing through the point  $P$ "; while further on he says: "It is manifest that the action of the circuit is independent of the form of the surface  $S$ , which was drawn in a perfectly arbitrary manner so as to fill it up."

I propose to show by means of a simple example that the surface is not drawn in a "perfectly arbitrary" manner.

Consider a narrow, rectangular strip of paper the opposite edges of which we shall denote by  $a$  and  $b$ , its opposite faces by  $A$  and  $B$ , and its two ends by  $1$  and  $2$ . We shall represent the ends of the edges by  $a_1, b_1, a_2, b_2$ , where the suffixes refer to the corresponding ends of the strip. Now let one end of the paper be turned round through an angle  $\pi$  and joined on to the other end, so that  $a_1$  is joined to  $b_2$  and  $b_1$  to  $a_2$ .

Then, since  $a_1$  is joined to  $b_2$ , the edges  $a$  and  $b$  form one continuous line, and, since  $b_1$  is joined to  $a_2$ , this line forms a closed circuit.

Thus we may bend a wire into the form of the edge, and can imagine an electric current to flow in it.

Although the electric circuit has the form of the edge, yet we could not have a simple magnetic shell the surface of which was that of the paper.

This is easily seen, for since, in addition to the edges, the faces  $A$  and  $B$  have also become continuous one with the other, we can no longer distinguish one as positive and the other as negative. The same thing is seen if we try to imagine the surface divided up into elementary portions, in the manner conceived

of by Ampère, with a current equal in strength to the given current flowing round the boundary of each.

It is easily seen that Ampère's construction fails for such a surface, which is known to mathematicians as a Möbius sheet.

Although the surface we have described would not serve as the surface of a simple magnetic shell equivalent to an electric current flowing round its boundary, yet it is possible to construct other surfaces having this boundary which would serve as surfaces of equivalent magnetic shells.

If we have one suitable surface we can obtain any number of others from it by continuous deformation while the edge remains fixed.

It is, therefore, desirable to give a general method of constructing a magnetic shell equivalent to a given electric circuit. The following appears to give a surface having the required property:—

Let  $O$  be a fixed point external to the circuit, and let  $P$  be a variable point. Let  $P$  travel once completely round the circuit, so that the radius vector  $OP$  traces out some conical surface.

The portion of this conical surface containing  $O$  and bounded by the circuit might then be taken as the surface of the equivalent magnetic shell.

In the particular case of the circuit we have considered (as well as in many others) the surface will cut itself, but will, nevertheless, have two distinct faces, one of which may be taken as positive and the other as negative. It thus appears to satisfy the necessary conditions.

A. A. ROBB.

March 30.

### Volcanic Rocks in the Anglo-Egyptian Sudan.

IN connection with Prof. J. W. Gregory's reference in NATURE of February 19, p. 667, to the discovery of the Bayuda volcanic field, and Mr. Campbell Smith's record of a riebeckite-rhyolite which constituted a number of stone implements found at Jebel Katul, in Northern Kordofan (*ibid.*, February 26, p. 693), some further notes may be of interest.

The rock collected by Sir Herbert Jackson at Merowe is a basaltic scoria, and the specimens either float or just sink in water. A few crystals of olivine are visible to the eye, and, under the microscope, a regular basaltic ground-mass, including feldspar, iron ores, and probably glass, can be recognised in the powdered rock. The specimens have evidently been transported by a stream system which drains from the south-east and debouches on the river at the spot where they were found. Save for the neighbourhoods of the river and a few routes by which travellers avoid the long journey around the Abu Hamed bend of the Nile, the maps of the Bayuda Desert are almost blank. Near one of the routes a surveyor has recorded "Hosh Eddalam, crater," and the name means a dark enclosure. Some of the older travellers mistook ironstone concretions for volcanic bombs, and as the surfaces of many rocks are darkened in the desert such a record of a crater did not call for particular note until evidence of extrusive rocks appeared. It is situated in latitude  $18^{\circ} 20' N.$ , longitude  $32^{\circ} 31' E.$ , and consequently lies to the west of the route taken by Dr. Chalmers Mitchell. The volcanic field seen from the air probably does not lie on the established routes, as it would certainly have been referred to in reports, even if it were not described. Presumably there can be no doubt about the existence of craters seen by an observer such as Dr. Chalmers Mitchell, but the results of an examination on the ground will be of interest, even if only to know the types of rocks involved.

Mr. Stanley C. Dunn records the presence of rhyolites and felsites near Jakdul, and these are doubtless

similar to those of the Sixth Cataract, about forty miles north of Khartum, where the volcanic rocks are certainly older than the Nubian Sandstone. In the northern parts of Dongola basalt intrusions occur in the Nubian Sandstone, and there is a hot spring at Akasha, about eighty miles south-west of Halfa. Turning to more distant regions, one of the solitary landmarks on the White Nile is Jebel Ahmed Aga, in latitude  $11^{\circ}$  N., consisting of the remains of a volcanic cone formed of basaltic scoria and evidently of comparatively recent age. Towards the east there are the plateau basalts of Abyssinia, with outliers extending into the Sudan. Along the Langeb Valley, north of Kassala, there is an interesting suite of acid and intermediate volcanic rocks, but we are still in doubt about their age. Similar rhyolites certainly occur farther north among the Red Sea hills. The western parts of Kordofan have been traversed geologically without revealing the existence of volcanic rocks on the continuation of the line referred to by Mr. Campbell Smith. Farther west Darfur appears to be full of recent volcanic rocks, principally of scoriaceous types.

The N.E.-S.W. features seen by Dr. Chalmers Mitchell may have been to some extent due to erosion by sand driven from the N.N.E. by the prevalent wind. The direction of strike among the metamorphic rocks is another factor to be borne in mind. It is not constant over these large areas, but it is very often N.E.-S.W., and would then account for some of the features seen from the air. In these circumstances caution appears desirable in basing wide structural theories on rather scanty data.

G. W. GRABHAM.

Box 178, Khartum, March 25.

### The FitzGerald-Lorentz Contraction Theory.

In the discussion on relativity at the Royal Society on February 5 (NATURE, February 12), Mr. Jeans stated that the FitzGerald-Lorentz contraction theory presented grave difficulties in the case of a wheel rotating about a fixed axle, so that the circumference would contract while the radius would not. Surely these difficulties are not so grave as would appear at first sight? Let us adopt the point of view of the old-fashioned non-relativist to whom space is rigid and Euclidean, even though his measuring instruments may change and so introduce errors in his measurements. A scale is not a rigid invariable unit of length. Its length, even if its orientation is unchanged, depends on its temperature and the tensile or compression stresses to which it is subjected. If we change its temperature, keeping the stresses constant, its length (as measured by a standard scale at fixed temperature) varies. But we may by suitable means prevent the variation of length, in which case the change of temperature will cause a change of stress. Similarly, on the FitzGerald-Lorentz theory, turning the scale to a different orientation relative to the supposed æther stream causes a change in the electric forces to which the cohesion of the molecules is ultimately due, so that if the temperature and the external stresses remain constant, the length changes. In this case, however, we cannot detect the change directly, as it would be necessary to turn our standard scale also, and it, too, would change. If for any reason the change of length is prevented, the FitzGerald-Lorentz effect causes a change of stress.

Now in the case of the rotating wheel the ratio of the circumference to the radius must remain constant, so that any tendency of one to change its dimensions will affect the other, with the result that both

circumferential and radial stresses will be set up, and any changes of length caused must be compatible with the constancy of  $\pi$ . These stresses would in any actual case be almost vanishingly small compared with those due to centrifugal force, so that the only effect of the FitzGerald-Lorentz contraction would be to alter the latter stresses to an utterly negligible extent.

HORACE H. POOLE.

Physical Laboratory, Trinity College,  
Dublin, March 19.

### Moseley Memorial.

THE fund founded in the University of Manchester for the provision of a memorial to the late H. G. J. Moseley (killed in action at Gallipoli, 1915), and originally proposed as a private memorial from Moseley's personal friends and fellow-workers in Manchester, has now been extended in order to give other scientific bodies, both in England and abroad, an opportunity of participating. This extension has been made at the request of a number of scientific men interested in Moseley's work, but not personally connected with him, and it is in order to reach this wider public that you are asked to publish this letter.

The scheme of memorial proposed is (1) the provision of a memorial tablet in the physical laboratory and (2) the foundation of a Moseley prize or medal for physics in the University of Manchester.

The fund is administered by a committee consisting of Sir Henry A. Miers (chairman), Profs. W. L. Bragg and H. B. Dixon, Sir E. Rutherford, and Dr. E. J. Evans.

Subscriptions, which should be made payable to the "Moseley Memorial Fund," and crossed "Williams Deacon's Bank, Ltd.," may be sent to either of the hon. secretaries, Mr. C. G. Darwin, Christ's College, Cambridge, or Dr. H. Robinson, Physical Laboratory, University of Manchester.

About 170l. has already been received, comprising donations from Great Britain, Canada, the United States, and France (including contributions from the Société Française de Physique and the Société de Chimie-Physique).

It is desired to close the fund in July of this year.

HENRY A. MIERS,  
Chairman,  
C. G. DARWIN,  
H. ROBINSON,  
Hon. Secretaries.

### The Aurora of March 22-23.

I HAD a fine view of this superb display at Workington between midnight and 1 o'clock a.m., in a clear and bright starlit sky. The whole sky was filled with the light except a small area in the south-east. I could detect no colour except creamy-white, the general intensity being, to my mind, at times equal to full moonlight. Curtains of light surrounded a point just east of the zenith, which seemed to mark the "hub" of the display. The bright star ( $\alpha$ ) in Canes Venatici almost exactly marked this point, and filmy sheets of light seemed to dash upwards from the south-west and north-east horizons and merge together at this star. The only display I have ever seen to equal this was on 1907 February 14 at Motherwell, in the previous sun-spot maximum period. It was the fact that I could see the great sun-spot train on March 22 without telescopic aid that made me expect and look out for the aurora that night.

W. B. HOUSMAN.  
Seaton Cottage, Workington, April 9.

### The Nitrogen Problem: By-products.<sup>1</sup>

IT is surely high time that we, as a nation, were more fully alive to the necessity of a complete investigation of the recovery of by-products, and that not merely in connection with nitrogen products. There is still too much of the feeling—one comes across it quite frequently—that so-called waste products form a recognised loss in any process. The investigation of the treatment of any waste product is not looked upon as the work of the person engaged in the specific manufacture from which that waste product is obtained. Competition becomes keener as the years pass, and if our position is to be retained by-products must be recovered in all cases where such recovery can be economically effected. A waste product may even become the starting point of a new industry. The detailed investigation of the position as regards nitrogen by-products manufacture comes as a very welcome record and as a much-needed indicator of the forward path.

The world's ammonia production, in terms of sulphate, advanced between the years 1903 and 1913 from 540,200 long tons to 1,389,790, an increase of more than 150 per cent. The chief producers were Germany, the United Kingdom, and the United States, who were respectively responsible in 1913 for 39, 31, and 12½ per cent. of the total production. The essential sources are gas-works, coke-ovens, gas-producers, shale-works, iron-works, and bone, etc., carbonising works.

In the years 1911 and 1913 the coke-oven industry was responsible for 84 and 86 per cent. respectively of the German production, in 1913 for 78 per cent. of the United States production, and in 1911 and 1913 for 27 and 30 per cent. of the United Kingdom production. The United Kingdom production rose from 233,664 long tons in 1903 to 432,618 in 1913, of which, in 1903, gas-works provided 149,489 long tons, or 64 per cent. of the total, which steadily increased to 182,180, or 42 per cent. of the total. Coke-ovens in the United Kingdom provided in 1903 only 17,438 tons, or barely 7½ per cent., but continual increase brought up the amount by 1913 to 133,816 tons, practically 31 per cent. of the production of the country. Iron-works during this period retained a steady output of 19,000 to 20,000 tons, shale-works production increased gradually from 37,353 to 63,061 tons, and that of producer-gas, bone, etc., carbonising works from 10,265 to 33,605 tons.

These are illuminating figures which deserve consideration and show plainly the development of the by-product industry up to the commencement of the war period.

In addition to supplying home demands for ammonia nitrogen, there was an average yearly

export of ammonia, ammonia salts, and products made therefrom during the years 1911 to 1913 equivalent to 82 per cent. of the total home production. This would have been more than sufficient to provide the nitrate and nitric nitrogen required for all purposes had the means of conversion been available, which they were not, so that we were dependent on imported nitrates for various purposes, including agriculture, the manufacture of sulphuric acid, nitric acid, explosives, and other products.

Passing on to the war period, estimates for the year 1917 indicate a by-product ammonia increase of 130 per cent. in the United States, 27 per cent. in Germany, and only 6 per cent. in the United Kingdom; but Japan has in the meantime taken a considerable step forward and increased her output more than sixfold—from 8000 tons in 1913 to 50,000 tons in 1917. The production of sulphate from coke-ovens in the United States had increased by 1916 to 83 per cent. of the total output, and in the United Kingdom to more than 36 per cent. of the total. Even during 1915 and 1916 considerably more than half our production of ammonia nitrogen was exported, and we were using large quantities of imported nitrate, all of which might be produced economically by ammonia oxidation or by synthetic processes, details of which are fully discussed in the report. We have now arrived at the stage where synthetic manufacture begins to complicate the ammonia problem and the economics of the various processes require the closest attention.

With regard to post-war conditions, it is certain that agricultural demands will be much greater than formerly: many lessons were learnt during the war, not the least being that of the need for increased food production at home. The consumption of combined nitrogen practically doubled during the ten years preceding the war, and there is little doubt that the increase will continue, nitrogenous fertilisers being more and more in demand, especially now that much more land is under cultivation than in pre-war days; in fact, our own agricultural demand for fixed nitrogen in the form of sulphate of ammonia and nitrates was more than doubled during the war period only. Moreover, nitric nitrogen will be needed in increased quantities owing to the extension of chemical manufactures, such as dyes and drugs, which hitherto have been too much neglected; and with this will be involved the oxidation of by-product ammonia.

It would appear likely that the world's productive capacity should now be able to provide some 30 to 40 per cent. more combined nitrogen than in 1914, and this does not appear to be greater than would have been the case under normal conditions had the ordinary rate of growth in consumption in the pre-war period been maintained during the four years under consideration.

Now, if food production in this country is to

<sup>1</sup> "Ministry of Munitions of War. Munitions Inventions Department. Nitrogen Products Committee. Final Report." Pp. vi+357. (London: H.M. Stationery Office, 1919.) Cmd. 482. Price 4s. net. See also NATURE, January 22 and 29.

be rendered independent of imported nitrogenous fertilisers, as is surely desirable—and recent conditions have shown that it may at any time become even absolutely necessary—and if this is to be coupled with a continued large export trade in nitrogen products, we must have a considerably increased production of ammonia nitrogen.

So far, practically all the by-product nitrogen has come from the manufacture of coal-gas, producer-gas, coke, and shale-oil; two possible sources have been practically untouched, viz. peat and sewage, though from the latter, owing to our position, perhaps little may be expected—certainly so unless some simple method should be discovered for recovering the soluble nitrogen from very dilute material. At the same time, it may be pointed out that the estimated annual amount of nitrogen in the sewage of the United Kingdom is 234,900 metric tons, 86 per cent. of which is in urine.

Power cost is, of course, the great factor in the question of by-product recovery *versus* synthetic manufacture, and this is affected by coal cost: the problem is fully discussed in the report. But questions of the first importance to the by-products industries, which must strive to increase production, are such questions as the efficiency of work on existing processes, the modification and further development of such processes, and the introduction of new methods.

Reviewing the gas industry, it is seen that, with existing methods, an increase in the amount of sulphate of ammonia recovered should certainly be expected. Many small gas-works run to waste the ammonia liquor, chiefly owing to their isolated position; a proposal is made in the report to work up liquors at small works in travelling sulphate plants, but this has been attempted in several instances and afterwards abandoned. One would remark, however, that some small works might well adopt the direct system of recovery, which has in some cases served very well, and a local demand for the sulphate produced would obviate cost of transport. A general consideration of the direct method of recovery demands more attention than has been given to it; much has been done and published in recent years by the Chief Alkali Inspector. Storage of ammoniacal liquor still needs attention; there are in use inefficient methods of running ammoniacal liquor into imperfectly covered wells and tanks:

this point is strongly indicated in the report. In dealing with concentrated ammonia liquor, the losses are apt to be particularly heavy. It is considered that several thousand tons of sulphate might be added yearly to the gas industry ammonia recovery by attention to such matters as these. Moreover, it will be necessary to produce a somewhat higher grade and at the same time a neutral sulphate. But a question that demands perhaps even more attention is the introduction of new methods whereby the sulphur content of the gas itself would be made available, and so transport and use of sulphuric acid avoided. The Burkheiser and Feld processes still require to be worked out satisfactorily, and quite recently comes the proposal of Cobb to use sulphate of zinc as a starting material. These methods are perhaps all the more worthy of careful investigation owing to modern developments in the manufacture of coal-gas; the increase in the vertical retort method of carbonisation, coupled with steaming, has given rise to increased quantities of liquor of decreased strength.

In the metallurgical coke industry many of the bee-hive plants have disappeared in recent years, and this has, of course, had its effect on the ammonia production. There is now no longer any question as to the relative merits of bee-hive and by-product oven coke, and proper treatment might lead to an increase of 10 per cent. or more on the present total production of ammonia from all sources.

In the producer-gas industry, again, there is scope for investigation; scarcely sufficient stress appears to be laid on producer-gas practice as regards steaming and liming. Hydrated lime certainly has a quite appreciable effect on ammonia production, and it would seem, moreover, to admit of greater latitude in the choice of the coal used.

It is unfortunate that peat has not received more attention in this country; apart from nitrogenous by-products, some of the by-products from peat gasification appear to have quite a special value, judging from results obtained in Scotland and Ireland. Moisture and transport are, however, difficulties, yet schemes for the utilisation of peat on the spot might well be considered from a power point of view, even though the addition to the by-product nitrogen production would not be by any means of the first order.

### A Survey of National Physique.<sup>1</sup>

ONE of the more valuable after-results of the great wars in the last century was the increased interest aroused in regard to national physique, leading to various measures directed towards its improvement. After the Napoleonic wars there arose the great gymnastic clubs of

<sup>1</sup> Ministry of National Service 1917-19. Report, vol. i., upon the Physical Examination of Men of Military Age by National Service Medical Boards from November 1, 1917-October 31, 1918. Pp. iv+159+charts. (London: H.M. Stationery Office, 1920) Price 6s. net.

Central Europe and Scandinavia, which laid the foundations of physical education on a wide scale. The Civil War in America led to the first great demographic survey, the data of which were rendered public in the report of the Surgeon-General of the Federal armies on the statistics of the recruiting bureaux. The War of 1870 was followed by surveys of the population in Germany, and on a smaller scale in France, which to a large extent

formed the basis of our ethnographic knowledge until the present time. The South African War led to the Commission on Physical Deterioration in England and Wales, and to a similar Commission on Physical Education in Scotland, from the labours of which resulted the introduction of medical inspection and treatment of school children, and perhaps in part also the National Health Insurance Act.

The Report of the Ministry of National Service on the Physical Examination of Men of Military Age by National Service Boards contains a survey which in extent, in wealth of demographic detail, and in narration of the associations of inferiority of physique surpasses all previous efforts in this country, and is approached elsewhere, as yet, only by the report of the American Surgeon-General's Department mentioned above. If similar data could have been collected from all examinations from the commencement of the war, a practically complete survey would have been available for the use of future social hygienists. It is probable that the earlier figures are irrecoverable, which may mean that while we shall in the future be equipped with a knowledge of the nature and sources of physical failure, we shall have fewer data as to the measure of physical fitness among the better-endowed members of the community. The anthropologist will thus derive rather less from the report than the social economist and hygienist.

The first volume of the report, which is all that is, as yet, issued, contains a brief introduction; sections on grading as a criterion of health, the comparison of grading results, the relation of occupation and health, the causes of low grading and rejection; and regional reports from the district Commissioners. Under each head there is a series of statistics chiefly taken from special areas, but an analysis of all available observations on physique and disabilities is promised for the second volume, which is stated to be in active preparation, and will present a complete survey of the conditions in Great Britain. The data available are taken from nearly two and a half million examinations, on a carefully standardised uniform system, the subjects being classified into four grades. Owing to re-examinations, the actual numbers of individuals would be slightly smaller save in the case of those rejected as totally unfit for service.

Grade 1 consists of those who attain to the full normal standard of health and strength, and are capable of enduring physical exertion suitable to their age. They have no progressive organic disease or serious disability or deformity. These constituted 36 per cent. of the total.

Grade 2.—Those who fall short of Grade 1 by reason of partial disabilities amounted to between 22 and 23 per cent.

Grade 3.—Those who presented such marked physical disabilities or such evidence of past disease as to be deemed unfit to undergo the degree of physical exertion required for the

former, but including those fit only for clerical or sedentary work, amounted to 31-32 per cent.

Grade 4.—Those permanently and totally unfit for any form of military service numbered 10 per cent.

The proportions found in the different grades varied from time to time and from place to place according to whether the numbers coming up for examination consisted largely of older categories and those who had been rejected previously, or of those just attaining military age and those just combed out from previously protected occupations. In the main the distribution is in accordance with probabilities, with the average, however, not, as might have been hoped, among the fit, but among those with partial disabilities.

Prof. Keith submitted a comment on the earlier reports of the boards showing that on the basis of the average man being fit 70 per cent. ought to be in Grade 1, 20 per cent. in Grade 2, 7½ per cent. in Grade 3, and 2½ per cent. in Grade 4. In practice there is a grave deficit from this, though the results of examinations of certain groups, as of miners from the western part of the Welsh coalfield and of miners and agriculturists from Yorkshire during the period of the combing, showed that this theoretical standard was attained by the best of the community. Bearing in mind the physique of many who went to military service in the earlier years, and of many who remained to the end in protected occupations, the total deficit of the country is probably less than would appear from the figures in this report, yet enough is shown to indicate the need for ameliorative measures.

Prof. Keith points out that from every area, or at least from numerous and representative sample districts, there should be not only the full return of grading, but also frequency tables of stature, weight, and chest dimensions, so that anomalies in grading may be manifest and the nature of the deterioration in physique detected. He suggests that indices of fitness should be determined and shown on maps, which could then be compared with maps of other physical and social data. The indices he suggests are an index of efficient fitness or the percentage of Grade 1 men, and an index of average fitness to be derived by assigning 1 unit to each Grade 1 man, ¾ unit to each Grade 2, ½ unit to each Grade 3, and ¼ unit to each Grade 4, the whole being then added and expressed as a percentage of the total number of men examined. Many such data are given for isolated areas, so it is to be hoped that the maps may appear in vol. ii., when they will carry more conviction than tables or diagrams. Graphs of the frequency of the different gradings are given month by month for the areas, with, in the regional reports, some commentary on the classes examined. The total results show a relative inferiority in the southern part of the country.

The measurements recorded in this volume show an average for Grade 1 of 5 ft. 6 in. stature, 130 lb. weight, and 34 in. chest girth. The

general averages vary from area to area, but show, on the whole, a close similarity to those obtained by Roberts and by the Anthropometric Committee for the artisan classes some forty years back, though in this volume there are not enough data to enable the different areas to be contrasted on an ethnographic basis.

the determining factor was how a man had lived his earlier life.

The variation in physique with different occupations is very marked, as can be seen from the respective indices of fitness of groups, though it would perhaps be well to defer detailed comparison until full figures are available. The following may serve as illustrations:—

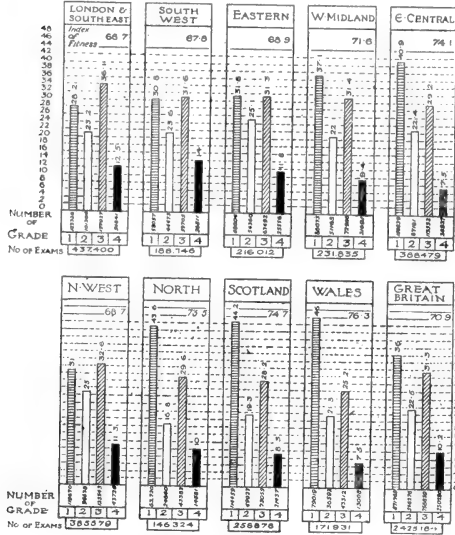

FIG. 10.—Graphical representation of physical fitness in each region of Great Britain. The diagrams show for each region the actual numbers and percentage for each grade, as well as the index of fitness. They provide, therefore, a convenient means of comparing the relative physical condition of the respective populations.

Physique and general fitness fall off with advancing years, and it is noted from several areas that after the age of fifty practically no recruits of military value are to be obtained. One Commissioner generalises the observations by pointing out that while the physical standard of early manhood was determined by inheritance modified by environment, above the age of forty,

Occupation	Index of fitness	Per cent. in Grade 1
Munition workers and colliers, St. Helens ... ..	92.8	81.8
Colliers, Wigan ... ..	91.7	77.4
Colliers, West Wales ... ..	90.5	76.0
Agriculturists, Yorks ... ..	89.9	74.8
Engineers, Yorks ... ..	85.9	60.9
Iron and steel workers ... ..	85.7	60.2
Lace workers ... ..	77.4	45.0
Woolen trade ... ..	75.7	37.5
Tailors ... ..	69.5	33.9
Cotton operatives, Stockport	57.9	19.6

This is also seen by comparison of towns—e.g. in March, 1918, Sheffield showed an index of 83.3 with 61 per cent. in Grade 1, and Leeds an index of 62 with 14.5 per cent. in Grade 1. It is evident that the men of good physique are found in the heavier occupations. Among the causes of low grading, heart disease and tuberculosis take a high place, while in some areas there is a prevalence of infantile paralysis. Contrary to expectations raised by the recent campaign on public morals, the incidence of venereal disease as a cause of low grading is nearly negligible. A special series of charts shows the full data obtained as to the relation between occupation grading and disease in the London area. Sedentary occupations show the worst results, and it is a question whether in part it is not as much that those of inferior physique gravitate to sedentary work as that this in itself is harmful. Heart and circulatory disease, and to a less extent congenital or acquired deformities, constitute the chief causes of deficiency.

The information available in this volume is such as to require almost a separate description for each section, and the Ministry is to be congratulated on a volume which should be on the shelves of every social worker and reformer.

### The Doctor of Philosophy in England.

THE neglect on the part of the English universities in not recognising a special faculty of philosophy has been remarkable, but this singular circumstance is of rare interest to the student of the history of universities. It is a curious fact indeed that the title of doctor itself dates, though with some uncertainty, to the first half of the twelfth century at Bologna, and to the middle of that century at Paris. About a century later the doctorate in law and divinity came into use in England, and in the fourteenth century followed that of medicine. In the fifteenth the English universities took the lead in conferring the degree of doctor of music. Yet doctorates in grammar,

logic, and philosophy were given in Germany so early as the thirteenth century. Until comparatively recently the M.A. in England ranked above the Mus.Doc.

To those acquainted with the history and the evolution of degrees, that of master of arts must carry the greatest respect, if not veneration, from the point of view of antiquity, for it conveys with it the first traditions of the spread of learning in Europe, being as it is by far the oldest of degrees. The earliest teachers bore the titles of lord, master, and judge (*dominus, magister, iudex*), which were in common use long before that of doctor. In fact, to this day the German



Ph.D. is primarily a master of arts, the degree being properly *Magister Artium et Doctor Philosophiae*, and is given for research, just as the Cambridge research M.A. is to-day. Whether the Cambridge research student who has already taken his M.A. will be qualified before long to add Ph.D. to his name remains, however, to be seen. Rashdall, in his "Europe in the Middle Ages," ridicules the practice now becoming prevalent in England of giving the master's and doctor's degrees in the same faculty; as, for instance, the LL.M. and LL.D. at Cambridge. Just as a doctor may have been learned in his own faculty, so was the master supposed to be supreme in his. In fact, the terms master, professor, and doctor were in the Middle Ages almost identical; and until Cambridge introduced the anachronism of the LL.M. in the nineteenth century, the master had always been regarded as equivalent to the doctor in his own special faculty. But the fusion of the two in Germany in the Ph.D. was in strict accordance with tradition, and perfectly correct.

It may be recalled that in England in the Middle Ages, as in Paris, teachers of law were styled doctors, and those of theology masters. The doctor of divinity, on the other hand, was a characteristic of Bologna, and the jealousy existing between the universities tended for some time to keep these features distinct.

In recent times, however, the doctorate has assumed a higher rank than the masterate. The University of Yale in 1860 first conferred the degree of Ph.D. after the German style, and this was followed by other universities in the United States. The commercial aspect of the question being of importance, there has been a strong tendency in recent years to recognise the disadvantages imposed upon students of research in this country, as compared with their rivals from Germany and the United States. For some time past—in fact, since 1895—Cambridge has given a Certificate for Research with the B.A. and M.A.—a distinction which is understood to rank with a first class in Part II. of the Tripos. This certificate testifies the candidate's dissertation to be "a work of importance and distinction as a record of original research." It is about the same standard as the German Ph.D. But the general public, being little acquainted with these innovations, continued to regard the Ph.D. as the hall-mark of respectability for all research workers, even in this country.

During the last year or two, however, Oxford, perceiving the need, has instituted the degree of D.Phil. for the benefit of those (a) who have attained the status of advanced student in the university, by having been placed in the first or second class in the Final Honours School, or in the first class in an Honours School of the First Public Examination, and passed all necessary examinations for the degree of B.A.; (b) students from other universities who have attained a similar standard, and can produce evidence of fitness to

engage in research, having pursued a course of study at one or more universities extending over four years at least. After two years at Oxford, such students may, as a rule, apply for the D.Phil. by presenting a dissertation, which must constitute an original contribution to knowledge, set forth in such a manner as to be fit for publication *in extenso*, being, in the opinion of the examiners, of sufficient merit to qualify for the degree.

The example of Oxford has been followed by Cambridge. A new statute authorising the degree of doctor of philosophy for research has been approved by the Privy Council, and the regulations will be put before the Senate at the first Congregation in the Easter term. The statute will rescind the old regulations relating to research students. As in the case of Oxford, the status of an advanced student, known now at Cambridge as research student, must be attained, whether by graduates of Cambridge or by students from other universities. (a) A student, being a graduate of Cambridge, who has from the time of his admission as a research student pursued in the university, or in some other recognised place of study, a course of research for not less than three years, one year of which has been spent at Cambridge, and two either at Cambridge or at some other recognised place of study, may, not earlier than the ninth, and not later than the twelfth, term from his admission as a research student, submit a dissertation embodying the results of his research. (b) A student who, not being a graduate of the university, has kept by residence not less than six terms in a course of research, and pursued research for not less than three years, two of which have been at Cambridge, and one either at Cambridge or elsewhere recognised by the authorities, may, not earlier than his ninth, and not later than his twelfth, term as a research student, submit a dissertation embodying the results of his research. It is not quite clear whether, and if so what, provisions are made for those research students who have already taken the research M.A. having worked for the prescribed period at Cambridge or elsewhere.

At present a master of arts of five years' standing—that is, *twelve* years from matriculation—may apply for the Sc.D. The fee varies from twenty-five guineas to nearly 50*l.*, according to the college. But very few ever proceed to this, since by the time the necessary status is reached most men consider that they have had sufficient patronage and paid enough for their education to trouble about it. They are usually by that time tired of examinations and of submitting themselves to the criticism of examiners, some of whom, having remained at the university, holding small teaching appointments, may not have attained quite the same status in the outer world.

It is a matter of importance that examiners for such degrees should have the confidence of the candidates, as well as of the university authorities, as being at least their equals, if not superiors,

in the knowledge of the special subjects of the dissertations; for at some universities professors who have never published anything whatever are asked, as professors, to examine, for the doctorate, candidates with a European reputation! An instance of this nature has recently occurred in one

of the universities in this country, the professors being almost unknown outside its walls. But no doubt Oxford and Cambridge may be trusted to stand above rendering such an injustice to those who seek their recognition and come from afar for the benefits they bestow.

### British Crop Production.<sup>1</sup>

By DR. EDWARD J. RUSSELL, F.R.S.

**F**ODDER and hay crops play a more important part than cereals in the economy of the farm, because they are the raw materials for a highly important part of the farmer's business—the production of meat, milk, or butter. They are too bulky to transport in any quantity, and farmers use only as much as they themselves grow. The output of meat and dairy produce is, therefore, limited by the quantities of these crops at the farmer's disposal. The quantities produced just before the war and in 1918 were:—

#### Production of Fodder and Hay Crops.

	Yield per acre 1908-17		Acreage. Millions of acres				Total produce. Millions of tons	
	England and Wales	United King- dom	England and Wales	United Kingdom	1914	1918	1914	1918
Swedes ...	13'0	14'6	1'04	0'91	1'75	1'60	24'2	22'8
Mangolds ...	19'5	19'5	0'43	0'41	0'51	0'50	9'5	10'3
	cwt.							
Hay (temporary)	29'1	32'2	1'55	1'45	2'90	2'80	4'2	4'4
Permanent grass	22'6	27'9	4'79	4'30	6'49	5'95	8'2	7'9

Like cereals and potatoes, these crops are greatly affected by artificial fertilisers, especially by phosphates, which increase not only the yield, but also the feeding value per ton. This is strikingly shown in the case of swedes and turnips, which receive a large part of the superphosphate made in this country. Mangolds respond remarkably well to potassic fertilisers and to salt. There is much to be learned from a systematic study of the influence of artificial manures on the composition and feeding value of these crops under the varied conditions of this country.

A further reason for the important part played by these crops in the economy of the farm is that they profoundly affect the fertility of the soil. They do not remove from the soil all the fertilising constituents which must be added to secure maximum growth; some of these constituents are left behind in the soil to benefit the next crop—a rare instance of double effectiveness for which the farmer ought to be profoundly thankful. In the second place, even the fertilising constituents which are absorbed by the crop are not entirely retained by the animal; considerable quantities are excreted and pass into the manure, and again are added to the soil. There is, therefore, the possibility of constant improvement of the soil; larger fodder crops enable more livestock to be kept, more livestock make more manure, and more manure gives still larger crops. It is sometimes argued that meat or milk production is in some way opposed to corn production, but on this method there is no antagonism; on the contrary, each helps the other. The production of more meat is consistent with, and indeed involves, the production of more corn.

The simplest way of utilising animal excretions without loss is to allow the animals to consume the crop on the land where it grows, and this is frequently

done excepting where the soil is so sticky as to become very unpleasant in wet weather. Sheep are the best animals for the purpose, as they are easily penned in by light hurdles, these being moved as each portion of the field is cleared; this folding is a common occurrence on the chalky and sandy soils of the Southern and Eastern Counties.

Bullocks are less tractable, and cannot be enclosed by light hurdles; they are, therefore, generally kept in yards, roofed in if possible, but oftentimes open. Sufficient straw is added to provide them with bedding and to soak up the excretions. In this way the fertilising constituents of the straw as well as of the food are returned to the soil.

In the case of dairy cows the treatment is rather different; they have to be housed properly in quarters which are sometimes palatial, and for hygienic reasons they are allowed but little bedding. Their manure is removed once daily—sometimes oftener—the primary object being to get it away without contaminating the milk. The investigations already referred to for which Lord Elveden provides the funds are now being extended to the dairy farm to see how far it is possible to save the manure without prejudice to the purity of the milk.

In the old days, when farmyard manure was the only manure and the old type of implements alone were available, farmers had to arrange their crops on a definite plan in order to get through their work and maintain permanently the productiveness of the land. There thus grew up a system known as the rotation of crops, which contributed very largely to the agricultural developments of the 'sixties, and ultimately became a rigid rule of husbandry strictly enforced over large parts of the country. Modern cultivation implements and fertilisers justify much more latitude, however, and no good farmer ought to be restricted in his cropping, provided, of course, that he maintains the fertility of his land. It is sometimes a convenience on the dairy farm to grow the same crop year after year on the same land, and the Rothamsted experiments show that this can be done, excepting only in the case of clover. With this exception there is no more need to have a rotation of crops than there is to have a rotation of tenants in a house. It is essential, however, that the land should be kept free from other competitors and from disease germs. Freedom from competition means the exclusion of weeds. In the old days this had to be effected by periodical bare fallows. Nowadays a different course is possible; modern cultivation implements worked by a tractor allow great scope for the suppression of weeds. There is, however, one crop that must be grown periodically to ensure the best results—clover or a mixture of clover and grass. Clover affords valuable food for cattle during winter, and it also enriches the soil in highly valuable nitrogenous organic matter. Much of this is the work of the plant itself, and could equally well be done by grass; but the enrichment in nitrogen is the work of bacteria residing

<sup>1</sup> Discourse delivered at the Royal Institution on Friday, February 20. Continued from p. 178.

in the nodules in the clover-roots, and is unique among the phenomena of the farm.

Unfortunately, clover, unlike other crops, cannot be grown frequently on the same land, and, consequently, the farmer is unable to make as much use of it as he would like. Investigators have for many years been trying to increase the effectiveness of the clover organism, but without result. Inoculation of the soil with virulent strains has been tried, but it was unsuccessful in this country, although results are claimed in the United States. The problem has recently been taken up at Rothamsted, and one reason found for the previous failure. The organism has several stages in its life-history, one of which is a period of rest; some conditions favour a long rest, others a shorter one, and Mr. H. G. Thornton is endeavouring to find out how to increase the activity of the organism in the soil and ensure that its work shall be done. Attention is being devoted also to the causes of failure of the crop. The clover crop furnishes some of the most important problems in arable farming before us.

In the meantime, a working solution lies in growing an admixture of grasses with the clover. This reduces the risk of failure while considerably benefiting both soil and farmer.

A typical arable district is thus a busy region in which both farmers and workers are kept constantly occupied. The crops claim attention all through the year, and particularly in summer, while in winter the animals need attention. Four or more men can be regularly employed per 100 acres. An organised village life has developed, having distinctive characteristics of its own and presenting endless scope for the intelligent social worker.

Grass farming, on the other hand, stands out in sharp contrast with all this. The grass farmer puts his animals into the fields, and Nature does the rest; when they are fat he sells them to the butcher. It is essentially summer work; the winters are left free. As no man can long remain idle, there has been an extensive development of hunting and its attendant occupation, horse-breeding, in the English grass regions. While the grass farmer's life is not all idyllic joy, it is, at any rate, free from much of the worry and uncertainty of arable farming, and it brings in sufficient money to ensure a modest competence. One can quite understand the reluctance of the farmer to quit this path of safety.

If one could accept the doctrine that a man could do what he liked with his land, the grass farmer could be left alone and reckoned among Virgil's too happy husbandmen. But this doctrine is now somewhat out of court, and the needs of the community have also to be taken into account. From this point of view grass husbandry, in spite of its safeness for the individual farmer, is not so good for the community as arable farming, since it is less productive per acre of ground. This was realised before the war, and was vividly brought to the notice of farmers by Sir Thomas Middleton, who drew up the following table:—

**Number of Persons who could be Supplied with Energy for One Year from the Products of 100 Acres of**

Poor pasture converted into meat	... 2-4
Medium pasture ditto	... 12-14
Rich pasture ditto	... 25-50
Arable land producing corn and meat	... 100-110

The area of rich pasture is very restricted. An improvement can often be made in poor and medium pasture by the use of basic slag, by drainage, and in other ways, but the results could probably never surpass those now obtained on rich pasture. None of them approach the results obtained on arable land.

During the war, therefore, the policy of the Food Production Department was to convert grassland into arable, and much was done; but now that the element of compulsion has disappeared some of the arable is going back to grass. It is not that the farmer is trying to avoid work; he is impressed by the greater risk of arable farming,<sup>2</sup> and, above all, he desires to keep to the well-established principle that his system of husbandry must suit the local conditions. This is strikingly shown by the following returns from a large number of farms:—

*Collected by the Agricultural Costings Committee.*

England and Wales—	Income per acre			Expenditure per acre			Profit <sup>2</sup> per acre			Capital per acre		
	£	s.	d.	£	s.	d.	£	s.	d.	£	s.	d.
Mixed farms ...	9	12	5	10	2	11	1	7	2	13	9	0
Dairy farms ...	14	17	0	13	18	5	1	7	4	15	7	0
Corn and sheep	7	7	1	7	4	10	1	14	2	12	10	9
Large sheep farm	1	4	3	0	17	6	0	8	5	1	7	10
All Scotland ...	5	10	9	4	15	10	1	4	11	7	7	9

The profit per acre from the large sheep farm is small in itself, but it is large in proportion to the capital and the expenditure, and, given a sufficient acreage, the farm is more lucrative than the more risky mixed or dairy farms. The risk of corn production can, and probably will, have to be met by some system of insurance or guarantee; but the need to conform to local conditions will always remain.

The problem therefore arises: Can a system of husbandry be devised which suits the natural conditions as well as grass, and is as productive of total wealth as arable crops? I believe this can be done. Grass is not the only crop adapted to moist conditions or heavy soils, and appropriate for the production of meat and milk. Many other leaf or root crops serve as well, some of which yield much more food per acre than does grass. Vetches, rape, mangolds, kale, and marrow-stem kale can all be used direct, and there are various mixtures of oats with peas, tares, vetches, etc., that can be fed green and made into hay or silage as the farmer may wish. The use of these crops in the place of grass for the feeding of livestock is known as the soiling system.

We are only just beginning to discover the combinations of crops best suited to particular conditions. An interesting experiment is in progress at the Harper Adams Agricultural College, which, however, should be repeated elsewhere. Each crop is governed by the same general laws as hold for cereals. In each case the yield and feeding value can both be increased by the proper use of artificial fertilisers, and there is the further possibility of great improvement by the plant-breeder.

It is in this direction that I think British agriculture will develop in the future. The system is strictly in accordance with the laws of science, and therefore it needs a minimum amount of artificial support. It gives the farmer abundant scope for the production of livestock, which he has always regarded as his sheet anchor, and the community an abundant production of food per acre. Most important of all, while

<sup>2</sup> On our ordinary farm at Rothamsted (distinct from the experimental land) the expenditure on arable land is continuously increasing, while that on the grassland is much less. The figures are:—

	1913-14	1917-18	1918-19
Wheat ...	£ 8.	£ 2.	£ 2.
Oats ...	5 7	10 14	14 0
Roots ...	6 4	9 7	14 5
Grass ...	17 10	20 18	26 0
Potatoes ...	21 1	37 11	46 0
Grass (hay) ...	3 19	4 16	6 0
„ (grazing) ...	2 15	2 4	3 0

Direct wage payments account for about 40 per cent. of the expenditure on arable land, but for less than 15 per cent. of that on grassland.

<sup>3</sup> Including change in valuation.

retaining the best features of our present arable and grass systems, it allows of considerable further development.

I shall not venture any opinion as to how far we could go in feeding ourselves. The accompanying table shows what we did before the war, and what, on our present technical knowledge, we could do now, assuming that the insurance problem of covering the extra risks of arable farming were solved, and assuming also a reasonable increase in the efficiency of labour.

In this country we can certainly hope to find the solution of the insurance problem, and I hope and believe of the labour problem also. Our output per acre of the arable crops is distinctly above that of many other countries, though we no longer lead as we did in the 'sixties. Our output per man, however, is not particularly good, and is open to considerable improvement. Those who know the agricultural labourer best have the fullest faith that his sterling qualities will enable him to rise to the new levels of industrial capacity which the man of science and the engineer have opened out for British agriculture. There are anxious days ahead, but with wise and sympathetic treatment the difficulties can be solved and our future assured.

*Consumption and Production of Human Food in the United Kingdom. Million Tons per Annum.*

	Consumption (1909-13)	Home production		
		Pre-war 1914	1919 <sup>4</sup>	Estimated attainable
Wheat, barley, and oats	13'4	6'5	7'0	10'0
Other cereals ... ..	3'5	—	—	—
Potatoes ... ..	5'2	4'8	6'3	7'0
Dairy produce ... ..	5'2	4'7	—	5'0
Meat ... ..	3'9	1'8	—	2'5

<sup>4</sup> Mr. McCurdy gives the following details for 1919 (see *Times*, February 18, 1920):—

*Consumption and Production of Food in the United Kingdom, 1919.*

Commodity	Estimated total consumption	Proportion of home-grown and imported produce included	
		Per cent.	
		Home-grown	Imported
	Tons		
Wheat ... ..	7,395,000	27	73
Barley ... ..	1,956,000	64	36
Oats ... ..	4,297,000	92	8
Beef and veal ... ..	995,000	66	34
Mutton and lamb ... ..	368,000	37	45
Bacon and hams ... ..	447,000	19	81
Butter ... ..	180,000	38	42
Cheese ... ..	145,000	50	70

*Notes*.—Cereals: The quantities are given after deduction for seed, and in the cases of wheat for tailings also. Bacon: The quantities given are for bacon as smoked or dried.

## Obituary.

THE death of M. LUCIEN POINCARÉ, Vice-Rector of the University of Paris, on March 9, at fifty-eight years of age, will be felt as a great loss, not only to higher education in France, but also to the *entente* between the universities of that country and those of Great Britain. Only a fortnight before M. Poincaré came to England, accompanied by Mme. Poincaré, to open the British branch of the Office National des Universités et Ecoles françaises, housed with our own Universities of the Empire Bureau in Russell Square. His speeches on February 23, at the Bureau, and on February 24, at the University of London, where he was given a special reception, and at the Lyceum Club, left on his hearers a deep impression of charm, of width of knowledge, of sound judgment, and of sympathy. M. Lucien Poincaré, like his brother Raymond, former President of the French Republic, and his cousin Henri, the great mathematician, came from Lorraine. He was a physicist by training, and took his doctor's degree with a thesis on the resistance of fused electrolytes. Like most French physicists, he began his teaching career in secondary education, and was a master first at the Lycée de Marseilles, and then at the Lycée Louis-le-Grand in Paris. For a time he was *chargé-de-cours* at the Paris Faculty of Sciences; later he entered on an administrative career and held successively the posts of Rector of the Académie of Chambéry, of Inspector-General and then Director of Secondary Education, and of Director of Higher Education at the Ministry of Public Instruction. In October, 1917, M. Poincaré was appointed official head of the University of Paris (the most distinguished post in French university administration) in succession to the veteran M. Liard.

NO. 2633, VOL. 105]

THE death is announced, at sixty-four years of age, of PROF. HECTOR TREUB, the eminent professor of gynaecology in the University of Amsterdam.

THE death of MR. H. S. B. BRINDLEY is recorded in *Engineering* for April 9 as having occurred on March 28, only three days before his name appeared on the list of newly created Knights Commanders of the British Empire. Mr. Brindley was born in 1867, and educated at the Tokio Engineering College, where his father was an instructor. He had wide experience with several engineering firms, and will be remembered chiefly by his energetic development during the war of a disused artificial stone factory at Ponders End into a shell and gun factory employing more than five thousand hands, a task which could have been accomplished only by a very exceptional man.

By the death, lately announced, of Mr. W. J. RAINBOW, the Australian Museum of Sydney, New South Wales, has lost the services of an entomologist who for twenty-four years laboured with assiduity and success to make the collection of insects and Arachnida in that institution worthy of a great colony, and has thereby laid all students of those classes under a lasting obligation. Mr. Rainbow's published works include treatises on certain groups of Lepidoptera and Diptera; but his main attention was given to the study, and especially the life-history, of spiders and scorpions. His papers on Arachnida are sixty-seven in number, one of the latest being devoted to a description and classification of the Araneidæ brought from Macquarie Island by the expedition under Sir Douglas Mawson.

## Notes.

PROF. C. J. MARTIN, F.R.S., director of the Lister Institute of Preventive Medicine; Sir William Orpen, K.B.E.; and Sir J. E. Petavel, K.B.E., F.R.S., director of the National Physical Laboratory, have been elected members of the Athenæum Club under the provisions of the rule of the club which empowers the annual election by the committee of a certain number of persons "of distinguished eminence in science, literature, the arts, or for public service."

THE Royal Danish Society of Science has elected Sir Ernest Rutherford and Sir Joseph Thomson as fellows in the physical and mathematical class, and Sir George Grierson and Prof. W. M. Lindsay fellows in the historical and philosophical class.

DR. A. McWILLIAM, formerly assistant professor of metallurgy in the University of Sheffield, and now a consultant metallurgist in that city, was invested by the King with the Order of C.B.E. on March 20. This honour was conferred upon him for his general war work in India, principally in connection with the supply of steel for war purposes.

As already announced, the Geological Survey and the Museum of Practical Geology were transferred from the Board of Education to the Department of Scientific and Industrial Research on November 1 last. The Lord President has now appointed a Geological Survey Board for the management of the work of the Survey and museum, and to submit from time to time recommendations on developments that appear to be necessary as the work progresses. The Board, as at present constituted, consists of Sir Francis G. Ogilvie (chairman), Prof. W. S. Boulton, Prof. J. W. Gregory, Dr. John Horne, Prof. J. E. Marr, Mr. Frank Merricks, and Mr. W. Russell.

SIR HENRY HOWORTH has presented to the Geological Department of the British Museum (Natural History) the collection of mammalian and other remains obtained by Mr. W. J. Lewis Abbott from a fissure near Ightham, Kent. This collection is especially important on account of the care with which the bones of the small animals were extricated and preserved. The ordinary larger specimens belong to the woolly rhinoceros, mammoth, reindeer, stag, roebuck, horse, and hyena, and show that the greater part of the fauna at least dates back to the latter part of the Pleistocene period. All the circumstances of the discovery were discussed by Messrs. Abbott and E. T. Newton in the Geological Society's Quarterly Journal in 1894.

DR. CARLOS AMEGHINO, director of the Argentine National Museum, announces that he has recently discovered the oldest known remains of man at Miramar, near Mar del Plata, on the coast of the province of Buenos Aires. Human remains were found in the same district several years ago in association with stone implements and with bones of the extinct Toxodon and ground-sloths; but according to the observations of Dr. Aleš Hrdlička and Dr. Bailey Willis (Smithsonian Institution, Bureau of

American Ethnology, Bulletin 52, 1912), they are of no great antiquity, and probably represent a modern South American race. All the supposed discoveries of early man in America have hitherto proved unsatisfactory, and Dr. Ameghino's detailed report on the latest find will be awaited with interest.

CAPT. VAUGHAN-WILLIAMS, who is excavating the supposed site of Edward the Confessor's palace in Windsor Great Park, has discovered what is believed to be the dedication-stone of a Saxon place of worship. Upon the stone are the marks of a cross and what looks like Saxon lettering. Among other discoveries are the remains of a kitchen and banqueting-hall and the traces of what seem to be Roman baths. This confirms the statement of Mr. Forester that the palace of the Saxon king was built upon the site of a Roman villa, which was provided, as usual, with a series of baths. The remains of the chapel indicate that it was 40 ft. long, and, according to Bishop Browne, who recently inspected it, it contained an altar for the worship of God, and one smaller for the worship of devils.

NINETEEN years ago the splendid survivor of the Great Trilithon at Stonehenge was in a very dangerous condition, but it was set upright again, and now the Office of Works, in association with the Society of Antiquaries, is engaged in restoring to a position of safety other stones that are in danger. A question of interest has been raised during the work now in progress. Just inside the Ditch a circle of holes has been discovered in the chalk, which mark the site of an outer circle of stones. In these holes have been found charred human bones, bits of burnt animals' bones, or only a single tine of a stag's horn. Aubrey's map, made in 1666, showed in approximately the position of these newly found holes a series of depressions in the turf which have since then disappeared. In one was shown a stone which has since been removed. The detached stone, well known as the "Slaughtering Stone," which lies in line with the "Hele Stone," appears to fit almost exactly into place in this new circle. Whether it is the last survivor of an outer circle of stones, and whether this outer ring was coeval with Avebury and made before Stonehenge itself existed—these are questions which cannot now be answered until further excavations help to solve the problem.

THE James Forrest lecture for the present year will be delivered at the Institution of Civil Engineers by Sir Dugald Clerk at 5.30 on Tuesday, April 20. The subject will be "Fuel Conservation in the United Kingdom."

THE fourth Guthrie lecture of the Physical Society of London will be delivered on Friday, April 23, at 5 o'clock, by M. C. E. Guillaume, who will take as his subject "The Anomaly of the Nickel-Iron Alloys: Its Causes and its Applications."

SIR GEORGE NEWMAN will deliver the Lady Priestley memorial lecture of the National Health Society on Thursday, April 22, at the Royal Society of Medicine.

His subject will be "Preventive Medicine: The Importance of an Educated Public Opinion."

THE Wilbur Wright lecture of the Royal Aeronautical Society for the present year will be delivered on Tuesday, June 22, at the Central Hall, Westminster, by Comdr. J. C. Hunsaker, U.S.N., who will take as his subject "Naval Architecture in Aeronautics."

UNDER the auspices of the National Union of Scientific Workers a public meeting, presided over by Mr. H. G. Wells, is to be held at 8 o'clock on Wednesday, April 28, in the lecture-theatre of Birkbeck College, Breams Buildings, E.C.4, addressed by Prof. F. Soddy on "The Public Support of Scientific Research." The address will be followed by a discussion.

THE Scottish Shale Oil Scientific and Industrial Research Association has been approved by the Department of Scientific and Industrial Research as complying with the conditions laid down in the Government scheme for the encouragement of industrial research. The association may be approached through Mr. W. Fraser, C.B.E., Scottish Oils, Ltd., 135 Buchanan Street, Glasgow.

A COMMUNICATION has been received from the Decimal Association criticising the recent report of the Royal Commission on Decimal Coinage. The association maintains that the report cannot be accepted as final for the following reasons, among others:—The Commission ignores the fact that eleven of our Colonies or Dependencies have already adopted decimal coinage, and that our non-decimal Dominions have repeatedly advocated the establishment of the decimal principle in currency. Further, the report exaggerates the difficulties which would be caused by the abolition of the penny, and takes no account of the altered and daily decreasing purchasing power of that coin. The Decimal Association considers that the first minority report represents the actual opinion of the community, and that the decision given in the main report is short-sighted and unpopular. For these reasons the association intends to persist with its active propaganda in favour of the reform.

IN *Ancient Egypt* (part i., 1920) Prof. Flinders Petrie describes the hoard of personal ornaments found some ten years ago at Antinoe, in Upper Egypt. Unfortunately, the hoard was not preserved intact, and the valuables are now scattered in London, Berlin, Detroit, and the Pierpont Morgan collection. The greater part of the treasure, now described by Dr. Dennison, is dated by coins to the time between Justinian and Mauricius Tiberius, the latter half of the sixth century. The finest object is a great necklet with fourteen inserted coins from Theodosius to Justinian, and a barbaric imitation of a gold coin of Valentinian III, as a centre-piece, the taste for making imitations of coins for ornament being familiar in North Europe. Prof. Petrie attributes the dispersal of the collection to the present Egyptian law of treasure-trove. If the Government would pay, as dealers do, the local prices, collections could be purchased much below the value

in Europe, and the profit would go to the State, not to the dealer.

THE probability of the Norse discovery of Spitsbergen before the voyage of Barents in 1596 is the subject of an article by Dr. F. Nansen in *Naturen* for January-February, 1920. It has long been a matter for discussion whether the Svalbard of the Icelandic annals was Spitsbergen, and the weight of evidence favours the belief that it was. Dr. Nansen reproduces an Icelandic map published in the sixteenth century, before Barents's discovery, which certainly suggests that Svalbard was the coast of Spitsbergen. At the same time, it does not preclude the possibility of its identification with north-eastern Greenland; but this explanation is improbable, in view of the courses given for reaching Svalbard from Iceland. Dr. Nansen believes that the Norsemen found Svalbard by chance, some vessel having been driven out of its course by a gale. He thinks that the greater attraction of the fisheries on the coast of Norway, particularly the Lofoten Islands, diverted attention from Svalbard, which was eventually forgotten. There is no evidence whatever that Barents made any use of Norwegian knowledge in his voyage in 1596. The article contains a good reproduction of the map known as Barents's chart, published in 1599 by Cornelius Claesz.

A WELL-KNOWN and much-advertised institute of mind-training has sent us particulars of a laboratory of applied psychology which it has organised and equipped. For a specified fee the laboratory, it is stated, "will enable those who need vocational guidance to discover with scientific accuracy their strong and weak points, and to obtain expert advice on the choice of a career. . . . Those living at a distance can have tests forwarded by post." Vocational psychology is the youngest branch of the youngest of the sciences; it is not ten years since the publication of the well-known books by Taylor and by Münsterberg upon industrial psychology and so-called scientific management. Many, therefore, will doubt whether any laboratory can yet state the vocational qualifications of a given individual "with scientific accuracy" either by post or otherwise, much less whether an institute organised for profit is the proper place for such investigations. At the same time the new venture is a striking testimony to the advance made by psychology, both during and since the war, into fields of practical application; and, clearly and ably written as they are, the two pamphlets issued by the new laboratory, on "Choosing a Vocation" and on "Choosing Employees," may do useful service in acquainting both employers' and applicants for employment with the possibility of scientific method in vocational guidance, and with the probability that, when established by disinterested research, such methods will be as superior to the current methods of personal preference or of phrenological advice as the prescriptions of a properly qualified medical specialist are superior to the pills of a wise grandmother or the potions of a local herbalist.

WE have on several occasions referred to articles in the *Cologne Post*—a daily paper published by the

Army of the Rhine—on educational institutions and work connected with the Army of Occupation. The first number appeared on March 31, 1919, and a copy of the anniversary issue reached us a few days ago. The journal has been most successful, and is exerting a very valuable influence in revealing British thought and spirit to Germany. It has a large circle of German readers, and is used in many schools for reading lessons and the study of English. "Here," says an editorial article in the anniversary number, "in this great German city we bide, facing a wonderful land torn with dissensions, after the mightiest conflict of all time; we of the *Cologne Post*—a little band of soldier scribes—and, never forgetting the ravaged west which lies behind us, we are facing east, where the sun rises." To the staff which is thus promoting a better understanding between two peoples we offer our most cordial congratulations upon the success of their faithful and intelligent work. It is particularly appropriate that we should associate ourselves with other good wishes in this expression, because Capt. W. E. Rolston, the editor and manager of the *Cologne Post*, was, before the war, a constant contributor to our columns. He was formerly an assistant to Sir Norman Lockyer in the Solar Physics Observatory at South Kensington, and when the observatory was transferred to Cambridge he went with it. For several years he wrote the whole of the notes in Our Astronomical Column, and also contributed numerous articles and reviews. Capt. Rolston provides another example of the value of a scientific training to business management and literary balance, and his devoted attention to what is really a unique newspaper merits the fullest official recognition.

In a study of the colour and markings of pedigree Hereford cattle (*Journal of Genetics*, vol. ix., No. 3) Miss F. Pitt finds that the breed arose by selection from the nondescript cattle of the county during the seventeenth and early eighteenth centuries. All sorts of colours and markings prevailed, but among them the red with white face, which is still characteristic of the breed, was most common. This pattern probably originated through a mutation which appeared in a dark herd in 1750, and was kept and bred from as a curiosity. The white face is a dominant condition, while excessive white in modern Herefords is found to be recessive to the typical pigmentation. Variations from type which now occur in the breed are due to the outcrop of recessive characters inherited from the time before pattern selection was practised.

CONSIDERABLE foliage injury is reported in Michigan owing to the substitution of calcium and magnesium arsenates for lead arsenate for spraying purposes. The Quarterly Bulletin of the Michigan Agricultural College Experiment Station (vol. ii., No. 2, November, 1919) reports interesting tests carried out to discover the reasons for this injury. Plants in respiring give out considerable quantities of carbon dioxide, with which the film of moisture on the leaves is presumably charged. The tests show that calcium and magnesium arsenates are very much more soluble

in carbonated water than in pure water, while for lead arsenate the reverse is true. It seems, therefore, that this solubility of calcium and magnesium arsenates in carbon dioxide is the cause of the foliage injury occurring in fruit-trees sprayed with these materials. It is suggested that the addition of lime to the spray mixture may prevent the injury, but this suggestion awaits proof.

As the result of comprehensive tests carried out by the New South Wales Department of Agriculture on two of their experimental farms, it is claimed that a more satisfactory method has been found of treating seed-wheat for bunt than by pickling in a bluestone solution. According to *Science and Industry* (Australia), carbonate of copper gives the best results, as has been shown after many years of experimenting with other substances. The method which the investigators recommend is to dust dry copper carbonate through the grain at the rate of 2 oz. of the fungicide to one bushel of wheat. Substantial increases in the yield per acre were obtained in comparison with pickled seed, while other advantages which the new process possesses over established practice are said to be that (1) no water is necessary; (2) no injurious effect is caused to either the grain or the young plant, as is the case with bluestone pickling; (3) seed-wheat can be treated weeks before it is sown; (4) no damage is done to the grain if it should lie in a dry seed-bed for weeks without germinating; (5) better germination is obtained; and (6) the process is quicker and less laborious than wet pickling.

An Official Guide has been issued (143 pages, price 2s.) to the Museum of British Forestry (Museum No. 4) at the Royal Botanic Gardens, Kew. This museum, which was opened in 1910, occupies Cambridge Cottage, formerly the residence of the Duke of Cambridge. The term "forestry" is more correctly used as synonymous with silviculture—that is, for trees and shrubs that are grown for commercial purposes—the term "arboriculture" being used for trees and shrubs that are grown as specimen plants or for purely ornamental work. The objects in view in the production of the two types of trees are very different, and the mature specimens differ in appearance. The scope of the museum is at present limited to collections of timber, fruits and seeds of trees, dried specimens of a few types of hardy trees and shrubs, photographs of isolated trees and plantations, the fungus- and insect-diseases of trees, articles manufactured from British-grown timber, and tools and machinery used in silvicultural and arboricultural operations. In most instances the specimens shown have been grown, manufactured, or collected in the British Isles. Room No. 3 contains a series of special interest to the student, and illustrates the trees and shrubs native to or planted in Great Britain, with a brief account of their economic uses; the arrangement is according to the natural families. Injuries to trees caused by various agencies—animals, parasitic or climbing plants, fungi, and insects—are also illustrated in detail. Apart from its service as a guide to the museum, the booklet contains much

useful information on our British-grown trees and their economic value.

ATTENTION may be usefully directed to the high grade of Indian bauxites now under development, as represented by analyses given by Dr. L. L. Fermor in his article on "The Mineral Resources of the Central Provinces" (Rec. Geol. Surv. India, vol. 1, p. 273, 1919).

DR. HOLTEDAHLS interesting maps and discussion of the distribution of land and water in the North Atlantic region in Palæozoic times (see NATURE, vol. ciii., p. 433) have been reproduced for readers of English in the *American Journal of Science* for January (vol. xlix., p. 1). Some corrections have been noted in the separate copies sent out by the author, the most important being the accidental exchange of the titles of Figs. 9 and 11, which should be rectified by those who may use them in their re-issued form.

In a paper on "Old Age and Extinction in Fossils" (Proc. Geol. Assoc., vol. xxx., p. 102, 1919) Dr. W. D. Lang directs attention to the reluctance—perhaps better called indifference—of the female to the reception of the male animal, as exhibited, for instance, by mosquitoes, as a possible cause of extinction of a group. He applies this possibility to the ammonites; but his main thesis is that extinction may result from exaggeration of a structure on the removal of an inhibiting influence. Environment may thus be effective, but the tendency in the organism is, on the whole, superior to external influences in affecting evolution and decadence. The increase in deposition of calcium carbonate in the Cretaceous cheilostomata, and the "exhaustion of their ancestral potentialities" in the case of the rugose corals, are utilised as examples in a discussion that would obviously bear expansion.

SCIENTIFIC Paper No. 363 of the Bureau of Standards (Washington) just to hand deals with the manner of preparation and determination of the spectral reflective properties of certain alloys of aluminium with magnesium and with zinc by R. G. Waltenberg and W. W. Coblenz. The investigators found that all these alloys tarnish in time, and hence are not suitable for mirrors where permanency is of the first importance. The compound of aluminium and magnesium,  $Al_3Mg_2$ , deteriorates less rapidly than any of the other alloys examined, and could be used in apparatus where a highly reflecting mirror is desired for a short time. A reflectivity of 92 per cent. at  $0.7\mu$  was obtained with this compound. The zinc-aluminium alloy has a minimum reflectivity at  $0.9\mu$ . An examination of the reflectivity of pure zinc revealed a similar reflectivity minimum at  $0.7\mu$ .

In a paper on "The Development of the Atomic Theory," by A. N. Meldrum, of the Bombay University, published by the Oxford University Press, a plea is put forward that historical questions should be made the subject of serious investigation and dis-

ussion, and should be taught in the universities by those who have given special attention to them. The paper is devoted very largely to vindicating the view that the atomic theory was not originated as a pure novelty by Dalton, but was a legitimate development of Newton's views. Attention is directed to the importance of Newton's theory of the repulsion of gaseous particles in the theoretical views of Bryan Higgins, William Higgins, and Dalton. Thus Bryan Higgins suggested that ammonia and hydrogen chloride must unite particle with particle, and in no other way, since if two particles of ammonia attempted to combine with a single particle of acid, one of them would be driven away from the acid by the mutual repulsion of the two particles of ammonia. William Higgins, for the same reason, assumed that, since like atoms repel one another, the most stable combination of dissimilar atoms is in the ratio 1:1, then 2:1, and then 3:1. This view did not attract so much attention as it deserved, but was identical with the method used by Dalton in deducing the formulæ of compounds. It is suggested that Dalton did not necessarily borrow his views from Higgins, but that both workers, starting from Newton's doctrine of an elastic fluid composed of mutually repulsive particles, followed much the same train of thought and reached essentially the same conclusions.

PROF. AIMÉ WITZ, professor of physics at Lille University, contributes a well-reasoned article on heat economy to the issue of the *Revue générale des Sciences* for March 15. He reviews in turn the merits of steam-engine and turbine plants, internal-combustion engines, and electric power distribution from the point of view of thermodynamic efficiency. As regards the reciprocating steam engine, he counsels caution in the replacement of this method of heat utilisation by turbo-electric plants in small works, and cites figures to show that the generic efficiency of the former may be extremely favourable under certain conditions. Much progress has been effected in recent years in the design of exhaust steam turbines, and in certain cases it may be very desirable to run a low-pressure turbine off the large cylinder of a multiple expansion steam engine of the reciprocating type, and thus effect a better yield per pound of steam expended. On the wider (national) question the author devotes considerable space to the subject of the gasification of coal at the place of production and its direct utilisation for power purposes, with the recovery of by-products, the gas generated being used for running large gas engines, and the heavy residual oils for internal-combustion engines of the Diesel type. In this connection he gives some figures showing the very satisfactory results obtained at certain mines in France from installations run from coke-oven gas, supplemented by steam units, for power purposes. Finally, he reviews the claims for a national electric network, comprising a number of single and self-governing units combined to meet all the possible demands of industry. The paper is well worthy of study by all who are interested in the better utilisation of our fuel resources.



## Our Astronomical Column.

CONJUNCTION OF JUPITER AND NEPTUNE.—On the morning of April 20 these planets will be within  $1^{\circ}$  of each other; the actual distance at 4 a.m. will be  $0^{\circ} 55'$ , Jupiter being on the north side of Neptune. Jupiter will set at 2.37 a.m. The motion of the two objects is so slow that in the earlier hours of the night of April 19 their relative positions will be but slightly different from that at the time of conjunction on April 20 at 4 a.m. Neptune will be situated in Cancer about  $2^{\circ}$  east-south-east of the star cluster called Præsepe and  $1\frac{1}{2}^{\circ}$  east of the star  $\delta$  Cancri. Neptune may be easily picked up in a good telescope, but is not brighter than about eighth magnitude. To identify this faint object if the small stars north of Jupiter are unknown requires that the observer should make a diagram of the objects in the field of the telescope and compare it with later observations in a few weeks' time. At the period of conjunction Neptune will be stationary.

A NOVA IN A SPIRAL NEBULA.—*Ast. Nach.*, 5038, contains a note by Prof. Wolf on the discovery of a nova in the faint spiral nebula N.G.C. 2608 (position for 1860, R.A. 8h. 26.7m., N. decl.  $28^{\circ} 56'$ ). The nebula is shaped like the letter S; the star is near the left-hand point of the upper curve. There are two nuclei, of which the north preceding is the brighter. The nova is  $18.6'$  from this nucleus, in P.A.  $280^{\circ}$ . It was discovered on a plate taken on February 8 last, and was afterwards found to be registered faintly on plates taken on January 25 (near edge of plate, bad image) and February 7. Plates taken in previous years were examined, and showed no trace of the star; a small nebular condensation was, however, visible in the neighbourhood. The latest available plate was taken on 1918 February 5.

Short exposures were secured of the nebula on February 11 and 12; the nova appeared brighter visually on the former date. On the latter its photographic magnitude was 10.7. A sketch-map of the field is given in *Ast. Nach.*, with magnitudes of comparison stars. It is important to obtain good light-curves of these novæ in spirals, as they sometimes give a clue to the absolute magnitude of the star, and hence of the distance of the spiral. The region will be observable for the next two months.

Observations on March 10 gave the magnitude of the nova as 11.5.

THE MADRID OBSERVATORY.—The "Anuario del Observatorio de Madrid para 1920," in addition to the usual almanac information, particulars of the sun-spots and prominences in 1918, and meteorological observations, contains a useful article by Señor C. Puento on methods of determining time and latitude by means of portable instruments in the field. Special attention is directed to the circumzenithal telescope designed by Nußl and Frič, of Prague, which consists of a small horizontal telescope which can be rotated in azimuth. A silvered prism with vertical angle  $\alpha$  is mounted outside the object-glass; the upper face reflects light from a star of altitude  $180^{\circ} - \alpha$ , the lower face light from the same star after reflection by a very small mercury trough. Coincidence of the two images is observed in the telescope, and gives the instant when the star's altitude is  $180^{\circ} - \alpha$ . There are some advantages in making this angle equal to the latitude, but this is not essential. Tables are given facilitating the construction of working catalogues. Observations of several known stars make it possible to deduce both time and latitude. The instrument is similar to the almuccantar in theory, but far more portable and easier to work with. The absence of all webs and screws is a decided advantage.

## National Education.

THE fiftieth annual meeting of the National Union of Teachers, founded in 1870, at which some 2000 delegates were present, representing a membership of 113,000 as compared with 400 on its formation, was held during Easter week at Margate. The proceedings were opened by a well-timed and thoughtful address on the part of the new president, Miss J. F. Wood, of the Fielden School, Manchester (herself a pioneer in the endeavour to bring opportunities of advanced secondary education within the reach of children leaving school during their fourteenth or fifteenth year), in which she reviewed the history of popular education since the Act of 1870, recounting its onward progress and making clear the objects still to be achieved, to ensure which all the various classes of teachers should make a common effort and present a united front. The Act of 1918, with which the name of Mr. Fisher will be linked in honour for all time, provides for fuller opportunities of education for elder children in elementary schools, for their easier transfer to higher schools by means of maintenance grants, for closer attention to conditions of physical health and education, and especially for the continued part-time education up to eighteen years of age of adolescents entering industrial life at fourteen.

The president pleaded for a more unified conception of education if these objects are to be attained and the full value of education to the nation is to be realised. Every child capable of profiting by advanced courses of education and training, whether given in higher or special schools or in the universities, should be afforded the fullest facilities. Wherever possible the elementary school should be enlarged in scope, with freedom to develop its own "top," and so obviate the necessity for the establishment of the central school with its futile two-year course. The further education of adolescent workers should have careful consideration, and, having regard to the mechanical nature of much of their work, also have in view the claims of leisure. With the purpose of fitting the primary teacher for all branches of education service, including the administrative, he should in all cases, in addition to appropriate professional training, be also required to take a university degree. The claim of women to be afforded equal opportunities with men to aim at the highest in the career they enter and with the same reward was firmly stressed. The future progress of education depends not only upon more suitable buildings, adequate playgrounds and equipment, and smaller classes, but also upon the supply of able and well-educated teachers, who must be attracted first by the nature of the work, and then by adequate pay, status, and prospects. There should be ensured also the full co-operation of the Board of Education, the local education authorities, and the teachers with the view of securing full partnership in administration, and, above all, of winning for all children a free and liberal education.

Among the many important topics discussed during the conference, reference may be made to that dealing with a national system of education, which received the full assent of the conference, and embodied proposals for (1) free education for all to the fullest extent of their capacity to profit by it; (2) the provision of maintenance grants where necessary; (3) the due co-ordination of schools, so that graduation from one to another of higher type shall be easy; (4) uniform regulations for all schools in respect of size of classes, adequacy of staff, floor- and air-space, playing grounds and fields, and swimming baths; (5) medical examinations, and treatment where neces-

sary; (6) the right of any qualified teacher to teach in any capacity in any State-aided school; (7) no class in any type of school to exceed thirty on the roll, and each class to have its own qualified teacher; and (8) the curriculum of the primary school should be liberal and non-vocational, with the aim of promoting true citizenship and high personal character. It was also suggested that the attention of public opinion and of organisations representing parents of elementary-school children should be directed to the powers now possessed by persons interested in education to secure substantial improvements in the educational facilities provided in their localities by means of representations on the schemes prepared by local education authorities under the Act of 1918, where such schemes fail to attain the standard set up in the foregoing proposals, and that county and local teachers' associations should stimulate the demand for the full benefits of the Act of 1918 in each locality.

A further important topic discussed at the conference was "The Supply and Training of Teachers." The scheme submitted was approved by the conference, and included the following main requirements: (1) All intending candidates should have completed a satisfactory course of higher education, and show by adequate tests their fitness for the profession; (2) the admission to the graduate course should be the standard of matriculation; (3) the course of study should include "Education" as a principal subject for the degree, and the course be followed in association with other students entering for other professions; (4) a period of one year should, as a rule, be devoted to the acquisition of skill in teaching, the existing training colleges (which should be recognised as colleges of the university) being utilised for this purpose alone, whilst education research work should be a distinct feature of the college staff and students; (5) on the completion of the academic and professional training the teacher should be eligible for recognition by the Board of Education for service in any approved school; and (6) the teachers of special subjects should be required to take a course of higher education and of professional training.

### Aeronautics at the Imperial College.

SIR RICHARD GLAZEBROOK, the occupant of the Zaharoff chair of aeronautics at the Imperial College of Science and Technology, completed on March 24 the series of five lectures which initiate the new course of study. It will be remembered that Sir Basil Zaharoff founded similar chairs in Paris and in Petrograd. The London chair has been chosen by the Government as the nucleus around which to organise a central school of aeronautics—a scheme in which the new professor's long experience as Director of the National Physical Laboratory, chairman of the Advisory Committee for Aeronautics, and, latterly, chairman of the Government Committee on Education and Research in Aeronautics, will be of immense help. In the years to come the courses of instruction so provided will doubtless prove of service to officers of the Royal Air Force selected by the Air Ministry for higher technical training, in addition to such numbers of other students as the then position of civil aviation may inspire to join this new and adventurous profession.

The attendance at this initial course of lectures must have been encouraging to the lecturer, if only as an indication of a widespread general interest in the subject. In the circumstances, the lectures were,

naturally and rightly, of a simple character, only the last one, on air-screws, being at all technical.

Sir Richard Glazebrook in his first lecture paid a tribute to the munificence of the founder of his chair, and proceeded to a description of the experimental wind-channels and of full-scale experiments on aircraft. He was able to show how, on Lord Rayleigh's law of similarity, the measurements made by the one method could be compared with the other. The agreement in most cases was reasonably satisfactory, though enough anomalies had been found to provide an ample field for future research work. This was followed by a lecture on the principles of automatic and inherent stability. The former is achieved by the use of auxiliary apparatus, whether mechanical or aerodynamic, to operate the controls of the machine; and the latter by providing, in the original design, such sizes and positions for the aerodynamic surfaces that any departure of the machine from its normal position brings into play forces which tend to restore it to that position, and create a "damping" couple sufficient to prevent the continuance of such oscillations. Inherent stability can, as experience has amply shown, be provided for by careful design, so that automatic apparatus for the purpose is quite unnecessary. Commercial machines should be decidedly stable, fighting machines only just stable. Sir Richard Glazebrook was able to show (with Mr. Naylor's assistance) a number of mica models in flight, and so to illustrate the various forms and degrees of stability and instability.

The third lecture was concerned with the instruments essential to flight, and included the air-speed indicator, the engine-revolution indicator, the altimeter, the clinometer (to indicate side slip), the statorscope (to show the rate of climb), and the turn indicator. The statorscope measures the rate of air leakage through a small hole in a vessel kept at a constant temperature. Turn indicators are of two forms, the static head type and the precessional gyro type; these are later inventions than the other instruments mentioned.

Among the most important measurements made on an aeroplane are the determinations of oscillation in yaw, roll, and pitch; for such experiments use can conveniently be made of the sun as a fixed point, since the motion of a shadow of some part of an aeroplane on the rest of the machine can be employed to obtain a photographic trace of the oscillations. This work, however, is really only just beginning.

In view of the enormous inertia forces which come on a machine when "stunting," it is essential to obtain a continuous record of their amount during all parts of the flight-path concerned. For this purpose a stiff fibre acted as an acceleration index, and some most valuable records were obtained. On occasion the force on the wings of the machine might be three, or even four, times the weight of the aeroplane.

This naturally led in the fourth lecture to a consideration of the strength of the wing structure and to statements of the load factors necessary in design. The load factor is the ratio of the breaking load to the normal load corresponding to horizontal straight flight at the designed speed. Another important coefficient is the factor of safety, and this is the ratio of the breaking load to the loading incurred during some specified operation, e.g. a vertical nose-dive. The load factor needs to be fixed at a higher figure for machines which, like fighting machines, have to "stunt."

Sir Richard Glazebrook's fifth and last lecture was of special interest. The subject, "Air-Screws,"

is intricate, and not one in which it is easy to excite interest in a general audience. It is, therefore, much to the lecturer's credit that he succeeded in making the subject not only intelligible, but also interesting. He discussed first Froude's theory of the screw, and then showed how the various factors in the resulting equations had been checked by experimental work both in the wind-channel and on the "rotating arm" apparatus. Incidentally, he referred to the flapping flight of birds, showed how difficult it would be to imitate this, and doubted whether true progress lay in this direction. Mankind had made much use of the wheel in mechanism; evolution had led to the introduction of no such element in animal life, in spite of its proved efficiency in its many human applications. This afforded an argument that man had here beaten un instructed Nature. The only flying animal which approached the aeroplane in design was perhaps the beetle, which possibly used its horny wing-covers as stationary planes and its wings as a means of propulsion.

### The Parallaxes of Globular Clusters and Spiral Nebulæ.

IT may be remembered that Dr. Charlier expressed doubt as to the correctness of the enormous distances for globular clusters announced by Dr. Harlow Shapley. Mr. Knut Lundmark, of Upsala Observatory, undertook a re-examination of the question, taking different lines of evidence from those used by Dr. Shapley. His work is published in *Kungl. Svenska vetenskapsakademiens Handlingar*, Band 60, No. 8. His data are avowedly of a much less precise character than those used by Dr. Shapley, but they lead to results of the same order of magnitude:—

(1) The discussion of the proper motion of those clusters for which data are available indicates a value not exceeding 1" per century. Accepting this maximum value, and combining it with the mean radial velocity of clusters found by Prof. Slipher, Mr. Lundmark finds the distance 3000 parsecs, one-fifth of Dr. Shapley's value.

(2) Use is made of Kapteyn's luminosity law. Van Schouten has already applied this method to the clusters M<sub>3</sub>, 5, 11, and 13, obtaining distances that are, in the mean, twenty-eight times those of Dr. Charlier and one-eighth of those of Dr. Shapley. His work is here revised, estimation being made of the spectral type of the stars from Dr. Shapley's observed colour-indices. The mean of several independent estimations gives 6000 parsecs for the distance of M<sub>3</sub> and M<sub>13</sub>.

(3) A rough estimate of distance is made from the observed mean absolute magnitudes of stars of different spectral types. Various assumptions are made as regards the mean spectral type of the stars employed. In the mean the distances found are about eighty times those of Dr. Charlier, or one-third of those of Dr. Shapley.

(4) Holetschek has investigated the apparent magnitudes of several clusters regarded as single objects. Mr. Lundmark shows that his values are about 7½ magnitudes brighter than Dr. Shapley's mean values of the twenty-five brightest stars in the respective clusters, this difference being very nearly constant.

It follows that the assumption that the absolute magnitude of a cluster is constant will lead to relative distances of the different clusters proportional to those deduced by Dr. Shapley.

The four lines of evidence outlined above, though

individually weak, have cumulative force, and tend to increase confidence in the accuracy of Dr. Shapley's work.

Mr. Lundmark uses Prof. Slipher's radial velocities of clusters to determine the sun's motion with regard to them. He finds that its velocity is 381 km./sec. towards R.A. 320°, N. decl. 74°. He notes that both the R.A. and declination of the solar apex as determined from stars tend to increase as fainter stars are used. This is explained by a larger proportion of the stars being outside the local cluster. He suggests that his value is the limit to which the others are tending.

Mr. Lundmark passes on to consider the parallaxes of the spiral nebulæ.

(1) Beginning with the Andromeda nebula, he quotes all the directly observed measures of its parallax. They are discordant, but their mean is near zero.

(2) The star density increases towards the middle of the Andromeda nebula, in spite of the nebulosity tending to veil them. It is concluded that the nebula is more distant than the non-nebular faint stars in the region. A combination of the results of many workers indicates a distance of 3000 parsecs for these faint stars.

(3) A combination of measured angular rotation of spirals with the values of the linear rotational speed given by the spectroscope has led to estimates of distance somewhat greater than the last, say 4000 parsecs. It is further shown that the mass necessary to control the rotation is  $10^9 \times \text{sun}$ , of the same order as the estimated mass of the stellar system.

(4) Making the rather doubtful assumption that the dark curves in various nebulæ have the same absolute dimensions as the similar dark regions in the galaxy, Wolf finds distances for various spirals ranging from 10,000 to 200,000 parsecs.

(5) Comparisons of the light curves of novæ in spirals with those in the galaxy, while they involve several rather doubtful assumptions, give very large distances for the spirals, 200,000 parsecs being found for the Andromeda nebula. Bullialdus noted that the Andromeda nebula was exceptionally bright in the year 1664. It is conjectured that a nova of magnitude 5 or 6 may have appeared in it at that time.

From the above and other considerations Mr. Lundmark locates the spiral nebulæ far beyond the galactic limits, but inclines to the view that they are the star-producing mechanisms of Mr. Jeans's theory rather than counterparts of the galaxy. Their linear dimensions appear to be much inferior to the latter, of which our ideas have lately been enlarged by Dr. Shapley's and other researches.

### The Forestry Commission.

WE are informed that the Forestry Commissioners who were appointed on November 29 last at once proceeded with the planting programme for 1919-20. The shortage of forest-tree seed has been met to a great extent by purchases in Austria and elsewhere and by gifts from the United States and Canada. About 34,000 acres of afforestable land are in course of acquisition by purchase or on lease, in some cases below the market value and in others as free gifts from landowners. Rather more than 10,000 acres are in England, of which 3500 are in Suffolk, 2760 in Devon, 1150 in Cumberland, and 1800 in Northamptonshire and Bedfordshire. More than 5000 acres are in Ireland, of which 2000 are in Tyrone, 1500 in County Galway, 1500 in King's County, and

the remainder in County Cork. The remaining 18,000 acres under acquisition are in Scotland. Planting is proceeding at thirteen centres—six in England and Wales, six in Scotland, and one in Ireland. Statistical work is being carried out and preliminary surveys are being undertaken.

The scheme for advances under the Forestry Act will be published after the consultative committees which have just been set up have considered the proposals.

Forest apprentices are receiving a two-year course in the Forest of Dean, the New Forest, and in Chopwell Woods, near Newcastle, and additional schools will be opened during the year. A special course for men with previous forestry experience is being conducted at Marischal College, Aberdeen.

An Imperial Conference to consider the forest resources and policy of the Empire is being organised for July, when a number of persons interested in forestry are expected in this country for the British Empire Timber Exhibition. The conference is expected to lead to the establishment of an Imperial Bureau of Forestry Information.

The Commission has published Bulletin No. 1, "Collection of Data as to the Rate of Growth of Timber" (which can be obtained post free for 4½d. on application at the headquarters of the Commission, 22 Grosvenor Gardens, London, S.W.1); also Leaflet No. 1, "Pine Weevils" (free). Other publications will follow at an early date.

The four consultative committees under the Forestry Act have been appointed, and consist of the following members:—

*England.*—Lt.-Col. G. L. Courthope (chairman), Col. M. I. Wilson (vice-chairman), Sir J. Ball, Lord Henry C. Bentinck, E. Callaway, the Earl of Chichester, M. C. Duchesne, J. H. Green, W. A. Haviland, Sir Edward Holt, Bart., E. C. Horton, A. F. Luttrell, W. Peacock, Major Harold Pearson, Col. B. J. Petre, Thomas Roberts, Sir William Schlich, W. R. Smith, Charles Stewart, Sir Lawrence Weaver, Col. J. W. Weston, and Leslie S. Wood.

*Wales.*—The Lord Kenyon (chairman), Col. F. D. W. Drummond (vice-chairman), C. B. Bovill, Major David Davies, Alderman T. W. David, Col. J. R. Davidson, Capt. J. D. D. Evans, Col. W. Forrest, Vernon Hartshorn, G. A. Humphreys, C. Bryner Jones, J. Jones, Lt.-Col. W. N. Jones, Col. C. V. Llewellyn, F. J. Matthews, the Earl of Powis, L. R. Pym, D. C. Roberts, J. Roberts, Major-Gen. A. E. Sandbach, J. I. Storrar, the Lord Tredegar, H. C. Vincent, P. Wilkinson, and Col. Sir H. L. Watkin-Williams-Wynn, Bart.

*Scotland.*—Sir Hugh Shaw-Stewart, Bart. (chairman), Gen. Stirling of Keir (vice-chairman), the Right Hon. William Adamson, Sir Isaac Baveley Balfour, F. R. S. Balfour, Wm. Black, Gilbert Brown, J. C. Calder, Sir Isaac Connell, J. A. Duthie, G. Fraser, R. Galloway, S. J. Gammell, Sir Robert Greig, J. H. Milne Home, G. Leven, Sir Robert Lorimer, H. L. Macdonald, Sir Kenneth J. Mackenzie, Bart., J. T. McLaren, J. Matson, D. Munro, Major W. Murray, J. Scott, and J. Wight.

*Ireland.*—T. B. Ponsonby (chairman), H. De F. Montgomery (vice-chairman), E. M. Archdale, J. Bagwell, the Lord Osborne Beauclerk, R. Bell, R. Bradley, S. Brown, J. R. Campbell, St. Clair M. Dobbs, Sir Henry Doran, J. Everett, V. C. Le Fanu, Wm. Field, A. C. Forbes, J. Calvin, the Earl of Granard, Prof. Augustine Henry, Wm. Kirkpatrick, A. E. Moran, the Viscount Powerscourt, the Viscount de Vesci, A. Vincent, Capt. R. H. Prior Wandersforde, and the Right Hon. F. S. Wrench.

## Recent Fishery Investigations.<sup>1</sup>

FIVE years ago the pivot round which fishery investigation turned was the question of the productivity of the North Sea grounds. It was agreed that the enormous development of catching power since the last third of the nineteenth century had produced no apparent change in the abundance of herring, haddock, whiting, and possibly some other species, but that, on the other hand, plaice, sole, turbot, and some other edible fishes had been affected. In January, 1913, the Plaice Committee of the International Fishery Council stated that it then had evidence that large plaice were becoming scarcer in the North Sea, and that small plaice were becoming more abundant, and this was taken to be proof that there was "impoverishment," or excessive exploitation of a natural resource. The conclusion is not free from ambiguity, for, on the whole, the total quantity of fish landed increased up to 1913; what had happened, it appears, was a reduction in the average expectation of life of a plaice living in the North Sea. Now if that change was a result of "intensive" fishing up to 1914, what has been the result of the very great decrease in fishing during the years 1915-18? Drs. A. C. Johansen and Kirstine Smith seek to answer this question by discussing measurements of plaice landed from a Danish North Sea area which was tolerably free from military restrictions during the period of war. They find that the pre-war tendency has been reversed; that large plaice are now relatively much more abundant than they were, but that their rate of growth has decreased—a curious result. We were justified, they say, in concluding that intensive fishing could reduce a natural stock of fish, and we are also justified in expecting that a slackening of this intensity of fishing, even for a relatively short period, will have the opposite effect.

The method by which the latter conclusion is made is indirect, and one is scarcely convinced that it is beyond doubt. It seems easy to show whether or not a natural fishery is stationary or declining. It would be easy and the conclusions certain if the systems of collecting statistics were adequate and well planned and if there were good scientific investigations that enabled one to interpret the statistical data. But the statistics are not adequate, and the scientific investigations have been neither well planned nor properly supported, and therefore the methods are roundabout ones and the conclusions do not carry absolute conviction. We do not know, for instance, that there is not a natural periodicity of abundance and that the results noticed do not simply represent phases in a cyclic change. It is quite likely that they do.

The last report of the Dove Marine Laboratory (at Cullercoats, Northumberland) contains an account (by Mrs. Dorothy Cowan and Mr. B. Storrow) of investigations into the local herring fishery. This and former reports contain a very rich series of data with regard to the biology of the herring on the North East coast, and apparently not all the results obtained have been published—the present report, for instance, deals only with age-determinations (by means of "scale-readings"), while biometric measurements made as part of the Board of Agriculture and Fisheries scheme of racial investigations have also been accumulated. Prof. Meek, in editing the report, points out that extensive accumulations of data have not yet been analysed, and that such treatment is advisable before further investigations are planned. His discussion of some of Mr. Storrow's results gives point to an expression of dis-

<sup>1</sup> "Meddelelser fra Kommissionen for Havunder søgelser; Ser Fiskeri," Bd. v., Nr. 9. (Copenhagen, 1919.)

appointment that the numerous inquiries and conferences held during the past year have not yet had any result. Local investigation with regard to the movements of herring shoals is insufficient. In this case the shoals leave Northumbrian waters and appear later on off the Firth of Forth, where, apparently, they are not sampled or investigated. It is therefore regrettable, Prof. Meek suggests, that reconstruction should have been a departmental rather than a national affair.

J. J.

### Flora of the Hawaiian Islands.

THE natural history of the Hawaiian Islands has been well worked as regards both the flora and the fauna. Generally speaking, there is an extraordinary degree of endemism in the plants and animals, associated with a strong Southern Pacific or Australasian and Indo-Malayan affinity and a weak Northern Pacific or American affinity. The islands are extremely isolated, being further removed from any continental area than is any other region of equal size upon the globe. The nearest continent is North America, two thousand miles away, and the nearest islands of any importance, the Marquesas, are 1860 miles distant. Within forty miles of the shores the ocean exceeds 10,000 ft. in depth, and between the islands and the American coast reaches in places more than 20,000 ft. The most commonly accepted view of the origin of the archipelago is that the islands, which are entirely volcanic, were raised by volcanic activity, and that they have always been completely isolated.

In a paper entitled "The Derivation of the Flora of Hawaii" (Leland Stanford Junior University Publications, University Series, 1919) Prof. D. H. Campbell gives a *résumé* of the composition of the flora and its relations to American and Southern Pacific floras generally, and criticises unfavourably Guppy's view of its origin and distribution. Guppy accepts the view that the archipelago has always been completely isolated, and that air-currents and birds have been the agents concerned in its population. The predominantly Australasian and Indo-Malayan element was, he suggests, introduced largely by birds, especially fruit-eating pigeons, but Prof. Campbell finds a serious objection in the absence of such birds from the present fauna, as, apart from a number of American migratory shore-birds, practically all are endemic. Prof. Campbell strongly supports the view taken by Mr. H. A. Pilsbry, based on the study of the molluscan fauna. The land-snails are all ancient types the modern representatives of which are largely confined to Polynesia, and they represent, it is contended, an ancient fauna which has survived from a time when Hawaii was part of a continental area connected to the south-west with that of Polynesia. A study of the insects leads to a similar general conclusion, namely, that while the ancestors of some of the species may have been introduced through the agency of wind- or ocean-currents or by migratory birds, there are many more species of both plants and animals the presence of which can best be explained by a former more or less direct land-connection between Hawaii and the Indo-Malayan region.

The multitude of islands constituting Polynesia are, on this hypothesis, the remains of a once extensive land-mass, either a single continent or several large continental islands like Australia. This great area has been subsiding since Early Tertiary times, and the existing islands are the tops of mountain masses, often volcanic, superimposed upon this submerged continental area. A serious objection to this theory

is the absence in Hawaii of certain types of vegetation characteristic of Southern Pacific regions, such as the conifers, aroids, and figs, and it is suggested that these forms became extinct after the isolation of the islands. Similar examples of such disappearance of plants are afforded by *Sequoia*, *Liriodendron*, and other genera, which had once a wide distribution, but are now represented in many regions only by Tertiary fossils.

### University and Educational Intelligence.

DR. J. B. CLELAND, of the Health Department of New South Wales, has been appointed to fill the newly constituted chair of pathology in the University of Adelaide, South Australia.

APPLICATIONS for grants from the Dixon Fund, of the University of London, for assisting scientific investigations, are receivable by the Academic Registrar, University of London, South Kensington, S.W.7, until May 14 next. They must be accompanied by the names and addresses of two referees.

THE MARQUESS OF CREWE, chairman of the governing body of the Imperial College of Science and Technology, and Sir Alfred Keogh, Rector of the college, will attend the annual dinner of the Old Students Association of the Royal College of Science, to be held at the Café Monaco on Saturday, April 24. Other distinguished guests will be Prof. W. H. Bragg, Dr. W. Garnett, Sir Richard Glazebrook, Mr. W. McDermott, and Sir Ronald Ross. Tickets (price 10s. 6d.) may be obtained from Mr. C. S. Garland, acting secretary, Old Students Association, Royal College of Science, South Kensington, London, S.W.7.

At a general meeting of old students held recently at King's College, Strand, it was decided to form a King's College, London, Old Students' Association for the purpose of promoting social intercourse and of keeping the members in touch with their old college. The association hopes to include students from all faculties, and the subscription of 10s. 6d. per annum will include the *King's College Review*, published once a term, and a list of members with their addresses (and possibly the work on which they are engaged). Further particulars and forms of application for membership may be obtained from Miss M. A. V. Fairlie, hon. secretary, 3 St. Julian's Farm Road, West Norwood, S.E.27.

### Societies and Academies.

**Faraday Society**, March 1.—Dr. T. Martin Lowry and F. C. Hemmings: The properties of powders. The caking of salts is, in general, dependent on the presence of a solvent, usually water. The following cases have been studied: Nitrates, other anhydrous compounds, hydrated salts, loss of sulphur dioxide during caking, and contraction during caking of copper sulphate.—Dr. T. Martin Lowry and S. Wilding: The setting of dental cements. Phenomena of caking or setting may be divided into five classes:—(1) Recrystallisation of anhydrous or hydrated salt without change of chemical composition. (2) Formation of hydrates. (3) The hydrolysis of complex salts by water. (4) The formation of new salts, such as the magnesium oxy-cements and the zinc oxy-phosphate cements used in dentistry, and "silicate" cements. (5) Amalgams in which mercury takes the place of water.

**Zoological Society**, March 16.—Prof. E. W. MacBride, vice-president, in the chair.—R. I. Pocock:

External characters of the South American monkeys. The paper showed the variations in the range of structure of the ears, nose, hands, feet, and external genitalia.—**Dr. C. F. Sonntag**: The comparative anatomy of the tongues of the mammalia. Having first outlined the plan which would be followed in his series of comparative studies, the author proceeded to describe the different divisions of the tongue and the physical characters of each. He demonstrated by diagrams and lantern-slides the different forms which the papillæ and openings of Wharton's ducts can assume among the mammalia, and exhibited specimens illustrating the shapes and colours of the tongue and the arrangements for cleaning the teeth.

March 30.—**Dr. A. Smith Woodward**, vice-president, in the chair.—**Dr. C. F. Sonntag**: Abnormalities of the abdominal arteries of a young panda.—**A. Loveridge**: East African lizards collected in 1915-19, with description of a new genus and species of skink and a new sub-species of gecko.

**Royal Meteorological Society**, March 17.—**Mr. R. H. Hooker**, president, in the chair.—**Capt. C. K. M. Douglas**: Clouds as seen from an aeroplane. A large number of photographs of clouds taken from an aeroplane were shown, nearly all of which were taken by the lecturer while flying in co-operation with the Meteorological Section, R.E., in France in 1918-19. The primary object of the flights was to obtain the temperature in the upper air for the artillery and for forecasting, and advantage was taken of the opportunity to study cloud-structure and its relation to the upper-air temperature and humidity and to the general meteorological conditions. The observations were made at Berck, on the French coast, twenty miles south of Boulogne, which lies close to the most important aerial routes. The photographs showed a large variety of cloud-forms, and also some changes which took place in short periods. A number of the photographs showed thunderclouds. Thunderstorms are caused by powerful ascending currents, and the tops of the clouds grow up to a great height, frequently exceeding 20,000 ft. Often when the weather is overcast and gloomy there is brilliant sunshine within one or two miles of the ground, and the clouds viewed from above present a splendid spectacle.

## PARIS.

**Academy of Sciences**, March 8.—**M. Henri Deslandres** in the chair.—**G. Humbert**: An extension of the modular group in an imaginary quadratic body.—**F. E. Fournier**: Forms of hull of least resistance to their translation in free air at all velocities.—**C. Guichard**: A characteristic property of congruences belonging to a linear complex.—**P. Vuillemin**: Remarks on a fungus attributed by M. Loubière to the genus *Trichosporium*.—**Sir James Dewar** was elected a correspondent for the section of general physics in succession to the late Prof. Blaserna.—**J. Villey**: The adaptation of internal-combustion motors to high altitudes.—**B. Gambier**: Surfaces of translation applicable to each other.—**M. Fréchet**: A complete family derived from the family of ensembles "bien définis".—**P. Humbert**: Functions of the parabolic hypercylinder.—**M. Renaux**: A problem of iteration.—**J. K. de Fériet**: An application of generalised differentials to the formation and integration of certain linear differential equations.—**L. de Pésloüan**: The extension of the rule of L'Hôpital to certain arithmetical quantities.—**J. Chazy**: The impossible singularities of the problem of  $n$  bodies.—**H. Blondel**: Application of the method of Lagrange to the orbit of the planet discovered by M. Comas Solà, January 13, 1920.—**E. Belot**: A new form of the law of distances of planets and satellites resulting from the spiral formation of

the planetary system, and the cause of rotation of the planets.—**J. Guillaume**: Observations of the sun made at the Observatory of Lyons during the third quarter of 1919. Observations taken on eighty-nine days are summarised in three tables showing the number of spots, their distribution in latitude, and the distribution of the faculae in latitude.—**L. de Broglie**: The calculation of the limiting frequencies of K and L absorption of the heavy elements. A comparison of the numbers deduced from Bohr's theory and from Végard's formula with the average experimental data derived from the experiments of Végard, Siegbahn, and de Broglie. The results for the L bands for tungsten, platinum, gold, lead, bismuth, thorium, and uranium are clearly in favour of Végard's formula.—**M. Rennesson**: The loss of energy in the dielectric of commercial cables. Two sets of experiments are described: in the first the frequency and temperature were maintained constant, and the voltage varied; and in the second the temperature was the variable, voltage and frequency being constant. In the latter case the energy losses in the dielectric showed a minimum at 30° C.; the losses at 30° C. were about half those found at 12° C. or at 55° C.—**A. Caillaux**: The search for invertin in pure honey. The presence of invertin in pure honey was definitely proved, and this explains why two analyses of a sample of honey made at different times may give different results for the sugars present.—**J. Martinet** and **O. Dornier**: The azo-compounds of indoxyl.—**Ch. Boulin** and **L. J. Simon**: The preparation of methyl chloride and bromide starting from dimethyl sulphate. The interaction of concentrated hydrochloric acid and methyl sulphate gives pure methyl chloride; methyl bromide is obtained in a similar manner by substituting a solution of an alkaline bromide acidified with dilute sulphuric acid for the hydrochloric acid.—**M. Zeil**: The ascensional movements of the earth's crust and the anomalies of gravity.—**G. Denizot**: The lower penneplain of the Paris basin.—**R. Abrard**: A layer of eruptive rocks at Souk el Arbâa du R'Arb (Western Morocco).—**V. Bjerknes**: The relation between the movements and temperatures of the upper layers of the atmosphere.—**L. Besson**: The primitive form of atmospheric ice.—**C. E. Brazier**: The variation of the indications of the Robinson and Richard anemometers as a function of the inclination of the wind.—**A. Guillemond**: The figured elements of the cytoplasm.—**J. D. d'Oliveira**: The transmission of fasciation and dichotomy as a result of the grafting of two Portuguese vines.—**J. Magrou**: The immunity of annual plants towards symbiotic fungi.—**J. E. Abelous** and **L. C. Soula**: The cholesterinogenic function of the spleen.—**J. L. Dantan**: Oyster beds: their development, classification, and exploitation.

March 15.—**M. Henri Deslandres** in the chair.—**G. Humbert**: The groups of M. Bianchi.—**Em. Bourquelot** and **M. Bridel**: The detection and characterisation of glucose in plants by a new biochemical method. The production of methyl glucoside by the action of emulsion forms the basis of the new method proposed.—**MM. d'Arsonval, Bordas, and Touplain**: The electrical purification of air.—**G. Gouy**: Gaseous currents in the interior of the sun.—**Ch. Nolle**, **A. Cuénot**, and **G. Blanc**: The experimental reproduction of trachoma (granular conjunctivitis) in the rabbit.—**M. Léon Lindet** was elected a member of the section of rural economy in succession to the late Th. Schlesing, and **Sir Joseph Larmor** a correspondent for the section of geometry in succession to the late M. Liapounoff.—**B. Gambier**: Applicable surfaces.—**Ch. Rabut**: The group of plane transformations in which all right lines remain right.—**A. Châtelet**:

Abelian bodies of the first degree.—H. Villat: The variable movement of an indefinite fluid with streamlines in presence of a solid body.—R. Thiry: A problem of hydrodynamics admitting an infinity of solutions.—E. Belot: Dichotomic classification of all stars with the hypothesis of their formation by cosmic shock.—Ad. Braly: A new, simple, and rapid method for collecting and characterising the sublimes produced by metalloids and metals volatilised by the blowpipe. Two flames are used, alcohol and paraffin, to secure different temperatures of volatilisation, and the sublimes are received on clear mica sheets.—O. Mengel: Two ancient lines of beach at Roussillon: their relations with two Glacial periods.—H. Hubert: Granitic rocks associated with the diabases of the Douaïé massif (Haut-Sénégal and Niger).—J. Rouch: The height of sea-waves. The Richard statoscope was used in these measurements; 1 mm. on the scale of the instrument corresponded to about 0.5 metre variation in height. The greatest wave-heights were observed on January 28, 1910, and gave numerous waves between 4 and 5 metres, forty above 6 metres, twenty above 7 metres, nine above 8 metres, five above 9 metres, and one of 10.5 metres. Waves of a greater height than 10 metres are rare in the Atlantic and the southern seas.—P. Bugnon: The origin of the transverse liberoligneous bundles forming a network at the nodes of the Gramineæ.—F. Morvillez: The liberoligneous apparatus of the leaves of Betulaceæ, Corylaceæ, and Castaneaceæ.—L. Blaringhem: The production by traumatism of a new form of maize, *Zea Mays*. var. *polysperma*.—J. Barlot: The determination of poisonous varieties of Amanita by colour reactions. The colour reactions of numerous fungi with sulphuric acid and potash solution are detailed. Three very poisonous varieties give a positive "haemo-reaction" with a mixture of fresh blood and potassium ferricyanide.—R. Cambier: The purification of sewage by activated sludge.

### Books Received.

A Text-book of Inorganic Chemistry. Vol. ix. Part I. By Dr. I. Newton Friend. Pp. xvii+367. (London: C. Griffin and Co., Ltd.) 18s.

Grundzüge der systematischen Petrographie auf genetischer Grundlage. By Dr. W. Hommel. Erster Band: Das System. Pp. xii+174+5 Tafel. (Berlin: Gebirger Bornträger.) 22 marks.

Mrs. Warren's Daughter. By Sir Harry Johnston. Pp. xi+402. (London: Chatto and Windus.) 7s. 6d. net.

Recent Developments in European Thought. Edited by F. S. Marvin. Pp. 306. (London: Oxford University Press.) 12s. 6d. net.

A Junior Course of Practical Zoology. By the late Prof. A. M. Marshall and Dr. C. H. Hurst. Ninth edition. Revised by Prof. F. W. Gamble. Pp. xxxvi+517. (London: J. Murray.) 12s. net.

Lectures on the Theory of Plane Curves. By S. Ganguli. Part I. Pp. x+138. Part II. Pp. xiii+130+30 diagrams. (Calcutta: University of Calcutta.)

Applied Aerodynamics. By G. P. Thomson. Pp. xx+202. (London: Hodder and Stoughton, Ltd.) 42s. net.

On the Interpretation of Phenomena of Phyllotaxis. (Botanical Memoirs, No. 6.) By A. H. Church. Pp. 58. (London: Oxford University Press.) 3s. 6d. net.

Half-past Twelve: Dinner Hour Studies for the Odd Half-Hours. By G. W. Gough. Pp. vi+77. (London: Sells, Ltd.) 1s.

Utilisation des Algues Marines. By Prof. C.

Sauvageau. Pp. vi+394. (Paris: O. Doin.) 3-50 francs.

Results of Meridian Observations of Stars made at the Royal Observatory, Cape of Good Hope, in the Years 1909-1911. Ppp. xx+206. (London: H.M.S.O.) 20s. net.

Fundamental Catalogue of 1203 Stars for the Equinox 1900 from Observations made at the Royal Observatory, Cape of Good Hope, during the Years 1905-1911. Pp. xlvi+27. (Edinburgh: H.M.S.O.) 5s.

Cape Astrogographic Zones. Vol. iii. Catalogue of Rectangular Co-ordinates and Diameters of Star-Images derived from Photographs taken at the Royal Observatory, Cape of Good Hope. Zone 43°. Pp. xxxvii+443. (Edinburgh: H.M.S.O.) 15s.

Annals of the Cape Observatory. Vol. vii. Part iv. Results of Meridian Observations of the Sun, Mercury, and Venus made at the Royal Observatory, Cape of Good Hope, in the Years 1907 to 1914. Pp. 93. (Edinburgh: H.M.S.O.) 3s.

The Use of Low-Grade and Waste Fuels for Power Generation. By J. B. C. Kershaw. Pp. x+202. (London: Constable and Co., Ltd.) 17s. net.

Colloids in Biology and Medicine. By Prof. H. Bechhold. Translated, with Notes and Emendations, by Prof. J. G. M. Bullowa. Pp. xiv+464. (London: Constable and Co., Ltd.) 31s. 6d. net.

Bygone Beliefs: Being a Series of Excursions in the Byways of Thought. By H. S. Redgrove. Pp. xvi+205+32 plates. (London: W. Rider and Son, Ltd.) 10s. 6d. net.

Macmillan's Graphic Geographies: The British Empire. By B. C. Wallis. Pp. 32. (London: Macmillan and Co., Ltd.) 1s. 6d.

The Nursery-Manual: A Complete Guide to the Multiplication of Plants. By L. H. Bailey. Pp. xi+456+xii plates. (New York: The Macmillan Co.; London: Macmillan and Co., Ltd.) 13s. net.

A Theory of the Mechanism of Survival: The Fourth Dimension and its Applications. By W. W. Smith. Pp. 106. (London: Kegan Paul and Co., Ltd.) 5s. net.

Roses: Their History, Development, and Cultivation. By Rev. I. H. Pemberton. Second edition. Pp. xxiv+334. (London: Longmans and Co.) 15s. net.

A Short Course in College Mathematics. By Prof. R. E. Moritz. Pp. ix+226. (New York: The Macmillan Co.; London: Macmillan and Co., Ltd.) 10s. 6d. net.

### Diary of Societies.

THURSDAY, APRIL 15.

ROYAL INSTITUTION OF GREAT BRITAIN, at 3.—S. Skinner: Ebullition and Evaporation.

ROYAL SOCIETY OF ARTS (Indian Section), at 4.30.—Sir George C. Buchanan: The Parts of India: Their Administration and Development. LINNEAN SOCIETY, at 5.—Capt. F. Kingdon Ward: Natural History Exploration on the North-east Frontier of Burma.—R. Paulson: Exhibition of Lantern-slides illustrating Definite Stages in the Sporulation and Gonidia within the Thallus of the Lichen *Evernia prunastri*, Ach.

ROYAL SOCIETY OF MEDICINE (Dermatology Section), at 5.

INSTITUTION OF MINING AND METALLURGY (Annual General Meeting) (at Geological Society), at 5.30.—F. Merricks: The Mineral Production of the Empire (Presidential Address).

CHILD-STUDY SOCIETY (at Royal Sanitary Institute), at 6.—Prof. W. Ripman: Spelling Reform.

INSTITUTION OF ELECTRICAL ENGINEERS (at Institution of Civil Engineers), at 6.—Dr. C. V. Drysdale: Modern Marine Problems (Kelvin Lecture).

OPTICAL SOCIETY (at Imperial College of Science and Technology), at 7.30.—J. Weir French: The Unaided Eye, Part III.—R. R. Walls: The Rock Crystal of Brazil.

CHEMICAL SOCIETY, at 8.—I. MASON and R. McCall: The Viscosity of Nitrocellulose in Mixtures of Acetone and Water.—S. S. Bhatnagar: Studies in Emulsion. Part I. A New Method for Determining Inversion.

—W. H. Gibson and R. McCall: (1) The Influence of Nitroxyglycerine on the Viscosity of Solutions of Nitrocellulose in Ether-alcohol. (2) The Viscosity of Solutions of Nitrocellulose in Ether-alcohol.—W. K. Slater: Experiments on the Preparation of Isotrioxo-derivatives.—C. S. Salmon: Direct Experimental Determination of the Concentration of Potassium and Sodium Ions in Soap Solutions and Gels.—W. C. McC. Lewis: Studies

in Catalysis. Part XIII. Contact Potentials and Dielectric Capacities of Metals, in relation to the Occlusion of Hydrogen, and Hydrogenation.—**V. G. Garnett:** Coloring Matters of Red and Blue Fluorapat.—**Miss P. V. McKie:** Determination of Nitroform by Potassium Permanganate.—**J. L. Simonsen:** (1) The Constituents of Indian Turpentine from *Pinus longifolia*. Part I. (2) Note on the Constituents of *Morinda citrifolia*. (3) Syntheses with the aid of Monochloromethyl Ether. Part IV. The Condensation of Ethyl Benzyl Sodiomalonnate and Monochloromethyl Ether.

## FRIDAY, APRIL 16.

ROYAL SOCIETY OF MEDICINE (Clinical Section), at 5.30.  
CONCRETE INSTITUTE, at 6.—**E. Fiander Etchells:** Submission of Plans to Local Authorities.

INSTITUTION OF ELECTRICAL ENGINEERS (Students' Meeting) (at Faraday House), at 7.—**J. Scott-Isgard:** The Vacuum Tube as a Transmitter and Receiver of Continuous Waves.

INSTITUTION OF MECHANICAL ENGINEERS (Informal Meeting), at 7.—**J. E. Baty and Others:** Discussion on Planing 7. Milling.

TECHNICAL INSPECTION ASSOCIATION (at Royal Society of Arts), at 7.30.—**F. R. Wade:** Labour Unrest—Its Causes and its Cure.

ROYAL SOCIETY OF MEDICINE (Electro-Therapeutics Section), at 8.30.—**Sir Ernest Rutherford:** Development of Radiology (Mackenzie Davidson Memorial Lecture).

ROYAL INSTITUTION OF GREAT BRITAIN, at 9.—**Prof. H. Maxwell Lefroy:** The Menace of Man's Dispersal of Insect Pests.

## SATURDAY, APRIL 17.

ROYAL INSTITUTION OF GREAT BRITAIN, at 3.—**Prof. W. H. Eccles:** The Thermionic Vacuum Tube as Detector, Amplifier, and Generator of Electrical Oscillations.

## MONDAY, APRIL 19.

INSTITUTION OF ELECTRICAL ENGINEERS (Informal Meeting) (at Chartered Institute of Patent Agents), at 7.—**G. H. Ayres:** Group versus Individual Driving.

ROYAL SOCIETY OF ARTS, at 8.—**Dr. W. Rosenhain:** Aluminium and its Alloys (Cantor Lecture).  
SURVEYORS' INSTITUTION, at 8.—**C. B. Fisher:** Some Problems connected with Agricultural Policy.

ROYAL GEOGRAPHICAL SOCIETY (at Aeolian Hall), at 8.30.—**Flight-Commander G. M. Dwyer:** An Air-Route Reconnaissance from the Pacific to the Amazon.

## TUESDAY, APRIL 20.

ROYAL INSTITUTION OF GREAT BRITAIN, at 20.—**Major G. W. C. Kaye:** Recent Advances in X-ray Work.

ROYAL STATISTICAL SOCIETY, at 5.15.—**Dr. T. H. C. Stevenson:** The Fertility of various Social Classes in England and Wales from the Middle of the Nineteenth Century to 1911.

INSTITUTION OF CIVIL ENGINEERS, at 5.30.—**Sir Dugald Clark:** Fuel Conservation in the United Kingdom (James Forster Lecture).

INSTITUTION OF PETROLEUM TECHNOLOGISTS (at Royal Society of Arts), at 5.30.—**G. F. Robertsshaw:** Methods of Examination of Lubricating Oils.

ROYAL PHOTOGRAPHIC SOCIETY OF GREAT BRITAIN (Technical Meeting), at 7.—**Dr. C. E. K. Mees and A. H. Niezi:** The Theory of Development.  
ILLUMINATING ENGINEERING SOCIETY (at Royal Society of Arts), at 8.—**J. Darch and Others:** Discussion on the Lighting of Churches.

ROYAL ANTHROPOLOGICAL INSTITUTE, at 8.15.—**R. G. Brown:** The Races of the Hindwin, Upper Burma.  
ROYAL SOCIETY OF MEDICINE (Pathology Section), at 8.30.—Annual General Meeting.

## WEDNESDAY, APRIL 21.

ROYAL UNITED SERVICE INSTITUTION, at 3.—**Rev. Father B. Vaughan:** Modern Patriotism.

ROYAL SOCIETY OF ARTS, at 4.30.—**Air-Commodore E. Maitland:** The Commercial Future of Airships.

ROYAL SOCIETY OF MEDICINE (History of Medicine Section), at 5.—**Dr. A. A. Chaplin:** The History of Medical Education at the Universities of Oxford and Cambridge.—**Mme. Panayotout:** Baths and Bathing in Ancient Greece.

ROYAL METEOROLOGICAL SOCIETY, at 5.—**Royal Observatory, Greenwich:** Polar Night-Sky Recorder.—**Lieut. N. L. Silvester:** Local Weather Conditions at Mullion, Cornwall.—**J. E. Clark:** The Surrey Half-storm of July 16, 1918.

GEOLOGICAL SOCIETY OF LONDON, at 5.30.—**J. W. D. Robinson:** The Devonian of Ferques (Bas-Boulonnais).—**E. S. Cobbold:** The Cambrian Horizons of Comley (Shropshire) and their Brahiopoda, Pteropoda, and Gastrozoa, etc.

ROYAL MICROSCOPICAL SOCIETY, in conjunction with the Optical Society and the FARADAY SOCIETY (at the Royal Microscopical Society), 7 to 10.—General Discussion on The Mechanical Design and Optics of the Microscope.—**Prof. J. Eyre:** Opening Remarks.—**J. E. Barnard:** (1) General Survey.—**A. The Mechanical Design of the Microscope.**

(2) General.—**Prof. F. J. Cheshire:** The Mechanical Design of Microscopes.—**C. Beck:** The Standard Microscope.—**F. W. Watson Baker:** Progress in Microscopy from a Manufacturer's Point of View.—**P. Swift:** A New Microscope.—(3) Metallurgical. **Dr. W. Rosenhain:** The Metallurgical Microscope.—**Prof. C. H. Desch:** The Construction and Design of Metallurgical Microscopes.—**E. F. Law:** The Microscope in Metallurgical Research.—**H. M. Sayers:** Illumination in Micro-metallography.

(c) Petrological. **Dr. J. W. Evans:** The Requirements of a Petrological Microscope.—**B. The Optics of the Microscope.** **Prof. A. E. Conrady:** Microscopical Optics.—**Dr. H. Hartridge:** An Accurate Method of Objective Testing.—**H. S. Rylance:** The Manufacture and Testing of Microscope Objectives.—**F. Twyman:** Interferometric Methods.

## THURSDAY, APRIL 22.

ROYAL INSTITUTION OF GREAT BRITAIN, at 3.—**S. Skinner:** The Tensile Strengths of Liquids.  
ROYAL SOCIETY, at 4.30.—*Probable Papers.*—**Prof. W. E. Dalby:** Researches on the Elastic Properties and the Plastic Extension of Metals.—

**H. W. Hilliar:** Experiments on the Pressure Wave thrown out by Submarine Explosions.—**E. F. Armstrong and T. P. Hilditch:** A Study of the Catalytic Action at Solid Surfaces. III. The Hydrogenation of Acetaldehyde and the Dehydrogenation of Ethyl Alcohol in the Presence of Finely Divided Metals. IV. The Interaction of Carbon Monoxide and Steam as Conditioned by Iron Oxide and by Copper.—**Dr. T. R. Merton:** The Structure of the Balmer Series of Hydrogen Lines.—**Prof. H. A. Wilson:** Diamagnetism due to Free Electrons.

## FRIDAY, APRIL 23.

PHYSICAL SOCIETY, at 5.—**M. C. E. Guillaume:** The Anomaly of the Nickel-Iron Alloys: Its Causes and its Applications (Guthrie Lecture).  
INSTITUTION OF MECHANICAL ENGINEERS, at 6.—**The late W. J. Lineham:** (1) The Hardening of Screw-Gauges with the least Distortion in Pitch (referring to Water Hardening). (2) The Hardening of Screw-Gauges with the least Distortion in Pitch (referring to Oil Hardening).

ROYAL INSTITUTION OF GREAT BRITAIN, at 9.—**Sir Israel Gollancz:** Shakespeare's Shylock and Scott's Isaac of York.

## SATURDAY, APRIL 24.

ROYAL INSTITUTION OF GREAT BRITAIN, at 3.—**Prof. W. H. Eccles:** The Thermionic Vacuum Tube as Detector, Amplifier, and Generator of Electrical Oscillations.

## CONTENTS.

	PAGE
The Encouragement of Discovery	189
English Cytology. By J. B. G.	190
Matrices. By G. B. M.	191
The Chemistry of Animal Products. By W. M. B.	192
Physics: Theoretical and Practical. By H. S. A.	193
Minerals and Metals	193
Our Bookshelf	195
Letters to the Editor:—	
The Plumage Bill and Bird Protection.— <b>Dr. Walter E. Collinge</b>	196
The Physiology of Migrations in the Sea.— <b>Prof. Alexander Meek</b>	197
Muscular Efficiency. (With Diagrams).— <b>A. Mallock, F.R.S.</b>	197
A Dynamical Specification of the Motion of Mercury.— <b>George W. Walker, F.R.S.</b>	198
The Construction of a Magnetic Shell Equivalent to a Given Electric Current.— <b>Dr. A. A. Robb</b>	199
Volcanic Rocks in the Anglo-Egyptian Sudan.— <b>Dr. G. W. Grabham</b>	199
The FitzGerald-Lorentz Contraction Theory.— <b>Horace H. Poole</b>	200
Moseley Memorial.— <b>Sir Henry A. Miers, F.R.S., C. G. Darwin, and Dr. H. Robinson</b>	200
The Aurora of March 22-23.— <b>W. B. Housman</b>	200
The Nitrogen Problem: By-products	201
A Survey of National Physique. (With Diagram.)	202
The Doctor of Philosophy in England	204
British Crop Production. (Continued.) By <b>Dr. Edward J. Russell, F.R.S.</b>	206
Obituary	208
Notes	209
Our Astronomical Column:—	
Conjunction of Jupiter and Neptune	213
A Nova in a Spiral Nebula	213
The Madrid Observatory	213
National Education	213
Aeronautics at the Imperial College	214
The Parallaxes of Globular Clusters and Spiral Nebulae	215
The Forestry Commission	215
Recent Fishery Investigations. By <b>J. J.</b>	216
Flora of the Hawaiian Islands	217
University and Educational Intelligence	217
Societies and Academies	217
Books Received	219
Diary of Societies	219

(INDEX)

Editorial and Publishing Offices:

MACMILLAN AND CO., LTD.,

ST. MARTIN'S STREET, LONDON, W.C.2.

Advertisements and business letters to be addressed to the Publishers.

Editorial Communications to the Editor.

Telegraphic Address: PHUSIS, LONDON.

Telephone Number: GERRARD 8830.



THURSDAY, APRIL 22, 1920.

### The Promotion of Medical Research.

IT is evident from the correspondence evoked by the leading article in NATURE of February 19 that many scientific workers are keenly interested in the subject of the organisation of scientific research and watch with some apprehension the efforts made to bring original investigators within an official system. Francis Bacon supposed that all scientific investigation must proceed from the general to the particular according to a prescribed set of rules, and gave in his "New Atlantis" "a modell or description of a college, instituted for the interpreting of Nature, and the producing of great and marvellous works for the benefit of man." As every student of the history of science knows, Bacon's method, and all other assumedly infallible systems for creating knowledge, fail to furnish a formula for scientific discovery. New truths present themselves in unexpected places, and the seeker after them has to follow whatever paths seem to be the most promising. Knowing that this is so, and cherishing the freedom of action of true explorers, men of science view with suspicion any schemes for systematising research which may deprive them of their birthright. They do not, however, form a single corporate body concerned solely with the promotion of discovery by the encouragement of genius; wherefore they are rarely considered when research systems are planned by the Bacons of our day.

It was pointed out by Prof. Soddy in NATURE of February 26 that the position is different in medical science, because in this case the profession is able to exact due and proper respect for its members, and to insist, therefore, upon administrative and other conditions which they consider best suited to their needs or to solve the problems with which they are concerned. The recent incorporation of the Medical Research Committee as the Medical Research Council is a very notable event in this connection. After its seven years' work under the National Health Insurance Department, the Committee has been transferred to its new position as the Medical Research Council, under the direction of a small Committee of the Privy Council consisting of the Lord President, the Minister of Health (England and Wales), the Secretary for Scotland, and the Chief Secretary for Ireland for the time being. The Council has been incorporated with a perpetual succession by Royal charter, with powers to hold

and use not only moneys and land derived from Parliament, but also property or trusts vested in it by private persons or bodies. It is not merely an Advisory Council, but is in charge of its own executive. These main features sufficiently mark the interest and importance of the new step now taken towards solving that difficult problem in the art of government—the preservation of the freedom and self-government of scientific research work as to both initiative and execution, with due regard to a just responsibility to Parliament in respect of State endowment.

The appointment of the Development Commission in 1911 marked the first modern step towards a solution of this problem of the State endowment of research. For the first time an organisation independent of the administrative Departments was set up to initiate and direct scientific research work in particular directions. The constitutional position of the Commission was anomalous, its functions were too various in kind, and the *personnel* selected for it suffered in quality, perhaps, because it depended too much upon the representative principle. But the work of the Commission, especially in relation to agricultural research was in charge from the first of scientific men, and in effect, if not in form, the Commission had executive as well as advisory powers.

The next landmark in this development was the formation of the Medical Research Committee in 1913 in connection with the National Health Insurance Department. This was attached directly to an administrative Department, but it was given a singularly free constitution. The Committee was composed of scientific men appointed for their quality as counsellors without subservience to any representative principle; it was empowered to appoint and dismiss its own servants, and it had full executive authority within the widest limits of research schemes of its own initiation when these had received general Ministerial approval.

The outbreak of war brought home to the Government the grave rational need for a wider and more liberal State endowment of research. In 1915 a scheme for public expenditure upon scientific and industrial research was developed under the Board of Education, where Dr. Addison was then Parliamentary Secretary. It was natural that this should be modelled in its early stages upon the system of the Medical Research Committee, of the working of which there had already been two years of useful experience; but the new organisation soon departed from that model in some essential points. It was early and

rightly transferred to the Privy Council, where it had independence from any one administrative Department, and could serve all Departments alike. But the council of scientific men became a purely advisory body, as it now is, and the Committee of Privy Council under which the work was to be done was not purely Ministerial and formal, but received the addition of other personally appointed lay members in a position constitutionally superior to that of the scientific members of the Advisory Council. A strong staff of lay officers was progressively appointed upon the executive side as a Department under the Privy Council Committee, not under the direct control of the scientific members of the Advisory Council, and neither appointed nor removable by them.

When the Ministry of Health for England and Wales was constituted in 1919, with corresponding Boards of Health in Scotland and Ireland, the disbanding of the four National Health Insurance Commissions made a new constitution necessary for the Medical Research Committee, the work of which in science has no national boundaries. It could not properly be attached to the Ministry of Health, because, altogether apart from the general arguments against placing a system of free research work under a strong administrative Department, a Committee serving the whole of the United Kingdom could not fittingly be attached to a Ministry responsible only for England and Wales. The obviously right course was to bring the medical research service under the Privy Council, the range of which not only covers the United Kingdom, but also allows easy constitutional relationship with systems of research work throughout the Empire. The problem was to bring the Medical Research Committee into close relationship with the scientific and industrial research system already under Privy Council direction, and equally with other systems that may hereafter be placed there, so as to allow the greatest possibility of co-operation along the innumerable boundary lines of scientific work; at the same time it was necessary to do this without sacrificing any of the freedom which the Committee had already enjoyed in its first constitution, or had worked out in experience and established in its traditions.

The solution of this was given when the new Committee of Privy Council for the work of the Committee—now the Medical Research Council—was established by Order in Council on March 11

last. This Committee provides the formal Ministerial responsibility for moneys provided by Parliament, and at the same time it represents and brings together the interests of all the four parts of the Kingdom. In the absence of the Lord President, the Minister of Health will act as Vice-President of the Committee. The Secretary appointed by the Medical Research Council for its own scientific and administrative purposes is to be *ipso facto* Secretary of this Privy Council Committee, so that the chief executive officer of the Research Council will have direct access to the Minister in charge, without the intervention of lay officials either now or in the future.

The Medical Research Council itself has been incorporated by Royal charter in perpetual succession with legal powers to hold money or other personal property, whether voted by Parliament or derived from other sources, and to accept trusts for the furtherance of medical research. It has licence to purchase and hold land or to receive it by gift or bequest up to an annual value of 50,000*l.*, determined at the time of acquisition.

The personal constitution of the Medical Research Committee upon becoming the new Council is little changed. At least two of its members must always be Members of Parliament, one each in the House of Lords and the House of Commons. Lord Astor and Dr. Addison, holding office in the Ministry of Health, retired from the Committee before the change was effected, and one additional scientific member was appointed, to bring the total number from nine to ten. The constitution of the final Medical Research Committee and of the new Medical Research Council is as follows:—The Viscount Goschen; Mr. William Graham, M.P.; the Hon. Edward Wood, M.P.; C. J. Bond, C.M.G., F.R.C.S.; Prof. W. Bulloch, F.R.S.; Dr. T. R. Elliott, F.R.S.; Dr. Henry Head, F.R.S.; Prof. F. Gowland Hopkins, F.R.S.; Major-Gen. Sir William Leishman, K.C.M.G., F.R.S.; and Prof. D. Noël Paton, F.R.S.

It is laid down that three of these members shall retire on September 30, 1921, and thereafter three at intervals of two years. Vacancies so caused or arising casually are to be filled by appointment by the Committee of Privy Council, but only after consultation with the President for the time being of the Royal Society and with the Medical Research Council. This provision will bring into effective bearing upon the constitution of the

Council the best scientific opinion of the time through the channel of the Royal Society, which is likely to be all the more effective because it is not a formal nomination to be made by a busy Royal Society Council among other business, and it gives direct access by the President to the responsible Ministers. A further important provision is that the charter itself may receive amendment or addition, if majority votes of the Council under stated conditions be obtained and the change be allowed by the Committee of Privy Council.

We have continually urged in these columns that scientific men themselves should decide upon the allocation of funds for research, as is done by the Royal Society, the British Association, and other bodies; and that they should be responsible for any schemes of organised investigation. Friction and misunderstanding always arise when these functions are performed by official administrators unfamiliar with such a sensitive plant as scientific genius and unable to judge the promise of incipient inquiry. The remedy for such difficulties is always to ensure that the men who do the work are the masters of the administrative machine and have confidence in the direction of it by specially qualified colleagues—to promote, in fact, the same spirit of common interest between director and worker that is desired between capital and labour. The Medical Research Council seems to fulfil these conditions in every respect, and its incorporation marks a noteworthy stage in scientific development. The Council can determine its own policy, has complete control of its funds, is in direct touch with progressive science by association with the Royal Society, and, above all, its Secretary, Sir Walter Fletcher, has the full confidence of medical research workers. He knows well enough the truth of the adage *Poeta nascitur, non fit* as applied to scientific genius, and may therefore be trusted to secure the most favourable conditions for the development of this rare fruit when it appears.

During its existence the Medical Research Committee brought together a brotherhood of research workers whose scientific investigations have been of the highest national value, and it did this without limiting the freedom of action which is their heritage. We confidently look to the new Council to encourage the independent investigator as well as to create a reserve of research workers, and thus consolidate the organisation of scientific effort in the service of medicine so well begun by the Committee which it supersedes.

### A Study in Palæogeography.

*The Environment of Vertebrate Life in the Late Paleozoic in North America: A Paleogeographic Study.* By Prof. E. C. Case. (Publication No. 283.) Pp. vi+273. (Washington: Carnegie Institution of Washington, 1919.) Price 3 dollars.

THE following passage from Suess's "Face of the Earth" might be taken as an appropriate text for the work under consideration:—"It is the organic remains, no doubt, which afford us our first and most important aid in the elucidation of the past. But the goal of investigation must still remain the recognition of those great physical changes in comparison with which the changes in the organic world only appear as phenomena of the second order, as simple consequences." Prof. Case's volume may be described as an attempt both to provide an up-to-date corpus of material, often presented in the form of lengthy quotations from the writings of American geologists, bearing upon the history of the later Palæozoic period, and to utilise the data as evidence in an inquiry into the physical and climatic conditions under which organisms lived, migrated, or became extinct in different regions of the North American continent.

The author has essayed a difficult but attractive task, and though his own conclusions and generalisations are to some extent overwhelmed by the superabundance of citations from published sources, he has succeeded in making a valuable contribution to a neglected branch of geological history. He takes a broad view of the conception of environment; it represents "the sum of all the contacts which any organism or group of organisms establishes with the forces and matter of its surroundings, either organic or inorganic." The difficulty is that we have comparatively little knowledge of the nature of the interaction of existing organisms and their environment; but it is none the less praiseworthy to extend ecological inquiry to a remote era in the hope that in this line of research, as in others, a knowledge of the past may help us to solve the problems of the present.

In the first chapter Prof. Case discusses the different categories of facts which it is essential to consider in connection with palæogeographical questions, the nature of the sedimentary deposits, the source of the sediments, the history of the flora and fauna—whether they were evolved where they were preserved, or had migrated from another locality—the influence of environment reflected in the morphological characters of animals and plants, and other factors. He empha-

sises the importance of close co-operation between palaeontologists and geologists in all matters relating to past geographies, and deprecates the over-readiness of the former class of workers to assume the existence of land-barriers. In illustration he refers to the continent of Gondwanaland, the existence of which "depends more definitely upon biological evidence and awaits full confirmation." Gondwanaland is, however, by no means the creation of palaeontologists alone; its foundations are also geological. Succeeding chapters are devoted to the description of different provinces of North America in the latter part of the Palaeozoic era, and the author summarises the results of an intensive study of Upper Pennsylvanian and Permo-Carboniferous rocks in certain areas. "It is difficult for a reader not conversant with American stratigraphy to interpret the formations mentioned in terms of European classification, and one feels the lack of more helpful correlation-tables than those provided.

One of the most valuable features of the book is the emphasis laid on the necessity for regarding fossils as once living things, and for considering their distribution in the strata in relation to the problems presented to them by their environment. The chapter on the climatology of the later Palaeozoic is a particularly useful mine of information. In the concluding chapter the author discusses the development and fate of vertebrate life in the Permo-Carboniferous period in relation to physical conditions. During Early Pennsylvanian time the conditions were singularly uniform over large areas, and the climate was equable and humid; a monotonous environment implies a limit to the number of genera and species in a flora or fauna; older and simpler types would persist because the variants, which were possibly being constantly produced, would not have a chance to develop. This idea is elaborated, though not so clearly as one could wish. It is suggested that the Upper Pennsylvanian fauna, though hampered in its further progress by the monotony of the environment, was accumulating force preparatory to a great radiation which would find expression when the limitations were removed. Prof. Case adds: "The fauna, long restrained from any expression of its evolutionary tendencies, full fed, and in the vigour of its youth, responded at once to the change, and new forms appeared so suddenly as to be unheralded in the preserved remains." This and similar passages illustrate the more imaginative side of the author's work.

The palaeobotanical data are largely taken from the contributions of Mr. David White, whose researches are well known. The American Coal

Measures have unfortunately yielded scarcely any petrified material comparable with that from England and a few other European countries, and although there is a wealth of plant impressions, anatomical criteria of climatic conditions are not available.

A. C. SEWARD.

### Wheat and Wheat-growing.

*Essays on Wheat.* By Prof. A. H. R. Buller.

Pp. xv + 339. (New York: The Macmillan Co.; London: Macmillan and Co., Ltd., 1919.) Price 2.50 dollars.

PROF. BULLER'S "Essays on Wheat" are among the most interesting things we have seen for a long time. As professor of botany in the University of Manitoba, he has unrivalled opportunities of studying the ramifications of the wheat industry, for in no city in the world is wheat so important as in Winnipeg. He is singularly fortunate in his subject, and he tells his story remarkably well, giving the wealth of detail, the figures, and the references needed by the man of science, without sacrificing interest or literary form.

The first essay deals with the early history of wheat growing in Manitoba. It is a story in which Parkman would have revelled. The first attempt was made in 1812 by a little band of pioneers sent out from Scotland by Lord Selkirk to colonise the 116,000 sq. miles of territory granted to him by the Hudson Bay Co.; they settled at the junction of the Red and Assiniboine rivers where Winnipeg now stands. The first crop failed, as also did the second. The failure is scarcely surprising. "There was not a plow in the whole colony, the one harrow was incomplete and could not be used, and all the labour of breaking up and working over the tough sod had to be done with the hoe." The Indians were amazed, and nicknamed the colonists "jardiniers." Fortunately for the settlers, potatoes and turnips did well, or they must have had two very bitter winters. The third crop succeeded. But the troubles were by no means at an end. Birds were a great nuisance, especially the now extinct passenger pigeon. In the fourth year the adherents of the North-West Company and their half-breeds made serious trouble and caused no little bloodshed, and, to crown all, in the sixth year, just as the settlers were about to reap their second good harvest, there came a great plague of locusts which stripped the fields and gardens bare. It was more than even these brave men could stand; the old record says: "The unfortunate emigrants, looking up to heaven, wept." It speaks volumes for their good Scottish upbringing if they did no

more. Troubles continued; mice and floods did great damage, and not until 1830 did prosperity come; from that time on, however, the tale is one of steady and increasing progress.

Space does not allow of quotations from Prof. Buller's description of modern wheat growing in western Canada, but this is less necessary since it is more generally known than the earlier history. While it has less human interest, the tale is still a fascinating record of what can be achieved by intelligent organisation.

Another essay is devoted to the Red Fife and Marquis wheats. Red Fife was introduced into Canada some sixty years ago, and by reason of its sterling merit and great suitability to Canadian conditions it spread far and wide, doing much to make Canada's reputation as a wheat-producing country. The farmer is rarely a writer, and David Fife, who raised the first crop about the year 1842, has himself left no record of how he did it. But, though written contemporary records are lacking, oral traditions are abundant; some of them are reproduced by Prof. Buller, and they can almost be graded in point of time by their respective wealth of picturesque detail. The earliest written record is in the *Canadian Agriculturist* for March, 1861. It is there related that David Fife, of Otonabee, Ontario, in 1842 procured from a friend in Glasgow a quantity of wheat drawn from a cargo coming direct from Danzig. The wheat arrived in spring and some of it was sown forthwith; it failed to ripen, excepting only three heads, which apparently sprang from a single grain. These were preserved and the grain sown the next year; the progeny did very well, escaping rust, while all round the local wheat was badly infested. Again the grain was harvested separately, and gradually a large stock was worked up and distributed among other farmers.

The Continental origin of Red Fife was definitely established by Dr. Charles Saunders in 1904, when he proved its complete identity with a Galician spring wheat.

Dr. William Saunders, the revered first organiser of the experimental stations in Canada, whose courtly bearing and distinguished kindness will always be remembered by those who knew him, began soon after 1886 to make crosses between Red Fife and other varieties with a view to improvement. One of the crosses actually made by his son Arthur in 1892 was between Red Fife as male and an early ripening Indian wheat, 'Hard Red Calcutta,' as female. Unfortunately, the Indian wheat is a mixture, and the precise variety used cannot now be determined. When Dr. Saunders's second son Charles became Dominion

Cerealist, he made a careful examination of the progeny of this cross, and selected from the mass of material one strain of outstanding excellence, which he called "Marquis," and which, from a single head in 1903, has spread over Canada and the United States, until in 1918 it was sown on 20,000,000 acres of land and yielded some 300,000,000 bushels of grain. So wonderful a rate of growth can scarcely have occurred before in the whole history of the world.

It is not often that a reviewer wishes a book had been longer, but that is decidedly one's feeling in closing this volume. One can only hope that Prof. Buller will find time to give us more of these delightful essays.

E. J. RUSSELL

### The Fertilisation of the Ovum.

*Problems of Fertilization.* By Prof. Frank Rattray Lillie. (The University of Chicago Science Series.) Pp. xii+278. (Chicago, Ill.: The University of Chicago Press; London: The Cambridge University Press, 1919.) Price 1.75 dollars net.

THE problem of fertilisation, of what really happens when the spermatozoon meets the ovum, and of how the latter is incited to begin the long series of rhythmical cleavages that finally result in a new organism, is one of the most interesting and at the same time one of the most complex in biological science. From the time of Aristotle, who held that "the female always supplies the matter, the male the power of creation," the problem has engaged the attention of biological philosophers, and no doubt it will continue to do so for generations to come, for the more it is investigated the more intricate it becomes, and each new theory, evolved under the influence of new experimental methods, is discarded in turn as our knowledge of facts increases. Not the least interesting part of Prof. Lillie's book is the historical survey with which it opens. The discovery of the spermatozoon by Leeuwenhoek and Hamm in 1677 was epoch-making for biological science, and, of course, was rendered possible only by the advent of the compound microscope. Like all other great discoveries, it was immediately followed by sensational nonsense, and we find "a certain Dr. Dalen Patius" claiming that the human body is actually visible in perfect miniature within the spermatozoon! This grotesque view, however, was but an extreme form of that held by the spermatist school in general, which maintained that the ovum plays no other part in the production of the young animal than that of furnishing the germ contained in the spermatozoon with nourishment.

The elaboration of microscopical technique in the nineteenth century, leading to the discovery of the cell, with its nucleus and chromosomes, afforded conclusive evidence that ovum and spermatozoon contribute more or less equally to the organisation of the new individual, and placed upon a secure foundation the fundamental generalisation that both are cell-units. Exactly how they co-operate in initiating development is the problem discussed by Prof. Lillie, in the light both of his own observations and of those of a small army of fellow-workers in the same field, pre-eminent amongst whom stand out the names of Hertwig, Fol, Boveri, Delage, Loeb, and E. B. Wilson.

There is one fact of fundamental importance about which all observers seem now to be agreed, and that is the twofold character of the process of normal fertilisation; not only does it stimulate the egg to develop, it also results in the combination of maternal and paternal chromosomes in the zygote nucleus. This combination is of the most far-reaching significance for the theory of heredity, but it appears to have little or nothing to do with the "activation" of the ovum which leads to development, and is only incidentally referred to in the volume before us.

As to how the activation is effected, there seem to be almost as many views as there are observers. It is well known, however, that activation can take place without the aid of a spermatozoon, and that artificial parthenogenesis may be brought about by a great variety of methods, involving the application of chemical or physical stimuli. The problem is one of physiological chemistry, and apparently many factors may be concerned in the process. The secretion of a substance by the egg, which causes the spermatozoa to agglutinate and adhere to the surface, appears to be one of the most important. The formation of the so-called "fertilisation-membrane" as a result of the impact of the spermatozoon and the consequent cortical changes that take place in the ovum are fully discussed, and the hypothesis is put forward that a substance ("fertilizin") exists in the cortex which exerts a ferment-like action as it penetrates into the egg, or is carried in by the spermatozoon, and it is suggested that the spermatozoon itself requires to be "fertilised" by passing through the cortex, before it can play its proper part in the events which take place internally and lead to development.

The book contains a vast amount of information as to recent discoveries and theories, and will serve as a very useful guide to those who wish to follow up this most intricate subject. A. D.

### Wisdom of Life and Existence.

*A Gentle Cynic: Being a Translation of the Book of Koheleth, commonly known as Ecclesiastes, stripped of Later Additions; also its Origin, Growth, and Interpretation.* By Prof. Morris Jastrow, jun. Pp. 255. (Philadelphia and London: J. B. Lippincott Co., 1919.) Price 9s. net.

PROF. MORRIS JASTROW, jun., of the University of Pennsylvania, is well known among scholars as one of the best equipped analysts and interpreters of Biblical lore. In this volume he has taken the Book of Koheleth in its origin, growth, and interpretation, and thrown a good deal of fresh light on the subject.

In a foreword of twenty pages is given a very able sketch of the main principles of Biblical criticism and of the enormous gain which accrues from a knowledge and acceptance of them. By such means only are we able to pass from the realm of confusion to that of clearness. In our generation alone has the religious portion of mankind come to realise this necessity, and even to-day the realisation is but a portion of a small minority. Yet only by the adoption of scientific methods can the past be illumined in the realm of religion, as it has been illumined in every other field.

The author passes on to examine the origin and structure of the Book of Koheleth. Here he arrives at the conclusion that the book, as we possess it to-day, is an expanded and edited rendering of an earlier version, which, when it is viewed without the accretions, presents a gentle criticism of human life and existence. The version knows nothing of what lies behind or before us. It really deals with man's passage through life, and emphasises the present infinitely more than either the past or the future. Man is asked to make the most of the good things that Nature brings to him; he is warned not to worry about speculative things, such as his own final goal or the destiny of the universe. In spite of much that is hidden, life has a meaning here and now; it has enjoyments which make it worth while to live.

Now, it is evident that such an empirical, Epicurean view of life would never do as a religious interpretation of the universe or of life itself. As it stood originally, the Book of Koheleth had no chance of entering into the sacred books. It is therefore edited, added to, and polished so as to furnish here and there pious injunctions of rewards and punishments in order that the life

of the present may be lived in accordance with "ideal ends." God and the future are brought in as the norms to which life has to conform.

This portion of the book is a brilliant piece of work, and the author has brought to bear upon it not only great learning, but also a lightness of touch which really borders on something like originality. In the hands of men such as Prof. Jastrow, the Bible can again become a work of immense significance.

The next part of the book presents us with the words of Koheleth in their original form, stripped of later interpolations, sayings, and comments. The translation of Koheleth is excellent, and in reading it we seem to be brought face to face with a book published yesterday, because it looks upon the world of Nature and of life from a point of view which cannot be neglected. Of course, such aspects do not exclude others, but it is always well to make the best use of each point of view, and not to try to form a composite so vague that no meaning can be extracted from it. No doubt Prof. Jastrow had something like this in mind when he undertook the preparation of this volume, and we sincerely hope he will deal with other composite books of the Old Testament as he has done so splendidly with the Book of Koheleth.

### New Books on Industrial Chemistry.

- (1) *Applied Chemistry: A Practical Handbook for Students of Household Science and Public Health.* By Dr. C. Kenneth Tinkler and Helen Masters. Vol. i., *Water, Detergents, Textiles, Fuels, etc.* Pp. xii+292. (London: Crosby Lockwood and Son, 1920.) Price 12s. 6d. net.
- (2) *Chemistry from the Industrial Standpoint.* By P. C. L. Thorne. (New Teaching Series.) Pp. xvi+244. (London: Hodder and Stoughton, 1919.) Price 4s. 6d. net.
- (3) *Fuel, Water, and Gas Analysis for Steam Users.* By John B. C. Kershaw. Second edition, revised and enlarged. Pp. xii+201. (London: Constable and Co., Ltd., 1919.) Price 12s. 6d. net.
- (4) *Popular Chemical Dictionary.* By C. T. Kingzett. Pp. vi+368. (London: Baillière, Tindall, and Cox, 1920.) Price 15s. net.

(1) THIS work is mainly intended for students in their third year who are preparing for diplomas in household and social science, and for diplomas and degrees in public health of the various universities. There is no work known  
NO. 2634, VOL. 105]

to the reviewer that covers the ground in the same manner as this. The book is clearly and attractively written, and forms a most useful addition, not only to the academic student, but also to the works chemist, who must often adjudicate upon matters such as are dealt with in this work.

The book does not deal with manufacturing operations, but gives a clear and practical exposition (with the necessary theoretical explanations) of the methods employed in analysing and appraising the value of water, water softening processes, soap, textile fibres, bleaching agents, dry cleaning, air analysis, gaseous fuels, liquid and solid fuels, materials used in the protection of wood, metallic and other surfaces, etc. Although the authors themselves make no claim to originality, many of the subjects are treated in a manner very different from that prevailing in most of the existing works on the subject. Every technical chemist should possess a copy of this work for reference, as there is collected together here in one volume a large mass of material which is usually scattered piecemeal throughout a number of expensive treatises. Altogether this is a book to be thoroughly recommended, and it should command a wide sale.

(2) Mr. Thorne has written an interesting little book on a very large subject, which is clearly and attractively explained, and the volume marks a considerable departure from the older style of text-book. Not very long ago a book of this type would have enjoyed no sale, but would have been coldly received in scientific circles, and the advent of such a work shows what a revolution has been wrought in the chemical world within the last few years. The reviewer cannot help thinking, however, that Dr. Briscoe's excellent introduction is somewhat hard upon the business man. His own experience is that the business world is very much alive to scientific possibilities, whereas the purely professional university-trained chemist of the past was not only largely unpractical, but also held himself aloof from the problems of the business man, and the latter's caution was founded in many cases upon heavy losses attained by contact with the semi-scientific "expert" who regards the business man as his natural prey.

For the earnest technical student or the trained works chemist the book naturally is not of great use, as it cannot go into exact detail. For a young chemist, however, entering works for the first time, it gives an excellent summary of the main operations involved in chemical industry, and is well up-to-date as regards modern develop-

ments, as witness the references to rotary filters, catalytic action, hydrogenation of fats, etc.

The ordinary business man engaged in dealing with the products of chemical industry will undoubtedly derive considerable benefit from the perusal of this volume. The style is clear enough to be intelligible even to the non-technical reader.

(3) Fuel and water are such important subjects industrially that any book dealing with them is bound to receive serious attention from every works chemist and steam user. The present work (now in its second edition) meets a well-defined want in that it gives trustworthy and up-to-date technical methods of analysing fuel, water, and gas.

Part i. deals with fuel; fuel sampling, analysis of fuel, thermal values of fuel, etc., and is excellent. Part ii. deals with water as applied to technical purposes; methods of sampling and analysing it, of softening, and of calculating the amount of softening materials to be added, are given in full. Here, in a concise form, are the materials upon which a practical opinion can be formed as to the best methods of dealing with any given type of water. The subject of part iii. is waste gases; their sampling, analysis, and valuation.

The work is written by an authority who is in practical touch with the numerous and difficult problems relating to fuel and water which every works chemist has to handle. It can be recommended to every industrial chemist.

(4) The author has achieved his aim of producing a "popular" dictionary of chemistry, and the work, so far as it goes, is very complete, almost every well-known chemical or piece of chemical apparatus being briefly mentioned. It is very difficult to see, however, for what class of reader such a work is intended. For purposes of strict reference the volume is far too "popular." For example, on looking up the word "pyridine," we are informed that it is "a nitrogenous base present in bone oil, and in tar obtained from shale and coal." No mention is made of its boiling point, specific gravity, constitutional formula, solubilities, etc., which the average reader would require. This is typical of the work. In the reviewer's experience, no one looks up chemical terms for amusement. Definite quantitative information is what the user of a dictionary requires in ninety-nine cases out of a hundred, and it is these quantitative data which are so conspicuously lacking in the present volume. The constants of most of the materials should have been given in a work of this kind. G. M.

## Our Bookshelf.

*The Theory of Heat.* By Prof. Thomas Preston. Third edition. Edited by J. Rogerson Cotter. Pp. xix + 840. (Macmillan and Co., Ltd., 1919.) Price 25s. net.

It is pleasant to meet an old friend still going strong in spite of years and changing fashions. In these days of rapid progress a quarter of a century is a long period in the life of a book dealing with a living science. The secret of the continued popularity of Preston's work is no doubt to be found in the fact that the book was written as a labour of love in the interests of true scientific education, instead of being merely compiled to suit an arbitrary standard or syllabus, adapted to a particular type of student, or a special limit of mathematical attainment. The object has been to give a comprehensive survey of the development of the theory of heat from an historical point of view, which possesses many advantages in the exposition of a scientific subject.

The historical order of evolution, both in theory and in experiment, generally follows the natural processes of reasoning of the human mind, and introduces fresh ideas in a regular sequence in which they are readily assimilated. The deductive method, starting with a general law or formula, may frequently provide a more direct means of arriving at any particular result or practical application, but it tends to obscure the essential foundation on experiment, and to rob the subject of human interest. From the point of view of the general reader, as distinguished from the special student, there can be no comparison between the two methods. There is an illusion of finality in the deductive method which appeals to the mathematical mind, but the historical method, when illustrated, as in Preston, by a critical discussion of typical experiments, is the more suggestive, inspiring the student to think for himself and to make further advances.

The book is so well known that it only remains to add that Mr. Cotter has shown himself to be a most sympathetic and capable editor in both pruning and grafting. The important additions, on recent advances in the theory of radiation and specific heat, and on the kinetic theory of gases, are admirable summaries, conceived and carried out in the spirit of the original. H. L. C.

*Royal Botanic Gardens, Kew: Bulletin of Miscellaneous Information.* 1919. Pp. iv + 459 + 39. (London: H.M.S.O., 1919.) Price 4s. 6d. net.

This volume contains the ten numbers of the *Kew Bulletin* which were published at intervals from April to December, 1919. The thirty-three articles include papers and miscellaneous notes of both economic and strictly botanical interest. Mr. J. H. Holland contributes a useful list of food and fodder plants arranged under their respective families, with notes on their origin, uses, popular names, etc. There are also papers



on "The True Mahoganies," by Mr. R. A. Rolfe, and "The Jerusalem Artichoke," by Mr. C. C. Lacaita; the latter is an exhaustive discussion on the introduction of this vegetable to the Old World and the origin of its popular name. An account is given of Lord Ventry's experiments on growing New Zealand flax in Ireland; the evidence goes far to show that the possibility of growing it in South-West Ireland as a commercial undertaking is an established fact. "Silver-leaf Disease" and "The Skin-spot Disease of Potatoes" are the titles of two important contributions on plant-diseases by Messrs J. Bintner and M. Nest Owen respectively. Results of botanical exploration are embodied in Dr. Hemsley's account of the flora of Aldabra and adjacent islands and in Mr. Turill's *résumé* of the botanical results of Swedish South American and Antarctic expeditions.

The more purely botanical papers include a careful examination, by Sir David Prain and Mr. Burkill, of the identity of the plant, or plants, known under the name *Dioscorea sativa*; and a revision by Mr. W. B. Grove of the species of the fungus genus *Phoma*. There is also an historical account of the botanic garden of Pamplemousses, Mauritius; and the new flagstaff at Kew and its erection are described in detail. The obituary notices include those of Prof. J. W. H. Trail of Aberdeen and Prof. W. G. Farlow of Harvard.

*The Story of Milk.* By J. D. Frederiksen. Pp. xx+188. (New York: The Macmillan Co.; London: Macmillan and Co., Ltd., 1919.) Price 9s. net.

THE author tells his story in a clear and interesting manner, and the general reader, as well as the student of domestic science or dairying, will follow the contents of the book with pleasure and profit. The subject-matter is sound, and the concise, practical directions will be valuable to anybody who is acquainted with the general methods of butter-making and cheese-making.

There are sections dealing with the composition and properties of milk, the testing of milk, the part played by enzymes and bacteria, and the methods by which organisms are utilised or controlled. Milk supply and butter-making and the manufacture of ice cream are the chief subjects of another section. As the book is written for American readers, the sixteen pages devoted to recipes for ice cream are perhaps not excessive, and they will not fail to raise in the English mind a feeling of envy that such delectable things as *parfaits* and *mousses* are not more general.

Cheese-making is well dealt with, and working details are supplied, whilst the methods adopted in the manufacture of condensed milk, milk powder, and casein are briefly sketched.

Very rightly the food value of milk is given a prominent place, and the recipes for dishes in which milk or cheese forms an important part are attractive, and should be found very useful to

many. A certain amount of historical information is given, and the names and labours of notable workers in the various branches of dairying are also to be found in the book.

*A First Year Physics for Junior Technical Schools.* By G. W. Farmer. With an Introduction by S. C. Laws. Pp. x+183. (London: Longmans, Green, and Co., 1920.) Price 4s. 6d.

THIS book is intended for use by boys of between twelve and fourteen years of age who have just completed the elementary-school course and are passing to a more advanced curriculum such as is provided in the junior technical, central, or continuation school. It may suit the courses in some of these institutions, but if this is to be the only kind of instruction in physics during the first year of study, the diet cannot be said to be too stimulating. The work is concerned almost entirely with the use of simple measuring instruments. The description of three methods of verifying "Pythagoras," of four ways of measuring the weight of a cubic centimetre of water, and of no fewer than eleven experiments to show that air exerts pressure indicates too much devotion to completeness of detail at the expense of time which could be spent more profitably in giving the pupils glimpses at the marvels of Nature by which they are surrounded.

*The Struggle in the Air, 1914-18.* By Major Charles C. Turner. Pp. viii+288. (London: Edward Arnold, 1919.) Price 15s. net.

MAJOR TURNER gives an extremely instructive and readable account of the development of aircraft from 1914 to 1918. With the work of a generation compressed into four years of war, it is not surprising that the developments and events narrated crowd upon each other in bewildering succession. The psychology of flying and the official requirements as regards details of machines for war purposes form exceptionally valuable chapters of the book.

*Calculation of Electric Conductors.* By William T. Taylor. Pp. 34. (London: Constable and Co., Ltd., 1919.) Price 10s. 6d. net.

A CHART supplied with the book enables the electrical engineer to determine the size of a conductor required to convey a current of a given value when the voltage drop and length of cable are given, or to find any of these quantities when the three others are given. With the help of the explanatory text all the ordinary cables and systems can be thus dealt with.

*Revision Arithmetic, Logarithms, Slide Rule, Mensuration, Specific Gravity, and Density.* By Terry Thomas. Second edition, revised. Pp. 62. (London: Crosby Lockwood and Son, 1920.) Price 2s. 6d.

NUMERICAL examples and answers are given. The standard is that of the Army and Navy Entrance Examinations.

### Letters to the Editor.

[The Editor does not hold himself responsible for opinions expressed by his correspondents. Neither can he undertake to return, or to correspond with the writers of, rejected manuscripts intended for this or any other part of NATURE. No notice is taken of anonymous communications.]

#### The Separation of the Element Chlorine into Normal Chlorine and Meta-Chlorine, and the Positive Electron.

THE very important letter of Dr. Aston in NATURE of December 18, 1919, gives much evidence in favour of a theory of the structure and composition of the nuclei of complex atoms as published by me five years ago and in a number of more recent papers. This theory led me to the idea, as published at that time (Journal of the American Chemical Society, xxxvii., pp. 1367-96, especially pp. 1390, 1391, and 1387), that among the light elements magnesium, silicon, and chlorine, in addition to neon (as found by Thomson), are mixtures of isotopes. The atomic weights of the normal isotopes were given as 24 for magnesium, 28 for silicon, and 35 for chlorine. It was also stated that nickel, copper, zinc, and practically all the other elements between atomic numbers 28 and 80, the latter being mercury, are mixtures of isotopes; while radio-active evidence shows that elements 81 (thallium) to 92 (uranium) exist in isotopic forms. This theory was recently summarised in a paper sent to the *Physical Review* in May and November, 1919. This paper, as well as the others, should be consulted for the details of the theory.

In February, 1916, I announced that we were working in this laboratory upon the separation of chlorine into isotopes by diffusion (*ibid.*, xxxviii., p. 221, 1916). Early in 1917 Mr. W. D. Turner, my research assistant, found slight differences in density between the heavy and light fractions obtained by diffusing chlorine, but, since small amounts of impurities were very difficult to exclude, this did not seem at all conclusive. Since if there are two isotopes of chlorine there are three molecular forms of the substance, a separation may be made more easily by the use of hydrogen chloride gas, and this has been used in nearly all our work for the last three years, though practically nothing was done during the period of the war.

The diffusion of this gas, as carried out on a moderately large scale by Mr. C. E. Broeker and myself, seems now, judging by our preliminary analyses, to be resulting in a definite separation of the gas into a heavier and a lighter fraction. The separation, while extremely slow, seems from our preliminary results on the heavy fraction to be of about the order to be expected by the Rayleigh diffusion theory, provided the atomic weights of the isotopes are 35 and 37; so the work is in good agreement with that of Dr. Aston. These results may be modified somewhat when our precise atomic weight determinations are made, since at the present time all our determinations are made by rapid methods. Our results suggest, but are not of a sufficient precision really to indicate, the possibility that a third isotope of higher atomic weight may exist, but since the separation is extremely slow, and the positive ray method as worked out by Dr. Aston gives results very quickly, he should be able to test this suggestion much more rapidly than ourselves.

Since 1916 we have diffused about 19,000 litres of hydrogen chloride gas as measured under standard conditions. The apparatus now in use will diffuse

about 400 litres per day, and we hope soon to raise the capacity to 1000 litres. These numbers refer to the fresh or ordinary gas introduced into the apparatus, and not to that which is rediffused in smaller units. The total number of units now in operation is five, and the method may be described as a fractional diffusion.

While the idea that the hydrogen nucleus may be the positive electron is a very general one, the only evidence I have found in print which gives real support to this idea, and explains the facts which seem opposed to the idea, is to be found in papers by my associates and myself as cited above, and in my other papers listed at the end of this letter. The hydrogen nucleus or the positive electron has, according to these papers, a weight, and presumably a mass, of 1.000, on the basis of oxygen as 16.000, whenever the positive electron is combined in a complex atom. The atomic weight of ordinary hydrogen is 1.0077. The difference between 1.0077 and 1.000 is due either to the existence of meta-hydrogen of atomic weight 3.00 and composition  $(\eta_3\beta_3)+e^-$  in ordinary hydrogen, or else to an electromagnetic packing (possibly to both), the latter as assumed by Sir Ernest Rutherford and by myself, but the details of which are to be found in my papers. In these formulæ  $\eta^+$  is the positive electron,  $\beta^-$  the negative electron when it is contained in the nucleus, and  $e^-$  when it is a non-nuclear or planetary electron.

The nuclei of atoms are built almost entirely from the following particles:—

		Weight (oxygen basis)
Alpha particle or helium nucleus	$(\alpha^{++}) = (\eta^+\beta^-)^{++}$	4.000
Nu particle or meta-hydrogen nucleus	$(\nu^+) = (\eta^+\beta^-)^+$	3.000
Mu particle	$(\mu) = (\eta^+\beta^-)$	2.000

Of these the  $\alpha$  particle forms the greater part of all complex atoms; one  $\nu$  particle is found in most atoms of odd atomic number, at least among the light atoms; and the  $\mu$  particle, which has no net charge, is responsible for the existence of one of the two known classes of isotopes. The other class of isotopes is due to the presence of the group  $\eta^+\beta^-$ , which consists of an  $\alpha$  particle, together with two cementing electrons. It is these cementing electrons which are shot off in  $\beta$  disintegrations of radio-atoms, and they always escape in pairs—that is, one directly after the other, or one just before and one just after the escape of an  $\alpha$  particle. The number of *negative* electrons in the nucleus of an atom is almost always *even*, whether the nuclear charge is odd or even, but the number of *positive* electrons is nearly always *odd* in a nucleus of *odd charge*. However, the nuclei which contain an even number of positive electrons, and are therefore built up either of  $\alpha$  particles alone or of  $\alpha$  particles and negative electrons, are, on the whole, much more stable than those with an odd number; so the even-numbered elements are much the more abundant, and make up 98.7 per cent. of the meteorites and the greater part of the material of the earth. Furthermore, all the seven most abundant elements in the meteorites have an even atomic number, as is indicated in Fig. 1.

In the exceptional case of nitrogen the group  $\eta_2\beta$  is present, and in beryllium the group  $\eta\beta$ . A suggested structure for the  $\alpha$  particle is given in Fig. 2, where the large circles represent negative, and the small ones positive, electrons. The  $\nu$  group probably has a similar structure, but with three positive electrons at the corners of a triangle; while the lithium nucleus

1 The negative electrons in these particles may be called *binding* electrons, while those which attach extra  $\alpha$  particles are called *cementing* electrons.

is assumed to consist of one  $\alpha$  and one  $\nu$  group, with a symmetrical arrangement of the seven positive electrons. Two  $\alpha$  particles do not seem to combine, but from three to eight, and also ten,  $\alpha$  particles combine without the inclusion of any cementing electrons; but when more than ten unite, two or a

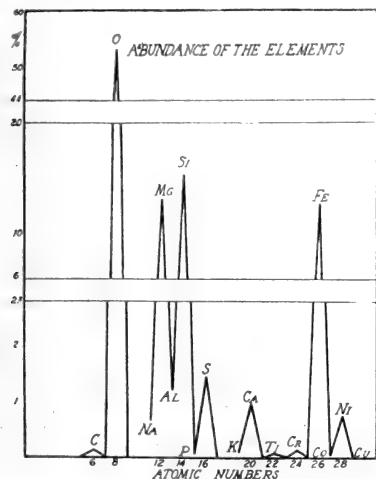

FIG. 1.

multiple of two negative electrons are used in cementing on extra  $\alpha$  particles—that is,  $\alpha$  particles which do not contribute to the positive charge on the nucleus.

Argon and calcium have isomeric atoms, the formula

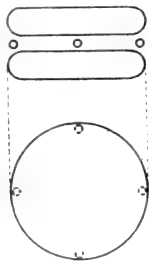

FIG. 2.

of the former being  $\alpha_{10}\beta_2e'_{18}$  and that of the latter  $\alpha_{10}e'_{18}e_2$ , so both have the general formula  $\alpha_{10}e'_{20}$ . The formulæ given below represent a few characteristic atoms:—

Even Nuclear Charge

- C  $\alpha_6\beta_2e'_{12}$
- O  $\alpha_8\beta_2e'_{16}$
- S  $\alpha_{16}\beta_2e'_{32}$
- Fe  $\alpha_{14}\beta_2e'_{28}$

Odd Nuclear Charge

- N  $\alpha_7\beta_2e'_{14}$
- F  $\alpha_9\beta_2e'_{18}$
- Cl  $\alpha_{17}\beta_2e'_{34}$  and  $\alpha_{17}\nu\mu e'_{30}e'$
- Co  $\alpha_{15}\beta_2e'_{30}$

Thorium Series

- Th  $\alpha_{24}\beta_{26}e'_{86}e'$
- ThX  $\alpha_{22}\beta_{24}e'_{82}e'$
- Pb(Th)  $\alpha_{20}\beta_{22}e'_{78}e'$

Uranium Series

- U  $\alpha_{23}\beta_{25}e'_{85}e'$
- Ra  $\alpha_{21}\beta_{23}e'_{81}e'$
- Pb(Ra)  $\alpha_{19}\beta_{21}e'_{77}e'$

Here  $e$  represents a valency electron,  $e'$  a non-nuclear electron in one of the inner shells, and  $\beta$  a cementing electron in the nucleus. The evidence for these formulæ is good, but cannot be presented here.

It will be seen that this hydrogen-helium-meta-hydrogen theory of atom-building is based upon the atomic weight and atomic number relations; the Rutherford atom; the rule of Soddy, Fajans, and Russell for radio-active changes; and the atomic weight relations discovered by Rydberg about thirty years ago; and is dependent for its validity upon the existence of chlorine, magnesium, silicon, and the heavy atoms in isotopic forms. It is a resurrection and an extension of the hypothesis of Prout.

References.—J. Am. Chem. Soc., xxxvii., pp. 1367-96 (1915); xxxix., pp. 856-79 (1917); Phil. Mag., xxx., pp. 723-34 (1915); Science, N.S., xlv., pp. 419-27, 443-48 (1917); Proc. Nat. Acad. Sciences, i., p. 276 (1915); ii., pp. 216-24 (1916); Physical Review, February, 1920, in press.

WILLIAM D. HARKINS.

Department of Chemistry, University of Chicago, March 8.

I HAVE read Prof. Harkins's letter with great interest. If Prof. Harkins has succeeded in separating the isotopic hydrochloric acids he is certainly to be congratulated. The very meagre positive results from my work with neon described at the British Association meeting in 1913 convinced me of the extreme difficulty and labour of such diffusion experiments. In the case of neon I had only to grapple with a twentieth root in the diffusion equation, whereas with HCl it is the thirty-sixth root which is involved. In connection with the possibility of a third isotope of chlorine in the full account of my recent analysis of this element, now in the press, I have described a faint line at 39 which may be this.

More experimental results will be required before the time is ripe for the formulation of a comprehensive theory of atomic structure. I do not propose, therefore, to discuss the one put forward by Prof. Harkins, but would like to point out that his basal assumption that the positive electron has a weight 1000 is definitely contradicted by experimental results quoted in my letter in NATURE of March 4. F. W. ASTON.

Cavendish Laboratory, Cambridge, April 20.

On Atomic and Molecular Structure.

THE statement of Mr. S. C. Bradford in the second paragraph of his letter to NATURE of April 8, that I suppose the electrons to revolve in small circles without any constraining force, is erroneous. The fact that I reserved an opinion as to the nature of the constraining force does not imply, as he suggests, that I deny its existence. Thus (cf. Science Progress, April, 1920, and Phil. Trans. Roy. Soc., vol. ccxxx., p. 247, 1920) an electron moving with speed  $v$  perpendicular to a magnetic field of intensity  $H$  (which may originate in the nucleus) describes a circular orbit of radius  $\rho = mv/He$ , and the frequency of the electron is  $\nu = He/2\pi m$ , which (and this is an advantage in the case of a radiating orbit) is independent of the speed with which the electron describes the orbit. At present we know little about the actual value of  $v$ . If  $H$  is of the order of  $10^7$  gauss, the value ascribed to the molecular field from magnetic considerations, the frequency is that of infra-red radiation, and the correlation of the elastic properties of the medium (which are determined by this molecular field) with the infra-red vibrations, as originally pointed out by Debye, is apparent. Within an atom the controlling field may be of the order  $10^8$  gauss, which gives rise to vibrations of optical frequency. Closer to the nucleus a field of  $10^9$  gauss gives rise to frequencies comparable with those of a K series.

Finally, it should be pointed out that the ring electron theory, which Mr. Bradford attributes to

Dr. H. S. Allen, was originally expounded by Mr. A. L. Parson (Smithsonian Miscellaneous Collections, vol. lxx., p. 1, 1915). The advantages of such a theory were ably expressed recently by Dr. Allen in an opening address before the Physical Society of London.

A. E. OXLEY.  
The British Cotton Industry Research Association, 108 Deansgate, Manchester.

### Aquarium Cultures for Biological Teaching.

THE increase in the number of students in biology during the last few years has created a demand for large quantities of such animal types as *Amoeba*, *Actinosphaerium*, brown *Hydra*, and *Daphnia*. It is often very difficult to obtain to time vast numbers of these types; for in Nature the supply is exceedingly precarious, depending as it does on conditions which are constantly fluctuating. In endeavouring to secure a continuous and plentiful supply of *Amoeba proteus*, I have accumulated a certain amount of experience in aquarium-keeping on a large scale, the results of which will be useful to others who, like myself, have to deal with large numbers of students.

Information with regard to *Amoeba* culture has already been given in "Notes on the Collection and Culture of *Amoeba proteus* for Class Purposes" (Proc. Roy. Phys. Soc. Edin., vol. xx., part 4, p. 179). Since the publication of that note, however, I have tried, as an alternative plan for procuring the material necessary to inoculate a culture, a modification of the respective methods described by J. B. Parker ("A Method of Obtaining a Supply of Protozoa," *Science*, N.S., vol. xlii., No. 1090, p. 727, 1915), Libbie Hyman (*Journ. Exp. Zool.*, vol. xxiv., No. 1), and Asa A. Shaeffer (*ibid.*, vol. xx., No. 4), and with success.

Water from such places as the drainage-cuttings in birch, alder, and willow woods, or from the margins of ordinary pools and ponds, together with the filamentous algae and the brown scum and included diatoms overlying the dead leaves and the other decaying organic matter forming the floor of such places, is gathered in autumn or in early spring. This is allowed to stand in tap-water for some time, until a rich brown scum appears on the top. The top water with the scum is poured off into another glass vessel, and wheat is added (1 gram to a litre of water). In February minute *Amoebæ* begin to make their appearance; these become fully grown in May and June, and will then divide rapidly, forming a luxuriant culture until the late autumn, when encystment of most individuals again takes place.

Once started, *Amoeba* cultures require no further attention than a supply of water to compensate for evaporation, and the addition of wheat from time to time.

I am indebted to Prof. Bourne, of Oxford, for information that boiled rain-water can be used in those districts, e.g. Oxford, where the tap-water contains much mineral matter.

*Actinosphaerium*.—My principal difficulty in the culture of *Actinosphaeria* has been in maintaining for them a sufficient food-supply. Stentors and vorticellids, their favourite food, appear to require running water, and therefore quickly die off when introduced into the laboratory (except the green stentor, which thrives well when once established, and a small vorticellid which appears in infusions of certain pond-weeds). The common rotifer is an excellent food, and this can be obtained from rubbish left over from pond-gatherings by means of wheat or hay infusion. Members of the family *Cathynadæ* (especially *Monostyla*, which is of

frequent occurrence in *Amoeba* cultures, and therefore easily grown in wheat-water) are the most useful of the above-mentioned foods.

Since *Actinosphaeria* disappear very quickly when their food is exhausted, and since, on the other hand, they grow and multiply very rapidly when the food-supply is good, and very quickly exhaust this food-supply, it is necessary to give the Rotifer culture a good start before introducing the *Actinosphaeria* into it. In practice I have several *Monostyla* cultures in readiness, and then, about three months before requiring large numbers of *Actinosphaeria*, I inoculate one or more of the *Monostyla* cultures with a few *Actinosphaeria* and set the jar aside. These latter soon multiply and appear in myriads.

*Hydra*.—Large brown *Hydra* showing buds and reproductive organs can be obtained in considerable numbers and very quickly in laboratory cultures (especially in rooms with a fairly uniform temperature of 60° F.) if they are systematically fed on a generous diet of Crustaceans, which latter can be obtained by the culture of *Daphnia*. The *Daphnia* should be strained off by means of a small net, and a concentrated mass of them in a small quantity of water should be added periodically to the jar containing the *Hydra*. Several hundreds of *Hydra* by this means can be obtained from one or two individuals in a few weeks.

Interesting colour-changes, varying from dingy brown to a bright pink, can easily be effected in brown *Hydra* by varying the Crustacean diet.

*Daphnia*.—I am indebted to Mr. P. Jamieson for the discovery of the value of small pieces of earthworm for the cultivation of *Daphnia*. If an infusion of dead earthworms in water be allowed to stand in a warm place (i.e. near the radiators in the laboratory) it is quickly converted into a rich food, which can be added to the *Daphnia* cultures, as required. A few *Daphnia* introduced into a large wide-mouthed glass bottle or beaker of water, to which the worm-water is regularly added, very quickly multiply. Several of these cultures should be kept going if the cultivation of *Hydra* is very intensive, as they must be allowed to recuperate after they have been depleted by use.

A variety of other Protozoa, Crustaceans, Oligochætes, etc., make their appearance in the above-mentioned cultures, commonly sufficient to supply abundant material for demonstration purposes.

MONICA TAYLOR, S.N.D.

Convent of Notre Dame, Glasgow.

### Ionisation in the Solar Chromosphere.

IT is well known that the spectrum of the upper layers of the solar chromosphere is chiefly composed of those lines which are relatively more strengthened in the spark than in the arc, and which Sir Norman Lockyer originally styled enhanced lines. The best-known examples are the calcium H and K and the strontium pair (4216, 4077). According to modern theories of spectral emission, these lines are due to an atom which has lost one electron. The principal line due to the normal atom of calcium is the *g*-line 4227, and the corresponding Sr line is 4607, both of which occur at much lower levels. According to modern theories, therefore, Ca, Sr, and Ba atoms are more and more ionised as we approach the upper layers of the solar atmosphere, while in the lower layers both normal and ionised atoms occur.

If we assume that ionisation is a sort of reversible chemical process taking place according to the scheme  $\text{Ca} = \text{Ca}^+ + e - U$ , where  $e$  is the electron,  $\text{Ca}^+$  is a positively charged Ca atom, and  $U$  is the energy of

ionisation, we can apply Nernst's theorem of the "reaction-isobar" to calculate the amount of ionisation under any given thermal stimulus. The method is based upon a remark of Nernst in his book, "Der Neue Wärmesatz . . ." (p. 154), that the electron may be regarded as a monatomic gas of molecular weight  $\frac{1}{1836}$ , and that its chemical constant can be calculated according to the Tetraode-Sackur relation

$$C = \log \frac{(2\pi m)^{3/2} k^3}{h^3}$$

It has recently been applied by Eggert (*Ver. d. D. Phys. Gesell.*, December 15, 1919) for the calculation of the degree of ionic dissociation in the interior of a star, as supposed by Eddington in his theory of stellar structures. But Eggert calculates  $U$  in a rather artificial manner for iron from assumed atomic dimensions and structures of the iron atom.

We can, however, calculate  $U$  directly from the value of the ionisation potential as experimentally determined by Franck and Hertz, MacLennan, and others, or from the quantum relation

$$V = \frac{h\nu}{e}, \nu = (1.5, s).$$

Using the value of  $U$  determined in this way for calcium, barium, strontium, hydrogen, and helium, the following remarkable results appear:

(i) About 30-40 per cent. of the Ca atoms are ionised just over the photosphere; in the chromosphere, when the pressure falls to  $10^{-4}$  atms., almost all the Ca atoms are ionised. The same conclusion holds to a varying degree for Ba and Sr.

(2) Hydrogen and helium are not ionised anywhere in the solar atmosphere. (This is due to their high ionisation potential.  $V$  is 13.6 for H and 20.5 for He, while for Ca, Sr, and Ba the figures are 6.12, 5.7, and 5.12.) Helium can become ionised only in stars of which the temperature exceeds 16,000 K.

(3) Pressure has a great influence on ionisation, a reduction in pressure causing great enhancement of ionisation.

It therefore appears that the ionisation in the upper layers of the solar atmosphere, as revealed by the enhanced lines of Ca, Sr, and Ba, and probably also of Fe, Ti, and Sc, is due to reduced pressure and the low ionisation potentials of these elements, and not to an increased temperature.

The full theory has been worked out in a paper communicated to the *Phil. Mag.* M. N. SAHA.

University College of Science, Calcutta,  
March 8.

### Gravitational Deflection of High-speed Particles.

In a letter published in NATURE of March 11 Prof. Eddington has shown that the statement made by me in an earlier letter to the effect that Einstein's law of gravitation seems to lead to a zero deflection for a material particle moving with the velocity of light is not in accord with the exact equation of the orbit contained in his report to the Physical Society, and suggests that my approximations were not sufficiently close to warrant my conclusion. The line element from which Prof. Eddington derives the equation of the orbit is expressed in co-ordinates which make the velocity of light different in different directions at any one point, whereas the one used by me requires that the velocity of light should be a function of position only, and not of direction. In terms of my co-ordinates the equation of the orbit of a particle moving with the velocity of light is

$$u = 2 \frac{m}{R^2} + \frac{1}{R} \left(1 - 2 \frac{m}{R}\right) \cos \theta,$$

which leads to the same deflection  $4 \frac{m}{R}$  for a material particle moving with the velocity of light as for a light-ray. Hence it is clear that my previous conclusion was based on an insufficiently close approximation, and therefore erroneous.

I am glad to see that Prof. Eddington has verified the other principal conclusion of my letter.

LEIGH PAGE.

Sloane Laboratory, Yale University, New Haven, Connecticut, March 29.

### Science and the New Army.

It requires some courage to offer any opposition to the chorus of approval which has greeted the suggestion that a proportion of officers endowed with the scientific spirit should be included in the General Staff, but I venture to think that it is by no means so easy to give effect to this proposal as some correspondents in NATURE seem to suppose. No doubt it would be delightful if we could have Staff officers who knew all about everything, but in actual practice the man who does useful work in the world is a specialist in one particular subject or in one particular branch of work.

A good regimental officer requires a particular kind of training and possesses a certain set of qualifications. Similarly, a good Staff officer requires a different training and possesses a different set of qualifications. A man of science, again, is different from either of the other two.

The proportion of officers in the Army as a whole who possess any scientific training is comparatively small. There are a certain number of specialists whose ordinary duties are of a technical nature, and there are a few officers who take up some branch of science as a hobby, but the work of the average officer is not such as to bring him into touch with scientific thought and scientific methods. Men are to be found who are good Staff or regimental officers and also scientific workers, but they are exceptions, and it seems to me that a system which demands a regular supply of exceptional men is not one which is likely to work in practice.

There is also a further difficulty. Granting, for the sake of argument, that there are sufficient officers in the Army who possess both the scientific spirit and the qualities necessary for potential Staff officers, it is still necessary to devise a method of selecting them from their more ordinary fellows. Two methods are in common use, namely, examination and nomination.

An examination is a good method of testing that form of knowledge which is acquired by study, but it will be generally agreed that it is not a good method for detecting the scientific spirit. The difficulty in the case of nomination is that the candidates must be selected by ordinary regimental officers who can alone be acquainted with the qualifications of the individual candidates. The average regimental officer, however, is not himself a man of science, and I cannot see that he can ever become a judge of another officer's scientific attainments.

Without arguing, therefore, against the desirability of a General Staff containing an appreciable proportion of scientific officers, I suggest that the ideal is unattainable except in so far as specialists are attached to the Staff for their own particular work, and I think the object in view must be attained by some other means. It might be done by raising the general standard of education in scientific matters throughout the country, but this is a very large question, and not a very easy one.

Probably the best hope of an immediate improvement in the relations between science and the Army lies in the direction suggested by Prof. Filon in his letter in NATURE of April 1, in which he says:—"I would suggest . . . that what is most urgently needed for General Staff officers is a course of scientific classification and organisation, where they would be taught the real meaning of scientific qualifications and the names of living authorities in various subjects."

The position of the Signal Service is a case in point. I think I am correct in saying that a few years before the war there was scarcely an officer outside the Signal Service itself who knew what that Service was. It was generally recognised among the officers of the Signal Service that one of their chief duties would be to advise and instruct the staff in the possibilities and limitations of the Service, and that this duty would not be less important than the supervision of the technical duties of the Service itself. This principle was applied both in manoeuvres and during the war, and I think that the correctness of the views held was fully borne out by experience. The ordinary Staff officer eventually learnt that battles could not be fought without signals, and that it was necessary to take the senior signal officer into his confidence if the best results were to be obtained.

I suggest that men of science in general might well follow this example. They should realise that the Staff officer is a specialist in his own particular business and that he cannot know everything, and they should themselves advise him how science can be used and what are its limitations.

Technical and scientific societies might themselves select small committees which would be prepared to advise the War Office or other Government Departments on technical matters. The committees might also be prepared to nominate gentlemen who could visit the Staff College and other military centres and give lectures on their own special subjects. The lectures would not deal with technical matters to any great extent, but their purpose would be to show what had been done by the particular science or industry during the war, and to indicate in what directions assistance might be expected in future.

One further suggestion I should like to make. Certain sums are allotted from time to time in connection with experiments on the design of military equipment, and these funds are devoted to work which is carried out almost entirely by military officers acting under the instructions of War Office Committees. The funds now allotted are small, but I suggest that additional sums might be given for research work on military subjects which might be allotted by the War Office Committees to technical or scientific institutions outside the Army. Periodical discussions between the War Office Committees and the technical institutions with regard to these researches would tend to keep the War Office Staff in touch with leading scientific and technical workers outside, and it would permit of those personal exchanges of opinion which are worth all the official letters which were ever written.

K. E. EDGEWORTH.

Crowborough, April 11.

#### The Universities and the Army.

THE proposals contained in the leading article in NATURE of April 8, that the raw material for the commissioned ranks should be university graduates rather than public-school boys, may be ideal, but it would have been more practicable in 1914 than it is at the

NO. 2634, VOL. 105]

present day. Under the existing pressure on the universities there is rather a risk of the Army candidate being squeezed out; there is not accommodation for all candidates for commissions to enter freely. For the moment we shall have to be content with a measure by which selected officers can be accepted at universities for specialised training not readily available elsewhere. Thus the Services can obtain that contact with living science which is so essential for them, and has been so often lacking in the past. This will require supplementing by courses within the fighting Services if proper preparation is to be made for the scientific aspects of the next war. At least at the various Staff colleges trained scientific workers must lecture, while selected officers should be sent to work in university laboratories. The present state of friendly co-operation must not be allowed to disappear.

The practice of farming out research problems to scientific institutions may have favourable results if pursued in a long-sighted manner and supported by adequate grants (and, where necessary, by field or marine trials). Given close co-operation, it should lead to many problems of defence and offence being foreseen and solved in advance. The man of science should have his chance of pointing out to those who must listen (and who have the power of decisive action) what key industries are vital to the country's safety, and cannot be allowed to pass entirely to other lands. The necessary mobilisation of science at the next emergency should be quicker and more practical, and the man of science should have a better sense of the nature of the problems that are likely to be sprung upon him to solve.

One word by way of conclusion. The fighting Services are not the only national Services that would gain by a wide infusion of scientific knowledge and method.

F. J. M. STRATTON.

Gonville and Caius College, Cambridge.

#### Early Hawthorn Blossom.

THE first sound of the cuckoo and the first flowers of the hawthorn have come this year about the same time, which is surely a remarkable occurrence.

It is not unusual for hawthorn blossom to appear well after the beginning of May, and it has been suggested that the discontinuance of May Day festivities was due in part to the change in the calendar introduced into this country in 1752. The change made May Day eleven days earlier by the sun, and so reduced the chance of obtaining whitethorn blossom, which was the proper ornament for the top of the maypole and for the crown of the May Queen.

Gilbert White's "Naturalist's Calendar" gives April 20 as the earliest date for the unfolding of the hawthorn blossom, but the Rev. C. A. Johns in his book, "The Forest Trees of Britain," states that hawthorn blossom was gathered in Cornwall on April 18, 1846. This year it was seen on April 16 at Northwood, Middlesex.

JENNY ROSE.

#### The Doctor of Philosophy in England.

REFERRING to the article in NATURE of April 15 on this subject, I may perhaps recall to the recollection of the writer that in the University of Aberdeen the degree which is primarily that of Master of Arts confers specifically *Magister Artium et Doctor Philosophiae*.

HENRY O. FORBES.

5 Ilchester Gardens, Bayswater.

## Progress in Naval Engineering.

THE association between the Royal Navy and the Institute of Metals has always been close. The first president was the late Sir William White, for many years the chief naval constructor, while the fourth to hold office was Vice-Admiral Sir Henry Oram, late Engineer-in-Chief of the Navy. The institute has now elected Vice-Admiral Sir George Goodwin as its new president, and thus for the second time chosen the Engineer-in-Chief of the Fleet as its chief executive officer.

The valuable address delivered by Sir George Goodwin on assuming office dealt very appropriately with progress in naval engineering, and the way in which this has been, and may be, still further aided by metallurgical research. As he pointed out, the British Navy is the largest individual user in the world of the principal non-ferrous metals, such as copper, zinc, lead, aluminium, nickel, tin, and their numerous alloys. The standards set by the Admiralty for most of the metals required by it have always been high, and to be on the Admiralty list in the supply of such materials has always been regarded by manufacturers as a valuable asset.

Sir George Goodwin remarked that the standing problem for naval designing engineers for the last thirty years or more has been the reduction of machinery weight and fuel consumption with increased durability and trustworthiness. There were days, however, when speed was not considered in the Navy to be of great importance, and when steam power was used chiefly for auxiliary purposes in getting in or out of harbour and in calms. In those days the machinery of warships was of very much the same type as that fitted in contemporary merchant ships. Pressure for advancement began when speed was recognised as an essential condition of naval warfare, and the never-ceasing demand since then for higher speeds has resulted not only in the enormously increased power of machinery for the swift war vessels of to-day, but also in a greatly reduced weight of machinery and an increased degree of trustworthiness.

The present-day problem, as outlined by Sir George Goodwin, deserves to be stated in his own language, and is as follows :—

In warship design offensive and defensive powers, speed, and radius of action are all tactical factors which must be taken into account. Their relative importance varies accordingly with the type of vessel and her intended service, but in all designs, once the separate values are allocated to these features, it is essential that the weight and space required for the propelling machinery should be as small as possible consistent with maintaining the desired power and degree of reliability and durability. Anything that can be saved in this direction will react on the design of the vessel as a whole, and lead to a smaller displacement and a higher speed, or, alternatively, to reduced engine power and lower fuel consumption for the same speed; or, again, on the same displacement greater offensive or defensive powers or a larger radius of action will be

rendered possible. The machinery weight is, moreover, closely allied with the steam consumption of the engines at full power, and any reduction in this respect is reflected in the weight of the boiler and condenser installation with their auxiliaries.

The position reached as a result of cumulative endeavour along these lines is that in the latest British battle-cruiser it is hoped to obtain 144,000 shaft-horse-power on a total machinery weight (including water) of 4750 tons—i.e. at the rate of 74 lb. per shaft-horse-power; while our most recent destroyers have frequently developed more than 28,000 shaft-horse-power on a weight of 32 lb. per shaft-horse-power.

The new president then briefly reviewed the successive steps which have led to this position. He first directed attention to the application of forced draft to naval boilers, which led by successive stages to the water-tube boiler, and pointed out that this was a time of trial with worries and troubles which have rarely had an equal. Eventually, however, the difficulties were overcome. Simultaneously with this development in boilers, we passed through a stage of intense reduction in engine weight by increasing the speed of revolution of the reciprocating engine. Following upon this came the splendid realisation of Sir Charles Parsons's endeavours for many years in the production of the steam turbine, which marked an epoch in naval engineering. It was quickly turned to account, and gave us a lead which has ever since been maintained. Another direction of progress was in respect of the fuel used for power development. For many years naval engineers had directed their attention to the utilisation of oil, but only as an auxiliary to coal. The experience obtained, however, and particularly the progress made in burning appliances, were such that it was demonstrated that oil could be used as the sole fuel when security of supply could be ensured. This done, the combination of oil fuel, water-tube boiler, and turbine became the definite policy for the Navy, and finally determined the superiority which we obtained. The British Navy was the first in the field, and its designs have been adopted in principle by other navies. The most conspicuous instance of the successful performance of the above combination was afforded by the expedition of the *Invincible* and the *Inflexible* to the Falklands in the late war and its satisfactory result.

In the second half of his address Sir George Goodwin dealt with the ways in which the work of the institute could be made to serve the advance of naval engineering, and considered briefly the problems and difficulties which centre round the use of condenser tubes, turbine blading, propeller-blade materials, bearing metals, and fast-running heavy oil engines.

Condenser tubes constitute the most important instance of the use of non-ferrous materials in the Navy. Anyone who desires to become acquainted with the perplexities of Lord Jellicoe during the late war caused by the corrosion of condenser

tubes has only to study his book entitled "The Grand Fleet." The alloy used is a tin-brass containing 1 per cent. of tin, 70 per cent. of copper, and 29 per cent. of zinc. Nearly ten years ago the institute took up this very problem with the view of solving it, and has been assisted since its inception by Sir Henry Oram and Sir George Goodwin at the Admiralty. As a result, tests are

now being carried out, in one of his Majesty's vessels, of a process devised by the committee's investigators, which, it is hoped, will go a long way towards solving this particular difficulty. In its work the committee has had no better friend than Sir George Goodwin, and there is a singular appropriateness about his choice as president of the Institute of Metals. H. C. H. C.

### The Investigation of Grain Pests.

By DR. A. D. IMMS.

FEW lines of biological research at the present time are of greater moment than those which are likely to contribute towards the maintenance of our food supply. Information comes from trustworthy sources that there is a considerable reduction in the available wheat of the world, and it is therefore more than ever incumbent upon us to reduce any preventable losses to a minimum. The damage sustained by stored grain through the inroads of insect pests is heavy, and we welcome a further series of the Royal Society reports<sup>1</sup> which are directly concerned with problems connected therewith. Prof. Dendy and his colleague, Mr. Elkington, have carried out much-needed observations of a more exact nature than has hitherto been attempted. Embodied in their reports is a good deal of both biologically and economically valuable information relating to some of our most destructive grain pests. In dealing with the phenomenon known to the trade as "webbing," they point out that it is due to the wandering of great numbers of larvæ of the moth *Ephesia elutella* over the surface of heaped grain in warehouses. Each larva trails behind itself a silken thread and, when very abundant, the whole surface of the grain may become infested with a reticulum of these threads. The superficial 12 in. of the grain are affected, and become fouled by faecal and other larval debris. Actual injury to the grain itself does not appear to be serious, and it is probable that much of the contamination would be effectually removed during the cleaning processes to which the grain is subjected. It is, however, scarcely likely that any advantage can be derived from allowing these webs to remain, on the strength of a suggestion that weevils are destroyed through getting entangled therein. The safest and surest method is to eliminate the pest as the authors advocate, and it is noteworthy that a wide range of other food products is susceptible to the attacks of this species.

In the same report (No. 4) Prof. Dendy also deals with the occurrence of live insects in pre-

sumably sealed tins. His observations show that it is an evident fallacy to conclude that they can survive indefinitely when once the original oxygen is completely used up. The main point is to ensure that the sealing of the tins has been really efficiently carried out before the latter are relegated to the store. Directly connected with airtight storage is the question of "heating." Two experiments conducted by Prof. Dendy indicate that this process, which is due to fermentation, is prevented when the grain is stored in hermetically sealed vessels. Whether anaerobic fermentation is a factor likely to occur does not appear to have been studied. In connection with the investigations, it was noted that when a vessel is only half filled with grain attacked by *Calandra oryzae*, all the insects may become perfectly motionless in twenty-four hours. When 273.5 c.c. of air are present to 100 grains of wheat, only three insects remained alive out of thirty-nine (including all stages) at the end of fourteen days at 30°-31° C. At room temperature nineteen insects out of forty-three remained alive after thirty-two days. In both experiments the percentage of carbon dioxide had gone up to between 18 and 19, and the oxygen diminished to less than 2; and the authors express themselves as being quite certain that the insects would have succumbed soon afterwards.

It is evident from these experiments that further research under varied conditions and degrees of infestation is still desirable. If airtight storage provides ready sterilisation, without previous application of heat, we have a fact of first-rate economic significance. An important factor is the moisture content of the wheat. Above a certain point the production of carbon dioxide by wheat increases very greatly. This critical point varies with the temperature, and in the cases investigated it lies between 13.25 and 16.95 per cent. Above this critical point of moisture content wheat in airtight storage speedily renders itself immune to insect attack; below it a longer time elapses. It is noteworthy that pure (moist) carbon dioxide acts almost instantaneously as a narcotic to Calandra, but is less fatal in its effects than when mixed with a small quantity of oxygen.

The seventh report deals with points in the biometrics of *Calandra oryzae* and *granaria*, and also of *Rhizopertha dominica*, which are three of the most serious grain pests. It was found that the

<sup>1</sup> Royal Society. Reports of the Grain Pests (War) Committee. No. 4: "On the Phenomenon known as 'Webbing' in Stored Grain." By Arthur Dendy and H. D. Elkington. "Note on the Occurrence of Live Insects in Tins Supposed to be Hermetically Sealed." By Arthur Dendy. No. 5, 1919; "On the Prevention of 'ending' in Wheat by means of Airtight Storage." By Arthur Dendy and H. D. Elkington. No. 6, 1920; "Report on the Effect of Air-tight Storage upon Grain Insects," Part iii. By Arthur Dendy and H. D. Elkington. No. 7, 1920; "Report on the Virality and Rate of Multiplication of certain Grain Pests under Various Conditions of Temperature and Moisture." By Arthur Dendy and H. D. Elkington.



optimum temperature for the breeding of Calandra is about 82° F., but somewhat higher for Rhizopertha. *C. oryzae* may increase 700-fold in sixteen weeks, which makes it a more dangerous pest than *granaria*, which has a slower rate of multiplication. On the other hand, adults of the latter species were found to survive the winter in this country at ordinary room temperature, whereas nearly all those of *oryzae* were killed off. Rhizopertha succumbs after three minutes' exposure at about 146° F., while 120°-130° F. is the lethal temperature for both species of Calandra.

As the consequence of information accumulated in the laboratory, tests along commercial lines need to be carried out in order to ascertain the

practicability or otherwise of the knowledge thus obtained. We strongly urge that large-scale tests should be inaugurated with as little delay as possible. If such tests confirm the conclusion that the most satisfactory method for the storage of grain in bulk, over lengthy periods, is in airtight silos or granaries, the Grain Pests Committee is to be congratulated upon a notable achievement. The construction of such receptacles would involve a high initial cost, but probably not excessive when the annual loss from weeviling is recounted. As the authors point out, by such a method of storage we should be provided with a means of maintaining a reserve of cereals in the event of war or crop failure, and, we may add, of economic or financial difficulties.

### Some Applications of Physics to War Problems.

IN an address to the Physics Section of the American Association for the Advancement of Science, delivered at the St. Louis meeting in December last and published in *Science* for March 5, Prof. Gordon F. Hull describes the work done by a number of American mathematicians and physicists in elucidating the various problems that arose during the war in connection with long-range and anti-aircraft gunnery. It may be of interest, therefore, to record the efforts of a number of British men of science, made at a much earlier date during the war, on which (and on the work of the French) the developments of American scientific gunnery as described by Prof. Hull were largely based.

Up to the spring of 1916 the developments of British ballistic science had come largely through the Ordnance Committee at Woolwich, which during the war was fortunate in having an officer of considerable mathematical attainments as head of the ballistic office. The mass of work, however, and the extraordinary variety and difficulty of the problems that arose, especially in connection with the new science of anti-aircraft gunnery, made it necessary for the Ordnance Committee to seek help from outside; and from 1916 onwards the investigation of problems in "external ballistics" devolved largely on the Anti-aircraft Experimental Section of the Munitions Inventions Department. The A.A.E.S., as it was called, consisted of a number of mathematicians and other men of science, mainly fellows and scholars of Cambridge colleges, some from the Patent Office, one from Oxford, and three fellows of the Royal Society—some in military, some in naval, and some in civilian clothes.

The work of this group was undertaken at H.M.S. *Excellent*, Portsmouth, at Rochford Aerodrome, at the National Physical Laboratory, at University College, London, and at a variety of other places. It consisted largely of trials with anti-aircraft guns, shells, and fuses, recording the

positions of shell-bursts at heights up to 33,000 ft., observing and calculating the effects of winds and of pressure and temperature abnormalities, developing the mathematical theory of ballistic calculations, and investigating the behaviour or the causes of failure and irregularity of fuses. In addition to this, work of considerable mathematical and physical interest was done, some of which will be published, on the general dynamics of shell flight (such problems as the stability of shells, the effects of rotation of the earth, "drift," the "twisted trajectory of the shot," etc.), and on the pressure distribution on the head of a shell in flight. The solution of some of these problems, undertaken originally in connection with anti-aircraft gunnery, had, in the end, a considerable bearing upon the theory of gunnery in general.

The A.A.E.S., in addition to its main work in investigating the problems of gunnery, did a large amount of routine computing of range tables in conjunction with the staff of the Galton Laboratory, and performed a number of interesting and important trials on time-fuses in co-operation with the Engineering Department of University College, London. It carried out far-reaching experiments on the use of sound-locators for the detection of aircraft, and in conjunction with the R.E. and the Air Force on the co-operation between such sound-locators and searchlights; the military equipment and methods finally adopted were based directly on these experiments. It tested both the theory and the use of a number of instruments required for anti-aircraft work, such, for example, as range-finders, height-finders, and "predictors" (instruments for predicting the "future position" of the target at the moment the shell bursts); and finally it had what was known familiarly as a "travelling circus," which moved about in Great Britain and France recording the results of practice anti-aircraft shoots, and investigating the performance of guns and instruments.

The work terminated in April, 1919, and an interesting body of scientific workers was disembodied, disbanded, or demobilised. The more important practical results of their work are being recorded for the use of the military authorities: the methods adopted, however, and many of the observations, calculations, and speculations, the

personalities of the men themselves, their various homes and adventures, the help (and the hindrance) they received from various people and officials, would provide material for a fascinating history of some "applications of physics to war problems"—a history, however, which will probably never be written.

### Obituary.

PROF. J. A. McCLELLAND, F.R.S.

JOHN ALEXANDER McCLELLAND was born at Coleraine in 1870. Leaving the High School, he studied in University (then Queen's) College, Galway, and after a distinguished course he obtained a junior fellowship of the Royal University. Proceeding to Trinity College, Cambridge, he worked under Sir J. J. Thomson, and was one of the brilliant band of investigators who made history in those days in the Cavendish Laboratory, being contemporary with Sir Ernest Rutherford, Prof. Townsend, and others. In succession to the late Prof. Preston he became professor of experimental physics in University College, Dublin, and quickly began his famous researches on secondary radio-activity.

Shortly after becoming a fellow of the Royal Society, the National University was founded, and McClelland was appointed a member of the senate and of the governing body of University College, Dublin, positions which he held until his death. He at once devoted himself to the planning of the physical laboratory of the college. His efforts were highly successful, and a very efficient research department quickly sprang up, which accomplished wonders, considering the resources at its disposal. The number of students in the college in the beginning was 550, and at the present moment it is 1350, and the task of keeping pace with such rapid growth might easily have absorbed all the time of a lesser man; but McClelland had many other spheres of activity—secretary to the Royal Irish Academy, member of the Board of National Education, member of the council of the Royal Dublin Society, and governor of St. Andrew's College—yet he undertook a still more onerous task. He became a member of the Privy Council Committee on Scientific and Industrial Research, which necessitated frequent journeys from Dublin to London, and this during the war, when, apart from the great discomforts of travelling in those times, every crossing of the Irish Sea was a gamble with death. The constant strain was too much for him, and oftentimes his friends urged him to take a long rest. His sense of duty, however, prevented him from paying attention to his bodily weakness, and when at last the college authorities persuaded him to take a six months' rest, it was too late.

As a man of science the outlook of McClelland and his method of exposition had all the clarity

of Faraday. Although, unlike Faraday, he had a sound mathematical training, his mind worked in the direction of a "common-sense" explanation of the most complicated phenomena. This made him especially valuable as a teacher, whether for advanced or elementary work. It has been the privilege of the writer to sit with him on many boards, and this same faculty of cutting away the unessentials of a question, and presenting it in its reality, rendered him a valued colleague in many matters far removed from the world of science. A Presbyterian in religion, he was followed to his grave by men of every shade of thought. It is a commonplace almost devoid of meaning to speak of a loss as irreparable, but in his college and in the wider public life of Ireland everyone who knew him feels that a man has gone from amongst us whose place it will be impossible to fill.

A. W. C.

DR. J. G. BARTHOLOMEW.

GEOGRAPHERS throughout the world will recognise that scientific geography has sustained a grave loss through the death suddenly at Cintra about midnight on April 13 of Dr. Bartholomew, the head of the cartographical firm which has been known since 1889 as the Edinburgh Geographical Institute.

Dr. Bartholomew was a native of Edinburgh, where he was born on March 22, 1860, and where he was educated at the High School and the University. As a young man he entered the business founded by his grandfather. From the age of twenty-two he took an active part in its management, and at twenty-nine he succeeded his father in the supreme control. By this time he had devised the method of representing topographical features by the system known as layering, which has made the Edinburgh Geographical Institute celebrated throughout the world, and is now copied in all other cartographical establishments. Like many other novel ideas, it may seem very obvious once it has been introduced. It merely consists in the spreading of distinctive colours, tints, or shades between successive contours on a contoured map. It accordingly gives no information as to the physical features additional to that furnished by the contours; but it

makes that information available at a glance, and hence, simple as the device is, its introduction had a revolutionary effect in cartography, all the more so because it is found capable, like contouring generally, of being combined with other methods of representing physical features.

The first important work issued by the institute illustrating this new system was "The Survey Atlas of Scotland," first published in 1895, which was followed in 1903 by a similar atlas of England and Wales. Previously to that Dr. Bartholomew had published (1899) "The Atlas of Meteorology," a work of immense labour with several original features, which shows even more strikingly his zeal for scientific geography, and amply justifies the motto he had adopted, "Amore et labore." It came out as vol. iii. of a great atlas of physical geography which he had designed, but of which only one other volume appeared during his life, "The Atlas of Zoogeography," published in 1911. Much of the most devoted work of his latter years was given to the preparation of the atlas (reviewed in these columns a few weeks ago) now being published under the title of "The Times Survey Atlas of the World," by which he hoped to out-rival the best works of the kind published in other countries.

But the Geographical Institute was far from engrossing all Dr. Bartholomew's interests. He was a member of council of the Royal Society of Edinburgh from 1909 to 1912, but in Edinburgh he was, above all, known through his intimate association with the Royal Scottish Geographical Society, of which he might with little exaggeration be called the founder. From him, at any rate, came the first suggestion of such a society, and he was among the most eager of that small body of men who in 1884 spent without stint time, energy, and enthusiasm in getting it established. He was an honorary secretary of the society from the first, and remained so until his death. By the council of that society he was generally regarded as its mainstay and chief directing spirit, and nowhere outside his family will his loss be more keenly felt than on that board.

Dr. Bartholomew was an honorary member of many foreign geographical societies. The Victoria Research Medal, a medal not awarded regularly every year, but only when there is a fit recipient, was conferred upon him by the Royal Geographical Society in 1905 "for his successful efforts to raise the standard of cartography"; and in 1918 the Helen Culver gold medal was awarded to him on like grounds by the Geographic Society of Chicago. In 1909 he received from his own university the honorary degree of LL.D. In private life he was held by all who knew him in the highest esteem, and as revealing his nature nothing, perhaps, could be mentioned more characteristic than that, in spite of the fact that he lost a son in the war, he was able to speak even of enemy countries with rare magnanimity.

GEO. G. CHISHOLM.

WE much regret to announce the death on April 18, in his seventy-third year, of DR. RUDOLPH MESSEL, F.R.S., president of the Society of Chemical Industry and past vice-president of the Chemical Society.

WE notice with regret the announcement of the death, very suddenly, on April 17, of PROF. A. K. HUNTINGTON, emeritus professor of metallurgy at King's College, London.

WE regret to record the death on April 18 of PROF. L. T. O'SHEA, professor of applied chemistry in the University of Sheffield and honorary secretary of the Institution of Mining Engineers.

MR. JAMES GAYLEY, whose death was recently announced, was the first vice-president of the United States Steel Corporation and made many important contributions to the progress of metallurgical industry. He was president in 1904-6 of the American Institute of Mining and Metallurgy and had been a member of the Iron and Steel Institute since 1888. The honorary degree of B.Sc. was conferred on him in 1912 by the University of Pennsylvania and Lehigh University; in 1906 he was awarded the Elliott Cresson medal, and in 1913 the Perkin medal, by the Franklin Institute.

MR. WILSON WORSDELL, whose death on April 14 is recorded in *Engineering*, was born at Crewe in 1850, was educated at Ackworth, and served a pupilage in the Altoona Locomotive Works of the Pennsylvania Railroad. On returning to this country Mr. Worsdell took up an appointment with the London and North-Western Railway, and in 1883 became assistant locomotive superintendent to the North-Eastern Railway; in 1890 he was appointed chief mechanical engineer of the same railway. Up to the time of his retirement in 1910 he supervised the construction of more than 1000 engines for the North-Eastern Railway.

THE death of SIR CHARLES ALLEN on April 13 is recorded in *Engineering*. Sir Charles was born in 1851 and educated at Halifax and at a technical college in Germany. In 1872 he entered the Bessemer works at Sheffield, of which his father, who was a brother-in-law of Sir Henry Bessemer, became chairman in 1889. He succeeded to the chairmanship on the death of his father in 1899, and the remarkable success of the company, especially in later years, is due largely to his ability. Sir Charles recognised fully the value of metallurgical research, and gave every encouragement in the developments of this branch; he was closely identified with the foundation of the Bessemer laboratory at the Imperial College of Science and Technology.

## Notes.

News of Capt. Roald Amundsen's Arctic Expedition has unexpectedly been received from Siberia via Alaska. The *Maud* left Norway in June, 1918, and was last heard of some months later from Dickson Island, at the mouth of the Yenisei. According to the telegram published in the *Times*, two men left the ship in October, 1918, in the vicinity of Cape Chelyuskin. Nothing has been heard of these men, although they presumably made for the fishing settlements of the Lower Yenisei, a distance of some six or seven hundred miles across the barren tundra. There seems to be little hope that the two men are alive. The *Maud* appears to have spent last winter in the neighbourhood of Aion Island, at the mouth of Chaun Bay, in north-eastern Siberia, within six hundred miles of Bering Strait. Aion Island is noted for its reindeer pasture. The coast in the vicinity is visited by native and occasional American traders in summer. The distance to the nearest wireless station at the mouth of the Anadir is about 450 miles across rough country. Until further news arrives it would be rash to suppose that Amundsen has abandoned his trans-polar drift. It is quite possible that he intends to push into the Arctic basin north of Bering Strait in order to ensure the drift taking him to a high latitude. On the other hand, the loss of two men, even supposing his messengers to the Anadir return, will seriously weaken his expedition. Capt. Amundsen always maintained that his aims were scientific, and that he had no desire merely to reach the North Pole. It is not, therefore, probable that he will return this year, since the coast of Siberia along which the *Maud* has sailed has been explored in recent years by Russian expeditions. The *Maud* is provisioned for another three years.

THE United States National Research Council has appointed a committee on eugenics, under the Division of Biology and Agriculture, consisting of the following members:—L. F. Barker, A. G. Bell, E. A. Hooton, Daniel W. LaRue, Stewart Paton, Raymond Pearl, R. M. Yerkes, H. S. Jennings, and C. B. Davenport (chairman). The committee met on Saturday, March 20, and decided to hold the second International Eugenics Congress in New York City on September 22-28, 1921, inclusive. Dr. Alexander Graham Bell was elected honorary president, Dr. Henry F. Osborn president, Mr. Madison Grant treasurer, and Mrs. Sybil Gotto, secretary of the Eugenics Education Society, in view of her activity in organising the first Eugenics Congress, was nominated honorary secretary of the second Eugenics Congress. The national consultative eugenics bodies in the various countries will be informed of the action of the eugenics committee of the National Research Council and invited to send representatives. A general invitation will be sent to universities in different American countries and in the countries of Europe.

THE president, vice-president, and council of the Royal College of Surgeons in Ireland have elected Prof. G. Elliot Smith to the Mary-Louisa Prentice Montgomery lectureship in ophthalmology. The sub-

ject of Prof. Smith's first lecture will be "The Influence of Stereoscopic Vision on the Evolution of Man." The lecture will be delivered in October next.

AN extraordinary general meeting of the fellows of the Chemical Society will be held at Burlington House on Thursday, April 29, at 5 p.m., to consider the alterations in the by-laws proposed by the council.

THE reorganisation and co-operation of research departments contemplated at the Middlesex Hospital promise to be of great value. In particular the co-operation of such distinguished investigators as Profs. Swale Vincent and McIntosh with Prof. Russ and Dr. Lazarus-Barlow may be expected to direct the investigations of cancer on the broad and general lines so necessary at the present time in this subject. We wish the new arrangements every success.

THE Report of the Salisbury Public Library for 1919-20 describes the arrangements for advancing adult education by means of a series of public lectures. A course of eight lectures was delivered by Mr. F. Stevens on the history of the neighbourhood at various periods. The lectures fell into two groups of four each, prehistoric and early historic, and were illustrated from the collections in the city museum by an inspection of the actual objects and by some five hundred photographs. The course, of which a syllabus is appended, attracted good audiences, and was so financially successful that a substantial balance remains, which is being expended in strengthening the existing collection in the library of books on Wiltshire. The committee may be congratulated on this result, and other public libraries throughout the country may use the report as a suggestion for similar arrangements.

DR. FELIX OSWALD and Mr. T. D. Price announce for publication at an early date a book entitled "An Introduction to the Study of Terra Sigillata, Treated from a Chronological Standpoint." During their excavations at the Roman station of Margidunum, in Nottinghamshire, the authors were impressed by the difficulties inherent in the study of Terra Sigillata, the so-called Samian ware, and especially by the necessity for collecting the many scattered references to the subject in many languages besides English. The importance of the study lies in the historical evidence furnished by this ware, for, apart from inscriptions, no relic of the Imperial age is more important for chronological purposes. Ample materials for the investigation are provided at sites such as Haltern, Hofheim, Newstead, and Niederbieber, which can be dated by historical evidence and from the names of the potters inscribed on their work. As the Gaulish Sigillata is a development of the Italian or Arretine fabric, a short account of this is supplied. The book promises to be valuable for the study of the Roman period in Western Europe.

IN an account of the Apalai Indians of the Amazon (*Museum Journal*, vol. x., No. 3, September, 1919) Mr. W. C. Farabee describes a remarkable form of puberty ordeal. A frame in the shape of a jaguar, possibly an indication of totemism, is made of wicker-

work, and about a hundred wasps or ants are passed through the interstices. The youths, exhausted by a dance which is kept up all day, present themselves before the medicine-man, who applies the wasp-frame to their chests, backs, arms, and legs. Those who scream or show signs of suffering when they are stung are not allowed to continue the ordeal. Those who pass the test are invested with a headdress and flute, and deemed fit for marriage. But more than this is required. The youth must give proof that he is able to support a family by passing the target test of throwing cassava pellets at a circle drawn on a piece of wood, and of shooting arrows from a rapidly moving boat. Girls undergo the ordeal of fasting in seclusion, and their bodies are scarified with the sharp teeth of an animal or fish. They are then dressed in aprons, and use charms to stimulate affection in courtship, in which they take the initiative.

DR. A. M. BLACKMAN discusses in the Journal of the Manchester Egyptian and Oriental Society for 1918-19, recently issued, "The House of the Morning" in Egyptian ritual. The Heliopolitan sun-god Re-Atum was represented by his priests as re-born every morning as the result of his undergoing lustration, which was supposed to be performed by the sun-god himself, assisted by other divinities. The king of Heliopolis, high priest of the sun-god, was regarded as his son and embodiment. The lustral washing of the king-priest took place before he officiated in the sun temple, and as a result of it he was thought to be re-born like his divine prototype. His purification was completed by fumigating him with incense and presenting him with balls of natron to chew. "By being washed or sprinkled with holy water and fumigated with incense, and by the chewing of natron, the king was mysteriously re-born, brought into contact with divinities, and imbued with their unearthly qualities, and his mouth made fit to chant the sun-god's praises and recite the formulæ which accompanied the enactment of the various episodes composing the daily service in the sun temple."

It is well known that in ancient India, as described in the Institutions of Manu, the law-giver, marriage was permitted between members of different castes—a system which was forbidden by later Brahmanical legislation. Mr. Patel, one of the advanced Indian members of the Viceroy's Council, recently introduced a Bill providing that marriages between Hindus of different castes shall be valid. More conservative members opposed the Bill on the grounds that it would undermine the present social system, and that it was opposed to Hindu custom, the potent force which controls Hindu society. It was also pointed out that the enactment of such a law raised the wide questions connected with succession, adoption, and legitimacy, for which no legislation was provided in the Bill. The Government representative, Sir W. Vincent, adopted a neutral attitude, admitting that the question should be decided by public opinion carefully devoted to its consideration. If the Bill is finally passed it will be a serious blow to caste, but it is

significant of the general feeling that the Moham-medan members refused to sit on the Special Committee appointed to consider it on the grounds that the question was one for Hindus, and that the latter had been obstructive on the grant of communal representation for Dacca University.

THE history of science is rapidly acquiring its own periodical literature. Dr. Sarton in a recent issue of *Isis* set forth a bibliography of reviews and collections on this subject, of which he recognised sixty-two. Most of these deal with special sciences, among which mathematics and medicine take first place. Several journals are, however, devoted to the history of science as a whole. The earliest was the *Archiv für Geschichte der Naturwissenschaften*, which has appeared since 1908. Next came *Isis*, the publication of which was interrupted by the war; it has now recommenced, and will in future be in English and under the joint editorship of Dr. Sarton and Dr. Singer. The Italians have now also started a quarterly, *Archivio di Storia della Scienza*. It is edited by Prof. Aldo Mieli, who has long devoted himself exclusively to the history of science, and has printed the first volume of a monumental work on the subject. It is encouraging to historians of science that his enthusiasm has overcome the economic and social difficulties that prevail in his country, and that the publication of the *Archivio*, begun in March, 1919, is now being continued. In addition to original articles on every aspect of the history of science, it will contain reviews, a bibliography of Italian works on the subject, and notices on activities in connection with it, which are very pronounced in Italian universities. The annual subscription to the *Archivio* is 35 lire, and it should be sent to Attilio Nardecchia, Via dell' Umiltà 14, Roma 19. Information concerning *Isis* can be had from Dr. George Sarton, Carnegie Institution, Washington, D.C., U.S.A., or from Dr. Charles Singer, Westbury Lodge, Norham Road, Oxford.

MISSes BLACKLOCK and Carter contribute to the *Annals of Tropical Medicine and Parasitology* (vol. xiii., No. 4, March, 1920) papers on a mosquito, *Anopheles plumbeus*. The bionomics of this species are probably less known than those of any European Anopheline mosquito. The species is widely distributed, being met with in the British Isles, in nearly all European countries, and in the Western Himalayas, and is essentially a tree-hole breeder. Experimental evidence is produced for the first time that *A. plumbeus* is capable of becoming infected with a malaria parasite, and may therefore transmit malaria.

A SUGGESTIVE review of the pathology and symptomatology of beri-beri is contributed by Dr. F. M. R. Walsh to *Medical Science: Abstracts and Reviews* (vol. ii., No. 1, April, 1920). The current hypothesis of the nature of beri-beri (a disease particularly of the East characterised by the development of neuritis) is that it is a "deficiency disease," due to the lack of certain elements or "vitamines" from the food. Dr. Walsh points out that the neuritis of beri-beri is similar to that produced by certain poisons, such as

alcohol and the diphtheria poison, and that neurologically we are dealing with no negative or defect disease, but with a definite, positive reaction of the nervous system to some unknown poison. "We know nothing of what happens in the body from the eating of a vitamine-free diet to the moment when the symptoms of beri-beri appear, and we cannot exclude the possibility that such a poison has been produced in the body." Dr. Walshe seems to agree with Eijkman that the ultimate cause of beri-beri may yet prove to be a nerve poison produced by a disordered metabolism arising out of vitamine deprivation.

A "FLORA of the District of Columbia and Vicinity," by A. S. Hitchcock and P. C. Standley, with the assistance of other Washington botanists, has been issued as vol. xxi. of Contributions from the United States National Herbarium (329 pp., 42 plates). It will replace Lester Ward's "Guide to the Flora of Washington and Vicinity," published in 1881, to which there have been six supplements. The area included is approximately a circle of fifteen miles radius, with the Capitol as the centre. The list includes all indigenous plants and all introduced ones that have become established; chance introductions are mentioned in notes appended to an allied species or genus. It is interesting to note that parts of this area are still almost wholly unexplored botanically, and the publication of the flora will afford an excellent opportunity for local botanists to supply the gaps. The arrangement is in the form of keys to the families, genera, and species, which have been carefully worked out, and also tested in the field during one collecting season; and the text is clear. An effort has been made to use common words so far as possible as substitutes for technical terms, and so-called popular names are provided for most species in the manner familiar to British botanists in Bentham's "Handbook." The Old World botanist will find some familiar plants hidden under strange names, as, for instance, *Dicentra* and *Negundo* (box-elder), which appear as *Bikukulla* and *Rulac*. The plates are a series of good photographic reproductions of aspects of the vegetation and of some of the commoner species. Unfortunately, the size of the book, large octavo, militates against its use as a pocket companion for the field botanist.

MR. J. F. N. GREEN (Proc. Geol. Assoc., vol. xxx., p. 153, 1919) has treated in his presidential address to the Geologists' Association the vulcanicity of the Lake District from a natural history point of view. He illustrates the use of petrographic details as a means of realising the conditions of intrusion and eruption, as when he pictures the scoria-cones of Borrowdale age rising above the sea and contributing their materials to the sediments by ordinary processes of erosion. He urges that the chemical analysis of an igneous rock is by itself of little value, since it cannot take into account the evanescent constituents of the magma.

FORAMINIFERA as a group always have their fascination owing to their irresolvable simplicity of organic structure and their apparent powers of selection in the up-building of their coverings. Mr. J. A. Cush-

man (Proc. U.S. Nat. Museum, vol. lvi., p. 593, 1919) describes "Recent Foraminifera from off New Zealand," including a new species of *Technitella*, a genus that forms its test of neatly arranged acicular sponge-spicules. In Bulletin 676 of the U.S. Geological Survey the same author describes Pliocene and Miocene species from the coastal plain of the United States, and shows how they help to indicate former marine climatic conditions. Mr. Cushman's wide knowledge of recent Atlantic forms renders even brief notes of this kind suggestive to the geologist.

REFERENCE has been made in NATURE (vol. xcv., p. 216) to the replacement of quartz by pyrite. A very remarkable case is now put forward by Mr. W. H. Collins in the Summary Report of the Canadian Geological Survey for 1918 (part E, p. 20, 1919) from the Michipicoten district of Ontario. The basement beds of stratified sands and gravels belonging to the Pleistocene drift, and resting on the Keewatin iron-bearing series, have apparently been replaced by "snow-white granular silica" (presumably quartz) with a deposit of loose pyrite grains below resembling ordinary sand, and sometimes 5 ft. thick. Mr. Carus-Wilson, it may be remembered, has cited a case of the replacement by pyrite of the carbonaceous cement of an Eocene sandstone (NATURE, vol. lxxviii., p. 436); but in the Canadian instance the sand-grains themselves have disappeared under the influence of solutions draining along the unconformable junction from the adjacent iron range.

THE Summary Report of the Mines Branch of the Department of Mines of Canada for the year 1918 has just been issued, and contains an interesting record of the year's activities. The fuel-testing station has been engaged, in addition to its regular routine work, upon an investigation on the carbonisation and briquetting of lignite, which promises to yield important results, as also does a test of New Brunswick oil shale in a novel type of retort—the Wallace retort. The methods adopted in Canada may be studied with advantage by those engaged in the study of carbonisation problems in this country. Good work is also being done in the ore-dressing division; until the middle of the year this had been engaged on the production of molybdenite concentrates on a working scale in view of the Empire's requirements of ferro-molybdenum for war purposes; afterwards, however, the normal working of the division was resumed and a variety of ores was tested and reported upon, the methods used being not only the ordinary wet-dressing methods, but also flotation (in a Callow cell), magnetic separation, electrostatic separation, and cyanidation. The Mines Branch may fairly be congratulated upon an excellent year's work, which must form a powerful factor in the development of the mineral resources of the Dominion.

IN the March issue of the *Decimal Educator*, a quarterly publication of the Decimal Association, there is an interesting historical account of the International Bureau of Weights and Measures at Sèvres, the establishment at which the international prototypes of the metre and the kilogram are preserved.

It is pointed out that the investigations at the Bureau have led to a vast improvement in the constancy and trustworthiness of thermometers and in the measurement of atmospheric pressure, and it is proposed to describe in future issues the instrumental equipment of the Bureau and the metrological work undertaken there. A good portrait is given of Dr. Guillaume, the director of the Bureau, who is to deliver the Guthrie lecture to the Physical Society to-morrow, April 23. In an article on the metric system it is urged that, in addition to teaching the system in schools, the Government should set a lead by adopting it in Departments such as the Post Office, the Ministry of Health, and the Royal Air Force, thus familiarising the public with metric measures and preparing the way for a change which is inevitable. Another feature of the number is an explanation of the advantages of decimal coinage.

A SUMMARY of the weather for the year 1919 has recently been issued by the Meteorological Office. It deals very fully with the annual results of the several elements for numerous representative stations for the several districts of the British Isles. The year was generally dry, and was noteworthy for the heavy snowstorm on April 27-28, and for the exceptionally cold March and November. October, which is normally the wettest month of the year, was in many places the driest. The mean temperature for the year was below the normal in all districts, the deficiency ranging from 1.6° F. in East Scotland to 0.4° F. in the south of Ireland. The earth temperatures were also below the normal, both at 1 ft. and 4 ft. below the surface. Rainfall was in excess in the eastern districts and deficient in the western districts. Sunshine was mostly in excess of the normal except in some of the eastern districts. Data are given showing the warmest day and warmest night, also the coldest day and coldest night, for the several stations of the different districts, and there are similar details for the several months. Monthly frequencies of sunshine for selected stations are shown. Days in the year with rainfall between fixed limits are given for selected stations, and the number of days in the year with certain maximum and minimum temperatures. Many and various particulars of anemograph observations are given, with the frequency of hours with average wind speed, also with a maximum hourly speed. A table shows the frequency of winds of various strengths from different directions for several stations in different parts of the British Isles. Much of the data is in a form which will be available for aviation requirements.

THE February and March issues of the Journal of the Franklin Institute contain the report of the committee—consisting of Messrs. E. P. Hyde, P. W. Cobb, H. M. Johnson, and W. Weniger—of the Nela Research Laboratory which undertook the investigation of the relative merits of monocular and binocular field-glasses under Service conditions. The tests are not yet completed, but already afford a large amount of valuable information. The principal conclusions of the eighty pages of the report are that in the hands

of not very experienced observers the monocular requires to have a magnification of 6.27 in order to give the same results as a binocular of the usual magnification of 6.0. As regards rapidity of production and adjustment, cost, weight, portability, and ease in use the monocular is far ahead of the binocular. The report deserves careful consideration by optical-instrument makers in this country.

IN an article in the April issue of *Science Progress* Major A. E. Oxley summarises his work on the magnetic properties of about forty organic compounds between  $-180^{\circ}$  and  $200^{\circ}$  C., and shows that atomic theories of the Rutherford-Bohr type, which neglect magnetic forces, are incapable of accounting for many of the magnetic properties of matter. How these theories are to be modified he is not yet in a position to say, but his diagram of two atoms held together by electromagnetic forces shows these forces to be due to a pair of oppositely directed circular currents in each atom outside the positive nucleus and rotating electrons. This idea is on the same lines as those put forward recently by Parsons (1915) and Langmuir (1919). The author points out finally that an adequate theory must account for the molecular structure of crystals, and the relations between that structure and their behaviour in the magnetic field must agree with stereochemistry, give the additive property of diamagnetics, and show no dielectric hysteresis. It is to be hoped that the forthcoming discussion on the subject of atomic structure at the Royal Society will throw some light on these difficulties of present theories.

AN important paper on the magnetic characteristics of the iron core of a transformer or of an induction coil by the late Prof. B. Osgood Peirce is published in the Proceedings of the American Academy of Arts and Sciences (vol. 1, No. 7, p. 149). Sixty years ago Helmholtz verified the predictions of the mathematical theory of a transformer. The verification, however, was limited to the case when the inductances of the two coils were constant. With an iron core—the case considered by the author—this assumption is not justified. He first tried the loading coils which are used in long-distance telephony. The cores of these coils are made of iron wire only one-tenth of a millimetre in diameter. The eddy currents induced in the core are therefore negligibly small. Assuming merely the connection between the ampere-turns and the magnetisation and Faraday's law for the electromotive force induced by a change in the magnetic induction, Prof. Peirce found that the experimental results agreed with those deduced from theory to within about the tenth part of 1 per cent., i.e. to within the limits of experimental error. Even with the ordinary closed iron circuit commercial transformer he found that the predictions of theory were verified to high accuracy when the eddy currents in the core could be neglected. It was concluded that a good approximation to the shape of the current curves, to the rate of growth of the excitation, and to the flux, of the magnetic induction in the core of a transformer can be obtained when an accurate statical hysteresis diagram of the core over the given range is available.

### Our Astronomical Column.

**OCCULTATION OF A STAR BY SATURN.**—Bad weather prevailed generally in Europe on March 14, when Saturn occulted the star Leipzig I 4091, mag. 7.6. A few observations were, however, secured, some of them being published in *Astr. Nach.*, 5042. Prof. Plassmann observed the disappearance at Münster, noting that at 7h. 30m. G.M.T. the star was still separated from the limb, at 7h. 51m. it was in contact with it, while at 7h. 59m. the star had disappeared.

Messrs. K. Novak and V. Rolcik, observing at Smichow, long. oh. 57m. 38s. E. Gr., lat.  $50^{\circ} 4' 42''$  N., noted the reappearance at 8h. 39m. 40s. G.M.T.

Dr. Bernewitz, at Berlin-Babelsberg Observatory, first saw the star at 8h. 39m. 34s. G.M.T. He noted that at 8h. 39m. 51s. it appeared of full brightness, and at 8h. 40m. 5s. the centre of its disc was distinctly separated from the limb. He states that the marked red colour of the star made it easy to distinguish its light from that of the planet. He made the only observation so far to hand of the appulse of Titan to the star, which occurred some four hours after emersion from the planet. He states that Titan did not occult it, but passed  $1''$  or  $2''$  to the north of it.

The extreme accuracy of Mr. Burnet's prediction is noteworthy. He gave 7h. 5m. for the disappearance, and 8h. 40m. for the reappearance. Owing to the slowness of Saturn's motion, he thought it likely that these times would be in error by several minutes.

**THE EINSTEIN DISPLACEMENT OF SPECTRAL LINES.**—The *Observatory* for April contains communications on this subject by Messrs. J. Evershed and C. E. St. John. The former gives reasons for thinking that the pressure in the photosphere is extremely low, so that pressure may be eliminated as a disturbing factor. Using forty-two iron lines, selected as not subject to pole effect, he obtains a shift equivalent to a recession of 0.643 km./sec. at the sun's centre and 1.000 at the limb. But observations of Venus at various elongations support the idea that this is not an Einstein effect, but a shift of all regions of the sun away from the earth. It is remarked that it is difficult to accept this as a physical reality, but no other explanation has yet been found. He notes that some of the carbon lines give an effect similar to the iron ones, but somewhat smaller. The effect seems to vary for different substances, and even for different lines of the same substance, so that some modifying influence is at work.

Mr. St. John recapitulates his well-known investigation, in which he used certain lines of the cyanogen band; he then describes his recent work on magnesium and iron lines. He finds from their weighted mean a displacement of the same sign as the Einstein prediction, but of only one-third or one-fourth of its amount. Mr. St. John notes, however, that the displacement varies with the intensity of the lines, being greatest for lines either of very great or very small intensity. As the majority of the lines measured are of medium intensity, the weighted mean is reduced. He also notes that no lines have been used which seemed unsuitable for the purpose, owing either to their proximity to others or to their instability in the arc spectrum.

**STELLAR SPECTROSCOPY AT THE DETROIT OBSERVATORY.**—Vol. ii. of the Publications of this observatory, belonging to the University of Michigan, has lately been distributed, and contains a great number of interesting studies of stellar spectra. Two may be instanced in particular: the study of variable stars of Class Md, by Mr. Paul W. Merrill, traces the changes of spectra that accompany the change of

light, and discusses various suggestions of the cause of variability. The one favoured by the author is somewhat analogous to the "geyser" theory, but, instead of imagining a solid or viscous crust imprisoning the gases within, he substitutes a smoke-veil composed of condensing gases (calcium is especially suggested) in the upper regions of the stellar atmosphere. This would act as a screen confining the heat of the photosphere, until the accumulation of heat sufficed to vaporize the screen. When the solid-crust theory was propounded these stars were thought to be near the end of their careers as suns, but from the smallness of their proper motions it now appears that they are mostly giants.

The other paper, by Mr. Laurence Hadley, deals with the elements of  $\zeta$  Ursæ Majoris, the first spectroscopic binary discovered. The orbit is fully discussed from several series of observations. The period is 20.53644 days, the eccentricity is 0.518, and the masses of the components  $\times \sin^3 i$  are respectively 1.83 and 1.79 in terms of the sun. It is noted that Prof. Joel Stebbins finds no evidence of light variation.

### Meteorology at Hong-Kong.

**MONTHLY** Meteorological Bulletins for the Royal Observatory at Hong-Kong for a considerable period to August, 1919, have recently been received. They contain detailed results of observations made at the observatory and the daily weather reports from various stations in the Far East, prepared under the direction of Mr. T. F. Claxton. For Hong-Kong hourly values are given of barometric pressure, temperature of the air and evaporation, direction and velocity of wind, amount of rainfall, and duration of sunshine. All the hourly observations are measured from the self-registering records. Three-hourly observations are made of the character and direction of motion of the clouds. Daily values are also given of the several meteorological elements. The normals used for comparison with the means are for the years 1884 to 1918, a period of thirty-five years. From 1916 the daily and mean hourly values of the principal meteorological records have been published in both C.G.S. and British units, and with the January Bulletins tables are given for the conversion of the several elements to the respective units. Information is also supplied for the reduction and correction of the instrumental observations. The December Bulletins give tracks of typhoons and depressions in the Far East for the year, and the divergence in the several months is well shown. With the Daily Weather Reports, which contain observations from forty-five stations in the Far East, notices are given of the warning to coast ports, which commonly state the position of typhoons when such are in progress, and forecasts are given daily for the twenty-four hours ending at noon.

The annual report for 1917 contains a comparison of the Beckley anemograph with the Dines instrument, extending over eight years; the differences are remarkably consistent until the summer of 1917, when for some unexplained reason, although noticed, the differences vary. A Richard dry- and wet-bulb thermograph has been set up to replace the Kew photographic thermograph. In section ix. reference is made to sympiesometer observations, and hourly observations are said to have been made for upwards of a year to test the popular belief in the sympiesometer as a weather forecaster. The remarks scarcely seem to refer to a sympiesometer, which was essentially a sailor's barometer in the first half of the nineteenth century. It seems rather that the instrument tested



is a camphor glass or chemical weather glass, long acknowledged to be of no real scientific value. The report for 1918 deals with the corrections to be applied to the readings of an unspirated wet-bulb thermometer in an "Indian" shelter to reduce them to those of an aspirated thermometer at definite wind velocities and for different depressions of the wet bulb. With the lighter wind velocities, of 1-5 m.p.h., and for the larger depressions of the wet bulb, say amounting to 6°-10°, the subtractive correction to the unspirated wet bulb amounts to 1° or slightly more. Three thousand three hundred and seventy-five observations have been dealt with, but as yet no definite scheme has been decided upon. The matter has been considered in correspondence with the British Meteorological Office.

### Milk Production of Ayrshire Cattle.

THE critical genetic study of a character such as that of milk production in cattle, which is highly subject to environmental influences, cannot be carried out effectively until a fairly comprehensive knowledge of the normal variation of the character has been acquired. To this end Prof. Raymond Pearl and Mr. J. R. Miner have carried out a biometrical analysis of the normal individual variation in the milk flow and the fat content of the milk of Ayrshire cattle, the results of which are summarised in a contribution to the *Journal of Agricultural Research* (vol. xvii., No. 6). Their study is based on the records of Ayrshire cattle for the years 1908 and 1909 published in the reports of the Ayrshire Cattle Milk Records Committee of Scotland, more than three thousand records in each year being used for the purpose. Amongst the many important conclusions arrived at mention may be made of the indications that about one-half of the observed variation in milk-production results from the varying genotypic individuality of the animals with respect to this character, the remainder resulting from varying environmental influences. The udder as a secreting organ is compared with the oviduct of a hen, and it is shown that the latter operates with somewhat less variability than the former, having regard to the absolute weight of the product in the two cases.

The change in mean weekly yield of milk with advancing age is found to be represented by a logarithmic curve, the absolute amount of milk produced per unit of time increasing, though at a decreasing rate, with the age of the cow to a maximum, which was found to be when the cow is ten to eleven years old. The mean fat percentage of the milk was found to decline with advancing age until the tenth year of the cow's life, after which it remains about constant.

### The Ignition Points of Liquid Fuels.

IN a paper read before the Institution of Petroleum Technologists on January 20, Mr. Harold Moore described a number of determinations of the ignition point of commercial fuels which are, or might be, used in internal-combustion engines. His ignition meter, somewhat similar in principle to that designed by Holm, consists of a steel block, heated from below, in the upper surface of which a hollow is made to take a crucible of platinum, nickel, or quartz. The air or oxygen supply passes through a hole in the block before entering the crucible, so as to pre-heat it to the temperature of the crucible, which is given by a resistance thermometer placed in a hole drilled in the block near the crucible. A cover to

protect the crucible from draughts is screwed on to the block, and a drop of the liquid fuel is introduced through a hole in this cover and falls on to the bottom of the crucible. After an interval, more or less prolonged, an explosion is heard and a flame seen if the temperature is above the ignition point. This interval may be as long as thirty seconds or more, and there is no doubt that quiet combustion takes place during this period, and such combustion is very marked in the case of ether. On the other hand, the evaporation of the drops of liquid must produce local cooling, and, unless the fuel is quite homogeneous, the ignition point found must in many cases be that of the last portion to evaporate.

But, in spite of certain inherent defects, the method gives a valuable comparative test of different fuels—a test which is quick and easy to apply.

Mr. Moore recommends the use of ordinary compressed oxygen instead of air as giving more concordant results and as having a concentration at atmospheric pressures more nearly like that used in motor engines. Most hydrocarbon liquids tested in air gave ignition points from 100° C. to 200° C. higher than in oxygen; but, curiously enough, Mr. Moore found that in an atmosphere containing 70 per cent. of carbon dioxide and 30 per cent. of oxygen the ignition point of kerosene was almost the same as in pure oxygen. A few ignition points from Mr. Moore's lists may be quoted:

Ignition Point.			
Fuel	In oxygen °C.	In air °C.	
Taxibus spirit (Anglo-American Oil Co.) ... ..	272	396	
Anglo-Persian oil ... ..	254	408	
Anglo-Mexican oil ... ..	259	417	
Normal hexane ... ..	287	—	
Benzene ... ..	620	—	
Ethyl alcohol ... ..	395	518	
Ether (methylated) ... ..	190	347	
Hydrogen ... ..	—	678	In silica crucible

In the case of mixtures of two liquids of very different ignition points the addition of about 20 per cent. of the more easily inflammable liquid suffices to reduce the temperature substantially to that of the lower constituent; for instance, the addition of 20 per cent. of ether (ignition point 206°) to xylol (ignition point 555°) reduced the ignition point of the mixture to 246°.

### Naval Research and Experiment.

TO ensure that the full benefits of science shall be secured to the Naval Service, a Department of Scientific Research and Experiment has been set up under the Third Sea Lord and Controller. As the Scientific Adviser of the Admiralty, and in charge of this Department, Mr. F. E. Smith, F.R.S., has been appointed with the title of Director of Scientific Research. It is the duty of the Department to keep the Navy in touch with outside scientific establishments and to ensure that the work at the various naval experimental establishments proceeds with full cognisance of scientific progress and methods. The Director of Scientific Research will work in close association with the Naval Staff, thus ensuring that naval policy is framed with due consideration of the possible practical applications of scientific progress in relation to naval needs, and enabling requirements as to types and weapons to be formulated with a knowledge of the latest scientific possibilities.

Consultations with outside scientific institutions will be resorted to, both to ensure against overlapping and with the view of utilising such of their researches and experiments as appear likely to prove of value to the Naval Service.

At present there exists under the Department a naval research laboratory at Shandon. This establishment was set up during the war with the primary object of investigating methods of counteracting the enemy's submarine menace. It has performed, and is performing, good service; but Shandon is a great distance from the experimental schools, the various scientific institutions, and the Admiralty, and it has therefore been decided that, so soon as suitable accommodation can be provided elsewhere, such of the work as requires sea environment, together with the scientific *personnel* associated with it, will be removed to a suitable existing naval establishment, and the remainder, which does not in its early stages require a sea environment, will be transferred to a naval research institute. This institute, under the Director of Scientific Research, will adjoin the National Physical Laboratory at Teddington. It will be entirely controlled by the Admiralty, but its close association with the National Physical Laboratory will offer exceptional facilities for co-operation, and the staff of the research institute will have the advantage of personal acquaintance with the work being carried out at the laboratory. The Department of Scientific and Industrial Research will be consulted in all cases when the results of investigations are likely to be of use to the general community.

To ensure effective co-operation and contact with naval thought, naval officers will frequently visit the research institute, and the scientific staff will work for lengthy periods at naval establishments, and at times go to sea

### Education and Science in the Civil Service Estimates for 1920-21.

THE Estimates for Civil Services for the year ending March 31, 1921 (Class IV.: Education, Science, and Art), have now been published. Among the increased grants compared with those of last year are:—Board of Education, 12,983,094*l.*; British Museum, 74,519*l.*; Scientific Investigation, etc., 81,442*l.*; Scientific and Industrial Research, 246,845*l.*; Public Education (Scotland), 2,200,000*l.*; Public Education (Ireland), 185,735*l.*; and Science and Art (Ireland), 20,917*l.* As the Geological Museum and Geological Survey are now under the Department of Scientific and Industrial Research, their grants of 7560*l.* and 30,043*l.* respectively represent part of the increase of 246,845*l.* to that Department. The grant for scholarships, exhibitions, and other allowances to students in technical schools and colleges is increased from 17,460*l.* to 34,350*l.* In addition, there are new grants of 15,000*l.* for scholarships tenable at universities, and expenses incidental to them, and 250,000*l.* to local education authorities for maintenance allowances at places of higher education. The total amount of the grants in aid of universities, colleges, medical schools, and like institutions in the United Kingdom is about 1,000,000*l.*; there is also a special grant of 106,000*l.* for extraordinary expenditure. The grant for assistance towards the higher education of ex-officers and men of like standing is 3,000,000*l.*, compared with 2,000,000*l.* for 1919-20. The grant under the Royal Society shows an increase of 9000*l.*, and includes 2000*l.* for subscriptions to international

research associations. The subjoined summary and details are extracted from the Estimates:—

#### SYNOPSIS.

##### United Kingdom and England.

Board of Education ... ..	£	45,755,567
British Museum ... ..	294,233	
National Gallery ... ..	29,956	
National Portrait Gallery ... ..	9,824	
Wallace Collection ... ..	15,953	
London Museum ... ..	5,412	
Imperial War Museum ... ..	50,000	
Scientific Investigation, etc. ... ..	208,416	
Scientific and Industrial Research ... ..	518,298	
Universities and Colleges, United Kingdom, and Intermediate Education, Wales ... ..	945,700	
Universities, etc., Special Grants ... ..	196,000	
Serbian Relief Fund (maintenance and education of young Serbians in this country) ... ..	25,000	

##### Scotland.

Public Education ... ..	6,877,220
National Galleries ... ..	11,661

##### Ireland.

Public Education ... ..	3,358,371
Intermediate Education ... ..	90,000
Endowed Schools Commissioners ... ..	1,042
National Gallery ... ..	4,650
Science and Art ... ..	211,475
Universities and Colleges ... ..	86,000

58,694,718

#### DETAILS.

##### Scientific Investigation, etc.

Royal Society :

(i) Grant in aid of:—

Scientific investigations undertaken with the sanction of a Committee appointed for the purpose (including non-recurrent grant of 5000 <i>l.</i> ) ... ..	11,000
Scientific publications ... ..	1,000
Subscriptions to international research associations ... ..	2,000
	14,000

(ii) Grant in aid of salaries and other expenses of the Magnetic Observatory at Eskdalemuir ... ..

1,000

Total for Royal Society ... .. 15,000

Royal Geographical Society ... ..	1,250
Marine Biological Association of the United Kingdom ... ..	1,000
Royal Society of Edinburgh ... ..	600
Scottish Meteorological Society ... ..	100
Royal Irish Academy ... ..	1,600
Royal Irish Academy of Music ... ..	300
Royal Zoological Society of Ireland ... ..	500
Royal Hibernian Academy ... ..	300
British School at Athens ... ..	500
British School at Rome ... ..	500
Royal Scottish Geographical Society ... ..	200
National Library of Wales ... ..	12,000
National Museum of Wales ... ..	25,500
Solar Physics Observatory ... ..	3,000
North Sea Fisheries Investigation ... ..	1,250
Imperial Mineral Resources Bureau ... ..	10,750

Royal Academy of Music	500
Royal College of Music	500
Medical Research Council	125,000
British Institute of Industrial Art	5,500
Edinburgh Observatory	2,566

*Department of Scientific and Industrial Research.*

Salaries, wages, and allowances	29,235
Travelling and incidental expenses	1,950
Grants for Investigation and Research:	
(1) Investigations carried out by learned and scientific societies, etc.	13,800
(2) Investigations directly controlled by the Department of Scientific and Industrial Research	40,928
(3) Students and other persons engaged in research	38,300
(4) Expenses of Research Boards for co-ordination of Government research	200,000
Total	293,028

Fuel Research Station	40,882
Geological Museum	7,560
Geological Survey of Great Britain	30,043
National Physical Laboratory <sup>1</sup>	203,000

*Appropriations in Aid:—*

Contributions of co-operating bodies	1,550
Refund of unexpended balance of grants	300
Testing fees at Fuel Research Station	1,000
Sales of by-products at Fuel Research Station	2,500
Testing fees at the National Physical Laboratory, charges for special investigations, and repayments by the Road Board, India Office, etc., for services rendered by the National Physical Laboratory	55,000
Balance of accrued interest at March 31, 1921, on the Fund of the Imperial Trust for the encouragement of scientific and industrial research, for which 1,000,000. was voted in 1917-18	27,050

Total for Appropriations in Aid 87,400

*Universities and Colleges, United Kingdom.*

Birmingham University	35,000
Bristol University	17,000
Bristol Merchant Venturers' Technical College	2,000
Cambridge University, Medical Department	8,500
Durham University	2,000
Durham, Armstrong College	22,000
Durham College of Medicine	3,800
Leeds University	33,000
Liverpool University	40,000
London University	8,000
London, Bedford College	13,000
„ East London College	11,000
„ Imperial College of Science and Technology	52,000
„ King's College, Household and Science Department	4,000
„ King's College, including King's College for Women	25,000

London, School of Economics	10,000
„ School of Oriental Studies	4,000
„ University College	39,000
„ Westfield College	3,000
„ Charing Cross Hospital Medical School	1,000
„ King's College Hospital Medical School	700
„ London Hospital Medical College	6,000
„ Middlesex Hospital Medical School	2,000
„ Royal Dental Hospital, School of Dental Surgery	1,000
„ (Royal Free Hospital), School of Medicine for Women	4,000
„ St. Bartholomew's Hospital Medical School	5,000
„ St. George's Hospital Medical School	700
„ St. Mary's Hospital Medical School	1,900
„ St. Thomas's Hospital Medical School	4,500
„ School of Tropical Medicine	1,100
„ University College Hospital Medical School	4,000
„ Westminster Hospital Medical School	300
Manchester University	40,000
Manchester College of Technology	7,000
Nottingham University College	11,000
Oxford University Engineering Department	500
Reading University College	12,000
Sheffield University	21,000
Southampton University College	5,000

Total England 461,000

University of Wales	6,500
Aberystwith University College	14,000
Bangor University College	14,000
Cardiff University College	18,000

Total Wales 52,500

Edinburgh University	53,000
Glasgow University	48,000
Glasgow Royal Technical College	3,000
Aberdeen University	32,000
St. Andrews University, including Dundee University College	29,000

Total Scotland<sup>2</sup> 165,000

Belfast, Queen's University	8,000
Cork University College	6,000
Dublin University College	10,000
Galway University College	3,000

Total Ireland<sup>3</sup> 27,000

Universities and Colleges, United Kingdom, unallocated grant 210,500

Total for Universities and Colleges, United Kingdom, Grant in Aid<sup>4</sup> 916,000

<sup>1</sup> Services rendered without payment for other Government Departments are estimated as follows: Admiralty, 7,500*l.*; Air Ministry, 40,000*l.*; Ministry of Munitions, 7,000*l.*; War Office, 2,150*l.*; H.M. Office of Works, 500*l.*; Board of Trade, 1,000*l.*; Works undertaken at the instance of the Advisory Council, 8,000*l.*

<sup>2</sup> This sum includes 42,000*l.* payable to Scottish Universities under Section 25 of the Universities (Scotland) Act, 1889, and is in addition to an annual sum of 30,000*l.* payable to these Universities from the Local Taxation (Scotland) Account under Section 2(2) of the Education and Local Taxation Account (Scotland) Act, 1892.

<sup>3</sup> In addition to 84,000*l.* provided in Class IV., 18.

<sup>4</sup> This sum, together with 84,000*l.* provided in Class IV., 18, is intended to raise to 1,000,000*l.* the total amount of the grants paid out of the Exchequer during the year 1920-21 for the maintenance of University Institutions in the United Kingdom.

## The Native Tribes of Western Australia.

AT a meeting of the Royal Anthropological Institute on April 13, Sir Everard im Thurn, president, in the chair, Mr. G. O. Neville read a paper on "The Aborigines of Western Australia: Their Treatment and Care." In introducing the speaker, the president laid stress upon the importance of papers dealing with the practical side of native questions. It was often said that the Government did not assist scientific societies enough, but he was sometimes in doubt whether scientific societies on their side gave sufficient assistance to the Government.

Mr. Neville said that the aborigines of Western Australia were most numerous in the north, diminishing as they came nearer civilisation, until almost extinct where the white man has lived since the early days of occupation. By nature a nomadic race, they live by hunting alone and cultivate nothing. They communicate with each other by means of a cipher, intelligible only to themselves, cut upon message sticks, or *Bambarro*, the bearer of which is granted a safe passage through hostile tribes. Numbers of crude figures, representations of beasts, birds, or reptiles, are to be found drawn in coloured pigments upon flat rocks or inside caves in the far north. The gradual disappearance of the natives continues unceasingly, in spite of constant effort. This is due to change of food, their hunting-grounds being occupied by the squatter, and the necessity for their having to clothe themselves and live more or less under shelter. The aborigines do not believe that any person dies a natural death, but suppose the deceased to have been *bulyaed* (bewitched) by some member of another tribe, and it becomes the duty of a near relative, generally a brother of the dead person, selected by the *Bulyas* or medicine-men, to avenge his death by killing the supposed murderer or another one of the tribe to which the murderer is supposed to belong. One of the most remarkable means of disposing of the dead, known as the stone system, occurs in the north. There the body of the dead person is elevated to a platform of sticks built in a tree, a layer of large stones being placed immediately beneath the body. The stones represent individuals who might have caused the death of the victim; and if the fat from the body, evaporating in the heat of the sun, falls upon any stone, the individual represented by that stone is the one upon whom vengeance will sooner or later fall at the hands of the near relatives of the deceased person. If no fat falls, a near relative will, after the removal of the body to an adjacent ant-heap, where only the bones are soon remaining, sleep upon the pile, and it will be revealed to him in a dream which is the selected stone.

No native can be employed except under a permit issued by a Protector. Generally speaking, the treatment of Western Australian natives at the hands of their employers leaves little to be desired. The Aborigines Act provides the necessary machinery for bringing offenders to book. The Chief Protector being constituted by law the legal guardian of every aboriginal and half-caste child until the age of sixteen, it is possible to remove any child from undesirable surroundings. Some eighty Protectors, under the Chief Protector, are resident in various parts of the State where there are natives. Seventy Government relief stations provide assistance for indigent and destitute natives. The Department owns cattle settlements in Kimberley, and two farming and industrial settlements have been established recently in the south for the reception of indigent and aged people, with special provision for the care and training of orphan children. The reserves upon which these settlements

are established are for the natives only, and whites, other than the staff employed, are rigidly excluded by law. The provision of medical attendance has been the special care of the State; all natives receive free advice, medicine, and hospital treatment in case of sickness. The nine mission stations in Western Australia, nearly all subsidised by the State, have done useful work, especially in the care and rescue of children. Though the people are dwindling away, the work of the Department must go on, in the hope that the last days of a dying race can be made the easier and happier.

In declaring the subject open for discussion, the president said that the cause of the decrease in a native population when it came into contact with civilisation was its failure to adapt its psychological constitution to changed circumstances.

Dr. Corney said that as a result of his experience in dealing with immigrant labour—male only—in Fiji, he had arrived at the conclusion that the type of soil had an important effect on certain groups; for instance, an alluvial soil was fatal to Gilbert Islanders and Solomon Islanders, although the former thrive on sandy soil such as that of the islands on which coconuts were grown, and the latter made excellent sailors. It was also evident that all were peculiarly susceptible to the attacks of micro-organisms from which the European population was to some extent immune, as shown by the virulence of the epidemics of measles and influenza.

Mr. N. W. Thomas pointed out that Pater Schmidt has shown that in the north mode of burial and language coincide in distribution, and asked whether the distribution of drawings also coincided with platform burial and language.

Prof. Arthur Keith said that if we were placed in the Australian desert and asked to live the life of the aborigines, he doubted whether we would survive. Would we not rather die as they die in our environment? When they were brought into contact with our civilisation we asked them to make a jump of perhaps two thousand generations within a lifetime; to change at once from the life of a prince to that of civilisation, the life of a horse in a mill. The governing factor in deciding the fate of native populations lay in the domain of psychology. Here the man of science came into touch with the practical problem, for he was trying to understand the back of the black man's mind.

Miss Freire-Marreco compared the measures adopted in Western Australia with those which had been followed in the United States of America, especially in relation to the dying out of the native races. Until about ten years ago the native races there had diminished rapidly. Since then, however, the Indian population had been on the up-grade, owing largely to the attention paid by the Central Government to the food-supply and the checking of tuberculosis and other diseases by isolation and the inculcation of sanitary and hygienic rules.

## University and Educational Intelligence.

MR. F. A. HERON has given to Queen's University, Belfast, the sum of 5000*l.* to provide the necessary equipment for teaching physical chemistry, and 1000*l.* towards the provision of accommodation for the department.

IN connection with the faculty of medicine of the University of Birmingham, a course of ten weekly lectures (free to medical men) on "Principles of Psychotherapy" is to be given by Dr. W.

McDougall, F.R.S., in the medical school buildings of the University, beginning on Friday, April 30.

THE subject for the Jacksonian prize of the Royal College of Surgeons of England for 1921 is "The Pathology, Diagnosis, and Treatment of Tuberculous Disease of the Spinal Column with its Complications."

APPLICATIONS for not more than three Ramsay memorial fellowships for chemical research will be considered by the trustees at the end of June next. They must be received by, at latest, June 15 by Dr. W. W. Seton, organising secretary, Ramsay Memorial Fund, University College, Gower Street, W.C.1. The fellowships will each be of the annual value of 250*l.*, with, possibly, a grant of not more than 50*l.* per annum for expenses, and tenable for two years, with the possible extension of a year.

DR. J. H. ANDREW has been appointed to the chair of metallurgy in the Royal Technical College, Glasgow, vacant by the transfer of Dr. Desch to the University of Sheffield. Dr. Andrew graduated in Manchester University with first class honours in chemistry. After research work in metallurgy, he received the M.Sc. degree in 1908, and was awarded the Dalton scholarship. He continued metallurgical investigations in the University laboratories until 1914, was appointed research fellow and demonstrator in 1910, and Carnegie scholar of the Iron and Steel Institute. He received the degree of D.Sc. in 1915. Since June, 1914, Dr. Andrew has been chief of the Metallurgical Research Department of Sir W. G. Armstrong, Whitworth, and Co., Ltd., Manchester, and has gained a wide experience in the metallurgical industry, having had unlimited scope for studying practice and for research. His publications include a number of important papers presented to the leading metallurgical societies.

## Societies and Academies.

LONDON.

**Royal Microscopical Society, March 17.**—Prof. John Eyre, president, in the chair.—T. E. Wallis: The Lycopodium method of quantitative microscopy. Various methods have been devised by different workers in an attempt to find a satisfactory method of making determinations of percentage composition by means of the microscope. The most trustworthy of these require specially constructed apparatus and are applicable in certain instances only. The Lycopodium method is simple in principle, and with slight modifications may be used for all kinds of problems. The only apparatus needed is such as is used in ordinary microscopical work. The results are correct to within 10 per cent. of the amount to be determined; they can therefore be utilised with the same confidence as is the case with results obtained by many well-known chemical operations having a similar range of error.—C. Da Fano: Method for the demonstration of the Golgi apparatus in nervous and other tissues. The author has been able to obtain a fairly constant staining of this peculiar intracellular formation by substituting cobalt for uranium nitrate in a formula originally proposed by the Spanish biologist, S. Ramon y Cajal. Da Fano's modification can be easily applied to all sorts of tissues, as proved by an interesting series of quite demonstrative microscopic preparations and lantern slides shown at the meeting. Another step has thus been taken in the study of the "internal apparatus" discovered by Golgi in 1858, the functions of which, however, still remain quite mysterious to biologists and physiologists.

**Linnean Society, March 18.**—Dr. A. Smith Woodward, president, in the chair.—Prof. J. Small: The chemical reversal of geotropic response in roots and stems. It was stated that when roots are placed horizontally in a moist atmosphere rendered very faintly alkaline by ammonia vapour they tend to grow upwards. When stems are treated in a similar way with acetic acid vapour they tend to grow downwards. These experiments form preliminary confirmation of a theory of geotropic curvature which has been elaborated as a correlation of previous work on the electrical conductivity of roots with data accumulated by other investigators.

**Aristotelian Society, March 22.**—Prof. Wildon Carr in the chair.—Clement C. J. Webb: Obligation, autonomy, and the common good. It was contended that the notion of obligation in which Kant rightly found the essential feature of our moral consciousness cannot be directly derived (as Green seems to suppose) from the notion of a "common good"; that, on the contrary, the notion of a "common good," and the closely connected notion of a "general will," derives its significance for ethics, and eventually for politics also, from its connection with the notion of obligation; and that this makes it necessary for any truly ethical conception of the State to retain the idea of "authority," as ascertained, indeed, through the general will, because only thus can it be recognised as authority—viz. the community for itself; not, however, as in itself merely the result of the general will, but as the expression of an absolute factor therein, which perhaps may be best described as the sovereignty of God. To the thought expressed in Kant's choice of the word "autonomy" to express the status of the good will may be traced along one line of descent the anti-authoritarian tendency in contemporary ethics and politics.

**Geological Society, March 24.**—Mr. R. D. Oldham, president, in the chair.—Mrs. Eleanor M. Reid: Two pre-Glacial floras from Castle Eden (County Durham). The seeds examined were obtained by Dr. C. T. Trechman from pre-Glacial clays, found in fissures of the Magnesian Limestone at Castle Eden. The clays were carried by the Scandinavian ice from the area now covered by the North Sea. The study proved the presence of two seed-bearing clays of different ages, the earlier being undoubtedly Pliocene. The Pliocene age is confirmed by M. P. Lesne, who determined the insect remains found intermingled with the seeds. While the work was in progress material from the base of the Pliocene of Pont de Gail (Cantal) gave knowledge for the first time of a seed flora of known age, low down in the Pliocene; it showed that the rate of change in the character of the West European Pliocene flora was slower than had been suggested by Clement Reid and the author. A critical comparison was made between the Cromerian, Teglian, Castle Eden, Reuverian, and Pont de Gail floras on the bases of the percentages of all exotics, and of Chinese-North American exotics—that is, plants now inhabiting the Far East of Asia or North America, but not Western Europe—in each flora. The result proved the Reuverian to be Lower Pliocene, not top of the Middle Pliocene (as formerly suggested), and the Castle Eden flora to be Middle Pliocene. Therefore a study of fossil seeds had made it possible to discriminate between strata intimately mixed *in situ*, and to determine their geological age when unknown.—Mrs. Eleanor M. Reid: A comparative review of Pliocene floras, based on the study of fossil seeds. By plotting as a curve the percentages of all exotics, and of Chinese-North American exotics, from the five floras (see above paper), it was found that all lay

along a smooth curve, part of which indicated changes in the Pliocene and part in the Miocene. From this curve certain deductions are drawn, namely: (1) The study of living and fossil seeds can lead to accurate specific determinations. (2) The study of fossil seeds is as accurate a method of determining geological age as is palaeontology, and the age indicated for the Reuverian and Castle Eden floras is approximately correct. (3) The destruction and supplanting of the Chinese-North American exotic flora began about the Middle Miocene, at the time when the great European and Asiatic Alpine ranges attained their maximum uplift; but it was to these trans-continental barriers that Clement Reid and the author attributed the extermination of this flora. Therefore, the curve gives strong and independent confirmation of the truth of their theory, and is in accord with the findings of stratigraphy and palaeontology. (4) The curve indicates an incoming flora—the present flora of Western Europe and, in part, of Central and Southern Europe—which first appeared in the Miocene. Of this the aquatic element is now chiefly circumpolar in distribution, whereas the dry-soil element mainly centres in the Himalayas. (5) The incoming flora only in part survived in Western Europe; the destruction became greater after the Middle Pliocene; the cause of this is unknown.

## CAMBRIDGE.

**Philosophical Society**, February 23.—Mr. C. T. R. Wilson, president, in the chair.—Prof. Seward: The origin of the vegetation of the land. A brief consideration of questions raised by Dr. A. H. Church in a recent memoir on "Thalassophyta and the Sub-aerial Transmigration" (Oxford, 1910). "The beginnings of botany are in the sea." Life evolved from the ionised water of a continuous world-ocean two miles in depth. The plankton epoch; unicellular, free-floating plants. The Benthic epoch was initiated when portions of the earth's crust rose to within the reach of light and plants were able to establish themselves on the ocean-floor. Development during the Benthic epoch of complex anchored marine plants. The epoch of the land flora began with the emergence of areas of land and the transference of plants from the hydrosphere to the atmosphere.

## MANCHESTER.

**Literary and Philosophical Society**, March 2.—Sir Henry A. Miers, president, in the chair.—W. J. Perry: The search for gold and pearls in Neolithic times. Further research on the distributions of early sites of civilisation and of the sources of gold and pearls has produced a mass of evidence to substantiate and enlarge the thesis of an earlier paper by the author on "Megalithic Monuments and Ancient Mines." The evidence now suggests that not only megalithic monuments, but also early sites in general, marked the settlements of seekers after gold and pearls, amber and purple having also played their part in attracting strangers. These settlements are mostly localised in the basins of rivers containing gold or pearl-bearing mussels, and the distribution map shows that the early seekers for these objects did not allow much to escape them. Further inquiry will be necessary in order to determine the precise age when this search began.—C. L. Barnes: Einstein's theory of space and time.

## EDINBURGH.

**Royal Society**, March 1.—Prof. F. O. Bower, president, in the chair.—Prof. J. C. Ewart: The nestling feathers of birds. This paper embodied certain facts of observation in regard to the development of nestling feathers which did not harmonise with

the view generally taken that feathers were originally developed out of scales. Three facts of fundamental importance should be borne in mind: (1) The geological record has hitherto told us nothing about the evolution of feathers; (2) the embryological record affords no evidence in support of the view that scales grew longer and lighter and, after much spreading and splitting, became feathers; and (3) the true feathers of modern birds are, as a rule, derived from small umbels consisting at the outset of barbs, which result from the splitting of the intermediate layer of cells of a simple dermic papilla similar to the papillae of the tongue of ducks. A study of simple nestling feathers (prepenæ) leads one to believe that the plumage of primeval birds consisted of umbels (protoptiles) which differed but little from the bundles of hair found in the jerboa and certain other mammals, or of umbels consisting of barbs armed with barbules, as in the feathers forming the first nestling coat of penguins, or of feathers with practically all the structures now associated with true feathers. In course of time feathers of a different type were evolved, which, as they grew, pushed from the skin, and for a time carried on their tips the feathers of the first generation. The second kind of feathers (mesoptiles) are now well represented in penguins and in the emu, and a remnant is still found in ducks and geese; whether the body of *Archæopteryx* was clothed with protoptiles or with mesoptiles or with plumose feathers it is impossible to say. When all the facts recently established by a study of the development of feathers are duly considered, there is no escape from the conclusion that the wing-quills are only highly specialised nestling feathers, and that it is inconceivable that the first nestling feathers were formed out of scales.—Dr. J. M'Lean Thompson: New stellar facts and their bearing on stellar theories for the ferns. In order to know how the complicated vascular system of adult ferns came into existence, knowledge of individual development was necessary. This has now been traced by sections in a number of specially chosen cases, and the results reconstructed into diagrams showing the individual advance. This involves the formation of a pith, inner phloem, inner endodermis, and frequently, in the early stages of development, pockets of outer endodermis. These tissues are new creations within the vascular system formed by a static change of quality of the elements from the growing point. The solenostele and other higher forms of the vascular system arise by further modification of the structures thus acquired. This involves the formation of gaps in the vascular system, through which the pith and cortex, originally distinct, unite to form one continuous tissue. The ferns dealt with range from the primitive *Schizæaceæ* to the advanced *Pteridææ*.—Sir Thos. Muir: Note on Pfaffians with polynomial elements.

## PARIS.

**Academy of Sciences**, March 22.—M. Henri Deslandres in the chair.—A. Lacroix: The eruptive rocks of the Pyrenees Cretaceous and the nomenclature of the modified eruptive rocks.—G. Bigourdan: The pupils of the Observatory of the Collège de France. The observatories of the Military School.—F. E. Fournier: General expressions for the resistance of water to the passage of ships floating in open air and for the wavelength of their satellite surge.—A. Haller and R. Cornubert: The constitution of the dimethylcyclohexanone obtained by methylation of the sodium derivative of  $\alpha$ -methylcyclohexanone. From a study of the condensation products with benzaldehyde it is concluded that the dimethylcyclohexanone is unsym-

metrical.—**H. Lecomte**: The tier-like structure of certain woods.—**P. A. Dangard**: The structure of the plant-cell and its metabolism. A critical discussion of the views of Guillaermond.—**M. Maxime Laubeuf** was elected a member of the division of the applications of science to industry.—**N. E. Nörlund**: A theorem of Cauchy.—**Ch. Fremont**: Work done in sawing metals by hand. A diagram and description of a pendulum support and guide for a hack-saw. There is an economy of about one-third of the labour.—**J. Vallot**: The calibration in calories of two actinometers adapted to studies in heliotherapy and agricultural climatology.—**J. Guillaume**: Observations of the sun made at the Observatory of Lyons during the fourth quarter of 1919. Observations were possible on sixty-six days during the quarter, and the results are tabulated, showing the spots, their distribution in latitude, and the distribution of the faculæ in latitude.—**M. de Broglie**: The K absorption bands of the rare earths for the X-rays.—**P. Boucherot**: Electrical resonance in a circuit the self-inductance of which contains iron.—**C. Chêneveau** and **R. Audoubert**: A nephelometer.—**P. Job**: The constitution of two cobaltamines.—**J. Guyot** and **L. J. Simon**: The combustion by mixtures of sulphuric and chromic acids of organic bodies containing chlorine. Whilst the combustion of hydrocarbons by the wet method is nearly always incomplete, out of nine chlorinated hydrocarbons seven gave correct figures for carbon and only two, pentachloroethane and hexachloroethane, gave low results.—**C. A. Kiénas**: The hydrocarbon zone of Western Greece. Sixteen points are marked on a map of Western Greece where indications of oil, bituminous schists, or asphalt have been found.—**P. Fallot**: Observations on drift phenomena in the centre of the Sierra de Majorca.—**C. Störmer**: The absorption of the penetrating corpuscular rays in the earth's atmosphere following non-rectilinear trajectories.—**G. Reboul** and **L. Dunoyer**: The utilisation of cirrus clouds for weather prediction. Rules are given for weather forecasts based on the appearance of cirrus clouds, their displacement and amount. Results of the application of these rules to weather predictions are compared with the observed weather.—**V. Bjerknæs**: The temperature of the upper layers of the atmosphere.—**G. Nicolat**: The respiration of plants carrying parasitic fungi.—**H. Coupin**: The time taken by chlorophyll to develop its maximum intensity in the light.—**P. Portier**: Modifications of the testicle of birds under the influence of a diet free from vitamins.—**J. Athanasu**: The supposed dynamogenic power of alcohol. There is no evidence of increase of muscular power at any period of time after ingestion of alcohol. The experiments described afford a further proof that alcohol is not a food utilisable by the organism.—**J. E. Abelous** and **L. C. Soula**: The action of secretin upon metabolism.—**F. Diénert**: The formation of activated sludge.—**A. Fernbach** and **M. Schoen**: New observations on the biochemical production of pyruvic acid. During the fermentation of sugar by yeast in a solution maintained neutral by chalk an appreciable quantity of pyruvic acid is formed.—**J. Legendre**: The rôle of domestic animals in the defence against malaria.

## ROME.

**Accademia del Lincei**, Class of Physical, Mathematical, and Natural Sciences, January 18.—**Prof. A. Röti**, vice-president, in the chair.—**O. M. Corbino**: A laboratory method for the production of continuous and constant electric currents of high tension.—**G. Ciamician** and **C. Ravenna**: Influence of some organic substances upon the development of plants (iv).—**A. Angeli** and **C. Lutri**: Chemical researches on the melanins of pyrrole.—**Q. Majorana**: Gravitation (vi).

A continuation of previous researches (1918) on a rather sensational subject, namely, the screening off of gravitation by a massive spherical sheet (in practice, about 100 kg. of mercury placed between two concentric spheres). Last May the author found, or at least believed he had found, a positive effect, e.g. a just discernible diminution of the weight of a sphere of lead placed within the cavity of the said sheet; but later he found a slight increase in the weight instead. In the present note the author gives some further details about the improvement of his apparatus, and discusses possible perturbations of thermal and mechanical origin. The net results of his search for a gravitational screening effect are so far inconclusive.—**F. Bottazzi**: Researches on the posterior salivary gland of Cephalopodes (iii). This note deals with the independence of secretive activity of the presence of free oxygen.—**E. Bompiani**: Metrical invariants and covariants with respect to surface deformations of higher order (species) (iii).—**A. Rosenblatt**: A theorem of Liapounoff (to be published in the next issue of the *Atti*).—**L. Tonelli**: Primitive functions. An old mathematical subject re-inaugurated about twenty years ago by Lebesgue and others.—**E. Zavattiero**: Relation between the resistance and stress in bismuth.—**C. Ravenna**: Preliminary note on the synthesis of a peptide from aspartic acid with vegetable enzymes.—**G. Sani**: Arbusterine and its derivatives.—**L. Bernardini**: Nicotine in tobacco. A contribution to the study of the genesis and the functions of alkaloids.—**E. Pantanelli**: Influence of nutrition and radical activity upon collapse produced by cold.—**A. Trotter**: The supposed parthenocarp of the hazel-nut and its possible characters (ii). Results of observation and experiments are given.

L. SILBERSTEIN.

## Books Received.

- An Introductory Course in Quantitative Chemical Analysis. By Prof. G. McPhail Smith. Pp. x+206. (New York: The Macmillan Co.; London: Macmillan and Co., Ltd.) 9s. net.
- New Zealand Plants and their Story. By Dr. L. Cockayne. Second edition. Pp. xv+248. (Wellington, N.Z.: Dominion Museum.) 7s. 6d.
- The Buzzard at Home. By A. Brook. Pp. 15+12 plates. (London: Witherby and Co.) 3s. 6d. net.
- A Synoptical List of the Accipitres (Diurnal Birds of Prey). By H. Kirke Swann. Part iv. Pp. vi+115-64. (London: J. Wheldon and Co.) 4s.
- Trattato di Chimica Generale ed Applicata all'Industria. By Prof. E. Molinari. Vol. ii. Chimica Organica. Parte prima. Terza edizione. Pp. xix+624. (Milano: U. Hoepli.) 28 lire.
- The Principles of Ante-natal and Post-natal Child Physiology, Pure and Applied. By W. M. Feldman. Pp. xxvii+694+6 plates. (London: Longmans and Co.) 30s. net.
- Calcutta University Commission, 1917-19. Report. Vol. xiii. Evidence and Documents. Statistics relating to Colleges. Pp. xii+221. (Calcutta: Supt. Government Printing, India.) 18 rupees.
- Year-book of the Royal Society of London, 1920. Pp. iv+236. (London: Harrison and Sons.) 7s. 6d.
- Hydration and Growth. By Dr. D. T. MacDougall. Pp. vi+176. Fluorescence of the Uranyl Salts. By E. L. Nichols, H. L. Howes, and others. Pp. 241+1 plate. Experiments in the Breeding of Cerions. By P. Bartsch. Pp. 55+59 plates. Contributions to Embryology. Vol. ix. Nos. 27 to 46. A Memorial to Franklin Paine Mall. Pp. v+54+plates. (Washington: Carnegie Institution of Washington.)

Butter and Cheese. By C. W. Walker Tisdale and J. Jones. Pp. ix + 142. (London: Sir Isaac Pitman and Sons, Ltd.) 2s. 6d. net.

Panchromatism. Second edition. Pp. 32 + x plates. (Ilford: Ilford, Ltd.) 6d.

Photography and its Applications. By W. Gamble. Pp. xii + 132. (London: Sir Isaac Pitman and Sons, Ltd.) 2s. 6d. net.

## Diary of Societies.

### THURSDAY, APRIL 22.

ROYAL INSTITUTION OF GREAT BRITAIN, at 3.—S. Skinner: The Tensile Strength of Liquids.

ROYAL SOCIETY, at 4.30.—Prof. W. E. Dalby: Researches on the Elastic Properties and the Plastic Extension of Metals.—H. W. Hilliar: Experiments on the Pressure Wave thrown out by Submarine Explosions.—E. F. Armstrong and T. P. Hilditch: A Study of the Catalytic Action at Solid Surfaces. III. The Hydrogenation of Acetaldehyde and the Dehydrogenation of Ethyl Alcohol in the Presence of Finely Divided Metals. IV. The Interaction of Carbon Monoxide and Steam as conditioned by Iron Oxide and by Copper.—Dr. T. R. Merton: The Structure of the Balmer Series of Hydrogen Lines.—Prof. H. A. Wilson: Diamagnetism due to Free Electrons.

LONDON MATHEMATICAL SOCIETY, at 5.—G. T. Bennett: The Three-bar Semic Curve.—S. Chapman and G. H. Livens: The Influence of Diffusion on the Propagation of Sound Waves in Air.—W. P. Milne and D. G. Taylor: The Relation between Apolarity and the Pippian-Quippian Syzygy.—G. H. Hardy and J. E. Littlewood: Some Problems of Diophantine Approximation; The Lattice-points of a Right-angled Triangle.

INSTITUTION OF CIVIL ENGINEERS (Students' Section), at 6.—C. M. Brain: Compression Refrigeration.

### FRIDAY, APRIL 23.

ROYAL SOCIETY OF MEDICINE (Study of Disease in Children Section), at 4.30.—Dr. D. H. Paterson: Three Cases of Renal Dwarfism.—Dr. Parkes Weber: Remarkable Example of Suprarenal Tumour in a Child, of the Robert Hutchison Type (?).—(Epidemiology and State Medicine Section), at 6.30.—Dr. E. W. Goodall: Typhus in Poland, 1916-19.

PHYSICAL SOCIETY, at 5.—M. C. E. Guillaume: The Anomaly of the Nickel-Iron Alloys: Its Causes and its Applications (Guthrie Lecture). INSTITUTION OF MECHANICAL ENGINEERS, at 6.—The late W. J. Lineham: (1) The Hardening of Screw-Gauges with the Least Distortion in Pitch (referring to Water Hardening). (2) The Hardening of Screw-Gauges with the Least Distortion in Pitch (referring to Oil Hardening).

JUNIOR INSTITUTION OF ENGINEERS, at 7.30.—R. S. Fox: Modern Developments in Motor-car Design.

ROYAL INSTITUTION OF GREAT BRITAIN, at 9.—Sir Israel Gollancz: Shakespeare's Shylock and Scott's Isaac of York.

### SATURDAY, APRIL 24.

ROYAL INSTITUTION OF GREAT BRITAIN, at 3.—Prof. W. H. Eccles: The Thermionic Vacuum Tube as Detector, Amplifier, and Generator of Electrical Oscillations.

### MONDAY, APRIL 25.

VICTORIA INSTITUTE (at the Central Hall, Westminster), at 4.30.—Dr. T. G. Pinches: Babylon in the Days of Nebuchadnezzar.

ARISTOTELIAN SOCIETY (at 74 Grosvenor Street), at 8.—Dr. W. M. McGovern: The Development of Buddhist Metaphysics in China and Japan.

ROYAL SOCIETY OF ARTS, at 8.—Dr. W. Rosenhain: Aluminium and its Alloys (Cantor Lecture).

ROYAL SOCIETY OF MEDICINE (Odontology Section), at 8.—G. B. Ash: A Factor in the Pathology of Pyorrhoea.—H. Stobie: The Problem of Infection about the Apex of the Tooth.

### TUESDAY, APRIL 27.

ROYAL HORTICULTURAL SOCIETY, at 3.—P. C. M. Veitch: Magnolias. ROYAL INSTITUTION OF GREAT BRITAIN, at 3.—Prof. A. Keith: British Ethnology: The Invaders of England.

INSTITUTION OF CIVIL ENGINEERS (Annual General Meeting), at 5.30. ZOOLOGICAL SOCIETY OF LONDON, at 5.30.—F. F. Laidlaw: Contributions to a Study of the Dragonfly Fauna of Borneo. Part IV. A List of the Species known to occur in the Island.—Dr. R. Broom: Some new Theropodan Reptiles from the Karroo Beds of South Africa.

ROYAL PHOTOGRAPHIC SOCIETY OF GREAT BRITAIN (Lantern Meeting), at 7.—Capt. C. W. R. Knight: Wild Life in the Tree Tops.

### WEDNESDAY, APRIL 28.

ROYAL SOCIETY OF ARTS, at 4.30.—Brig-Gen. C. H. Sherrill: Ancient Stained Glass.

ROYAL AERONAUTICAL SOCIETY (at Royal Society of Arts), at 8.—Maj-Gen. Sir S. Branner: Aerial Transport from the Business Point of View.

### THURSDAY, APRIL 29.

ROYAL INSTITUTION OF GREAT BRITAIN, at 3.—R. Campbell Thompson: The Origins of the Dwellers in Mesopotamia.

ROYAL SOCIETY, at 4.30.—Probable Papers.—Prof. J. W. Gregory: The Irish Eskers.—Miss K. M. Curtis: The Life-History and Cytology of *Synchytrium endobioticum* (Schilb) Perc. the Cause of Wart Disease in Potatoes.—B. Sahni: The Structure and Affinities of *Acmephylla Pancheri* Pilger.

ZOOLOGICAL SOCIETY OF LONDON, at 4.30.—Annual General Meeting. CHEMICAL SOCIETY, at 5.—Extraordinary General Meeting to consider the Alterations in the By-laws proposed by the Council. CHILD-STUDY SOCIETY (at Royal Sanitary Institute), at 6.—Sir A. E. Shipley: Biting Insects and Children.

INSTITUTION OF ELECTRICAL ENGINEERS (at Institution of Civil Engineers) at 6.—A. E. McColl: Automatic Protective Devices for Alternating Current Systems.

OPTICAL SOCIETY (at Imperial College of Science and Technology), at 7.30.—Dr. C. E. Kenneth Mees: The Reaction of the Eye to Light.

### FRIDAY, APRIL 30.

WIRELESS SOCIETY OF LONDON (at Institution of Civil Engineers), at 6.—Major B. Binyon: A Wireless "Call" Device.

INSTITUTION OF ELECTRICAL ENGINEERS (Students' Meeting) (at Finsbury House), at 7.—J. E. Holmstrom: Tidal Power.

INSTITUTION OF MECHANICAL ENGINEERS (Informal Meeting), at 7.—A. P. Bale and Others: Discussion on Suggested Means of improving and Increasing the Services of the Institution to Members.

ROYAL INSTITUTION OF GREAT BRITAIN, at 9.—Prof. F. O. Bower: The Earliest-known Land Flora.

### SATURDAY, MAY 1.

ROYAL INSTITUTION OF GREAT BRITAIN, at 3.—Dr. F. Chamberlin: The Private Character of Queen Elizabeth; at 5.—Annual Meeting.

## CONTENTS.

	PAGE
The Promotion of Medical Research	221
A Study in Palæogeography. By Prof. A. C. Seward, F.R.S.	223
Wheat and Wheat-growing. By Dr. E. J. Russell, F.R.S.	224
The Fertilisation of the Ovum. By A. D.	225
Wisdom of Life and Existence	226
New Books on Industrial Chemistry. By G. M.	227
Our Bookshelf	228
Letters to the Editor:—	
The Separation of the Element Chlorine into Normal Chlorine and Meta-Chlorine, and the Positive Electron. (With Diagrams).—Prof. William D. Harkins; Dr. F. W. Aston	230
On Atomic and Molecular Structure.—Dr. A. E. Oxley	231
Aquarium Cultures for Biological Teaching.—Dr. Monica Taylor, S.N.D.	232
Ionisation in the Solar Chromosphere.—M. N. Saha	232
Gravitational Deflection of High-speed Particles.—Leigh Page	233
Science and the New Army.—K. E. Edgeworth	233
The Universities and the Army.—F. J. M. Stratton	234
Early Hawthorn Blossom.—Lady Rose	234
The Doctor of Philosophy in England.—Dr. Henry O. Forbes	234
Progress in Naval Engineering. By H. C. H. C.	235
The Investigation of Grain Pests. By Dr. A. D. Imms	236
Some Applications of Physics to War Problems	237
Obituary: Prof. J. A. McClelland, F.R.S. By A. W. C.—Dr. R. G. Bartholomew. By Geo. G. Chisholm	238
Notes	240
Our Astronomical Column:—	
Occultation of a Star by Saturn	244
The Einstein Displacement of Spectral Lines	244
Stellar Spectroscopy at the Detroit Observatory	244
Meteorology at Hong-Kong	244
Milk Production of Ayrshire Cattle	245
The Ignition Points of Liquid Fuels	245
Naval Research and Experiment	245
Education and Science in the Civil Service Estimates for 1920-21	246
The Native Tribes of Western Australia	248
University and Educational Intelligence	248
Societies and Academies	249
Books Received	251
Diary of Societies	252

### Editorial and Publishing Offices:

MACMILLAN AND CO., LTD.,  
ST. MARTIN'S STREET, LONDON, W.C.2.

Advertisements and business letters to be addressed to the Publishers.

### Editorial Communications to the Editor.

Telegraphic Address: PHUSIS, LONDON.  
Telephone Number: GERRARD 8830.



THURSDAY, APRIL 29, 1920.

### The Chemical Industries of German Rhineland.

IN 1916, as a result of war conditions, British chemical manufacturers formed an association with the view of strengthening and consolidating their position by mutual help and co-operation. After the declaration of the armistice the association dispatched a Mission to Germany, under the guidance of the Department of Overseas Trade, to study the present position of German chemical industry. The Mission consisted of twenty members of the association, representing various branches of chemical manufacture, and it was accompanied by a military representative and by delegates of the Department of Overseas Trade, the Board of Trade, the Local Government Board, and Canadian interests. Thirty-nine works were visited, all of them in German Rhineland and in zones occupied by the Allies from north of Cologne to Mannheim. The inquiry resolved itself into a study of the position of the following sections of chemical industry, as developed in Germany, viz. (1) Heavy chemicals; (2) coal-tar products, intermediates, and dyestuffs; (3) fine organic and pharmaceutical products; (4) general inorganic products.

The report of the Mission is of the highest public importance, and merits the attentive consideration of every chemical manufacturer in the kingdom. It is, however, too technical to be dealt with here. We are concerned rather with its general purport and with the lessons and warnings it conveys. These are given in the summary of the report which the association has caused to be printed and published.<sup>1</sup> We trust it will be widely circulated and read. The moral it inculcates is summed up in this one brief sentence: "*German chemical industry has been one stupendous organisation for effecting and promoting the application of science to industry*"—a statement which, we agree with the writer of the summary, "should be displayed, not only in every office, but in every educational institution in the kingdom," as well as "in all Government Departments."

At the same time, there is nothing very new in this pronouncement. It has been the burthen of innumerable articles and public addresses during the last half-century; and we see their effect in the

multiplication of our provincial universities and the creation of our various technical colleges and schools. Anyone at all familiar with the history of these institutions knows that their creation has been entirely due to the action of a few public-spirited men who have laboured, in season and out of season, and often under sore discouragement, to effect their establishment. In no single instance have they been due to the spontaneous impulse of a whole community, prompt to recognise and to appreciate the value of science to industry. Even when established, there was, as a rule, no very widespread desire, at all events at the outset, to take advantage of the opportunities they afforded. In most of them their day of small things was a fairly long period.

But the coming of the war brought a great awakening. The national importance of science was recognised as never before. We then realised we were confronted with a nation that had sedulously cultivated science in its application to practically every art and every industry of peace, as well as of war, and we were amazed and disquieted at our own shortcomings and our supine neglect. The new Education Act is a measure of the degree to which the country has been roused. The ease and practical unanimity with which it was passed are the clearest proofs of the public conviction of its necessity.

The document before us, emanating from a body of experts eminently qualified to express an authoritative opinion, will serve to strengthen that conviction. It deals, of course, mainly with only one branch of applied science; but, as it happens, it has been a branch which has rendered extraordinary service to the country at one of the most critical periods of its history. It was not so much our knowledge of chemistry that helped us, or the facilities we possessed of applying it. In these respects we were lamentably behind our chief enemy, and that enemy knew it. But she reckoned without the national characteristics which ultimately saved the situation, and, luckily for us and the world, her lightning stroke missed its aim, and she was compelled by circumstances to give us time to develop and apply them. But it is safe to say that, had we been capable of taking up the position before the war that we were in at its close, its duration would have been greatly curtailed, and it is conceivable, indeed, that it would never have been begun.

The summary of the report, concise as it is, covers more ground than can be dealt with in a single article. We must therefore confine our-

<sup>1</sup> A Summary of the Report of the British Chemical Mission on Chemical Factories in the Occupied Area of Germany. (Association of British Chemical Manufacturers, 166 Piccadilly, W.1.)

selves to a brief statement of the general impressions which the members of the Mission gained concerning the present development of chemical industry in Germany, and its potential future as affected by the war.

To begin with, the Mission was strongly impressed with the evidence of scientific method which appertained to everything relating to the industry, not only to the laboratory and the factory, but also to accountancy, buying and selling, and the management of labour—in fact, to every side of business activity. This result had been achieved by an efficient combination of experts. "The Germans, in fact, have learnt how to use their leaders with utmost effect." It has been the fashion to disparage the originality of the Germans and to point to their lack of inventive power. Whatever may be their failings in these respects, there is no question that it is through their willingness to co-ordinate their efforts that much of their striking success is to be attributed. Moreover, as is pointed out, the chemical industry occupies a high position in Germany, and it can command the services of the best brains in the country. The status of the chemist is such that it is now, at least in the higher positions, one of the best paid of the professions in Germany—far more so than the Law and the Church. How this has been brought about is clearly stated:

"During generations past, unlimited facilities have existed for providing those who wish to become chemists with an education which is nowhere excelled, so that not only is the status of the chemist high, but the man himself, in virtue of his thorough training, is fitted to maintain the high position in which he is placed. Everywhere the chemist is to the fore, and not only are chemists found in the chief administrative positions of the large chemical undertakings, but they frequently control the great organisations characteristic of German industry generally."

The author of the summary has a very definite opinion as to the influence of the German educational system in the universities and the polytechnics in reaching this result, and he contrasts it with our own system of scholarships and bursaries, which he evidently disparages:

"As German education has been carried on without money bribes in the form of scholarships and fellowships, and without competitive examinations, the system has been one of almost complete *Lernfreiheit*. Although it has often been adversely criticised by those unacquainted with its workings, the results belie all such criticism. At least, the student has always worked with a forward outlook; his effort has been to *solve a problem*, not

merely to acquire knowledge. The system has been as far removed as possible from that pursued in this country, especially at Oxford; there can be little doubt that it has been a factor of great importance in the development of industry on a scientific basis in Germany."

Now, while there is much that is unquestionably true in this statement, in his desire to decry our own educational system the writer has shown either that he himself is not wholly acquainted with the later development of the German system, so far as it is concerned with chemistry and its industrial application, or that he is guilty of a *suppressio veri*. The German leaders of chemical industry some time ago determined to attract promising chemical students by that very system of "money bribes" which he deprecates, and to endow what are practically fellowships to be held in connection with German university laboratories. In principle there was nothing in this essentially different from our own procedure—except that the aims of the German manufacturers were not quite so altruistic as those of the "pious founders" in our own universities.

The writer of the summary pays a well-deserved compliment to the enterprise, skill, and courage of the men who controlled these vast industrial concerns—their breadth of view and keenness of outlook; their tireless efforts and unflinching perseverance in attacking problems needing years for solution, and for which no early return for the large expenditure involved could be anticipated. Nothing, we are told, appeared to have struck the Mission more than the lavish monetary outlay on laboratories, libraries, and technical staffs. As an example, an account is given of the leading features of the great Bayer works at Leverkusen, one of the most highly organised of the Rhineland factories. We have also a brief statement describing the rapid development of power stations in the Rhine district, especially during the war; and some account of the working of the *Interessen Gemeinschaft* (I.G.), by which the leading chemical firms co-operate so as to secure community of interests. But limits of space preclude any detailed account of the several matters of interest covered by the report. Enough, however, has been written to indicate its importance. Whilst we cannot wholly subscribe to every statement of the writer of the summary, who has been allowed, possibly, too free a hand in interpreting the findings of the report, we can at least testify that he has the courage of his convictions and little hesitation in giving utterance to them.

**Man: Past and Present.**

*Man: Past and Present.* By A. H. Keane. Revised, and largely re-written, by A. Hingston Quiggin and A. C. Haddon. Pp. xi+582+xvi plates. (Cambridge: At the University Press, 1920.) Price 36s. net.

IT is scarcely necessary to extol the virtues of the late Prof. A. H. Keane's invaluable compilation of data relating to the races of mankind and their customs (see *NATURE*, June 8, 1899, p. 121), for it has been the *vade mecum* of almost every working ethnologist for more than twenty years. If the authors of the new edition had a task of exceptional difficulty in practically re-writing a work of so encyclopaedic a nature they also had a great opportunity. Moreover, Mrs. Hingston Quiggin and Dr. Haddon had exceptional, if not unique, qualifications for making the most of their chance. But they have contented themselves with pouring their new wine into Keane's old bottles. Even so glaring an anachronism as Keane's classification of the races of mankind and the use of the unpardonable term "Caucasian," with many of its unfortunate implications, have been retained. They have made a digest of the modern literature of ethnology that will be extremely useful to the expert, who knows what to select and what to reject, but utterly bewildering to the student and the general reader, who expect some sort of consistency and some leading idea to bind together such vast masses of data as are presented to them in this book. Instead of this they will find an excellent series of extracts from a host of authors without any serious attempt to create a consistent story or to explain the wide discrepancies in their interpretations of the facts.

Although the authors direct attention (pp. 351-53) to the fact that fatal objections have been made to the fashionable speculation of the independent origin of cultures, throughout the rest of the book they ignore this warning and adopt an extreme attitude in flagrant opposition to the doctrine of diffusion. Take, for example, the dogmatic statement on p. 23:—"In fact, we know for certain that such an independent Copper Age was developed not only in the region of the Great Lakes of North America, but also amongst the Bantu peoples of Katanga and other parts of Central Africa": the researches of one of Dr. Haddon's own pupils, Mr. W. J. Perry, have shown this claim to be totally unfounded. Copper was not used in either of these places until immigrants who had already become acquainted with the economic value of the metal elsewhere had made their way into these territories and discovered the new sources of supply.

This sort of fallacy runs through the whole book, and will be a repeated source of confusion to the thoughtful student. What, for example, will he think of the statement on p. 465: "The idea of an independent evolution of Western [European] culture is steadily gaining ground," after reading a hundred pages earlier that the opposite tendency is now strongly asserting itself?

The late Prof. Keane was a strong supporter of the speculation of the independent origin of culture, and at times became almost fanatical in giving expression to his devotion to the fashionable craze. But the authors of the present edition, in spite of their pretence of impartiality, go further than the original author. The latter was not always consistent. While he poured scorn upon the whole theory of the diffusion of culture and quoted with child-like gusto the worst extravagances of Brinton's and J. W. Powell's denials of the possibility of such a spread of civilisation as everyone knows to be happening at the present time, he frankly and fully adopted it as the explanation of the ancient Rhodesian monuments at Zimbabwe. But the authors of the present edition reject Keane's solution of the Zimbabwe problem, and adopt Dr. Randall-MacIver's discredited speculations. Thus we are told that "exploration in 1905 dispelled the romance hitherto connected with the 'temples' and produced evidence to show that they were not earlier in date than the fourteenth or fifteenth centuries [*sic*], and were of native construction" (p. 89). Dr. Haddon does not enlighten his readers as to how the discovery of a piece of medieval Chinese pottery in one of the altogether subsidiary buildings at Zimbabwe can prove that the great buildings were built by *negroes* not earlier than the fourteenth century. The discovery of a piece of willow-pattern plate in the foundation of a house at, say, Bristol would not prove that the Roman buildings at Bath were erected by Englishmen in the nineteenth century! Yet this is the sort of argument which is naively borrowed by Dr. Haddon, who is well aware of the multitude of data entirely fatal to it.

The authors, in fact, seem to have accepted without discrimination anything that has recently appeared in print, and not tested it in the light of their own knowledge. Thus they have reproduced without comment or criticism some of the least excusable fallacies of current ethnological literature. For example, in their discussion of the origin of Chinese civilisation (p. 207) they confuse race and culture. They are giving the reasons for not deriving the *people* of China from south-western Asia, when they are really discussing the origin of Chinese *civilisation*. Writers

who had compiled the vast mass of data in this book should have had no hesitation in dismissing once for all any suggestion that "the present inhabitants of China are late intruders of south-western Asia" (p. 207). At the same time, they should not have been blind to the fact that there is ample evidence to demonstrate how most of the Chinese customs and beliefs were inspired by events that were occurring in Elam, Sumer, and Turkestan early in the third millennium, the influence of which was gradually transmitted to Shensi by prospectors searching for gold, freshwater pearls, and jade in the heart of Asia.

But the writers have not understood the meaning of these facts. Nowhere in the book is there so much confusion as in the sections relating to Turkestan. On p. 257 they qualify their acceptance of Prof. Ellsworth Huntington's views by quoting Dr. Peisker's wise warning that "[change of] climate was not the sole or even the main factor" in causing the desolation of Turkestan and Central Asia; yet on p. 263 they seem to forget the need for caution, and attempt to explain the origin of Sumerian civilisation as one of the results of a period of drought in Central Asia. To those who are acquainted with the scientific results of M. de Morgan's "Mission en Perse" it will come as a surprise to be told that "recent archaeological discoveries [by which the writers refer to Huntington's desiccation hypothesis] make Sumerian origins a little clearer"! On the contrary, M. Edmond Pottier's report on the earliest painted pottery found by M. de Morgan in Susa proves conclusively that the earliest ceramic ware from Turkestan was directly inspired by Elam. So far from the origin of Sumerian civilisation being explained by discoveries in Turkestan, we now know that the culture of the latter area was derived from the neighbourhood of the Persian Gulf.

These examples serve to illustrate the weakness of the book. While making an encyclopædic compilation of extracts from the most recent writers, the authors have made little attempt to assimilate and co-ordinate the collection of facts. Nor has any attempt been made to link together the data by means of any general idea or principle. The book has been compiled at a time when the facts of ethnology are being illuminated by the brilliant light of a new theory which explains how and why the elements of our common civilisation were spread abroad in ancient times by prospectors searching for pearls and the precious metals. This revolutionary idea in ethnology was propounded by one of Dr. Haddon's pupils, Mr. W. J. Perry. But it is clear from this book that Dr. Haddon has

utterly failed to appreciate the new vision in ethnology which his own school has effected.

There is no reference to the Talgai skull, and Sir Baldwin Spencer's assumption that the Tasmanians must have crossed Bass Strait on dry land is accepted without comment. Why people whose ancestors had already crossed Wallace's line by boat could not also have ferried across Bass Strait is not apparent!

The lack of maps and diagrams is a serious defect, and many of the illustrations at the end of the book are far from satisfactory. I think it unfortunate that a book of this character should have been issued at the present moment, for it will give the world outside Cambridge an altogether misleading idea of the nature and quality of the excellent training which the Cambridge School of Anthropology is now providing.

G. ELLIOT SMITH.

### Critical Mathematics

*Les Principes de l'Analyse Mathématique: Exposé Historique et Critique.* By Prof. Pierre Boutroux. Tome second. Pp. iv + 512. (Paris: Librairie Scientifique A. Hermann et Fils, 1919.) Price 20 francs.

THIS second volume of Prof. Boutroux's work contains the outlines of analytical plane and solid geometry, projective geometry, the theory of ordinary complex quantities, infinite series and products, infinitesimal calculus, analytical functions. There are also very brief notices of determinants, groups, aggregates, vectors, elliptic, abelian and fuchsian functions.

On the whole, the volume may be described as a varied and stimulating course likely to interest a competent university student and induce him to follow up one or more of the numerous branches of mathematics to which his attention is directed. Owing to the variety of topics introduced, much of the didactic part of the course is very fragmentary; at the same time, it is elegant and suggestive.

To the teacher, the most interesting part of the volume is the critical and historical matter. The historical sections seem to be admirable in every way—judicious, impartial, and in proper perspective and proportion. Among other things, attention is directed to Fermat's contributions to analytical geometry, some of which, in a measure, anticipated Descartes. At the same time, it is pointed out that, whereas Descartes had in view the ousting of pure geometry by analysis, Fermat, like Newton, remained faithful to the old methods, regarding analysis mainly as an auxiliary. Prof.

Boutroux properly directs attention to the fact that much of Apollonius's "Conics" is essentially analytical, though, of course, there is no algebra, strictly so called. In the sections on function-theory, due reference is made to Méray, who shares in great measure with Weierstrass the credit of laying the foundations of a sound theory of analytical functions. It is fortunate that the great similarity of the work of these two mathematicians did not give rise to bitter polemic; there was at least as much material for it as in the famous Newton-Leibniz controversy.

The author's critical remarks, we fancy, will not meet with such unqualified acceptance. To take one example, he says of Peano's symbolism: "Unfortunately, it is not everyone who can read with facility these combinations of signs, which are often grotesque and repulsive, and unaccompanied by a single word of the vulgar tongue. Moreover, M. Peano's symbolism cannot claim to have made any contribution to the progress of mathematics; it remains a remarkable method of scientific shorthand." As a criticism of the work of Peano and his school, this is distinctly unfair. Anyone who has the patience to become moderately familiar with the notation is bound, we believe, to admit that the alternative is either to produce a text full of ambiguities and tacit assumptions, or else one of intolerable prolixity. The present reviewer has come to this conclusion with very great reluctance; even the Cambridge Press has not succeeded in making the "Principia Mathematica" attractive to the eye; and it is to be feared that the first impression it is likely to produce is that it is the work of a drunken compositor. Probably its use will be mainly, if not wholly, confined to the logical foundations of mathematics; for this purpose we think its value is indisputable. There are other controversial statements scattered about the text; they all deserve careful attention, even if the reader is inclined to disagree with them.

There is one point, of frequent occurrence, against which we feel bound to protest. Prof. Boutroux repeatedly says that such an equation as  $x^2 + y^2 = 0$  represents a *point*. This is absolutely untrue; it may be said to represent a point-circle (circle of zero radius), or a pair of isotropic lines, according as we exclude or include complex elements. But no single equation in point-co-ordinates can represent a point; moreover, it is fatal to ignore the degree of the equation. Oddly enough, Halphen makes the same mistake in his memoir on characteristics; he repeatedly gives the name of "a single line" to what is, as a degenerate *quadratic* locus, a double line with two special points (or, exceptionally, one special

double point) upon it. Fortunately, this does not affect Halphen's conclusions, the reason (apparently) being that he discusses point-equations and line-equations simultaneously.

We hope that this work will have a good circulation in England; its virtues are precisely those in which our text-books still leave something to be desired: elegance, breadth of view, choice of topics, and regard to historical perspective.

G. B. M.

### The Proteins.

*The Physical Chemistry of the Proteins.* By Prof. T. Brailsford Robertson. Pp. xv+483. (London: Longmans, Green, and Co., 1918.) Price 25s. net.

THIS is not a new book. It first appeared in the form of an edition in German published at Dresden in 1912. The second edition, in English, has, however, been so completely rewritten as to make it practically a new account of the subject.

There are four parts, of which the first deals with the mode of preparation and estimation and the chemical constitution of proteins; the second with their electro-chemistry; the third with the physical properties of their solutions, such as viscosity, refractive indices, etc.; and the last with what the author calls the chemical dynamics of protein systems, by which, broadly, he means their reactions with catalysts. It will be seen that a complete survey of the subject has been attempted, and it may be said at once that, as an introduction to the literature, already extensive, the book can be commended.

It is now agreed that the proteins are chemically a homogeneous group the molecules of which are built up by the synthesis of amino-acids. The size of the molecules so formed is still open to doubt. Emil Fischer, than whom no one could speak with more authority, refused to accept the molecular weights of 15,000 to 20,000 commonly ascribed to native proteins. The molecular weight, indeed, varies widely from the 16,000 of hæmoglobin, or the 17,000 of edestin, to the values reckoned in hundreds of the polypeptides. It certainly lies in the thousands for native proteins, and is large enough to upset the simpler stoichiometrical relations.

Consider, for example, the reaction with acids and alkalis. Proteins, like amino-acids, are amphoteric—that is to say, they will form salts with either an acid or a base—but, according to the author, when their combining equivalents are determined by known methods, their combining capacity is found to be much in excess of the

possible number of terminal —OH or —COOH groups.

For example, casein, according to the author, behaves as a 16-base acid. To provide sixteen terminal carboxyl groups, the molecule would have to be either a branched chain, or chains radiating from a centre where carbon atoms are directly linked one to another. Such a molecular structure, however, would render the decomposition of the casein molecule on hydrolysis into its constituent amino-acids unintelligible.

Moreover, the form of the molecule of the polypeptides which have been prepared synthetically is not open to doubt, and it is not radial, but a chain, the constituent amino-acids being joined end to end.

The amino-acids of the chain are united by a CONH linkage, which may have a keto- or enol-form, and it is here the author supposes that the reaction with acids or bases takes place.

Consider the simplest case—that of a dipeptide. If combination with an acid or a base takes place at the middle of the chain where the CONH linkage is situated, and the salt ionises in solution, the dipeptide molecule will form two protein ions. Salts of proteins, therefore, should yield, not a protein ion and a simple ion such as Na<sup>+</sup> or Cl<sup>-</sup>, but two oppositely charged protein ions.

This hypothesis is the central feature of the book, which, indeed, is devoted to following out its consequences. Its validity has been challenged, but, whether true or false, no worker or student will be the worse for learning what it leads to.

Obviously, one consequence is that when a solution of the salt of a protein is electrolysed, the protein should migrate to both cathode and anode. But, as a matter of fact, as Hardy's observations show, the protein migrates only in one direction and in quite a normal way. The author recognises this difficulty and attempts to meet it, but, owing to a slip in the reasoning, his argument would appear to upset his own theory.

### Science and Engineering.

*Engineering Education: Essays for English.*

Selected and edited by Prof. Ray Palmer Baker. Pp. ix+185. (New York: John Wiley and Sons, Inc.; London: Chapman and Hall, Ltd., 1919.) Price 6s. net.

THIS is an interesting small book containing addresses or portions of addresses by distinguished professors and consulting engineers bearing on the importance of a knowledge of science to engineers. Dr. Steinmetz, of the General Electric Co., urges the need of a broad culture, and especially of the study of Greek and

Latin classics, for engineers. Prof. McClenahan, of Princeton University, advocates a three- or four-year course of literary and scientific studies, followed by a two-year technical course. Mr. J. L. Harrington, a well-known engineer and bridge designer, points out the necessity for a thorough knowledge of English.

"It is notorious that a technist is rarely a good business man. This is partly because of the exaggerated importance he gives to technical matters, but very largely because his thought is clumsily expressed and awkwardly ordered."

Mr. Harrington remarks on the frequent obscurity of specifications, and tells of a contractor who never completed a contract without a lawsuit to determine the meaning of a specification, and who had never lost a lawsuit. Sir W. H. White and Prof. Ranum, of Cornell University, write on the value of mathematics. There are addresses on chemistry and physics, and a distinguished consulting engineer, the inventor of the obelisk dam at Niagara, built on end on the shore and then toppled into the river, writes on the importance of imagination.

It strikes a reader that these addresses, each advocating the claim of some one branch of science, interesting as they are, would have been more useful if there had been a recognition of the distinction between what should be included in the school course preceding the technical course, in the technical course itself necessarily restricted, and what extra academic self-education should be expected to accompany and follow it. It may be surmised that engineering students in the United States do not enter on the technical course as well prepared as they should be, and this is certainly to some extent the case here. But preachers on education might remember what Stevenson says of Sainte-Beuve, that he regarded all experience as a single great book in which to study for a few years before we go hence; and it seemed all one to him whether you read in chap. xx., which is the differential calculus, or in chap. xxxix., which is hearing the band play in the gardens.

There is also an admirable address by Sir J. J. Thomson, delivered before the Junior Institution of Engineers, on the relation of pure science to engineering. Sir Joseph remarks that the scientific spirit has not diffused through and influenced the bulk of our industries to the extent it has done in one or two other countries. He traces the evil to the fault of the secondary school, the inefficiency of which causes the technical course to be overloaded.

"The curriculum is founded on the truly British idea that our boys are not expected to learn any-

thing at school. Most of the work in the courses for students in their first year, and some of that in the second, in all the engineering schools with which I am acquainted, is of a kind that a boy might well be expected to do at school. There is no reason why a boy of eighteen, of the mental calibre which would justify his becoming an engineer, should not have a good working knowledge of the calculus and the elementary parts of differential equations, and have read a considerable portion of dynamics. This could, I am convinced, be done without undue specialisation, and without depriving the boy of the literary training which is essential, if he is to keep his sympathies wide and his mind receptive."

W. C. U.

### Health and the Teacher.

*A Text-book of Hygiene for Training Colleges.*

By Margaret Avery. Pp. xv + 324. (London: Methuen and Co., Ltd., 1919.) Price 7s. 6d. net.

THIS book is intended to cover the subject-matter of the Board of Education Certificate Examination for Training Colleges in England. It includes the usual anatomico-physiological "properties" long familiar in books of this order since the days of Huxley's "Physiology": elementary ideas about structure of tissues, the skeleton, the muscular system, the circulatory system, the digestive system, etc. But the exposition is kept well within the technicalities suited to the students concerned. There are chapters on food, clothing, cleanliness, mental dullness and deficiency, fatigue, infectious diseases, temperance, school building, medical inspection and treatment, special schools, welfare of infants and young children, legislation affecting school children, and eugenics.

This is a very large programme for so small a book, but the expositions, which, incidentally, retain a good deal of the somewhat loose notes-for-lecture style, are, on the whole, relevant and practical. The author has kept close touch with official memoranda, reports, and standard books. The result is that the volume, all through, contains good informational material which has obviously stood the test of experience in the classroom.

It is difficult to say how much medical information proper should be included in a book like this, but to untrained lay persons it is of no value to state that, in anæmia, "a little iron often has excellent results" (p. 42). Again, as to the cause of rickets, something more is wanted than that "the cause is wrong food, chiefly lack of fat, a lack existing in all patent foods" (p. 88). This kind of information may fulfil the terms of a

syllabus, but it is of no value whatever to the student, though, usually, in a practical curriculum, there are many opportunities of supplementing these generalities by demonstrations of cases.

The chapter on "First Aid" relies on accepted instructions, but Schäfer's method for recovery from drowning should have a place. The chapters on legislation affecting children and on eugenics are judiciously proportioned, but the remarks on the causes of pauperism as implying "a want of grit and independence" (p. 305), and on feeble-mindedness and heredity, show that the author has accepted somewhat too uncritically the theoretical deductions of "experts." The book will, however, serve as a good text-book for the practical teacher.

### Our Bookshelf.

*The Mineralogy of the Rarer Metals: A Handbook for Prospectors.* By Edward Cahen and William Ord Wootton. With a foreword by F. W. Harbord. Second edition, revised by Edward Cahen. Pp. xxxii + 246. (London: Charles Griffin and Co., Ltd., 1920.) Price 10s. 6d.

THIS book is neatly bound, and is of handy size for the pocket. The mineral descriptions are conveniently treated in a general way in the alphabetical order of the metals. The alkali metals come first; then follow beryllium, cerium, and so on to zirconium. Under each metal the properties, preparation, industrial application, and ores are first considered; following this an account of the chemical methods for its detection, and a list of the minerals containing the metal, are given. Much care appears to have been taken in describing the chemical and physical character of the minerals and the tests available for purposes of identification. Separate sections at the end of the book deal with the geographical distribution of rare metals and methods of analysis.

To the critical reader of the book many of its features suggest questions and scope for improvement. Is it permissible to regard titanium as a rare metal? Ilmenite is certainly not a rare mineral, and it is incorrect to refer to this mineral as "a chief constituent of monazite from Travancore and Ceylon" (p. 130). It would be more correct to say that the chief producer of rutile is Virginia, U.S.A., than to imply, as the author does, that the chief producer is Norway (p. 131). Under tungsten no mention is made of the wolframite deposits in China, which has recently been the leading producer (p. 141). Zircon is mentioned as occurring in "Scotland and Ireland," but no mention is made of its universal distribution in sands and gravels such as those of Hampstead Heath (pp. 182, 189).

The section dealing with geographical distribution has been revised, but it might with advantage be amplified to include such countries as Spain,

Portugal, and France, where there are many occurrences of greater importance than some that receive mention in this book.

T. C.

*A Text-book on Machine Drawing for Electrical Engineers.* By E. Blythe. (The Cambridge Technical Series.) Pp. vii+81. (Cambridge: At the University Press, 1920.) Price 20s. net.

ALL teachers of electrical engineering are aware of the need for a text-book on the drawing and construction of electrical apparatus. This attempt, however, to supply the need is disappointing. Apparently the author intends the book to serve for a complete course of machine drawing for electrical students, for he commences with the laws of projection and gives several very simple examples in illustration of them. He proceeds then to fastenings, cable sockets, junction-boxes, switches, and dynamos. The subject-matter is confined entirely to such apparatus as is found in small continuous-current power stations (but instruments are not included); consequently the alternator, induction motor, oil-switch, and other important pieces of electrical apparatus are notably absent. Several complete plates are devoted to non-dimensioned sketches showing types of apparatus, e.g. one on brush-holders; a few such examples are undoubtedly useful for practice in sketching, but here too much space is occupied in this way. The drawings are clear and very well arranged, but the descriptive matter is unnecessarily prolix. The examples given do not always represent good practice; for instance, in several places a single-piece armature disc is shown with a dove-tailed key, while a bearing is shown on p. 73 which would be destroyed by a little end-thrust. The book is well got up and has been prepared carefully; but the ground covered is insufficient—at the price.

*Mathematics for Engineers.* Part ii. By W. N. Rose. (The Directly Useful Technical Series.) Pp. xiv+419. (London: Chapman and Hall, Ltd., 1920.) Price 13s. 6d. net.

PART II. of this book is devoted principally to the differential and integral calculus, and includes chapters on spherical trigonometry and mathematical probability. The book is intended for engineers, most of whom are not called upon in their profession to show capacity for high mathematical flights, but are expected to comprehend clearly such fundamental principles as enter into their work, and to be ready successfully to apply them to practical problems. Examining the book from this point of view, we believe that it will find favour with most engineers and students of engineering. If we include also the matter comprised in Part I. the volumes contain practically everything in the way of mathematical principles which the engineer is likely to require. The treatment is clear and of a kind which appeals to engineers, and a very large number of practical applications are given. Many of these are fully worked out to the arithmetical result, and there are very few which can be said to be of an

academical nature only. These examples cover a wide field, having been drawn from all branches of engineering, and represent a large amount of labour for which engineers will be grateful. We can heartily recommend this volume, as well as its predecessor, to all students of engineering.

*The Manufacture of Intermediate Products for Dyes.* By Dr. J. C. Cain. Second edition. Pp. xi+273. (London: Macmillan and Co., Ltd., 1919.) Price 10s. net.

PROBABLY no one in this country is more competent to write on intermediate products than Dr. Cain, and the fact that a new edition of this book has been called for within a year is the best testimony to its success. The opportunity has been taken to improve certain sections and to incorporate new work, most of which, it is of interest to note, originates now in America. It is gradually being realised that intermediates are the crux of the dye situation, and the wisdom of the policy adopted in this direction by British Dyes, Ltd., in building their new factory at Huddersfield is becoming apparent. Given the intermediates, the manufacture of the several dyes is usually a fairly straightforward problem, but there is still much leeway to make up in connection with intermediates, which will require the most ample resources, alike in capital, plant, and technical experience. This will take considerable time to fructify, and some form of closer co-operation with the heavy chemical trade would appear most desirable.

The British colour industry is receiving some adverse criticism from the users of the rarer colours for which the demand, at the most, is but small, but it has a more important task at the moment than to fritter away its energies in making these colours. The colour industry is based on intermediates; it is the manufacture of these by the best methods, with the largest yields, and of satisfactory purity which must be studied in the laboratory and in the works. This is being done, and Dr. Cain, through his book, in which the available information is clearly presented, is helping to do it.

*Solutions of the Examples in a Treatise on Differential Equations.* By Prof. A. R. Forsyth. Pp. 249. (London: Macmillan and Co., Ltd., 1918.) Price 10s. net.

EVEN from the point of view of an undergraduate, the subject of differential equations is very different from what it was fifty years ago. But in a large and miscellaneous collection of examples like this there are a number of survivals which remind us of De Morgan's application of the proverb: "Those that hide know where to find." Teachers and solitary students (if such there be nowadays) will be grateful to Prof. Forsyth for providing them with a key. It is one more example of the author's untriting industry; and, so far as we have tested it, of his accuracy in details of analysis.



### Letters to the Editor.

[The Editor does not hold himself responsible for opinions expressed by his correspondents. Neither can he undertake to return, or to correspond with the writers of, rejected manuscripts intended for this or any other part of NATURE. No notice is taken of anonymous communications.]

#### Theories of Atomic Structure.

In a letter to NATURE (March 11, p. 41) S. C. Bradford stated: "The great objection to Langmuir's theory of atomic structure is the difficulty of accepting his hypothesis of stationary electrons." The cases cited are all discussed in G. N. Lewis's paper, "The Atom and the Molecule" (Journ. Amer. Chem. Soc., xxxviii., p. 762, April, 1916), so it is scarcely fair to Lewis to refer to the theory as "Langmuir's theory."

Although Lewis frankly implied that the electrons in atoms are stationary, his theory of valency did not depend upon such an assumption. The chemical data give information in regard to the geometry of atoms, and, in particular, tell us of the kinds of symmetry which they possess. From the chemical point of view it is at present a matter of comparative indifference what the motions of the electrons may be so long as they conform to the required conditions of symmetry. For this reason I was careful to state in my first paper (Journ. Franklin Inst., clxxvii., p. 359, March, 1919, and Journ. Amer. Chem. Soc., xli., p. 932, 1919) that "the electrons in atoms are either stationary or rotate, revolve, or oscillate about definite positions in the atom." It was, perhaps, not sufficiently emphasised that the positions of the electrons shown in the diagrams may be regarded as the centres of their orbits.

It is sometimes thought that the success of Bohr's theory furnishes reason for believing that all the electrons in atoms are rotating in coplanar orbits about the nucleus. There is little justification for this opinion. The remarkable results yielded by Bohr's theory, particularly in the hands of Sommerfeld, for the case of the hydrogen atom and the helium ion seem to prove beyond question that in an atom containing only one electron this electron actually revolves in a circular or elliptical orbit about the nucleus. Although Bohr's theory has had some applications to other atoms, these are, for the most part, of a very general nature, such as those which relate to the combination principle. The theory does not give a satisfactory model even for such simple structures as the hydrogen molecule or helium atom (see, for example, Sommerfeld's recent book, "Atombau und Spectrallinien").

From the chemical point of view Bohr's theory is wholly unsatisfactory when applied to atoms containing more than one electron. Thus, according to Bohr's calculations (*Phil. Mag.*, xxvi., p. 492, 1913), a lithium nucleus surrounded by three equidistant electrons should have less potential energy (and, therefore, greater stability) than one in which one electron is further from the nucleus than the other two. Bohr's theory thus gives no reason for the contrast between the properties of lithium and helium.

The two theories are not mutually incompatible if we consider that, in general, the electrons do not revolve about the nucleus, but about definite positions symmetrically distributed in three dimensions with respect to the nucleus. It is interesting to note that Born and Landé (*Verh. deut. physik. Ges.*, xx., pp. 210, 230, 1918), starting out from Bohr's theory and without knowledge of Lewis's work, were led to the theory of the cubical atom by a study of the compressibilities of the alkali halides. They conclude that the electron orbits do not lie in a plane, but are arranged in space with cubic symmetry. Sommerfeld

in his book suggests that this conception may help to solve some of the outstanding difficulties, and evidently does not consider it inconsistent with Bohr's theory.

In the case of atoms which do not share electrons with other atoms, it is logical to assume that each electron in the outer shell has its own orbit. Thus the atoms Ne, Na<sup>+</sup>, Mg<sup>++</sup>, F<sup>-</sup>, and the S atom in SF<sub>6</sub> should have cubic symmetry, the eight outer electrons revolving about positions located at the corners of a cube. But where a pair of electrons is held in common between two atoms, the chemical evidence indicates that the pair acts as a unit. When an atom shares four pairs of electrons with its neighbours, it thus has tetrahedral rather than cubic symmetry. So far as the chemical evidence is concerned, it would be satisfactory to adopt Bohr's model for the hydrogen molecule to represent the pair of electrons which constitutes the chemical bond. We may thus picture the chemical bond as a pair of electrons revolving in a single orbit about the line connecting the centres of the two atoms.

Bohr in his 1913 paper (*Phil. Mag.*, xxvi., p. 874) states: "The configuration suggested by the theory for a molecule of CH<sub>4</sub> is of the ordinary tetrahedron type; the carbon nucleus surrounded by a very small ring of two electrons being situated in the centre, and a hydrogen nucleus in every corner. The chemical bonds are represented by four rings of two electrons each rotating round the lines connecting the centre and the corners." This structure is quite consistent with the octet theory. Bohr had, in general, identify a pair of electrons with a valency bond.

When we consider, however, that Bohr's theory in its present form does not furnish an explanation of the stability of the pair of electrons in the helium atom and in the bond between atoms, it is evident that the model described above can scarcely be regarded as satisfactory. It seems as though some factor of vital importance is still missing in Bohr's theory. The chemical data suggest that the ultimate theory will be extremely simple, but perhaps more radical than anything yet proposed.

I am in full agreement with the views put forward by Dr. H. S. Allen in NATURE for March 18, p. 71.

IRVING LANGMUIR.

Research Laboratory, General Electric Co.,  
Schenectady, New York, April 12.

#### Decimal Coinage.

IN NATURE of April 1, p. 145, reference is made to the unfavourable report of the Royal Commission appointed to inquire into the above subject. It would appear from a close study of the findings of the Commission that the failure to solve this century-old problem was due more to differences between the advocates than to opposition to the principle.

Although fifteen of the twenty Commissioners would prefer to decimalise the existing £ sterling rather than to create a new monetary unit equal to 100 halfpence, it is significant that only four of them could agree that the advantages to be secured by the decimalisation of the £ would outweigh the inconvenience arising from the change. This is tantamount to an admission that the method of dealing with the penny difficulty as proposed in Lord Southwark's Bill (£—mil) was unduly complicated. (No exact equivalent of the penny was provided, the choice of a 4-mil and 5-mil piece being alternatively offered.)

Retaining the £ as the unit, there are three possible values for the penny, viz.:

- 4 mils = the present penny less 4 per cent.
- 5 mils = the present penny plus 20 per cent.
- 4½ mils = the present penny exactly.

The claims of these denominations may be summed up as follows:

**The 4-mil Penny.**—As the denomination 4 represents neither a decimal multiple of 1 nor a binary division of 10, a 4-mil coin could have no permanent place in any decimal coinage system. As a transitional value it would also be unattractive, because it would still further reduce the purchasing power of the penny at a time when an increase is needed, and its temporary adoption would involve two adjustments of existing pennyworths, thus doubling, instead of removing, the difficulty. For these and other reasons a 4-mil penny may be safely dismissed from our consideration.

**The 5-mil Penny.**—There are at least four good reasons in its favour, viz.:

(1) In a decimal coinage system prices are normally arranged in steps of 5, e.g. 5, 10, 15, 20, 25, etc., and the value of 5 mils would fall conveniently between that of the unduly high 5 American cents and the unnecessarily low 5 centimes of the Latin Union.

(2) The reduction of the present high prices would be hastened by the provision of a penny of this value. The price of a pre-war pennyworth, now sold at three-halfpence, could obviously be reduced to 5 mils long before it could be restored, if ever, to the original penny.

(3) The prevailing shortage of copper coins would be relieved by thus increasing the token values of all the penny and halfpenny coins now in circulation. Two copper coins are now employed in countless transactions where formerly one sufficed, and this fact alone, quite apart from decimalisation, demands a penny of higher value.

(4) The simple relationship of 10 pence to the shilling would be readily grasped by the uneducated, and the deservedly popular single-coin payments would be restored. Retail shopkeepers could, if so desired, continue to keep their accounts in £ s. d. instead of £ f. m., the 2½, 5, 10, and 25 mil coins being in that case entered as ½, 1, 2, and 5 pence, all the higher value coins retaining their present descriptions as 1, 2, 5, and 10 shillings respectively.

**Note.**—The majority Commissioners apparently feared that 5 mils would always be charged in place of the present penny. If they had said in place of the present three-halfpence, they would have been just as near the truth, which possibly lies between these two views. Probably everyone would now be very glad to pay 5 mils for a pre-war pennyworth of anything—the trouble is we are charged three-halfpence or more. When introducing this year's Budget the Chancellor of the Exchequer (referring to his proposal to raise the receipt duties from 1d. to 2d.) said: "This change is no more than reflecting the altered value of the penny."

**The 4½-mil Penny.**—If there are insuperable difficulties in the way of raising the values of the existing penny and halfpenny coins to make them serve as tokens for 5 mils and 2½ mils respectively, they could remain in circulation at their present values side by side with new 5-mil nickel coins, in which event their values in mils could be expressed as 4-2 and 2-1 respectively, the latter figure representing twelfths of a mil. (These expressions would be no worse than our present use of 4/2 to represent four shillings and two-twelfths.)

The present penny could thus be preserved indefinitely for the continued exact payment of all statutory pennyworths, but the competition of the smaller, lighter, and cleaner 5-mil nickel coin, representing a value in closer harmony with present-day needs, would rapidly drive the bronze penny out of popular favour for the countless single-coin payments of daily life. In concluding that this method might involve the dual circulation of pence and mils "for seventy-five years or more," the majority Commissioners have unwarrantably assumed that no steps

would be taken by the established "penny" interests, such as insurance and tramway authorities, etc., to bring themselves into line with the new mil system, whereas many of these interests are already agitating for legislative authority to abandon the penny basis, which has proved inadequate to cover operating costs. Many of the old fixed penny charges, such as the penny stamp, penny-a-mile, etc., have already disappeared, and the retention of the coin itself is no longer a matter of vital importance.

The £ sterling could thus be decimalised either without altering the penny or by raising its value to 5 mils (either instantaneously or gradually), and so securing substantial benefits over and above those normally arising from decimalisation.

Having very truly said: "It is necessary to distinguish between the coins in circulation and the reckoning of money of account," and having properly referred to the human habit of halving quantities, the Commissioners failed to realise that it is quite practicable to combine the advantages of decimal accounts and binary coins. Such a composite scheme would provide decimal multiples and binary divisions thus:

Coins	In accounts	Equivalent
<i>Gold or Note:</i>		
Pound ... ..	£ f. m.	£ s. d.
Half-pound ... ..	1 0 00	1 0 0
Quarter-pound (crown) ... ..	5 00	10 0
	2 50	5 0
<i>Silver:</i>		
Florin ... ..	1 00	2 0
Half-florin (shilling) ... ..	50	1 0
Quarter-florin ... ..	25	6
<i>Nickel:</i>		
Dime (10-mil piece) ... ..	10	2 4
<i>Bronze:</i>		
Half-dime (penny) ... ..	5	1 2
Quarter-dime (halfpenny) ... ..	2½	0 6
Mil ... ..	1	0 24

The above proposal achieves the complete decimalisation of the £ by means of a smaller number of coins and in a simpler manner than by the method described in Lord Southwark's Bill. No decimal point would be needed, the number of figures would be reduced, and no new coins would be immediately required.

HARRY ALLOCK.

Trafford Park, Manchester, April 21.

#### International Council for Fishery Investigations.

As the writer of the article on the above subject in NATURE of March 18, I should be disposed to allow Prof. McIntosh's letter in the issue of April 8 based on it to pass without comment if that letter had not been quoted extensively elsewhere. I merely remark that the professor's claim to maintain the same position as he took up in his published criticisms in 1902 and 1903 is fully substantiated. I see no reference in my article to the Moray Firth, which, indeed, had nothing to do with the International Council, and which I must leave Prof. McIntosh to settle with his fishery colleagues in Scotland. His criticism of the representatives of France is out of place, in that representatives of all countries are appointed by their Governments.

Prof. McIntosh confuses the programme adopted with the general discussion which took place first. Commodore Drechsel and others spoke of "the closure of the greater part of the North Sea as the most gigantic scientific experiment ever made, [will

any scientific man contest this view?] in respect to the closure of areas." This is stated by Prof. McIntosh to be the first item in the scheme of investigations, whereas no such general scientific investigation is recommended. Whether or not the fisheries of the North Sea will be permanently altered by the closure consequent on the war no one knows, but certainly trawlers have been experiencing the immediate benefit of the closure since the armistice. The extent to which the North Sea is covered by the operations of trawlers is evidently not understood. The work of Masterman, Heincke, and others results in the estimate that 1500 million plaice of more than 12 cm. live in the North Sea, of which one-third are caught annually, 200 million being put on the market and 300 million being destroyed in the process of catching.

Again, Prof. McIntosh refers to one part only of the proposal for the protection of plaice, viz. that by a size limit, whereas the permanent closure of certain areas "to provide a reserve from which the young plaice might spread so as to restock the open grounds" is definitely mentioned in my article. Prof. McIntosh apparently does not realise that the representatives of at least three of the four countries that are particularly interested in the plaice stock of the North Sea are convinced that the evidence shows that the plaice stock is, under normal conditions, being so seriously depleted by man that international legislative action is essential. In view of such action, the proposed year's intensive plaice investigation is fully justified. We wonder whether Prof. McIntosh has examined the statistics that have been published in respect to the plaice and other flat-fishes year by year?

Prof. McIntosh scoffs at the basal researches on the physico-chemical conditions of sea-water in respect to the life in the sea as likely to be of any importance. He selects in particular "vitamines." His remarks should be read in connection with my paragraph to which he refers. It is self-evident that even the largest quantity of food can be of no use to a living animal unless that animal has the requisite power to build up that food into its own living matter. The understanding of this at every age of the animals in question—and of animal life in general—is the object of these researches. There seems to be no such thing as "pure sea-water" without "vitamines."

It may not be generally known that an almost judicial committee appointed by the Development Commission is at present sitting on the question of fishery research. There is no member of that committee employed in fishery research, and, equally, there is no member of the committee who is incapable, by training or otherwise, of understanding any parts of the problems to be investigated. The report of that committee should shortly be issued. It will doubtless be an authoritative pronouncement upon the whole question as to the utility or non-utility of fishery investigations as proposed by the International Council and as undertaken by the Fishery Departments of England, Scotland, and Ireland.

X. Y. Z.

### The Plumage Bill and Bird Protection.

NATURE is doing a service to science, as well as to art, in having opened its pages to the discussion of the Plumage (Prohibition) Bill. For in the end the Bill should be drafted in harmony with the scientific facts concerning the bird-life it is designed to protect, and also with due regard for the æsthetic and decorative needs of mankind. There is one aspect of the subject which has hitherto been only lightly touched upon, but which, if unfettered, is sure to become of

great importance in the future, namely, the domestication of plumage birds. Impressed with the success of its ostrich industry, South Africa has for some time turned its attention to the possibility of the domestication of other plumage birds. Experiments have already demonstrated that the marabout stork can be controlled in captivity and, in all probability, induced to breed. Attention has also been directed to the gregarious weaver-birds and other brightly coloured species; but the advent of war turned men's thoughts away from the arts of peace.

In all the considerations no biological difficulty presented itself which a thorough study of the nature and habits of the bird could not be expected to overcome; the chief problems were economic, namely, how profitably to produce the plumage in sufficient quantity to comply with trade requirements, so admirably met in the case of the ostrich. On the authority of Prof. Lefroy we learn that there are many egret farms in India, and the plumes are procured without cruelty; domestication of the same bird has also been considered in parts of Africa. With the encouragement which ornithologists could give, there is every likelihood that in the future great developments will take place in the production of domesticated plumage, procured in harmony with the highest humane sentiments and to the exclusion of plumage from the wild bird—a realisation which would be peculiarly acceptable to the trade as well as to zoologists.

Now if the Plumage Bill were passed in its present form it would close the door on all efforts of this kind, at any rate so far as importation into England is concerned. Sir Harry Johnston indicates that, as a compensation, plumage might be procured from a dozen or more kinds of our domestic birds; but surely, in these days of Empire considerations, he would not wish us to isolate ourselves in prejudice from the Dominions overseas, as well as from the products of other countries?—a result which would follow from the carrying out of his suggestion.

Nor is this necessary. A study of the situation reveals that all the reasonable requirements of the supporters of the Bill can be met, and at the same time the avenue be left open for the development within the Empire of a trade in domesticated plumage. Instead of asking for a prohibition of import of every kind of plumage (except ostrich and eider-down), let the prohibitionists and others interested in the preservation of bird-life agree upon a list of birds the protection of which is desirable from any point of view, and then have the list appended to the Bill as a schedule of prohibitions. The carrying out of the intent of the Bill on these lines would be a simple matter, and additions to, and removals from, the schedule could be made as circumstances demanded. Passed in this form, the Bill would become a real stimulus to the activities of the Royal Society for the Protection of Birds and an effective measure for the inculcation of humane principles and regard for bird-life generally.

As Prof. Lefroy has shown, the trade has no concern in avian rarities, but is prepared to work with bird-lovers in the direction of their preservation and in the discouragement of every kind of cruelty. Before the war a list of prohibited plumage had been agreed upon by the trade representatives in the leading European capitals. When the matter of bird-protection is discussed in a calm manner, with full knowledge of the facts involved, it is seen that the interests of the bird-lover and of the plumage trade are alike, and the simple modification of the Bill suggested above would meet the needs of all.

J. E. DURDEN.

Royal Colonial Institute,  
Northumberland Avenue.

### The Standard of Atomic Weights.

It is with considerable surprise, as a chemist, that I see in NATURE of April 22, p. 230, arguments as to the structure of atoms based on the deviations of the atomic weights of elements from whole numbers on the standard  $O=16.00$ . The reasons for the use of this arbitrary and inconvenient standard are now matters of ancient history, and the values of Stas, which were regarded as fundamental at the time when the standard was adopted, have now been shown by many independent lines of experiment to be inexact. It is almost pathetic to observe modern experimenters who have determined equivalents by the accurate analysis of hydrogen compounds, such as hydrogen chloride, methane, hydrogen bromide, ammonia, etc., all of which are more easily obtained in a state of purity, and analysed, than oxygen compounds, compelled to multiply their results by 1.008 in order to bring them into line with the standard of  $O=16.00$ .

A glance at the International Table of Atomic Weights will show that very few of the elements form oxygen compounds suitable for analysis, and the statement to the contrary, found in most elementary textbooks, is clearly inaccurate. A great number of equivalents, on the contrary, have been referred to  $Ag=107.88$ . This number can be brought into ratio with oxygen only through the intermediate link of nitrogen, the atomic weight of which has been most accurately determined by the analysis of ammonia. The latter involves the ratio 1.008 to get the ratio to  $O=16.00$ . But the atomic weight of chlorine has been most accurately determined directly to  $H=1.00$ , and the ratio  $Ag:Cl$  is also very accurately known. From hydrogen to chlorine, from chlorine to silver, and from silver to a large number of other elements seems to be the most natural proceeding. Oxygen then comes in from the ratio  $H:O$  found by Morley, Scott, and Burt and Edgar. This is now probably one of the most accurately known atomic weights. The above is one instance only of the extraordinary branch-chain methods now necessary in order to get the experimental numbers referred to oxygen.

On the theoretical side the advantages of the hydrogen standard are self-evident. No one has ever pretended that the adoption of oxygen as the unit has any theoretical significance; the retention of the number  $O=16.00$  alone is sufficient to prove this. The accumulating evidence on the physical side, such as atomic numbers, the structure of atomic nuclei, the periodic law, and the like, all points unmistakably to the mass of the hydrogen atom as the natural standard. It is no longer correct to say, as is still done in elementary books, and even in other quarters, that the standard of atomic weights is a matter of indifference, and that, apart from experimental reasons, one element is as good as another. We have almost certain evidence that the hydrogen nucleus is a fundamental constituent of all atoms. Prout's hypothesis being thus reinstated, there can be no doubt as to the suitable standard of atomic weights, and Dalton's choice has had a most remarkable vindication.

When, therefore, arguments are advanced based on the standard  $O=16.00$ , it seems time to suggest that some steps should be taken to put an end to the prevailing confusion. Physicists have never taken kindly to the oxygen standard, and there is no longer any reason why chemists should be given needless trouble. I have, in my elementary lectures, made a practice of using the hydrogen standard, and thus avoiding all the confusion in connection with vapour densities, etc., which comes in with the other system.

There is one other point which seems to me of

importance. On the oxygen scale the atomic weights of a number of elements differ by about half a unit from whole numbers. It has been conjectured that these elements are mixtures of isotopes, with atomic weights which are whole numbers. But if there is anything in the theory of isotopes to justify this, it can only rest on the hydrogen nucleus, and the atomic weight of hydrogen should be taken as unity. If this is done, it is found that the suspected elements are replaced by those not at present under any clouds of suspicion. The following table will illustrate the point:

Element	Atomic Weight $O=16.00$	Atomic Weight $H=1.00$
Chlorine ...	35.45	35.18
Magnesium ...	24.32	24.14
Silicon ...	28.3	28.1
Zinc ...	65.37	64.88
Copper ...	63.57	63.10

It may be that there is some real physical reason for taking  $O=16.00$ , and then supposing that, if some elements deviate from the whole number on this basis, they must be mixtures of isotopes, but this reason has so far escaped my attention.

There seems to me to be a good case for the Committee on Atomic Weights to consider whether the unit  $O=16.00$ , adopted largely on account of the persistence of Ostwald, is any longer necessary. At best it was a temporary decision, and all the reasons which were advanced in its favour have now lost their force. I am convinced that the arguments in favour of a return to Dalton's unit are so cogent that, once they are clearly realised, they will be admitted.

J. R. PARTINGTON.

East London College (University of London),

April 23.

### Mortlake as a Cause of River-windings.

MORTLAKE on the Thames has a place-name which not only accords with the natural history of the place, but also supplies a word which might conveniently be brought into common use to signify a process which plays an important part in the development of every river system, just as the River Meander supplies a word to signify the windings of any river. The area between Barnes and the Thames was formerly an island in the river (Fig. 1), formed by a

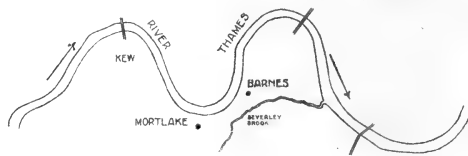

FIG. 1.

division of the stream into a northern and a southern arm reunited at the down-stream ends. The southern arm is now incomplete; the part of it remaining is included in the line of the Beverly Brook, which, having come from the south, turns to the east round a bold curve and joins the Thames. This leaves a gap between the convexity of the curve and the river at the point where it previously divided. This gap now forms the isthmus of a peninsula into which the island has been converted by the partial effacement of the southern arm of the divided river. Here Mortlake stands. It is on or near to the former line of the stream which has been in part effaced. This part has become a dead stream—a mortlake, the word "lake" having been used in the Middle English sense

as signifying a stream. Leland the Chronicler wrote that "there runneth a praty lake out of Sudeley Parke down by the Castle and runneth into Essebourne Brook at the south syde of Winchcombe." And again: "I passed over 2. or 3. small lakes betwixt Chiltinham and Gloucester and they resort to Severne." The word is still used in some places as meaning a stream; children on the Severn banks still sing of the moon as claiming to guide the ship "up the lake."

The first Lord Avebury, in writing of meanders ("Scenery of England"), mentions, as one of the results, "that the loop often remains as a dead river-channel or mortlake." Such loop-lakes are known in America as "oxbows." There is, however, a great difference. In the case of an "oxbow" the loop, formed by a lateral deviation of the river, has been entirely cut off from the main stream. A mortlake may be defined as the line of a closed part of one of the two sections of a river (previously divided so as to surround an island in the stream), the other channel remaining open and serving as a single channel for the river.

Of the two sections of a river enclosing an island, one of them at least must have a curved line. Two straight lines cannot enclose a space. If, then, the whole or a part of the stream in one of the sections be effaced, the remaining section, now forming the whole of the river, must have a more or less curved line. It must be a river-winding. The form and the length of it will, of course, depend on the shape and on the size of the former island. Thus a result of the formation of a mortlake may be one of those meanders or river-windings which are a familiar and picturesque feature in the landscape. The explanation of them has been a puzzle from classic times until the present. The subject was discussed at length by six contributors to NATURE in November and December, 1907.

I have come to the conclusion that the conversion of river-islands into areas bounded by single streams, more or less curved, is part of the ordinary course of river development. This, in my view, may be briefly stated thus: A newly exposed part of the earth's surface receives the rainfall on every square inch of it, but the water will not flow away in the form of a sheet; minute runnels form, and these will not be in straight lines parallel to each other. I cannot imagine straight "primary consequent streams" as they are sometimes depicted. Even slight obstructions would turn them aside so that they would meet and coalesce, thus forming a miniature network of streams, each of the meshes enclosing an islet. Then the water on the up-stream side of every islet will have alternative routes before it. These routes may, for a time, be equally easy, but they will not continue to be so; one of them will be preferred, and this may not be the most direct. The stream which continues may be the one which meets with the least obstruction, or it may be the one most necessary for continuance as having to receive longer or more numerous tributaries. A channel no longer needed will cease to be used; it will silt up. Then the islet will become continuous with an adjoining islet. This process being many times repeated, islands of increasing size—which may be large and, possibly, of very great extent—will result. Ultimately, they will all cease to be islands, in the absence of need for two channels. The development, in my view, is not from "primary streams" into a "complicated network" of channels, but from the complexity of a network of channels towards the simplicity of one principal stream with tributaries converging towards it. Certain it is that in a river system as we see it there is no network.

I do not wish to suggest that the formation of mortlakes is the only cause of river windings. Thirty-

seven years ago I pointed out (in a paper read before a local society, and printed at the time) the influence of tributaries as one cause; and I recognise others. But the same laws govern the development of all rivers. Although Herodotus found the rivers of Egypt to be different from other rivers, I, in imagination, see the life-history of the Nile as very strikingly depicted in its present course. I have elsewhere shown ("The Lower Severn," Proceedings of the Cotteswold Naturalists' Field Club, xvi., 1909) an outline picture of a thousand miles of the Nile below Khartum compared with one of ten miles of the Severn below Gloucester. The resemblance is so close as to lead to the remark that it almost seemed as if the one figure had been drawn in ink on the second page of a sheet of paper and the other by pressing the ink before it was dry against the opposite page. The size of the two rivers and the character of the rock formations being so very different, it is at least remarkable that the course of the two should be so very much alike. In the *Times* of a recent date (March 15) is a report from Dr. Chalmers Mitchell of his view from an aeroplane in passing above the railway between Wady Halfa and Abu Hamed. He saw "huge cliff-lines submerged at intervals by desert," which suggested the "proper bed" of the Nile. It is really a relic of the time when the area, now partly enclosed by the great sickle-shaped curve of the Nile, was a huge river-island two hundred miles wide and five hundred miles long. That which Dr. Chalmers Mitchell saw was the line of the eastern arm of the Nile; it is now the line of a long mortlake.

T. S. ELLIS.

59 Park Road, Gloucester.

#### Eiffel Tower Wireless Time-Signals.

It may interest a number of readers of NATURE to know that the Eiffel Tower is at present sending out two additional sets of "scientific" time-signals. The scientific signals are arranged as a time-vernier, gaining about one beat in fifty. They have hitherto been sent at 11.30 p.m. G.M.T., followed at 11.45, after the ordinary time-signal is concluded, by numbers which give the moment of the first and the last signal of the set, according to the standard clock of the Observatory of Paris. A comparison can thus be made with the introduction of a very small error, often not exceeding one-fiftieth of a second. These valuable signals have suffered from two awkward features: In summer time they are inconveniently late, and the purring or snoring note (*ronflée*) on which they are sent is much obscured by atmospherics when the latter are bad, so that sometimes one failed to pick up the identification breaks which occur at the end of every sixty beats.

In addition to the old series, which remain unchanged, two new series are now being sent; these are on wave-length 2600 metres and a high musical note that cannot be confused with atmospherics. Otherwise they are the same as the original—300 dots, the 60th, 120th, 180th, and 240th being suppressed. They are sent: (1) at 10.30 a.m. G.M.T., the comparison numbers giving Paris time following after completion of the 10.45 ordinary signal; and (2) at 11 p.m. G.M.T., the comparison numbers being sent after the 11.45 ordinary signal, along with those which refer to the old 11.30 signal, the two references being distinguished by the letters ML (*musicale*) and RF (*ronflée*) respectively. The new series are beautifully clear, and ought to be of great service to those who require accurate time.

R. A. SAMPSON.

Royal Observatory, Edinburgh, April 17.

### Some Tests of the 100-in. Hooker Telescope.

By DR. GEORGE E. HALE, For. Mem. R.S., Director of the Mount Wilson Observatory.

THE construction of a telescope of very large aperture is necessarily an experiment the final success of which can be determined only by the results of astronomical observations. After the mechanical and optical difficulties have been overcome, there remain those disturbances of the atmosphere which are of little importance with small apertures and low magnifying powers, but become more and more serious as the diameter of the objective and the scale of the image are multiplied. Thus in undertaking the construction of a reflecting telescope of 100-in. aperture, while we had the advantage of experience with the 60-in. Mount Wilson reflector, we frankly recognised that the outcome must remain in question until the completion of tests made under customary atmospheric conditions.

As contrasted with the 60-in. reflector, the full measure of advantage attainable under perfect atmospheric conditions would be as follows:

	Light collecting power	Scale of focal image	Resolving power
60-in. reflector	1	1	1
100-in. " "	2.8	1.7	1.7

This means that either in direct photography or in spectrographic work with a given dispersion the larger instrument should bring within range stars about one magnitude beyond the reach of the 60-in. The advantage thus gained would be important, as two illustrations, out of many that might be given, will suffice to show. Only two or three of the brightest stars can be studied with the most powerful spectrograph of the 60-in. telescope, which is not much inferior in dispersion to the instrument used by Rowland in his work on the solar spectrum. The same high dispersion, if employed with the 100-in. reflector, could be applied to several times as many stars, representing most of the principal stages of stellar evolution. At the other end of the magnitude scale, the 100-in. telescope should be able to record photographically many millions of stars too faint to be reached by the 60-in.

In the second place, the increased scale of the focal image, whether in the principal focus of the large mirror or at the Cassegrain focus, where the 100-in. telescope has an equivalent focal length of 134 ft., should separate more widely the crowded stars at the centre of globular star clusters, thus permitting them to be studied without confusion with one another; it should increase the precision of measurement in such difficult work, for example, as that involved in detecting the very small changes in the configuration of spiral nebulae caused by their internal motions; and, to give no other illustrations, it should permit minute details, not previously photographed, to be recorded on negatives of such objects as the moon.

Finally, the increased theoretical resolving power, if realisable in practice, should permit the

visual measurement of the components of very close binary stars, which cannot be separated by the smaller instrument, not merely because of the overlapping of their images during periods of poor seeing, but also because of their inherent irresolvability due to the wave-length of light itself.

In spite of the fact that most of the tests have been applied under the comparatively poor atmospheric conditions of the winter season, the early results are very satisfactory. It has become possible to include in our regular spectrographic programme stars one magnitude below those studied with the 60-in., so that the radial velocities and spectroscopic parallaxes of stars down to the tenth magnitude are being measured in large numbers by Dr. Adams and his associates. This involves a notable extension of the range of our investigations on the structure and motions of the stellar universe. Similarly, an important advance in our researches on stellar evolution has also been rendered possible, bringing to light new and curious types of stellar spectra and interesting phenomena in the spectra of variable stars at minimum brightness. The spectra of the long-period red variables of the Md class, most of which were too faint for satisfactory observation with the 60-in., are now being systematically photographed by Dr. Merrill with the Hooker telescope. One of these stars has been found to show the chief nebular lines in its spectrum, a matter of peculiar interest because of the fact that these lines have previously been observed only in nebulae and in temporary stars. With low dispersion, the spectra of stars of the fourteenth magnitude have been photographed by Dr. Shapley with moderate exposures at the centre of globular clusters.

The preliminary results of the photography of nebulae have also been very satisfactory, both at the principal (Newtonian) focus of the 100-in. mirror and at the 134-ft. Cassegrain focus. The photographs indicate an important advance over the 60-in. telescope, and leave no doubt that the desired increase in the precision of measurement, rendered possible by the larger scale of the images, will aid materially in the study of the internal and proper motions of spiral nebulae. A striking feature of these negatives, as compared with those taken with the 60-in., is the increased contrast of the minute nuclei in spiral nebulae, which are brought into greater prominence by the larger aperture. This will render available for measurement a large number of sharply defined symmetrical points.

The character of the images may be judged from the accompanying reproduction of a photograph of the moon (Fig. 1), taken by Mr. Francis G. Pease at the 134-ft. Cassegrain focus on September 15, 1919. This negative, like others obtained by Mr. Pease with the Hooker telescope, shows smaller details of structure than we have previously been able to photograph.

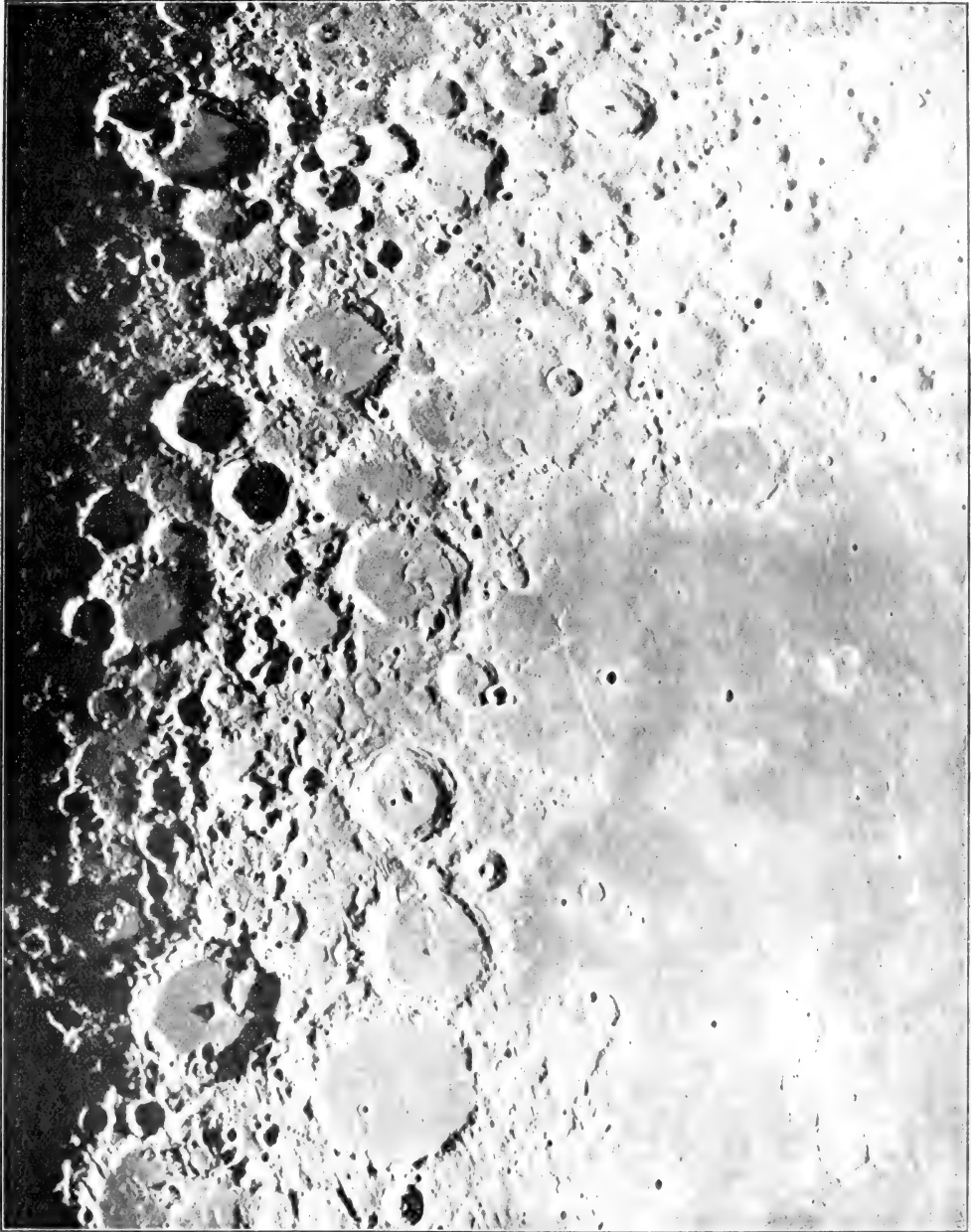

FIG. 1.—North central portion of the moon at last quarter. Photographed with the Hooker telescope of the Mount Wilson Observatory September 15, 1919, by Mr. F. G. Pease. Scale: 1 in. = about 90 miles.

Perhaps the most interesting application of the 100-in. telescope hitherto made is that rendered possible by the utilisation of Michelson's interference method for the measurement of the spectroscopic binary star Capella. The method consists in completely covering the 100-in. mirror by a screen in which are two slits, which can be placed at any desired distance apart. Light coming from a point source, such as a single star at a very great distance from the earth, passes through the two slits and is brought to focus by the large mirror. A system of interference fringes may then be seen under a telescopic power of about 5000 diameters, which are sharply defined even on a night of poor seeing. If the star is single, the fringes remain visible even when the slits are separated by the full diameter of the 100-in. mirror. But if the star is a very close double, the fringes will disappear (assuming the members of the pair to be nearly equal in brightness) when the slits, set by observation at the proper position angle, are moved apart to a distance that depends upon the angular distance between the star's components.<sup>1</sup>

The following measures of Capella, made by Dr. Anderson, indicate the possibilities of the method:

	Position angle	Distance
1919, December 30 ...	148° 0'	0'0418
1920, February 13 ...	5° 0'	0'0458
" " 14 ...	1° 0'	0'0451
" " 15 ...	356° 4'	0'0443
" March 15 ...	242° 0'	0'0505

<sup>1</sup> In practice, a somewhat different technique, giving the same result with higher precision, is employed by Dr. Anderson.

When plotted, these points fall accurately on an ellipse. The method, which has been tested experimentally in the laboratory, not only allows binaries that cannot be resolved by other means to be measured with very high precision, but also permits *twice* the theoretical resolving power of the Hooker telescope to be attained in practice, even when the seeing is poor.

This application of the interferometer was suggested by Prof. Michelson many years ago and used by him in the measurement of the diameter of Jupiter's satellites at the Lick Observatory in 1891. The possibility of seeing the fringes under ordinary atmospheric conditions with the full aperture of the Hooker telescope was demonstrated by Prof. Michelson during a visit to Mount Wilson last September. The method will have many applications, and should be utilised by observers with instruments of moderate aperture who wish to resolve close doubles and to increase greatly the precision of their measures.<sup>2</sup>

From this record of the preliminary tests of the Hooker telescope it will be seen that in light-collecting power, in the increased scale and improved photographic definition, and in the added possibilities of optical resolution attained through the application of Michelson's method, the new instrument has not disappointed our hopes. We must now endeavour to utilise these advantages in the extension and development of our researches on stellar evolution and the structure of the universe.

<sup>2</sup> For an account of this method, see Michelson, "On the Application of Interference Methods to Astronomical Measurements," *Phil. Mag.*, July 1890.

## Artillery Science.

By SIR GEORGE GREENHILL, F.R.S.

THE religious attachment of the officer of artillery to the practice of his predecessors" was described by Benjamin Robins about 1740, and his attachment persisted with unimpaired devotion right up to the war. There he found himself outclassed at the outset, out-gunned and out-gunnered; the little artillery he took out was small and puny, and not of the right sort required—"pas de celle qu'il faut." Our Artillery Authority cannot be said to have understood what it spelt, the word "artillery."

On the assumption of our politicians that this country was never going to war again, an interdict had been laid on England of seven lean years; and when they were up, the lean years got an extension leading right up into the war.

A well-disciplined Army Council had been formed, obsequious to the Minister, with instructions to resist all suggestions of military progress—housed in a magnificent new palace in Whitehall, the barracks of an army of War Office clerks, provided out of a reduction of the Regular soldiers.

Temple of Victory it cannot be called. The stone slab over the portal is still blank, ready to

receive the appropriate motto, with no derangement in the epitaph:

PACEM PARA BELLUM SI VIS.

The mentality of the Army Council can be glimpsed in its attitude to Flight in warfare. The Wright brothers framed on their wall the egregious answer of the Secretary in the official jargon: "I have nothing to add to my last letter to you. The War Office is not disposed to enter into relations with any manufacturers of airplanes."

This was in March, 1913, and only the next year we were running the risk of our whole Army being completely surrounded, with no airmen to scout for us. The evil name "Maubeuge" would have been written on our history as indelibly as "Jena" and "Sedan" were on others. No wonder the German squadrons could fly all over England and London with impunity, in the face of all our air defence.

The belated arrival in the war of the Tank is another similar story. Military prejudice preferred to muddle along in a stalemate of trench



warfare, at a cost of two years' delay, of intolerable waste and slaughter, before it could be persuaded to take up this new revolutionary idea. The German advance walked over our trench warfare system in the spring of 1918, and took all our guns.

Technically bold as a lion, our military soul was intellectually a very timid bird, and shuddered at any suggestion of novelty and progress. Whenever I asked an artillery officer: "What did you learn as a cadet at the Royal Military Academy?" the answer came in the invariable formula: "I learnt nothing when I was at the Shop."

The Shop! Not a workshop, except so far as the "ca' canny" slogan would carry. And yet we find this nickname, full of meaning and contemptuous, is countenanced by authority, from the Governor downward, as a surrender of all Prestige. It should be made a crime of a military nature ever to use such a derisory, contemptuous *alias*, too descriptive of the obsolete, decadent traditions of the place.

The Army List gives a whole page to the catalogue of the staff of the Royal Military Academy, Woolwich, full of official Army titles. Low down on the page a line is to be seen, and under it a list of half a dozen names, the civilian instructors who should carry out the real work of the place.

Nothing was ever so Prussian, not even in Prussia. But the line has a more sinister meaning still; it emphasises one of the important reforms of the Cardwell scheme, and excludes all those appearing under it from retiring allowance, while every Civil Service clerk is *pukka*, subsidised and covenanted, on the strength of a Civil Service examination, medical or otherwise. A sailor would compare the Academy to a boat trimming too much by the stern, with too many cocked hats in the stern sheets.

This the only source of supply of our artillery officer does not run clear; it commissions him with the brand of second class, with all the mental outlook implied of indolence and apathy.

Thinking officers among them deplore the arrangement, and are beginning to confess to their deficiency of all artillery science in the war; but, with military docility, they are afraid to say much, and formerly, before the war, would bring upon themselves the scowl of the senior officer, and the disparaging epithet of "scientific."

The old school aimed at being as close an imitation of cavalry as possible, and a stable boy was the noblest gunner of them all, prepared to carry out a gallop of a few seconds over Woolwich Common, with a little gun on wheels behind. The idea was deprecated of firing off his gun, in imitation of the practice exacted in real warfare, as likely to wear the gun out, and so provided a good excuse.

But here is a Disadvantage of Durability, especially in artillery, and most of all in its traditions.

NO. 2635, VOL. 105.]

Our guns were always obsolete when they were most wanted.

So this gunner preferred to seek the seclusion of his stable before the guns began to shoot; he was encouraged to be gun-shy, and to despise any sort of artillery that could not go at a gallop behind horses. His favourite arm was this *corps d'élite*, the plaything of the I.R.C. (Idle Rich Class), very expensive to maintain in peace, and of little proved utility in war commensurate with the cost.

But motor artillery has come to stay as the real artillery, unless "bilked" by the old school. This was the sort required in the war, and in peace it is not eating its head off, like horses in a stable, and is never tired on the march. De Wet was run to earth very soon by a squadron of motor-cars never giving his horses any rest: what our old cavalry tactics never could effect.

The civilian has grasped the paramount importance in modern warfare of heavy long-range artillery; and he must be careful that the lesson has not been lost on the regular gunner, or allow him to return to his ancient, worn-out traditions. Such long-range fire was declared officially of no military value, until our poor fellows came under the accurate fire of the long-range German howitzer, with no protection from our own side.

German science could always astonish our sleepy regular gunner, in providing a gun that could bombard Paris, and London too, when it could be brought up as near as Calais. How much longer would the war have lasted then? although the fire was declared of no military importance by those who did not suffer under it.

This advanced German artillery science, as well as of the chemical and aeronautical science, was the outcome and product of the Military Technical Academy in Berlin, a magnificent institution such as our Ministers thought England was too poor to afford. Sixty officers were under instruction there in a three years' course more thorough than exacted to-day for honours in the university. No wonder our feeble amateur military science went down before such superior training.

I was once privileged to visit the Berlin Academy, under the guidance of Prof. Cranz, and to inspect the instruction in all branches—ballistics, aeronautics, and electricity. There, for one thing, I remember seeing the electrical class occupied in making the antennæ of wireless telegraphy. This was ten years ago, when aeronautical science and flight were derided by our War Office authority, and opposed on the score of economy. We shall not feel safe in England until we set up a rival institution, but it must be as far apart as possible from the Woolwich tradition. South Kensington would be an ideal site, say in the building of the old School of Mines and Naval Architecture and alongside the Imperial College of Science, as the Berlin Academy is a neighbour of the Charlottenburg Technical High School, with the same

advantage of the free use of laboratories and special professorial lectures. Our artillery will then be able to throw off the badge of second class and claim to take the rank of first class again.

A cadet military college can only carry on the initial stage of the education of the artillery officer, and for that it is better for him not to be isolated too early from the other military branches. Many a scheme for the amalgamation of the military colleges will be found pigeon-holed in the War Office, awaiting the pressure required to be exerted on the opportunist. The artillery could then make its selection from the whole list of Army candidates, and with proper prestige secure the pick of the bunch. It would not then have to submit, as at present, to put up with the leavings of the Royal Engineers, and to be branded as second class.

The pick of the officers, after some military service, would be selected for a further course at our equivalent of the Berlin Military Technical Academy, where neither indolence nor apathy was tolerated, but stigmatised as bad form, so I was informed. Here they would find a standard of uni-

versity rank, in a centre of keen intellectual activity.

But the atmosphere of all Woolwich is close and ill-ventilated. Throw open the window, and let in air and light! The Royal Military Academy there is unhealthy, physically as well as mentally, seated on the safety-valve of the main drainage of all South London. The buildings are antiquated and worn-out, fit only to be mined and blown up at the moon, and then a more healthy atmosphere, physical and intellectual, might be formed. With the solidarity of any other trade union, Woolwich strongly opposed dilution. But Dilution proved the best material, and carried the war to a successful conclusion, and so the insidious efforts at his elimination in peace must be watched carefully, and countered by a plentiful entry of university candidates from the outside.

The country will never cease to shiver at the recollection of our narrow escape from defeat and utter ruin, and will listen to no specious political views of opportunist economy likely to place us again in a state of military inferiority.

### Obituary.

DR. RUDOLPH MESSEL, F.R.S.

DR. R. MESSEL died on Sunday, April 18, in his seventy-third year. Death came to him as a happy release but to a large circle of friends familiar with his social qualities and many acts of unostentatious generosity the loss is severe and will be deeply mourned. He had long been one of the most notable of our chemical manufacturers as pioneer founder of a most important industry, for he was the first to produce sulphuric anhydride from its elements on a large scale.

Messel was born in Darmstadt and came to this country, at the conclusion of his university career, shortly before the Franco-Prussian War; when this broke out he returned to Germany and volunteered for service but owing to a physical disability, I believe, he was drafted into the Army Service Corps and was wounded while on ambulance duty. He lost no time in returning to England and became assistant to the late Dr. Squire, a man of considerable ability and originality. Messel had qualified at Tübingen as a chemist under Strecker, who naturally took an interest in the then infant alizarin industry, as he had worked with alizarin. Strecker foresaw the important part that fuming sulphuric acid was to play in the industry and directed Messel's attention to the fact, suggesting that he might well seek to supply the want. Messel, therefore, was fully conversant with what had been done and when Squire, possessed of the same idea as Strecker, suggested to his assistant that he should set to work on the subject, he was soon ready with a process, having at once resorted

to the use of platinum as a catalyst in order to bring about the interaction of sulphur dioxide with atmospheric oxygen.

A patent was taken out by Squire in 1875 and he and Messel described their process in a paper read to the Chemical Society early in 1876; but this was not published. Their works were erected at Silvertown, on the Thames; the manufacturing process was rapidly developed through Messel's skill and intense devotion to his task. Not alone were English wants soon met but a considerable quantity of the acid was supplied to the German colour-makers. The Badische Anilin- & Soda-Fabrik was led largely to develop the manufacture of the acid in connection with the production of synthetic indigotin; but the "splash" this firm made in 1900, when it published the results of its experiments in considerable detail, was unwarranted. Practically everything essential then put forward had long been a matter of everyday practice with Messel. Had not commercial considerations prevailed, he might well have upset the patents; but he was ever a man of peace, as well as a modest man, so he made no attempt to claim the credit that was his due. He acquired the German patents at a peppercorn price but his former countrymen never had the honesty to do him public justice.

The writer was a frequent visitor at Silvertown in early days and was always impressed by the remarkably systematic manner in which the works were operated. Messel was ever on the look-out for improvements and ever ready to make them. His chief trial in later years was the difficulty he experienced in persuading his conservative British

partners to consent to the scrapping of inefficient plant and the substitution of improved appliances. A man of great energy, he was ready at all times to work twenty-five hours a day for several days together. He long lived on the works in the most modest quarters and his all-seeing eyes were everywhere. In Germany the success of the great chemical works has been mainly due to the effective co-operation of a variety of workers, representing the different sides of the business, supported by a small army of highly disciplined, qualified scientific assistants; but Messel did everything himself: his versatility was astounding; he was not only chemist but also engineer, works manager and business man; he had no scientific staff but only an assistant or two.

Though a German but a German fired with Jewish imagination, Messel appreciated and practised English methods. Aided only by the most modest resources, he long held his place successfully against his rivals in Germany. Probably much of his early success was due to his sympathetic attitude towards his workmen, by whom he was generally beloved; but Messel was not only a worker, he also played hard. In great social request, he knew everyone: Gilbert was one of his great friends. Of late years Messel had been one of the most familiar and popular figures at the Savage Club.

Messel's eminent scientific services to industry were recognised in 1912 by his election into the Royal Society. No other compliment could have given him greater satisfaction. Though a manufacturer, he lived for science and in the atmosphere of science and not the least of his merits is the example he has thus set. H. E. A.

PROF. A. K. HUNTINGTON.

By the regretted death, on April 17, at sixty-four years of age, of Prof. Alfred Kirby Huntington so shortly after relinquishing the chair of metallurgy at King's College, University of London, which he had occupied since 1879, British technical science loses one of its old guard, and both metallurgy and aviation are the poorer by the loss of an indefatigable worker and an outstanding personality.

Though it be admitted that Prof. Huntington's name is linked with no spectacular discovery, his work, beyond its professional duties, was continuous, scholarly, and of marked originality. In both respects he therefore exercised a determinative moulding influence upon the two generations of men he trained in this rapidly widening field of science. His career, indeed, coincided with what we may justly regard as the Renaissance of non-ferrous metallurgy. For nearly forty years he was invariably abreast, more usually in the forefront, of the many new departures which have marked it. A physicist as well as a chemist, his researches on the micro-structure of metals and on "corrosion" have added essentially to our metallographic knowledge; his paper on "The

Concentration of Metalliferous Sulphides by Flotation," read before the Faraday Society in 1905, broke ground which has been gratefully cultivated by others, and provided the starting-point for fresh researches; whilst in the discussion of such diverse technics as those of copper-smelting, cyanidation, nickel metallurgy, etc., many have owed essential enlightenment to his suggestions and criticisms, imparted with a kindly, if somewhat gruff, sententiousness.

Prof. Huntington rendered yeoman service in the earlier development of several of our now important technical associations; thus one recalls his two papers (upon "The Mexican Amalgamation Process" and "The Metallurgy of Nickel and Cobalt") which were read at the first annual meeting of the Society of Chemical Industry in 1882. Later he was actively interested in the formation of the Institution of Mining and Metallurgy, becoming its second president in 1894, and remaining an honoured member of council until his death. The mere enumeration of his contributions to its Transactions occupies a whole page of index. In 1913 he succeeded to the presidential chair of the Institute of Metals, and to that society he gave of his energy and experience with equal freedom. During the war his specialised knowledge of high explosives was placed at the disposal of, and fully utilised by, the Admiralty.

A marked characteristic of Prof. Huntington's metallurgical outlook was its practicality and its constant insistence upon the economic aspect of the problem under consideration. His motto might seem to have been: "First write your equation in economics, and the remaining 20 per cent. of technics will be easily and better supplied thereafter"—though it must be admitted that he could be unsparing if that balance appeared faulty!

Prof. Huntington's intense practical interest in aeronautics, which advancing years were powerless to quench (since, in addition to his exploits in ballooning, he was until quite recently his own pilot and flew his own 'plane), made him famous to a wide circle; but it is to his services to modern metallurgy that special tribute is due.

DR. A. J. CHALMERS.

THE death of Dr. A. J. Chalmers in Calcutta on April 5 causes a gap in the ranks of British workers in tropical medicine, and will also be deeply regretted by his many friends in this country, as well as in the various Colonies in which he held important posts. The son of a Wesleyan minister, Dr. Chalmers was born in London in 1870, but began his career at University College, Liverpool, which at that time formed part of Victoria University. His career in the Medical School during his student days was brilliant, and it was soon apparent that he had a bright future before him. He gained the Holt fellowship of his college in 1890 and 1891, and obtained honours on taking his degree as M.D. Soon after

taking his F.R.C.S. (England), he had a great desire to travel, the tropics especially having an attraction for him, and he joined the West African Medical Service in 1897. He served as a medical officer with the Ashanti Field Force in 1900, and was with the British troops that were besieged in Kumasi, who, after some time, gallantly broke through the native hordes and regained the coast. Dr. Chalmers attended to the sick and wounded with great energy and devotion and was mentioned in despatches by the commanding officer, and received the medal with a clasp. In 1901 he accepted a post under the Ceylon Government as registrar of the Ceylon Medical College. Here his capabilities as administrator and organiser were brought into full play. He soon developed this institution into an excellent medical school, the licence of which is now recognised by the General Medical Council.

While in Ceylon Dr. Chalmers first turned his attention to the tropical diseases that came under his notice, and never spared himself in working among the resident Europeans and natives who came to him. Resigning his position in Ceylon in 1902, so that he might devote more time to the study of tropical diseases and parasitology, he returned to England. It was then that he conceived the idea of writing a much-needed manual on tropical medicine; and in collaboration with his colleague, Dr. Castellani, in Ceylon, he began the work which will remain a monument to his memory. The preparation of "The Manual of Tropical Medicine," which has now reached its third edition, cost him a great amount of time and labour. He was an ardent worker in many fields, and carried on research not only in pathology and bacteriology, but also in parasitology, especially in connection with diseases of the tropics. His work on the Mycetoma will always be connected with his name.

From 1912 Dr. Chalmers devoted more than a year to the study of the cause of pellagra, and in company with Dr. Sambon visited Italy and Rumania. On his return he carried on researches in this country, with the result that cases of pellagra, a disease unknown to be endemic in Great Britain, were found in Hertfordshire and Scotland. Later he visited Egypt and travelled up the Nile with the same object, and accumulated much valuable data in connection with the study of pellagra and other diseases such as endemic hæmaturia.

On his return to England Dr. Chalmers gave some time to the study of the history of medicine, and became an enthusiastic lover of ancient literature—especially that dealing with the medical art. After some time he felt again the call of the East, and often expressed a wish to return there. In 1913 he accepted a post as director of the Wellcome Research Laboratories at Khartum, which he filled with conspicuous success. He became a member of the Central Sanitary Board, and also of the Sleeping Sickness Commission of the Sudan.

Dr. Chalmers continued there until a short time ago, when he left the Sudan, accompanied by his wife, with the object of returning home *via* India, Japan, and America, and when in Calcutta was unfortunately seized with his fatal illness.

#### PROF. L. T. O'SHEA.

LUCIUS TRANT O'SHEA, professor of applied chemistry in the University of Sheffield, who died suddenly from cerebral hæmorrhage on April 18 at sixty-two years of age, was educated at the Grammar School and at Owens College, Manchester, and went to Sheffield in 1880 as assistant lecturer and demonstrator in chemistry at Firth College. In 1890 he became lecturer in mining chemistry, and in 1905 professor of applied chemistry, in the university. For the past twenty years he had specialised in the study of explosives as applied to mining operations, and of the coking of coal in retort ovens. He also did much work on the safety of coal mines, particularly with regard to the effect of the gases given off by the coal and of coal dust on explosions in mines. He was a fellow of the Chemical Society, a member of the Society of Chemical Industry, and hon. secretary of the Institute of Mining Engineers.

Prof. O'Shea published "A Contribution to the History of the Constitution of Bleaching Powder," and "The Retention of Lead by Filter Paper," about the time of the lead-poisoning epidemic in Sheffield more than thirty years ago, and some years later, with Dr. W. M. Hicks, he produced electro-iron of almost perfect purity, which the present writer had the privilege of using for experiments when helping to lay the foundations of theoretical steel metallurgy, for which pure iron was required as a basis for study. He also published "A Note on the Woolwich Testing Station," "A Testing Station for Mining Explosives," and "The Safety of High Explosives, with Special Reference to Methods of Testing."

In 1901 Prof. O'Shea went out to the South African War in command of a detachment of the 1st West Yorks Royal Engineer Volunteers, remained until the declaration of peace, and was given the Queen's medal with five clasps. In 1914 he was made O.C. of the O.T.C., Sheffield University, with the rank of captain in the unattached Territorial Force, and he was an energetic and inspiring leader.

Prof. O'Shea was not able to devote a large proportion of his time to research, but he will be greatly missed for the painstaking work he did in the training of students in chemistry as applied to mining and to the coking of coal, and in the general preparation of fuel for industry.

A. McW.

A MAN who had great influence in the application of science to the use and convenience of man has passed away in MR. THEODORE N. VAIL, well known to many in England, as well as in

his homeland across the Atlantic. Mr. Vail's life-work was the development of the "Bell" telephone system in the United States, and it is to his personal initiative that the enormous growth of the American Telephone and Telegraph Co., of which he was for many years the president, is largely due. He was a rare combination of the business man, quick to see opportunities and far-seeing in his policy, and the patient, scientific worker. It is not too much to say that the success of the American telephone system, culminating in the achievement of speech from New York to San Francisco, is mainly due to the unremitting attention that he gave to the organisation and prosecution of research, and the technical laboratories that he initiated are the finest in any industrial undertaking. It is pleasant to think that, unlike many workers on parallel lines, Mr. Vail lived to behold the fruit of his labours.

THE death is announced, at the age of eighty years, of DR. JOHN A. BRASHEAR, the founder of the well-known American firm of makers of astronomical and physical instruments. In his youth, while working as a machinist, Dr. Brashear devoted himself to the study of astronomy, and made his first telescope while pursuing this hobby after his working hours. With this instrument he made many observations, as a result of which he contributed articles to the daily Press on comets, etc. These attracted the attention of Mr. William Shaw, whose offer to build and equip for him a good shop for the production of astronomical instruments was accepted. This ultimately developed into the works of the John A. Brashear Co. at Pittsburgh, which turns out instruments that are used in observatories all over the world. Dr. Brashear received the honorary doctorate from Pittsburgh and other universities, and from 1901 to 1904 was acting chancellor of the Western University of Pennsylvania, now the University of Pittsburgh. He was a member of many American and foreign scientific societies, and was a recognised authority on solar phenomena, lunar craters, and other subjects.

MR. JAMES METCALFE, who died on April 12, was born in 1847, and was locomotive superintendent of the Manchester and Milford Railway from 1867 to 1880. He was afterwards managing director of the Patent Exhaust Steam Injector Co., whose injectors are extensively used in locomotives. Mr. Metcalfe was elected a member of the Institution of Mechanical Engineers in 1906.

THE death is announced of MR. FRANK EDWARD PRIEST as having taken place on April 14. Mr. Priest was born in 1860, and was chiefly interested in railways, waterworks, and road and sewerage works. He took a great interest in aeronautics, and at the time of his death he was chairman of Messrs. A. V. Roe and Co., Ltd. He was elected a member of the Institution of Civil Engineers in 1896.

## Notes.

FURTHER news from Capt. Roald Amundsen fails to explain his movements. According to the *Times* of April 23, a message has been received in Norway from the wireless station on the Anadir to the effect that the expedition will arrive at Nome, Alaska, at the end of July. Nome is the port Amundsen reached on his accomplishment of the North-West Passage in the *Gjoa* in 1905. Possibly his ambitions include the North-West Passage before starting on his North Polar journey. These two difficult journeys, in addition to the discovery of the South Pole and the not improbable attainment of the North Pole, would be a remarkable record for one man. A start on the polar drift from Bering Strait or Point Barrow entails a longer route than Amundsen had originally intended, so that he may be calling at Nome for extra stores. News of the arrival of Amundsen himself at Anadir needs confirmation.

Now that political and social conditions are more favourable in the Near East, a certain recrudescence of archaeological activity is evident. The recent discoveries of M. Hatzidakis at Mallia, in Crete, have been followed by a further discovery west of Candia. M. Xanthoudides has excavated a Cretan palace, which appears to date for the most part from the end of the Middle Minoan period to the end of the first Late Minoan period. The most important discovery made in the palace was a series of colossal bronze double-axes, measuring several feet in length in some cases. No such axes of this size have yet been found on Cretan sites, and their purpose is for the present obscure. Another excavation by M. Xanthoudides near Candia brought to light some pottery of Early Minoan date of a peculiar type. Similar pottery has been found only at one other site in Crete, and it does not appear to be typically Cretan. In shape the vases found resemble the so-called Minyan ware. In technique they have no parallel in Cretan wares. The detailed publication of both these excavations will be awaited with the greatest interest.

APPLICATIONS for grants in aid of scientific investigations bearing on agriculture are receivable by the Ministry of Agriculture and Fisheries not later than May 15. They must be made upon Form A.230/1, copies of which are obtainable upon application to the General Secretary, Ministry of Agriculture and Fisheries, 72 Victoria Street, S.W.1.

THE Minister of Health has appointed a Committee to consider and advise on the legislative and administrative measures to be taken for the effective control of the quality and authenticity of such therapeutic substances offered for sale to the public as cannot be tested adequately by direct chemical means. The members of the Committee are:—Sir Mackenzie Chalmers (chairman), Dr. H. H. Dale, Dr. G. F. McCleary, Mr. A. B. MacLachlan, and Dr. C. J. Martin. The secretary is Dr. E. W. Adams, of the Ministry of Health.

THE following have been elected officers and council of the Society of Antiquaries of London:—*President*:

Sir C. Hercules Read. *Treasurer*: Mr. W. Minet. *Director*: Sir Edward W. Brabrook. *Secretary*: Mr. C. R. Peers. *Council*: Sir W. Martin Conway, Mr. V. B. Crowther-Beynon, Mr. H. R. H. Hall, Mr. W. J. Hemp, Mr. A. F. Hill, Mr. C. F. Jenkinson, Sir Matthew I. Joyce, Mr. C. L. Kingsford, Lt.-Col. G. B. Croft Lyons, Prof. J. L. Myres, Lord Northbourne, Prof. E. Prior, Mr. J. E. Pritchard, Mr. H. W. Sanders, Major G. T. Harley Thomas, Mr. R. Campbell Thompson, and Mr. W. H. Aymer Vallance.

THREE important scientific appointments will shortly be made by the British Cotton Industry Research Association, and the council of the association invites applications from qualified candidates. The posts to be filled are those of the heads of the departments of colloid chemistry and physics, organic chemistry, and botany. The minimum salary offered in each case is 100*l.* per annum. Applications, accompanied by the names of two referees, must be received not later than Saturday, May 22. Forms of application and any further information may be obtained from the Director, British Cotton Industry Research Association, 108 Deansgate, Manchester.

INFLUENZA is abating somewhat in its severity, according to the latest weekly returns of the Registrar-General. The deaths from the disease for the week ending April 17 numbered only 306 for the ninety-six great towns of England and Wales, whilst for the three preceding weeks the deaths were 392, 379, and 332. A similar decrease is shown in the deaths for London, which for the week ending April 17 numbered 101, and for the three preceding weeks the deaths were 131, 124, and 105. The returns also show a decrease in the deaths from pneumonia and bronchitis. The age incidence of the present influenza epidemic resembles somewhat the character of the attacks in 1918 and 1919, which were entirely different, so far as age incidence goes, from previous attacks since 1890. There seems, however, now a tendency to revert somewhat to the former age incidence. In the present epidemic the deaths in London during the last twenty-six weeks numbered 1056, and of these 16 per cent. occurred between the ages of 0 and 20, 36 per cent. between 20 and 45, and 48 per cent. at ages above 45 years. In the virulent attacks of 1918 and 1919 the deaths were about 24 per cent. between the ages of 0 and 20, 46 per cent. from 20 to 45, and 30 per cent. above 45 years, the able-bodied being attacked most severely. The maximum number of deaths in any week in London during the present epidemic was 131, whilst in the summer epidemic of 1918 the deaths in one week numbered 287, and in the autumn of 1918 the deaths from influenza for two successive weeks, November 2 and 9, amounted to 2458 and 2433. For the ninety-six great towns the deaths for the same two weeks in November were respectively 7412 and 7557, against 392 in the week ending March 27 in the present epidemic.

IN *Man* for April Sir W. Ridgeway describes two wooden Maori daggers, part of a collection brought home by the late Col. Honner after the first Maori war in 1840-41. It was at first suggested that these implements were Potuki, or "flax-beaters," and it

was doubted whether the Maori did use daggers. But Mr. Henry Balfour has described a bone dagger from the Chatham Islands, and some cultural similarities indicate a link between those islands and New Zealand, especially the Otago district. It is now certain that the Maori did use daggers made of wood and bone. As regards the Potuki, there is a class of beautifully carved examples which can never have been put to any practical use. Their exact function has not been recorded, but they were, perhaps, signs of dignity in the tribe. Sir W. Ridgeway remarks that the paper mulberry, from which tapa cloth was made, was brought to New Zealand by Maori immigrants. But it did not thrive, and the tapa-beater, so important in the social life of Polynesia, would thus fall out of practical use. "My suggestion is that it retained only a ceremonial significance, and that its parallel straight grooves conditioned the type of decoration which the Maoris subsequently applied to it."

IN the *Journal of the Manchester Egyptian and Oriental Society* for 1918-19, recently published, Mr. W. J. Perry discusses the significance of the search for amber in antiquity in connection with the megalithic problem. He supposes that the amber used for decorative purposes in the Mycenaean age may have been found in the Adriatic. It is not easy, however, to see why it should have been so readily adopted as a form of wealth, as it does not possess the attractiveness of gold and pearls. Mr. Perry suggests as an explanation of its value that amber, a solidified resin, may have been associated with the productions of certain trees venerated in Egypt as the source of resinous substances used in mummification and other death-rites. As a further explanation he refers to the Chinese use of jade and gold, supposed to convey vitality to those who consumed them. "In the case of the Chinese, whose civilisation can be accounted for on the hypothesis of a cultural movement across Asia from goldfield to goldfield, the desire for life, health, and immortality has played an important part in the production of philosophical systems, and thus it is possible that their civilisation itself owes its existence to that instinctive process." The theory is certainly ingenious, but the evidence in its support is still scanty, and the analogy of Chinese or Egyptian beliefs with the search for amber in Europe must be accepted with some caution.

THE trade routes of the British Empire in Africa is the subject of a paper by Mr. G. F. Scott Elliott in the *Journal of the Royal Society of Arts* for April 2 (vol. lxxviii., No. 3515). Mr. Scott Elliott approaches the problem of future rail and steamer routes from a geographical point of view. He emphasises the location of the plateau regions in Central Africa, each of which above 5000 ft. is a possible centre for European settlement, civilisation, and trade. The problem as he sees it is to link these interior regions with British seaports by lines through British territory. He discusses at length the possible routes for railways linking Lakes Nyassa, Tanganyika, Victoria, Edward, and Albert. These lines, with the construction of a railway from Kashitu, on the Bulawayo-

Katanga line, would complete a Cape-to-Cairo route within British territory.

The annual report on the Nile gauges and rainfall of the Nile Valley ceased publication during the war, the last number being that for 1912, published in 1914. The work has now been transferred from the Survey Department to the Ministry of Public Works, which publishes the records of the gauges for 1913 to 1918 as Physical Department Paper No. 1. In order to reduce the number of data, five-day means are given for twenty representative gauges between the delta barrage and Entebbe, on Lake Victoria. Tables are also given of monthly means for each of the six years, and the actual discharges on certain days at several stations on the main Nile and Blue Nile. These discharges were measured by the current meter, which Mr. H. E. Hurst, the author of the report, calculates has a probable error of not more than about 3 per cent.

Two papers published recently by the Ministry of Agriculture and Fisheries (Series II., Sea Fisheries, vol. iv., Nos. 1 and 2) deal with the method of determining the age of fishes by inspection of the scales. It is well known that the material of the latter structures is laid down in more or less regular layers, and that there are differences between the substance deposited in the warmer, and that laid down in the colder, months. By counting these rings, then, an estimate of the age of the fish can be made. The method is not applicable to all scale-bearing fishes, and there has been much discussion as to its trustworthiness. In the first of the papers to which reference is here made Mr. R. E. Savage describes the structure of various scales as elucidated by special reagents and studied under polarised light. In the second paper Miss R. M. Lee has made a critical review of most of the important memoirs dealing with scale-markings, and subjected selected series of measurements to mathematical tests. Her general conclusions are that, with certain precautions, the method is trustworthy.

The climate and weather of the Falkland Islands and South Georgia is the subject of a memoir compiled by Mr. C. E. P. Brooks, and published by the Meteorological Office as Geophysical Memoir No. 15. The Falkland Islands observations are all from Cape Pembroke lighthouse with the exception of a few discontinuous series from Port Stanley. The Cape Pembroke records date from the visit of the *Scotia* in 1903, when Dr. W. S. Bruce and Mr. R. C. Mossman started observations there in connection with their records in the Weddell Sea. The scanty South Georgia records are the result partly of various scientific expeditions, but are mainly due to the enterprise of the Argentine Fishery Co. in Cumberland Bay. Summaries of all available data, including those previously published, are given in the memoir.

The Danish Meteorological Institute has published its issue for 1919 on the state of the ice in Arctic seas. As usual, the publication is in both Danish and English, and is well illustrated with charts. Information was scarce from the Beaufort and Bering Seas, Baffin Bay, and the western part of Davis

Strait. In Spitsbergen seas the state of ice was about normal; the pack-ice off the west coast in April and May disappeared in June, and did not return throughout the summer. The ice in the fjords did not break up until May, which is later than usual and two months later than this year. The coasts of Iceland were singularly free from ice throughout the year except for a few days on the north-east in spring, and again in summer. Icebergs on the Newfoundland banks were normal in number and distribution. The Kara Sea, as usual, was navigable in the south and east in September, but there is no information for earlier summer months.

The attention of systematic students of the Arachnida may advantageously be directed to J. Hewitt's "Survey of the Solifugæ of South Africa" (Ann. Transvaal Mus., vol. vii., part 1, 1919), in which clear generic and specific diagnoses are illustrated by structural drawings and by a series of excellently reproduced photographs. E. A. McGregor's paper on the "red spiders" (*Tetranych*) of America (Proc. U.S. Nat. Mus., vol. lvi., 1919) is another recent arachnological publication of importance.

A CONTRIBUTION of importance to Cetacean embryology has been made by Dr. F. E. Beddard, who describes (Ann. Durban Mus., vol. ii., part 4, 1919) two embryos of the sperm whale of an earlier stage than has hitherto been observed. The smaller, measuring only 114 mm. in length, has the relatively short head flexed ventralwards, so that its long axis is almost at right angles to that of the body, while the lower jaw projects beyond the upper; the tail-fin is narrow and ovate in form.

In a memoir on "The Theoretical Determination of the Longitudinal Seiches of Lake Geneva" (Edin. Roy. Soc. Trans., vol. lii., 1920, pp. 629-42), Messrs. Doodson, Carey, and Baldwin have applied Proudman's general solution (Lond. Math. Soc. Proc., vol. xiv., p. 240) to the particular case of Lake Geneva. The dimensions of the lake along thirty-one sections being obtained from Hornlimann and Delebecque's map, the durations of the first three periods were found to be 74.45, 35.1, and 28 minutes. According to Forel's observations (with a slightly different zero-plane), the period of the uninodal oscillation is 73.5 minutes, and of the binodal oscillations 35.5 minutes. The positions of the nodes of the uninodal and binodal oscillations are also determined theoretically, and agree approximately with those found experimentally, although, as the authors remark, the exact determination of nodes by observation is very difficult. Would it not be possible to test the latter by observing the reflections of the setting sun from the east end of the lake? Three definite reflections were once seen from such a position by the writer of this note.

THE Journal of the Quekett Microscopical Club (vol. xiv., November, 1919) contains an interesting contribution by Dr. Hamilton Hartridge on microscopic illumination, in which the question of the supposed advantages of so-called critical illumination (which consists in accurately focussing an image of

the actual source of light upon the object under examination) is carefully examined. The well-arranged and conclusive experiments described by the author lead to an unconditionally negative answer which will not surprise those who are familiar with the theory of microscopic image-formation, but the results, being experimental, may put an end to the barren discussions on this subject by practical microscopists. A very neat and compact arrangement for the efficient and perfectly controlled illumination of objects in accordance with the results of the investigation is described. Some of the theoretical views in the first part of the paper are not acceptable. Whilst it is true that the usual methods of illumination do not strictly realise the assumptions underlying Abbe's theory, it is surely not open to question that the *theoretical* work and the rare *theoretical* calculations of images have always been carried out in accordance with the theory. The statement that if the ideals of critical illumination were realised, then resolution would be destroyed, is quite untenable, for as that ideal is to make the object behave as if it were self-luminous, the statement amounts to claiming that a self-luminous object—say a white-hot one—could not give a distinct image, which is absurd.

We have received the fourth report (for 1916) of the seismological observations at De Bilt, Holland (Konink. Nederl. Meteor. Inst., No. 108, 1918, pp. 1-102), in which are given full details of the records obtained from horizontal motion seismographs of Galitzin and Wiechert and a pair of Bosch horizontal pendulums, as well as a summary of the results from other observatories of the more important earthquakes. From this report we learn that the munitions explosion at Faversham on April 2, 1916 (see NATURE, vol. xcix., 1917, p. 250), was registered by the Wiechert and Galitzin pendulums at De Bilt. The effects of the air-waves of this explosion were widely manifested in Holland, especially in the western districts, by the shaking of doors, windows, and pictures, as if by a slight earthquake.

One of the strongest earthquakes felt in Porto Rico since the European occupation occurred on October 11, 1918, the official Report of the Earthquake Investigation Commission (Washington, 1919), by Prof. H. F. Reid and Mr. S. Taber, having recently been published. The approximate position of the epicentre is given as  $18^{\circ} 30' N. lat.$ ,  $67^{\circ} 20' W. long.$ , in the north-east portion of Mona Passage, and the time of occurrence, within a very few seconds, at 2h. 14m. 38s. p.m. (Greenwich mean time). The earthquake was followed after a few minutes by a sea-wave which reached a height of about  $4\frac{1}{2}$  metres above mean sea-level along the north-west coast of Porto Rico, the first movement of the water, wherever seen, being one of withdrawal. The epicentre lies along a deep submarine valley, the slopes of which are so steep that they must be regarded as the result of faulting. During the last half-century the north-west coast of the island has been noticeably subsiding, and the authors attribute the earthquake and sea-wave to a vertical displacement near the head or on one side of the submarine valley.

### Our Astronomical Column.

ECLIPSE OF THE MOON.—There will be a total eclipse of the moon on the night of May 2-3. The following are the Greenwich times of the various stages:—

Moon enters penumbra	... May 2, 10.49 p.m.
Moon enters shadow	... " 12.0 mid.
Beginning of total eclipse	... " 3, 1.15 a.m.
End of total eclipse	... " 2.27
Moon leaves shadow	... " 3.41
Moon leaves penumbra	... " 4.53

At Greenwich the moon rises on May 2 at 7.5 p.m. and sets on May 3 at 4.34 a.m. The whole of the phases of the eclipse will thus be visible.

During some lunar eclipses the disc of our satellite has remained fairly bright, while at others it has been scarcely visible. If atmospheric conditions are favourable, observations of the character of the shadow on this occasion might be made and, possibly, photographs taken. During the lunar eclipse of July 4, 1917, observations made at the Bordeaux-Floriac Observatory showed that throughout totality the north edge of the moon seemed brighter than the south.

MARS AND WIRELESS SIGNALS.—It is regrettable that in these days, when results of great interest concerning solar and stellar physics are continually being reached, the public should have its attention concentrated upon sensational assertions, such as the Porta planetary scare last December and the suggestion of wireless signals to or from Mars which is now under discussion in the daily Press. Leaving aside the physical difficulties of such communication—which, though considerable, are perhaps not insuperable—a very little consideration suffices to show the utter improbability, closely approaching to impossibility, that the idea of signalling should be mooted simultaneously on the two planets. On any view as to the development of the planetary system, the periods when Mars and the earth pass through corresponding stages would be likely to be separated by millions of years. The suggestion that the Martians have kept up the practice of signalling at every opposition through such a period as this, in the patient hope that they might one day be answered, makes too strong a demand upon our credulity.

THE APRIL METEOR SHOWER.—The weather was moderately fine at the time the Lyrids were expected, and a fair number of them were visible. The best night seems to have been that of April 21, when the sky was generally clear and the maximum abundance occurred near midnight. The phenomenon was observed by Miss A. Grace Cook at Stowmarket, Mr. S. B. Matthey at Plumstead, S.E., Mr. C. P. Adamson at Wimborne, Mr. W. F. Denning at Bristol, and others. The Lyrid meteors formed about one-half of the total number visible on the nights of April 19, 20, and 21, and nearly all of them left streaks. They moved with moderate velocity, being decidedly slower than either the Leonids or the Perseids. As regards brightness they were much above the average, and some fine ones were recorded on the dates mentioned.

THE WASTING OF STELLAR SUBSTANCE.—This is the title of a paper by Prof. F. W. Very in *Scientia* for April. It will be remembered that Prof. Eddington made the suggestion in the *Observatory* last September that the immense duration of the radiation from the stars might be explained by the annihilation of some of their component atoms through collision, and the consequent liberation of their stores of energy.



Prof. Very states that he made a similar suggestion many years ago. He conjectures that great gaseous nebulae, such as that in Orion, are the synthetic laboratories where matter is being built up; he applies the idea to the Russell sequence of giant and dwarf stars, supposing that the loss of mass (contrary to Prof. Eddington's suggestion) is a large fraction of the whole initial mass, so that the dwarfs, on his view, are stars not merely of smaller diameter and greater condensation, but also of small mass. The increase of velocity with advance of spectral type would thus receive an explanation.

### Map-making in India.

THE Report for the year 1915-16 (vol. x.) of the Records of the Survey of India (printed at the office of the Trigonometrical Survey, Dehra Dun, 1917), which has lately come to hand, is somewhat belated. The price of it alone would indicate this, viz. "four rupees or 5s. 4d.," which does no justice to the present value of the rupee. It is in other respects a new departure. There is no preface, and we look in vain for the usual summing-up of the scientific results of the year's work by the Surveyor-General, Sir Sidney Burrard, who, for that matter, has ceased to direct the Department and retired to a well-earned rest. On the whole, it is a dry record of useful progress in the work of map-making, supplemented by long tables of the results of scientific observation, which surely, if they are of any use at all, should be published in such an up-to-date form as to compare readily with the work of other observers elsewhere whose researches may lead them into the same scientific fields. There is no narrative or detail explanation showing how the results recorded have been attained; no excursions into the realms of geography to lend a flavour of romance to the volume; and no new theories or startling discoveries to save it from the familiar atmosphere of dry official dullness. It is, of course, not meant to be amusing, but it might easily be made more interesting. One unusual and redeeming feature it does indeed contain. There are seven most excellent photogravure portraits of those gallant officers of the Department who fell in the service of their country. They are so good that one cannot but hope that they exist otherwise than in this official environment, and have already become a permanent and honourable feature in the headquarters' offices of the Indian Survey.

The actual progress of mapping for military purposes under the difficult conditions of the war period, when so many men were absent on duty in the fields of France, Mesopotamia, and elsewhere, appears to have been most satisfactory during that busy time. The Punjab surveys extended into Kashmir, and included a great deal of revision on the one-inch scale as well as certain areas on four inches to the mile. This feature of variety in the scale of mapping is common to all the topographical parties, and is a most encouraging sign that the scale is now adapted to the quality of the district surveyed far more freely than used to be the case. Formerly, there is no doubt, much money was wasted over unnecessarily large scale work in districts which had no possible military significance and not much geographical importance in any sense. Practically the topographical surveys are scattered all over India, from the Punjab to Madras and Burma. An examination of cost rates is interesting, for it does not indicate that the cost has greatly altered during the last twenty years. Here again everything depends on the physical charac-

teristics of the district. From 7-6 rupees per square mile in the Punjab (almost entirely revision) to 50-7 rupees in Burma is certainly a most reasonable outlay for the work of the one-inch class, especially when compared with the enormous costs of European mapping on the same scale. The two-inch-per-mile surveys were a trifle more costly (when compared with previous years) than usual, but the surveyors had to face special difficulties in the shape of large areas of dense forest growth.

There is no record of any extension of first-class triangulation, and the scientific branch of the Survey Department seems to have been directed towards the completion of "fore and back double levelling of precision" in the Punjab and the United Provinces, together with the usual programme of tidal and magnetic observations. It is interesting to note the generally increasing accuracy of tidal predictions, although certain errors seem to require explanation. For instance, there were five predictions at Moulemin which were more than thirty minutes wrong. Why? The tabulated magnetic results show that great disturbances occurred in 1915, particularly in the month of June; and on August 29, 1916, the seismograph was dislocated by the violence of its action in recording an earthquake shock. The report, however, says nothing as to the probable location of that shock. It would be interesting to know more about it. An ingenious instrument for calculating attractions, which the designer, Mr. J. de Graaff Hunter, calls an "integrator," is illustrated by photogravure in the report, and this is indeed the one new feature in it which will probably attract most attention from men of science.

The final record of publications by the Survey of India can be best studied by an examination of the index charts which form the appendix. Progress with the 1/M (one-millionth) Maps of the World Series is very satisfactory. It is this class of geographical mapping which has formed the basis for the Peace Conference boundary delimitations, and in their preparation India is working hand-in-hand with the Royal Geographical Society and the Geographical Section of the War Office.

Vol. xiii. of the Survey of India Records, which is issued as supplementary to the general report of 1917-18, brings the topographical records of the Department to a later date than the above. It deals with the same distribution of parties working on original, revision, or supplementary surveys in much the same fields, and denotes good progress at reasonable rates, but for purposes of comparison a more detailed summary is wanted of the amount of survey completed in each class and a few notes on its character and cost by the Officiating Surveyor-General, Col. Ryder, R.E. The geodesic and scientific operations are summarised in part ii., and in the appendices will be found useful reprints from the Journal of the Royal Geographical Society (March and October, 1918) on the problem of the Himalayan and Gangetic troughs, containing the views of such scientific experts as Sir Sidney Burrard and Mr. R. D. Oldham on this most interesting subject. A feature in the report which attracts attention is the distribution of Survey detachments (with the consequent weakening of field parties) amongst artillery practice camps, presumably for the same purpose of range determination as that which absorbed such a large and expensive staff of surveyors under R.E. direction during the later years of the war. This leads one to ask whether the gunners could not be trained to carry out such special surveys for themselves.

T. H. H.

### Melanism in British Lepidoptera.

MELANISM has long been a subject of special interest to British entomologists owing to the rise and spread of melanic varieties in many British species of moths and butterflies, such groups as the Geometridæ showing many examples. Records of melanism go back at least to 1850, when the dark variety *Doubledayaria* of *Amphidasys betularia* appeared near Manchester. It afterwards spread until it became the prevalent or exclusive form in Lancashire and the Midland Counties, extending also to the Continent in later years. The earlier naturalists' point of view (as represented by the writings of Tutt and of Porritt) concerning its causation, related it to the progressive darkening of the background in the neighbourhood of cities as a result of industrialisation. When this explanation was found to be inadequate, moisture was added as a cause of melanism; and Tutt concluded that moisture would darken the surfaces of rocks in rural districts just as smoke darkens surfaces in urban areas, natural selection progressively favouring darker forms which habitually rested on such darkened backgrounds.

In a recent consideration (*Journal of Genetics*, vol. ix., No. 3) of melanism, based on extended observations and breeding experiments in Yorkshire, Mr. J. W. H. Harrison discards the older hypothesis and proposes a new one. This is based on a modification of the insect's metabolism by its feeding upon substances more or less impregnated with chemicals derived from the smoke. It is pointed out that certain melanic areas, such as the vicinity of Middlesbrough, Newcastle-upon-Tyne, and Moray Firth, are among the driest in the country, having a rainfall of 25-28 in. Also, in such species as *Boarmia repandata* and *Oporabia dilutata* the melanic varieties are confined to the towns, while the type occurs in the surrounding country. The melanic forms of different districts, moreover, differ from each other, showing that they have originated locally and irrespective of each other.

Observations showed that an increase in melanism was accompanied by a striking decadence of cryptogamic plants, especially mosses, liverworts, and lichens, many species having quite disappeared from affected areas owing to smoke contamination. This effect on vegetation, and also the degree of melanism, is found to diminish as one leaves the town.

Mr. Harrison compares melanism to such a condition as alkaptonuria in man. The latter condition is known to be inherited, and may be considered a chemical mutation in which the alkapton is not decomposed owing to the absence of a certain enzyme. He suggests that the taking in with the food of small quantities of such salts as KCl, NaCl, and MnSO<sub>4</sub> present on the foliage in urban areas would lead to an increase in the amount of tyrosinase present, and so to an increased deposition of melanin, since the activity of various enzymes is increased by the presence of small quantities of these salts. The same interpretation is extended to melanic forms on coasts and islands, where the vegetation is impregnated with similar salts from the sea spray.

It is known that in many cases melanic varieties behave in inheritance as simple Mendelian dominants to the type (e.g. Onslow, *Journal of Genetics*, vol. ix., No. 1, on the melanic variety of *Boarmia* (*Tephrosia*) *consoraria*). In crosses with species of *Oporabia*, however, the author obtained a blend which remained true for two generations, and is interpreted as a gametic blend, the melanism being of a perfectly continuous type. Also, when the hybrids between *O. autumnata* and *O. filigrammaria* were crossed back with the parent forms, a blend resulted. In the

F<sub>2</sub> of the cross, however, a "pseudo-segregation" was observed, which is likened to the behaviour in *Oenothera Lamarckiana*. Many writers have suggested such a relation between hybridisation and mutation.

In this interesting and manifold study the author has discarded an original anti-Lamarckian bias, and concludes that various cases, such as the food instincts of *O. filigrammaria* and the period of emergence in a pinewood race of *O. autumnata*, are only explicable as true Lamarckian effects. Natural selection is believed to lead to the genesis of local races, "limiting the range of variation by the elimination of genetical strains less protected in any given habitat."

The haploid chromosome numbers are determined for *O. dilutata*, *autumnata*, and *filigrammaria* as 30, 38, and 37 respectively, and the behaviour of the chromosomes in meiosis furnishes a basis for a further interpretation of the hereditary phenomena.

### University Developments at Manchester.

THE University of Manchester is appealing for the comparatively small sum of 500,000, in order to enable it to maintain its present activities effectively and to develop new features. These embrace not only additional buildings and equipment urgently required for the extension of the School of Medicine, especially in the departments of pharmacology and pathology, and for advanced scientific study and research in other important spheres of the University's many-sided work, but also a large increase in the professorial staff, including new professorships in social and political science, physiological chemistry, law, mathematical physics, and French. The present Department of Commerce, established in 1904, is stated to be hopelessly inadequate to the needs of a great commercial centre such as that of south-east Lancashire, and demands, if it is to serve its purpose worthily, a considerable strengthening of its teaching staff. The University has recently established a new degree, namely, the doctorate in philosophy (the Ph.D. degree), granted upon a course of advanced study and research, which will necessarily involve a large expenditure in staff and equipment.

The University is committed to an expenditure of a sum of 171,000, in respect, among other items, of the building and equipment of the new arts building, where it is intended to house the subjects of languages, literature, history, and philosophy, the endowment of new chairs, the reconstruction and equipment of scientific departments, and the provision of women's hostels. It is further contemplated to set up a wide extension of extra-mural teaching so as to bring the influence of the University more closely in touch throughout its wide area with the needs and aspirations of working people by means of extension lectures and systematic three-year evening courses of tutorial classes.

Already in response to the appeal of the University a sum of about 160,000, has been raised, and it ought not, having regard to the population and wealth of the area the University serves, to be difficult to secure the desired sum, and even more. With the view of inducing a large number of people of small means to participate in the effort to raise the money required, a novel scheme has been launched in the form of a prospectus, such as that issued on behalf of limited liability companies, entitled "Lancashire Development, Unlimited, The University of Manchester," inviting subscriptions for new capital to the extent of 500,000, divided into 425,000 cumulative participating bonds of 1*l.* each and 1,500,000 people's

bonds of 1s. each, the interest upon which will be found in the enrichment of the whole life of the people served by the work of the University. The faculty of technology carried on in the Municipal College of Technology is also issuing an appeal for 150,000l., more than half of which has already been subscribed, for the extension of its building and for new equipment. The great and lasting benefit of the work of the University ought to rouse the active sympathy of the numerous municipalities and district councils, together with that of the County Council itself, and to induce these bodies to levy a rate which, if as low as  $\frac{3}{4}$ d. in the pound, would annually produce a sum equal to the interest upon the half-million it seeks to raise.

### Courses on the History of Science.

GERMAN and American universities long ago recognised the importance of the history of science as a subject of academic study. In British universities the subject is only just beginning to receive attention. In the University of London last year the Faculty of Arts passed a resolution in favour of including the history of science among the subjects for the B.A. degree, and, although the Senate has not yet dealt with the question, the inclusion of the subject in the curriculum for the new diploma in journalism has helped to advance matters. University College undertook to provide the necessary courses. During the first and second terms of the session 1919-20 Dr. Wolf delivered a course of elementary lectures on the general history and development of science until the end of the eighteenth century. During the present (summer) term Sir W. H. Bragg and others will deal with the history of physical science during the nineteenth century, and Dr. Singer will lecture on the history of medicine. A more elaborate programme will be provided next session. Sir W. H. Bragg and Dr. Wolf will repeat their courses, Prof. J. P. Hill and Dr. Singer will deal with the history of the biological and medical sciences, Prof. Filon will lecture on the history of astronomy, and Mr. Wren on the history of mathematics. The history of other sciences will also be dealt with as opportunity offers.

The primary aim of the elementary courses on the history of science is to provide an essential part of the history of culture. The modern treatment of history is marked by the attention paid to the daily life and habits of the people, as well as to the romance of Court life and the adventures of warriors. The kind of houses which our forefathers inhabited, the kind of dress they wore, and similar matters are receiving due attention in order to fill in the historic picture. All this is as it should be, but the picture can scarcely be complete without the realisation of the mental make-up of the ages, especially so in view of the important rôle played by scientific ideas in carrying forward the torch of civilisation.

Over and above its value as an essential part of human history, a course on the history of science should also have the moral and disciplinary value of inculcating a scientific frame of mind—the kind of attitude on which the future of mankind will depend more than ever now that the age of faith seems to be a thing of the long ago.

Such are some of the benefits that may be expected even by those who are not, and do not intend to be, scientific workers, to say nothing of the scientific knowledge which even such students are bound to acquire in following an elementary course on the

history of science. More advanced courses for scientific students can scarcely fail to confer the additional advantage of illuminating the methods and results of the makers of science, and so stimulating the latent originality of the student of science.

### Marine Biological Structures and Functions.

VOL. XIII. of Papers from the Department of Marine Biology of the Carnegie Institution of Washington, which has lately reached us, contains some contributions of considerable interest. Dealing with gland-cells of internal secretion in the spinal cord of the skates, C. C. Speidel describes large irregular cells of peculiar structure present to the number of some hundreds in the anterior horn. The nucleus is lobular and branched, and the cytoplasm of the resting cell is homogeneous, but in active stages granules of a protein substance are formed in it and discharged into the tissues of the spinal cord, where they persist for some time. These cells develop from neuroblast tissue, and cells homologous with them have been found in various other fishes. The author discusses their function, and concludes that they are gland-cells of internal secretion. He is unable to find that they are necessary to the life of the skate, or to show what their function may be. In a paper on the spermatophores of *Octopus americana*, G. A. Drew shows that these structures, while they are built on a similar plan to those of the squid, are adapted to act quite differently, being less complicated, under less tension, and suited for less rapid service, in correspondence with the less active life of the species. H. L. Clark finds in the distribution of littoral Echinoderms of the West Indies evidence of a much closer relationship between that region and the western coast of tropical America than between it and the Mediterranean, while the fauna of Tobago contains an element derived from the Brazilian coast. Studies on the chemistry of light production in luminous organisms by E. N. Harvey reveal that the substance formerly called photophelein by that author includes two bodies, one—luciferin—oxidisable by luciferase with production of light and formation of oxyluciferin, which can again be reduced to luciferin, the other—protophelein proper—assisting in the promotion of the luciferin-luciferase reaction. E. W. Gudger describes the ovary of *Felichthys felis*, the gaff-topsail catfish, the male of which carries the eggs and larvæ in his mouth.

### The Propagation of Flame in Gaseous Mixtures.

ALTHOUGH the large-scale experiments for which the Home Office Experimental Station at Eskmeals was designed have been discontinued since the outbreak of the war, the laboratories have continued to do good work under the direction of Dr. R. V. Wheeler, the chief chemist. In addition to Dr. Wheeler's own researches on the initiation of flame and its propagation through gaseous mixtures, Mr. W. Payman, a member of his staff, has recently published in the Journal of the Chemical Society a series of papers on the propagation of flame in complex gaseous mixtures (vols. cxv. and cxvii.).

Mr. Payman has determined the upper and lower "limits" of methane that will just propagate a flame along a horizontal glass tube 2.5 cm. in diameter when mixed with an atmosphere containing oxygen and nitrogen in which the oxygen varies from 13.7 to 100 per cent. He finds the speed of such flames

almost identical, on the average 20 cm. per sec., the highest speed being measured when the oxygen was 21 per cent. as in air. The same speed was found for the "lower-limit" mixture of all the other paraffin vapours up to pentane when mixed with air.

The "lower-limit" speed of carbon monoxide is also the same, but with hydrogen and air the speed at the lower limit is much slower (10 cm. per sec.), probably on account of the small size of the flame, which does not nearly fill the tube, though it travels to the end.

Mr. Payman next measured the speed of the uniform rate of the hydrocarbons from methane to pentane (when added in different proportions to air) along the same horizontal glass tube. The fastest uniform rate for methane was given by the mixture containing 9.52 per cent. of methane, viz. 66.6 cm./sec. For propane, butane, and pentane the fastest rate was in each case between 82 cm. and 83 cm. per sec.

Then, by mixing together mixtures of the several paraffins which had the same speed, it was shown that all the mixtures had the same speed except just near the maximum or the extinction point, and this gives us a simple means of calculating the values for any combination of paraffins in air.

In a third paper the speeds of the uniform movement in mixtures of carbon monoxide and air are recorded. The rate increased as the amount of water-vapour rose, e.g. when a mixture in equal volumes was saturated with steam at 10° C. The rate was 60 cm./sec., and when saturated at 17° C. 79 cm./sec. The mixture in equal volumes also gave the quickest speed at constant temperature, although the percentage for complete combustion is only 29.5 per cent. The uniform speeds for different mixtures of carbon monoxide with hydrogen and with methane were also determined and compared with the calculated speeds.

In the concluding paper Mr. Pavman describes his experiments on the uniform rate of flame in mixtures of methane and of hydrogen with atmospheres richer in oxygen than ordinary air. When methane is mixed with pure oxygen the mixture which gives the fastest initial rate is the theoretical mixture for complete combustion with 33 per cent. of methane to 66 per cent. of oxygen; whereas in the propagation of the explosion-wave the fastest mixture is that in which the gases are in equal volumes. Although the uniform movement of flame in the mixture containing 33 per cent. of methane is faster than that in a mixture containing more methane, the author's photographs show that the explosion-wave is more quickly set up in the latter. The abrupt physical change in the mode of propagation seems to be accompanied by an abrupt change in the chemical reaction.

These papers form an interesting contribution to our knowledge of the propagation of flame by "conduction."

### University and Educational Intelligence.

EDINBURGH.—His Majesty the King has graciously consented to lay the foundation-stone of the University buildings on the new site of 115 acres at Craigmillar on the occasion of the Royal visit to Edinburgh in July next.

Acting on the recommendation of a special committee recently appointed to consider the question of the German chair, the University Court has resolved that no person be appointed professor of German who is not of British nationality and British parentage, and that, in view of the special circumstances of the case, no appointment to the chair be made at present, but that the present lecturer be retained.

Dr. G. L. Malcolm Smith has been appointed as

whole-time assistant in clinical medicine, and Mr. John Anderson as lecturer in logic and metaphysics.

Dr. Robert Kidston has presented to the geological department a collection of Mesozoic fossil plants. The forestry department has received from the Director of the Royal Scottish Museum, on loan, a collection of forestry exhibits, and from the Forest Research Officer of the Federated Malay States and the Chief Conservator of Forests, Dominion of Canada, prepared samples of commercial woods peculiar to these countries.

PROF. H. J. W. HETHERINGTON, of the University College of South Wales, Cardiff, has been appointed to the principalship of Exeter University College in succession to Mr. A. W. Clayden, resigned.

NOTICE is given by the Royal College of Physicians of London that the next examination for the Charles Murchison scholarship in clinical medicine will be held on Monday, June 14, and following days. The scholarship is of the value of twenty guineas, and tenable for one year. Intending candidates must send their names and other specified particulars by June 1 to the Registrar of the College, Pall Mall East, S.W. 1.

At the request of the Ministry of Labour, and with the co-operation of the Rubber Growers' Association, a six months' course of training in the appropriate sciences has been arranged at Birkbeck College to enable ex-Service men to obtain the requisite knowledge to fit them for positions on the great rubber and tea plantations. The course includes training in chemistry, botany, geology, entomology, and simple mechanics, with some knowledge of the care of machinery and book-keeping.

The League of Nations Union is organising a summer school, to be held at Kempsey School, near Worcester, from Saturday, July 31, to Saturday, August 7. The school is open to both men and women. Applications for admission, which will be considered in the order in which they are received, must reach the League of Nations Union, 22 Buckingham Gate, S.W. 1, by June 15. The main object of the summer school is to train those likely to make efficient leaders of study circles.

The London County Council will shortly proceed to the appointment of the principals of its first group of twenty-two compulsory day continuation schools to be established under the Education Act, 1918. These appointments will be the first of their kind in London, and will be of more than ordinary interest. The type of pupil to be dealt with is one that hitherto has, for the most part, failed to take advantage of educational facilities after leaving the elementary schools. The Act makes great demands on the commercial and industrial world, and it will devolve on the principals of these schools to cultivate close relations with business men and employers, and to secure their cordial co-operation. The success of this great new experiment in national education depends in considerable measure on the sympathy and assistance of the business world. The position of principal will require of its holder administrative ability, good scholastic attainments, and marked personality. The outside-school activities will have to be fostered in every way, so that, with shorter hours of labour, the increased leisure may be utilised to the fullest profit, not only of the individuals, but also of the community. The work should make a strong appeal to those interested in the social welfare side of education. Advertisements inviting applications for these positions are now appearing in the public Press, and forms of applica-

tion can be obtained from the Education Officer (T/3), L.C.C. Education Offices, Victoria Embankment, W.C.2.

THE MARQUESS OF CREWE, chairman of the governing body of the Imperial College of Science and Technology, was present, with other distinguished guests, at the ninth annual dinner of old students of the Royal College of Science on Saturday last, April 24. Sir Richard Gregory, president of the Old Students' Association, who occupied the chair, in proposing the toast of the governing body, said that the time had come for a national survey of the conditions and requirements of university and higher technical education in this country, so that a comprehensive view could be taken of the problem as a whole, existing deficiencies discovered, and adequate educational facilities provided in all areas. The Imperial College would take an important place in any national scheme which might result from such a survey. Lord Crewe, in responding to the toast, said that the college was not content to be merely a school of any university, however distinguished. Though there was in this country no precedent for a technical university, there was, on the other hand, none for a population of eight millions, which was the population of Greater London, with but one university to serve all purposes. The problem of the reorganisation of the University of London was quite enough in itself, without involving the infinitely more difficult task of trying to combine in some way the activities of the University and of the Imperial College in one entirely unprecedented unit. At any rate, the governors of the Imperial College had made up their minds that the problem had to be solved in a way which assured their practical independence. Sir W. H. Bragg spoke of the increased interest, due mostly to the war, now taken in scientific studies, resulting in overfilled laboratories in university institutions and insufficient instructors. Mr. Herbert Wright gave instances of purely scientific investigations at the college which had proved of great practical value, and Prof. J. C. Philip referred to the steps being taken to provide a worthy war memorial to old students. Prof. H. E. Armstrong, proposing the toast of "The Guests," paid a tribute to the men of science whose work contributed so largely to success in the war; and Sir Richard Glazebrook, in responding, referred particularly to the work of Mr. L. Baird, Dr. G. W. C. Kaye, and Mr. F. E. Smith, old students of the college, at the National Physical Laboratory.

## Societies and Academies.

LONDON.

**Linnean Society**, April 15.—Dr. A. Smith Woodward, president, in the chair.—Capt. F. Kingdon Ward: Natural history exploration on the north-east frontier of Burma.—R. Paulson: Stages in the sporulation of gonidia within the thallus of the lichen, *Evernia prunastri*, Ach. It has for a considerable time been generally accepted that the bright-green, spherical gonidium which is common to many lichens, and is referred to in the literature of the subject as *Cystococcus*, *Protococcus*, or *Pleurococcus*, multiplies vegetatively only, while it remains the algal constituent of the lichen thallus. Faminzin (1868), Baranetzki (1868), Woronin (1872), Bornet (1873), and Chodat (1913) state that the gonidia (*Cystococcus*?) of certain lichens produce zoospores after being isolated from the gonidial layer and afterwards cultivated in, or on, different media. The author has not been able to find that the gonidia of *Evernia prunastri*, and of twenty-

three other species of lichens, representing eleven genera, divide vegetatively within the thallus, but in all these cases the reproduction of gonidia was found to be the result of the successive bipartition of the original protoplast of the cell into four, eight, or sixteen separate masses, each of which rapidly develops a cell-wall of its own while within the mother-cell. These daughter gonidia (suppressed zoospores?) ultimately escape as the mother cell-wall becomes diffuent. They exhibit all the characteristics of the parent cell before they are set free.

**Royal Anthropological Institute**, April 20.—Sir Everard im Thurn, president, in the chair.—R. Grant Browne: The races of the Chindwin, Upper Burma. The basin of the Chindwin, in the north-west of Burma, is of exceptional interest to ethnologists on account of the medley of peoples inhabiting it—peoples distinguished from each other by their language and customs rather than by their physical characteristics. They include Burmans, Shans, Tamans, Chins, Nagas, Kachins, and Kadus. These terms denote communities rather than races, for the inhabitants may change from one group to another in the course of a few years. The people of Maukkalauk, for instance, are now regarded as Kachins, but have learnt Shan, and will, no doubt, "become" Shans like their neighbours, and eventually Burmans; but their head-man says they left Assam, where they wore white clothes and spoke some language, of which they have forgotten even the name, when his father was a boy. In contrast to this process of assimilation there are mountain tribes living a few miles apart from each other whose dialects have been differentiated until they have become mutually unintelligible. The more civilised communities owe their language and customs to a succession of dominant races. The Burmese came last. Before them were the Shans, and before these probably the Kadus. There are signs that Kādū, now almost extinct in this area, was once the prevailing language of the riverine tracts.

**Royal Meteorological Society**, April 21.—Mr. R. H. Hooker, president, in the chair.—**Royal Observatory, Greenwich**: A night sky recorder. The object of the instrument is to supplement the daily sunshine record in so far as it gives an indication of the amount of cloud. The instrument consists of a small camera in a fixed position pointing to the pole of the heavens. The lens is a single component of a doublet of 8-in. focal length and 0.4-in. aperture, working at  $f/20$ . It is found that the aperture, in conjunction with plates of "ordinary" speed, will give a good record even at full moon. Measurements are made by means of a photographic scale.—Lieut. N. L. Silvester: Local weather conditions at Mullion, Cornwall. The author gave a detailed analysis of the local meteorological elements in the order of their importance relative to airship navigation, but remarked that the period under review (approximately one year) was too short to deduce much information of climatological value, though during most of this period the observations were as full and as frequent as the changes of the Service in war-time would permit. Ratios of gradient to surface wind had been computed and analysed, from the results of more than 400 pilot-balloon ascents by the one-theodolite method. There was evidence of the marked friction and turbulence affecting the wind near the surface in the vicinity of large buildings, such as airship-sheds. Much useful information relating to the local occurrence of fogs and of unusual visibility had been tabulated; whilst another feature was the collection in tabular form of local signs of approaching bad weather, which should prove of value to the local forecaster.—J. E. Clark: The Surrey hailstorm of July 16, 1018. This storm differed from other similar British visitations by the

fortunate absence of much wind and by coming after midnight. The track of serious damage rarely exceeded  $\frac{1}{2}$  mile in width and was  $16\frac{1}{2}$  miles long, the hail beginning at 1.55 a.m. west of Holmwood Station and ending near North Bromley Station, twenty-two miles to the north-east, at about 2.30 a.m. (true time).

## EDINBURGH.

**Royal Society, March 15.**—Prof. F. O. Bower, president, in the chair.—Capt. T. Bedford Franklin: The effect of weather changes on soil temperatures. In comparison with the variations of surface temperature, the regular pulsations of temperature in the soil follow well-known laws for amplitude and retardation according to depth, but in these regular pulsations there are fluctuations which occur according to the weather and the state of the soil. If the ratio of the ranges of temperature at the 4-in. depth and the surface be taken as the standard for measuring the heat transfer in the soil, it is found that in a light loam soil this range-ratio varies between 0.19 and 0.42 when active percolation is not taking place in the soil, and between 0.42 and 0.85 when rain is actually falling or during those long-period weather changes associated with the passage of depressions north of these islands, whether rain falls or not. Heat transfer in soil is thus carried out by both conduction and percolation, and a sandy soil that allows free percolation, with consequent high values of the range-ratio, will heat up quicker in spring than a clay soil which takes up and parts with water only sluggishly. Apart from percolation, the high values of the range-ratio in the south-westerly cyclonic type of weather are particularly valuable in causing rapid rises of soil temperature in spring. A surface layer of frozen soil protects the lower depths from rapid changes of temperature; an average surface temperature of  $-10^{\circ}$  C. would be necessary to freeze ordinary soil to a depth of 4 in. in one night. Snow is an even more efficient protection; in November, 1919, the air temperature above 4 in. of snow fell to  $-15^{\circ}$  C. without freezing the soil surface or causing any appreciable fluctuation in the temperature 4 in. beneath the surface of the soil.—D. Ferguson: Geological observations in the South Shetlands, the Palmer Archipelago, and the Danco coast, Grahamland.—G. W. Tyrrell: A contribution to the petrography of the South Shetlands, the Palmer Archipelago, and the Danco coast, Grahamland.—H. H. Thomas: Petrographical notes on rocks from Deception Island and Roberts Island (South Shetlands), the Danco coast, and adjacent islands, Grahamland. These papers contained a great many new facts regarding the geology and petrography of the rocks in the islands named lying to the south of South America. In a broad sense, the geological arrangement might be described as a mirror reflection of the arrangement on the South American coast, and it was probable that the two sets of strata were connected by an arc passing east, and then bending round to the south and to the west, but there was no evidence in support of Suess's theory that this arc extended far to the east so as to include the South Georgian group.—Miss C. W. N. Sherriff: A class of graduation formulæ.—Prof. L. Becker: The daily temperature curve. In this paper the author developed a new mathematical method of treating the variation of temperature, and illustrated it by a discussion of a forty years' photographic record of temperature in Glasgow.

## DUBLIN.

**Royal Dublin Society, March 23.**—Dr. F. E. Hackett in the chair.—Prof. James Wilson: The application of the food-unit system to the fattening of sheep. A

summary of experiments in fattening sheep was published by Mr. Herbert Ingle in the Transactions of the Highland and Agricultural Society of Scotland for 1910 and 1911. From this it is evident that the sheep differs from the bullock by being better able to consume roots, and, therefore, less dependent upon hay and straw. The sheep is also considerably more economical as a producer of human food; for, while the well-fed bullock of average size—say 9 cwt.—needs from six to seven food units to produce a pound of beef—a food unit is the quantity of any other food which would have the same producing capacity as a pound of barley—a well-fed sheep of average size—say 120 lb.—produces a pound of mutton on five to six food units.

**Royal Irish Academy, April 12.**—Mr. W. G. Strickland, vice-president, in the chair.—E. Heron-Allen and A. Earland: An experimental study of the Foraminiferal species *Verruculina polystropha*, Reuss, and some others, being a contribution to a discussion on "The Origin, Evolution, and Transmission of Biological Characters." In this paper the authors describe normal and monstrous forms of *Verruculina polystropha*. The species exhibits characteristic dimorphism in a long, tapering test which is megaspheric, and a short test which is microspheric, but in the dwarf variety, *pusilla*, the tapering test is microspheric. Observations on the selection by *Verruculina* of fragments of heavy minerals, by mixing crushed gems with the sand in the experimental tanks with which the authors worked, are described. Variation in the shells of *Masilina secans* is also described in detail, one of the most remarkable "monsters" being a perfectly twinned specimen which had added a curved tube at the junction of the shells to form a common aperture; the whole of this abnormal shell was chitinous. In another case a shell was entirely chitinous except the terminal chamber, which was perfectly and normally calcareous. Further instances of shells combining the characters of two distinct genera—such as have been recorded in former papers by these authors—are given, and the opinion is expressed that the accepted systems of classification of the Foraminifera, founded as they are on the shape and material of the test, must be regarded as largely artificial and unscientific.

## PARIS.

**Academy of Sciences, March 29.**—M. Henri Deslandres in the chair.—G. Bigourdan: The observatory of J. S. Bailly at the Louvre.—Prince Albert de Monaco: Stray mines in the North Atlantic. A chart is given showing the positions of sixty-eight mines located between November 7, 1918, and February 9, 1920. The predictions by the author in two earlier communications have been fully confirmed.—A. Rateau: Some considerations on flight at very high altitudes and on the use of a turbo-compressor. An adverse criticism of a recent communication on the same subject by M. Villey.—P. Vuillemin: The growth of fungi discovered in the human nail by Louis Jannin.—G. Julia: Families of functions of several variables.—H. Mineur: Discontinuous solutions of a class of functional equations.—B. de Fontviolant: The strength of circular arches.—F. Kromm: A star with a large proper motion. The star B.D.+9-2636°, 9-1 magnitude, has an annual proper motion of nearly a second of arc.—G. Sagnac: Newtonian light radiation and the zones of silence in damped wireless telegraphy signals.—M. Pauthenier: The ratio of the absolute retardations in Kerr's phenomenon.—M. Lemarchands: Study of the reactions of the metallurgy of zinc.

Zinc oxide is reduced by carbon in absence of oxygen (atmosphere of nitrogen) at temperatures between 850° C. and 1100° C. The amounts of carbon used in the reduction of zinc oxide in ordinary metallurgical practice are excessive.—P. Nicolardot, A. Réglade, and M. Gelo: The volumetric estimation of manganese. A study of the errors of Knorr's method.—F. Gros: Improvements relating to the commercial production of oxides of nitrogen in arc furnaces. The improvements described are the use of dried gases, increasing the amount of oxygen to 50 per cent., and the replacement of the alkaline absorption towers by a physical method, the separation of the nitrogen peroxide by cooling. The latter can be readily converted into nitric acid of any strength.—A. Mailhe: A new method of formation of nitriles by catalysis. Methyl benzoate and ethylamine, passed over alumina heated to 480°–500° C., gave benzonitrile. Paratoluic nitrile, isomyl nitrile, and isobutyronitrile were prepared in a similar manner.—L. Joleaud: The presence of a Tomistoma in the fresh-water Pliocene of Ethiopia.—F. Baldet: The diurnal variation of the atmospheric potential at the Algiers Observatory. A discussion of five years' observations. The diurnal variation is represented by a simple oscillation having a constant minimum about 4 a.m. and a maximum variable with the season. The observations confirm the law of M. Chauveau.—P. Girard and V. Morax: Liquid exchanges by electrical osmosis through living tissues.—J. Chaîne: The union of the paramastoid apophysis and of the temporal in mammals.—A. Krepmitz: The oro-aboral metamorphosis of the larva of *Pocillopora cespitosa* and of *Seriatopora subulata*.  
 April 6.—M. Georges Lemoine in the chair.—G. Rémondou: Increasing functions and entire functions.—P. Humbert: A new application of the function  $W_{k,1}^{(p)}(x, y)$ —L. E. Z. Brouwer: Enumeration of the classes of transformations of the projective plane.—J. Andrade: Extension of conservative systems and a generalisation of a theorem of M. Painlevé.—Ch. Fremont: Cause of the undulatory wear of rails.—M. Lecornu: Observations on the preceding communication.—J. Villey and A. Volmerange: Hovering flight by a horizontal wind of invariable direction and velocity.—M. Girousse: The distribution in the soil of currents from electric traction lines.—P. Job and G. Urbain: The detection of masked sulphuric ions in complex compounds. The benzidine method of estimating sulphate ions is shown experimentally to possess advantages over the barium method. Examples are given of analyses of cobaltamine sulphates.—Ch. Boulin and L. J. Simon: The action of water on dichloroethyl sulphide. Using an excess of water at its boiling point, dichloroethyl sulphide can be completely decomposed, giving hydrochloric acid and thiodiglycol; the reaction is reversible.—P. Fallot: An extension of the phenomena of drift in the Sierra de Majorca.—G. Dubois: The Quaternary fauna of the base of the Ergeron at Cambrai.—L. Besson: The actinometers of Arago and Bellani. Details of the precautions necessary in the accurate use of these two instruments.—A. Piutti: The action of chloropicrin on the parasites of wheat and on rats. Large-scale experiments have proved the efficacy of chloropicrin in destroying wheat parasites, and it has also been demonstrated that the treated wheat is inoffensive and preserves its nutritive power. Chloropicrin has also been successfully employed in the destruction of rats in ships.—V. Galippe: Researches on the resistance of the microzymas to the action of time and their survival in amber.—G. Bertrand: The action of chloropicrin upon the higher plants. Under suitable conditions it is possible to use chloropicrin to free a plant from all its leaf parasites without killing the plant.

ROME.

Accademia dei Lincei, February 1.—A. Ròiti, vice-president, in the chair.—G. Fubini: Affine differential invariants of a surface.—Q. Majorana: Gravitation. This is the seventh note on the author's experimental attempts to detect the screening off of gravitation by massive sheets of matter (see NATURE for April 22, p. 251). The whole note is devoted to the search after, and the discussion of, "causes of error" or disturbing effects. These troublesome effects are now all estimated numerically, but, notwithstanding this, the author closes the present note, postponing the computation of the corrected value of the effect sought for to the next (viii.) note.—V. Amato: Kronecker's method for the decomposition of an integral rational function in an amplified field of rationality.—P. Scatizzi: Abelian differential equations reducible to quadratures.—L. Tonelli: Primitive functions (ii.).—Clara di Capua: Investigations on alloys of Au and Si.—C. Gorini: A microbiological investigation of the behaviour of *Bacterium coli* in milk.

L. SILBERSTEIN.

## Books Received.

- Life of Lord Kitchener. By Sir George Arthur. 3 vols. Vol. i., pp. xxvi+326; vol. ii., pp. xi+346; vol. iii., pp. xi+413. (London: Macmillan and Co., Ltd.) 2l. 12s. 6d. net  
 Grain and Chaff from an English Manor. By A. H. Savory. Pp. viii+311. (Oxford: B. Blackwell.) 21s. net.  
 The Works of Aristotle. Translated into English. (Economica. By E. S. Forster. Atheniensium Republica. By Sir Frederic G. Kenyon. Unpagged. (Oxford: At the Clarendon Press.) 5s. net.  
 The Geography of Plants. By Dr. M. E. Hardy. Pp. xii+327. (Oxford: At the Clarendon Press.) 7s. 6d. net.  
 The Ways of Life: A Study in Ethics. By S. Ward. (London: Oxford University Press.) 6s. 6d. net.  
 Tungsten Ores. By R. H. Rastall and W. H. Wilcockson. Pp. ix+81. (London: John Murray.) 3s. 6d. net.  
 Microscopy: The Construction, Theory, and Use of the Microscope. By E. J. Spitta. Third edition. Pp. xxviii+537+xxviii plates. (London: John Murray.) 25s. net.  
 College Text-book of Chemistry. By W. A. Noyes. Pp. viii+370. (New York: H. Holt and Co.)

## Diary of Societies.

THURSDAY, APRIL 29.

- OPHTHALMOLOGICAL SOCIETY OF THE UNITED KINGDOM (at Royal Society of Medicine), at 10 a.m.—J. B. Story: Presidential Address.—C. H. Usher: Enlarged Cornea in Goldfish.—E. Treacher Collins: Megalocornea and Micro-cornea.—J. Rowan: Are not some Cases of Glaucoma Better Treated without Operation, and, if so, what are the Indications?—A. Zorab: Later Notes on Aqueous Phlycten.—T. Harrison Butler: Notes on Infection after Operations for Cataract.—G. H. Pooley: Abnormalities of the Lacrymal Apparatus and their Treatment.—G. Harvey Goldsmith: A Case of Double-Traumatic Dislocation of the Lens.—G. F. Alexander: (1) A Position of the Head Favourable to the Operation for Cataract; (2) An Operation for Advancement in Strabismus.  
 ROYAL INSTITUTION OF GREAT BRITAIN, at 5.—R. Campbell Thompson: The Origins of the Dwellers in Mesopotamia.  
 ROYAL SOCIETY, at 4.30.—Prof. J. W. Gregory: The Irish Eskers.—Miss K. M. Curtis: The Life-History and Cytology of *Synchytrium endobioticum* (Schilb) Perc., the Cause of Wart Disease in Potato.—B. Sahni: The Structure and Affinities of *Acanthoplex fancherii*, Pilger.  
 ZOOLOGICAL SOCIETY OF LONDON, at 4.30.—Annual General Meeting.  
 CHEMICAL SOCIETY, at 5.—Extraordinary General Meeting to consider the Alterations in the By-laws proposed by the Council.  
 CHILD-STUDY SOCIETY (at Royal Sanitary Institute), at 6.—Sir A. E. Shipley: Biting Insects and Children.  
 INSTITUTION OF ELECTRICAL ENGINEERS (at Institution of Civil Engineers), at 6.—A. E. McColl: Automatic Protective Devices for Alternating Current Systems.  
 OPTICAL SOCIETY (at Imperial College of Science and Technology), at 7.30.—Dr. C. E. Kenneth Mees: The Reaction of the Eye to Light.

## FRIDAY, APRIL 30.

OPHTHALMOLOGICAL SOCIETY OF THE UNITED KINGDOM (at Royal Society of Medicine), at 10 a.m.—Sir Archibald Garrod, R. Foster Moore, and Others: Discussion on Diabetes in Relation to Diseases of the Eye.—At 8.—H. M. Traquair: Anatomically Separate Anterior Commissure at the Chiasma in a Case of Pituitary Tumour, with Acromegaly.—Dr. G. Holmes: Tumours Involving the Optic Nerves and Chiasma.—M. L. Hine: Primary Epithelioma of the Ciliary Body.—E. Clarke: A Further Note on the Accommodation of the Eye.—H. Neame: Cysts of the Retina.—W. Wallace: A Glyptic Method for Representing Certain Conditions of the Fundus in Disease.—A. W. Stirling: A Case of Melanoma of the Iris.

WIRELESS SOCIETY OF LONDON (at Institution of Civil Engineers), at 6.—Major B. Binyon: A Wireless "Call" Device.

INSTITUTION OF ELECTRICAL ENGINEERS (Students' Meeting) (at Faraday House), at 7.—J. E. Holmstrom: Tidal Power.

INSTITUTION OF MECHANICAL ENGINEERS (Informal Meeting), at 7.—A. P. Bale and Others: Discussion on Suggested Means of Improving and Increasing the Services of the Institution to Members.

ROYAL INSTITUTION OF GREAT BRITAIN, at 9.—Prof. F. O. Bower: The Earliest-known Land Flora.

## SATURDAY, MAY 1.

OPHTHALMOLOGICAL SOCIETY OF THE UNITED KINGDOM (at St. Margaret's Hospital, Leighton Road, Kentish Town), at 10 a.m.—Dr. G. Fitzgibbon, M. Mayou, and Others: Discussion on the Prevention and Treatment of Ophthalmia Neonatorum.

ROYAL INSTITUTION OF GREAT BRITAIN, at 3.—Dr. F. Chamberlin: The Private Character of Queen Elizabeth.—At 5.—Annual Meeting.

## MONDAY, MAY 3.

ROYAL INSTITUTION OF GREAT BRITAIN (General Meeting), at 5.

SURVEYORS' INSTITUTION (Junior Meeting) (Annual General Meeting), at 7.

ROYAL INSTITUTE OF BRITISH ARCHITECTS (Annual General Meeting), at 8.

ROYAL SOCIETY OF ARTS, at 8.—A. T. Bolton: The Decoration and Architecture of Robert Adam and Sir John Soane, 1758-1837 (Cantor Lecture).

SOCIETY OF CHEMICAL INDUSTRY (at Chemical Society) (Annual Meeting), at 8.

ROYAL GEOGRAPHICAL SOCIETY (at Æolian Hall), at 8.30.—H. St. J. Philby: Across Arabia: by the Persian Gulf to the Red Sea.

## TUESDAY, MAY 4.

ROYAL INSTITUTION OF GREAT BRITAIN, at 3.—Prof. A. Keith: British Ethnology: The Invaders of England.

ROYAL SOCIETY OF MEDICINE (Orthopædics: Sub-Section), at 5.—Annual General Meeting.

ROYAL PHOTOGRAPHIC SOCIETY OF GREAT BRITAIN (Technical Meeting), at 7.—Dr. C. E. Kenneth Mees and L. A. Jones: The Theory of Tone Reproduction.

RÖNTGEN SOCIETY (at Medical Society of London), at 8.15.—Prof. S. Russ: Some Problems in the Action of Radiation upon Tissues.—Prof. A. O. Rankine: The Transmission of Speech by Light.—Dr. H. A. Eccles: Two New Portable Viewing Lantern (Demonstrations).

## WEDNESDAY, MAY 5.

ROYAL SOCIETY OF ARTS at 4.30.—Dr. C. E. Kenneth Mees: A Photographic Research Laboratory.

GEOLOGICAL SOCIETY OF LONDON, at 5.30.—S. Hazzardine Warren: A Natural "Eolith" Factory beneath the Thane's nand.

ROYAL SOCIETY OF MEDICINE (Surgery Section), at 5.30.—Annual General Meeting.

SOCIETY OF PUBLIC ANALYSTS AND OTHER ANALYTICAL CHEMISTS (at Chemical Society) at 8.—C. A. Mitchell: Estimation of the Age of Ink in Writing.—E. R. Dovey: The Estimation of Chinese Crude Camphor.—H. D. Richmond and L. R. Ellison: Studies in Steam Distillation, Part VII: The Volatility of Isomers.

INSTITUTION OF AUTOMOBILE ENGINEERS (at Institution of Mechanical Engineers), at 8.—Major B. H. Thomas: The Electro-Deposition of Iron as applied to Motor Vehicle Repair Work.

## THURSDAY, MAY 6.

IRON AND STEEL INSTITUTE (at Institution of Civil Engineers) (General Meeting), at 10 a.m.—C. A. Ablett: Direct Current compared with Three Phase Current for Driving Steel Works Plant.—J. F. Wilson: Notes on Slag Conditions in Open-hearth Basic Steelmaking Practice.—B. Yaneske and G. A. Wood: The Reduction of Silicon from the Slag in the Acid Open-hearth Process.—At 2.30.—W. E. Hughes: Some Defects in Electro-deposited Iron.—T. Baker and T. K. Russell: Note on the Ball Test.—J. H. Whiteley: The Distribution of Phosphorus in Steel between Points A and Ac<sub>2</sub>.—G. F. Preston: Practical Notes on the Design and Treatment of Steel Castings.

ROYAL SOCIETY OF MEDICINE (Laryngology Section), at 4.—Annual General Meeting.

ROYAL ASTRONOMICAL SOCIETY (Geophysical Discussion), at 5.—Prof. R. A. Sampson and Others: The Use of Wireless Telegraphy in the Determination of Longitude.

ROYAL INSTITUTION OF GREAT BRITAIN, at 9.—Lord Rayleigh: The Blue Sky and the Optical Properties of Air.

SATURDAY, MAY 8.

ROYAL INSTITUTION OF GREAT BRITAIN, at 3.—Dr. F. Chamberlin: The Private Character of Queen Elizabeth.

BRITISH PSYCHOLOGICAL SOCIETY (at Bedford College), at 3.30.—Dr. E. W. Scripture: Speech Inscriptions in Normal and Abnormal Conditions.—A. Klein: Camouflage in Land Warfare.

## FRIDAY, MAY 7.

IRON AND STEEL INSTITUTE (at Institution of Civil Engineers) (General Meeting), at 10 a.m.—C. A. Ablett: Direct Current compared with Three Phase Current for Driving Steel Works Plant.—J. F. Wilson: Notes on Slag Conditions in Open-hearth Basic Steelmaking Practice.—B. Yaneske and G. A. Wood: The Reduction of Silicon from the Slag in the Acid Open-hearth Process.—At 2.30.—W. E. Hughes: Some Defects in Electro-deposited Iron.—T. Baker and T. K. Russell: Note on the Ball Test.—J. H. Whiteley: The Distribution of Phosphorus in Steel between Points A and Ac<sub>2</sub>.—G. F. Preston: Practical Notes on the Design and Treatment of Steel Castings.

ROYAL SOCIETY OF MEDICINE (Laryngology Section), at 4.—Annual General Meeting.

ROYAL ASTRONOMICAL SOCIETY (Geophysical Discussion), at 5.—Prof. R. A. Sampson and Others: The Use of Wireless Telegraphy in the Determination of Longitude.

ROYAL INSTITUTION OF GREAT BRITAIN, at 9.—Lord Rayleigh: The Blue Sky and the Optical Properties of Air.

## SATURDAY, MAY 8.

ROYAL INSTITUTION OF GREAT BRITAIN, at 3.—Dr. F. Chamberlin: The Private Character of Queen Elizabeth.

BRITISH PSYCHOLOGICAL SOCIETY (at Bedford College), at 3.30.—Dr. E. W. Scripture: Speech Inscriptions in Normal and Abnormal Conditions.—A. Klein: Camouflage in Land Warfare.

## CONTENTS.

	PAGE
The Chemical Industries of German Rhineland	253
Man: Past and Present. By Prof. G. Elliot Smith, F.R.S.	255
Critical Mathematics. By G. B. M.	256
The Proteins	257
Science and Engineering. By W. C. U.	258
Health and the Teacher	259
Our Bookshelf	259
Letters to the Editor:—	
Theories of Atomic Structure.—Irving Langmuir	261
Decimal Coinage.—Harry Alcock	261
International Council for Fishery Investigations.—X. Y. Z.	262
The Plumage Bill and Bird Protection.—Prof. J. E. Duerden	263
The Standard of Atomic Weights.—Prof. J. R. Partington	264
Mortlakes as a Cause of River-windings. ( <i>With Digram</i> ).—T. S. Ellis	264
Eiffel Tower Wireless Time-signals.—Prof. R. A. Sampson, F.R.S.	265
Some Tests of the 100-in. Hooker Telescope. ( <i>Illustrated</i> ). By Dr. George E. Hale, For. Mem. R.S.	266
Artillery Science. By Sir George Greenhill, F.R.S.	268
Obituary:—	
Dr. Rudolph Messel, F.R.S. By H. E. A.	270
Prof. A. K. Huntington	271
Dr. A. J. Chalmers	271
Prof. L. T. O'Shea. By A. McW.	272
Notes	273
Our Astronomical Column:—	
Eclipse of the Moon	276
Mars and Wireless Signals	276
The April Meteor Shower	276
The Wasting of Stellar Substance	276
Map-making in India. By T. H. H.	277
Melanism in British Lepidoptera	278
University Developments at Manchester	279
Courses on the History of Science	279
Marine Biological Structures and Functions	279
The Propagation of Flame in Gaseous Mixtures	279
University and Educational Intelligence	280
Societies and Academies	281
Books Received	283
Diary of Societies	283

Editorial and Publishing Offices:

MACMILLAN AND CO., LTD.,  
ST. MARTIN'S STREET, LONDON, W.C.2.

Advertisements and business letters to be addressed to the Publishers.

Editorial Communications to the Editor.

Telegraphic Address: PHUSIS, LONDON.  
Telephone Number: GERRARD 8830.



THURSDAY, MAY 6, 1920.

### The Cost of Scientific Publications.

WE have had before us recently the annual reports of the councils of a number of scientific societies, and it is evident from all of them that the burden of the cost of publications of these societies has become so heavy that it cannot be borne any longer without additional support. The great increase in printers' charges, and the high cost of paper, make the expenses of publication so considerable that the slender funds at the disposal of most scientific societies, particularly those devoted to subjects having no direct association with profitable industry, will often not permit the substantial expenditure now required for the printing and distribution of papers presented at meetings. Few scientific societies have any other source of income than that provided by the subscriptions of their members or fellows, and science workers in general are already sufficiently harassed by the problem of their private budgets, with salaries little above the pre-war level, and relatively far below it on account of the rise in prices, that increased subscriptions cannot be contemplated without serious misgiving.

It has always seemed to us that in the pursuit of their researches and the publication of the results science workers follow principles on a far higher ethical level than that occupied by members of any other profession. The first object of their work is to increase the store of human knowledge, and the value of any communication to a scientific society is measured by what the explorer has brought back from a known region, or how far he has lifted the veil with which Nature jealously guards her secrets. Nothing must be kept back from the narrative of the discoverer, and the fruits secured must be displayed so that all who wish may enjoy them and be able to go out into the same fields to secure like riches for themselves.

In presenting the results of his labour to the human race without receiving any personal payment for it, the science worker occupies a unique position. Genius in art, or literature, or music may sometimes be neglected, but usually it secures generous reward, and its products have always a marketable value—high or low—whereas scientific discovery rarely brings direct gain to the genius who makes it. Plutocrats will pay high prices for the pictures they want, and popular

authors and musical composers may amass riches from royalties on their works; but the science worker is deprived of any such rewards for his discoveries, though all the world may benefit by them. Not only does he bring his rich argosies into port, but he also describes his cargoes fully, and himself pays for the publication of the catalogue of gifts which he is prepared to bestow freely upon all who care to receive them. Such pure altruism is almost inconceivable to the ordinary business mind, yet it represents the common standard of scientific endeavour and achievement. Altered circumstances, however, make it necessary to reconsider this position, and we urge that it is time the community, through its rich citizens or the Government, provided reasonable contributions towards the expenses of publications which bring honour to them as well as add to the sum of human knowledge.

There is, indeed, no more difficult problem before our learned societies at the present time than that of the maintenance of their scientific publications. With a limited circulation which cannot be increased by the ordinary methods of enterprising journalism, the additional cost of production can be met only by a higher subscription. The societies which provide a library of their special subject already find most of their normal income absorbed by the increased establishment charges. As we have said, a very large proportion of the members of these societies are professional men whose incomes have not risen in proportion to the prices of the ordinary commodities of life. Any additional subscription to provide for an adequate record of the societies' activities under present conditions thus proves to be a hardship, sometimes an impossibility.

It may perhaps be admitted that, in the past, scientific publications have sometimes been produced in a rather extravagant style. Some societies have never completely emancipated themselves from this idea, and although a large format may sometimes be needed both for drawings of natural history and engineering, and for extensive mathematical formulæ, there has been less strict regard to such necessities than should have been exercised. Moreover, during the years before the war, with cheap printing, there was an increasing tendency in some departments of science to pour forth the undigested contents of notebooks rather than carefully considered results.

After all reasonable reform and economy, however, it still remains impossible to continue the serial publications of science with the means that

have hitherto been at its disposal. The question arises, therefore, whether help from some public source may not reasonably be expected. There is doubtless a very general popular feeling that ordinary scientific research is as much a recreative amusement to its devotees as are games and sport to the majority, and that those who indulge their whims should bear the additional cost like any other section of the community. But it must not be forgotten that there are various degrees of games and sports suited to the several means of those who pursue them, whereas ability and inclination to make and record scientific discoveries are in no way proportional to the resources of those who possess them. It must also be emphatically maintained that there is no basis for such a comparison. Science is undoubtedly an absorbing source of gratification to those who study its problems; but even the most abstract research, however far removed from the affairs of everyday life, is an asset of which no man can estimate the value.

In some directions the public has already become accustomed to the scientific spirit. It has begun, for example, to understand the value of preventive medicine. It no longer reserves its gratitude for those who discover remedies for disease; it realises the still greater importance of the work of those who try to learn the origin of disease and the influence of the environment upon the exciting cause. It should now be led to understand its debt to those who make advances in this and other branches of purely scientific work. The germs of all material progress and comfort are contained in our scientific serials and the publications of our scientific societies, and to allow a limitation of their scope is a hindrance to the public welfare.

The Government has already aided a few of the older and more important societies with a partial or complete grant of premises, and it entrusts an annual sum of money, given in the Estimates of 1920-21 as 11,000*l.*, to the Royal Society, to be distributed for scientific investigations by a committee appointed for that purpose, as well as 100*l.* annually towards the cost of scientific publications. It has also established the important Department of Scientific and Industrial Research. We would now urge that a further step should be taken, and some direct endowment provided for those purely scientific publications which have for so many years been maintained by voluntary effort, both to the honour of the country and to the welfare of mankind.

### Useful Physiology.

*Physiology and National Needs.* Edited by Prof. W. D. Halliburton. Pp. vii + 162. (London: Constable and Co., Ltd., 1919.) Price 8s. 6d. net.

PROF. HALLIBURTON and his fellow-lecturers have made out a good case for physiology having done its bit in the great war. The editor leads off with an account of the activities of the Royal Society and other committees in food control in general, and gives more particular details of the inquiries made in his own laboratory on the value of margarines and fatty acids. Vitamins occupy the whole of Prof. Hopkins's discourse, and Prof. Harden returns to them again with a summary of the work done on scurvy at the Lister Institute. But Prof. Harden is surely in error in saying that Lind held that scurvy was caused by abstinence from fresh vegetable food. That astute observer knew 150 years ago that scurvy could be cured by fresh vegetables, but he thought it was caused by living in confined, damp quarters, arguing that no one would say that ague was caused by abstinence from bark because it could be cured by giving bark.

Prof. Paton's essay on physiology in the study of disease is much less satisfactory. He is under a complete misapprehension of the aim and objects of medicine—a mistake shared in part by Prof. Halliburton—and medical men who read his solemn castigation of their empirical methods may not unreasonably retort that his discovery that tetany is due to the liberation of guanidin, controlled "somehow" by the parathyroids, has left medicine just about where it was. Prof. Paton seems to think that the object and business of medicine is to study disease. The object of medicine in reality is to prevent people feeling ill, and to make those who do feel ill feel better, and its success is to be measured by the product of the degree of betterment and its duration. "What the physician has to find out in every case," he says, "is simply what has gone wrong, and why it has gone wrong, before he attempts to put it right." So that if I have a headache and send for my physician, he is to engage with the hitherto insoluble problem of the nature and cause of the common megrinous headache (which is one of the great causes of human inefficiency, and no trivial matter) and solve it before he cures me by exhibiting 10 grains of aspirin: it might be good physiology, but it would be thoroughly bad medicine. The "practical man" is of course very wicked from our point of view, but he has been belaboured pretty freely these last few years; and, after all, he does a lot of practical good in

his blundering way. *Gerris*, as Mr. Belloc says, would sink if he stopped to meditate about the surface film, and he might get no nearer the truth than Prof. Paton does when he affirms that phosgene yields chlorine in the lungs. Knowledge helps practice truly enough, but to ask that practice shall stand still while a particular sort of intolerant knowledge gropes to a rationale will meet no national need whatever.

Prof. Dendy's interesting account of the ravages of weevils in stored grain and the means of preventing them tells, on the other hand, an excellent tale of practical empiricism. Prof. Dendy found, as on general grounds he expected to find, that the weevils soon perished if infested grain was shut up in air-tight receptacles in which the metabolism of the seeds soon replaced most of the oxygen by carbon dioxide, and he shows with a variety of experiments that air-tight storage is the practical method which is wanted: which appears to have been known from time immemorial and is expressed in the habit of Indians, Maltese, and others in storing their harvested grain closely in covered underground pits in face of the opinion that it was "absurd to hold that weevils require a free play of air or that free access of air is favourable to their existence," given by the entomological expert—doubtless a mere morphologist.

Natural man, indeed, as Dr. Pembrey argues in his breezy plea for the wild life, is apt to go right: "A sturdy growth of children is not to be obtained by the intelligent selection of the quality or quantity of their diet, but by the natural process of muscular activity in the open air, the appetite with its likes and dislikes acting as the guide in questions of food" (p. 158), which is not quite what the editor seems to say (p. 23). But the discrepancy is only on the surface: Sussex is not the Marylebone Road, and it is when civilisation interferes that trouble comes. Western refinements in rice polishing gave the East beriberi; a world trade in wheat gave the weevils their chance; mean and restricted lives brought in physical exercises instead of games. The truly physiological procedure, says Dr. Pembrey, is to put people where they can live a natural life by accumulated experience and to let them live it. "Bread and cheese" off the hedges is an older remedy than orange juice, and even scientific opinion has been taught by Prof. Leonard Hill that there is something to be said for our primitive open fires.

The book as a whole is extraordinarily interesting from many different aspects, as much perhaps for the questions it asks as for those it answers.

"Physiology" is conceived in no narrow spirit; it is hygiene, pathology, bacteriology, and pharmacology, as well as itself. And in this generous field everyone will find a good many things worth thinking about.

A. E. B.

### Service Chemistry.

*Service Chemistry: Being a Short Manual of Chemistry and Metallurgy and their Application in the Naval and Military Services.* By the late Prof. Vivian B. Lewes and Prof. J. S. S. Brame. Fifth edition. Pp. xvi + 576 + vii plates. (London: Edward Arnold, 1920.) Price 21s. net.

THE late Prof. Vivian Lewes, of the Royal Naval College, Greenwich, an excellent teacher and an admirable lecturer, conferred a great benefit on the Service of which he was a member by the compilation of this manual. In the early days of the history of the college, the relation and importance of physical science to the business of the naval officer were but dimly appreciated by the authorities at Whitehall, and the scheme of instruction at Greenwich went but little beyond the standard of a public school which sought to develop its modern side. Prof. Debus, the first professor of chemistry, although a sound and remarkably well-informed chemist, carried with him to the college merely the traditions and methods of Clifton. The scope of his instruction of the naval lieutenant was practically that which had served him for years past in the several public schools to which he had been attached. He continued to teach chemistry simply as a branch of a liberal education, with no very direct reference to the life-work of those whom he addressed. It may be that at the outset of the career of the college no other course was open to him. The preliminary education of a naval officer at that period afforded no opportunity for him to acquire even the most elementary knowledge of science, and hence his teacher had of necessity to restrict himself to the kind of instruction which a well-ordered school system ought to have supplied.

Prof. Debus exercised a very salutary influence at the Royal Naval College. He was personally popular, and, in spite of certain little mannerisms, his quiet dignity and personal bearing enabled him to keep an effective control over a class of young men whose sense of humour is proverbially always acute and occasionally irrepressible. But to the budding Nelson, keen on his job, there must have been much in the professor's teaching that made no appeal. It probably seemed to him to have no possible relevance to the work of his pro-

fession. Prof. Lewes, who acted as chief assistant to Prof. Debus for some years and eventually succeeded to his chair, was no doubt fully conscious of this fact. At all events, his intimate association with the young officers in the laboratory must have afforded him abundant opportunities of learning it. When his turn came he entirely remodelled the course of chemical teaching. During the years of his assistantship he had been brought into frequent contact with Service and dockyard problems, in which his chemical knowledge and practical aptitudes could be turned to account. Prof. Debus was essentially the philosophic student; Prof. Lewes, with no pretensions to the academic attainments of his predecessor, was more a man of affairs, with a keen appreciation of the value of science to practice, and he could bring his experience to bear upon the character and style of his teaching.

The book before us was written to aid and supplement Prof. Lewes's instruction. It was unique of its kind. It bore directly upon what he conceived to be the true function of his chair. In one sense it is more restricted in scope than the ordinary text-book of pure chemistry, which seeks to cover more or less fully every department of the science, with no special reference to its practical application; in another sense it is wider, inasmuch as its subject-matter is intended to lead up to the far-reaching problems with which modern Service conditions deal.

A book based upon such principles can continue to be of value only so long as it has regard to the constant changes and increasing complexity of these conditions. Each successive edition bears witness that such regard has been held. The four previous editions of the work were issued under the direction of the original author, the fourth having appeared in the year before the outbreak of the war.

The present edition—the fifth—is due to Prof. Brame, Prof. Lewes's successor at the Royal Naval College. The plan of the work has not been altered in any essential particular. But the text has been carefully revised, and certain new features have been introduced. Greater attention has been paid to the applications of organic chemistry, especially in relation to fuels, explosives, and oils, mineral and vegetable. Also, the sections on boiler waters, corrosion, pigments, etc., have undergone considerable alteration.

It has become a truism to say that the great war through which Europe has recently passed was a chemist's war. Whether that is wholly true is a matter of opinion. But it is at least universally acknowledged that chemistry entered more largely into it than into any previous war. That

fact alone adds interest and value to a book of this kind. Both arms of the Service now recognise that the operations of modern warfare are largely dependent upon chemical principles. That dependence is bound to increase in the future, and should therefore lead to a wider recognition of the importance of chemical instruction to all who may be concerned in the conduct of war, whether afloat or ashore. The book before us makes mention of many chemical applications and adaptations which the war originated; but the complete story has yet to be told, and in the present unsettled state of the world some time must elapse before it can be published. When, however, it is made generally known, it will constitute a triumph for the knowledge, skill, and resourcefulness of British chemists. That fact is already appreciated in the Naval Service, and by no section more warmly than by those who owe their chemical knowledge to the instruction they have received at the Royal Naval College.

T. E. THORPE.

### Euclid's Elements.

*Euclid in Greek. Book I. With Introduction and Notes.* By Sir Thomas L. Heath. Pp. ix + 239. (Cambridge: At the University Press, 1920.) Price 10s. net.

THE editor of this text expresses the hope that it may be read by boys in the higher forms of schools. We hope so too, although the price of the book is rather prohibitive. At any rate, a copy should be obtained for the school library.

The text is accompanied by an introduction and a set of explanatory and critical notes; each of these is a model of its kind. In the introduction we have a summary of the contents of the elements, all the facts known about Euclid's life and works, and a full account of the principal translations and editions of the elements. The notes are extremely valuable in various ways. In the first place, the author is both a competent Greek scholar, and also a student imbued with the unadulterated spirit of Greek geometry. This makes his translations of technical terms eminently apt and trustworthy. As an example of his critical ability, we may take his discussion of the very difficult phrase  $\epsilon\tilde{\iota}\ \tau\omicron\omega\omega$  in Euclid's definition of a straight line. He shows, we think conclusively, that the intention of the definition is to express that if any point on the (indefinite) line be taken, what we may call the aspect of the line therefrom is an "indifferent" one, with no bending one way or the other; in fact, we have an attempt at expressing in abstract terms the Platonic test—that a straight viewed "end

on" is a point. The editor keeps the time-honoured rendering "evenly"—we should prefer "equally" or "indifferently"; but this is of little importance, because, whatever term is used, it will have to be carefully explained. In any case, Simson's definition is a gross misrepresentation of Euclid, who evidently, however obscurely, states a property of a straight line in relation to all the points upon it.

Owing to the great popularity of the Elements, it is unlikely that we shall ever find out exactly the contributions made to geometry by Euclid's predecessors. Naturally, we should like to know what were the attainments of the Pythagorean school, and how far they were arithmetical or geometrical respectively. A still greater satisfaction would be to know how far the Greek theory of proportion was developed by Eudoxus. As presented in the Elements, it may fairly be called the crowning triumph of Greek mathematics; it is so near absolute perfection that no recent analysis can amend it, except perhaps by explicitly introducing what is known as the axiom of Archimedes. The question is, How far, if in any way, did Euclid improve upon Eudoxus's exposition?

We do not know whether Sir T. Heath intends to publish all the other books of the Elements. Those who are interested in Greek mathematical thought would be grateful for a similar edition of Euclid's arithmetical books, especially the tenth, which, as De Morgan pointed out long ago (in Smith's Dictionary of Classical Biography), contains an exhaustive discussion of a particular family of irrationals. Another boon would be an edition like this of some of the books of Apollonius's "Conics," especially those which virtually give the equations of conics referred to a principal diameter and the tangent at a vertex.

There is one point on which we venture, with all deference, to disagree with the editor. On p. 175 and elsewhere he translates  $\text{πολλῶ μείζων}$  by "much greater." The Greek idiom is peculiar, but unless we are to make it absurd we must render  $\text{πολλῶ}$  by "all the more," or some such phrase.

One remark in conclusion. Forty or fifty years ago, when a blind idolatry of Simson's "Euclid" was still the vogue, Euclid's fifth book was never read, and its theorems were assumed on the basis of Todhunter's "Algebra." In other words, the greatest achievement of Greek mathematics was absolutely ignored. It is a great mistake to assume that all who are in favour of modern methods of teaching are wholly out of sympathy with the classic exponents of their subject. On

the contrary, those of them who are sane psychologists will always bear in mind that the progress of the individual is, in a way, a condensed image of the progress of the race, and they will be the last to ignore the historical development of their subject, whether it be mathematics, or philosophy, or chemistry, or anything else. G. B. M.

### The Earliest Flint Implements.

*Pre-Palaeolithic Man.* By J. Reid Moir. Pp. 67+29 plates. (Ipswich: W. E. Harrison; London: Simpkin, Marshall, Hamilton, Kent, and Co., Ltd., n.d.) Price 7s. 6d.

**I**N this little volume Mr. Reid Moir treats of the various forms of flaked flints found in deposits older than those in which ordinary palaeolithic implements occur. He also describes the experiments in flint-fracture which have convinced him that the specimens in question are examples of human workmanship. Most of the matter has already appeared in various papers by the author, and many of the illustrations are from these papers, but the whole is a useful summary which the general reader will be glad to have in so convenient a form.

Among flints like the so-called eoliths, which are very little shaped by chipping, it must naturally be difficult to decide which have been flaked by man for his own use, but Mr. Reid Moir considers that they can be distinguished by the shape and appearance of the flake-scars. According to his experiments, the scar left by fortuitous percussion is comparatively wide and truncated, and often marked by concentric lines, while that made by human flaking is longer than it is wide, tapering at the far end, and not marked by concentric lines. If this criterion be trustworthy, it is evident that man's earliest handiwork can be recognised, for when he first began to use stone he must have selected pieces which were already of the needed shape, and he merely trimmed certain edges for greater effectiveness.

Man's first efforts to shape a real implement are supposed to have resulted in the rostro-carinate type, and this by further chipping gradually passed into the familiar palaeolith. Mr. Reid Moir describes the process of change, as further discussed in his memoir in the Philosophical Transactions which was noticed in NATURE for April 1, p. 146. He also, as in the memoir just mentioned, expresses the opinion that the Acheulean and the Mousterian forms of palaeoliths have been derived from the rostro-carinates in somewhat different ways. The speculation is interest-

ing, and the argument is easily followed with the aid of the many accompanying illustrations.

Mr. Reid Moir's final chapter on "Pre-Palæolithic Man in England" is more discursive, and suggests that we should turn to England rather than to Asia for the earliest traces of man. The detritus-bed at the base of the Pliocene Red Crag near Ipswich is described as yielding rostrocarinate and other worked flints. The age of the Piltown skull is also discussed, and it is regarded as Pliocene. The conclusion is that English "pre-palæolithic" deposits should be more carefully studied than they have been hitherto, and the little book before us cannot fail to stimulate such study.

### The Heat Treatment of Cast Iron.

*Malleable Cast Iron.* By S. Jones Parsons.

Second edition, revised. Pp. xi+175. (London: Constable and Co., Ltd., 1919.) Price 14s. net.

THE first edition of Mr. Parsons's book on malleable-iron founding was published in 1908. A second edition has now been issued. It differs principally from the first in that it contains two new chapters, one dealing with mixing by analysis, the other with the measurement of temperature. There is also a brief addendum on what is called "malleable cast steel."

The high percentage of "waster" castings formerly produced in malleable-iron foundries has undoubtedly been reduced in the interval which has elapsed between the appearance of the two editions by adopting a more scientific method of making up mixtures according to chemical standards; but this alone is not sufficient to ensure a continuous output of good malleable castings. There has always been an undue amount of wastage in the annealing process, chiefly owing to irregularities in the temperature of the ovens. This is inevitable when there is no means provided for measuring the temperature. In the best foundries the hopelessness of relying on the purely human element has long been recognised, and it has now been proved by the use of suitable pyrometers that a considerable saving in fuel may be effected and the percentage of waster castings due to imperfect annealing almost entirely eliminated. The chapter on temperature measurement gives a brief account of optical and thermo-couple pyrometers and the methods of using them in this industry.

It is somewhat surprising that in a book which is evidently designed to assist the malleable-iron industry to more scientific methods of production there is no mention of the light thrown by the

microscope on the structural changes which occur in the malleablising process; nor is there any reference to the mechanical properties of the various types of iron produced. It is the microscope which has shown what the essential difference is between European malleable iron, which dates back to the time of Réaumur, and the modern "Black Heart" variety, which is an American product. This instrument affords a valuable means of controlling the extent of the malleablising action of the annealing process.

A valuable account of these two aspects of the scientific control of malleable iron is to be found in Dr. Hatfield's book "Cast Iron in the Light of Recent Research." If a third edition of Mr. Parsons's book is called for he would be well advised to include a reference to these additional methods of control.

### Our Bookshelf.

*The Running and Maintenance of the Marine Diesel Engine.* By John Lamb. Pp. xii+231+4 plates. (London: Charles Griffin and Co., Ltd., 1920.) Price 8s. 6d.

THIS book opens with brief descriptions of the properties of oil fuels, combustion, the modes of working of four-cycle and two-cycle engines, and the general arrangement of the marine Diesel engine on board ship. The remainder of the book is taken up with descriptions of details and the manner in which these operate; sections are included dealing with high-speed Diesel engines for driving dynamos and fans, steering-gears, running troubles, and lists of stores which should be carried. The book is profusely illustrated with diagrams showing the construction of details; as the author's object has been merely to explain the mode of working, many of these diagrams have not been drawn to scale; detailed descriptions of parts which are common to all classes of engines, e.g. connecting-rods and crank-shafts, are not included.

The book will appeal to and be found useful by a large class of engineers whose experience has been confined to the steam engine, both by reason of the clearness of the matter included and by the many useful hints which the author's four years' sea-going experience in motor ships has enabled him to give. For example: "In the same vessel the scavenging valves would intermittently fail to close, frequently to such an extent that the escape valves on the scavenging air pipe would lift. The scavenging pumps drew the air through a ventilator passing up through the deck. It was afterwards found that scale from the inside of the ventilator was the cause of the valves failing to close. The air was then taken from the engine-room, when no further trouble was experienced." Obviously hints of this kind are of service not only to the engineer on board ship, but also to the

designer. We can recommend the book to all engineers desirous of obtaining information on the running of Diesel engines.

*A Course of Practical Chemistry for Agricultural Students.* Vol. i. By L. F. Newman and Prof. H. A. D. Neville. Pp. 235. (Cambridge: At the University Press, 1920.) Price 10s. 6d. net.

MR. NEWMAN AND PROF. NEVILLE have brought into three volumes details of a practical course of agricultural chemistry designed for students taking degrees in agricultural science; the present volume deals with the chemistry and physics of the soil. Much of the book is concerned with pure chemistry and pure physics (physical properties of gases, density, specific heat, etc.), and has no special connection with agriculture as distinct from any other branch of science; only about one-third is devoted to soils and manures.

The exercises appear to be well chosen, but one cannot help wishing that the authors had used one of the many books already published on pure chemistry, and given more space to agricultural problems.

The exercises on soils and manures are mainly analytical; they are on the usual lines, and intended obviously for elementary students, for whom the instructions should be found sufficient. Had there been more space available, some more inspiring exercises might well have been given, especially in the direction of pot and plot experiments. Many of the properties of soil are more easily demonstrated out of doors than indoors, and in any case the principles of soil fertility cannot be elucidated entirely by purely laboratory work. Numerous experiments have been devised, but they are scattered about over a number of text-books and have never been collected.

Within the limits they have set themselves, the authors have produced a useful book which will be helpful to teachers, especially in these busy times, when classes are large and demonstrators very hard-worked.

*The Mason-Wasps.* By J. Henri Fabre. Translated by Alexander Teixeira de Mattos. Pp. vi+318. (London: Hodder and Stoughton, n.d.) Price 7s. 6d. net.

THE writings of few open-air naturalists have equalled, or even approached, in ease and attractiveness of style the "Souvenirs entomologiques" of J. H. Fabre, the veteran observer of Sérignan. Much of the charm of these essays has been preserved in the skillful translations by A. T. de Mattos, of which the present work is an example in no way inferior, either in interest or in wealth of accurate observation, to the other volumes of the series. In it are recorded the results of a minute and careful study of the life-history of wasps belonging to the genera *Eumenes*, *Odynerus*, *Pelopœus*, *Agénia*, and *Vespa*, related with the utmost simplicity and vividness, and illuminated by the lively and charming personality of the author.

Leaving the domain of pure observation and experiment, and entering on that of bionomic speculation, we find Fabre a less satisfactory guide. It is well known that no theories of evolution appealed to him in the least degree, and the *naïveté* with which he touches and dismisses the problems of mimicry and protective resemblance in the volume before us gives a key to the reasons of his failure to appreciate the greatest advances in biological science of his time. On the other hand, his views on the subject of instinct, fortified by ingenious experiments on the mud-building and spider-storing habit of *Pelopœus* and on the cocoon-weaving procedure of *Saturnia*, are sound enough. But it is difficult to follow him in the distinction that he draws between "instinct" and "discernment"; nor can one take seriously his playful remarks on the mental processes involved in insect activities.

F. A. D.

*The Handbook of Cyprus.* Eighth issue. Edited by Harry Charles Luke and Douglas James Jardine. Pp. xii+300. (London: Macmillan and Co., Ltd., 1920.) Price 12s. net.

To every Englishman—and by that we mean every English-speaking citizen of our Commonwealth—Cyprus suggests, not the succession of love-cults, but that one great lovers' meeting when Othello came to land. "Once more well met in Cyprus." This new issue of the official handbook assures us that the island is now a Crown colony of Britain. Let us trust that its authors, who are both administrators of empire, in reviewing their work among its mixed inhabitants, may record that they "have found great love amongst them."

It is rare to find a publication that in its essence is economic and statistical allowing also for the taste of visitors in archaeology and natural history. Enough is here given in a small compass to lead the reader on to the works enumerated on pp. 93-95 and in the sections on geology and zoology. It would have been well if the treatment of the geology had been connected with the brief geographical section which occurs some two hundred pages earlier. The comparatively recent origin of the islands of the Levant, consequent on the breaking up of the *Ægean* land, is the real basis for the history of merchant fleets. The dwarf elephant and hippopotamus, so well included under *Natural History* on p. 246, are effective links in the romance. We find so much in this invitation to the isle that we should like to arrange it more in sequence, so as to produce the true geographical effect. Perhaps each reader will do this for himself as he journeys eastward, sure of welcome.

G. A. J. C.

*An Introduction to Social Psychology.* By Dr. W. McDougall. Fourteenth edition. Pp. xxiv+459. (London: Methuen and Co., Ltd., 1919.) Price 7s. 6d. net.

IN this edition, among other changes, the principle is elaborated that all emotion is the affective aspect of instinctive process.

### Letters to the Editor.

[The Editor does not hold himself responsible for opinions expressed by his correspondents. Neither can he undertake to return, or to correspond with the writers of, rejected manuscripts intended for this or any other part of NATURE. No notice is taken of anonymous communications.]

#### Organisation of Scientific Work.

I HAVE only recently seen the article in NATURE of February 19 and the correspondence so unanimously supporting the view that the present decentralised system of team work by experts in different branches of science in agricultural, forestry, and medical research institutes is greatly superior to the proposed centralisation in distant Simla of each separate science—chemistry, botany, etc.—under directors of research with autocratic powers to decide what each original worker in his branch throughout India shall investigate and publish; for it is clearly impossible in these days for one man to be sufficiently conversant with each special division of his science adequately to fulfil such a stupendous task. I desire to associate myself with that view, which may be illustrated by my experience in organising the Calcutta School of Tropical Medicine, shortly to be opened, for which I have just obtained endowments from two successful European and Parsi business men for a whole-time biochemist, in addition to two other chemists for the analysis of indigenous drugs and of food and water respectively, all three of whom will aid nine medical research investigators in team work at important medical problems under a medical director. Could anyone contend that these very specialised chemists would be better controlled by a purely chemical director a thousand miles away in Simla, who could know nothing of the medical problems they will investigate?

On the other hand, if the Government of India is to provide the large sums urgently required for the further development of scientific research in India, it will require some organisation to co-ordinate and report on the work it will be financing. May it not learn a lesson from the Medical Research Committee of eminent medical men of science, which is wisely utilising the large sums supplied by the British Government in assisting the investigations of university and medical-school workers with established reputations and with a minimum amount of interference? A very similar and successful organisation was set up in India when the late Sir Pardey Lukis persuaded the Government of India to hand over five lakhs (some 50,000*l.*) a year to the Indian Research Association, administered by a governing body on which the medical members, through their special knowledge of the subject, exercise a preponderating influence; while I have recently obtained a purely medical governing body to administer the endowments of the Calcutta School of Tropical Medicine with an income of some 11,000*l.* a year, which I have been fortunate enough to raise to provide both men and apparatus without the long delays, usually of several years' duration, involved in obtaining the sanction of the Government of India and of the Secretary of State for new posts.

This plan has thus already proved its value and is capable of extension, while boards composed of a number of men of science of high standing will command much greater confidence than an autocratic director of research. The nucleus of such a body already exists in the Board of Scientific Control, which meets twice a year in Delhi and Simla, and might with greater advantage hold its principal meeting

coincidentally with the Indian Science Congress in one of the large centres of research. At a meeting in Delhi in December, 1918, I advocated, in place of an autocratic director of medical research, that an inspector of research might be appointed, who would not attempt the invidious task of laying down what each research worker should investigate and publish, but would visit different research laboratories and consult with their respective directors or councils regarding the financial and other needs of the institutes, and help to co-ordinate the work in different parts of India to prevent waste through overlapping. The recent correspondence in NATURE confirms me in that solution of the difficulty, and I venture to think that in some such ways as I have suggested the established advantages of the present decentralised system may be retained and strengthened by greater and more elastic financial aid, and be better co-ordinated, without introducing the highly objectionable autocratic and distant centralised control of the proposals now before the Indian Government to which you have directed such timely attention.

LEONARD ROGERS.

South Devon, April 29.

#### The Small Islands of Almost-Atolls.

THE familiar inductive series of fringing reefs, barrier reefs, and atolls may be further subdivided so as to contain six members: Normal fringing reefs, offshore fringing reefs, narrow-lagoon barrier reefs, broad-lagoon barrier reefs, almost-atolls, and atolls. Almost-atolls, or atoll-like reefs encircling lagoons in which one or several small islands rise, are of interest as affording a critical test of certain competing coral-reef theories, as follows: Murray's theory of out-growing reefs around still standing islands explains a completed atoll by supposing that the original volcanic island is slowly worn down as the encircling reef grows outward and the lagoon is degraded behind the growing reef by solution, the degraded central island eventually disappearing in a way not clearly explained, perhaps by outwash of its detritus from the lagoon by currents which are fed by the influx of surf over the windward reef and discharged by outflow through passes in the leeward reef. Under this theory the small island of an almost-atoll would be a nearly worn-down central island, which would exhibit rolling hills of low relief surrounded by delta flats; or in a later stage, after the delta deposits had been swept away, the low hills of the vanishing island would be encroached upon by the lagoon waves and cut back in low bluffs fronted by low-tide rock platforms that gradually deepen into the lagoon.

According to Daly's Glacial-control theory, atoll reefs are built up from the margin of platforms abraded by the waves of the lowered Glacial ocean across still standing islands that had been previously worn down to low relief by long-continued normal erosion, the reefs being built up as the ocean rises in post-Glacial time. Under this theory an almost destroyed central island would have a surface of rolling hills, cut back by cliffs which would now—except for fringing reefs that may border them—plunge into the lagoon waters to a depth of twenty or more fathoms. This inference is well supported by the occurrence of strongly cliff islands surmounting submarine banks of moderate depth in the extra-tropical seas. According to Darwin's theory of up-growing reefs on intermittently subsiding foundations—submergence by subsidence being faster than erosional degradation—atolls are produced when the central island of an up-growing barrier reef has sunk out of sight. Under this theory the lagoon of an



almost-atoll would contain one or several nearly submerged islands of mountainous or mountain-top form.

The characteristics of the small islands of hypothetical almost-atolls, as thus deduced from several theories of coral reefs, may be confronted with the appropriate facts as represented in five actual almost-atolls: The Hermit Islands, in the Admiralty group north of New Guinea; Truk or Hogueleu, in the Caroline Islands; Budd Reef, in north-eastern Fiji; the Great Astrolabe Reef, in south-western Fiji; and Mangareva or the Gambier Islands, south of the Paumotu. The Hermit Islands are enclosed by a reef about 12 miles in diameter; the largest of the islands is 3 miles long and more than 3000 ft. in height. The encircling reef of Truk is about 30 miles in diameter, and encloses some twenty small islands; the largest measures 6 by 3 miles, and several of the larger ones are from 1000 ft. to 1300 ft. high; the smaller ones rise from 20 ft. to 300 ft. Budd Reef measures 12 miles in its longest diameter; three small islands, each less than a mile across, rise from 280 ft. to 480 ft. near the lagoon centre; a small horseshoe crater island, a mile in diameter and 590 ft. high, near the north-eastern angle of the enclosing reef, appears to be of much more recent origin than its neighbours, and does not bear on the problem here considered. The Great Astrolabe Reef makes an oval loop, 6 miles wide by 10 miles long, around a lagoon containing nine small islands; it is not properly an almost-atoll reef, for on the south it continues a long distance around the four-mile island of Ono and the thirty-mile island of Kandavu. However, the small islands that its northern loop surrounds are typical residuals; the largest is scarcely a mile in length, the highest rises 460 ft.; all are of rounded, mountain-top form, their small spurs being a little cut back by shore-line cliffs, which rise from low-tide rock platforms and do not plunge into deep water. Moreover, a triangular space defined by three of the islands, a mile and a half on its open sides, has the same depth of from 17 to 20 fathoms that prevails between the islands and the barrier reef; and this is beyond explanation by the Glacial-control theory. Gambier Reef is from 12 to 15 miles across; the enclosed islands are eight in number, and the largest of them measures 4 by 2 miles and has a height of 1300 ft. Dana wrote of the larger of these islands: "The very features of the coast—the deep indentations—are sufficient evidence of subsidence to one who has studied the character of the Pacific islands; for these indentations correspond to valleys or gorges formed by denudation during a long period while the island stood above the sea" ("On Coral Reefs and Islands," 1853, p. 95). Within the polygon defined by several of these islands two soundings give depths of 38 fathoms, while the lagoon outside the polygon has no depths so great.

All these almost-atoll islands are of mountainous or mountain-top form; they appear to be residuals of originally larger islands, much reduced by sub-aerial erosion and now isolated by submergence. The smaller ones are mere summits, too small to show embayed valleys; the larger ones have somewhat embayed shore-lines, which would, according to the best accounts that I can gather, be more strongly embayed if the deltas that now partly occupy the bays were removed. None of the islands are described as strongly cliff, like those of the extra-tropical seas, although some headlands are a little cut back in low bluffs fronted by low-tide rock platforms, evidently the work of the lagoon waves at present sea-level. It thus appears that the small islands of actual almost-atolls are excellent counterparts of the mountainous or mountain-top islands of hypothetical almost-

atolls deduced as the necessary consequences of Darwin's theory, but such islands cannot be accounted for by either Murray's or Daly's theory.

The attention of European men of science has been so largely withdrawn from the study of coral reefs during the last thirty years that the coral-reef problem now has scarcely a hearing among them. It is to be hoped that, with the acquisition of the numerous islands and reefs of northern and eastern New Guinea with the neighbouring reef-encircled islands by Australia, the old problem may be taken up again by the explorers and investigators of that remarkable region. The Louisiade group in particular deserves attention. The present communication suggests some of the newer aspects of coral-reef study, which, along with the embayments of reef-encircled islands and the unconfortable contacts of fringing and elevated reefs with their foundations (see "The Geological Aspects of the Coral-reef Problem," *Science Progress*, xiii., 1919, pp. 420-44), must be taken into account for the future. All considered together, these newer aspects go far towards restoring confidence in Darwin's theory, which between 1880 and 1910 was so unreasonably discarded by many writers. The theory needs subordinate modification by the addition of changes of ocean-level during the Glacial period, to which Daly has so justly directed attention; but those changes acting alone would, whenever they occurred, produce emergences or submergences everywhere alike in their moderate amount, their slow rate, and their Pleistocene date; while all the reef-encircled islands that have yet been studied—as, for example, in Foye's "Geological Observations in Fiji" (*Proc. Amer. Acad. of Arts and Sci.*, liv., 1918, pp. 1-145)—testify to submergences and emergences at dates that are frequently unlike from place to place, and of amounts that are frequently much in excess of the most liberal estimates of Glacial changes in ocean-level. Such submergences and emergences are, therefore, to be explained by local movements of subsidence or upheaval in the islands concerned. As reef-growth has been associated chiefly with the various movements of subsidence, reinforced recently by rise of ocean-level, Darwin's theory subordinately modified is thereby supported. W. M. DAVIS.

Harvard University, Cambridge, Mass.,  
March.

#### Scientific Apparatus from Abroad.

THERE is one aspect of the proposed "anti-dumping" legislation to which I should like to direct attention.

While there is much scientific apparatus made in the British Isles of a quality at least as good as that imported, it is, unfortunately, very costly. But there are also many articles which our manufacturers have not yet learned to produce in anything like a satisfactory quality. The result of restricting the import of good articles by a heavy duty would be to compel scientific workers to use home-made goods. There would be no hardship if these goods were satisfactory. But such is by no means always the case, and we are then penalised by waste of time and frequent loss of experimental results. Moreover, if inferior goods obtain a sale by methods of this kind, no inducement is given to the makers to improve the quality.

I am aware that I may be called a doctrinaire Free Trader, but it seems to me to be a far more reasonable procedure to allow free import of such apparatus until equally good material is to be had cheaply at home. In the meantime, our manufacturers should,

if necessary, receive State aid to enable them to perfect their processes. When they can show that they have attained success, an import duty might be imposed temporarily on the foreign substitute to ensure the sale of the British article and to introduce it to the market. If the product is satisfactory, there would be no need to retain the duty for any great length of time.

Owing to the present poor rate of pay of free scientific workers, it is only just to give them generous grants if they are compelled to buy the costly home-made goods of the first category referred to above.

It will surely be admitted that the desirable state of affairs is that each country should produce what it is best fitted to do, and that there should be no necessity for protective duties. But if the League of Nations is believed to be ineffective, and if we must be prepared to be self-supporting in case of another great war, it behoves those who advocate measures to bring this about to see that the nation does not lose more than it is likely to gain.

I have confined my remarks to the case of scientific appliances, but similar considerations apply to many industrial processes. Inferior material and machinery would have to be put up with for the sake of supporting some other industry. If the foreign goods are superior they should be freely imported, and the British makers subvented until they can produce equally good material, if it is thought essential that they should do so.

W. M. BAYLISS.

University College, London.

#### The Cost of Laboratory Fittings.

In all directions we have at the present time evidence of a growing enthusiasm for education in the field of natural science. Students are being turned away from our schools and universities for lack of accommodation, and the new Education Act has given great encouragement to science teaching. Our war experiences seem to have aroused the nation to the necessity for vastly extending the facilities for these studies, and at the same time the need for financial economy is pressing in all directions.

The material requirements of science teaching are expensive, and, though heavy outlay is in the main inevitable, it seems probable that if costs cannot be reduced the very necessary expansion of science in our schools may in many cases have to be deferred or abandoned, and, possibly, curtailed in our higher institutions. The character of the fixed fittings in our laboratories has altered but little for many years, and it seems pertinent to inquire whether something could not be done by the use of alternative materials or by standardisation to reduce their cost.

I recently brought this matter to the notice of one of our learned societies, and received a very cordial reply from its council, which has referred the question to the Department of Scientific and Industrial Research; and I have reason to believe that this Department is proposing to take some action, in which event I have arranged that the Science Standing Committee of one of our Royal institutes shall be represented at any deliberations. Things, however, move slowly and time is passing, which must be my excuse for troubling you with this letter in the hope that the subject may raise some interest, and possibly lead to some constructive suggestions.

There are several obvious directions in which research on this subject, which should be neither particularly lengthy nor expensive, seem likely to be fruitful, but I must not encroach further by elaboration.

ALAN E. MUNBY.

9 Old Square, Lincoln's Inn, W.C.2.

#### The Standard of Atomic Weights.

IN reply to the letter of Prof. J. R. Partington appearing in NATURE of April 29, it has already been announced in your columns that Dr. Aston has shown neon and chlorine to be each mixtures of two isotopes with atomic weights which are whole numbers, and I have suggested that the atomic weights of all the elements with low atomic weights are very approximately of the form  $2x+a$ , where  $x$  is the atomic number and  $a$  a small integer, and there are indications tending to show that  $a$  is independent of the chemical properties of the element (see NATURE, February 26, p. 704). For the lower atomic weights the calculation is not greatly affected whether the atomic weight of hydrogen or of oxygen is taken as the standard. With the exception of hydrogen, no atomic weight is less than  $2x$ , if the atomic weight of oxygen is taken as the standard. There is, accordingly, some justification for treating the atomic weights of helium, boron, carbon, nitrogen, oxygen, and fluorine as normal and that of hydrogen as abnormal. If, as appears to be the case, the atomic weights are not only variable, e.g. lead, neon, etc., but also contain a quantity independent of the chemical properties of the element, the determination of the relative atomic weights of two elements to a high degree of accuracy will in many cases be impossible, and in some others futile.

In some respects it might be convenient to take helium as the standard for atomic weights, this element certainly assisting in a few instances to build up the atomic weight, and as helium can now be prepared in large quantity the accurate determination of its density will not be so difficult as heretofore.

STEPHEN MIALI.

28 Belsize Grove, N.W.3.

#### The Mole Cricket.

ONLY one British species of mole cricket is known, *Gryllotalpa vulgaris*. It is now becoming very rare in England. It is largely carnivorous, and by burrowing underground with its powerful fore-legs, which by a shear-like action cut through roots, it causes a certain amount of damage. It is by the peculiar



FIG. 1.—Mole Cricket.

structure of these fore-legs that the mole cricket is readily recognised and distinguished from all other insects. These legs are thicker, but shorter, than the hind-legs, each of the very short tibiae ending below in four claws spread out like the fingers of a hand. The specimen represented in the illustration was caught at Send, near Woking, in Surrey, on March 15 last.

F. V. D.

## The Optophone: An Instrument for Reading by Ear.

By DR. E. E. FOURNIER D'ALBE.

THE type-reading optophone, an instrument designed to enable blind people to read ordinary print, was described in *NATURE* in 1914 (vol. xciv., p. 4). At the British Scientific Products Exhibition of 1918 some public reading demonstrations were given with a somewhat improved apparatus exhibited by the writer and by Mr. W. Forster Brown (see *NATURE*, vol. cii., p. 10, September 5, 1918). These demonstrations sufficed to show that all the essential problems of type-reading had been solved, but the instrument then exhibited had certain defects which militated against its prolonged and convenient use by blind persons. Thus, the displacement along the line of type was effected by turning a handle, which no blind person would care to use by the hour. The construction of the apparatus generally was not sufficiently solid and substantial, in view of the fact that it had to be put into the hands of a necessarily somewhat clumsy operator.

After the close of the exhibition the construction of the instrument was undertaken by Messrs. Barr and Stroud, Ltd., of Glasgow, the well-known makers of range-finders and fire-control apparatus for the British and foreign navies. A great deal of thought and care has been bestowed upon the instrument by Dr. Archibald Barr, and the result has been a thoroughly sound, compact, and practical instrument, such as was shown by Dr. Barr in his lecture to the Royal Philosophical Society of Glasgow on March 24 last.

The general principle of the apparatus is shown by Fig. 1. A siren disc, D, is run at about 30 revolutions a second by means of the small magneto-electric motor shown. It contains five circles of square perforations, the innermost circle having twenty-four perforations, the outermost forty-two, the other circles being intermediate and corresponding to the relative frequencies of certain notes of the diatonic scale. A line of light in a radial direction is provided by the festoon lamp L, and the image of the filament of this lamp is thrown upon the print by a system of three lenses on the other side of the selenium tablet S. The axis of the concavo-convex lens C is slightly tilted out of the axis of the other lenses for a purpose which is specified below. The general result of the optical system is to give a line of luminous dots on the print, each dot having a different musical frequency. The light constituting these dots is diffusely reflected back on to the selenium, which is put in circuit with a battery and a high-resistance telephone receiver. Those dots which fall on white paper produce a note of their own musical frequency in the telephone, while those which fall on black are extinguished. We thus get what may be called a "white-sounding" optophone, in which the black letters are read by the notes omitted from the

scale rather than by the notes which remain sounding. All the reading demonstrations hitherto undertaken have been given with a "white-sounding" optophone.

A modification of this principle, introduced by Messrs. Barr and Stroud in consultation with the writer, is the provision of a second selenium preparation in the form of a cylindrical rod, the top of which can be seen at B (Fig. 1). This rod receives the light reflected by the concave surface of the lens C, which produces a real image of the line of dots on a generator of the cylindrical rod, and by turning this rod about its axis the image can be made more or less effective as desired. By balancing the effect on B against the effect on S, when white paper alone is exposed, a silence can be produced in the telephone, and the effect of the passage of a black letter is to make a sound which varies in accordance with the formation of the letter. This is the principle of what may be called a "black-sounding" optophone, and

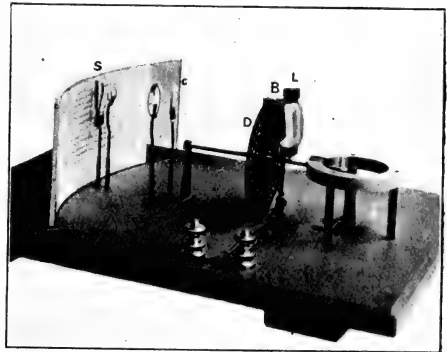

FIG. 1.—Skeleton apparatus showing the principle of the optophone.

although its advantage over the white-sounding type has yet to be proved, there is little doubt that the learning of the alphabet sounded on the new principle will be easier, though in the writer's opinion the ultimate speed acquired by either black-sounding or white-sounding will be approximately the same. It is interesting in this connection to note that Miss Mary Jameson, the blind girl who gave the demonstrations at the 1918 Exhibition, now reads habitually at a speed of about twenty-five words a minute with a "white-sounding" optophone made by Messrs. Barr and Stroud, and finds, indeed, that when the instrument is adjusted for a lesser speed reading becomes more difficult.

The present construction adopted by Messrs. Barr and Stroud is shown in Fig. 2. The disc, lamp, lenses, and selenium, as well as the motor, are all mounted in the swinging "tracer," which

can be brought over to the right by means of the reading-handle H. It then returns to the left with a slow, silent, and steady motion regulated by the worm gearing W, which drives a small paddle inserted in a viscous liquid. This paddle can be inserted more or less deeply into the liquid by the regulating nut R, and such is the range

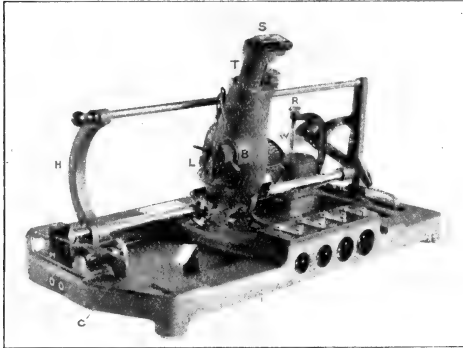

FIG. 2.—The optophone with book-rest removed.

of adjustment possible that a line can be read in anything from five seconds to five minutes, according to the proficiency of the reader. When the line is read, the next line is brought into focus by the change-bar C, which works a friction grip inside the bar on which the "tracer" is pivoted, and can be adjusted for any desired line space

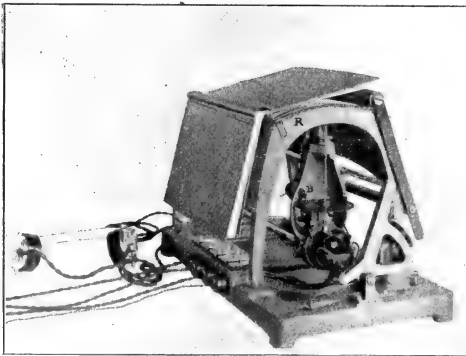

FIG. 3.—The optophone complete with book-rest.

by means of the screw attached to the change-bar. A lever attached to the "tracer" enables the operator to reverse this motion or to release the whole "tracer" from the friction gear, so that it may be quickly brought to the top of a page.

NO. 2636, VOL. 105]

The festoon lamp is inserted at L, where it is held by a spring clip, and whence it can easily be removed for renewal even by a blind operator. The balancer is inserted at B, and can be adjusted for silence by means of the small handle shown.

Fig. 3 shows the apparatus from the top page end and with telephone and flex connections attached, as well as the book-rest R holding a book. The adapters of these flex connections are all of different sizes, and fit into different-sized holes in such a manner that they cannot be wrongly inserted—an important consideration with blind operators.

The various connections with their switches are for the motor, the lamp, and the two selenium circuits respectively. When the adapters are removed, a cover can be placed over the whole instrument, which clips on to the aluminium base, and the optophone can thereupon be carried about like a typewriter.

Fig. 4 shows the manner in which the instrument is manipulated by a blind person.



FIG. 4.—Line-changing with the optophone.

Special mention ought to be made of a contrivance for adjusting for various sizes of type. The middle lens of the three shown in Fig. 1 is mounted in a nut which can be screwed up and down within the "tracer" by means of two gaps cut in the upper cylindrical portion at T (Fig. 2). The nut is provided with six nicks across the rim, which enable a blind operator to count the number of turns of the nut, and thus to adjust for any definite size of type. This ingenious contrivance is, I believe, due to Dr. Stroud.

In practice it is found that, with the new apparatus, the various adjustments for size of type, length of line, and line interval are quite easily made by blind persons, and that the instrument, with all its delicate adjustments, can remain in use for a long time without anything getting out of order. It is therefore safe to say that the problem of opening the world's literature to the blind is now definitely solved.

The Kalahari and Ovamboland.

By PROF. E. H. L. SCHWARZ.

THE Kalahari and Ovamboland belong physiographically to one and the same province; the former is a region of red sand and the latter of white sand. The whole area, some 350,000 square miles, is blocked by an encircling ring of hard rocks, breached on the east by the Victoria Falls, on the south by the Auhrabies Falls on the Orange River, and on the west by the great cataract (300 ft. high) on the Cunene River. The consequence of this peculiarity is that the whole

300 miles long by 100 miles broad; part of the breadth in the northern half is occupied by sand dunes, so that the effective area is now less than that of Victoria Nyanza; but before it was tapped by the Zambezi it must have been a little larger. The Zambezi enters the depression at the Mambove Falls, follows the northern boundary, and leaves the old lake at Kasungula. It is not certain when the Zambezi first breached the wall and let out the waters of the lake; the Portuguese maps

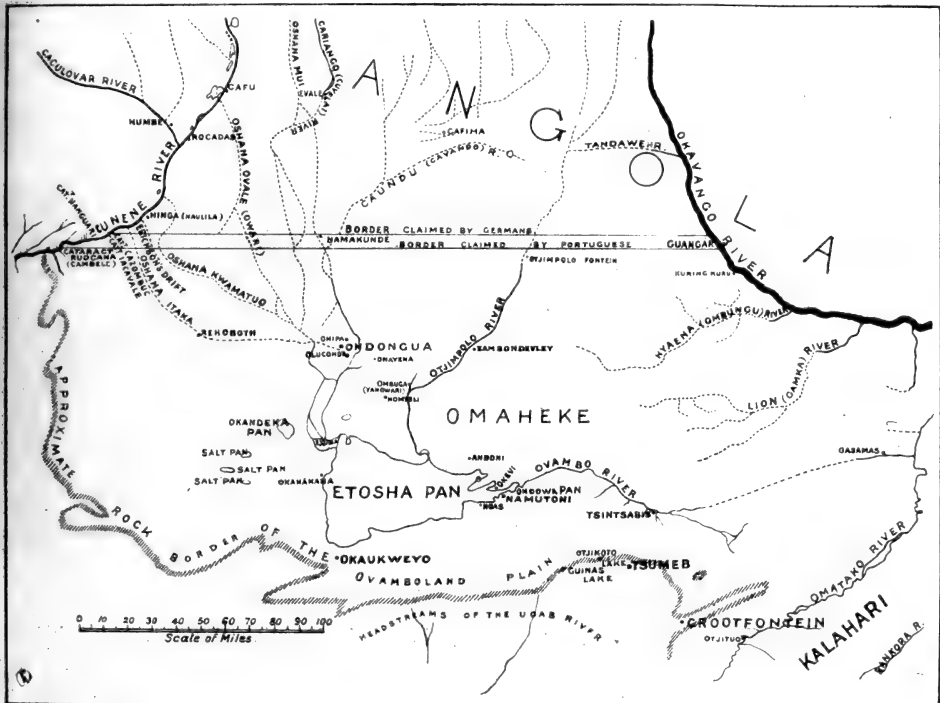

FIG. 1.

region is flat and the rivers have scarcely any fall, the floods seeping rather than flowing along the sandy river-beds and blocking up the channels with bars made of branches, reeds, and other rubbish, so that there has been a constant changing in the distribution of the water.

On the west there are two great depressions, the Makarikari and the greater Ngami. Livingstone obtained the impression that the two formed the bed of one enormous lake, but the map of Passage shows the two very clearly defined. The greater Ngami is a depression elongated in a south-westerly direction, with parallel sides, and

before Livingstone's time showed the river beginning not so very far above Zumbo, and we know that the Portuguese had a very good idea of the country so far back as the sixteenth century. The Falls cannot be of very great age, because the gradient below them is more than 15 ft. to the mile, and a great river like the Zambezi would have flattened out the gradient if it had been of any considerable age. The recent earthquake at New Langenburg, at the head of the Loangwa River, shows that the area is one of great seismic activity, so that the original idea of Livingstone and Murchison, that the crack was formed by

such agency, is worth reconsidering. Certainly the idea that the river has worked back along joints requires some modification, because the depth of the crack, reckoning from the top of the Falls to the bottom of the gorge, is more than 1100 ft., and joints do not penetrate so deep.

Two rivers fan out on the floor of the depression of the greater Ngami, in the same way that the Rusisi does on the plain on the north of Tanganyika, which has been exposed since the Lukuga tapped the lake and drew off the water; this last case, according to Arab accounts, has occurred within the last 500 years or less. The Ngami feeders are the Okavango and Chobe rivers. The Chobe flowed south in Chapman's time (1852), but the channel became blocked with reeds and rubbish below the Mababe swamp, and it now goes straight into the Zambezi. The Okavango until quite recently also flowed south into the Ngami of Livingstone, but a branch, the Selinda, has developed which takes the water into the Chobe and so into the Zambezi, and Ngami is now dry.

When the Chobe and Okavango rivers flowed south to Lake Ngami the water overflowed from that lake into the Botletle, which breached the eastern wall of the depression, and so made its way to the Makarikari. This depression has an area of 15,000 square miles and two "floors"; the Soa and Ntwetwe Pans form the lowest levels, while around are immense grass flats. We know fairly definitely that this dried up about 1820, thirty years before Chapman was there, and the Bushmen described to him how the whole expanse was then covered with dead hippopotamus and fish. Now the Botletle very seldom reaches the Makarikari, though the floors may fill for a few weeks from drainage from the east.

When the waters of the upper Zambezi were impounded in the Ngami depression, the water flowed south from the Makarikari into the Letwayo or Okwa, and found its way into the Molopo and so to the Orange River. According to traders who have crossed this part many times, the old channel can still be traced; certainly the lower Molopo has a bed far greater than would have been cut had it only carried the waters from the tributaries now shown to connect with it. The region between the Makarikari and the bend of the Molopo is the "Great Thirst"; the main routes through the Kalahari are now fairly safe and the Government has put down bore-holes for the accommodation of travellers, but it is still exceedingly difficult to explore away from the main tracks. The natural slope of the plain of the

Kalahari is to the S.S.W., so that there was nothing to prevent the original river taking the course indicated; when the water was diverted to the Zambezi the area became a waste of sand. The French in the western Sahara have similarly shown that the ergs or sand deserts occupy the basins of former river systems.

Ovamboland is just a great level river plain, the ideal peneplain. Every part of it is covered with shallow depressions, sometimes connected, forming rivers; at others they are in parallel series of disconnected hollows, elongated in the direction of the nearest river. In between are sandy tracts covered with forest. In this there are a number of wide, open tracts, which form the main habitable areas, and each of these openings is occupied by a separate tribe of Ovambos. On the north there are the Cunene and Okavango rivers, which have built themselves above the



FIG. 2.—Rucana Cleft, Cunene River.

plain, and in flood-time they overflow their banks and send the water down spillways which, in former years, filled up all the depressions and converted the country into a swamp; something like a third of the plain was then submerged. As the flood subsides, the crops, which are planted on series of little sand-hillocks, rapidly come to maturity in the damp, steaming atmosphere, the palms and morula-trees yield wine, and the lot of the Ovambo was then a pleasant one.

The spillways from the Okavango still carry water out from the river southwards, but not in sufficient quantity to reach any distance; and those from the Cunene are quickly diminishing. The rapid lowering of the beds of the main rivers by erosion has resulted in the desiccation of the country, and at no very distant date Ovamboland will become a land of the "Great Thirst" like the Kalahari. The conversion of an area of

70,000 square miles from the condition of a tropical swamp, similar to the Bahr-el-Ghazal, into a wilderness of dead trees and withered grass has had a very bad effect on the climate of South Africa, and the consequences are noticeable north as well as south of the Zambezi; the completion of the process is a matter of a few years only. What has happened in Ovamboland occurred in the Makarikari a hundred years ago, and in the central Kalahari not so very long before that; so, section by section, this great area has lost its water-supply, and between 300,000 and 400,000 square miles of country have become desert within comparatively recent times.

The spillways from the Cunene on one side, and those from the Okavango on the other, connect in the great depression to the south, the Etosha Pan. This is a "floor," like the Soa and Ntvetwe Pans, only here there is no trace of brak, the level pan being



FIG. 3.—Cambele Ca aract, Cunene River.

covered with a dark green film due to microscopic plants which turn a yellowish-green when moistened with water from a thunderstorm. Very little water finds its way into the pan down the river channels nowadays. The grass flats round the pan are some 5 ft. above the level of the floor, and are often black with zebras, wildebeests, gemsbok, koodoos, and springbok, with the attendant lions. The late Mr. J. W. F. Breijer was game ranger at the time of my visit, and it is due to his tireless efforts to suppress poaching that the game has returned to the district; to him also I owe the tracing of the Lion River, a spillway from the Okavango to the Etosha, thus completing the through connection of the Cunene and Okavango rivers.

The restoration of the Kalahari and Ovamboland plains by weiring up the outlets on the north and turning the waters of the Cunene on one hand, and of the Okavango and Chobe rivers on the

other, would convert these countries into habitable regions once more. Both rivers are necessary, for the one reinforces the other. Ovamboland would be converted into a swamp, a condition of affairs which the natives are accustomed to and thrive on; as it is, they are always on the verge of starvation, and in 1915-16 thousands died of starvation, and their bones are strewn for 200 miles along the road from Ondongua to Tsumeb, the terminus of the railway, where they had expected to get food and work. Ovamboland is not suitable for white settlement, but from the evaporation from this vast swamp the rivers, like the Zambezi and Okavango, would be reinforced at their sources, and their diminishing volume converted into an increasing one. The Kalahari, on the other hand, is eminently suited for white settlement; with water anything will grow; cotton is indigenous and would form the summer crop as in Egypt;

wheat grows as a winter crop, and mealies (maize) as an autumn one. Away from the actual irrigation furrows the ranching possibilities are enormous. The country is now nominally under Bechuana chiefs; but, while every consideration can be paid to their wants, a meagre population of 150,000 natives cannot indefinitely hold up a country of 300,000 square miles. White settlement could proceed without interfering in any way with the natives, as there is room enough for all.

The effect on the climate of South Africa is another matter. We know that hippopotamus swarmed all over the Karroo in not very distant times, for their bones are dug up all over it in the dry river-beds. Before the Makarikari went dry in 1820, Barrow, Lichtenstein, and Le Vaillant described

finding hippopotamus in enormous quantities in typical Karroo country like Cookhouse, and the banks of the rivers were clothed with subtropical forest, in which roamed rhinoceros, elephant, eland, etc. The Karroo within the last 120 years, in the eastern portion, was a country similar in flora and fauna to British East Africa. Would the restoration of the Kalahari affect the Karroo? The lost lakes formed the end of the series of great lakes in Central Africa, and the function of these latter is to provide moisture for the inland regions. The central areas of Africa lie so high that moisture blown in from the sea is dropped on the edge by the diminution of pressure, and very little is left for the centre from these sources. With the Kalahari lakes restored and the vegetation once more established, it seems reasonable to suppose that the effect will be the same as that produced by the great northern lakes on their neighbouring regions.

### The Royal Academy.

EVERY critic of the Royal Academy finds material for praise or for condemnation from whatever point of view he regards the works exhibited, and the scientific visitor is no exception to this rule. Indeed, it is impossible that among so large a number of works all should be of the same high order of merit as are the few produced by master hands. From the scientific point of view it is not difficult to divide the sheep from the goats—the true representations of Nature from the grotesquely unreal. It may be presumed that the perpetrators of the latter type of work visit the Academy and there study the pictures of their fellow-artists. If this be so, it is astonishing that they should continue from year to year to produce unreal caricatures of natural objects, when often in close contiguity to their pictures are to be seen beautiful representations of the same type of scenes, truthful to life in every particular, and gaining immeasurably thereby. The fact that both obtain admittance to Burlington House must be taken to demonstrate that both are of artistic merit, but there the similarity ends.

An example of this contrast in methods of dealing with a subject may be found in this year's exhibition by comparing "Off the Land" (38) with "Sunset at Sea" (347). Both show sea and sky scenes. The former gives a perfectly natural representation of light from the sky reflected in the sea, while in the latter an intensely red sunset sky meets at the horizon an intensely blue sea, a condition unlikely to obtain while water possesses its normal powers of reflection. The effect is so entirely unnatural that it is difficult to believe, without reference to the title, that the lower part of the picture is meant to represent water at all. In Gallery No. III., on either side of the chief centre piece, with which the scientific critic is not concerned, are two pictures of yacht

racing which form an interesting contrast. When looked at from near-by the one is wholly delightful, while the other is spoilt by its crude sky. When, however, a view is taken from a considerable distance, the two pictures appear of more equal merit. The contrast between the two methods of treatment is brought out strikingly by the juxtaposition of the pictures, be it accidental or otherwise.

A feature of the present exhibition which will strike the visitor is the extraordinary sea-colouring in several of the works, though examination of the catalogue shows that for this a single artist is largely responsible. One case has already been cited. To mention one other from among several examples, it would be very surprising to meet in Nature with the contrasts in colouring depicted in "The Sunken Reef" (177). The writer has not had any opportunity of studying dazzle-painted ships in their natural surroundings, but if in the work "In the Narrow Seas" (200) Mr. Norman Wilkinson has given a correct representation of the effect produced—and there seems no reason to doubt that this is the case—it is well brought home to the landsman how baffling the effect must have been to the commanders of enemy submarines. In "The Forerunner" Leonardo da Vinci is seen showing a model of his flying machine to Ludovico Sforza, Duke of Milan, and his Court. Some of the spectators look amused, and for this the modern airman will find little difficulty in forgiving them. Several of Leader's beautiful scenes are exhibited. In studying "An Autumn Evening" (139) one wonders what object outside the picture casts a shadow over the lower part of the trees, while the upper part is illuminated with an evening glow; but there is no temptation to doubt the truthfulness of the portrayal.

J. S. D.

### Obituary.

CAPT. E. W. CREAK, C.B., F.R.S.

CAPT. ETRICK WILLIAM CREAK, who died in his sleep on April 3, was the son of the late Commander William Creak, of Norfolk, and a nephew of Sir H. Have-lock, of Lucknow fame. He joined the Navy in the navigating branch of that Service about the year 1849, and served in various ships afloat until he was selected in 1868 to serve as an assistant in the compass department of the Admiralty. His service afloat was distinguished not only by his nautical acquirements and the remarks he sent from time to time to the Hydrographer, for which he was specially thanked in 1866, but also by his knowledge of French and music, rather rare acquirements in those days. He was able to add to our knowledge of some unsurveyed

localities by his study of surveying operations, particularly by a plan of Ngaloa Bay, in the Fiji Islands, when serving in H.M.S. *Esk* about 1866. About this time Capt. Creak turned his attention to the errors of the compass on board certain ships which had traversed a great range of magnetic latitude, which inquiry was embodied in a report to the Admiralty and published by the Board of Trade. This marked him out as a suitable officer to be employed in the investigation of compass errors in H.M. ships, which were being increasingly constructed of iron and steel. For his services in the compass department and his magnetic reports he was made a fellow of the Royal Society in 1885, and he became superintendent of the Admiralty compass department in 1887.

Capt. Creak took an active part in the determination and control of the constants required for



the reduction of the magnetic observations made by the *Challenger* expedition, 1872-76, during which expedition it was discovered that the coral islands of Bermuda lay over a magnetic field in which the variation of the compass differed as much as  $6^{\circ}$ , viz. from  $4^{\circ}$  W. to nearly  $10^{\circ}$  W., the true variation of the needle being  $7^{\circ}$  W.; this was ascertained by swinging the *Challenger* on every point in deep water close to the islands, and this process was continued on board that vessel in many other parts of the world, where the true variation was affected by local attraction on shore, so that the results of the shore observations were not trustworthy; but the *Challenger* being a wooden vessel, although not entirely free from iron in her construction, better results were obtained by swinging her in deep water near the land. The results of the *Challenger* observations are published in vol. ii. of the official narration of the voyage, and in vol. ii. of the reports on the physics and chemistry of the expedition, where plans, constructed by Creak, are given of the magnetism observed at the Bermuda Islands, and also charts of the variation, inclination, horizontal force, and vertical force for the epoch 1880, constructed mainly from the *Challenger* observations, combined with all other observations available to the date of publication.

Capt. Creak pointed out in his magnetic contributions that at certain positions in the world magnetic shoals exist which affect the compasses of vessels sailing over those shoals. One such shoal near Cossack, in North Australia, was crossed by H.M. surveying vessel *Meda*, in a depth of 8 fathoms, with two shore objects transit, and the compass needle was deflected  $30^{\circ}$  for about one mile.

At Funafuti, another coral atoll in the Pacific, in lat.  $8^{\circ} 30'$  S., long.  $179^{\circ} 12'$  E., another magnetic field exists, where the variation changes nearly  $2^{\circ}$ , and the dip  $1^{\circ}$ , in different localities, as shown by the magnetic survey of the atoll made by Admiral Sir A. Mostyn Field in H.M.S. *Penguin* in 1895, the results being investigated by Capt. Creak, and published by the Royal Society in 1904. Capt. Creak also instructed the officers engaged in the Arctic expedition of 1875-76 under Capt. G. S. Nares, R.N., and prepared the directions and magnetic charts for the "Arctic Manual," 1875. He also prepared the magnetic instructions for the Antarctic expedition of 1901. When, owing to his having reached the age of fifty-five, he had to retire from active service afloat in 1890, and to his not having served the number of years afloat to entitle him to be retired with the rank of captain, a special Order in Council was issued giving him that rank, so that his important services in the compass department should not deprive him of the honour he would have received had he served the requisite number of years at sea.

During Capt. Creak's service in the compass department the late Lord Kelvin invented a compass superior to that then in use in H.M.

ships, which was adopted by the Admiralty; but, owing to the increase in the size of the guns in H.M. ships, this compass was eventually discarded for a liquid compass brought out by Capt. Creak, which is now the standard instrument afloat, and is furnished with a special azimuth circle for use in torpedo-boats, destroyers, etc., all other compasses having failed to stand the vibration and motion and the gunfire in these vessels. He also brought out a simple form of instrument for correcting by magnets the heeling errors, and invented the Lloyd-Creak dip and intensity apparatus, originally meant for observations afloat, but which has been found very useful also on shore. This instrument was fully described in *Terrestrial Magnetism* for October, 1901.

In 1903 Capt. Creak was president of the geographical section of the British Association, and in his presidential address at Southport in that year gave an interesting account of the progress of our knowledge of magnetism both afloat and ashore up to that time, which was published in the Proceedings of the British Association, and also in the *Geographical Journal*, vol. xxii., 1903. He was made a C.B. in 1901, in which year he was retired from the compass department at the age of sixty-six. Capt. Creak also assisted the late Sir Frederick Evans and Mr. Archibald Smith in preparing and publishing the "Elementary Manual for the Deviations of the Compass in Iron Ships" in 1870, and after the death of Sir F. Evans later editions of that manual were entirely prepared and published by Capt. Creak. In the ninth edition prepared by him in 1895 the question of heeling error and its correction was specially discussed, and tables were given to assist in the correction of quadrantal deviation and the application of the Flinders bar, etc.

T. H. T.

#### SIR EDMUND GILES LODER, BART.

THE death of Sir Edmund Loder at the age of seventy removes from the ranks of English country gentlemen one of the cultivated members of that class. Possessed of ample means and abundant leisure, Sir Edmund devoted his youth and middle age to field sport and travel in many lands. In the pursuit of big game in four continents his fine marksmanship enabled him to make the very large collection of horned and other trophies now preserved at Leonardslee. He was among the last of British sportsmen to take toll of the dwindling herds of bison in North-west America, and the first European to obtain a specimen of the little desert antelope, named after him, *Gazella Loderi*, which inhabits the Sahara contentedly without access to water.

Were that all, it would scarcely serve to raise Sir Edmund Loder above the common ruck of big-game shooter and globe-trotter; but he possessed and exercised the gift of accurate observation, enabling him to acquire much sound knowledge of the habits of wild animals, and to distinguish their specific affinities. Unfortunately, he had

not the knack of recording his experience. Not only was he destitute of all turn for literature, but the mere act of putting pen to paper was intolerably irksome to him. This is the more to be regretted, because the few papers on zoology and botany which he contributed to scientific journals contained sound, and sometimes important, information.

Sir Edmund's indolence in this respect had no counterpart in his botanical work, for he took infinite personal pains in the delicate operation of hybridising rhododendrons. His crowning achievement in that line has been the magnificent cross between *R. Griffithianum* and *R. Fortunei* which appropriately bears the name *R. Loderi*, and is generally admitted to be the grandest hardy hybrid hitherto raised in that genus. The collection of conifers which he formed and grew at Leonardslee contained more species than any other in the United Kingdom.

Only a few weeks before Sir Edmund's death the present writer spent an afternoon with him in the wonderful landscape he had created at Leonardslee. The early Asiatic rhododendrons were already ablaze; there was no warning in that fair scene; but now comes Horace's dirge irresistibly to mind:—

Linquenda tellus et domus et placens  
Uxor, neque harum quas colis arborum  
Te, præter invisas cupressus,  
Ulla brevem dominum sequetur.

HERBERT MAXWELL.

PROF. WILHELM PFEFFER, FOR. MEM. R. S.

W. PFEFFER, who died on January 31 last at Leipzig, was born in 1845 near Cassel, the son of an *Apotheker*; he studied at a number of German universities, his Ph.D. being taken at Göttingen. He was first a Privatdozent at Marburg, then assistant-professor at Bonn, and later full professor at Basel, in Switzerland. In 1878 he went to the University of Tübingen, and in 1887 to the University of Leipzig, where he remained for the rest of his life. He was elected a foreign member of the Royal Society in 1897. Pfeffer may be associated with Sachs as the founder of modern plant physiology. He and the late Prof. Strasburger, of Bonn, were for a long time the two best-known German botanists, and for many years they drew to their respective laboratories numerous foreign workers, particularly from the United States. Pfeffer was the author of many scientific papers, but he is perhaps best known for his "Pflanzenphysiologie," of which the first edition appeared in 1880, and the last part of the second edition in 1904; the second edition was translated into English. This handbook was a truly monumental work, in which a wealth of material was dealt with with great critical insight; hence it was for many years the standard and invaluable reference book on the subject. Pfeffer's work in 1877 on osmotic pressure, which laid the foundation of our more exact knowledge of that phenomenon, must also be referred to. With his

death the three outstanding figures of the older German botany—Sachs, Strasburger, and Pfeffer—have all passed away.  
V. H. B.

IT is with much regret we learn of the death, on February 20, of MR. MAXWELL HALL, Government Meteorologist of Jamaica. Mr. Maxwell Hall was a barrister-at-law and resident magistrate for the district of Hanover. His interest in meteorology has placed the knowledge of the weather of Jamaica on a better basis than that of any other West Indian island. He succeeded in establishing a weather service in Jamaica in 1880, the objects being to encourage the recording of rainfall and to foretell the approach of hurricanes. In 1911 rainfall records were available from 194 stations, with observations at each for at least ten years. It is hoped that this fine record of work will not be interrupted by the death of its originator. For upwards of thirty years Mr. Maxwell Hall was a fellow of the Royal Meteorological Society.

THE death is announced of LORD GUTHRIE, one of the senators of the College of Justice in Scotland, at seventy-one years of age. Charles John Guthrie was admitted to the Faculty of Advocates in 1875, and, after a successful career at the Bar, was appointed a Judge in the Court of Session in 1907. Lord Guthrie was for a time president of the Royal Scottish Geographical Society and chairman of the Early Scottish Text Society. His interest in antiquities led to his election as member of the councils of the Antiquarian and Scottish History Societies. He was joint author of the memoirs of his father, the Rev. T. Guthrie, D.D., founder of the Ragged Schools and editor of the *Sunday Magazine*. In the world of literature he will be best remembered as a friend in youth of Robert Louis Stevenson, of whose nurse, "Cummy," he published an appreciation in 1914.

MEMBERS of the British Association who have attended any meeting for many years past will learn with regret of the death of MR. H. C. STEWARDSON, the chief clerk and assistant treasurer. Mr. Stewardson's record of devoted work was particularly notable. He entered the service of the association in 1873, being encouraged to do so by William Spottiswoode, president of the association in 1878, to whom he was apprenticed in the printing business. The annual reports of the association owe much to his careful reading and indexing, and he was also specially concerned with the work of the Corresponding Societies Committee, and compiled its valuable annual catalogue of communications to local scientific societies. Mr. Stewardson was a member of the Stationers' Company.

THE RIGHT HON. SIR THOMAS W. RUSSELL, Vice-President of the Department of Agriculture and Technical Instruction for Ireland from 1907 to 1918, died on May 2 in his eightieth year.

## Notes.

THE first conversazione of the Royal Society this year will be held in the rooms of the society at Burlington House on Wednesday evening next, May 12.

A SUMMER meeting of the Institution of Naval Architects will be held in Liverpool on July 6-8. Meetings for the reading of papers will be held, and arrangements will be made to visit some of the principal shipbuilding and other works in Liverpool and its vicinity.

SIR HENRY A. MIERS, Vice-Chancellor of the Victoria University of Manchester, has been re-elected president of the Manchester Literary and Philosophical Society for the session 1920-21. Dr. H. F. Coward and Prof. C. A. Edwards have been elected honorary secretaries.

A PUBLIC meeting, arranged by the National Union of Scientific Workers, will be held on Tuesday next, May 11, at 8.30 p.m., at the Imperial College Union, Prince Consort Road, South Kensington, for the discussion of "The Economic Position of Scientific Workers." The chairman will be Dr. H. M. Atkinson, and the subject will be introduced by Prof. J. B. Farmer and Dr. J. W. Evans.

SIR HENRY BIRCHENOUGH has been appointed chairman of the British Dyes Corporation in succession to Lord Moulton, whose resignation is announced. Sir Henry was chairman of the Royal Commission on Paper, 1917; of the Committee on Cotton-growing in the Empire, 1917; and of the Advisory Council to the Ministry of Reconstruction, 1918.

A COMMITTEE of fellows of the Royal Society and members of the University of Cambridge has been formed for the purpose of collecting funds for a memorial to be erected in Westminster Abbey to the late Lord Rayleigh in recognition of his eminent services to science. Lord Rayleigh was both president of the Royal Society and Chancellor of the University, and an appeal has been issued by the society and the University. It is thought, however, that there may be some men of science unconnected with either of these bodies who may wish to show their appreciation of Lord Rayleigh's work. Donations may be sent to the hon. treasurers of the fund, Sir Richard Glazebrook and Sir Arthur Schuster, at 63 Grange Road, Cambridge.

THE council of the Institution of Civil Engineers has made the following awards for papers read and discussed during the session 1919-20:—Telford gold medals and Telford premiums to Mr. David Lyell, Mr. J. K. Robertson, and Major-Gen. Sir Gerard M. Heath; a George Stephenson gold medal and a Telford premium to Mr. Maurice F. Wilson; a Watt gold medal and a Telford premium to Mr. P. M. Crosthwaite; and Telford premiums to Major E. O. Henrici, Sir Francis J. E. Spring, Mr. F. O. Stanford, Mr. J. Mitchell, Mr. J. W. Sandeman, and Dr. A. R. Fulton.

LT.-COL. SIR LEONARD ROGERS, I.M.S., has recently returned from India on a year's leave on

medical certificate, on the expiry of which he will have only a short period of Indian service remaining before being retired under the age rules. As he has completed the organisation of the Calcutta School of Tropical Medicine for opening next autumn with a full staff, he does not propose to return to India, but to devote himself to continuing his researches on the treatment of tuberculosis, which have already yielded some promising results in India, and have arisen out of his successful method of treating leprosy by injections of soluble preparations of the unsaturated fatty acids of various oils.

At the annual general meeting of the Marine Biological Association, held in London on April 28, Sir E. Ray Lankester was re-elected president of the association, and Sir Arthur Shipley chairman of council. The Rt. Hon. Sir Arthur Griffith-Boscawen was added to the list of vice-presidents, and Messrs. T. H. Riches and Julian S. Huxley became members of council for the first time. The council reported that donations amounting to 1770*l.* had been promised towards the erection of new laboratories and the equipment of a department of general physiology. Scientific work at Plymouth during the year had been specially directed to a comparison of the condition of the trawling grounds with that which had been observed before the war, to the continued study of the distribution of post-larval and young adult stages of fishes and the food eaten by fishes when in these stages, and to observations on the invertebrate fauna, particularly on the rate of growth of various organisms.

THAT the Plumage Bill was "talked out" in the House of Commons last Friday is probably due to the fact that it did not come before the House until the day was far spent. As a private members' Bill, its chances of success, should the debate be resumed on some future Friday, are not great. The Hon. E. S. Montagu spoke briefly, and to the point, in its favour, remarking that the Government was extremely anxious to see the Bill passed into law. He did not believe, he said, that the passing of the measure would destroy any legitimate trade. Lord Aberdeen's Bill, which is on its way to the Commons, affords yet another chance, though a slender one, for necessary legislative action. It does not seem to be realised, even by zoologists, that the matter is one of real urgency, not merely for ornithologists, or for those who desire to protect birds for their own sake, but for all who are concerned with problems of economic zoology and pure science. It is therefore devoutly to be hoped that this matter will at once be taken up by men of science in all seriousness. Their considered opinion is necessary if any Bill restricting the import of plumage of wild birds is to become law before extermination has set its seal upon a number of species which are well within the "danger-zone."

THE need has long been felt for a corporate body analogous to the Institute of Chemistry which would represent the profession and strengthen the position of workers engaged in physics, and would also form a bond between the various societies interested. The

Institute of Physics has been founded for this purpose by the co-operation in the first instance of the Faraday Society, the Optical Society, and the Physical Society of London; and the first board is constituted from representatives appointed by the councils of these societies. It is hoped that in the course of time other societies will associate themselves with the institute. There will be three classes of members: Ordinary members, associates (A.Inst.P.), and fellows (F.Inst.P.). Only the two latter classes, membership of which will require full professional qualifications, will be corporate members. The institute has already received promises of support from leading physicists, and the initial expenses are covered by a guarantee fund amounting to more than 1200*l.* The first president of the institute is Sir Richard Glazebrook, Sir Robert Hadfield is treasurer, and Prof. A. W. Porter honorary secretary. The other members of the board are:—Dr. H. S. Allen, Inst.-Commander T. Y. Baker, R.N., Prof. F. J. Cheshire, Dr. R. S. Clay, Mr. W. R. Cooper, Prof. W. H. Eccles, Major E. O. Henrici, Dr. C. H. Lees, Mr. C. C. Paterson, Major C. E. S. Phillips, Dr. E. H. Rayner, Mr. T. Smith, and Mr. R. S. Whipple. Mr. F. S. Spiers has been appointed secretary to the institute, and further particulars and forms of application for membership may be obtained from him at 10 Essex Street, Strand, W.C.2.

DURING the last ten years important research work on the corrosion of metals, and particularly on condenser tubes, has been carried on by the Corrosion Research Committee, which was founded under the auspices of the Institute of Metals. Very considerable progress in the study of this difficult subject has been made by the investigators acting under the direction of the committee, and the five reports which have been issued contain most valuable information, both as to the factors which influence corrosion and as to the methods of preventing corrosion, especially in the case of marine condenser tubes. The financial support of the investigations has been provided partly by the Institute of Metals and partly by the makers of tubes and of condensers. More recently a grant has been received from the Department of Scientific and Industrial Research. The cost of the investigations is, however, considerable, and the committee now makes an appeal for further funds from the users of tubes and condensers, who are equally interested in the question with the manufacturers. The continuance of a Government grant is contingent on a sufficient sum being provided by persons interested in the research. The persons affected by the work include shipbuilders and shipowners and also the insurers of ships, and it is hoped that a sum of something like 1000*l.* per annum can be raised from this source. Particulars of the work may be obtained from the secretary of the Institute of Metals, 36 Victoria Street, Westminster, London.

At the annual general meeting of the Institution of Civil Engineers held on Tuesday, April 27, the result of the ballot for the election of officers for the year 1920-21 was declared as follows:—*President:*

Mr. J. A. Brodie. *Vice-Presidents:* Mr. W. B. Worthington, Dr. W. H. Maw, Mr. C. L. Morgan, and Mr. Basil Mott. *Other Members of Council:* Mr. E. A. S. Bell, Dr. C. C. Carpenter, Col. R. E. B. Crompton, Mr. M. Deacon, Sir Archibald Denny, Bart., Sir William H. Ellis, Mr. A. Gordon, Mr. W. W. Grierson, Sir Robert A. Hadfield, Bart., Sir Brodie H. Henderson, Mr. E. P. Hill, Mr. G. W. Humphreys, Mr. Summers Hunter, Mr. H. G. Kelley, Mr. C. R. S. Kirkpatrick, Mr. J. Marchbanks, Mr. H. H. G. Mitchell, Sir Henry J. Oram, Mr. F. Palmer, Capt. H. Riall Sankey, Sir John F. C. Snell, Mr. W. A. P. Tait, Mr. A. M. Tippet, Mr. E. F. C. Trench, Prof. W. H. Warren, and Sir Alfred F. Yarrow, Bart. This council will take office on the first Tuesday in November next.

THE annual meeting of the members of the Royal Institution was held on May 1, Sir James Crichton Browne, treasurer and vice-president, in the chair. The annual report of the Committees of Visitors for the year 1919, testifying to the continued prosperity and efficient management of the institution, was read and adopted, and the report of the Davy Faraday Research Laboratory Committee was also read. Sixty-four new members were elected during the year, and sixty-two lectures and nineteen evening discourses were delivered. The following gentlemen were unanimously elected as officers for the ensuing year:—*President:* The Duke of Northumberland. *Treasurer:* Sir James Crichton Browne. *Secretary:* Col. E. H. Hills. *Managers:* Dr. Horace T. Brown, Mr. J. H. Balfour Browne, Mr. J. Y. Buchanan, Mr. Burdett-Coutts, Sir James J. Dobbie, Dr. J. Dundas Grant, Dr. Donald W. C. Hood, the Right Hon. Earl Iveagh, Mr. H. R. Kemps, Sir Ernest Moon, the Hon. Sir Charles Parsons, Sir James Reid, Bart., Sir Ernest Rutherford, the Right Hon. C. Scott-Dickson, and Sir Henry Wood. *Visitors:* Sir Hugh Bell, Bart., Sir William H. Bennett, Mr. W. R. Bousfield, Mr. J. G. Bristow, Dr. Frank Clowes, Mr. Montague Ellis, Mr. W. E. Lawson Johnston, Mr. J. R. Leeson, Mr. T. B. Lightfoot, Mr. F. K. McClean, Mr. W. S. Norman, Mr. H. M. Ross, Mr. J. Shaw, Mr. T. H. Sowerby, and Sir Almoth Wright.

At the anniversary dinner of the Royal Academy of Arts, held on May 1, the president, Sir Aston Webb, in proposing the toast of "Science," remarked that to science and scientific research in medicine and surgery they were indebted for the marvellous record of freedom from disease and saving of life which was one of the most wonderful and gratifying chapters in the war. To the physicist and engineer were due much of the work done in connection with aircraft, tanks, submarines, and guns, the wonderful work done in sound-ranging for submarines, the location of aircraft and guns by sound; but it was impossible to give any list of all that was done, and still less the names of the men of science who thus helped their country in its time of urgent need. The president coupled the toast with the name of Sir Joseph Thomson, who, in replying, said that the qualities of mind

that were called into play by the artist were in many respects identical with those used by the man of science. Imagination and observation were vital to scientific discovery. The artist and the man of science were concerned with the same subject—the study of Nature under various aspects. While it was vital for the progress of this country that the application of science to industry should receive every encouragement and assistance, yet they ought not to neglect those who, forsaking the trade routes of the great liners, steered their little ships to uncharted seas to bring back to us the golden fleece.

SIR JAGADIS BOSE gave a very interesting lecture at the University of London Club on Thursday evening, April 29, on his well-known experiments on movements in plants. He has applied the methods of instrumental physics to the study of tropic plant movements, and, beginning with methods which magnified the growth one hundred times, has finally, with his high magnification crescograph, reached magnifications of more than ten million. This instrument uses the principle of a fine magnetised lever affecting a magnetic needle and so demonstrating growth by the movement of an attached mirror. By this method very delicate growth responses of the plant could be shown, and its relative sensitivity under different conditions compared. One of the lecturer's most general conclusions was that indirect stimulus causes an increase of growth, while direct stimulus of a plant organ causes a decrease of growth or contraction. In this way positive, negative, and neutral responses to gravitation or light on the part of any organ were explained as the result of various combinations of response to direct and indirect stimulus. Sir Jagadis Bose's crescograph is so remarkably sensitive that doubt was recently expressed as to the reality of its indications as regards plant growth; and the suggestion was made that the effects shown by it were due to physical changes. A demonstration at University College, London, on April 23, has, however, led Lord Rayleigh and Profs. Bayliss, V. H. Blackman, A. J. Clark, W. C. Clinton, and F. G. Donnan to state, in the *Times* of May 4: "We are satisfied that the growth of plant tissues is correctly recorded by this instrument and at a magnification of from one to ten million times." Sir W. H. Bragg and Prof. F. W. Oliver, who have seen similar demonstrations elsewhere, give like testimony that the crescograph shows actual response of living plant tissues to stimulus.

FURTHER news from Capt. Roald Amundsen confirms the belief expressed in NATURE of April 22 and 29 that he had not abandoned his North Polar journey. His object in calling at Nome, Alaska, in July is evidently to secure more supplies, add to his crew, and to receive mails. A long despatch published in the *Times* of May 1 gives some details of the fortunes of the expedition and explains the change in plans. The *Maud* left her winter quarters in the Nordenskjöld archipelago west of Cape Chelyuskin as late as September 12, 1919. It was necessary to blast a channel through about one and a half miles

of solid floe six to nine feet thick. Until the Taimir peninsula was cleared pack offered some obstruction, but to the eastward the sea proved to be fairly open. The lateness of the season was in Amundsen's favour in this part of his journey, and he was no doubt trusting to former accounts of open water in September. The *Maud* sailed east through Laptev Strait between the New Siberia Islands and the mainland and then turned north-east for Jeannette Island, but was stopped by tight pack in lat.  $73^{\circ}$  N. Amundsen made fast to the floes, intending to begin his drift, but on finding that the pack was nearing south he had to abandon his attempt. He decided to winter on the coast of Siberia, and after a passage rendered dangerous by ice and darkness reached Aion Island, Chaun Bay. One member of the expedition spent the winter with the Chukchee, who inhabit the interior of this part of north-eastern Siberia, in order to study their customs. Two men sent overland to the small trading village of Nizhne-Kolimsk with despatches for home turned back at Sukharnoe, a village at the mouth of the Kolima, with news that all communications with Europe were cut off. Amundsen hopes to reach Nome in July or August, and, if not too late in the season, to return north and enter the ice about Wrangel Island for his five years' drift.

WITH reference to the note in NATURE of April 15, p. 210, upon the laboratory of applied psychology connected with a well-known institute of mind-training, the director informs us that the fees charged are very considerably less than the cost of the tests performed or the scientific advice given, and that the laboratory is projecting the publication of research papers giving details of the work done, so that the world of science in general will be able to examine the methods adopted and the results obtained.

WITH the return to peace the increased cost of production has made it necessary to devise a new scheme for the publication of the "Victoria History of the Counties of England." Hitherto no order for fewer than ten volumes relating to a single county has been accepted, but it has been found by experience that there is a considerable demand for separate articles on special subjects. It has therefore been decided to issue the History, both that portion which has already been published and the remainder which is in preparation, in separate parts. Each part will include a single hundred, wapentake, or borough, and persons interested in the history, archaeology, or economics of a special area will be able to procure what they require within a single cover. The new arrangements seem well adapted to popularise a work which has already taken the rank of a standard authority on the subjects with which it deals.

SIR THOMAS MUIR, the well-known mathematician, and until lately Superintendent-General of Education in Cape Colony, has recently made a splendid gift to the South African Public Library, Cape Town. It consists of about 2500 books and pamphlets, collected by the donor in the course of many years, and it includes a number of serials, sets of which are now almost un-

procurable. As might be expected, there is an unusually complete group of works on determinants and allied topics. The gift is of special interest because it is made to a *public* library. Several of our college and university libraries have been enriched by similar donations (e.g. there is the Graves collection at University College, London). The time has come when we may hope that the reference departments of our rate-supported town libraries will be strengthened in a similar way. Of course, mathematics is not the only subject deserving attention; natural science, history, archaeology, economics, etc., all have a claim to be considered. Anyone who cares to examine the present record of public research libraries will be convinced that such gifts as that of Sir Thomas Muir are not likely to be wasted.

THE meeting of the Physical Society of London on March 26 took the form of a discussion on Einstein's theory of relativity. Prof. A. S. Eddington opened with an explanatory lecture. Prof. A. O. Rankine described experiments undertaken in collaboration with Dr. Silberstein on the influence of a gravitational field on the velocity of light polarised in a plane parallel to the field; the results of the experiment were in accord with the theory. Sir Joseph Larmor contributed a paper in the course of which he remarked that "the unresolvable essence of relativity appears to be that we cannot get on without *some foundation* to which phenomena are referred, and with respect to which they are ordered to the degree that is necessary for our reasonings." Reference was made also to the close relation between the theory and the fundamental principle of least action. That principle furnishes the most concise and elegant means of comprehending Einstein's theory. Here Helmholtz was a pioneer, not only in his grasp of physical principles, but also in his appreciation of the true nature of geometry. The searching question was asked: "How is it that astronomers since Newton's time have persisted in one special and very precise illusion about the distribution of gravitation, whereas really an unlimited choice is open?" Several speakers raised questions about the interpretation of the Michelson-Morley experiment, indicating that the explanations offered both by Lorentz and by Einstein still remain unconvincing to many physicists.

THERE are many chemists, and doubtless other scientific workers, who, busy with their everyday duties, have not been able to follow closely the progress made during the last few years in the study of atomic structure, and would welcome a connected survey of recent experiments and present views. Hence attention may be directed to an address by Prof. A. Berthoud on "The Structure of Atoms," a translation of which appears in the *Chemical News* of April 9 and 16. This gives, in simple language, a very readable account of the matter. It shows the connections which have been traced between the phenomena of radio-activity, isotopy, atomic numbers, Moseley's law, Bohr's theory, and the spectra of the elements; and it indicates to what extent the fundamental characters of atomic structure may now be

regarded as known, however much of detail may still be waiting for the sagacity of the investigator to fill in.

MESSRS. ILFORD, LTD., in issuing a second edition of their well-known booklet on "Panchromatism," have taken the opportunity of revising it and making some important additions. The largest of the new sections explains the nature of three-colour photography, in which is demonstrated the fact that in three-colour half-tone prints, granting the use of satisfactory inks, the result is the same whether the dots are side by side or superposed. The variability of so-called "white light" is treated of, the table of the multiplying factors of colour-filters is greatly extended, and a considerable number of new filters are described. The most novel and interesting of these last are the "photographic-vision" filters, which have transmissions that correspond with the sensitiveness of an orthochromatic or panchromatic plate, and therefore, when looked through, give the object or landscape the appearance that it will have when photographed on the plate that it matches. The effect of any colour-filter on the photograph is seen at once by putting the filter together with the "photographic-vision" filter in front of the eye. The price of the booklet is 6d., or post free 9d.

MESSRS. A. GALLENKAMP AND CO., LTD., have forwarded us a copy of their list (No. 72) of graduated instruments for volumetric analysis. These include burettes, pipettes, graduated cylinders, and various kinds of measuring flasks for use in the chemical and physical laboratory; we do not, however, notice pyknometers in the list. The instruments are made in three qualities, depending upon the degree of accuracy required. Those intended for research and special work (Grade A) are graduated according to the regulations laid down by the International Congress of 1909. Apparatus of the next quality (Grade B) is intended for specially accurate commercial analysis; and that in Grade C is suitable for ordinary technical determinations and general school-work. It is satisfactory to know that our makers of scientific glassware are endeavouring to meet the requirements of all users, including those of research workers. Whilst writing on this subject we may note that, from a report appearing in the *Journal of the Society of Glass Technologists* (December, 1919), there is a movement in Germany to restrict and standardise the shapes and sizes of glass vessels such as beakers, flasks, retorts, cylinders, and crystallising dishes in order to eliminate unnecessary diversity and facilitate replacement. The proposed standard dimensions are quoted at length.

MESSRS. H. K. LEWIS AND CO., LTD., 136 Gower Street, W.C.1, have just issued a list (dated April) of new books and new editions added to their medical and scientific circulating library during January, February, and March of the present year. Being very comprehensive and carefully classified, it should be useful to all who wish to keep abreast of current scientific literature. Copies can be obtained free of charge upon application to the publishers.

### Our Astronomical Column.

**THE LUNAR ECLIPSE.**—On the whole this eclipse was seen under favourable weather conditions, though for a time there was drifting cloud. The eclipsed portion was easily visible, being at first of a greenish tint, and later assuming the familiar coppery hue. Mr. A. Burnet had prepared a list of stars occulted during totality; they were few, and faint, and only one of these phenomena was observed at Greenwich. There will not be another total lunar eclipse visible in London with the moon at a considerable altitude until November 7, 1938, which is a much longer interval than usual.

**THE NATURE OF PHOTOGRAPHIC IMAGES.**—Dr. Kenneth Mees, director of the Research Institute of the Eastman Kodak Co., New York, gave an address at the meeting of the British Astronomical Association on April 28 on the nature of photographic images. Various points were raised that are of importance in the application of photography to astrophysics. Thus in the extra-focal determination of stellar magnitudes it was demonstrated that stars of different colours might have their magnitudes arranged in a different order, according to the exposures given and the developer employed.

Magnified sections of films were thrown on the screen, showing that with some developers the image of a luminous object caused an elevation of the film, but with other developers a depression. In either case the film in the neighbourhood suffers strain (sometimes to the point of cracking), so that images of faint stars near a bright one are subject to displacement. Prof. Turner noted some time ago an apparent displacement of a star near a *résseau* line which was probably due to this cause. It is possible to minimise the effect by a judicious choice of developer. The address contained many other hints of a practical nature; it will be published in the B.A.A. Journal for April. The Astronomer-Royal, proposing a vote of thanks, said that photography was the only way of obtaining information about the fainter stars in bulk. While some of the phenomena described by the lecturer were a little disquieting, the careful analysis of their origin and effects could not fail to be of great value.

**THE BINARY KRUEGER 60.**—This system is of particular interest as being one of our nearest neighbours, and since the *comes* has the smallest mass yet found for any star. *Astronomical Journal*, No. 767, contains researches on the parallax, proper motion, and orbit made at the Leander McCormick Observatory by S. A. Mitchell and C. P. Olivier. They find for the relative parallax  $0.266'' \pm 0.009''$ . Combining this with the determinations of Barnard, Schlesinger, and Russell, and adding  $0.005''$  as the estimated value for the comparison stars, the absolute value  $0.261'' \pm 0.006''$  results.

Their orbit makes the period nearly fifty years, a being  $2.68^d$ , or 10 astronomical units. Hence the combined mass is  $0.42$  in terms of the sun. The ratio of masses of the two components is still uncertain; three estimates are  $0.35$ ,  $0.53$ , and  $0.83$ . Taking it as  $0.5$ , the faint component is  $1/7$ th of the sun in mass, while it is only  $1/250$ th of it in luminosity. Prof. Eddington considered that the minimum mass necessary for the attainment of a stellar state may not be much below  $1/7$ th of the sun.

It is pointed out that the photographs of the close pair give as good results as visual measures, while for the distant optical component, observed for the purpose of deducing the relative masses, they are more accurate. Comparisons continued for another twenty-five years should give a satisfactory determination both of the orbit and the mass-ratio.

### Leonardo da Vinci.<sup>1</sup>

By EDWARD McCURDY.

AMONG the greater names in the history of Italian art some are found to be pivotal by reason of the influence of their work upon that of other artists. Giotto and Masaccio are the most conspicuous instances among the earlier masters. Giotto created the scientific basis of the naturalism of the art of the Renaissance by contrast with the decorative symbolism of the earlier art of Byzantium. Masaccio reinforced these tenets with noteworthy access of realism in the frescoes in the Church of the Carmine in Florence. The names of Antonio Pollaiuolo and Andrea Verrocchio serve to indicate how in Florentine art of the Quattrocento the study of structure gained new scientific precision from anatomical research. Piero de' Franceschi reveals a deeper knowledge of the various problems of perspective, arrangement, and light and shade in his works at Arezzo than was possessed by any of his contemporaries, but the influence which his work would naturally exert was restricted by reason of its remoteness from the greater centres of art training.

The divergent aims of this small band, who may be termed the upholders of the scientific tradition in Italian art, are realised with singular completeness in the work of Leonardo da Vinci. Born in the year 1452, the illegitimate son of a Florentine notary, descended from a long line of Florentine notaries, having shown, according to Vasari, marvellous talent as a boy in the art of design, he was placed by his father in the studio of Andrea Verrocchio, who is described by the same writer as at once goldsmith, master of perspective, sculptor, inlayer of woods, painter, and musician. It was apparently a sort of clearing-house for ideas for the art world of Florence, and there Leonardo became acquainted with Botticelli and Perugino. His apprenticeship had ceased in 1472, for in that year his name occurs in the Red Book of the Guild of Painters of Florence.

In the year 1483 Leonardo, being then in his thirty-second year, left Florence and went to Milan, where he entered the service of Ludovic Sforza. Making all possible allowance for what may have been lost, the sum total of his work in art up to this time is astonishingly small as covering the period from his apprenticeship to his thirty-second year. Already in his few pictures the detailed treatment of the herbage, the gradation of the light, the presentment of muscle and tendon, all reveal the scientific study of the laws which defined their structure. The inference is irresistible that while still at Florence he had commenced those studies of natural and applied science the rumour of which, superimposed upon the fame of his artistic work, caused his name to be endowed among his contemporaries with a half-legendary universality. Some of the forms of this nascent activity are enumerated by Vasari. I quote from the translation by Mr. Herbert Horne:—

"In architecture he made many drawings, both of plans as of other projections of buildings; and he was the first, although a mere youth, that put forward the project of reducing the River Arno to a navigable channel from Pisa to Florence. He made designs for flour-mills, fulling-mills, and machines which might be driven by the force of water. . . .

"And he was for ever making models and designs to enable men to remove mountains with facility, and to bore them in order to pass from one level to another; and by means of levers, and cranes, and screws he showed how great weights could be lifted and drawn; together with methods of emptying

<sup>1</sup> From a discourse delivered at the Royal Institution on Friday, March 19.

harbours and pumps for drawing up water from low places, all which his brain never ceased from inventing."

In the famous draft of a letter to Ludovic Sforza, in the Codice Atlantico, written presumably immediately on his arrival in Milan, Leonardo offers his services in the capacity of military or naval engineer, detailing the various inventions of which he possesses the secret, and offering to make trial of any, either in the ducal park or in whatsoever place might please his Excellency, in case any of the said inventions should seem to be impossible. If natural incredulity, which the writer of the letter apparently expected to meet with, by reason of the scope and variety of the inventions, which comprise pontoons, scaling-ladders, cannon or bombards, mines, covered chariots, catapults, mangonels, and smoke-powders, should dispose any to look on the list merely as a piece ofrodomontade, it may be observed that the contents of Leonardo's manuscripts at Paris and Milan fully substantiate every claim contained in the letter.

The position which Leonardo desired to occupy under Ludovic Sforza was not very unlike that of military engineer and inspector of fortresses which he occupied at a later period in the service of Cæsar Borgia.

The concluding paragraphs of the letter to Ludovic Sforza refer to Leonardo's readiness to be employed in the arts of peace—in architecture as a designer of both public and private buildings, in the construction of watercourses, in painting, and in sculpture, whether of marble, bronze, or clay, and especially in the execution of the equestrian statue of Francesco Sforza, upon which he laboured intermittently for sixteen years. The extent and fervency of the researches that he considered necessary, which comprised studies of various antique equestrian statues, and numerous notes on the proportions of particular horses, as well as a treatise on the anatomy of the horse, were such that the very desire of perfection prevented the execution of the work. As Vasari says, quoting Petrarch's line: "L'opera fosse ritardata dal desio." The monk, Sabba da Castiglione, who was present when the French entered Milan in 1499, records the fact of the destruction of the clay model under the arrows of the Gascon bowmen. The statue ranked with Donatello's Gattamelata at Padua and Verrocchio's Bartolommeo Colleone at Venice as one of the three great examples of equestrian statues of the Italian Renaissance. So far as it is possible to form an opinion from the very numerous studies in the Royal Collection at Windsor, it would seem to have been in advance of both the others in freedom and vigour of movement. The sequence of studies shows a change of purpose from the attitude of the horse galloping to that of it walking. Leonardo says in a note in one of his manuscripts, "The trot is almost the nature of the free horse."

Few paintings are now in existence the execution of which can be connected with Leonardo's first period of residence in Milan. The most important of these is the haunting ruin of the Last Supper. The paucity of the list, even allowing for the inevitable mischances of time, confirms the testimony of Sabba da Castiglione, who says that, besides the Last Supper, few other works in painting by Leonardo were to be seen at Milan in the middle of the sixteenth century, "because when he ought to have attended to painting, in which without doubt he would have proved a new Apelles, he gave himself entirely to geometry, architecture, and anatomy."

The external history of his life is sharply divided by circumstances into three periods. First the early years at Florence. Then his life at Milan under

Ludovic Sforza. The third period was that of the Odyssey of wanderings commenced on his leaving Milan with Fra Luca Paciolo two months after the flight of Ludovic Sforza, and extended for the remaining twenty years of his life.

At Venice, as Leonardo's manuscripts show, he studied the tides of the Adriatic, and apparently prepared a scheme for flooding part of the Veneto in order to stem the Turkish invasion, and also an apparatus by which it would be possible to approach the Turkish galleys under water. A note in the Codice Atlantico tells of his hurried departure from Florence to travel in the Romagna as architect and military engineer in the service of Cæsar Borgia. His manuscripts refer to works planned at Urbino, Cesena, and Porto Cesenatico. But the office ended with the rebellion of the Duchy, and in March, 1503, Leonardo was once more back in Florence. There he was employed to divert the channel of the Arno, in connection with the war with Pisa. He painted at this time the portrait of Madonna Lisa del Giocondo, the world-famous Mona Lisa, and also the cartoon for the Battle of Anghiari. His work on this composition was interrupted by an invitation to Milan, and this led to his entering the service of the French. Louis XII. refers to him in a letter to the Signoria as "our painter and engineer in ordinary." He consulted him as to the conduit in the garden of the Château of Blois, and employed him on hydraulic work in Lombardy. It was probably in May, 1509, when Louis XII. made a triumphal entry into Milan after the victory of Agnadello, that Leonardo constructed as part of the pageant an automatic lion which walked a few paces and then, opening its breast, revealed it full of lilies. There was much study of anatomy with Marc Antonio della Torre at this period, and his intercourse with French artists is shown by a note to inquire from Jean de Paris the method of painting in tempera, but he did not engage in any great artistic work.

In the year 1512 the French lost Milan, and after the re-entry of the Sforzas, in the person of the young Maximilian, there is no record of Leonardo's further employment. On September 24 in the following year he set out from Milan to Rome with his assistants, and was there lodged in the Belvedere of the Vatican. According to Vasari, the Pope gave him a commission, and then was indignant because he began by experimenting with the varnish. The practice of painting, however, had no more than a secondary interest for him. His manuscripts reveal him as engaged in studies in optics, acoustics, and geometry, studying geology in the Campagna, improving the method of coining at the Mint at Rome, busy with engineering work at Civitá Vecchia, and in studying anatomy at the hospital, for which last-named pursuit he was denounced to the Pope by one of his apprentices. He seems to have gone with the Papal army to Bologna, where in December, 1515, the Concordat was held between the Pope and Francis I., and a month later he accompanied the king on his return to France with the office of "his painter and engineer," being given as a residence the Château of Cloux, near Amboise, where he died on May 2, 1519.

A record of a visit paid to him at Cloux by the Cardinal of Aragon on October 10, 1517, makes special mention of the anatomical drawings, and the diarist states that Leonardo told the visitors that in preparation for these he had dissected more than thirty bodies. They saw also his treatise on the nature of water, and others on various machines, there being, as it appeared, "an endless number of volumes, all in the vulgar tongue, which if they be published will be profitable and very delectable."

The activities of Leonardo's mind fall naturally into



such as found expression, either mainly or in part, in constructive work and those revealed only in his writings. The first category comprises painting, sculpture, architecture, and engineering. In painting it is enough to instance the fresco of the Last Supper and the portrait of Mona Lisa, each of its type unique among all works of the Renaissance, and beyond all power to appraise in its union of technical mastery and the inevitability of supreme art. In sculpture the Sforza statue, the master-work of his Milanese years, lives only in the drawings which furnish some faint index of its power. In architecture there is no outstanding memorial.

Sir Theodore Cook, in his elaborate study of spiral forms entitled "The Curves of Life," has collected a remarkable array of evidence in favour of attributing to Leonardo the design for the open spiral staircase in the Château of Blois. The documentary evidence is missing, but the date of construction is known to have been between the years 1516 and 1519, and Leonardo was then living a few miles distant in the manor-house of Cloux, near Amboise. A spiral staircase occurs in one of Leonardo's drawings for a fortified tower, and he made many studies of spiral formations occurring in Nature, in shells, in smoke, and in the eddies of water. The staircase at Blois is apparently modelled on *Voluta vesperilio*, a shell common on the coast of northern Italy. The theory has obvious attractions. It supplies an example of a work in architecture emanating from the brain of Leonardo, and this a work of supreme distinction.

Records of his activity as an engineer are concerned with schemes of canalisation in Florence, in connection with the diversion of the Arno from Pisa as a war measure; and in Friuli, in similar circumstances, he devised movable sluices in order to prevent the advance of the Turks across the Isonzo. He made canals in Lombardy for purposes of irrigation, and also aqueducts to improve the water-supply of Milan; and the canal of Romorantin, for which he made plans when in France, was intended to connect the waters of the Loire and the Saône.

The potential list of Leonardo's activities in the construction of instruments of warfare figures in the letter to Ludovic Sforza. He says there: "I can make armoured wagons safe and immune from attack which will open up a passage through the enemy with their artillery, and, however great the multitude of the enemy may be, they will be able to break through. And behind them the infantry will be able to follow quite unhurt and without hindrance."

This armoured wagon is seen ready for action in a drawing in the British Museum. It is moved on wheels, and a sketch of the lower half shows the internal machinery, but it is not possible to discern the nature of the motive power. The use of the armoured wagon in order to open up a passage through the enemy, as described above, is identical with that of the tank in the late war. The manuscripts reveal a strangely prophetic insight in regard to two other developments of recent warfare, namely, poison gas and submarining.

Leonardo contemplated the use of poisonous gas or powders in naval warfare for the purpose of suffocating the enemy, and told how to make a simple preventive mask. He also contemplated the contingency—as happened on occasions in Flanders—of an adverse wind causing the poison to recoil upon the users. The passage, which occurs in MS. B of the Paris manuscripts, is entitled "How to throw poison in the form of powder upon ships."

"By means of catapults," he says, "a mixture of powdered quicklime, arsenic, and verdigris may be

thrown upon the ships of the enemy, and all who inhale the powder will die.

"But take care that the wind is favourable, lest it blow the powder back upon you, and be sure you have a fine piece of damp cloth to cover the nose and mouth in order that the powder may not enter."

In the Leicester manuscript (folio 22b) he foretells the horrors of submarine warfare, and refuses to impart any information as to the machine which he has constructed lest it should serve to bring them about:

"How by means of a certain machine many people may stay some time under water. How and why I do not describe my method of remaining under water, or how long I can remain without eating; and I do not publish or divulge this because of the evil nature of men who would use them as means of destruction at the bottom of the sea by smashing the ships in the keel and sinking them together with the men in them. But I will impart others which are not dangerous, because the mouth of the tube by which you breathe appears above the water supported on leather bottles or corks."

In connection with this passage reference may be made to one in MS. B of the Paris manuscripts entitled "A Way of Escaping in a Tempest or Shipwreck at Sea," in which Leonardo tells how to construct a coat of leather of double thickness which will be capable of being inflated when necessary, and thus of serving as a life-saving jacket in case of emergency.

Senatore Luca Beltrami associates the former of these passages with the Turkish war. Leonardo, as a reference to his manuscript shows, had been employed in the construction of a movable dam which should enable the line of the Isonzo to be flooded in the defence of the Veneto against the Turkish invasion. The reference is to the construction of submarine boats in order to sink the Turkish galleys in the Gulf of Venice "by smashing the ships in the keel and sinking them together with the men in them." Leonardo considers this to be justifiable, because it is an act of defence "for the safety of our Italian lands" ("delli nostre parti italiane"); but he will not give any details of the construction of his submarine craft in which it would be possible to remain under water for four hours, because he is fearful of the evil use to which it might be put in future times.

(To be continued.)

### Public Support of Scientific Research.

ON Wednesday, April 28, a public meeting was held at Birkbeck College to hear an address from Prof. F. Soddy on "The Public Support of Scientific Research." Mr. H. G. Wells, who took the chair, claimed that everything in which the world of to-day differed from that of years ago was due to science and the scientific worker. Prof. Soddy expressed his regret that the greater encouragement of scientific research during the war had not resulted in any appreciable improvement in the position of pure science, which was the tree of which applied—industrial and trade—science were the fruits. He deprecated the exploitation of science by financiers and commercial men and its employment to increase the indebtedness to them of those who had done the creative work of the world. The scheme framed by the Government to foster scientific research endeavoured to place the man of science who was to do the work under the same type of men—often the same men—as had thwarted progress in the past. The change from gross inefficiency in the medical

services in the Boer War to singular efficiency in the late war was due to change in the status of the Army medical officers and to their liberation from the misdirection of unqualified superiors. This was possible only because of the great strength of the professional union of medical men. A similar strong professional union comprising every qualified man of science was necessary before science ceased to be misdirected and used to the hurt rather than to the good of the community.

Not a single chemist was included in the directorate of the national scheme for the manufacture of British dyes when it was announced, although the taxpayer contributed 2,000,000*l.*, a portion of which was to be expended in research. The cause of the success of the German industry was that it was under scientific direction from end to end. Prof. Soddy complained that the benefaction of Mr. Carnegie to foster scientific study and research at the Scottish universities had been diverted to the general maintenance of the universities. At one time none of the trustees were men of science, and the secretary was now the administrative chairman of the Government Department of Scientific and Industrial Research. That Department allocated a million to industrial research associations in the form of a capital grant, over which Parliament was powerless, whereas researches in the fields of pure science, from which directly flowed all the useful applications, were put on the yearly Parliamentary Estimates. The research associations were becoming water-tight concerns to eliminate competitors, and the interests neither of the public nor of the scientific worker were protected. Representatives both of trained scientific workers and of organised labour should be included in the councils and executive committees of the research associations. At the same time, Prof. Soddy urged that representatives of democratically constituted associations of scientific workers should be placed on the Council of the Department, of which it should be the governing body. He declared his belief that co-operation would replace competition; but this co-operation depended upon a dominance of individuals of intellect and knowledge—not over men, but over Nature; for the struggle of man against Nature was, in the first instance, a duel fought by lonely men in the furthest outposts of knowledge, finding a path where all before had turned back beaten and befogged.

In the discussion which followed Sir William Bragg urged that as science slowly established its position and men of science reached a condition of greater equity, responsibility came with it, and they must work and learn to handle greater and greater things, so that they might take their part in everything that was done in the State. He expressed his appreciation of the assistance he had received from the Department of Scientific and Industrial Research.

### American Agricultural Research.

RECENT numbers of the *Journal of Agricultural Research* (vol. xviii., Nos. 7 and 8) contain several articles dealing with plant physiology and with insect pests. Plants grown in water-culture are not able to withstand such high concentrations of nutrient salts without showing toxic effects as are plants grown in sand or soil. In the latter case the presence of solid particles, which cause a considerable amount of absorption, has much to do with this reduction of toxicity, but J. A. Le Clerc and J. F. Breazeale have shown that the effect is also partly due to certain soluble substances which are sometimes present

in very small quantities. Traces of calcium oxide and calcium sulphate do much to overcome the toxicity of sodium chloride and sodium sulphate, but the various other salts tested had no ameliorating action. The lime, however, does not seem to prevent the entrance of the sodium chloride or sulphate into the plant-cells, and therefore its antagonistic action would appear to be due to some undetermined cause rather than to its effect upon the permeability of the cells.

The question of the physiological balance of the salts necessary for plant nutrition is many-sided, and J. W. Shive approaches it from the point of view of the relation of the moisture in solid substrata to the physiological salt-balance and to the relative plant-producing value of various salt proportions. Under his experimental conditions the physiological value of salt solutions was not affected by the degree of moisture present, and that which was best with the lowest moisture-content was also the best with the medium and the highest degrees of moisture. Nevertheless, an optimum moisture-content is necessary to produce maximum growth, and the actual plant-producing value of any fertiliser treatment is largely determined by the moisture conditions of the substratum.

It is customary to subject cereal seeds to treatment by hot water or various chemicals in order to control plant diseases when their presence on the seed is known or suspected. Such treatments are not effective in every case, as measures that are sufficiently drastic to cut out the disease often result in destroying the viability of the seed. D. Atanasoff and A. G. Johnson find that these difficulties may be largely overcome by the use of dry heat for disinfection, as such cereals as barley, wheat, rye, and oats are able to withstand protracted exposures to dry heat at comparatively high temperatures, especially if the seed is of good quality and well dried. The method has proved successful in the elimination of seed infection from bacterial blight of barley (*Bacterium translucens*) and bacterial blight of oats (*Pseudonoma avenae*), and a number of seed-borne fungus diseases, such as wheat-scab, spot-blotch of barley, stripe disease, and smut, are either practically eliminated or much reduced. The dry heat treatment seems to offer possibilities which should be followed up.

Natural enemies must be regarded as a great asset in the control of insect pests, but the value of fungal parasites in this respect is often overlooked. A. T. Speare describes experiments on *Sorosorella uvella*, an entomogenous fungus which attacks Noctuid larvae, and is recorded for the first time in America. The practical interest of the investigation lies in the fact that quite a number of Noctuid larvae, including such pests as cutworms, have proved to be susceptible to the disease, and other Lepidopterous larvae can also be infected by special methods. The disease caused by the organism is readily transmitted to healthy insects, and in laboratory experiments a mortality of from 60 to 90 per cent. may be obtained. Control by means of parasitism has proved of great value in reducing the Mediterranean fruit-fly in Hawaii. Four larval parasites of this pest have been introduced and established since 1913, and their value as destroyers increased until in 1918 they caused the destruction of considerably more than half of all the fruit-flies developing in fruits about Honolulu (H. F. Willard).

The ravages of the broad-bean weevil (*Bruchus rufimanus*, Boh) in California have led to the abandonment of a considerable acreage, especially since weevil-infested beans have been classed as adulterated food. R. E. Campbell (Bull. 807, Professional Paper, U.S.A. Dept. Agric.) gives an account of the distribution and life-history of the pest and discusses various measures of control. The only practicable means is to plant seed which contains no live weevils,

as the application of poisons or deterrents in the field is useless. Dry heat is unsatisfactory, as temperatures that destroy the weevils kill the seeds also; sulphur is unsuccessful, but fumigation of well-matured and dry seeds with carbon bisulphide gives good results. Damp seeds should not be treated. Contrary to expectation, it was found that fumigating while the insects were in the larval stage was less effective than if done in the adult stage, as the gas cannot penetrate into the interior of the bean to the partly grown larvæ as easily as it can reach the full-grown larvæ, pupæ, or adults directly under the seed-coat.

W. E. B.

**Canadian Water-Power Development.**

**A**N interesting article in the *Engineer* of April 9 by Mr. Leo. G. Dennis, Hydro-electric Engineer of the Canadian Commission of Conservation, reviews the situation in regard to Canadian water-power development. From it we have gathered the following particulars indicating the remarkable growth since the commencement of the century.

In 1900 less than 200,000 h.p. was utilised, as compared with 2,383,240 h.p. now available, according to the most recent returns, subdivided as follows:—

Province.	Horse-power.
Ontario ... ..	1,000,000
Quebec ... ..	900,000
British Columbia ... ..	310,000
Manitoba ... ..	78,600
Alberta ... ..	32,500
Nova Scotia ... ..	30,000
New Brunswick ... ..	17,000
Yukon ... ..	13,400
Prince Edward Island ... ..	1,700
Saskatchewan ... ..	40

Of the total electric central station installation of 2,107,743 h.p., no less than 1,806,618 h.p., or more than 85 per cent., is in hydro-electric stations, and these are remarkable for their large size. Forty per cent. is in plants of 100,000 h.p. and more, and another 42 per cent. in plants between 10,000 and 100,000 h.p. Particularly worthy of note are two large hydro-electric systems in Eastern Canada. The Niagara system is supplied mainly from plant of 211,300 h.p., and transmits to some 150 municipal distribution centres. The Shawinigan system is fed from plants with a total capacity of 270,000 h.p., and, directly or indirectly, supplies some 85 distributing systems.

Water-power is an important factor in many Canadian industries, but in none so essentially as in the case of pulp and paper manufacture. Of a total of 525,000 h.p. installed for this purpose, at least 475,000 h.p. is derived from hydraulic sources. From an economic point of view it is probable that if water-power had not been available, pulp in many cases could not be manufactured at all.

Canada's potential water-power resources are placed by recent estimates at 18,832,000 h.p., subdivided provincially as follows:

Province.	Horse-power.
Quebec ... ..	6,000,000
Ontario ... ..	5,800,000
British Columbia ... ..	3,000,000
Manitoba ... ..	2,797,000
Alberta ... ..	462,000
New Brunswick ... ..	300,000
Saskatchewan ... ..	220,000
Nova Scotia ... ..	100,000
Yukon ... ..	100,000
North-West Territories ... ..	50,000
Prince Edward Island ... ..	3,000

NO. 2636, VOL. 105]

In Ontario, the Niagara and St. Lawrence powers are the outstanding features, although the figures in regard to the former have been at times exaggerated. Bearing in mind that it is an international source, the theoretical total available for Canada is about 2,300,000 h.p. But only about one-third of that quantity is at present available for exploitation. The large power plants installed below the Falls have not so far utilised the descent in the river below the cataract, but this mistake is not being repeated by the Chippawa-Queenston project, which will add 200,000 h.p. to the total installation. It will embrace the maximum possible head of 316 ft. The St. Lawrence powers are also partly international, and are estimated as follows:

Province or State.	Available low-water horse-power.
Ontario ... ..	387,500
New York ... ..	387,500
Quebec ... ..	1,375,000
	2,150,000

Besides its share of the St. Lawrence and Ottawa River powers, Quebec has other important possibilities, notably on the St. Maurice River and in the Sagaway basin. The present capacity of plants at Shawinigan and Grand'mère in the Upper St. Maurice is 330,000 h.p., and there is expectation of this figure being doubled at no distant date.

**The Solar Eclipse of May, 1919.**

**P**ROF. L. A. BAUER contributes an article on this eclipse to a recent issue of *Science*. He notes the new interest which eclipses have recently acquired, first from their effect on terrestrial magnetism, and secondly from the gravitational deflection of light. The Carnegie Institution of Washington sent two parties to stations inside the zone of totality; Prof. Bauer himself occupied Cape Palmas, Liberia, while Messrs. Wise and Thomson went to Sobral, Brazil. There were three other stations outside the zone, and most of the magnetic observatories co-operated in a scheme of observations. The detailed results are not yet available.

Cape Palmas has a bad weather record, but this was of little importance for the magnetic work. The sun was very high, and the duration of totality, 6m. 33s., was probably the longest that a scientific party has ever enjoyed. As it turned out, the sky was clear, and small-scale photographs of the corona were secured. These were, however, subsidiary to the main work, of which Prof. Bauer says: "There were clear indications of a magnetic effect. . . . As the station was nearly on the magnetic equator, the effect was specially noticeable . . . upon the magnetic dip." He notes that the darkness was not nearly so great as at the much shorter eclipse of 1918, perhaps owing to the greater brightness of the corona. The fall of temperature was nearly 3° F., the minimum being some twenty-four minutes after totality; the maximum of humidity synchronised with this minimum. Shadow bands were not seen here, but they were observed at Sobral by Mr. Thomson.

Dr. Abbot and Mr. Moore observed the eclipse from La Paz, Bolivia, where the sun's altitude was only 5°, but their altitude of 14,000 ft. compensated for this. "Taking into account the great length and beauty of the coronal streamers, the splendid crimson prominence . . . the snow-covered mountains as a background, it seemed to the observers the grandest eclipse that they had seen." Besides photographing the corona, their special work was the measurement

of sky and solar radiation at different stages of the eclipse. Curves of these are given, which indicate that the sky radiation varies proportionally to the amount of sunlight.

Prof. Bauer then discusses the British expeditions and the observed deflection of light. As these have already been dealt with in *NATURE* (November 13, 1919, and elsewhere), it will suffice to mention one point. After noting that the Sobral results indicated larger deflection than those deduced from Einstein's law, and that the excess was greater in R.A. than in declination, Prof. Bauer made the suggestion that the excess might arise from the passage of the light through a rare outer atmosphere of the sun, which, like the corona, might be more extended in the equatorial regions. The residuals are too small to lay very much stress on this, unless future eclipses should indicate the same effect.

### The Manufacture of Synthetic Ammonia and Production of Nitrates.

THE Ministry of Munitions announces that Lord Inverforth has arranged for the sale of H.M. Nitrate Factory at Billingham-on-Tees to Messrs. Brunner, Mond, and Co., Ltd. The purchasers will form a company to take over the factory, and will be responsible for all outstanding liabilities of the Ministry in connection with the project. This factory, the erection of which was commenced early in 1918 by the Department of Explosives Supply, was designed for the manufacture of synthetic ammonia and for the production of 60,000 to 70,000 tons of ammonium nitrate annually.

Soon after the appointment of the Nitrogen Products Committee, the monumental report of which was published in January last, the Government decided to install one or other of the processes for the fixation of nitrogen. The Committee, after thorough investigation of the problem, recommended the cyanamide process as the one best suited for this purpose in the circumstances, since the working details were well understood. This advice was at first adopted, and a contract was on the point of being negotiated, but, for reasons which are not stated, the recommendation was not acted upon.

During 1916 the Nitrogen Products Committee had established a laboratory in premises placed at its disposal in the new Ramsay building of University College, London, and the Committee's research staff, under the direction of Dr. J. A. Harker, was engaged in an experimental investigation of a number of problems relating to nitrogen fixation. Although it was not anticipated that there would be any shortage of supplies of ammonia, yet it was deemed desirable, in view of the special suitability of the synthetic ammonia process for the needs of this country, that an experimental study of it should be made forthwith, so that the required information should be available if necessary.

After a year's experimental work, the progress made was considered so encouraging that the Committee decided to establish a moderate-sized technical trial unit, and funds for the purpose were allocated by the Treasury. It was hoped, by means of this plant, that a study of the chemical engineering problems could follow upon that already made of the pure chemistry of the reactions involved, but the Committee did not suggest the establishment of the process as a war measure upon an industrial scale. In 1917, however, the Explosives Supply Department considered that the position reached in the experiments justified it in recommending the erection of a large works, in substitution for the Committee's cyanamide project, and

a site at Billingham, some 260 acres in extent, was ultimately chosen for this purpose. But a number of difficulties supervened, and construction was slow, and at the time of the Armistice only a few permanent buildings and a number of temporary structures had been erected, though a large amount of plant had been ordered.

The purchasers of the factory now undertake to complete the scheme by providing the additional buildings and plant required for the synthesis of ammonia and its oxidation to nitric acid and nitrates suitable for the manufacture of explosives and fertilisers.

It is understood that the company has acquired a large amount of additional land and that it intends to develop the project on a very large scale. The factory has been re-designed on a peace as distinct from its former war basis, and in many particulars the new plant will represent a substantial advance, both in the ammonia and nitric acid sections, on anything previously used in Germany.

### New Ordnance Survey Maps.

THE new edition of the one-inch and quarter-inch Ordnance Survey maps is described, with specimen sheets, by Lt.-Col. W. J. Johnston in the *Geographical Journal* for March (vol. lv., No. 3). Three types of one-inch map are to be published: the popular, the district tourist, and the outline. The popular edition has contours in orange at 50-ft. vertical interval in place of the 100-ft. and 250-ft. interval on the former one-inch maps. A new classification of roads, which divides them into ten categories, makes the main roads, coloured red, stand out prominently. Rivers and streams are shown in solid blue. Parish boundaries, which caused much confusion with foot-paths, are omitted, but county boundaries are retained. Woods are coloured green. The outline edition is the present one-inch map, which in future will be printed from stone on stout paper. The tourist edition entails a combination of sheets to cover conveniently in one map certain areas frequented by holiday-makers. It is hoped to have at least eight of the tourist sheets ready before the summer. The contours are at 100-ft. and 250-ft. intervals, and the representation of relief is made more striking by the use of hachures and transparent colour layers; rivers are in solid blue and woods in green. The black printing will be the same as in the popular edition. The quarter-inch map is being issued with contours and layer colours in place of hill shading, red colour for main roads only, solid blue for streams, and no green wood symbol. The sample sections of the popular one-inch and the quarter-inch maps accompanying Col. Johnston's paper are beautiful specimens of cartography, and a great improvement on the old editions, good as they were. The tourist one-inch will be useful mainly by reason of the combination of sheets which it offers. We understand that arrangements have been made to popularise these maps by having them on sale at all booksellers' and bookstalls.

### University and Educational Intelligence.

CAMBRIDGE.—Gifts totalling 1500l. are announced towards the partially endowed Hopkinson professorship in thermodynamics.

The Linacre lecture will be delivered to-day, May 6, by Dr. Henry Head on "Aphasia and Kindred Disorders of the Speech."

In connection with the installation of the Chancellor, it is proposed to present honorary degrees to the Prime Minister, Mr. Bonar Law, and several other prominent politicians. The following are amongst those selected for honorary degrees on the same occasion: Sir Joseph

Thomson, Sir Joseph Larmor, Sir J. G. Frazer, Prof. James Ward, Mr. C. M. Doughty, and Prof. Bergson. The Sheephanks exhibition in astronomy has been awarded to E. S. Pearson, scholar of Trinity College. The first examination for the diploma in medical radiology and electrology will be held on July 27 next.

Mr. H. Hamshaw Thomas has been re-appointed curator of the Botanical Museum.

LONDON.—A course of eight lectures on "Nutrition," by Prof. E. Mellanby, at King's College for Women, Campden Hill Road, Kensington, W.8, was begun on Monday, May 3, and will be continued at 5 p.m. on Mondays and Tuesdays, May 10, 11, 17, 18, and 31 and June 1. Another course of eight lectures on "The Biochemistry of Sterols" will be given by Mr. J. A. Gardner in the Physiological Laboratory of the University, South Kensington, S.W.7, at 5 p.m., on Tuesdays, May 18 and 25, June 1, 8, 15, 22, and 29, and July 6. The lectures are addressed to advanced students of the University and to others interested in the subject. Admission is free, without ticket.

At University College, on Wednesday next, May 12, at 5.30, Dr. Charles Singer will deliver a public inaugural lecture, as lecturer in the history of medicine, on "Greek Science and Modern Science: A Comparison and a Contrast." The chair will be taken by Sir Robert Hadfield, Bart.

OXFORD.—On May 4 Convocation passed a decree gratefully accepting the offer of Mr. Edward Whitley, of Trinity College; of a sum of 10,000*l.* towards the endowment of a professorship of biochemistry, and providing that the first appointment of a professor shall be made by Mr. Whitley, subject to the approval of the Vice-Chancellor and the professors of medicine, physiology, chemistry, and pharmacology.

By another decree Convocation expressed its thanks to the British Dyestuffs Corporation for its munificent donation of 5000*l.* towards the cost of extending the organic chemical laboratory.

These gifts to the University are most timely and welcome. The opportunity thus afforded for the study of the important subject of biochemistry in the University is likely to have far-reaching results; while increased accommodation for the department of organic chemistry has for some time past been urgently needed.

The chairman and directors of the Cunard Steamship Company have decided to contribute 10,000*l.* to the appeal fund of the University of Liverpool.

THE HON. SIR CHARLES A. SMITH, for many years Controller and Auditor-General of Cape Colony, who died a year ago, bequeathed 15,000*l.* to the Master and fellows of St. Peter's (Peterhouse) College, Cambridge, "for the advancement of education and learning, the fund to be associated with his name."

We are glad to learn that the appeal of the College of Technology, Manchester, for 150,000*l.* for the extension of its buildings is meeting with a satisfactory response. The total amount subscribed for the extension of university education in Manchester includes the subscriptions to this fund as well as the 175,000*l.* or thereabouts subscribed in response to the appeal for 500,000*l.* for faculties other than technology.

NOTICE is given by the University of Bristol of the impending award of the Vincent Stuckey Lean scholarship in botany. The scholarship, value 36*l.* and tenable for one year, is open to graduates of any university on the understanding that the successful candidate undertakes research work in botany in the University. Applications must be made on or before May 22 to the registrar of the University of Bristol.

NO. 2636, VOL. 105]

WHEN the University of Bristol was established in 1909 the city possessed one of the best-equipped engineering faculties in the United Kingdom; but since then great improvements have taken place in many other universities, and the time has come when, in order to hold its own, the Bristol engineering faculty needs further equipment. The Merchant Venturers, in whose college the faculty is provided and maintained, have decided, therefore, to undertake considerable extensions. The total cost of the alterations and additions will amount to about 11,000*l.*, and it is hoped that a considerable part of the extensions will be available for use during next session, when the number of advanced students in the faculty will be very greatly increased. Last term there were 1340 students in the faculty of engineering—271 in the daytime and 1069 in the evening.

THE scientific and efficient use of steel and other metals, both in mechanical and structural engineering, depends on the collaboration of the metallurgist and the engineer. The examination of metals under a microscope is, perhaps, a matter for the metallurgist rather than the engineer, but this branch of testing of materials has now become of such importance that it is essential that the engineer should be able to follow the methods employed and to judge something of the properties of a material from photomicrographs. Most engineers have some detailed knowledge of the mechanical tests which should be carried out before a particular material is used in construction, but there are large numbers who are not in touch with modern work on metallography. We have pleasure, therefore, in directing attention to six lectures on "Metallography for Engineers," by Dr. W. Rosenhain, which have been arranged to be given at King's College, Strand, W.C.2, on Thursdays at 6 o'clock, commencing on Thursday, May 13. The lectures form part of the post-graduate work of the engineering department of the college. They are, however, open to all students and engineers. The post-graduate courses for engineers at King's College deserve to be widely known. During this session the lectures have included courses on "Metrology and Engineering Standardisation," by Mr. J. E. Sears; "Central Station Practice," by Mr. C. H. Wordingham; and "Irrigation," by Mr. N. F. Mackenzie. Arrangements have already been made for similar courses next session, and full particulars of these can be obtained from the secretary of the college.

## Societies and Academies.

LONDON.

Royal Society, April 22.—Sir J. J. Thomson, president, in the chair.—H. W. Hilliar: Experiments on the pressure-wave thrown out by submarine explosions. A method is described for determining the time-pressure curve at a given point in water in the neighbourhood of an exploded charge. The method depends, in principle, on measuring the growing velocity of a short steel piston exposed at one end to pressure in water. This method was applied in a comprehensive deep-water investigation of pressure-waves springing from a great variety of charges. Comparisons were made between various kinds of explosive, including gunpowder, which gives results remarkably different from those yielded by high-explosives. The general behaviour of the pressure-wave was found to approximate closely to that of a sound-wave. Its velocity was measured directly and found not to differ sensibly from that of sound in sea-water (4900 ft. sec.). The pressure falls off in

approximately simple proportion to distance from the charge. The influence which the water surface exercises on pressure at a given point can be accounted for by supposing that the pressure-wave is reflected from the surface as a tension-wave. The first part of the pressure-wave arrives at the point in question entirely unaffected by proximity of surface; but after a certain interval, determined by the difference in length of direct and reflected paths, the remaining pressure is obliterated by the arrival of the tension-wave.—E. F. Armstrong and T. P. Hilditch: A study of the catalytic action at solid surfaces (iii.). The hydrogenation of acetaldehyde and the dehydrogenation of ethyl alcohol in the presence of finely divided metals. *Hydrogenation of Aldehyde*.—Aldehyde may be converted into alcohol by passing the vapour together with hydrogen over either copper or nickel (Sabatier); but in presence of the latter metal, probably owing to the special affinity of nickel for the carbonyl group, the aldehyde is prone to undergo decomposition into carbon monoxide and methane. Copper at 200–220° effects reduction of aldehyde to alcohol smoothly, but at 300° about 50 per cent. of the aldehyde disappears and but little reduction is effected, the recovered aldehyde and alcohol being in about equal amounts. *Dehydrogenation of Alcohol*.—The yield of aldehyde obtained from alcohol as dehydrogenated in the presence of nickel is only 35 per cent., whereas, in the case of copper, not only is the ratio of aldehyde to hydrogen close to that calculated, but the unchanged alcohol may also be recovered almost quantitatively, the yield of aldehyde being about 90–95 per cent. of that to be expected from the amount of alcohol used. There is a striking absence of the secondary products observed when aldehyde together with an excess of hydrogen is passed over the metal at the same temperature.—E. F. Armstrong and T. P. Hilditch: A study of the catalytic action at solid surfaces (iv.). The interaction of carbon monoxide and steam as conditioned by iron oxide and by copper. It is shown that, like certain forms of iron oxide, prepared copper is able to effect considerable transformation of carbon monoxide and steam into carbon dioxide and hydrogen. Whereas, however, iron oxide at a suitable temperature causes the action to proceed almost as far as the equilibrium constant permits, copper does not at its optimum temperature effect more than 50–70 per cent. of the possible amount of chemical change; the exact proportion is to some extent a function of the composition of the original gas employed. The action of copper commences at a little more than 200° C., and up to 300° is greater than that of an iron oxide catalyst, the latter being without appreciable effect below 250° C. The difference in behaviour is explained by the hypothesis that copper effects a decomposition of formic acid (momentarily produced from carbon monoxide and steam) into carbon dioxide and hydrogen from 190° C. upwards, whereas the iron oxide alternately oxidises carbon monoxide, and is in turn in its reduced form reoxidised by the action of steam. These results are of interest, from the point of view of the general theory of catalysis which the authors have lately put forward, as illustrating the specific action of two different types of catalyst, which produce ultimately the same change ( $\text{CO} + \text{H}_2\text{O} = \text{CO}_2 + \text{H}_2$ ), but by an entirely different mechanism, involving production of intermediate systems of quite distinct kinds.—T. R. Merton: The structure of the Balmer series of hydrogen lines. In a previous investigation with Prof. J. W. Nicholson it was found that the separation of the components of the lines  $\text{H}_\alpha$  and  $\text{H}\beta$  suggested that the series should be regarded as a principal series. It is now found that

the structure of these lines is not invariable, but is altered by the presence of impurities, notably helium, in vacuum tubes containing hydrogen. The optimum conditions of sharpness were found in hydrogen mixed with an excess of helium and cooled to the temperature of liquid air, and under these conditions the separations of the components approximate to those appropriate to a diffuse or sharp series. The appearance of the lines in the purest obtainable hydrogen is entirely different. Measurements have been made of the separations of the components under the optimum conditions of resolution with the aid of an échelon diffraction grating, and the physical widths of the lines and the relative intensities of the components have been deduced from the measurements. It is suggested that the structure of the lines is complex, the relative intensities of the components being variable under different conditions; the structure suggested would appear to be consistent with Sommerfeld's theoretical investigations and with the results of experiment.—H. A. Wilson: Diamagnetism due to free electrons.

**Zoological Society**, April 13.—Dr. A. Smith Woodward, vice-president, in the chair.—Prof. A. Willey: An apodous *Amia calva*.—H. A. Baylis and Lt.-Col. Clayton Lane: A revision of the Nematode family Gnathostomidae.—A. M. Altson: The life-history and habits of two parasites of blowflies.

**Geological Society**, April 21.—Mr. R. D. Oldham, president, in the chair.—J. W. D. Robinson: The Devonian of Ferques (Lower Boulonnais). In the Lower Boulonnais, between Calais and Boulogne, lies a small tract of Devonian rocks. They form a link between the Devonian beds in Belgium, France, and Germany, and those of England geographically, and also geologically, since they appear to have been formed in a narrow strait which joined the open seas extending towards the Atlantic and over Germany and Russia.—E. S. Cobbold: The Cambrian Horizons of Comley (Shropshire), and their Brachiopoda, Pteropoda, Gasteropoda, etc. As the study of the Comley Cambrian fossils proceeded, it became apparent that the several faunas, sketched out in 1911 on the evidence of the trilobites (Q.J.G.S., vol. lxvii., pp. 282 *et seqq.*), and their order of appearance may prove to be of more than local interest. The author consequently proposes names for the horizons, based on their fossil contents, to replace those used in his previous publications, which were often clumsy and only of local origin, though necessary until the fossils were better known.

#### PARIS.

**Academy of Sciences**, April 12.—M. Henri Deslandres in the chair.—A. Lacroix: The eruption of Katla (Iceland) in 1918. This volcano, quiescent since 1860, entered in violent eruption in October, 1918. The eruption was explosive, and there was no lava flow.—G. Bigourdan: The instruments and observations of Bailly at the Louvre. The Observatory of the Abbey of Sainte-Geneviève, at Paris.—E. Ariès: The equation of state of ether. The formulæ deduced from the equation of state given in earlier communications require modification for ether. The results of the modified formula are compared with Young's experimental figures.—G. Julia: Families of functions of several variables.—L. Bianchi: Pairs of surfaces with lines of associated curvature.—C. Camichel: The permanent régime in water-chambers. An account of an experimental study of the water velocities by a photographic method.—C. Zenghells: The action of finely divided gases.—A. Gascard: The melissic alcohol of Brodie. Myricic

alcohol discovered by Brodie in beeswax, and named by him melissic alcohol. By analysis of the alcohol it is not possible to distinguish between  $C_{21}H_{42}O$  (Brodie) and  $C_{21}H_{40}O$ , but analysis of the iodide shows that the true composition is the latter. This has been confirmed by the preparation of the hydrocarbon  $C_{21}H_{40}$ , and by other reactions.—Ph. **Glangeaud**: The geyser of Martres d'Artières (Puy-de-Dôme). In Iceland the motive power of the geysers is steam; that of the Martres geyser is shown to be carbon dioxide.—L. **Gentil**: The mode of formation of terraces in chalk districts. A discussion of the views of Poulet Scrope. While these are in part in accord with the views of the author, it is maintained that these terraces can be formed by purely natural agencies, and are not in all cases due to ploughing, as supposed by Poulet Scrope.—H. **Vallois** and A. **Peyron**: The first stages in the development of the coccygian glomerule in man.—A. **Krempf**: Extension of the notion of oro-aboral metamerism to the internal organisation of the larva of the hexacorals (*Pocillopora cespitosa* and *Seriotopora subulata*).—MM. **Diéniert** and **Girault**: The action of activated sludge on the ammonia of sewage and of ordinary water.—R. **Legroux** and J. **Messard**: Vitamines for the culture of bacteria. The current view that the growth of bacteria in a culture medium stops owing to the inhibiting action of deleterious substances is held by the author to be incorrect. Most media derived from animal or plant tissues contain more or less substances (hormones) favouring bacterial growth.—A. **Paillet**: The polymorphism of bacteria.—S. **Giaya**: Zinc in the human organism. The normal presence of zinc in the body is proved, the proportion increasing with the age of the subject.

**Books Received.**

Invertebrate Palæontology. By H. L. Hawkins. Pp. xix+226+xvi plates. (London: Methuen and Co., Ltd.) 6s. 6d. net.

Chemical Fertilizers and Parasitocides. By S. H. Collins. Pp. xii+273. (London: Baillière, Tindall, and Cox.) 10s. 6d. net.

The Coolidge Tube: Its Scientific Applications, Medical and Industrial. By H. Pilon. Translated. Pp. v+95. (London: Baillière, Tindall, and Cox.) 7s. 6d. net.

Lad: A Dog. By A. P. Terhune. Pp. 309. (London: J. M. Dent and Sons, Ltd.) 6s. net.

Industrial Administration. By A. E. Berriman and others. Pp. vii+203. (Manchester: At the University Press; London: Longmans and Co.) 7s. 6d. net.

Scientific Management in the Home: Household Engineering. By Mrs. C. Frederick. Pp. 527. (London: G. Routledge and Sons, Ltd.) 12s. 6d. net.

Bibliography of Industrial Efficiency and Factory Management. By H. G. T. Cannons. Pp. viii+167. (London: G. Routledge and Sons, Ltd.) 10s. 6d. net.

The House-fly: Its Life-History and Practical Measures for its Suppression. By Major E. E. Austen. Pp. 52. (London: British Museum (Natural History).) 1s. 6d. net.

A National System of Education. Pp. 78. (Manchester: At the University Press; London: Longmans and Co.) 1s. net.

Physiology. By Prof. R. D. Salisbury. Third edition. Pp. xv+676+26 plates. (New York: Henry Holt and Co.)

Early English Magic and Medicine. By Dr. C. Singer. Pp. 34. (London: Oxford University Press.) 4s. net.

Committee of the Institution of Civil Engineers appointed to Investigate the Deterioration of Structures of Timber, Metal, and Concrete exposed to the

Action of Sea-water. First Report of the Committee. Edited by P. M. Crosthwaite and G. R. Redgrave. Pp. 301+33 plates. (London: Institution of Civil Engineers.) 30s. net.

The Columbian Tradition on the Discovery of America and of the Part Played Therein by the Astronomer Toscanelli. By H. Vignaud. Pp. 62. (Oxford: at the Clarendon Press.) 3s. 6d. net.

Silver: Its Intimate Association with the Daily Life of Man. By B. White. Pp. xi+144. (London: Sir Isaac Pitman and Sons, Ltd.) 2s. 6d. net.

Spanish Prose and Poetry: Old and New, with Translated Specimens. By I. Farnell. Pp. 185. (Oxford: At the Clarendon Press.) 10s. 6d. net.

Hydrographical Surveying. By the late Rear-Admiral Sir W. J. L. Wharton. Fourth edition, revised and enlarged, by Admiral Sir Mostyn Field. Pp. xii+570. (London: John Murray.) 30s. net.

Psychology and Folk-lore. By Dr. R. R. Marett. Pp. ix+275. (London: Methuen and Co., Ltd.) 7s. 6d. net.

The Atlas Geographies. Part iii. Senior Geography. No. 2: Europe. Pp. iv+148. (Edinburgh: W. and A. K. Johnston, Ltd.; London: Macmillan and Co., Ltd.) 7s. 6d. net.

A Handbook of British Mosquitoes. By Dr. W. D. Lang. Pp. vii+125+5 plates. (London: British Museum (Natural History).) 20s.

Flora of Jamaica. Vol. iv. By W. Fawcett and Dr. A. B. Rendle. Pp. xv+369. (London: British Museum (Natural History).) 25s.

Catalogue of the Lepidoptera Phalænæ in the British Museum. Supplement. Vol. ii. By Sir G. F. Hampson. Pp. xxiii+619. (London: British Museum (Natural History).) 30s.

Arithmetic. Part 2. By F. W. Dobbs and H. K. Marsden. Pp. xii+163+xi. (Answers.) (London: George Bell and Sons, Ltd.) 3s. 6d.

Elementary Algebra. Part I. By C. V. Durell and G. W. Palmer. Pp. viii+256+viii. (Answers.) (London: George Bell and Sons, Ltd.) 3s. 6d.

Le Parc National Suisse. By S. Brunies. Traduit par S. Aubert. Pp. 274. (Bâle: B. Schwabe et Cie.) 12 francs.

Die Gliederung der Australischen Sprachen. By P. W. Schmidt. Pp. xvi+209. (St. Gabriel-Mödling, bei Wien: "Anthropos.")

An Introduction to Sociology. By Prof. J. J. Findlay. Pp. xi+304. (Manchester: At the University Press; London: Longmans and Co.) 6s. net.

**Diary of Societies.**

THURSDAY, MAY 6.

IRON AND STEEL INSTITUTE (at Institution of Civil Engineers) (General Meeting), at 10 a.m.—Dr. J. E. Stead: Inaugural Address.—E. H. Lewis: Iron Portland Cement.—At 2.30.—F. Clements: British Blast-Furnace Practice.—H. E. Wright: Chemical and Thermal Conditions in Blast-Furnace Practice.—C. H. Riddale: The Valuation of Ores and Iron-making Material.—J. A. Heskett: The Utilisation of Titaniferous Iron Ore in New Zealand.

ROYAL SOCIETY OF MEDICINE (Obstetrics and Gynecology Section, conjointly with the North of England and Midland Obstetrical and Gynecological Societies), at 10.30 a.m.—Dr. H. Tweedy and Others: Discussion on the Treatment of Antepartum Hemorrhage.—At 2.—Dr. E. Holland and Others: Discussion on Rupture of Cesarean Section Scar in Subsequent Pregnancy of Labour.

ROYAL INSTITUTION OF GREAT BRITAIN, at 3.—R. Campbell Thompson: The Legends of the Babylonians.

ROYAL SOCIETY, at 4.30.—R. H. Fowler, F. C. Gallop, C. N. H. Lock, and H. W. Richmond: The Aerodynamics of a Spinning Shell.—Prof. W. E. Dalby: Researches on the Elastic Properties and the Plastic Extension of Metals.—C. T. R. Wilson: Investigations on Lightning Discharges and on the Electric Field of Thunderstorms.—L. F. Richardson: The Supply of Energy to Atmospheric Eddies.

LINNEAN SOCIETY OF LONDON, at 5.—Dr. G. P. Hilder: Notes on the Physiology of Sponges. *Panostia thourizum*, a New Species of Alga found in a Sponge.—E. J. Bedford: The British Marsh Orchids and their Varieties, illustrated by Coloured Drawings and Lantern Slides.

CHEMICAL SOCIETY, at 8.—G. M. Bennett: The Mustard Gas Problem.—C. K. Ingold: A New Method of Preparing Muonic Acid.—J. W. Cook and O. L. Braly: The Dimerization of *m*-Acetotoluene.—Y. Venkatarayana and M. V. Narasimhaswamy: A New Ozoniser.—G. T. Morgan and H. D. K. Drew: Orthochlorodinitrotoluenes. Part I. SOCIETY OF ANTIQUARIES, at 8.30.

FRIDAY, MAY 7.

IRON AND STEEL INSTITUTE (at Institution of Civil Engineers) (General Meeting), at 10 a.m.—C. A. Ablett: Direct Current compared with Three-Phase Current for Driving Steel Works Plant.—J. F. Wilson: Notes on Slag Conditions in Open-hearth Basic Selmaking Practice.—B. Yaneske and G. A. Wood: The Reduction of Silicon from the Slag in the Acid Open-hearth Process.—At 2.30.—W. E. Hughes: Some Defects in Electrodeposited Iron.—P. Baker and J. K. Russell: Note on the Ball Test.—J. H. Whiteley: The Distribution of Phosphorus in Steel between Points A1 and A2.—G. F. Preston: Practical Notes on the Design and Treatment of Steel Castings.

ROYAL SOCIETY OF MEDICINE (Laryngology Section), at 4.45.—Annual General Meeting.

ROYAL ASTRONOMICAL SOCIETY (Geophysical Discussion), at 5.—Prof. R. A. Sampson and Others: The Use of Wireless Telegraphy in the Determination of Longitude.

CHINA SOCIETY (at School of Oriental Studies), at 5.30.—G. S. Boulger: The History of Silk.

JUNIOR INSTITUTION OF ENGINEERS, at 7.30.—J. G. McBryde: Pulverised Fuel.

PHILOSOPHICAL SOCIETY (at University College), at 8.—Anniversary.

ROYAL INSTITUTION OF GREAT BRITAIN, at 9.—Lord Rayleigh: The Blue Sky and the Optical Properties of Air.

SATURDAY, MAY 8.

ROYAL INSTITUTION OF GREAT BRITAIN, at 3.—Dr. F. Chamberlin: The Private Character of Queen Elizabeth I.—At 5.—Dr. E. B. Rieu: BRITISH PSYCHOLOGICAL SOCIETY (at Bedford College), at 3.30.—Dr. E. W. Scripture: Speech Inscriptions in Normal and Abnormal Conditions.—A. Klein: Camouflage in Land Warfare.

MONDAY, MAY 10.

ROYAL GEOGRAPHICAL SOCIETY (at Lower Lodge, Kensington Gore), at 5.—G. Dobson: Instruments for the Navigation of Aircraft.

BIOCHEMICAL SOCIETY (at Chemical Department, St. Bartholomew's Hospital), at 5.30.—I. S. Hele: The Synthesis of Mercapturic Acids in the Dog.—R. G. Mackenzie Wallis and H. E. Archer: Improved Methods of Analysis of the Gastric Juice.—G. Graham: The Source of the Uric Acid Excreted in the Urine after Atophan.

ROYAL SOCIETY OF MEDICINE (War Section), at 5.30.—Annual General Meeting.—Surg.-Capt. Bassett-Smith: Surgery, with Special Reference to Pyrophylms in the Royal Navy.

ARISTOTELIAN SOCIETY (at 74 Grosvenor Street), at 8.—Prof. H. Wildon Carr and Others: Discussion on Bergson's "Mind-Energy."

ROYAL SOCIETY OF ARTS, at 8.—A. T. Bolton: The Decoration and Architecture of Robert Adam and Sir John Soane, 1738-1837 (Cantor Lecture).

INSTITUTION OF MECHANICAL ENGINEERS (Graduates' Association), at 8.—E. B. W. Maitland: Chemistry as applied to Boilers.

MEDICAL SOCIETY OF LONDON (General Meeting), at 8.—At 9.—Sir D'Arcy Power: Rev. John Ward and Medicine (Annual Oration).

SURVEYORS' INSTITUTION, at 8.—S. A. Smith: Rent Problems.

TUESDAY, MAY 11.

ROYAL HORTICULTURAL SOCIETY, at 3.—Sir Daniel Morris: The Use and Relative Value of Trees in Great Britain.

ROYAL INSTITUTION OF GREAT BRITAIN, at 3.—Prof. A. Keith: British Ethnology: The Invaders of England.

ZOOLOGICAL SOCIETY OF LONDON, at 5.30.—Dr. W. J. Dakin: Fauna of Western Australia. III. Further Contributions to the Study of the Onychophora.—C. Forster-Cooper: Cheliceriferous from Baluchistan.—Dr. W. T. Calman: Notes on Marine Wood-boring Animals. I. The Shipworms (Teredinidae).

ROYAL PHOTOGRAPHIC SOCIETY OF GREAT BRITAIN, at 7.—Prof. A. Findlay: Some Properties of Colloidal Matter and their Applications in Photography (Second Biennial Hunter and Driffell Memorial Lecture).

QUEBET MICROSCOPICAL CLUB (at 20 Hanover Square), at 7.30.

ILLUMINATING ENGINEERING SOCIETY (at Royal Society of Arts), at 8.15.—Annual Meeting.—Capt. J. W. Barber: Recent Developments in Portable Types of Cinema Outfits.

WEDNESDAY, MAY 12.

ROYAL SOCIETY OF ARTS, at 4.30.—G. Hewitt: Rolls of Honour.

ROYAL AERONAUTICAL SOCIETY (at Royal Society of Arts), at 8.—Major L. Hope: Short Flights.

BRITISH PSYCHOLOGICAL SOCIETY (Education Section) (at London Day Training College), at 8.—H. Gordon: Left-handedness and Mental Deficiency.

THURSDAY, MAY 13.

ROYAL INSTITUTION OF GREAT BRITAIN, at 3.—A. P. Graves: Welsh and Irish Folk Song.

ROYAL SOCIETY, at 4.—Election of Fellows.—*Probable Papers*.—Dr. A. D. Waller: Demonstration of the Apparent "Growth" of Plants (and of Inanimate Materials) and of their Apparent "Contractility."—W. N. F. Woodland: The "Renal Portal" System (Renal Venous Meshwork) and Kidney Excretion in Vertebrata.

LONDON MATHEMATICAL SOCIETY, at 5.

INSTITUTION OF ELECTRICAL ENGINEERS (at Institution of Civil Engineers), at 6.—S. Evershed: Permanent Magnets in Theory and Practice.

OPTICAL SOCIETY, at 7.30.

INSTITUTION OF AUTOMOBILE ENGINEERS (Graduates' Section) (at 28 Victoria Street), at 8.—W. E. Newbough: The Chemical and Physical Properties of Iron and Steel.

ROYAL SOCIETY OF MEDICINE (Neurology Section), at 8.30.—Annual General Meeting.—Dr. S. A. K. Wilson: Decerebrate Rigidity in Man, and the Occurrence of Tonic Fits.

FRIDAY, MAY 14.

ROYAL ASTRONOMICAL SOCIETY, at 5.  
ROYAL SOCIETY OF MEDICINE (Clinical Section), at 5.—Annual General Meeting.

PHYSICAL SOCIETY OF LONDON, at 5.—Dr. F. Lloyd Hoopwood: Demonstration of Experiments on the Thermionic Properties of Hot Filaments.—G. D. West: A Modified Theory of the Crookes Radiometer.—A. Campbell: The Magnetic Properties of Silicon-Iron (Stalloy) in Alternating Fields of Low Value.—T. Smith: Tracing Rays through an Optical System.

MALACOLOGICAL SOCIETY OF LONDON (at Linnean Society), at 6.  
INSTITUTION OF ELECTRICAL ENGINEERS (Students' Meeting) (at King's College), at 7.—E. G. Humphres: Electrical Motor Control Devices.—The Meeting will be preceded by the Annual General Meeting.

ROYAL INSTITUTION OF GREAT BRITAIN, at 9.—Prof. Karl Pearson: Sideights on the Evolution of Man.

SATURDAY, MAY 15.

ROYAL INSTITUTION OF GREAT BRITAIN, at 5.—Frederic Harrison: A Philosophical Synthesis as proposed by Auguste Comte.

CONTENTS.

PAGE

The Cost of Scientific Publications . . . . .	285
Useful Physiology. By A. E. B. . . . .	286
Service Chemistry. By Sir T. E. Thorpe, C.B., F.R.S. . . . .	287
Euclid's Elements. By G. B. M. . . . .	288
The Earliest Flint Implements . . . . .	289
The Heat Treatment of Cast Iron . . . . .	290
Our Bookshelf . . . . .	230
Letters to the Editor:—	
Organisation of Scientific Work.—Sir Leonard Rogers, F.R.S. . . . .	292
The Small Islands of Almost-Atolls.—Prof. W. M. Davs . . . . .	292
Scientific Apparatus from Abroad.—Prof. W. M. Bayliss, F.R.S. . . . .	293
The Cost of Laboratory Fittings.—Alan E. Munby . . . . .	294
The Standard of Atomic Weights.—Dr. Stephen Miall . . . . .	294
The Mole Cricket. ( <i>Illustrated</i> ).—F. V. D. . . . .	294
The Opophone: An Instrument for Reading by Ear. ( <i>Illustrated</i> ). By Dr. E. E. Fournier d'Albe . . . . .	295
The Kalahari and Ovamboland. ( <i>Illustrated</i> ). By Prof. E. H. L. Schwarz . . . . .	297
The Royal Academy. By J. S. D. . . . .	300
Obituary:—	
Capt. E. W. Creak, C.B., F.R.S. By T. H. T. . . . .	300
Sir Edmund Giles Loder, Bart. By Right Hon. Sir Herbert Maxwell, Bart., F.R.S. . . . .	301
Prof. Wilhelm Pfeffer, For. Mem.R.S. By V. H. B. . . . .	302
Notes . . . . .	303
Our Astronomical Column:—	
The Lunar Eclipse . . . . .	307
The Nature of Photographic Images . . . . .	307
The Binary Kueger 60 . . . . .	307
Leonardo da Vinci. By Edward McCurdy . . . . .	307
Public Support of Scientific Research . . . . .	309
American Agricultural Research. By W. E. B. . . . .	310
Canadian Water-Power Development . . . . .	311
The Solar Eclipse of May, 1919 . . . . .	311
The Manufacture of Synthetic Ammonia and Production of Nitrates . . . . .	312
New Ordnance Survey Maps . . . . .	312
University and Educational Intelligence . . . . .	312
Societies and Academies . . . . .	313
Books Received . . . . .	315
Diary of Societies . . . . .	315

Editorial and Publishing Offices:  
MACMILLAN AND CO., LTD.,  
ST. MARTIN'S STREET, LONDON, W.C.2.

Advertisements and business letters to be addressed to the Publishers.

Editorial Communications to the Editor.  
Telegraphic Address: PHUSIS, LONDON  
Telephone Number: GERRARD 8830.



THURSDAY, MAY 13, 1920.

### The Federation of Science.

WE referred last week to the harassed condition in which many scientific societies find themselves in consequence of the greatly increased cost of publication of papers communicated to them, and other additional expenses involved in the rise in prices. While the incomes remain much the same as they were before the war, the essential expenditure has become so much greater in proportion to them that the outlook is depressing to contemplate. Any increases in subscriptions which would prevent the younger scientific workers from joining learned societies, or cause a number of present members to resign would be detrimental not only to British science, but also to the extension of natural knowledge and to the welfare of mankind. The fields are ripe, and more labourers are now being trained to work in them than ever before, but if advantage is to be taken of the harvest, machinery for carrying it must be provided, and granaries built in which it can be stored. As things are at present, most of the scientific grain is cut by voluntary workers, and they are perplexed because they cannot see how they are to pay for the construction of a building in which to store it for the benefit of the community.

We are painfully reminded of this association of high motive with restricted effectiveness by the third annual report, which reached us a few days ago and is summarised on another page, of the Conjoint Board of Scientific Societies. The Board was constituted in 1916 for the purpose of "promoting the co-operation of those interested in pure or applied science; supplying a means by which the scientific opinion of the country may, on matters relating to science, industry, and education, find effective expression; taking such action as may be necessary to promote the application of science to our industries and to the service of the nation; and discussing scientific questions in which international co-operation seems desirable." In the main, these objects are much the same as those of the British Science Guild, founded by Sir Norman Lockyer in 1905, but the constitutions of the two bodies are different. Whereas the British Science Guild aims at securing the active interest and support of all members of the public who desire to promote the application of science and scientific method to

national and provincial affairs of every kind, membership of the Conjoint Board is limited to representatives nominated by scientific and technical societies.

The total number of constituent societies now represented on the Board is fifty-seven, and it includes practically all the leading British societies concerned with the advancement of science and technology. The Royal Society sends four representatives, and the other societies one or two, the total number being eighty-seven, and including leaders in all departments of science and technology. We have, therefore, in the Board a federation or union which can faithfully represent joint opinion upon any scientific or technical matter of national importance submitted to it. The organisation is thus admirable for its purposes, but, as in all like British institutions, it has not the means to carry out its aims and objects. The funds of the Board are derived from contributions from the constituent societies, and these amounted last year to about 600*l*. Three societies have intimated that they are unable to make a contribution this year, owing apparently to the necessity for limiting in every possible direction the claims upon their incomes, so that this splendid organisation not only finds its activities hampered through a miserably inadequate income, but must also contemplate the future with serious misgiving. For though British science may organise itself, it has not the means to provide the motive power for the machinery it has created.

How different the conditions are in the United States may be judged from the article upon the National Research Council printed elsewhere in this issue. Like the Conjoint Board—or Federation, as it should have been called, to prevent confusion with the medical Conjoint Board—the National Research Council was started by men of science themselves, and represents their efforts to mobilise the whole strength of American science for the promotion of national well-being and the advance of science itself. While recognised by the United States Government, the Council was not organised by it, and is not supported by it. The Council's funds are derived from private sources, and the Carnegie Corporation alone has contributed no less than one million pounds, which is the amount given by our Government in 1916 in establishing the Department of Scientific and Industrial Research "for the conduct of research for the benefit of the national industries on a co-operative basis." The Council has permanent headquarters at Washington, with an executive

staff of men of science giving their whole time to the work of their respective positions. While it favours well-planned co-operation and organised effort in connection with the solution of particular problems, it is opposed to all attempts at central control of research, and to any action which may hamper the individual investigator or hinder personal initiative.

The National Research Council has thus like functions to those of our Department of Scientific and Industrial Research, but its constitution is different, and approaches more closely that of the Conjoint Board of Scientific Societies. It is not financed by the U.S. Government, and is, therefore, not a Government bureau, but a federation of the principal research agencies in the United States concerned with the fields of science and technology. Men of science in America are fortunate in securing the generous support of private benefactors for the work of their National Council. They are in consequence perfectly free to determine their own policy and to shape their own destiny, untrammelled by any of the conditions laid down by administrators unfamiliar with their spirit or their service.

Much of the misunderstanding which exists among many of our men of science concerning the Department of Scientific and Industrial Research would be avoided if the constitution of the Department were on the democratic lines of the National Research Council. We do not wish to depreciate the work of the Department in the slightest—indeed, its very important activities in some directions have often been commented upon in our columns—but we think the work could be extended and made more effective if the suspicion of bureaucratic control could be removed completely by placing responsibility for it more definitely upon the body of scientific opinion. The men who administer the grants in aid made by the Royal Society, British Association, and other scientific societies represent the fellows or members of these societies, and are not appointed by other persons or bodies. This is the case also in the National Research Council, and we suggest that our Department of Scientific and Industrial Research might relieve itself of the criticism to which it is sometimes subjected by making its Advisory Council similarly representative of scientific opinion.

Even if this change of constitution cannot be readily made, we have in the Conjoint Board a means at hand of removing existing objections. The Department might make the Board a part of

its administrative machinery and pay it an annual retaining fee for service in a consultative capacity, without giving it any executive functions. The Board would thus serve as *liaison* officer between the Department and scientific societies, and science workers as a body would share responsibility with the Department in the selection of subjects for investigation which should be supported, and of societies to which these might suitably be entrusted. If our rich citizens and corporations were as generously disposed towards science and education as those of the United States, the Conjoint Board would be able to carry on its work as effectively as the National Research Council, without connection with a Department of Government. There is, however, little hope that such aid will be forthcoming, and in its absence the Department could with advantage use an organisation very similar in constitution to the National Research Council, but, unfortunately, without the funds to do like service for science.

Though the Conjoint Board was associated with the establishment of the Department of Scientific and Industrial Research, it has hitherto received little aid from the Department, and has had to carry on its very useful work mainly through its own slender resources. Among the important subjects dealt with by committees of the Board are the application of science to agriculture, national instruction in technical optics, the possible relation between magnetic anomalies and the presence of iron ores, water-power of the British Empire, timber for aeroplane construction, glue and other adhesives, Patent Laws, and the need for a joint building for scientific and technical societies. In New York there is a splendid building of this kind, and the National Research Council proposes to expend 200,000*l.* on its headquarters. Here there is nothing to compare with such accommodation for joint housing and meetings of scientific and technical workers. Science has organised itself in the Board as well as shown directions in which organised effort may profitably move. What is wanted now is what scientific workers are unable themselves to provide, namely, sufficient funds to enable the Board to continue and extend its operations on a firm financial basis. We hope the Department of Scientific and Industrial Research will be able to afford some aid of this kind, while we pray that private benefactors will arise who will place the Board in the same independent and strong scientific position as is enjoyed by the National Research Council of the United States.

### Lord Kitchener as a Scientific Worker.

*Life of Lord Kitchener.* By Sir George Arthur. In three volumes. Vol. i. Pp. xxvi+326. Vol. ii. Pp. xi+346. Vol. iii. Pp. xi+413. (London: Macmillan and Co., Ltd., 1920.) Price 2l. 12s. 6d. net.

SIR GEORGE ARTHUR'S account of the work of the eminent soldier and administrator who is the subject of his three volumes is impressive not only on account of the series of successes which Lord Kitchener obtained in different and dissimilar fields, but also because of the methods by which so much was attained, for the biography is presented with such vividness that the careful reader can discern the man apart from his work. It is true that many of the episodes in the career of Lord Kitchener are mentioned with scarcely a comment, where expansion would have been desirable. Nevertheless, there is sufficient for interest and instruction in the mere relation of the stirring events in which he played so prominent a part. To have dealt with them in detail would perhaps have unduly expanded the volumes.

Kitchener possessed a variety of qualities and tastes obvious only to his intimates. Those not in intimate official relation with him in his work cannot readily form a conception of his methods. How much of his inflexibility he owed to his never having been cast in the public-school mould it is impossible to say, but to his early scientific training and his scientific tastes he no doubt owed the precision and accuracy which he required from those about him and to which he subjected himself. He was a quick thinker, readily grasping the conceptions of others, rapid in his decisions, rejecting or accepting proposals with astonishing celerity. The initiative always lay with him. It was he who gave scientific form to all his own projects. The spirit was his. It is the personality of the man which interests us as we pass from work to work.

His methods were not those of the orthodox administrator, and we cannot conceive Kitchener sheltering himself behind committees, though he frequently summoned conferences. Lord Salisbury, in his preface to the book, describes him as a man of sentiment, and pre-eminently as a man of imagination. Nothing can be more true; but it would be a mistake to suppose that, "bold and independent" as was his mind, he undervalued the opinions of experts who ventured to question his conclusions. If he never argued, he was ready to listen, and the latitude which he gave to a subordinate in devising means to an end was the measure of that confidence he reposed

in his staff which was his marked characteristic. His conclusions were ever his own, and were irrevocable. Although to him the end was everything, he was less impatient of detail than is generally supposed. For precedent, of course, he cared nothing.

The truth appears to be that Kitchener's early scientific training profoundly influenced him in his subsequent career. That earnestness which he displayed in the solution of engineering undertakings was as evident in his readiness to adapt new knowledge in any branch of science to the solution of his administrative problems, and experts could readily discern the scientific method by which he reached his conclusions, for he reasoned from facts. As Sir George Arthur alludes only very briefly to the influence which Kitchener, as Commander-in-Chief in India, exerted on the reduction of disease and invaliding incidence in the Army of India, this influence is likely to be overlooked. In the history of this branch of Army administration the work of the Commander-in-Chief must always occupy a prominent place. Here he left a permanent monument to himself. It would have been strange had it been otherwise, for by his previous training and experience problems of public health were certain to appeal to him by reason of their bearing upon Army efficiency, and so we read:—

"Recent discoveries in bacteriology facilitated a systematic investigation which Kitchener, after the conference of 1905, instituted into the causation and origin of these maladies: a campaign against the house-fly, with its nidus in the night-soil accumulated near cantonments, and the mosquito—the recognised agents of the two diseases—resulted in a most significant drop of nearly one-half in the death and sickness rates. Stringent preventive regulations were issued as to sanitation, inoculation for malaris [*sic*], the purification of water, and the preservation of all food and drink from contamination; and it was peremptorily ordered that all persons—British or Native—before being employed in the preparation of any sort of eatables intended for the troops, should undergo a medical examination. Depots were also established in the hills for enteric convalescents, often carriers, who had hitherto not been sufficiently recognised as a source of danger to their comrades; and technical training in hygiene was provided for selected N.C.O.'s and men, each of these sanitary sections being supervised by a medical officer."

Similarly we see in other incidents the influence of Kitchener's early training and his scientific sympathies in many of his epoch-making measures. He was a lover of learning, and had that delight in it which we are told he endeavoured to inculcate in the students of the Staff College

at Quetta. His foundation of this college and his establishment of the institution at Khartum are evidence sufficient of his interest in education. Indeed, in his knowledge of science and in his appreciation of its utility Kitchener may be said to stand alone amongst great military administrators.

We get some clue to the Kitchener method if we bear these facts in mind, and we are enabled to see how, forsaking the practice of a scientific profession for the more ambitious sphere of civil administration and diplomacy, varying these with intervals of command of armies in peace and war, ending as an organiser of victory, he accomplished his ends with such extraordinary success.

No account of the life and work of this man will ever be complete which neglects a consideration of the influence exerted upon him by his early education. Kitchener understood the language of men of science. Consciously or unconsciously he adopted their methods. He was never out of date. We get a clue to his dislike of the bureaucrat, to his hatred of red tape, and to his contempt for precedent and of War Office methods, if we bear these in mind. We are not surprised when we hear that he "would rather sweep a crossing" than go to the War Office, for freedom to work on new lines—"always a learner," as his biographer tells us—was the very essence of the Kitchener method. When Lord Curzon and Lord Haldane characterised his organisation of the Army in India as "scientific" they were nearer the mark than perhaps even they recognised; for in the widest acceptance of the term Kitchener was a man of science, and Sir George Arthur's record of his remarkable career will find many appreciative readers in the scientific world.

### The Nation's Food.

*Food Supplies in Peace and War.* By Sir R. Henry Rew. Pp. vii + 183. (London: Longmans, Green, and Co., 1920.) Price 6s. 6d. net.

SIR HENRY REW has the happy and unusual faculty of making statistics interesting; indeed, the only time when he is less interesting than usual is when he is quoting fewer figures. In this little book he has brought together the vital statistics of British food supplies and set them out: they tell their own tale so plainly that even the ordinary non-statistical person can understand.

The book was badly needed, for it is highly important that the average man should realise the facts. Unfortunately, agricultural policy is a

matter for politics and emotions, and political considerations have sometimes been more in evidence than facts or business principles. Recently a bishop wrote to the *Times* making the astonishing statement that he thought the bread subsidy was paid to farmers to encourage corn production. If such amazing lack of knowledge can occur in high places, what must be the state of the ordinary voter's mind? Sir Henry Rew's book will supply the facts for those who will take the trouble to read it.

In the first chapter he deals with the problem as it was before the war, when we had a considerable balance of money due from abroad which we could take either in food or in other commodities. The general result is shown in the following table:—

	Weight in metric tons used in the United Kingdom per annum. <sup>1</sup>		
	Home-grown.	Imported.	Total.
Cereals ... ..	1,010,000	3,855,000	4,865,000
Meat ... ..	1,615,000	1,070,000	2,685,000
Poultry, eggs, game, and rabbits ... ..	170,000	161,000	331,000
Fish ... ..	715,500	132,900	848,400
Dairy produce (including lard and margarine) ... ..	4,704,000	527,800	5,231,800
Fruit ... ..	341,000	930,000	1,271,000
Potatoes and other vegetables ... ..	4,788,000	694,000	5,482,000
Sugar (including cocoa and chocolate) ... ..	—	1,657,000	1,657,000

<sup>1</sup> A certain amount of cottage and farm produce is not included in the above table.

About one-fifth of the cereals, more than half the meat, and nine-tenths of the dairy produce and of the potatoes were home-grown. The total amount of foodstuffs, home-grown and imported, was considerable, and the nation was amply supplied with food. In 1913 the main sources of supply outside the United Kingdom were, in order of value of shipments, the United States, Argentina, Denmark, Canada, India, Australia, Russia, the Netherlands, Germany, New Zealand, Austria-Hungary, France, Spain, and Ceylon.

The second section of the book deals with war-time conditions. The outbreak of the war came, no doubt deliberately, at the time when the harvest of Central Europe was practically all gathered in, and when, therefore, there were ample stocks of food for a year. On our side the wheat crop in the United States was good, and although in Canada it was short, the total North American supply was well above the average. The year 1915 opened badly, as the Russian supplies were cut off in February. The situation was saved,

however, by the heavy crops in India and Argentina. Australia considerably increased her wheat area, as did also the United States and Canada; indeed, during the first year of the war the wheat area of the world was extended by more than 18,000,000 acres. In the later years of the war the difficulty was one of transport rather than of total supply; a great effort was therefore made after the close of 1916 to increase food production in the United Kingdom. The methods and results have been discussed from time to time in these columns: the general result was a steady increase in production right up to 1918, the figures for the United Kingdom being in thousands:—

	1914	1915	1916	1917	1918
Wheat ... quarters	7,804	9,239	7,472	8,040	11,643
Barley ... ..	8,066	5,862	6,613	7,185	7,760
Oats ... ..	20,664	22,308	21,334	26,021	31,196
Beans ... ..	1,120	924	893	474	931
Peas ... ..	374	300	261	278	441
Potatoes... tons	7,476	7,540	5,469	8,604	9,223

This high production was obtained at a time when manures were scarce and implements difficult to repair, and when most of the skilled men were gone, their places being taken by old people, women, and children. But these substitutes worked with a will, and amply made up in enthusiasm what they lacked in skill. Even the high production of 1918 was not the maximum possible, and had the conditions persisted, even higher results could have been obtained.

The last section of the book deals with post-war conditions. Serious fears had been entertained as to the food supplies of the world; fortunately, these have not been realised, and although food is undoubtedly scarce and will remain so there is no reason to fear famine, and in the main the people of Europe, though still suffering privation, are better fed than they were in 1918. It is difficult to say what the position is likely to be in the near future, but the redeeming feature is the rapidity with which agriculture has been restarted in the devastated areas of France and Belgium. Of the 4,000,000 acres damaged by the war, nearly a quarter were handed back to the cultivators before a year had elapsed. On the other hand, agriculturists in our own country are not producing so much as they did. The withdrawal of the women from the land and their replacement by men coincided with a considerable fall in production, which is distinctly unfortunate. A further fall is anticipated as a result of the shortened hours of labour.

Other countries, however, are in a worse pre-

dicament. Russia, formerly one of the chief wheat-producing countries of the world, is unlikely to have any exportable surplus, and the position in Central Europe is still very obscure. Sir Henry Rew is not greatly perturbed, but thinks that if the social and political conditions of Europe became settled, its food production would rise to pre-war level in the course of two or three years. He is also quite hopeful about the position in this country. No student of British agriculture can ever give up hope of the future, and Sir Henry Rew is one of the leaders of the helpful band of optimists.

E. J. RUSSELL.

### Differential Geometry.

*The Elementary Differential Geometry of Plane Curves.* By R. H. Fowler. (Cambridge Tracts in Mathematics and Mathematical Physics. No. 20.) Pp. vii+105. (Cambridge: At the University Press, 1920.) Price 6s. net.

**D**IFFERENTIAL geometry is a fascinating subject, because it gives us vivid and picturesque embodiments of theorems obtained by the combination of several branches of pure analysis, such as algebra, function-theory, and the infinitesimal calculus. It presents us with problems of all degrees of difficulty, from the comparatively simple theory of curvature and torsion to the provokingly difficult question of geodesics.

The present tract is just what its title indicates, except that there are a few digressions on twisted curves and on surfaces. The work has two conspicuous merits; in applying the differential calculus, the assumptions made are explicitly pointed out, and proper attention is paid to the determination of sign. The latter point is particularly important, not only because an error in sign is the one most frequently committed in computation, but also because, if a consistent determination of sign is not strictly adhered to, the formulæ of analytical and even of pure geometry cease to have general validity. Even now our text-books, especially in analytical geometry, pay so little attention to this matter that a university teacher has to spend much valuable time on this topic with intermediate students, and too frequently finds, to his disgust, that even an honours student is not so careful as he should be in the matter of sign.

Mr. Fowler's chapters on tangents and normals, curvature, contact and envelopes, leave little, if anything, to be desired. The chapter on envelopes is the most thorough-going, and suggests a couple of remarks. The elimination of  $\alpha$  from the equations  $f(x, y, \alpha) = 0$ ,  $\partial f / \partial \alpha = 0$  leads to a definite locus

which may break up into a number of distinct, irreducible curves. How far any one of these curves should be considered to form a part of the envelope proper depends upon our definition of "envelope." For instance, in the author's example (p. 61)—

$$(y-a)^2 - x^3 = 0,$$

the  $\alpha$ -eliminant is  $x^3 = 0$ , which is a cusp-locus: Mr. Fowler refuses to regard this as an envelope, but if we regard the cusps as limiting forms of nodes, we may fairly regard  $x=0$  as the limit of an envelope. However, this is a matter of slight importance, because each case that occurs can be treated independently.

On p. 60 we have the example—

$$a^2f + (2a+1)h = 0,$$

where the  $\alpha$ -eliminant is  $h(h-f) = 0$ , and neither  $h=0$  nor  $h-f=0$  is an envelope. If we put  $(2a+1)/a^2 = \beta$ , the family of curves is  $f + \beta h = 0$ , and the  $\beta$ -eliminant is  $h=0$ . It seems worth while to direct attention to this apparent discrepancy, because similar cases occur in problems of maxima and minima, etc. If, starting with  $f + \beta h = 0$ , we replace  $\beta$  by  $(2a+1)/a^2$ , we obtain, by variation of  $a$ , the same pencil of curves; but, generally speaking, each curve occurs twice, and, as a rule, for different values of  $a$ . If  $\beta = -1$ ,  $(a+1)^2 = 0$ , and the curve  $f-h=0$  counts twice for the double value  $a = -1$ , and hence  $f-h=0$  occurs in the  $\alpha$ -eliminant, though it does not appear in the  $\beta$ -eliminant. Similar results, of a more complicated kind, occur if in  $f + \beta h = 0$  we put  $\beta = \phi(\alpha)/\psi(\alpha)$ , where  $\phi(\alpha)$ ,  $\psi(\alpha)$  are any polynomials in  $\alpha$ .

In his last two chapters we think Mr. Fowler has rather lost his sense of proportion. In the eight pages devoted to the singular points of plane curves, scarcely anything more is attempted than a discussion of ordinary nodes and cusps; on the other hand, fourteen pages are filled with the theory of rectilinear and curvilinear asymptotes, and many of the results may fairly be said to be more interesting in function-theory than in geometry proper.

The author has conscientiously given references to the text-books which he has more or less followed in his exposition; but there is no bibliography of original papers, such as add greatly to the value of other tracts in this series. We hope that in future editions this want will be supplied; reference should at least be made to Puiseux, Weierstrass, Smith, and Halphen in connection with singular points.

G. B. M.

NO. 2637, VOL. 105]

### A Garden in the Dunes.

*Arcachon, Ville de Santé: Monographie Scientifique et Médicale.* By Dr. F. Lalesque. Pp. viii + 798. (Paris: Masson et Cie, 1919.) Price 25 francs net.

THIS handsome volume is mainly a justification of Arcachon as a health-resort, and it should appeal to those who feel the attractions of a life in France, and yet shrink from the crowd and cosmopolitan gaiety of the Mediterranean Riviera. The author is not content, however, with giving climatic temperature-charts, records of rainfall, and views of exercises on the shore and of yachting on the broad sea-basin. He has made a "regional survey" of his district, and the details of the natural history will provide matter of much interest to those who sojourn in the town. The modern "town" is a veritable garden city, especially developed in the last twenty years in accordance with Dr. Lalesque's scheme for *la cure libre*, and the separate villas provided in the *ville d'hiver* among the woods offer the patient the cheerful encouragements of family life in place of the more formal control of the sanatorium. The sand-dunes have been captured, as it were, and converted into shelters, while the fishing village on the open northern strand has been enlarged as a place for summer bathing.

Arcachon, indeed, began its career of usefulness when François Legallais, a retired sea-captain, imported from India to its desolate sand-hills the idea of the bungalow in 1823. Dr. Lalesque gives us, in a few brief lines, a sketch of this rather captivating incident in human settlement and geography. His range of vision is wide. He interests us equally in the wind-worn grains of magnetite brought northward from the great fan-deltas of the Adour system; in the "alios," a ferruginous conglomerate formed as an iron-pan in the subsoil, the permeability of which has now been triumphantly established; in the health of the oyster, an inoffensive creature, infected with typhoid germs entirely by the carelessness of man; and in the diatoms that flourish in the Lac de Cazeaux, to the actual benefit, it appears, of the water-supply of Arcachon. Dr. Lalesque in 1890 made an independent investigation of the irritating power on the human skin of the processionary caterpillar, the larva of *Bombyx pityocampa*, which inhabits the pine-trees of the coast, and he concludes that the hairs which cause urticaria are scattered from the nests of the insect by the wind. Even this affection seems trivial at Arcachon; we can imagine a visitor, temporarily inclined to irritation, being calmed by Dr. Lalesque's

enthusiasm and by his introduction to the fascinating work of Fabre.

The author shows us Arcachon, not as a modern creation on a promontory in a featureless lagoon, but as the product of great natural forces, conspiring for the health of man. The winds blow over it fraught with warmth from tropic waters; the sands are kept from wandering by the growth of aromatic pines; and the subsoils that can be traced southward across the vast Pliocene estuary of the Landes represent for the naturalist the spoils of the Central Plateau and the Pyrenees. Like Prof. Tornquist in East Prussia (*NATURE*, vol. lxxxv., p. 468), but with a little more professional formality, Dr. Lalesque has conquered in a field that offered little promise to the unobservant eye. G. A. J. C.

### Our Bookshelf.

*Iron Bacteria.* By Dr. David Ellis. Pp. xix + 179 + v plates. (London: Methuen and Co., Ltd., 1919.) Price 10s. 6d. net.

In this book Dr. David Ellis has compiled a monograph on a subject which he has largely made his own, and on which he can speak with first-hand knowledge. The group of micro-organisms discussed is important, and one of the makers of geological history, for many of the bog iron ores owe their formation largely to the activities of iron bacteria, and other iron ores may be due to the same cause. In modern life these organisms are of importance to the water engineer in relation to water reservoirs, the corrosion of conduit pipes, and the general appearance and clarity of water supplies.

The iron bacteria are a heterogeneous group of organisms, scarcely bacteria in the strict sense, belonging to several genera—*Leptothrix*, *Cladothrix*, *Crenothrix*, and others. The iron is collected from the water in which they live, and stored in a concentrated state as ferric hydroxide in the mucilaginous sheaths which surround their bodies. The ferruginous deposit in the membrane is often so great that it exceeds the volume of the organism itself, and the iron-impregnated membrane may persist for long after the dissolution of the organism.

Some of these organisms may occasionally multiply in a very short time to such an extent as in the course of a few weeks to change entirely the character of the water in which they are present, as was the case at Cheltenham in 1896. They may also cause encrustations in the pipes, and the group is therefore of considerable economic importance. Six species are fully described, and methods of treatment to retard their activities in water supplies are detailed. The book is well produced and illustrated, and forms a standard work on the subject.

R. T. H.

*Meteorology for All: Being some Weather Problems Explained.* By Donald W. Horner. With an Introduction by M. de Carle S. Salter. Pp. xvi + 184 + vii plates. (London: Witherby and Co., 1919.) Price 6s. net.

THE science of the weather may well make a wider appeal than any other branch of science, and the opening for a book which is not only scientifically accurate, but also simple and easily comprehended, is therefore very great. The author of the present work has realised that the opening exists, and has endeavoured to fill it, but his attempt can scarcely be considered successful. A few quotations will illustrate the nature of the book. In estimating cloud amounts on the scale 0-10 we are told that "if there is one cloud upon the horizon or in any part of the sky we put 1." For obtaining true bearings from a compass, "the magnetic variation in the British Isles is now 14° W." Again: "There is no more sure precursor of a gale than the 'wind-dog,' or coloured parhelion" (p. 2), which may possess some degree of truth, but scarcely seems compatible with: "When these halos are coloured and accompanied by parhelia or mock suns, they generally precede very dry weather" (p. 110). Even in such a simple matter as giving the equivalent velocities of the Beaufort numbers, the author falls into error. Some chapters are better than others, but the book can certainly not be recommended as a safe guide to put into the hands of the non-technical reader without previous knowledge of meteorology. J. S. D.

*The Psychology of the Future.* ("L'Avenir des Sciences Psychiques.") By Emile Boirac. Translated and edited with an introduction by W. de Kerlor. Pp. xiii + 322. (London: Kegan Paul, Trench, Trubner, and Co., Ltd., n.d.) Price 10s. 6d. net.

THE author deals with the more debatable classes of psychological phenomena discussed at the Paris Congresses of Experimental Psychology of 1911 and 1913, and defined as "the phenomena which, produced in animate beings or as an effect of their action, do not seem to be entirely explicable by the laws and forces of nature already known." They are classified as: Hypnoidal, including dissociation of personality and "cryptopsychism" (subconscious action); magnetoidal, which are supposed to comprise mesmerism, telepathy, and "hyloscopic" phenomena (unexplained actions of inanimate objects on animate beings); and spiritoidal, which imply agents of a psychological nature more or less analogous to human intelligence. The author proposes the term "bi-actinism" (bio-actinism?) for any phenomena in which a radiating influence is apparently exerted at a distance over other animate beings. For "clairvoyance," or knowledge obtained by certain individuals apparently independently of the normal senses, he prefers the term "metagnomy." On the question of the spiritistic hypothesis the author maintains a non-committal attitude.

### Letters to the Editor.

[The Editor does not hold himself responsible for opinions expressed by his correspondents. Neither can he undertake to return, or to correspond with the writers of, rejected manuscripts intended for this or any other part of NATURE. No notice is taken of anonymous communications.]

#### The Indian Chemical Service.

It would, perhaps, have been better if the writer of the leading article entitled "The Organisation of Scientific Work in India," published in NATURE of February 19, had held his hand until he had obtained further information concerning the proposed organisation. The report of the Indian Industrial Commission dealt only with the general question, and left the elaboration of any scheme, if such were considered desirable, to special committees which were to be appointed at a later date. The special committees were to be given a free hand, and were left to approach the problem from an unbiased point of view.

I was not a member of the Indian Industrial Commission, but there is nothing in the report which indicates that the Commission was in favour of a centralised system of scientific services under Government control such as that which is condemned in the article, and still more emphatically condemned by those who have contributed to the ensuing correspondence. As a matter of fact, if the Industrial Commission had recommended such a course, it would not have been supported for one moment by the Chemical Services Committee, over which I had the honour to preside. Indeed, my colleagues and I, as old investigators, would have been fully alive to the absurdity of any such proposal.

I should like to make my position clear by referring to the conditions we found to prevail in India and to the remedies which we considered necessary in order that the great natural resources of the country might be developed, but I should preface my remarks by saying that I speak for chemistry alone. Other sciences must formulate their own schemes in a manner best suited to their particular requirements.

The problem presented was twofold: First, the position of the chemists in India, and, secondly, the position of the Indian chemical industry. The position of chemists we found to be exceedingly unsatisfactory. There are in all about fifty chemists in India, and most of them are attached to established Government Services, such as forestry, agriculture, medicine, geology, ordnance, and education. In the main, the chemists, although working in the Services, were not attached to them—that is to say, they were in the position of hirelings without any claim to the advantages attaching to Service membership and without the possession of the *esprit de corps* which characterises such membership. They were, moreover, for the most part working in isolated positions in the different provinces, and were without any means by which they could press their claims on the official lay mind. In consequence, they were in many cases receiving totally inadequate salaries, and were, in fact, often regarded as some kind of freak druggist—a point of view which is even more prevalent in India than in England. It was clear that the only way by which the chemist in India could be brought to occupy a financial and social position which his education and training demanded was to place him on an equality with members of other Government Services.

The problem of the chemist was therefore a straightforward one, and was, in our opinion, open to one answer only. The other point, that of the Indian chemical industry, is perhaps rather more complex.

In the first place, there can be no question, I think, that research in chemistry must be divided into pure research and industrial research. It is true that there is no sharp line of division, but in their extreme forms pure research is carried out entirely for the advancement of knowledge, and is without obvious practical bearing, whereas industrial research is done for the advancement and development of industry. The Chemical Services Committee has recommended that pure chemical research should be left to the universities and university institutions, the obvious duty of which is to carry it out. It is not proposed that the chemists attached to university institutions should be normally members of the Service, but it is asked that the universities and university colleges should undertake to train men for recruitment into the Service in the manner recommended by the Committee.

The Committee considers that recruits should have the following training:—

- (1) An honours degree in chemistry in the first or second class or its equivalent.
- (2) Training in engineering (machine drawing and workshop practice) where such training has not formed part of the course under (1).
- (3) One or two years' training in the methods of chemical research under someone competent to train in research.

It is not proposed to institute any system of training within the Service, excepting, of course, such practical training as will normally accrue during the working of the Service, and it is asked that the universities and university institutions should give the necessary training under (3) above. For this purpose it is recommended that maintenance and equipment grants should be given to promising students to enable them to undergo this training subsequent to graduation.

The Committee considered that, provided the trainer were a man of recognised ability, the question of the subject in which the student should be trained could be safely left to him. It agreed that instruction in the methods of chemical research, received after a course such as that given above, was the best training a man could have to develop any initiative and enthusiasm which he might possess, and that a man so trained ought to be able to turn his hand to anything chemical.

In the case of industrial research it must be remembered that chemistry in one form or another underlies most industries, and that in India the following conditions are present: (a) Great natural resources; (b) lack of scientific chemical help to develop these resources; and (c) a public very shy to risk capital without some real assurance of the value of the process it is proposed to finance.

Obviously, the best means for advancing chemical industry is for the firms or combination of firms engaged in the industry to establish research laboratories and to work out their own problems by the aid of their own chemists. This is an ideal which the Indian Chemical Service will be formed to foster. It will, for example, help any member of the Service who wishes to pass out into the industry, and it will second members of the Service for temporary employment to firms who wish to investigate any particular problem. But at the present time there are few manufacturers who employ chemists, and it is evident that some steps are necessary not only to demonstrate to the manufacturer the value of research in connection with his manufacture, but also to demonstrate the possibilities of any particular process to any one wishing to invest capital and start a new industry.

Who is to do this? There is, we think, only one answer, namely, that, as it is to the interest of the State as well as of the manufacturer to develop



industry, it is the duty of the State to convince the manufacturer of the value and necessity of research in connection with his work.

The Indian Chemical Service will have research institutes in the centres of industry of every province. These will be in close touch with the works and with works conditions, and deal with questions of immediate practical importance submitted by manufacturers. They will also carry out research work in connection with the establishment of new industries, and develop a process as far as the unit factory scale. In some cases it will be necessary, in order to demonstrate the value of a process, to erect pioneer factories and work them on the complete commercial scale. Each institute will be under a director of research.

A central Imperial institute will be located at Dehra Dun. It will be under the Director-General of the Chemical Service, and contain laboratories for inorganic and physical chemistry, organic chemistry, analytical chemistry, and metallurgical chemistry, each controlled by a deputy-director. Questions involving fundamental research arising out of the work of the provincial institutes will be dealt with here, as well as the initial work in connection with the establishment of new industries. Research work of an All-India character, such as investigations on the utilisation of forest products, will also be done.

The report, which should reach England during the course of the next fortnight, should be consulted for further details. It may be added, however, that there is no official control; the Service will be worked by chemists for chemists. Chemists seconded for service with other Departments will retain their lien on the Chemical Service, but be under the control of the Department to which they have been seconded.

The provincial institutes will not be under the control of the central institute, which will act towards them in an advisory capacity only.

In conclusion, I should add that I have discussed the proposed scheme with eminent Indian men of science and prominent business men in different parts of the Empire, and they have told me that they are prepared to give it their whole-hearted support. Moreover, Sir P. C. Ray, the distinguished professor of chemistry in the College of Science, Calcutta, who was a member of the Committee and attended all its meetings, while stating at the outset that he was opposed in principle to Government Services generally, nevertheless agreed to each paragraph of the report as it was passed in its final form. He signed the report subject to a separate note in which he expresses his general approval of the scheme in the following words: "In conclusion, I desire to state that, although I consider that the days of Government Services are over and that the development of industries by the agency of a Government Service is not the most suitable way of dealing with the problem, yet I agree that, if a Government Service is constituted, the proposals of the Committee represent the best method of constituting and carrying on such a service. It is for this reason that I have attached my signature to a report with the major portion of which I am in substantial agreement."

JOCELYN THORPE.

I HAVE followed with keen interest the leading article on "The Organisation of Scientific Work in India" in *NATURE* of February 19, and the correspondence thereon by Profs. Soddy and Bateson, Sir Ronald Ross, and others. The note of warning has been sounded not a moment too soon. To me it appears that the Industrial Commission has not been able to make out

a very convincing case for the creation of a highly expensive All-India Chemical Service—an elaborate and ordered hierarchy under the almost absolute control of a number of highly paid bureaucrats. The Services degenerate in India, the land of caste, into so many rigid and watertight compartments unamenable to healthy external influence.

The manner in which the work of the Service is to be carried on appears to me to be extremely objectionable. There is to be a Director-General of Research at the Imperial Chemical Institute, with five or six directors at different provincial centres. These officers are to have almost absolute power over the rank and file—the real workers; for not only are the directors to dictate what particular piece of research a worker is to take up, but even the publication of the work is to be subject to the consent of the Board of Control.

For the scheme to be successful the directors must be men who are conversant with almost all the different branches of chemistry, and keep in touch with the most up-to-date advances in their science. Moreover, their minds are to be occupied with swarms of problems awaiting their day to be delivered to the care of the researchers. Lastly, they are to do justice, with the impartiality of a Privy Council Judge, to each individual worker according to his work and accomplishments. Even the greatest chemists of the age would hesitate to acknowledge that they are supermen of this description.

I am afraid that the proposed Service will simply be an asylum for a few officials in favour with the Government who find administrative work much more suited to the taste than bottle-washing and other humdrum work of the laboratory, and want to legalise the exploitation of the brain and labour of the young men just coming out of the universities full of new ideas and enthusiasm for work. We shall have a number of chemists working under a peripatetic director whose claims to the post will be his seniority, which in India often goes hand in hand with incompetence. I am afraid that the so-called research work will lapse into dull, mechanical, routine output, and will kill all enthusiasm and initiative on the part of the actual workers. They are even, as Prof. Soddy remarks, "to be deprived of what little satisfaction and independence genuine scientific work for its own sake affords," and in many cases will have to renounce their own work for the propitiation of the directors.

It seems to be supposed that since there is a Viceroy over governors, a governor over a number of magistrates, and a magistrate over a number of petty officials, so there must be an Imperial chemist over a number of provincial directors, directors over deputy-directors, deputy-directors over sub-deputy-directors, and so on. But in the republic of science the idea of such ordered gradation is absurd. Each branch of science, notably chemistry, has now grown so vast that a particular worker, however highly gifted, can honestly tackle and follow intelligently the developments of only a minute fraction of his subject. In the quest after truth and in the exploration of new paths of knowledge every worker has to find out his own way, and it not infrequently happens that a young and unknown worker may achieve much more brilliant results than men who have grown grey in the service of science. What is wanted is co-operation, provision for more ample facilities, and the opening up of better prospects for the earnest-minded and enthusiastic workers.

In India at the present state of her scientific development, the institution of the Chemical Service on the proposed lines will be not simply a blunder, but

a crime. There is not a single technical teaching institute in the whole of India. In the universities and Government colleges there is very meagre provision for research work. The universities are just trying to emerge from mere examining bodies into centres of education, and the demand for State aid for founding chairs in experimental and industrial subjects is very great. In Bengal, the most advanced province in India, there are, technically speaking, no endowed chairs at all (except one or two founded by the generosity of patriotic citizens). Altogether we have five or six high posts in the Government colleges, but the occupiers of these posts are required only to teach, and not to do any research work. The number of research scholarships is only three or four. But the man who has done good original work, and has the good fortune to be taken into the Service, has no better prospects before him than the man who has nothing to his credit except his original degree in the university; for under the Service system promotion is by favour and seniority, not by work and efficiency.

It appears to me that the most pressing needs for India at the present moment are: (1) The foundation by the Government of a number of chairs in various branches of pure and applied chemistry in the universities, and also a large number of readerships, assistant professorships, and research scholarships. (2) The establishment of a number of technical institutes and the strengthening of the laboratories and scientific libraries. (3) The organisation of the posts so created and of the posts already existent on a professional rather than on a Service basis. (4) The replacement of the director by boards of recruitment composed chiefly of university professors, one official, and one or two non-official representatives of the public. (5) The encouragement of the foundation of scientific societies.

There should be no watertight separation between those who are engaged in special types of work in Government research institutes and those working in the university laboratories. The officials in the research institutes should be asked to maintain a life-long connection with the university in some shape or other; and the researchers in the universities may be invited, when an occasion arises, to avail themselves of the opportunities afforded in the research institutes.

PRAFULLA CHANDRA RAY.

University College of Science, 92 Upper  
Circular Road, Calcutta.

### The Cost of Scientific Publications.

IN the timely leading article in NATURE of May 6 on the cost of scientific publications a note is struck which goes deep to the heart of many scientific workers—editors, secretaries, and members of councils on one hand, struggling to make inadequate funds meet the greatly increased expenses, and on the other the young investigators whose papers on the results of research are being held up by the impossibility of paying for publication. It is difficult to see the remedy at the moment. Most of us will, I think, agree with you that increased subscriptions to the publishing societies, on any adequate scale, would be a hardship to many, and probably defeat the end in view by choking off members. My experience as an officer of the British Association and of several scientific societies has shown me that it is difficult enough for our younger scientific workers, such as the demonstrator class at the universities, to afford the necessary expense of joining such societies and attending the meetings. Recognising the great pleasure and advantage that one enjoys in seeing and hearing the

senior men in the subject at the first scientific meetings one attended (British Association and Linnean Society), it would be deplorable that anything should be done to render it still more difficult than it is for the younger men of to-day to attend and take part in such gatherings.

You suggest that we may have been unduly extravagant in the past in the production of our scientific publications. This may have been so to some slight extent in a few cases, but I am by no means convinced that it is general, or material, and I would deprecate any drastic change. A judicious and kindly editor, secretary, referee, or communicator of a paper may usefully do something to moderate the exuberance of a youthful author and to keep note-book details within reasonable bounds; but the scientific value of a paper may be spoiled by ruthless excision. It is not enough, in many cases, to give end-results unless conclusions are to be accepted uncritically like text-book statements. To be of value to workers on the subject in the future, the details of experiments and the statistics of observations are essential. I see therefore no remedy except the provision of considerably increased funds for publication, not from the members of the publishing societies, but from outside sources—either private benefactors or the State.

We already have certain endowments and certain annual grants for the promotion of scientific research, but I would urge the emphatic opinion that adequate publication is an essential part—the necessary completion—of any important and successful research. Some administrators of scientific funds—for example, the trustees of the Percy Sladen Memorial Fund—have acted on that view, and so far as their limited resources allow they try to see through to complete publication the researches which they have supported; but, of course, this limits to some extent their activities in subsidising further research.

The provision of a considerable endowment from which grants might be given in aid of the publication of worthy papers by the principal scientific societies would be a noble benefaction which would doubtless have an effect upon the advancement of knowledge second only to the endowment of the research itself.

W. A. HERDMAN.

The University, Liverpool, May 9.

I HEARTILY agree with the opinion expressed in the leading article in NATURE of May 6 that a Government subsidy is necessary at the present time to lessen the sudden shock of war conditions to our scientific societies, especially in the matter of printing. The case was well put by Sir Joseph Larmor in a letter to the *Times* some months ago: the blow strikes at the very roots of scientific advance, and the risk of vital damage is thus the greater because roots are apt to be buried out of sight. If the mischief be not remedied in time, it will become clearly manifest only when the fruits begin to fail.

In societies with which I am connected, and especially in the British Association, anxious study has been made of all possible economies in printing, and anything which could be regarded as a luxury is being rigidly excluded; but the printing bill will still be heavy—much heavier than before—and the excess will inevitably be subtracted from funds formerly devoted to research. Moreover, we cannot be quite easy about the omission of the items regarded as luxuries. It is a common experience that life-long influences may hang on trifles, and the natural accretions which gather round an old-established association like the British Association are peculiarly liable to contain just

the trifles which may decide events. The scientific net can scarcely be cast too wide.

H. H. TURNER.

University Observatory, Oxford, May 8.

THE appearance of the leading article in NATURE of May 6 is extremely opportune. The question is one in which the scientific world is seriously concerned, and the possibility of the high cost of production stifling the progress of science must lead us to consider what means can be found to obviate so disastrous a calamity. It is unnecessary to quote evidence of the enormous increase in the cost of printing and publication at the present time—that is well known—but the question is accentuated by many indications that the cost will go higher in the near future.

It is very undesirable that such increased charge upon the funds of scientific societies should be met by raising subscriptions. No deterrent to join societies should be advocated, for science is advanced more by individuals than by the extent of their published papers.

The question turns upon the limitations which the present state of affairs must exercise upon publications. It is quite certain that some curtailment is necessary to avoid insolvency. It is patent to all that many papers are characterised by diffuseness and redundancy, as if the value of a paper was to be judged by its length. No one who wishes to keep *au fait* with current work has time to read such—conciseness and economy of expression in the treatment of scientific papers are the desiderata.

During the war we were rationed in our food for the body, with good rather than harm to ourselves. It is now necessary that the food for our minds should be rationed. The only possible way to carry on until things are easier is to limit publication to condensation or abstracts of papers, except in special cases. It is not an easy task to make abstracts of papers so as to retain all that is essential, and with some writers it is extremely difficult to condense their diffuse communications. The point might be met by putting the responsibility upon authors and limiting them to a definite number of pages, according to the character of the paper.

Let me give an instance where curtailment in publication has resulted in great economy without loss. A few years ago the volume of Greenwich Observations extended to as many as 1400 pages. The Board of Visitors decided that it was not necessary to publish a considerable mass of observations, as these could always be supplied from the Royal Observatory to anyone who wanted them, and by this means the volume was at once cut down to less than 600 pages.

E. B. KNOBL.

32 Tavistock Square, W.C.1, May 8.

THE leading article in NATURE of May 6 comes home to those of us who are concerned in carrying on the work of scientific societies. We are making laborious efforts to prune down diffuse contributions, and also endeavouring to increase our income by attracting new members. Many of us regard an increase in subscription rates as a device only to be contemplated as a last resort, and are in complete agreement with your article.

The Royal Meteorological Society is directly concerned with the question of accommodation, as well as of increasing costs of publication, and we should welcome any possibility of joining the privileged societies that are housed by Government. Failing a cash subvention for the one purpose, is it possible to

urge the Government to do something for us in the other direction? I should like to press for the removal of the Civil Service Commission from Burlington Gardens. Examinations might well be held in university rooms at South Kensington or elsewhere. I do not know how many societies could find adequate room in the building if it were thus set free; but it seems to me that assistance of this kind would be, at any rate for those of us who secured it, better than a subvention towards printing expenses, and possibly easier to obtain from the Government.

WALTER W. BRYANT.

Hon. Sec., Royal Meteorological Society.

Royal Observatory, Greenwich, S.E., May 8.

### Atomic and Molecular Forces and Crystal Structure.

ONE of the most difficult problems in the theory of chemical valency is to form a clear picture of the attractive forces between *similar* atoms. Lewis and Langmuir, in their theory of the cubical atom, have each attributed the single valency bond to the mutual action between a pair of electrons, and Langmuir has recently pointed out (NATURE, April 29, p. 261) that, as regards chemical considerations, such a pair of electrons may be regarded as revolving in the same orbit. This idea is closely allied to Bohr's construction for the hydrogen molecule. It should, however, be pointed out that such a construction leads to a strong paramagnetic property for molecular hydrogen, unless the electron motions are compensated by rotation of the nuclear charges. Such compensation is scarcely likely, since the magnetic moment depends on the area of the orbit described, and evidence up to date points to a nuclear radius of small order compared with that of the electron orbit, even though the latter be small compared with the conventional radius of the atom.

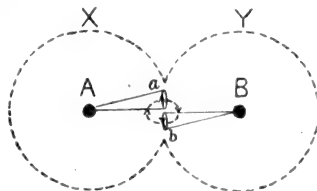

Model of hydrogen molecule.

Suppose X and Y are two exactly similar hydrogen atoms. Their nuclei are shown at A and B, and the negative electron orbits at a and b. The nucleus A may control the orbit a electrostatically and magnetically, while B controls b. As shown, there will be magnetic attraction between a and b, and possibly also a certain amount of electrostatic repulsion if each electron is not completely bound to its own nucleus. Equilibrium may be established for some such disposition of the charges as that indicated. We thus get a sort of fusion of the two hydrogen atoms which corresponds to the fusion of the electron orbits in Bohr's theory of the hydrogen molecule. In the present case, however, the fusion is controlled magnetically, whereas in Bohr's theory it is purely electrostatic.

The system depicted above gives a diamagnetic hydrogen molecule as required.

With more complicated systems, we can see, in a general way, how the small circular orbits will dispose themselves in pairs (Lewis and Langmuir) primarily under their mutual magnetic influences.

We might further expect that the crystallographic symmetry would be determined in a similar way by the magnetic forces due to the electrons in each atomic kernel. These electrons are drawn by mutual magnetic forces into a *space-pattern*, characteristic for each molecule, and the symmetry of this pattern is reflected in the crystalline symmetry. Thus the rigidity of the crystalline medium in different directions and the orientations of the planes of cleavage are defined in terms of the local magnetic forces (*cf. Science Progress*, No. 56, March, 1920, p. 588; *Phil. Trans. Roy. Soc.*, vol. ccxx., A, p. 247, 1920, particularly conclusion xii., p. 289; vol. ccxv., A, p. 79, 1915; vol. ccxiv., A, p. 109, 1914). The close connection between the department of crystals in a magnetic field and the disposition of the planes of cleavage, as observed by Tyndall, may then be explained.

Possibly each of the electron orbits shown in the above diagram may be identified with the ring-electron of A. L. Parson (*Smithsonian Miscellaneous Collections*, vol. lxx., p. 1, 1915). The conception of the hydrogen molecule and the line of argument leading up to it, as indicated by the above papers, are, however, quite distinct from those described by Parson.

A. E. OXLEY.

The British Cotton Industry Research Association, 108 Deansgate, Manchester, May 1.

#### Wasps.

If glory be known to insects; if solid glory be measured among them, as among us, by the difficulties surmounted, the female wasp is a heroine to whom the queen bee is in no way comparable.—RÉAUMUR.

HAVING spent some time in observing wasps during the past eight years, a few notes descriptive of the results may possibly have an interest at this season when the queen wasps are searching for suitable positions in which to found new colonies. The queens usually appear in the third or fourth week of April, and about a fortnight later than the humble bees. They spend a few days in feeding, and then fly about grassy banks and hedgerows, looking for a mouse's hole or some fissure or opening in the ground likely to prove desirable habitations. They are very fastidious in making a selection. I have specially constructed places for them, but hundreds of queens have declined the invitation. In twenty-seven cases, however, the queens took up residence, and the average date was May 6. The young wasps begin to show themselves in twenty-nine or thirty days, and then a few days later the queen remains at home. During the month elapsing before the small working wasps appear the queen works hard, and performs about 1136 completed journeys to procure material for constructing cells and obtaining food for herself and young. The number given is the mean derived from eight nests.

When a queen finds herself a proper site in which to build, it by no means follows that she will succeed in rearing a colony. Only one in three have overcome the difficulties (*i.e.* nine out of twenty-seven) in my garden, for trouble was occasioned by marauding intruders such as ants, earwigs, beetles, woodlice, etc. Besides, every man's hand is turned against the wasp, and numbers of queens are destroyed every spring before the embryo nests have developed.

As to the number of wasps composing a nest, this varies greatly. The strength is pretty fairly indicated by the number flying to and fro, and I have generally kept a record of the horary rate. In regard to three strong nests, the following were the figures on different dates, a wasp flying out being counted as one, and one going in as one, so that completed journeys would be half the figures given:

Date	Two nests in 1915. per hour	One strong nest in 1918. per hour
June 25	150	742
July 5	350	1,750
15	670	4,800
25	1,250	7,230
Aug. 4	2,500	8,400
14	3,900	11,150
24	5,200	12,060
Sept. 3	6,800	15,780
13	4,500	6,860
23	2,150	3,030
Oct. 3	1,250	1,620
13	650	280
23	250	very few

In September, 1918, I recorded an abnormal rainfall of 10.47 in., and this occasioned the virtual swamping of the nest I kept under observation in that year.

With regard to young queens, they begin to leave the nests at different times. In 1913 I noticed them first on August 21, in 1916 on August 19, and in 1918 on September 22. Two nests not at all abundant yielded in one case 990 queens and drones, and in the other 1400. A strong nest in 1915 yielded in all 1118 queens and 995 drones. There were ten tiers of cells in another nest, and six of the largest measured 10x8 in. These included 12,900 cells at least, and if each cell produced three generations this means an aggregate of nearly 40,000 wasps.

The most prevalent species of wasp in this locality is *Vespa germanica*, in the proportion of 3 to 1 of other varieties. Of twenty-seven nests, I had 1 *V. rufa*, 7 *V. vulgaris*, and 19 *V. germanica*. The latest colony I have seen in great activity was on November 5.

Wasps kill an enormous number of flies of all kinds. I found that the members of a moderately small nest of *V. germanica* in 1913 brought home at least two thousand flies per day. A very strong nest would account for twelve times as many. Man often misapprehends the benefits derived from certain forms of animate Nature. Birds are destroyed and noxious insects enabled to multiply. Efforts are ever being made to exterminate the wasp, and hordes of pestiferous flies naturally become the bane of our summers.

In spite of the popular belief, wasps are not nearly so bad-tempered and dangerous as they are supposed to be. If not obstructed or attacked they are quiet and harmless enough, and may be watched with entertainment. They are more industrious. Sir John Lubbock (later the first Lord Avebury) said: "I have been much struck by the industry of wasps"; and "On the whole, wasps seem to be more clever in finding their way than bees." Mr. T. A. Preston in the *Phenological Report for 1887* (*Royal Met. Soc. Journal*, vol. xiv., p. 56), speaking of the wasp, stated: "It seems far superior in intelligence to the bee."

W. F. DENNING.

#### Dr. J. G. Bartholomew and the Layer System of Contour Colouring.

To prevent misapprehension, it would have been better if, in the sixteenth line of the obituary notice which appears on p. 238 of *NATURE* for April 22, the word "introduced," used by Dr. Bartholomew himself in "Who's Who," had been employed instead of "devised." Dr. Bartholomew made no claim to be the originator of the idea of indicating differences of altitude by differences of colour, but he was the first to apply this method to topographical maps.

GEO. G. CHISHOLM.

The Prismatic Astrolabe.<sup>1</sup>

IN the process of measuring the places of stars on the celestial sphere, or in the converse process of using these measured places to fix the position of the observer upon the earth's surface, the astronomer has at his disposal two systems of reference lines or circles upon which to base his measurements. These are respectively the vertical great circles through his zenith and the small circles parallel to his horizon, the circles of equal altitude or equal zenith distance. Using the first system, his method is to time the transit of a star across a vertical circle, almost invariably the meridian circle passing through the north and south points. If, in addition to timing the transit, he measures the altitude, he gets a complete determination of the position of the star observed, and uses both sets of reference circles, the vertical circle for fixing the time of transit, and hence the right ascension of the star, and the horizontal circle for fixing the altitude of transit, and hence the star's declination. This is the ordinary observation carried out in the observatory with the transit circle or by the surveyor in the field with the theodolite. Another method of observation which gives the same quantities, though not in the same direct form, is by the use of an instrument adapted for the recording of transits across a horizontal circle of constant altitude. An instrument of this class is the almcantar, in which horizontality is secured by the device of floating the whole in a mercury bath, it being easily seen that if either the instrument or the bath is moved round, the telescope will maintain a constant angle with the horizontal, and the line of vision will therefore always intersect an almcantar or circle of equal altitude.

Another instrument of the same fundamental type, but of an entirely different form, is the prismatic astrolabe devised about twelve years ago by MM. Claude and Driencourt. This appears to possess great merits for survey work in the field, and has earned quite enthusiastic praise from those who have used it. The one objection to its more extensive employment, the arduous labour involved in preparing observing lists of stars, has now been removed by the publication of Messrs. Ball and Knox Shaw's "Handbook" and "Diagram." We will revert to this point later, but we must first give a short description of the principles of this interesting instrument.

It consists essentially of a telescope with a  $60^\circ$  prism in front of the object glass, and a mercury trough placed so as to reflect the star on to the lower face of the prism.

The prism can be placed in either of the two positions shown in Fig. 1, from which it will be

obvious that in both cases, on looking through the telescope at a star which is approaching and near to the altitude of  $60^\circ$ , two images of the star will be seen moving towards each other, and that these images will coalesce into one when the apparent altitude of the star is equal to the angle of the prism. In arrangement A the reflection is from the two outside surfaces of the prism, which must therefore be silvered; in B we get a total reflection from the two inside surfaces. It is further obvious that with outside reflection the angle of the prism can be given any value; the two star images will always coincide when the

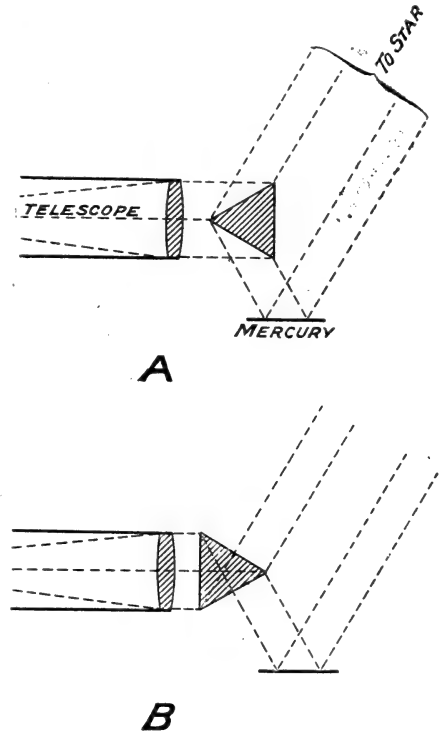

FIG. 1.—Principle of construction of the prismatic astrolabe.

altitude is equal to this angle, whereas if the rays traverse the glass they must enter and leave normal to the faces; the prism must therefore be equilateral, and stars can be observed only at the fixed altitude of  $60^\circ$ . The observation consists in the timing of the moment of coincidence of the two images. To allow them actually to coincide would, however, render accurate timing difficult, and far greater precision is obtained by giving the telescope a very small lateral displacement, so that the images pass close to, but not exactly over,

<sup>1</sup> "Description et Usage de l'Astrolabe à Prisme." By Claude et Driencourt. (Paris: Gauthier-Villars, 1910.)

<sup>2</sup> "Bestimmung fundamentaler Sternörter aus Höhendurchgangsbeobachtungen." By R. Trümpler. Nachrichten der K. G. der Wissenschaften. (Göttingen, 1913.)

<sup>3</sup> "A Handbook of the Prismatic Astrolabe." By John Ball and H. Knox Shaw. (Cairo: Government Press, 1919.)

<sup>4</sup> "Astrolabe Diagram." By John Ball. (Cairo: Government Press, 1919.)

each other; what is observed is, then, the transit of the two images over the same line of a horizontal graticule.

There is no appreciable difference in precision between the two prism arrangements. B has the apparent disadvantage that a closer adjustment of the telescope is required, the line of collimation must be perpendicular to the prism base, and the latter must be truly vertical, whereas with A the horizontality of the telescope and the symmetrical inclination of the prism faces are immaterial. On the other hand, from the practical surveyor's point of view, the use of the easily damaged silvered faces is inexpedient, and the method of internal reflection preferable. The disadvantages attaching to the necessity of more careful adjustment of telescope and prism are, moreover, more apparent than real. It must be remembered that while the actual observation involves no reading of graduated circle or micrometer, a horizontal circle is required for the purpose of directing the line of sight, so that the desired star will cross the field. The telescope and circle must therefore be levelled and adjusted as with a theodolite, and the extra labour involved in the setting of the prism is a very small matter.

As already stated, the preparation of an observing programme involves somewhat lengthy computations. These have now been made, and are available for the use of observers within a wide range of latitude. The "Handbook of the Prismatic Astrolabe" gives a succinct description of the smaller survey form of the instrument, its construction and method of use, and contains tables of all the Nautical Almanac stars down to the fourth magnitude which cross the altitude circle at azimuths suitable for observation for each degree of latitude between  $55^{\circ}$  S. and  $55^{\circ}$  N. This list gives sufficient stars for all field work except geodetic survey of the first order, for which more and fainter stars would be wanted. For these, reference must be made to the "Astrolabe Diagram," giving, for the same limits of latitude, a series of graphs from which the azimuth and time of any star crossing the altitude circle can be plotted. A comparison of the relative accuracy of the astrolabe and other survey instru-

ments seems to indicate that it is probably capable of somewhat greater precision than a theodolite of similar telescopic power; and there is no doubt that in it we have a valuable addition to the resources of the surveyor. It cannot, however, take the place of the theodolite, being capable of determining only latitude and time, not azimuths or angles. It has therefore been urged as an objection to its more extended use that as a survey party must in any case carry theodolites the astrolabe could be taken only when the added labour of transport is unimportant. Apart from the fact that the addition of thirty pounds to the baggage of a survey expedition would be found burdensome only in quite exceptional cases, this objection does not appear to have any validity. A theodolite is capable of conversion into an astrolabe by the addition of the prism and mercury trough, and it would be easy to design these so that they could be clamped on to the front of the telescope, and the prism levelled in a minute or two. The extra weight would then not exceed a few ounces.

An attempt has been made, not, however, yet carried very far, to develop the use of this instrument for the astronomical problem of the determination of star places of high-order precision. It is very doubtful if it presents any real advantages for this work. The difficulty of making true plane surfaces is well known, and in an instrument of large aperture and high magnification the inclusion of flat reflectors in the optical system is undesirable. Furthermore, the two star images are not symmetrical, each being formed by only half the object glass, and the results show a magnitude equation, or variation with the brightness of the stars observed. This has not been specially studied in the portable survey patterns, but would probably be found even with them. Trümper (*loc. cit.*), using an aperture of only 4.7 cm. and a focal length of 50 cm., found it conspicuously. It would increase rapidly with increase of aperture. For the present we must regard the astrolabe as a surveyor's instrument, capable in his hands of useful service, and leave any possible application to observatory work for further investigation. E. H. H.

## The Heart of a Continent.<sup>1</sup>

By DOUGLAS CARRUTHERS.

"CENTRAL ASIA" used to conjure up in the imagination thoughts of lonely and mysterious frontiers between three great Asiatic Empires, of strange doings in unheard-of valleys on the Pamirs, of long-dead conquerors, and of strange capitals at the back of the world. Even now, in 1920, the heart of Asia is a storm centre, for it forms the meeting-place of the civilisations of the remote past—China; of the present—Great Britain; and of the future?—Bolshevism.

Great happenings have been in middle Asia—

<sup>1</sup> "Through Deserts and Oases of Central Asia." By Miss Ella Sykes and Brig.-Gen. Sir Percy Sykes. Pp. xii+340. (London: Macmillan and Co., Ltd., 1920.) Price 21s. net.

unheard-of movements, unimagined miseries—during the past six years, when all men's thoughts have been concentrated on Europe and the Middle East. The remote highlands and deserts of Asia did not escape the turmoil. The most secluded and most apathetic native races felt the ripples of the storm in Europe. The confines of China, India, Russia, and Afghanistan have returned, by a strange coincidence, to their former place as, what may well be, the centre of a prolonged struggle, not between East and West, but between right and wrong.

Chinese Turkestan, or Kashgaria, is that

part of middle Asia which forms the most westerly province of the Chinese Empire, under the title of Hsin-Chiang, or the New Province, for it is of comparatively recent occupation (since Keen-Lung, 1758). Although an integral part of the Celestial Empire, it is actually Central Asian in physical features, character, and inhabitants. This desert plain is girt on three sides by great mountain walls, yet these barriers seem to be less of a hindrance to man than is the endless desert zone which cuts it off from China proper.

The Chinese rule, but the natives look to Mecca, not to Peking, and trade with Moscow and Peshawar rather than with the cities of China. The oases belong to the group which extends from Khotan, in the east, to Bokhara, in the west.

Chinese Turkestan, then, is a colony where mild and unwarlike farmers, probably the most phlegmatic of all peoples in the world, are ruled by a handful of Chinese officials. On the north and west was a great and virile Russian Empire ever ready to overflow still further eastwards and southwards, while on the south great mountain walls arose behind which ruled the Emperor of India. Kashgar, the capital, was the only place in Central Asia where Great Britain maintained a representative. From the Caucasus to Siberia, and from Siberia to China proper, we had no official residents. It was to this far-off city that the authors went in 1915, Sir Percy Sykes to act for Sir George Macartney, the Consul-General, on leave.

We have a general account of the journey out, by way of Norway, Sweden, and Finland, Petrograd, Moscow, Tashkent, and Osh, followed by chapters on life at the British Consulate, around Kashgar, and trips to the Russian Pamirs and to the great oases of Yarkand and Khotan. These chapters, by Miss Ella Sykes, are ably supplemented by her brother's (Sir Percy Sykes) section, which deals with the geography, government, and commerce of the district, and also gives us an historical sketch which is admirable in its brevity and conciseness, for it covers in three short chapters a period from somewhere about the third century B.C. up to 1915! It should be realised that Turkestan history was shaped by Hun, Chinese, Turk, Arab, and Mongol, while the romantic names of Kutayba, Jenghiz, Tamerlane, Amursana, and Yakub Beg

figure largely. Sir Percy Sykes traces the story right up to the year of his visit, and by no means the least interesting part is that which deals with the modern period. His final sentence contains much of import: "The future of Chinese Turkestan is not finally settled, but the World War, which has temporarily broken up the Russian Empire, will undoubtedly stimulate China to move along the path of progress. If so, there is hope that the condition of this outlying province of her Empire may benefit, more especially by improved



FIG. 1.—A hunting eagle. From "Through Deserts and Oases of Central Asia."

communications. At the same time, there are many parts of Asia which have reason to envy the peace and plenty enjoyed by the inhabitants of Chinese Turkestan." The chapter on "The Kashgar Farmer" is noteworthy; it shows the difference between this desert land and others. Whereas other arid regions are dependent on scanty and uncertain rainfalls, the great oases of the low, hot plains of Turkestan live by a sure and abundant water supply brought down from

the giant glaciers and snowfields which wall them in on north, south, and west. A certain livelihood, an ample and cheap food supply, and complete safety have produced a contented race, devoid of ambition and easily ruled. The town-folk are much the same. Kashgar and Yarkand are still great trade centres. Since Marco Polo's day, "from this country many merchants go forth about the world on trading journeys." The old

Pamirs, while Sir Aurel Stein crossed the plateau from east to west, and penetrated to the amazingly interesting regions of Roshan and Darwaz.

The chief interest of this book lies in the fact that it recounts the impressions of a resident in a country which has so far been described only by the passer-by. Even a glimpse of life in the only city of Central Asia where the British Empire retains a representative should commend it to the



FIG. 2.—Cart used in the Osh district. From "Through Deserts and Oases of Central Asia."

silk route ran the length of the country. All trade between China and Western Asia passed through Kashgar.

The volume ends with an account of a visit to the Russian Pamirs. For a long time the "Roof of the World" has been a forbidden land to the English hunter, but the war proved that Russian designs on India were a bogey. The author was permitted to travel and shoot in the heart of the

reader. For years the post has been held by Sir George Macartney. Far removed from the nearest Englishman, cut off from India, isolated and alone, he has upheld the honour of the Empire, using prestige instead of Cossacks, and relying on his unrivalled knowledge of the East. Sir Percy Sykes had his work cut out to fill the gap satisfactorily, but his life experience in Asia served him well, and he has allowed us to see something of it.

### The United States National Research Council.

By PROF. VERNON KELLOGG.

THE National Research Council is a co-operative organisation of men of science in America for the special purpose of promoting fundamental research in the physical and natural sciences, the application of scientific knowledge in the industries, and the training of research workers, all for the sake of the general advancement of science and the increase of the national strength and well-being. It was organised in 1916, under the auspices of the National Academy of

Sciences, especially to help make the scientific resources of the country available to the Government in the solution of pressing war-time problems involving scientific investigation. As now reorganised on a permanent peace-time footing, its membership of about 250 is largely composed of duly appointed representatives of about forty major scientific and technical societies of America, with a group of administrative officers and necessary office staffs, resident in Washing-



ton. These officers are appointed for but one year at a time, and it is expected that most of the offices (chairmen of divisions, etc.) will be filled in rotation by men drawn from the scientific faculties of the universities, the staffs of large scientific institutes, and the research laboratories maintained by the industries.

Although during the war the Council was largely supported by the Government, it is now entirely supported by private funds. A gift of 5,000,000 dollars has recently been made to it by the Carnegie Corporation. Part of this money, perhaps a million dollars, will be used to erect a building in Washington for the offices, conference rooms, etc., of the Council and the National Academy of Sciences, and the remainder will constitute a permanent endowment for the Council. This endowment will provide for the administrative expenses of the organisation, leaving the funds necessary to aid in the support of the large co-operative scientific projects of research, which the Council hopes to stimulate or establish, to be found, as the needs require, from wealthy men or philanthropic foundations interested in the promotion of the investigation of the fundamentals of science and from the industries interested in promoting the extension of scientific applications.

The Council as at present organised includes thirteen divisions, seven representing the various major lines of science and technology, and six representing general relations. The first seven are divisions of the physical sciences, engineering, chemistry and chemical technology, geology and geography, the medical sciences, biology and agriculture, and anthropology and psychology. The general relations group includes a division of foreign relations, a Government division (including representatives of each of the major scientific bureaux included in the Government Departments of War, Navy, Commerce, Labour, Agriculture, State, and Treasury), a division of States relations, one of educational relations interested especially in the research conditions and activities in the colleges and universities of the country, a division of research extension especially devoted to the extension of research to the industries, and a research information service intended to act as a general national clearing-house for information concerning the scientific *personnel* and scattered research work of the country.

Affiliated with these various divisions are many special committees and sub-committees which concern themselves with various special phases and specific projects of scientific investigation. The present number of these committees approximates fifty. There is also a special Research Fellowship Board, which has at its disposal through the

period from May 1, 1919, to June 30, 1925, the sum of 500,000 dollars, appropriated by the Rockefeller Foundation for the Maintenance of National Research Fellowships in Physics and Chemistry. Thirteen of these fellowships have so far been instituted.

The National Research Council is thus neither a great operating scientific laboratory nor an organisation possessing large funds from which to make direct gifts to individual scientific investigators or scientific laboratories, but an institution for the purposes of stimulating and organising scientific research in America, and of promoting international scientific relations in all possible ways. It is specially interested in organising scientific effort along co-ordinated co-operative lines. It hopes to encourage vigorous attack on major problems too large and many-sided for the individual investigator working alone, and often requiring the co-operation of numerous investigators and laboratories representing several different but allied lines of science. In the applications of science it is especially interested in such problems as bear directly on the promotion of the national strength and well-being.

Among the many projects now in course of organisation or actual development are an extensive study of food and nutrition in charge of a committee including many of the leading American physiological chemists and experts in human and animal nutrition; a study of high explosives, begun during the war; the preparation of critical compendia of physical and chemical constants; a study of the fundamental scientific problems of baking, of ceramics, of steel alloys, of synthetic drugs, of the chemistry of colloids, of sewage disposal, of forestry, of fertilisers, etc. An extensive investigation of tropical biology, including especially tropical medicine, is in course of organisation. A detailed survey of the research conditions in all the colleges and universities of the country, in which research work is now being done or probably can be done in the near future, is in active progress. A committee on mental measurements has recently completed an elaborate series of trials of group tests on several thousand children, and has prepared, and is about to publish, a set of recommended tests for use for classification and grading in the common schools of the country. These tests are adapted from the sets developed by the Council's special psychological committee on Army tests during the war. Altogether, the Council is getting under way a good deal of important research work, and promises to be an organisation of much influence in the promotion of American activity in the advancement of science.

### Obituary.

MARLBOROUGH R. PRYOR.

SOME fifty years ago Marlborough Robert Pryor, who died at Weston Park, Stevenage, on April 3, was well known in scientific circles at Cambridge, and seemed likely to rise to a high

position in those studies. He was a man of many interests and great adaptability of mind, who, though he was rather early diverted to executive business, never lost his interest in those parts of it which were connected with science. Educated

at Eton, he entered Trinity College, Cambridge, taking his degree as B.A. in 1870, and that of M.A. three years later. It is rather remarkable that he did not "go in for honours," for he was then so conspicuous a student of natural science as to obtain successively a scholarship and a fellowship by examination in those subjects, being in each case the first elected to these distinctions in Trinity College.

In Pryor's days natural science was beginning to look up in Cambridge, though it did not yet lead directly to a degree, for its first Tripos examination, when the list was headed by Prof. Liveing, was in 1858, four men being in the first class, and two in the second. Until 1869 the total number in all the classes rarely exceeded ten, and sometimes sank down to four, and on three occasions no one was in the first class. Things have changed since then, for in the days immediately before the war there would be some 120 or more in the three classes, as there doubtless will be again. But from 1870, when Pryor's name would have appeared had he gone in for the examination, the names of men who have since won distinction are more often found in the lists—such as H. Darwin (now Sir Horace); W. M. Hicks, of Sidney, who turned from science to theology and became Bishop of Bloemfontein; Garrod and Lydekker, Teall, Martin, Frank Balfour, M. Hartog, and Sollas, now professor of geology at Oxford, not to mention others.

Pryor, however, so far as I know, wrote no papers of importance on strictly scientific matters. I do not find his name in the earlier volumes of NATURE, which began to appear in November, 1869, nor is it in my catalogue of collected papers on scientific matters, which goes back to a still earlier date. Yet he won distinction at Cambridge, not only by his academic successes at Trinity, but also from all who met him there in scientific society. One could not be long with him without getting the impression that one was talking with a clear-headed man of strong intellect, who looked at things all round before he spoke of them, and expressed his views quietly and deliberately. He had a large store of knowledge and was a keen critic, yet never anything but kindly. He took a special interest in ornithology, and was a frequent member of that circle of young men of science which the late Prof. Alfred Newton delighted to gather round him on Sunday evenings after dinner in his rooms at Magdalene, where much tobacco was consumed and any amount of natural history was talked. These gatherings indirectly extended the interest felt in that subject in Cambridge, and perhaps were an even greater incentive to its study than any formal teaching by the professor.

Soon after taking his degree Pryor left Cambridge and entered on a business career in London, settling down near Stevenage, where he inherited from an uncle an estate called Weston Park. At first he joined a firm of South American merchants, and became a director of some important joint-stock companies. The two with which he

was most closely and permanently connected—and they were businesses requiring especially a clear head and a sound judgment—were the Sun Insurance Office and the Sun Life Assurance Society, to each of which he became chairman, holding those offices until 1918. The prosperity of these institutions was the chief work of his later life, and he carefully studied the problems of insurance in all its branches. It is said that his views were strong and his business ideals high, and that nothing short of the strictest practice would ever satisfy him. But he was regarded with real affection by the other members of the boards, and to the younger of them his great store of knowledge on all sorts of subjects was a constant cause of wonder. Still, he kept up his connection with his college and his university, for he frequently came up to be present at special social gatherings in the former, and in later years took an active part in the endeavour to collect funds to advance teaching in the latter, which was gratefully acknowledged in a resolution passed the other day. Besides all this, he was a good Spanish scholar, and had paid much attention to church architecture, especially in Hertfordshire. He married Miss Alice Solly, of Serge Hill, in that county, and has left six daughters and one son, Col. Pryor, D.S.O., who served in France and Italy.

So, to the regret of many friends, Marlborough Pryor is gone. He has left no conspicuous record in the scientific annals of his generation, as once seemed probable, but no one can say that his life was wasted, because, while some men can serve science the better by taking a prominent lead in this or that branch of it, others can do it by the catholicity of their knowledge and interests. Marlborough Pryor was among the latter, and each has his work to do; each is helpful to his generation; for the one raises the towers; the other, as he did, builds the walls.

T. G. BONNEY.

Mr. J. A. POTT, who died recently at the age of fifty-five, was a scholar whose importance as a moving force in his generation cannot be estimated by the popularity of his work during his lifetime. As an archaeologist he contributed to the *Antiquary* for 1904 two articles on Neolithic and other remains found near Harlyn Bay, Cornwall. He made the first translation into English of two important treatises of Thomas à Kempis, entitled "The Founders of the New Devotion," and the "Chronicle of the Canons Regular of Mount St. Agnes." These were followed by two series of graceful renderings of poems from the Greek Anthology. Just before his premature death, due to overwork in recruiting during the war, he had completed a verse and prose translation of the Epigrams of Martial, which will shortly be published. A fine scholar and man of letters, Mr. Pott exercised an inspiring influence over a large group of friends drawn from circles largely differ-

ing both socially and intellectually. The charm of his personality depended on the fact that, happy as he was himself in living, he was still happier in making his life a blessing to others.

MR. A. H. HIORNS, who died on April 17, was for many years head of the metallurgical department of the Birmingham Municipal Technical School. He commenced teaching metallurgy about 1875 in branch evening classes under the auspices of the Birmingham and Midland Institute. Later he was transferred to the central school, and was so successful as a teacher that he was granted leave of absence in 1882 and 1883 to study at South Kensington under Sir W. Roberts-Austen. On his return to Birmingham he organised a new metallurgical department at the Birmingham and Midland Institute. As the work expanded, it was transferred to the Birmingham Municipal Technical School, where the enthusiasm and geniality of Mr. Hiorns gathered an ever-increasing number of students. Mr. Hiorns contributed papers on metallurgical subjects to various scientific societies, but was best known as the author of a number of students' text-books, which have had a wide circulation, and include "Practical Metallurgy and Assaying," "Metallography," "Metal Colouring," "Iron and Steel," "Mixed Metals," etc. He retired from teaching some eight years ago, and the latter part of his life was spent chiefly in rural pursuits.

T. T.

MR. T. W. BACKHOUSE, of West Hendon House Observatory, Sunderland, who died on March 13 in his seventy-eighth year, devoted a large part of his life to scientific pursuits, and carried on for more than sixty years a series of meteorological and astronomical observations. He was a frequent contributor to our correspondence columns, and a most successful student of those minute differences in the appearance of the sky or of the atmosphere that escape untrained observers, who prefer to consult the barometer rather than natural phenomena. Four volumes of Publications were issued by him from his observatory, and the last, in 1915, summed up the accumulated records, extending over fifty years, of his skill and vigilance as an observer. In 1912 Mr. Backhouse published a valuable new catalogue of 9842 stars, containing all stars conspicuous to the naked eye. The catalogue was designed specially to afford assistance in the observation of meteors, to which Mr. Backhouse himself gave much attention; but it has been found useful by many other astronomers. His last communication was on the subject of the January meteors (Quadrantids) of 1917 (*NATURE*, vol. c., p. 313). Mr. Backhouse became a fellow of the Royal Astronomical Society in 1873, and of the Royal Meteorological Society in 1892.

NO. 2637, VOL. 105]

## Notes.

THE PRINCE OF WALES having graciously consented to be nominated as an honorary fellow of the Royal Society of Edinburgh, the nomination was made at the last ordinary meeting on May 3, and the election will be carried out, according to regulation, at the ordinary meeting to be held on June 7.

THE Croonian lecture of the Royal Society will be delivered by Prof. W. Bateson on June 17 upon the subject of "Genetic Segregation."

MR. J. H. LESTER has been elected chairman of the chemical section of the Manchester Literary and Philosophical Society for the session 1920-21.

NOTICE is given by the Chemical Society that applications for grants from the society's research fund must be made, on forms supplied, to the assistant secretary, Chemical Society, Burlington House, W.1, on or before June 1.

MR. WILFRED H. PARKER has been appointed director of the National Institute of Agricultural Botany. The institute, including the Official Seed-testing Station for England and Wales (the director of which is Mr. Saunders), will be housed at Cambridge in a large building which will be completed by next summer. Meanwhile the temporary office of the institute is at 72 Victoria Street, London, S.W.1.

THE Salters' Institute of Industrial Chemistry invites applications for fellowships of the annual value of 250*l.* from those who in October next will have completed three years' training in chemistry and desire ultimately to enter upon an industrial career. The applications, including particulars of the candidates' training and war service, must be sent to the director of the institute, Salters' Hall, St. Swithin's Lane, E.C.4, by, at latest, July 1.

A REPORT by Dr. A. Mearns Fraser, Medical Officer of Health for Portsmouth, upon the prevention of venereal diseases was noticed in *NATURE* of March 25 (p. 114). The Society for the Prevention of Venereal Disease now informs us that the Portsmouth Borough Council has decided that steps shall be taken to educate the male inhabitants of the borough in the facts put forward by Dr. Fraser as to methods of prevention by immediate self-disinfection.

SCIENTIFIC visitors to the Royal Academy's exhibition this year will be much interested in the fine presentation portrait of Sir Clifford Allbutt painted by Sir William Orpen. The picture hangs in the first gallery and bears the inscription: "Sir Clifford Allbutt, K.C.B., M.D., F.R.S., Regius Professor of Physic in the University of Cambridge; President of the British Medical Association. Presented to him by his Profession, 1920." A proof of the mezzotint engraving of the portrait is exhibited in the room devoted to engravings, drawings, and etchings.

THE Department of Scientific and Industrial Research announces that the third Conference of Research Organisations will be held to-morrow,

May 14, at 3 p.m. in the lecture theatre of the Institution of Civil Engineers, Great George Street, Westminster. An introductory address will be given by the Marquess of Crewe, who will be chairman of the conference, and it will be followed by papers on "The Relation of Research Associations to Existing Institutions for Research," by Dr. A. W. Crossley, and on "The Staffing of Research Associations: Salaries and Superannuation," by Mr. J. W. Williamson.

In an article in the *Times* for May 3 Mrs. Ayrton presents what must appear to be a formidable indictment of the War Office for neglect in regard to the use of the anti-gas fan. It is stated not only that there was great difficulty in getting the device considered, but also that, after its efficacy had been demonstrated, its adoption was delayed. Further, it is alleged that the supply of fans was never adequate, that the method of using them was never properly taught, and that to the last less efficacious measures were adopted in preference to the fan. It is suggested that this neglect on the part of the War Office entailed death to numbers and untold suffering to countless others. Many charges of grave neglect have been levelled against the War Office. The present one, however, is peculiar in being a charge, not against the military element, but rather against the experts who were associated with the Gas Service. It is well known that the Anti-Gas Service of the Army was, in the field, in the research laboratory, and on the instructional side, in most of the chief appointments, staffed by well-accredited men of science, and that both at the central laboratory in France and in London competent men were keenly on the alert to test and improve defensive measures. In view of this, it appears scarcely likely that Mrs. Ayrton's allegations will be accepted without question, and it is much to be desired that some plain statement of the facts should come from the men of science whose intelligence and humanity are implicitly assailed in her article.

On the occasion of a luncheon given by the *Times* last week to celebrate the first attempt to fly from Cairo to the Cape, Dr. P. Chalmers Mitchell, who accompanied Capts. S. Cockerell and F. C. Broome as scientific observer, made some interesting remarks on the value of aviation in scientific exploration. The aviator has an opportunity denied to the explorer on land of seeing the general lie of the country and the broad features of its topography. The view of a large tract of country makes it possible to appreciate and explain features which would be puzzling when seen piecemeal or partially by the surface traveller. This applies particularly in a country such as Africa, where much detailed exploration has been done in places before the broader features are understood. Dr. Chalmers Mitchell believes that geographical and geological exploration will benefit widely by the use of aeroplanes. Another interesting point he emphasised was the unexpected number of natural aerodromes which the flight revealed. Several times when the machine was forced to make unexpected descents, suitable places were found. Dr. Chalmers Mitchell

pointed out that a re-survey of the Cairo-Cape route from the air made in order to locate these natural aerodromes would save the cost of many intermediate stations that are being planned.

THE trustees of the British Museum have arranged to purchase the whole of the collection of Lower Palæozoic fossils made in the Girvan district by Mrs. Robert Gray, of Edinburgh. The number of specimens is more than 38,000. Fossils from these rocks are scarcely represented at all in the British Museum, and very meagrely even in the Scottish museums. Apart from the specimens collected some fifty years ago by Mr. Robert Gray and now in the Hunterian Museum, Glasgow, there is little worth considering outside the present Gray collection. Mrs. Gray has diligently continued the work begun by her late husband, so that the whole series is admirably represented in her collection. She has also taken pains to get her material described, and it forms the foundation of a long series of memoirs. Noteworthy among these are the well-known work by Nicholson and Etheridge on "The Silurian Fossils of the Girvan District" (1878-80), the Palæontographical Society's monographs by Cowper Reed, W. K. Spencer, and Ida Slater, and the large memoirs in the Transactions of the Royal Society of Edinburgh by Reed and by Bather. In spite of these publications, the collection is known to contain undescribed material scarcely less in extent and importance. The situation of the rocks near the northern limit of the Ordovician and Silurian sea, and the richness of certain beds of a facies different from their representatives elsewhere, have led to the inclusion of a number of rare forms in the fauna. Among these are a new and strange cystid, *Cothurnocystis*; starfishes carrying back to the Ordovician plans of structure previously regarded as Devonian; echinoids among the oldest known and of a type hitherto unrecognised before the Upper Silurian; a remarkable edrioasteroid, *Pyrgocystis*; beautiful examples of the supposed cirripede, *Turrilepas*; and two new species of the very rare Helminthochiton.

THE thirty-first annual Conference of the Museums Association will be held in Winchester on July 5-8, under the presidency of Sir Martin Conway, Director-General of the Imperial War Museum. The meeting this year is a joint conference with the French Museums Association, and among those who have signified their intention of attending are M. Hughes Leroux (senator), M. le Prof. Louis Roule (Paris Museum), M. le Prof. Vayssièrè (president of the French Museums Association), M. Fernand Guey (treasurer of the French Museums Association and director of the Museum of Fine Arts at Quimper), Dr. A. Loir (secretary of the French Museums Association), and a delegate from the French Association for the Advancement of Science. The mornings during the conference will be devoted to the reading and discussion of papers, and the afternoons to visits to places of special interest to museum workers. The subjects for discussion at the conference are: (1) The Public Libraries Act of 1919, and its effect on the future policy of museums; (2) the status and remuneration of museum curators and their staffs; and

(3) the desirability of a diploma for museum curators and the necessary course of training. In addition, the following papers have been promised: (1) "The Lighting of Picture Galleries and Museums," by Mr. Hurst Seager, vice-president of the New Zealand Institute of Architects; (2) "The Selection of Pictures for Municipal Art Galleries," by Mr. E. Howarth, curator of Sheffield Public Museums; and (3) "A Central Government Department for Museums and Art Galleries," by Dr. F. A. Bather. Mr. R. W. Hooley, Earlescroft, St. Giles's Hill, Winchester, has undertaken the duties of local secretary, and a small committee under the chairmanship of the Rev. S. A. McDowall, Winchester College, has been formed to arrange the programme of local visits.

THE next informal meeting of the Chemical Society will be held at Burlington House on Thursday, May 20, after the conclusion of the formal business of the ordinary scientific meeting. An exhibit demonstrating the methods of controlling soil organisms now being investigated at the Rothamsted Experimental Station will be shown by Mr. and Mrs. D. J. Matthews. This exhibit will include specimens of the soil organisms and the cultivation of these on artificial media. The effect of toxic substances on organisms and of the relationship of chemical composition to toxicity, with specimens illustrating effective doses of certain typical substances with a given quantity of soil, will also be shown. Dr. Marie Stopes will exhibit specimens and microscopic slides of fusain, durain, clarain, and vitrain, the four main constituents of banded bituminous coal. Mr. E. R. Thomas will show some experiments illustrating the influence of temperature, concentration, solvent, constitution, and catalyst on the rate of chemical change.

A SHORT article in our issue of March 11, p. 56, describing a magnetic disturbance which occurred on March 4-5, mentioned that aurora had been observed at Aberdeen on March 4, but considerably earlier than the commencement of the disturbance, and so presumably not directly connected with it. This seems to have been the only observation of aurora in this country on either March 4 or 5. A letter, however, which we have received from Prof. A. S. Eve, of Montreal, mentions a brilliant aurora as having been observed there between 1 a.m. and 2 a.m. G.M.T. on March 5, and so synchronous with the magnetic storm. Commencing with isolated patches, the aurora appeared for a short time in the form of an arc, and ended in a curtain display. This incident leads Prof. Eve to inquire whether there is in existence "an organisation for recording, with accurate timing, auroræ in both northern and southern hemispheres, and, if so, where can the records be obtained?" So far as we are aware, no such records exist. The question seems to merit the consideration of the recently instituted Section of Terrestrial Magnetism and Electricity of the International Geodetic and Geophysical Union.

THE Marlborough College Natural History Society, which has been in existence for fifty-six years, is a notable example of the good work which an association of schoolboys can perform under competent guid-

ance. The report of the society for 1919 announces the retirement from the post of president of Mr. J. C. Alsop, who carried on the work with success during the period of the war. In botany 205 species, in ornithology 85, and in entomology 223 have been recorded. Lichenology shows a good record, though the subject has been little worked in this country, but the monograph on British species recently published by the British Museum and edited by Miss A. L. Smith may stimulate interest. A good course of lectures delivered by eminent specialists and numerous papers read by members during the year form an interesting feature of the report, which is carefully prepared, and furnishes a good example for the authorities of other schools in Great Britain.

DR. CHARLES SINGER has reprinted an address delivered before the British Academy (Proceedings, vol. ix.) on "Early English Magic and Medicine." The history of medicine is sharply divided into the Dark Age period and that which followed the arrival of the Arabian learning, the remnant of Greek science which survived in the Moslem world. Dr. Singer deals only with the pre-Arabian material. In England the latter has survived from two channels, manuscripts and folk-lore. Greek medicine reached the barbarian peoples of the West at a time when the scientific system of Greece was in complete decay, and it came through Latin channels. In dealing with magic Dr. Singer remarks that ecclesiastical elements are found throughout the whole corpus of Anglo-Saxon medicine and magic. Native Teutonic magic and medicine may be distinguished from imported elements of classical, ecclesiastical, or Salernitan origin by the presence of four characteristic elements: the doctrine of specific venoms, the doctrine of the Nines, the doctrine of the worm as a cause of disease, and, lastly, the doctrine of the elf-shot—all of which are fully described. "The Celtic influence in the Anglo-Saxon material is elusive and yet pervasive, but the difficulty of tracing it may be a result of the common heritage of the two cultures and the common external influences to which they were both subjected."

MESSRS. SUTTON AND SONS, Reading, have published an interesting contribution to the literature on seed electrification. This bulletin (No. 11) presents the results of a number of germination and field tests carried out in 1919 with seeds of carrot, swede, cabbage, and mangold. The best-known process of seed electrification, viz. the Wolfryn process, consists in immersing the seeds in a solution either of common salt and water or of calcium chloride and water, through which an electric current is then passed. After this treatment the seeds are dried at a temperature of 100° F., and they are then ready for sowing. Obviously two processes are here involved, seed immersion and seed electrification, and the Reading experiments were designed primarily to test the value of the Wolfryn process, and secondarily, if there are advantages, to decide whether they are due to the immersion, to the electrification, or to both agents combined. Tests were made with untreated seeds, with seeds electrified by the Wolfryn process, with seeds soaked in a solution of sulphate of am-

monia, and with seeds soaked in a solution of salt and water, the strength of the solution being the same as that used in the Woflyrn process. After immersion the seeds were dried at 100° F. and then sown. Regarding the tests as a whole, they do not reveal any advantage from seed electrification, the only possible exception occurring in the case of mangolds, where the germination of the electrified seed was 94 per cent., compared with 82 per cent. for the untreated seed and 86 per cent. for the seed soaked in the salt solution, while in the field tests the electrified mangold seed yielded 62 lb. per pole more than the untreated seed. In all other cases either the electrified seed gave a lower yield than the seeds treated in other ways, or the increase following electrification was so small as to be negligible.

THE Government of India is now considering the principles under which the census of 1921 is to be undertaken synchronously with those of the nations of civilised Europe. Hitherto the reports have included much valuable anthropological material, but this is found to be in practice of little value to the bureaucracy. The time, it is said, has come for a scientific demographic census, one which collects such statistical details as will throw light on all the problems of population, such as the causes which increase or decrease peoples or sections of peoples in numbers, by sexes, in efficiency and capacity for progress. More, we want to know the real causes why the Moslem population increases at a faster rate than the Hindu, and the causes of the excess of male births, of the variability of sex mortality, and of polygyny and polyandry. To carry out such a scheme it will be necessary to work in close collaboration with European experts. In former census reports the mass of anthropological material made them a happy hunting-ground for European workers. If future reports are to be confined to inquiries of a sociological kind, we trust that efforts will at once be made to continue the ethnological survey on wider lines. The scheme initiated by Lord Curzon has led to little result; and while Madras, the Central Provinces, Burma, and the Punjab have issued some important publications, practically nothing seems to have been done after twenty years' incubation in Bombay, Bengal, and the United Provinces.

THE *Meteorological Magazine* for April contains an article on "Climates of the British Empire Suitable for the Cultivation of Cotton," by Mr. C. E. P. Brooks. Details with respect to rainfall and temperature of a cotton-growing climate are given for various British Possessions and Colonies. It is stated that the essential features are: (1) The mean annual temperature should not be below 60° F. (2) The mean temperature of the warmest month should exceed 80° F., or the mean of the three warmest months should exceed 77° F. to get the best results; this condition, however, is not so important as the first. (3) The interval between killing frosts (or droughts) should be at least 200 days. (4) The annual rainfall should not exceed about 60 in. for good crops, though cotton of a poorer quality can be grown in much wetter climates; unless irrigation is possible, the annual fall should not be less than 23 in.

NO. 2637, VOL. 105]

(5) There must be plenty of bright sunshine. A dull and humid atmosphere is particularly unfavourable to the cotton plant.

MR. G. W. LAMPLUGH's address as president of the Geological Society of London appears in the *Quarterly Journal* of that Society, vol. lxxv., part 1, published in January, 1920. Its theme is that studies of the thicknesses of English sedimentary series show that an anticlinal uplift is the sequel to deposition in a gradually deepening trough. Hence the greatest thicknesses of strata are now found near the escarpments, from which the beds thin away towards the margins of the former trough. The Weald, the Jurassic uplands, the Trias, and most of our Carboniferous rocks are cited as examples. The Jurassic beds beneath the Weald still retain the synclinal structure; but the "partial recovery" of the trough is marked as we pass upwards through the Wealden series to the Chalk. The sections given provide much material for thought.

THE latest addition to the series of Special Reports on the Mineral Resources of Great Britain, issued by the Geological Survey, is vol. xv. on "Arsenic and Antimony Ores," by Henry Dewey. As neither of these substances is produced in any very important quantities in this country, the report is necessarily a brief one, though the subjects are treated quite thoroughly. In the case of each metal there is given a general account of the mode of occurrence and of the distribution of its ores, followed by a detailed description of all the mines that have produced any noteworthy quantity. There is practically no antimony at all produced in Great Britain, but Cornwall and Devon still rank as relatively important contributors to the world's output of arsenic, much of this being obtained as a by-product from Cornish tin-mines. As has been pointed out by Sir Aubrey Strahan, the main value of this report lies in the fact that it has brought together in a convenient and readily accessible form a quantity of information previously scattered through a number of publications, which is thus rendered readily available to those interested in the various industries which make use of the metals here discussed or of their compounds.

THE April issue of the *Journal of the Institution of Electrical Engineers* contains the paper read by Mr. R. S. Whipple at the joint meeting of the institution and the electro-therapeutics section of the Royal Society of Medicine on electrical methods of measuring body temperatures. After describing the modern resistance thermometer and the thermo-electric couple methods of measuring temperature, he comes to the conclusion that for ordinary work records of body temperature and its variation can best be obtained by means of a resistance thermometer placed in the rectum. For more accurate work a thermo-electric couple with a photographic recorder must be used, especially if rapid or minute variations of temperature are to be detected. The resistance thermometer may be made of platinum wire of about 1/20 mm. diameter, have a resistance of about 140 ohms, and be used with a moving-coil galvanometer in a resistance

bridge with arms of about the same resistance. A suitable thermo-electric couple is provided by copper and constantan, an alloy of about 60 per cent. copper and 40 per cent. nickel. A moving-coil galvanometer of coil resistance 10 ohms or less is suitable, with a balancing resistance placed in series to give a convenient scale deflection.

It is a sign of the spirit which we have so long worked to encourage, to find on opening last month's issue of *Beama*, the excellently produced journal of the British Electrical and Allied Manufacturers' Association, an article by Mr. E. B. Wedmore urging the importance of co-operative scientific research. Mr. Wedmore points out how the war has taught us the value of concerted action, and shows that combined rather than individual research facilities are particularly necessary in view of the present shortage of scientifically trained technical men. Among articles which follow, indicating some of the enormous industrial structures already raised on foundations of scientific endeavour, is one by Mr. W. E. Hughes sketching the many uses to which the electro-deposition of metals has been put. An interesting example is the building up of worn engine parts, such as crankshafts, by deposits of iron—a practice developed by the Royal Air Force in face of some difficulty during the war. The author, however, points out how the serious lack of educational facilities has hampered British progress in these branches of electro-metallurgy. Another interesting article by Mr. A. B. Searle deals with the preparation of tungsten and its important uses in the filaments of modern incandescent lamps and of the three-electrode ionic valves upon which many of the recent developments in wireless telegraphy are based. Notwithstanding the large amount of research that has led up to the present processes, the author characterises them as "making the best of a bad job." If means could be found for melting the purified tungsten economically, the quality of the filaments would be greatly improved. Unfortunately, however, this cannot be done at present, he concludes, owing to the extraordinarily high melting point of the metal (more than 3000° C.) and the difficulty of heating it to this temperature out of contact with carbon.

THAT "small things often very considerably affect the destinies of great ones" is the appropriate motto chosen to introduce a paper on lubricants read by Mr. G. F. Robertshaw at a meeting of the Institution of Petroleum Technologists on April 19. One object of the paper was to urge a plea for uniformity in the methods of examining lubricating oils. At present there is a diversity of practice which is liable to produce confusion and uncertainty in judging lubricants from the physical and chemical data obtained in testing them. For instance, there are half a dozen kinds of instruments used for determining the viscosity of oils, and the results are expressed in different terms, depending upon the particular viscometer employed. Hence an appeal is made that the absolute viscosity, or some convenient multiple or sub-multiple of it, should uniformly be used as the standard method of expression. The paper also, it may be noted, affords a convenient

reference to the somewhat extensive literature upon lubrication. Without compiling a complete bibliography, the author directs attention to many useful sources of information, historical, scientific, and practical. On the question of "oiliness"—a property possessed by good lubricants which at present cannot be specified in definite terms—it is remarked that this property is not necessarily proportional to viscosity. Whilst the late Sir Boverton Redwood's dictum is still true, that viscosity is our most valuable test of lubricating quality, there yet remains the fact that for the same viscosity the fixed vegetable and animal oils have usually a greater "oiliness" than mineral oils.

A NEW view of the nascent state is put forward by C. Zenghelis in the *Comptes rendus* of the Paris Academy of Sciences for April 12. Experiments are described which show that the chemical activity of such gases as hydrogen, oxygen, nitrogen, or carbon monoxide is increased by bringing them in contact with solutions in very minute bubbles. This fine state of division is obtained by forcing the gas through cartridges of paper, the pressure inside the cartridge being so adjusted that the gas does not bubble through, but reacts with the dissolved body in the pores of the paper. Before each experiment a blank was made with each cartridge alone to prove that the paper had no action on the solution. Under these conditions hydrogen was proved to reduce mercuric chloride to calomel, potassium nitrate to nitrite, carbon dioxide to formaldehyde, and substances giving a sugar reaction. With oxygen gas ammonia was oxidised to nitrous acid, and methyl alcohol to formaldehyde. With nitrogen and hydrogen sufficient ammonia was produced in half an hour to give a reaction with Nessler solution. Carbon monoxide reduced iodic acid and sodium molybdate. All these reactions took place at ordinary temperatures. Fuller details of the experiments will be published later.

PROF. A. N. WHITEHEAD is publishing almost immediately through the Cambridge University Press the Turner lectures delivered by him in November last. The volume will be entitled "The Concept of Nature," and form a companion to the same author's "Enquiry Concerning the Principles of Natural Knowledge." It will, however, be less mathematical than the earlier work.

THE Cambridge University Press announces the publication in June of "The Influence of Man on Animal Life in Scotland: A Study in Faunal Evolution," by J. Ritchie. As the title implies, the book will deal with the bearing of man upon the character and composition of the fauna of Scotland. It will be fully illustrated and contain eight maps.

THE latest catalogue (No. 401) of Mr. Francis Edwards, 83 High Street, Marylebone, W.1, gives particulars of 757 books on the Far East—China, Japan, and the Malay Archipelago; also of the Far North-East of Asia, including Siberia and Kamtchatka. Many of the works are scarce, but the majority are listed at greatly reduced prices. The catalogue will be sent free upon request.

### Our Astronomical Column.

CONJUNCTION OF MARS WITH SPICA.—Interesting, though not extremely close, approaches of Mars to the bright star Spica Virginis will occur on May 22, when Mars will be situated  $2\frac{1}{2}$  degrees north of the star. On that night the planet will pass the meridian at 9.21 G.M.T. at an altitude of about 30 degrees. On succeeding nights Mars will be observed to the N.N.W. of the star, but on June 2 will become stationary, and thereafter move slowly eastwards. On June 12 he will again be in conjunction with Spica Virginis, and about  $1^{\circ}37'$  N. of the star. Mars will cross the S. meridian 10 minutes before sunset on the latter night, and a good view will not be obtainable of the planet and star until 9 p.m. G.M.T. and afterwards. Mars will be much the brighter of the pair, and visible at an earlier time than the star. The two conjunctions will form attractive and striking configurations.

THE DUPLICITY OF  $\nu$  GEMINORUM.—There is an article on this star by Dr. Bernewitz in *Astr. Nach.*, 5041. The orbit as a spectroscopic binary was investigated in the Publications of Ottawa Observatory (vol. iv., No. 19). The period is 9.6 years, and the value of  $a \sin i$  is 1,400,000,000 km. This large value suggested that it might not be impossible to detect the duplicity visually. It has been examined with the 65-cm. refractor at Berlin-Babelsberg Observatory by Dr. Bernewitz, Dr. Bottlinger, Prof. Guthnick, and Mr. F. Pavel. All agree that the image is distinctly elongated. Neighbouring stars of similar magnitude appeared perfectly round, so that it is concluded that the effect is not instrumental. On examining  $\nu$  Geminorum through increasing thicknesses of a dark wedge it was found that before it disappeared it became round; they conclude from this that the companion is about 1 magnitude fainter than the primary. This difference removes uncertainty as to the quadrant. Dr. Bernewitz and Mr. Pavel each measured the pair on five nights, and their respective results are:

Date	P.A.	Distance.
1920-208	116.2	0.14
1920-205	124.3	0.16

They state that the spectroscopic results indicate that the star is now near elongation. If measures can be obtained over a sufficient arc of the orbit, it will be possible to deduce the parallax and mass. The spectral type is B<sub>5</sub>, so that a mass-determination would be of particular interest.

KODAIKANAL OBSERVATIONS OF PROMINENCES.—Vol. i., part 2, of the Memoirs of Kodaikanal Observatory has lately been distributed. It contains a full description, with numerous photographs, of the prominence observations made by Mr. and Mrs. Evershed, and a discussion of their distribution and motion. Their preponderance at the sun's eastern limb, which many observers have noticed, is difficult to explain except as an earth effect. It will be remembered that Mr. Evershed has recently noticed another sign of an earth effect in the distribution of line-of-sight velocities in the photosphere.

It is pointed out that besides the principal prominence zones, which coincide with those of sunspots, there are also high-latitude zones. The prominences in these are less active than the equatorial ones; they frequently appear as pyramids, or rows of round patches. Their wave of activity begins in latitude  $50^{\circ}$ , soon after sunspot maximum; it travels poleward, reaching the pole about the next maximum and dying out there. It is suggested that the change in the corona round the poles, which takes place in the

sunspot cycle, may be connected with this prominence fluctuation.

The rotation of the prominences has been studied at Kodaikanal; it is found to be more rapid than that of the photosphere. Line-of-sight velocities and disc observations of long-lived prominences agree in supporting this. It is concluded that the prominences are so tenuous that the free path of the atoms is infinite. Their luminosity "is due to the internal energy of the atoms, perhaps derived mainly from absorption of the intense solar radiation."

### Leonardo da Vinci.<sup>1</sup>

By EDWARD McCURDY.

WITH the list of war inventions may be numbered Leonardo's researches in aviation. He pursued this subject for many years. His studies range from the consideration of the primary causes of flight in birds and other winged creatures to the invention of a screw propeller and the consideration of its applicability to aerial navigation. He also made an actual attempt. Jerome Cardan, the physician who made a horoscope for Edward VI., in his work "De Subtilitate" refers to an unsuccessful attempt at flight made by Leonardo da Vinci, and adds somewhat dryly, "He was a great painter." A sentence on the cover of Leonardo's manuscript, "Sul Volo degli Uccelli," written in 1505, has been interpreted as referring to this attempt. "The great bird," it runs, "will take its first flight upon the back of the great swan, filling the whole world with amazement, and filling all records with its fame; and it will bring eternal glory to the nest where it was born."

This enigmatic utterance may be somewhat more comprehensible if it is remembered that *cecero* is the Italian word for swan, and "the back of the great swan" may therefore be interpreted as a reference to Monte Ceceri, a hill to the south-west of Fiesole, from which it is believed the flight took place.

From the meagre records of the attempt we pass to researches in theory and construction.

The material falls naturally into two groups, the first being a series of investigations of the laws which govern the power of flight as manifested in Nature by birds and other winged creatures, the second consisting of deductions from these principles in the construction of a mechanism which should be capable of sustaining and being worked by man. The interdependence of the two parts of the inquiry is stated with great succinctness in a passage in the Codice Atlantico:

"A bird is an instrument working according to mathematical law, which instrument it is within the capacity of man to reproduce with all its movements, but not with a corresponding degree of strength, though it is deficient only in the power of maintaining equilibrium. We may therefore say that such an instrument constructed by man is lacking in nothing except the life of the bird, and this life must needs be supplied from that of man.

"The life which resides in the bird's members will, without doubt, better conform to their needs than will that of man, which is separated from them, and especially in the almost imperceptible movements which preserve equilibrium.

"But since we see that the bird is equipped for many obvious varieties of movements, we are able from this experience to deduce that the most rudimentary of these movements will be capable of being comprehended by man's understanding; and that he will to a great extent be able to provide against the

<sup>1</sup> From a discourse delivered at the Royal Institution on Friday, March 19. Continued from p. 309.



destruction of that instrument of which he has himself become the living principle and the propeller."

In the analogy thus drawn from Nature to the problem before him, Leonardo has anticipated the attitude of modern research.

In his construction of the instrument he finally attempted to combine the type of the lark soaring with its wings open with that of the bat as it descends. He does this by the introduction of *sportelli* (trap-doors or shutters) in the surface of the wings, whereby, as he says, "the wing is full of holes as it rises and closes up when it falls." The shutters should have rims of cane and be covered with starched taffeta to render them airtight. Perhaps it was after the Monte Ceceri attempt that he wrote on a page of MS. B of the Paris manuscripts, "Try the actual instrument in the water, so that if you fall you will not do yourself any harm." It may also have been the failure of this attempt that caused him to search for a fresh source of motive power to take the place of that exerted by the muscles of a man. On 83 verso, MS. B of the Paris manuscripts, there is a drawing of a large screw constructed to revolve round a vertical axis, and a note explains its intended use: "If this instrument made with a screw is well made—that is to say, made of linen of which the pores are stopped up with starch—and is turned swiftly, the said screw will make its spiral in the air, and it will rise high."

Leonardo adds that a small model may be made of cardboard, with the axis formed of fine steel wire bent by force, and that this when released will turn the screw. To his drawing of this instrument the architect Luca Beltrami has—to me, as it seems, justly—applied the word "aeroplane."

Another page in the Codice Atlantico (311 v. d.) of unique interest contains three studies of artificial wings, a name, and a note that the machine is to be made, not with *sportelli*—that is, shutters—but united. The natural interpretation is that the note refers to a commission for the construction of a machine for flight, with regard to which the patron, Gian Antonio de Mariolo, has expressed a desire that the wings should be such that no wind would be able to pass through them as it would if they had shutters, i.e. should be like the wings of the bat.

Leonardo's researches in natural and applied science cover so wide a field, and specialisation in these days has so divided knowledge into watertight compartments, that properly to gauge the value of his contributions to scientific research would require a combination of many trained intelligences. But it is not possible to devote a number of years to the close study of all that concerns Leonardo without becoming imbued with the conviction of the complete oneness of his work and method. The dominant purpose which animates him, whatever the nature of the problem, is to investigate, to examine, and to define primary causes. His pen reinforces his practice. "Nature," he says, "is constrained by the order of her own law, which lives and works within her." Again, "There is no result in Nature without a cause; understand the cause, and you will have no need of the experiment"; and "Nature is full of infinite causes which were never set forth in experience."

With Leonardo the latter end of this search forgot the beginning. His intellectual curiosity into the origins and causes of all created things is revealed in infinite variety in the thousands of pages of his manuscripts, compact, as has been said, "of observation, of prophecy, of achievement," and in his triple legacy forming a record probably unequalled, certainly unsurpassed, by that of any other man in the history of the world. For consider what he was! Painter,

sculptor, engineer, architect—all these to the wonder of his contemporaries. His manuscripts reveal that he was no less distinguished as physicist, biologist, and philosopher. But in the field of science he was essentially a forerunner. The results that he achieved must be reckoned as small compared with his grasp of basic principles, with the vistas that he opened up, and with the unerring instinct which he displayed in choosing the true method of investigation.

All Leonardo's writings connected with science seem, as it were, fragments of a larger purpose, charted, defined, explored, but never fulfilled, of which his researches in anatomy, zoology, physiology, embryology, and biology are the allied and component parts. Discerning the essential unity of man and the animals—"because," as he says, "all land animals have similar members—that is to say, muscles, nerves, and bones—and these members do not vary at all except in length and thickness" (MS. G, 5 verso)—he may be said to have founded comparative anatomy. Drawings now at Windsor show the gradations of the human type merging into that of various animals. Leonardo tracks the mystery of life from the conception and the foetus through growth to maturity, and so to the gradual wasting of the tendons and all the physical phenomena of death.

"I have dissected," he says, "more than ten human bodies, destroying all the various members, and removing even the very smallest particles of the flesh which surrounded these veins without causing any effusion of blood other than the imperceptible bleeding of the capillary veins. And, as one single body did not suffice for so long a time, it was necessary to proceed by stages with so many bodies as would render my knowledge complete; and this I repeated twice over in order to discover the differences."

The drawings made in the course of these investigations, now in the Royal Collection at Windsor, were examined in the time of George III. by the famous surgeon William Hunter, who, approaching them with natural professional distrust, thus made the *amende honorable*—

"I expected," he says, "to see little more than such designs in anatomy as might be useful to a painter in his own profession. But I saw, and indeed with astonishment, that Leonardo had been a general and deep student. When I consider what pains he has taken upon every part of the body, the superiority of his universal genius, his particular excellence in mechanics and hydraulics, and the attention with which such a man would examine and see objects which he has to draw, I am fully persuaded that Leonardo was the best anatomist at that time in the world." Although he does not fully explain its mechanism, he evidently knew of the circulation of the blood a hundred years before Harvey gave the knowledge to the world. "The heart," he wrote, "is a muscle of great strength; the blood which returns when the heart opens again is not the same as that which closes the valve."

The depth and variety of his researches in other branches of natural science may be inferred from the citation of a few instances in which he anticipated the results of investigations associated with other names. Either before, or at latest during such time as Copernicus was laying the foundations of his heliocentric theory by study at Bologna and Padua—a theory afterwards brought to completion and published in his work, "De Revolutionibus Orbium Cœlestium," in 1543—Leonardo had enunciated the ruling principle of it in a line in the manuscripts now at Windsor, "Il sole non si muove" ("The sun does not move").

A hundred years before Maestlin, who is credited with the discovery, he had defined the obscure light of

the unilluminated part of the moon as due to reflection from the earth's surface.

In the search for hidden laws and causes the scientific problem followed hard upon the artistic problem. The study of perspective led to that of light and shade, and so of optics—the study of the structure and functions of the eye, as being the instrument by which light and shade are perceived. He made a model of its parts, and showed how an image is formed on the retina, thus refuting the currently accepted belief of the eye throwing out rays which touch the object it desires to examine. He described also the principle of the *camera obscura* ninety years before Porta developed the idea in practice.

In mechanics he enunciated the theory of inertia, afterwards demonstrated by Galileo, and relegated the theory of perpetual motion then current to the same category as astrology and necromancy. He refound the wisdom of Archimedes, and demonstrated his theory of oblique forces applied to the arm of the lever, afterwards associated with the name of Galileo. Following on Archimedes's conception of the pressure of fluids, he showed—a century and a half before Pascal—that liquids stand at the same level in communicating vessels, while if the two arms are filled by different liquids the heights will vary inversely as their densities.

Leonardo is at once artist and man of science in his treatment of, and interest in, water. He studies its properties and power of movement under conditions varying from the action of the tides of the ocean to the laws which regulate the movement of water in siphons—a subject on which he notes his intention of writing a treatise. He follows its transformation into vapour, rain, dew, snow, and ice. It winds mysteriously in wonder-working coils through the landscape backgrounds of his pictures. He traces the infinite shapes it assumes, falling in violence of movement in spirals and eddies, circling like the loop of a swallow's flight, something of the artist's sheer delight in the creation of beauty of form mingling with the purpose of the man of science to wrest from this variety its underlying principle. Or again, as engineer he harnesses its power, studying to divert its channels either in menace of war or for purposes of commerce or irrigation.

In considering a geological problem his method is entirely deductive. "Since," as he says, "things are far more ancient than letters," he turns from authority to the testimony of things themselves. "Why," he asks, "do we find the bones of great fishes and oysters and corals and various other shells and sea-shells on the high summits of mountains by the sea just as we find them in low seas?" The fact that the cockles were living at the time when they became embedded in the strata—this being evident from the shells being found in a row in pairs, while in other places the dead are found separated from their shells and all cast up together by the waves—is cited as proof that water formerly covered parts of the earth which are now far above the level of the sea, and that this condition continued for a period of more than the forty days of the Deluge, because, as the cockle travels along a furrow at the rate of three or four braccia daily, it could not in forty days have proceeded from the Adriatic to Monferatto in Lombardy, a distance of 250 miles. By an investigation of the cuttings formed by the Arno in the successive strata of which the shells are found, he shows the gradual changes in the crust of the earth, and, following on the track of this knowledge, he essays the construction of the map of Italy in days remote beyond record, but of which the earth remains a living witness.

His special interest in botanical study may be traced

back to the earliest period of his artistic work. Vasari tells of a cartoon, intended for tapestry, of the sin of Adam and Eve in Paradise, where was a meadow with innumerable plants and animals, "of which in truth one could say that for diligence and truth to Nature divine wit could not make the like." He mentions a fig-tree as of special excellence for the foreshortening of the leaves and the disposition of the branches, and also a palm in which the roundness of the fan-like leaves was shown with marvellous art. His description suggests minute attention to detail on the part of the artist based upon a profound study of Nature, and these are the characteristics which find expression in Leonardo's many exquisite studies of plants and flowers, and in the treatment of the herbage in the Virgin of the Rocks in the Louvre. His study of botany was in inception an integral part of his treatise on painting, botany being as necessary as anatomy, in order that the painter might have the requisite knowledge of form and structure. But here also the artist's power of observation of the varied beauty of earth's raiment of plants and flowers is merged imperceptibly in the mood of the man of science who saw in Nature not only form and colour, but, above all, light, which St. Augustine called "the queen of colours," and uses Nature's profusion as a background whereon to study the incidence of light and shade.

Leonardo's researches in structure are so exact and so scientific in method as to anticipate the results of subsequent inquiry, as, for instance, in the knowledge his writings reveal of phyllotaxis—the law of quincuncial arrangement of the leaves on the stem—promulgated in 1658 by Sir Thomas Browne in his "Garden of Cyrus." In like manner the discovery that the age of a tree may be told from the number of concentric rings visible in a section of its trunk, with which more than a century later the names of Nathaniel Grew and Marcello Malpighi are associated, is contained in a passage in Leonardo's "Treatise on Painting" (Ludvig, 829). Leonardo also states in the same passage that these rings vary in thickness according to the greater or less amount of humidity of each year.

I have attempted here to summarise a few of the results attained in the course of this investigation. The breadth and variety of their scope may serve to recall the remark of Francis I., who is recorded by Benvenuto Cellini to have said that "he did not believe that any other man had come into the world who had attained so great knowledge as Leonardo."

### Aeronautical Research.

THE announcement by the Air Ministry of the future arrangements for aeronautical research and education marks an important stage in the history of the subject. The course followed was indicated in a White Paper, noticed in NATURE of March 4, p. 14, containing the report of a Committee on Education and Research in Aeronautics. The chairman of that Committee, Sir Richard Glazebrook, is now head of the new Aeronautical Research Committee and Zaharoff professor at London University. He was for twelve years chairman of the late Advisory Committee for Aeronautics under the presidency of the late Lord Rayleigh, and it may fairly be claimed that the new advance in the direction of the co-ordination of research in a large subject is a consequence of the success of the work of the earlier body. The Advisory Committee for Aeronautics had the assistance of such eminent men of science as Sir Horace Darwin, Sir Joseph Petavel, Sir Dugald Clerk,

Sir Napier Shaw, Mr. F. W. Lanchester, and Sir George Greenhill. The new Committee differs considerably from the older one in its *personnel*, and indicates an apparent break in continuity. This is not wholly the case, for many of the new members of the Research Committee have for some time been members of sub-committees of the Advisory Committee. It was inevitable that the end of a strenuous period, such as that which brought the war to a close, should be taken as a suitable time for the withdrawal of the older members from some of their activities, and this has happened to a great degree in the case of the members of the Advisory Committee for Aeronautics. The place of such members is taken by specialists in aeronautics together with one or two men of science of wide experience.

It was recommended, in the report referred to, that funds should be provided for a school of aeronautics at the Imperial College of Science, South Kensington, to which institution the Zaharoff chair of aviation was attached. The Treasury has approved of the necessary funds being provided, and steps have now been taken for the formation of the necessary educational staff. The Committee's scheme recommended that this staff should include, in addition to the Zaharoff professor, whole-time professors of aerodynamics and airship construction, together with part-time teachers on design, materials, aero-engines, meteorology, navigation, and airships, and a whole-time junior staff. Mr. L. Bairstow, a former student of the college, has been appointed to the chair of aerodynamics. His work at the National Physical Laboratory on the stability of aircraft is well known and constitutes an important advance in aeronautical engineering. Mr. Bairstow is a member of the new Aeronautical Research Committee, and this dual position—like that of Sir Richard Glazebrook—should afford ample facility to enable the Research Committee to supervise the educational work of the new school.

In general the scheme proposed attempts to provide a common meeting-ground for everybody connected with aeronautics. As a central body responsible for advice and criticism and for the broad lines of policy in research, the Advisory Committee for Aeronautics proved to be of the greatest value. It had no direct executive powers, although the National Physical Laboratory had departments in aeronautics provided solely for carrying out the wishes of the Committee.

The experience gained is apparently considered by the Air Ministry to have justified an extension of powers, and, in particular, the contact with full-scale research at Farnborough and elsewhere is made of the same character as that previously holding for the model work at the National Physical Laboratory. In addition, the Committee has intimate relations with the Imperial College for educational needs. The terms of reference to the Committee and the delimitations of the respective responsibilities of the Air Ministry and the Department of Scientific and Industrial Research give some indication of the very complex arrangements contemplated. Control in all directions is divided, and it is some consolation in these troubled times to find the whole of the essential elements of aeronautics combining to give a fair and generous trial to a scheme without definite rules, *i.e.* to a scheme which assumes helpful co-operation as the basis of success. Whatever difficulties may appear in this direction can only be known later, but it may be hoped that the new Committee will be a worthy successor to the Advisory Committee for Aeronautics and so help to confirm a healthy precedent in the relations of industry and research to the Departments of State.

### Conjoint Board of Scientific Societies.

THE report for the year 1919 gives evidence that the Board continues to discharge useful work. During the year there was a danger that supplies of casein and glue would fall short, and that aeroplane manufacture would suffer thereby. The Board came to an arrangement with the Air Group of the Ministry of Munitions, and carried out a research into the nature, functions, and manufacture of adhesives. This resulted in the discovery of two new adhesives, one possessing very remarkable properties, and the other prepared from a waste product of which there was a large supply in the country throughout the war. In addition to this, Dr. Schryver and his colleagues devised improvements in the manufacture of casein which effect a considerable saving in material and an improvement in its quality.

The Committee on the Water-power of the Empire, with Sir Dugald Clerk as chairman and Prof. A. H. Gibson as secretary, drew up a second report, in which it is able to claim that it has stimulated interest in water-power investigations in many parts of the Empire. In India, Ceylon, British Guiana, Australia, the Union of South Africa, and the East Africa Protectorate steps are being taken by the appointment of commissions or committees, or by preliminary investigation and survey, to estimate the water-power supplies which will be available, and in several instances the committee has been asked to give guidance and assistance. Much new development is taking place in New Zealand. A proposal has been put forward to hold an Imperial Water-power Conference in London. Attention is directed to the general lack of facilities in universities and technical institutes for the specialised training of young men in hydro-electric engineering.

The committee of which Sir Robert Hadfield is chairman has sent deputations to interview Sir Alfred Mond and Mr. Stanley Baldwin (on behalf of the Chancellor of the Exchequer) in order to put forward its opinion that there is a great need for better and more centralised accommodation for the technological and scientific societies.

The Patent Laws Committee drew up a series of recommendations, which were adopted by the Board and transmitted to the Federation of British Industries for use in its endeavour to introduce modifications into the new Patent Laws.

An elaborate report on the advisability or otherwise of the compulsory adoption of the metric system, drawn up by a committee with Mr. Wilson-Fox as chairman and Mr. A. R. Hinks as secretary, was discussed at a special meeting of the Board called for the purpose. The report, which envisages boldly the actual practical difficulties which would confront compulsory adoption, especially during the war, is shortly to be published on the authority of the committee, accompanied by a series of criticisms on the part of the scientific and technical societies to which it has been submitted.

Other pieces of work summarised in the report relate to such subjects as the supply of timber for aeroplanes, the establishment of geophysical and petrological institutes, and the place of science in warfare.

The Board has also taken its share in the discussion of the formation of national and international research councils, and in advocating the publication of a work devoted to the mineral resources of the Empire. The Bulletin, which is printed and issued to the conjoint societies and the members of the Board, gives in a comprehensive form a forecast of the meetings of the societies and an early announcement of the papers to be read thereat.

## Agricultural Development in the West Indies.

THOSE interested in tropical agriculture will find much worthy of attention in a paper on "Tropical Departments of Agriculture, with Special Reference to the West Indies," written by Sir Francis Watts, Imperial Commissioner of Agriculture for the West Indies, and published in the *Journal of the Royal Society of Arts* (February 20). The paper contains a very interesting account of the evolution of tropical Departments of Agriculture, pointing out that these Departments had their origin in the botanical gardens which were started in the larger islands in the eighteenth century, and also in the mission gardens which the early missionaries cultivated around their stations. The author traces the decline of the British West Indian sugar industry, and the efforts to revive it and to stimulate agriculture by the formation of botanical departments in the smaller islands. Economic conditions, however, became worse, and in 1806 the West Indian Royal Commission was appointed, and its report marks a period in West Indian history. As an outcome of this report the Imperial Department of Agriculture was constituted, the expense of which was met by Imperial funds. The policy of the Department was to revive, extend, and improve the already existing botanic gardens. This action so fostered agricultural development that, at the end of ten years, the Colonial finances had so improved that it was decided to diminish progressively the Imperial grants to the various stations, until in 1912-13 these grants ceased. Sugar production is still a highly important industry; it has been very much improved; the pests and diseases of the sugar-cane are understood, and what is more important, the growers know how to control the pests; also, the sugar produced by the factories is now a much more valuable product than the old muscovado sugar. The cacao and lime industries have been studied and improved; some minor industries, e.g. onion-growing, have also been studied to the advantage of the growers; while encouragement has been given to the production of such crops as maize for home consumption. The latter activity is especially important at the present time, when a wheat shortage is threatened.

## A Simple Viscometer.

PARTICULARS of a remarkably simple viscometer devised by Mr. A. G. M. Michell, of Melbourne, are given in *Engineering* for April 16. The instrument is intended for workshop use, and gives rapid determinations of viscosity in absolute measure without requiring extraordinary care or skill. It consists of a cup fitted with a handle and a ball of the same curvature as the cup. Contact of these surfaces is prevented by three symmetrically disposed projections in the cup, raised a mil or two above its surface. The cup is held by its handle, and a few drops of the oil to be tested are placed in it. The ball is then placed in the cup and pressed firmly into it for five or ten seconds. This drives some of the oil out, which collects in a channel; enough oil must be provided in the first instance to ensure that the channel is filled. The instrument is then inverted, and the time taken for the ball to drop clear noted. This time in seconds divided by the constant of the instrument is equal to the absolute viscosity of the oil. The action depends upon the rate at which the oil-film between the cup and the ball thickens under the force of gravity exerted by the ball. This flow of oil is

resisted by its viscosity, and the time taken for the ball to fall clear is accordingly directly proportional to the viscosity. The above method is sufficiently accurate for workshop use. To obtain accurate results, the ball is placed at the bottom of a vessel containing a considerable quantity of the liquid. The cup is then lowered over the ball, taking care to exclude air. After pressing the two together as before, they are lifted until the ball clears the bottom of the vessel, and the time it takes to drop clear is noted as before. Mr. W. Ramsay, of Messrs. Cammell and Laird, has made as many as 120 most concordant readings in two hours, and the results plotted quite regularly. With liquids of very low viscosity, the ball is suspended from the arm of a balance. By adjusting the weights, the force tending to separate the ball from the cup can be diminished to, say, one-twentieth of the normal. This increases twentyfold the time needed to effect the separation. The manufacture in this country has been undertaken by Messrs. Michell Bearings, Ltd., 3 Central Buildings, London, S.W.1.

## The Chemical Society and its New By-laws.

IT is not surprising in these days, when the old political order has been challenged in so many quarters, that even the scientific societies should be moved to recast their constitution and government in a democratic sense. The Chemical Society is the latest to complete this process of revision, and a record of the chief points in which changes have been made is of public interest.

As a preliminary to any fundamental alterations, a supplemental charter was found to be necessary. The original charter of 1848 included many hampering restrictions, prescribing, for example, the maximum size of the council and the manner of its election. Such provisions, devised for the conduct of a small society associated mainly with London and the immediate districts, are quite unsuitable now that the society numbers more than 3500 fellows, and when probably about two-thirds of these reside beyond the metropolitan area.

There has been some doubt also whether, under the original charter, it was permissible to elect women as fellows of the society. Uncertainty on this point has now been removed by the supplemental charter, which provides that fellows may be of either sex.

Another important feature of the new by-laws based on the supplemental charter is the attempt to secure for provincial fellows a greater share in the conduct of the society. Hitherto every important matter affecting the society, including the election of officers and council, has been determined at a general meeting by a majority of the fellows present and voting. Under the supplemental charter the society has power to elect the officers and council by a postal vote, and further, in certain cases, to take a poll of all fellows resident in the United Kingdom. These powers have been incorporated in the new by-laws.

Another important aspect of these is that there has been kept in view the contingency of combined action with kindred societies concerned in the development of chemical science, as, for example, in the possible acquisition of common premises, or in the publication of joint abstracts. Under the new provisions there will be greater liberty to deal with such a situation if and when it arises, and it may be that these particular modifications of the by-laws will prove to be amongst the most important that have been made.

## University and Educational Intelligence.

CAMBRIDGE.—The syndicate appointed to consider the relation of women students to the University has presented a double report. One-half of its members are in favour of admitting women to full membership of the University with a few limitations affecting special posts. They specifically exclude in their proposed statute the recognition by the University of women students at the men's colleges, but they throw open University lectures, examinations, degrees, offices, and emoluments to women on the same terms as to men. The legislation they propose will give degrees to past students of Girton and Newnham.

The report of the second half of the syndicate contains a long discussion of the question. Their actual proposal boils down, however, to a recommendation that the Senate should express itself in favour of a new university being formed from Girton and Newnham Colleges, the intention being to preserve for their students the facilities at present extended to them by the University of Cambridge. The advantages accruing to women students under this proposal would be the awarding of degrees and official consultations between the men's and the women's universities on examination schedules. There is a controversy ahead ending in a contest to which the outside voter will doubtless be summoned by both parties.

Sir Geoffrey Butler, Corpus Christi College, has been appointed secretary of the Board of Research Studies; correspondence in connection with students desiring to come to Cambridge to work for the Ph.D. degree should be addressed to him.

Mr. H. F. Gadwo has been appointed reader in the morphology of vertebrates; Dr. H. Scott curator in entomology; Mr. G. F. C. Gordon superintendent of the engineering workshops; and Mr. L. G. P. Thring superintendent of the engineering drawing office.

MR. T. HARRISON HUGHES has made the generous gift of 50,000*l.* to the University of Liverpool as a contribution to the appeal for funds.

A PUBLIC lecture on "The Life-movements of Plants" will be delivered at University College, London, by Sir Jagadis C. Bose on Monday, May 17, at 5.30.

A HOLIDAY course in geology will be held at the School of Metalliferous Mining, Camborne, Cornwall, from July 12 to August 23. The course will consist of lectures, laboratory work, and field work, and occupy five days a week. The lectures will deal with the geology of West Cornwall, with special reference to the economic side.

A LIMITED number of free places, tenable at the Imperial College of Science and Technology, South Kensington, are being offered by the London County Council to candidates who can show that they are qualified to enter on the fourth, or post-graduate, year of the course of study selected. Applications must be made upon Form T2/255 A., obtainable from the Education Officer, L.C.C., Victoria Embankment, W.C., and sent in by, at latest, June 5.

THE council of the London (Royal Free Hospital) School of Medicine for Women will award, in June next, the Dr. Edith Pechey Phipson post-graduate scholarship of the annual value of 100*l.* and tenable for three years. The scholarship is open to all medical women, preferably coming from India or going to work there, for assistance in post-graduate

work. Applications are receivable by the warden and secretary of the school, 8 Hunter Street, Brunswick Square, until May 31.

DURING the period immediately following the Armistice it was necessary to adopt temporary measures to fill vacancies in Civil Departments otherwise than by open competitive written examination. The scheme, authorised by Order in Council and under regulations of the Civil Service Commission, has been known as the Reconstruction Scheme. Under that scheme, men who have served in his Majesty's Forces have been chosen to fill positions in the Civil Service by interview before a selection board, following a qualifying examination. The scheme, which has been applied to the Home Civil Service (Class I), the Indian Civil Service, the Colonial Civil Service, junior or intermediate appointments, and officerships of Customs and Excise, is now coming to an end; and the Civil Service Commissioners announce that the last day for the receipt of applications under it (which must be on the prescribed form) is June 30, 1920, and that *no application received after that date can be considered*. This announcement does not apply to appointments in the Foreign Office and Diplomatic Service or in the Consular Service, which it is intended to make on the Reconstruction Scheme until the end of the year 1921.

THE various associations of teachers in Lancashire and Cheshire engaged in different spheres and branches of education, ranging from the Private Schools Association to the Universities of Liverpool and Manchester, and including all grades and phases of education, have formed themselves into a federal council comprised of two or more representatives from each association or branch with the purpose of considering the further co-ordination of education in Lancashire and Cheshire, and of bringing into closer association teachers who are engaged in different branches of educational work. The council comprises thirty-two representatives, with Principal J. C. M. Garnett as chairman, from fourteen different teachers' associations, and the federal council thus constituted met in Manchester on October 26, 1918. At a later meeting the council appointed special committees to investigate the following matters:—(a) The interrelation of the various types of schools and the age of transfer, together with a national scholarship system; (b) the curricula of the several types of schools; (c) the training and supply of teachers; and (d) the means and methods whereby teachers may secure a more effective voice in the administrative control of education. The recommendations of these committees are set forth in a statement of some seventy pages, published at 1*s.* by the Manchester University Press, entitled "A National System of Education: Some Recommendations for Establishing it in England during the Decade Ending Ten Years Hence." The statement includes an introduction, being a lecture delivered by Principal Garnett in January last, which is accompanied by an elaborate coloured diagram setting forth the various grades of education for different classes of children according to their opportunities and capacities and their probable future in life. The pamphlet describes nine types of educational institutions and sixteen different types of education, but whether these could not with much advantage be seriously reduced in number is a matter for the grave consideration of educators. It is suggested that there should be established upon the lines of this federal council a provincial joint committee for each of some eight or ten provinces into which England and Wales should be divided for the purposes of education.

## Societies and Academies.

LONDON.

**Royal Society**, April 29.—Sir J. J. Thomson, president, in the chair.—Prof. J. W. Gregory: The Irish eskers. Eskers are banks of sand and gravel, typically occurring as ridges on the central plain of Ireland, where they were deposited during the recession of the ice at the close of the Glacial period. They have been generally attributed to deposition along glacial rivers, like Swedish *osar*. Their structure and composition indicate that the most important Irish eskers were formed along the margin of the receding ice-sheets by floods of water, due to the melting of the ice. Irish eskers formed along glacial rivers are relatively small and exceptional. The accumulation of the materials into ridges, and their restriction between about 150 ft. and 300 ft. above sea-level, are attributed to the formation of the eskers where the ice entered into a sheet of water, which was probably the sea, since marine fossils are widely distributed in the adjacent drifts, and there are no embankments to maintain glacial lakes at the required level. It is proposed that the term "esker" should be continued for Irish ridges and mounds of sand and gravel, but that in glacial geology the term "*osar*" should be used for ridges formed along the course of glacial rivers, and "*kame*" for ridges deposited by water along the margin of an ice-sheet.—Miss K. M. Curtis: The life-history and cytology of *Synchytrium endobioticum* (Schilb.), Perc., the cause of wart disease in potato. The life-history and cytology of the organism have been followed through all their stages. In the course of the investigation the following important points have been determined: (1) A sexual process has been discovered and followed in all its details; (2) the nature of the difference between the resting (or winter) sporangia and the sori (or summer sporangia) has been established; (3) the infection of the host-tissue by the zoospores and zygotes has been traced; and (4) the peculiarities in the behaviour of the nucleus of the parasite have been investigated.—B. Sahni: The structure and affinities of *Acropyle pancheri*, Pilger. *Acropyle*, a monotypic New Caledonian Podocarp, is the most specialised member of the Podocarpaceae, and closely allied to the genus *Podocarpus*, which it resembles in the vegetative anatomy, drupaceous seed, megaspore membrane, young embryo, structure of male cone, microsporophyll, pollen-grain, and probably male gametophyte. It differs from *Podocarpus* in (1) the nearly erect seed; (2) the complete fusion of the epimatium to the integument, even in the region of the micropyle, in the formation of which it takes part; and (3) the much greater development of the vascular system of the seed, which forms a nearly continuous cup-like tracheal investment covering the basal two-thirds of the stone. (a) The Taxineae are structurally so distinct from the remaining conifers as to justify their being placed in a separate phylum, Taxales, equivalent in rank, and related to, the Ginkgoales and the Coniferales as here defined. The Cordaitalean affinities of the Taxales are emphasised. (b) Concerning the ovuliferous scale of the conifers, the conclusion is in favour of the brachyblast theory, support for this view being derived from the structure of the megastrobilus of *Acropyle*. (c) No definite opinion is expressed on the question whether the conifers arose ultimately from microphyllous or megaphyllous ancestors, for the origin of the Cordaitales themselves is still regarded as *sub judice*.

**Zoological Society**, April 27.—Dr. A. Smith Woodward, vice-president, in the chair.—F. F. Laidlaw: Contributions to a study of the dragon-fly fauna of

Borneo. Part iv.: A list of the species known to occur in the island.—Dr. R. Broom: Some new Terephthalian reptiles from the Karroo beds of South Africa.

MANCHESTER.

**Literary and Philosophical Society**, March 16.—Mr. William Thomson, vice-president, in the chair.—Prof. R. Robinson: Note on the mechanism of the production of kynurenic acid in the dog. The formation of kynurenic acid from tryptophane is susceptible of a very simple representation involving normal reactions. The process appears to be primarily one of oxidation followed by decomposition of a carbanic acid derivative, and a probably spontaneous closing of the quinoline ring.—Prof. A. Lapworth: Latent polarities of atoms and mechanism of reaction, with special reference to carbonyl compounds. A consideration of the properties of carbonyl compounds shows that divalent oxygen and tervalent nitrogen tend to cause a latent polarisation in the molecules of carbon compounds. When this occurs in a molecule, the other atoms in the neighbourhood show induced latent polarities which the writer indicates by attaching  $-$  and  $+$  signs to the atoms in alternating order, beginning with the "key atoms," arriving at schemes like those adopted by Fry and others. The induced polarity of an atom or group is not interpreted as necessarily signifying an electric charge, but only as an enhanced or diminished tendency to attract or repel other atoms (or electrons) with definite polar character, and that only at the moment of chemical change (or ionisation, when this occurs). A condition which appears necessary for the full extension of the inductive effect is the occurrence of double bonds (conjugation?), though it may survive the intervention of two successive single ones. While divalent oxygen and tervalent nitrogen (and especially the former) seem more effective than any other atoms, it would appear that halogen ( $-$ ), hydrogen ( $+$ ), and metals ( $+$ ) can act as "key atoms" to a smaller extent; carbon appears almost indifferent. This principle includes Markownikoff's rule of addition, the rules of substitution in the benzene series, the rules of reaction of saturated and unsaturated ketones, nitriles, and carboxylic acids, as well as of their halogen derivatives. The influence of hydrogen as a "key atom" is perceptible in the cresols, of which the relative acidities can be foreseen from a consideration of the influence of the hydrogen atom in the methyl groups on the latent polarities of the atoms in hydroxyl groups.—Prof. R. Robinson: The conjugation of partial valencies. The author deals with the mechanism of chemical processes on the basis of a hypothesis of divisible valency, assuming that activation of molecules is due to a partial dissociation or splitting of valencies, and that only molecules so polarised take part in reactions. This accounts for the well-recognised effect of polar atoms on alternate atoms in a chain, and the theory is extended to include cases such as the addition of hydrogen bromide to allyl bromide, where the conjugation of ethylene linkage and bromine atom is relatively weak. Conjugated decompositions and the problem of molecular rearrangement are dealt with.

PARIS.

**Academy of Sciences**, April 19.—M. Henri Deslandres in the chair.—G. A. Boulenger: The fossil *Gavialis* of Omo.—A. Vaysière: The marine fauna of the western coast of the Gulf of Marseilles.—G. Julia: New properties of certain very general classes of integral or meromorphic functions.—W. Sierpinski: Functions of the first class.—Fr. Lange-Nielsen: A generalisation of Rolle's theorem.—J. Villey: Flight at high alti-

tudes. Reply to some criticisms of M. Rateau on an earlier communication.—E. Brylinski: The transport of electrical energy to great distances. A mathematical discussion of the properties of a half-wave line.—S. Posternak: The variations of the composition of ammonium phosphomolybdate. An account of the variations in the composition of the precipitate produced by the presence of ammonium nitrate or sulphate in the liquid in which the precipitate is formed.—F. Bourion: The analysis of commercial chlorobenzenes by distillation. The substances present in the commercial product are benzene, monochlorobenzene, and higher chlorination products boiling at  $80^{\circ}$  C.,  $130^{\circ}$  C., and  $172^{\circ}$  C. or above. A scheme for systematic fractional distillation is given, with results for synthetic mixtures. The method is a lengthy one, a single sample requiring three and a half days for analysis.—G. Mignouac: The ketimines. Formation by the catalytic reduction of the oximes. The reaction was carried out with nickel (reduced from its oxide at  $300^{\circ}$  C.) in absolute alcohol at ordinary atmospheric pressure at a temperature of about  $16^{\circ}$  C. The oxime of cyclohexanone gave *N*-cyclohexylketimine, a substance not previously isolated, and the corresponding ketimines were isolated from the reduction products of the oximes of acetophenone, propiophenone, benzophenone, and phenyl- $\alpha$ -naphthyl ketone.—Mlle. S. Veil: Alloys of oxides. Mixtures of the oxides of chromium and cerium were compressed and heated, and measurements made of the electrical conductivity and magnetisation coefficient of the products. Diagrams are given showing the results for varying proportions of the two oxides.—C. Matignon and J. A. Lecaun: The reversible oxidation of arsenious acid. From the thermochemical data it should be possible directly to oxidise arsenic trioxide to the pentoxide, and experiments were carried out at temperatures between  $400^{\circ}$  C. and  $450^{\circ}$  C., the pressures of the oxygen being 130, 127, and 138 atmospheres. The production of the pentoxide was proved, but the oxidation of the arsenic trioxide was not complete.—Ch. Gorceix: The formation of the first ocean.—R. Souèges: The embryology of the Enothraceæ. Development of the embryo in *Oenothera biennis*.—M. Moilliard: The influence of a small quantity of potassium on the physiological characters of *Sterigmatocystis nigra*. Potassium has a marked specific action on the development of this mould. Deficiency of potassium causes the glucose in the culture fluid to disappear more rapidly than the lævulose; conidia and black pigment do not appear as usual; a golden-yellow pigment appears in the fluid, and a soluble substance stained blue by iodine is formed.—G. Bertrand: The conditions which may modify the activity of chloropicrin towards the higher plants. The effects of chloropicrin are nearly proportional to the concentration of the vapour and the time of action. Moisture and light, except direct sunlight, are without influence.—M. Baudouin: An anatomical measurement permitting the diagnosis of sex in the human skull.—L. Boutan: Comparative yields of pelagic apparatus.—P. Wintrebert: The propagation of the undulating movement of the muscles of the skeleton in advanced embryos of *Scylliorhinus canicula* after section or partial resection of the spinal cord.—P. Portier: The rabbit deprived of its cæcal appendix regenerates this organ by differentiation of the extremity of the cæcum. When the rabbit's appendix is removed the terminal portion of the cæcum is modified, becomes infiltrated with lymphocytes, and regenerates a new appendix possessing the essential histological and physiological characters of the normal appendix. This is a proof of the important function of this organ in the rabbit.—Ch. Porcher: Lactal retention.—M. Doyon: The anti-

coagulating and hæmolytic action of sodium nucleinate.—P. Courmont and A. Rochon: The action of the micro-organisms of sewage effluents purified by the activated-sludge method on albuminoid materials, urea, and nitrates.—E. Aubel: The sterilising power of acids.

### Books Received.

- School Dynamics. By W. G. Borchardt. Part i. (with Answers.) Pp. vii+286+xix. (London: Livingstons.) 3s. 6d.
- Space and Time in Contemporary Physics. By Prof. M. Schlick. Rendered into English by H. L. Brose. Pp. xi+89. (Oxford: At the Clarendon Press.) 6s. 6d. net.
- Zoology: A Text-book for Colleges and Universities. By Prof. T. D. A. Cockerell. Pp. xi+558. (Yonkers-on-Hudson, New York: World Book Co.) 3 dollars.
- An Introduction to Palæontology. By Dr. A. M. Davies. Pp. xi+414. (London: T. Murby and Co.) 12s. 6d. net.
- Practical Plant Biochemistry. By M. W. Onslow. Pp. vii+178. (Cambridge: At the University Press.) 15s. net.
- Wild Fruits and How to Know Them. By Dr. S. C. Johnson. Pp. xi+132. (London: Holden and Hardingham, Ltd.) 1s. net.
- Aluminium: Its Manufacture, Manipulation, and Marketing. By G. Mortimer. (London: Sir Isaac Pitman and Sons, Ltd.) 2s. 6d. net.
- Cotton Spinning. By W. Scott Taggart. Vol. iii. Fifth edition. Pp. xxviii+490. (London: Macmillan and Co., Ltd.) 70s. net.

### Diary of Societies.

THURSDAY, MAY 13.

- ROYAL INSTITUTION OF GREAT BRITAIN, at 3.—A. P. Graves: Welsh and Irish Folk Song.
- ROYAL SOCIETY, at 4.—Election of Fellows.—4.30.—Dr. A. D. Waller: Demonstration of the Apparent "Growth" of Plants (and of Inanimate Materials) and their Apparent "Contractility."—W. N. F. Woodland: The "Renal Portal" System (Renal Venous Meshwork) and Kidney Excretion in Vertebrata.
- LONDON MATHEMATICAL SOCIETY, at 5.—H. W. Richmond: (1) Historical Note on Some Canonical Forms quoted by Mr. Wakeford. (2) Historical Note on Cayley's Theorems on the Intersections of Algebraic Curves.—T. Stuart: The Lowest Parametric Solutions of a Dimorph Sextan Equation in the Rational, Irrational, and Complex Fields.—A. E. Jolliffe: The Pascal Lines of a Hexagon.
- INSTITUTION OF ELECTRICAL ENGINEERS (at Institution of Civil Engineers) at 6.—S. Evershed: Permanent Magnets in Theory and Practice.
- INSTITUTE OF INVENTORS (at Royal Society of Arts), at 7.30.—D. Leechman and Others: Discussion on The Relations of the Inventor to the State.
- OPTICAL SOCIETY, at 7.30.
- INSTITUTION OF AUTOMOBILE ENGINEERS (Graduates' Section) (at 28 Victoria Street), at 8.—W. E. Benbow: The Chemical and Physical Properties of Iron and Steel.
- ROYAL SOCIETY OF MEDICINE (Neurology Section), at 8.30.—Annual General Meeting.—Dr. S. A. K. Wilson: Decerebrate Rigidity in Man, and the Occurrence of Tonic Fits.

FRIDAY, MAY 14.

- DEPARTMENT OF SCIENTIFIC AND INDUSTRIAL RESEARCH. Conference of Research Organisations (at Institution of Civil Engineers), at 3.—Marquess of Crewe: Introductory Address.—Dr. A. W. Crossley: The Relation of Research Associations to Existing Institutions for Research.—A. Campbell: The Staffing of Research Associations: Salaries and Superannuation.
- ROYAL ASTRONOMICAL SOCIETY, at 5.
- PHYSICAL SOCIETY OF LONDON, at 5.—Dr. F. Lloyd Hopwood: Demonstration of Experiments on the Thermionic Properties of Hot Filaments.—G. D. West: A Modified Theory of the Crookes Radiometer.—A. Campbell: The Magnetic Properties of Silicon-Iron (Stalloy) in Alternating Fields of Low Value.—T. Smith: Tracing Rays through an Optical System.

ROYAL SOCIETY OF MEDICINE (Clinical Section), at 5.30.—Annual General Meeting.  
 MALACOLOGICAL SOCIETY OF LONDON (at Linnean Society), at 6.  
 INSTITUTION OF ELECTRICAL ENGINEERS (Students' Meeting) (at King's College), at 7.—E. G. Humphreys: Electrical Motor Control Devices.—The Meeting will be preceded by the Annual General Meeting.  
 JUNIOR INSTITUTION OF ENGINEERS, at 7.30.—Hon. H. Fletcher Moulton and Others: Discussion on The Business Aspect of the Peace Treaty.  
 SOCIETY OF TROPICAL MEDICINE AND HYGIENE (at 11 Chandos Street, W.1), at 8.30.—Dr. E. W. Clegg: A Consideration of Pellagra from the Standpoint of a "Deficiency Disease."  
 ROYAL INSTITUTION OF GREAT BRITAIN, at 9.—Prof. Karl Pearson: Sidelights on the Evolution of Man.

## SATURDAY, MAY 15.

ROYAL INSTITUTION OF GREAT BRITAIN, at 3.—Frederic Harrison: A Philosophical Synthesis as proposed by Auguste Comte.

## MONDAY, MAY 17.

VICTORIA INSTITUTE (at Central Hall, Westminster), at 4.30.—Bishop G. Forrest Browne: Monumental Art in Early England, Caledonia, and Ireland.  
 ROYAL INSTITUTE OF BRITISH ARCHITECTS, at 8.—B. J. Lubschetz: The Two Great Railway Stations of New York.  
 ROYAL SOCIETY OF ARTS, at 8.—A. T. Bolton: The Decoration and Architecture of Robert Adam and Sir John Soane, 1758-1837 (Cantor Lectures).  
 ROYAL GEOGRAPHICAL SOCIETY (at Aeolian Hall), at 8.30.—Capt. F. Kingdon Ward: The Valleys of Kham.

## TUESDAY, MAY 18.

ROYAL INSTITUTION OF GREAT BRITAIN, at 3.—Prof. A. Keith: British Ethnology: The Invaders of England.  
 ROYAL SOCIETY OF MEDICINE, at 5.—General Meeting.  
 ROYAL STATISTICAL SOCIETY, at 5.15.—F. B. Guild: Variations in the Numbers of Livestock and in the Production of Meat in the United Kingdom during the War.  
 INSTITUTION OF PETROLEUM TECHNOLOGISTS (at Royal Society of Arts), at 5.30.—R. Stirling: Air Lift System of Pumping Oil Wells.  
 ROYAL PHOTOGRAPHIC SOCIETY OF GREAT BRITAIN (Lantern Meeting), at 7.—A. C. Vowles: Wanderings in Mesopotamia (Babylon).  
 ROYAL ANTHROPOLOGICAL INSTITUTE, at 8.15.—Sir Henry Howarth: Buddhism in the Pacific.

## WEDNESDAY, MAY 19.

SOCIETY OF GLASS TECHNOLOGY (at Institute of Chemistry), at 9.—C. J. Peddle and Others: Discussion on The Physical Properties of Glass. Part I.: The Interaction of Silica with the Oxides of Sodium and Potassium. Part II.: The Interaction of Silica, Lime, and Sodium Oxide. Part III.: The Interaction of Silica, Lime, and Potassium Oxide. Part IV.: The Interaction of Silica, Lime, and the Oxides of Sodium and Potassium. Part V.: A Comparison of the Soda-Lime-Silica and the Potash-Lime-Silica Glasses.—Dr. M. W. Travers: A Surface Effect in Glass, Probably Caused by Re-heating.—S. English and Dr. W. E. S. Turner: The Thermal Expansion of Magnesia-containing Glasses.—J. R. Clarke and Dr. W. E. S. Turner: The Optical Properties of Some Lime-Soda Glasses.—S. English and Dr. W. E. S. Turner: The Annealing Temperatures of Soda-Lime and Soda-Magnesia Glasses.—J. D. Cauwood, J. R. Clarke, Miss C. M. M. Mead, and Dr. W. E. S. Turner: The Durability of Lime-Soda Glasses.—J. R. Clarke and Dr. W. E. S. Turner: The Influence of Lime on the Value of Young's Modulus of Elasticity for the Lime-Soda Glasses.—S. English and Dr. W. E. S. Turner: The Density of Soda-Magnesia Glasses and a Comparison with that of the Soda-Lime Glasses.  
 ROYAL SOCIETY OF ARTS, at 4.30.—J. S. Highfield, Dr. W. R. Ormandy, and D. Northall-Laurie: The Commercial Applications of Electrical Osmosis.  
 ROYAL SOCIETY OF MEDICINE (History of Medicine Section), at 5.—Annual General Meeting.—Dr. Withington: The Medical Terms in Liddell and Scott.  
 ROYAL METEOROLOGICAL SOCIETY, at 5.—Dr. Griffith Taylor: Agricultural Climatology of Australia.—J. E. Clark and H. B. Adames: Report on the Phenological Observations for 1919.  
 ROYAL SOCIETY OF LONDON, at 5.30.—Dr. H. H. Thomas: Certain Xenobiotic Tertiary Minor Intrusions in the Island of Mull (Argyllshire).  
 ROYAL MICROSCOPICAL SOCIETY, at 8.—Annual Exhibition of Microscopic Pond Life.

## THURSDAY, MAY 20.

ROYAL INSTITUTION OF GREAT BRITAIN, at 3.—A. P. Graves: Welsh and Irish Folk Song.  
 ROYAL SOCIETY, at 4.30.—*Probable Papers*.—Prof. J. N. Collie: Some Notes on Krypton and Xenon.—Silk Ling Ting: Experiments on Electron Emission from Hot Bodies, with a Preface by Prof. G. W. Richardson.—Dr. L. Silberstein: The Aspherical Nucleus Theory Applied to the Balmer Series of Hydrogen.—Dr. T. E. Stanton, Miss D. Marshall, and Mrs. C. N. Bryant: The Conditions at the Boundary of a Fluid in Turbulent Motion.  
 ROYAL SOCIETY OF ARTS (Indian Section), at 4.30.—Brig.-Gen. Lord Montagu of Beaulieu: Roads and Transport in India.  
 ROYAL SOCIETY OF MEDICINE (Dermatology Section), at 5.—Annual General Meeting.  
 INSTITUTION OF MINING AND METALLURGY (at Geological Society), at 5.30.—G. Rigg: Roasting and Lead-Smelting Practice at the Port Pirie (S.A.) Plant of the Broken Hill Associated Smelters Proprietary, Ltd.—Capt. H. Tatham: Tunnelling in the Sand Dunes of the Belgian Coast.

INSTITUTION OF ELECTRICAL ENGINEERS (at Institution of Civil Engineers), at 5.30 (Annual General Meeting).  
 OPTICAL SOCIETY, at 7.30.—B. K. Johnson: The No. 7 Dial Sight, Mk. II.—Lt.-Col. Gifford: A Short High Power Telescope.  
 CHEMICAL SOCIETY (Ordinary and Informal Meeting), at 8.

## FRIDAY, MAY 21.

ROYAL SOCIETY OF MEDICINE (Oology Section), at 5.—Annual General Meeting.  
 WIRELESS SOCIETY OF LONDON (at Institution of Civil Engineers), at 6.—P. Coursey: Some Methods of Eliminating Atmospherics in Wireless Reception.  
 ROYAL SOCIETY OF MEDICINE (Electro-Therapeutics Section), at 8.30.—Annual General Meeting.  
 ROYAL INSTITUTION OF GREAT BRITAIN, at 9.—Prof. J. A. Fleming: The Thermionic Valve in Wireless Telegraphy and Telephony.

## SATURDAY, MAY 22.

ROYAL INSTITUTION OF GREAT BRITAIN, at 3.—Frederic Harrison: The Reaction and the Critics of the Positivist School of Thought.

## CONTENTS.

	PAGE
The Federation of Science	317
Lord Kitchener as a Scientific Worker	319
The Nation's Food. By Dr. E. J. Russell, F.R.S.	320
Differential Geometry. By G. B. M.	321
A Garden in the Dunes. By G. A. J. C.	322
Our Bookshelf	323
Letters to the Editor:—	
The Indian Chemical Service.—Prof. Jocelyn Thorpe, F.R.S.; Sir Prafulla Chandra Ray	324
The Cost of Scientific Publications.—Prof. W. A. Herdman, F.R.S.; Prof. H. H. Turner, F.R.S.; E. B. Knobel; Walter W. Bryant	326
Atomic and Molecular Forces and Crystal Structure. (With Diagram.)—Dr. A. E. Oxley	327
Wasps.—W. F. Denning	328
Dr. J. G. Bartholomew and the Layer System of Contour Colouring.—Geo. G. Chisholm	328
The Prismatic Astrolabe. (With Diagrams.) By E. H. H.	329
The Heart of a Continent. (Illustrated.) By Douglas Caruthers	330
The United States National Research Council. By Prof. Vernon Kellogg	332
Obituary:—	
Marlborough R. Pryor. By Prof. T. G. Bonney, F.R.S.	333
Notes	335
Our Astronomical Column:—	
Conjunction of Mars with Spica	340
The Duplicity of $\nu$ Geminorum	340
Kodaikanal Observations of Prominences	340
Leonardo da Vinci. II. By Edward McCurdy	340
Aeronautical Research	342
Conjoint Board of Scientific Societies	343
Agricultural Development in the West Indies	344
A Simple Viscometer	344
The Chemical Society and its New By-laws	344
University and Educational Intelligence	345
Societies and Academies	346
Books Received	347
Diary of Societies	347

Editorial and Publishing Offices:

MACMILLAN AND CO., LTD.,  
 ST. MARTIN'S STREET, LONDON, W.C.2.

Advertisements and business letters to be addressed to the Publishers.

Editorial Communications to the Editor.

Telegraphic Address: PHUSIS, LONDON.  
 Telephone Number: GERRARD 8830.



THURSDAY, MAY 20, 1920.

*Editorial and Publishing Offices:*MACMILLAN & CO., LTD.,  
ST. MARTIN'S STREET, LONDON, W.C.2.Advertisements and business letters should be  
addressed to the Publishers.

Editorial communications to the Editor.

Telegraphic Address: PHUSIS, LONDON.  
Telephone Number: GERRARD 8830.

### The Officers Training Corps and the Universities.

**I**N a leading article on "The Universities and the Army," in NATURE for April 8, we referred to the Memorandum on the Army Estimates for 1920-21 published by the War Office, and quoted the words: "One of the important lessons of the war has been the extent to which the Army is dependent on the Universities." Of these lessons one especially was emphasised, viz. the necessity for the reorganisation of the Army on its educational side. We were told again and again, both during and after hostilities, that the war was primarily a scientific war—laboratory against laboratory, machine shop against machine shop, trained intelligence against trained intelligence—and it is gratifying to know that the War Office recognises that "the Universities responded to the call for help in a splendid manner." That they did so is an indisputable fact. Thousands of undergraduates and hundreds of their teachers, from junior assistant to full-fledged professor, switched off from classics, history, philosophy, natural science, and what not, to gunnery, engineering, motor transport, and so on. Chemical laboratories substituted investigations on explosives, anti-gas protectives, and smoke screens for routine qualitative and quantitative analysis; engineering laboratories concentrated their energies on the invention of depth charges, shell-gauges, and submarine engines; and the geologist relinquished the study of stratigraphy and palæontology to discover new sources of sand from which to manufacture glass. All this work was novel to the Universities, and, as many would add, foreign to their purpose and traditions; yet should another war of similar magnitude ever arise, can it be doubted that the Universities will again be called upon to play an even greater part in it than they did in the Great War of 1914-18?

NO. 2638, VOL. 105]

If this be so, and if the Army be regarded as a profession, should its officers not receive a professional training, and where more appropriately and effectively than in the Universities? One of the most enlightened features of Army reorganisation introduced by Lord Haldane in 1907 was the institution of the Officers Training Corps in connection with the Universities. Had this tentative scheme of professional training for future Army officers received proper encouragement and been developed on suitable and elastic lines, the War Office might have had at its disposal in the autumn of 1914 a large reserve of trained officers who had passed through a properly devised University curriculum.

The military education committees of the various British universities and university colleges were recently sounded as to their views on the future of the Officers Training Corps, and from the replies received it would appear that most of them are unwilling to commit themselves to any plan of action until the attitude of the Army Council in reference to the Corps has been ascertained. What that attitude may be we have at present no means of finding out. We are informed that one of the largest Universities in the Kingdom answered the inquiry in the following terms: "The Military Education Committee are not of the opinion that it is desirable to take any further action at the present time until the Army Council have made a definite statement with regard to the future position of the Officers Training Corps, or to take any steps in regard to the creation of a Department of Military Studies until this official statement is issued." Several other Universities replied in similarly non-committal terms, and out of twelve, only one expressed any enthusiasm on the subject.

If the Army Council sincerely desires to make use of the Universities in the training of officers, let it say so in clear and unmistakable language, and indicate at the same time how and to what extent it is prepared to aid the Universities in carrying out its ideas. Some progress might be made, for example, if the Army Council would appoint a committee representing all departments concerned with Officers Training Corps, *with power to act and not merely to hear and report*, to meet and confer with representatives of the Universities, who on their side could submit the special needs of the Universities regarding Officers Training Corps. We cannot get rid of the suspicion that the War Office authorities are unaware of the work and organisation of the

newer Universities, and that they are still convinced that Great Britain has only two institutions worthy of the title. Have they any adequate conception, for example, of the extent and capacities for teaching and research of the faculties and departments of metallurgy, engineering, chemistry, and applied electricity at Sheffield, Leeds, Manchester, and Liverpool, to mention only one group of provincial Universities, and how it might be possible, in connection with a properly organised training corps, to provide instruction for cadets in those branches of specialised military work for which a particular University had special facilities and equipment, involving the application of science to war?

The Regulations governing the O.T.C. are dated 1912, but we have learnt much since then, and it is essential before these Regulations are revised and re-issued that the Army Council should take the Universities into its confidence, and, in consultation with their representatives, produce a scheme of training that shall conform to University practice and be within the range of University capacity, while at the same time meeting the requirements of the Army Council in its effort to obtain suitably trained men to command the various units of the Army of the future.

### Relativity and Geometry.

*The Foundations of Einstein's Theory of Gravitation.* By Erwin Freundlich. Authorised English translation by Henry L. Brose. Preface by Albert Einstein. Introduction by Prof. H. H. Turner. Pp. xvi+61. (Cambridge: At the University Press, 1920.) Price 5s. net.

**P**URELY mathematical workers have often found occasion to remark on the prophetic vision of Riemann. He possessed that special genius which catches glimpses of truth, of no special significance to a contemporary, which one day are found to have an importance greater even than the seer himself had dreamed. Certainly this has proved so with much of Riemann's work. His famous *Habilitationschrift*, "On the Hypotheses which lie at the Bases of Geometry," was presented to the faculty of philosophy at Göttingen in 1854, and, in an English translation by Clifford, was brought to the notice of the British public in the columns of *NATURE* (vol. viii., Nos. 183-84, pp. 14-17, 36, 37). It may be permissible to quote one or two prophetic phrases:

"It seems that the empirical notions on which the metrical determinations of space are founded, the notion of a solid body and of a ray of light,

cease to be valid for the infinitely small. We are therefore quite at liberty to suppose that the metric relations of space in the infinitely small do not conform to the hypotheses of geometry; and we ought in fact to suppose it, if we can thereby obtain a simpler explanation of phenomena."

It is worthy of note that Riemann never speaks of space itself as being non-Euclidean. He carefully refers always to the metric or measured relations. The "ground" of these metric relations is to be sought in the nature of the reality underlying space. Is that reality a discrete manifoldness, or is it continuous? If the latter, then the "ground of the metric relations" must be sought in the properties of that reality, or, as he says, "in binding forces which act upon it." Could anything be more prophetic of Einstein's conception of gravitation? Then, as if to anticipate the conservative and the scoffer of to-day, he continues:

"The answer to these questions can only be got by starting from the conception of phenomena which has hitherto been justified by experience, and which Newton assumed as a foundation, and by making in this conception the successive changes required by facts which it cannot explain. Researches starting from general notions, like the investigation we have just made, can only be useful in preventing this work from being hampered by too narrow views, and progress in knowledge of the interdependence of things from being checked by traditional prejudices."

With this open mind, and the work of Gauss, Lobatchevsky, and Bolyai on the geometry of figures on curved surfaces to provoke thought, Riemann faces the possibility that the geometry of three dimensions of actual material bodies may not be so simple as Euclid's system suggests. Geometry in the ordinary sense is, in fact, eliminated; the metrical relations of bodies are "studied in abstract notions of quantity"; the results of calculation may afterwards be expressed in geometric form. Indeed, what is meant by the "length of a line," or a "line element," becomes far from clear from the geometrical point of view. It is merely some quantity which serves to distinguish one point from another. The question is asked: What type of magnitude may be constructed out of the quantities that serve to define two special points in a material body, which may conveniently be taken as a measure of their distinctness one from the other, first from a purely mathematical point of view, but afterwards by an empirical test of its abiding value. Riemann is led to use the general quadratic differential form as the simplest possible expression.

It is easy for one writing now to see the organic connection between Riemann's thought and the step made by Einstein in passing from the special principle of relativity propounded in 1905 to the general theory now established. The recognition of the relative nature of time measurement had already been made in the special principle, and Minkowski quickly perceived that our separate concepts of space and time were thereby brought into a unity. It seems now but a short step to apply Riemann's analysis to this four-dimensional view of the universe.

But questions still linger; the romance of relativity, its sweeping comprehensiveness, leave us breathless. When Dr. Freundlich tells us that "space is banished out of physical laws altogether: just as æther was eliminated out of the laws of electrodynamics by the special theory of relativity," we must pause and ask ourselves if enthusiasm is not going too far. Dr. Freundlich himself finds the mainspring of Einstein's method in two fundamental postulates: (i) that of continuity; (ii) that of causal relationship between only such things as lie within the realm of observation. It was the craving for continuity that gave rise to Faraday's conception of tubes of force, developing gradually into the electromagnetic æther. It is the instinctive faith in the second postulate that leads the timid to distrust the formidable array of differential equations between an army of variables that represent the gravitational field in Einstein's theory.

No physical theory has the power to forbid the mind to use the firm scaffolding of Euclidean truth on which to build its own representation of the universe. True, it may be that the representation is not so simple as we had thought; that the Euclidean element of length does not correspond exactly to a measured interval in a rigid body. But the work of the exponents of relativity is not finished until an added clearness is given by them to the picture of how natural phenomena are related. The æther must not be put on the scrap-heap, but must be rehabilitated. Space must not be spoken of as warped, for that is to leave far behind the essential nature of space as a mode of apprehension. The only true continuum is that which the mind conceives. Matter cannot be a singularity in mental space; it can only be a singularity in the picture drawn upon that background. Matter is one and minds are many. So many minds, so many pictures of matter. The correspondences between the pictures are the grounds of our intellectual intercourse, the only evidence of the external world which we possess.

To turn over the pages of this pamphlet is to encounter many questions; nevertheless the reader will have nothing but thanks to offer to the author, and especially to Mr. Brose, who, while yet a prisoner in an enemy country, found solace in truth that transcends racial strife, and translated it for our enjoyment. E. CUNNINGHAM.

### Colloidal Therapy.

*The Use of Colloids in Health and Disease.* By Alfred B. Searle. With foreword by Sir Malcolm Morris. (The Chadwick Library.) Pp. vii+120. (London: Constable and Co., Ltd., 1920.) Price 8s. net.

BASED on a lecture delivered at the request of the Chadwick Trustees, this volume provides in compact form an account of the principal facts which are known at the present time regarding matter in its colloidal form, with special reference to the utilisation of colloids in the normal animal organism and in the treatment of disease.

We find a lucid account of the physical properties of colloidal matter and of its reactions in the presence of ionising currents, of electrolytes, of radiations, etc. There is explained in simple scientific language the colloidal nature of cellular protoplasm and the selective permeability of cell membranes for salts and colloids.

The importance of the relatively high content of the protective colloid, lactalbumin, in human milk in relation to its digestibility is emphasised, and the means are stated by which cow's milk may be rendered more suitable for human consumption. In discussing the colloidal nature of the blood, reference is made to the adsorption theory of the conveyance of blood gases and to the phenomena of hæmolytic; an isotonic saline solution is, however, 0.9 per cent. sodium chloride.

The modern processes for precipitating colloidal matter in sewage and drinking water, and the use of soap as a detergent, are also briefly reviewed. The author suggests that the hygienic effect of sea-air is due to the presence in it of particles positively charged by the beating of the waves on the shore, which particles precipitate negatively charged bacterial and other colloids; and in regard to the invasion of the body by micro-organisms, he considers that disturbance of the normal colloidal condition of the body-cells or fluids by undesirable electrolytes, salts, or colloids of the "opposite" sign is an ætiological factor.

The author has devoted considerable space to accounts of the preparation of colloidal sols and of their use in therapeutics. In the latter respect he has digested the bulk of the recent and rele-

vant medical literature on the colloidal remedies now in the market. The relative value of colloidal drugs in treatment is still *sub judice*, and we can only hope that the author's optimism regarding their effects as therapeutic agents may be justified in the future. In this section we note several misprints, such as "epidytinitis," "granulama pupendi," and "leishmonnoris," to mention only a few, and the assertion that the colloidal state is the ideal one for the administration of alkaloids is contrary to the evidence afforded of the inefficacy of colloidal quinine and cocaine. In the course of the work the author makes many speculations on the rôle of colloids in physiology and on their possibilities in treatment, speculations which form food for reflection if one is unable to assimilate them all as truths.

The volume, to which Sir Malcolm Morris, whose pioneer work with colloids in skin diseases is well known, contributes an interesting and hopeful foreword, forms a helpful introduction to the subject of colloids in their relation to physiology, pharmacology, and therapeutics, and may be found useful by medical practitioners and others who desire to have a general and not too scientific account of the subject.

### Nature Pictures.

*Twenty-four Nature Pictures.* By E. J. Detmold.  
(London: J. M. Dent and Sons, Ltd., n.d.)  
Price 5 guineas net.

SEVERAL important works have recently been published portraying and describing the birds and mammals of the British Islands. Some of these publications are expensive, others appeal to a slender purse; but, whether the lover of such books is able or willing to spend much or only a little on animal pictures, he is fortunate in having a good deal of scope for choice, many of the works that we have seen of late being excellent in every way, combining artistic merit with scientific accuracy.

In introducing a new work on the higher animals to the British public, therefore, it behoves its author to show that it possesses some outstanding feature of merit which may serve as its *raison d'être*. The work under consideration cannot be regarded as serving any zoological purpose, since the subjects are so few in number. Hence any merit it may lay claim to must be sought from its purely artistic side. But such pictures, to be satisfactory, should be accurate in form and colour, so that, while appealing to the artistic sense, they do not at the same time offend the scientific eye; and herein the

nature-studies of Mr. Detmold are decidedly faulty.

In a series of twenty-four plates the artist portrays altogether five species of mammals, twenty birds, a fish, a crab, and a lobster. Zoologically speaking, the two crustaceans are, in our opinion, the most successful portraits in the series. The majority of mammal and bird studies are distinctly disappointing, and lead one to fear that they have been drawn from specimens supplied by some unskilful taxidermist. They seem to lack the subtle and delicate curves of beauty we are accustomed to associate with the living and healthy animal, while in some cases the colouring is faulty. The proportions, too, between the parts of the body are sometimes incorrect, even allowing for the effects of foreshortening. In the painting of plumage and pelage there are a peculiar "lumpiness" of surface and angularity of outline which are foreign to our ideas of animal form and beauty. Whether the artist has allowed himself to be carried away by the licence proverbial to his profession, or is endeavouring to formulate a new style of composition and portraiture, we cannot say, but the effect, at least from a zoological point of view, is disappointing and at times irritating.

The surroundings of the various subjects are certainly artistic and original, but in some plates the environment is overloaded with detail, while in others its artificiality is oppressive, and suggests tapestry or wall-paper rather than a background for a "nature-picture."  
W. E. C.

### Our Bookshelf.

*General Science: First Course.* By L. Elhuff.  
Pp. vii+435. (London: G. G. Harrap and Co., Ltd.) Price 5s. net.

THAT a pupil's first view of science should be a broad one has been more generally recognised in the United States than in this country. The routine of measurements and weighings, which is all that so many of our children know as science, fails to arouse enthusiasm except as a relief from work which is still more dull. Teachers who are breaking away from this system have been helped by more than one recent American publication. Their attention is confidently directed to the volume now under review.

In its general outlines the book does not differ widely from some of the best of its kind, but it is exceptional in that stress is laid in the earliest chapters on the value and the means of maintaining health. To the question "Why study science?" the answer is given: "To learn how to live." That is kept constantly in view throughout the book. In his preface the author puts the following first among the results which he hopes may be achieved: "A desire to grow strong

in body and mind and to remain free from disease. . . . Successful work on the part of many boys and girls is dependent upon this desire becoming strong enough to rule the body." So it is not surprising to read as an exercise to be set to pupils: "Notice what effects tobacco, alcohol, opium, etc., have upon those who use them." But another, "Observe whether tea and coffee affect the health and 'temper' of parents," makes one wonder whether tactless observation might not have even more effect than the stimulants!

Where it follows lines which are already becoming conventional in America the book is good; in the more novel parts it is even better.

*A Geographical Bibliography of British Ornithology from the Earliest Times to the End of 1918.* By W. H. Mullens, H. Kirke Swann, and Rev. F. C. R. Jourdain. Part 1. Pp. 96. (London: Witherby and Co., 1919.) Price 6s. net.

MESRS. MULLENS AND SWANN have already made ornithologists their debtors by compiling a "Biographical Bibliography of British Ornithology" (completed in 1917). Of this the present work is a supplement or continuation, the books and articles being now arranged under counties. The Rev. F. C. R. Jourdain has shared the labour. The aim of the authors has been to give an account; as complete as possible, of the literature and records relating to the avifauna of each county. This will be of great value to local workers, and there is good sense in Gilbert White's remark, quoted on the title-page: "Men that undertake only one district are much more likely to advance natural knowledge than those that grasp at more than they can possibly be acquainted with; every kingdom, every province, should have its own *monographer*." The labour of making this bibliography must have been very great; it has extended over six years, and has meant the consultation and analysis of a huge mass of literature. There are to be six parts, and those which have appeared represent arduous and useful work well executed.

*The Philosophy of Conflict: and Other Essays in War-Time.* By Havelock Ellis. Second series. Pp. 299. (London: Constable and Co., Ltd., 1919.) Price 6s. 6d. net.

MR. ELLIS is likely to find readers for this collection of essays. His social studies turn on sex-problems, often shrewdly handled. His literary and anthropological studies are dominated by his sense of the picturesque. He is arrested by the picture-making metaphors of Conrad, and by the picturesque theories of Sollas in prehistoric anthropology. In his essays in this last group he reminds us of his own portrait of Jung, wandering "with random, untrained steps, throwing out brilliant suggestions here and there." But in the essay in which this portrait occurs he is on his own ground, and justifiably dwells on his part in introducing to English readers the picturesque psychology of Freud.

NO. 2638, VOL. 105]

## Letters to the Editor.

[The Editor does not hold himself responsible for opinions expressed by his correspondents. Neither can he undertake to return, or to correspond with the writers of, rejected manuscripts intended for this or any other part of NATURE. No notice is taken of anonymous communications.]

### The Cost of Scientific Publications.

MAY I add a word to this most interesting discussion from the point of view of the society with which I am most concerned?

The London Mathematical Society was founded by De Morgan and others in 1865, and has steadily improved its position until it is admittedly the leading mathematical society in the country. It is a comparatively small society, and its activities are almost entirely concentrated on the publication of its Proceedings, to which purpose practically its whole income is devoted. It has no paid staff of any kind.

Before the war the society was able to publish annually about 500 pages of original research, at a cost of some 300l. to 350l. Now a volume of 400 pages only, costs some 600l., and such slight increase of income as there has been is entirely insufficient to meet the new situation. Most of the members are life-compounders, and it is exceedingly difficult to raise the membership beyond a certain point; it was 290 in 1918, and is now about 340. A committee is considering what is possible in the way of economy or increase of charges, but every increase of charges makes it harder to secure new members, and the only substantial economy possible lies in a further limitation of output.

If the society is to maintain the position won by years of effort before the war, it must at all costs keep up both the quality and the size of its Proceedings. In particular it must continue to attract the best work of young mathematicians; and it cannot do this if it has to hamper them at every turn by incessant demands for condensation. A considerable part of the volumes must always be occupied by the work of men of established reputation, and if they are to be further curtailed it is the younger men who will in the first instance be likely to suffer.

The society has during the last year been able to obtain some aid from the fund under the control of the Royal Society, but it is plain that the demands on the fund are likely to multiply, and all possible pressure should be brought to bear on the proper authorities to augment it.

G. H. HARDY,

Hon. Sec. London Math. Soc.

New College, Oxford, May 15.

IN the leading article in NATURE of May 6 on the cost of scientific publications, reference is made to the critical financial position of those of our scientific societies which have no popular means of adding to their income. The position is serious. The scientific worker, upon whom, to a great extent, a scientific society depends for maintenance, is rarely in a position to add to his financial obligations, and the interested person from whom the society also receives considerable support is often in a similar position. If a society is to be efficient, the library must be kept up, the standard of publications be maintained, and its salaried staff receive at least a living wage. How is this to be done? Apart from external aid, there are only two ways—by exercise of rigid economy, and by increased contributions from the members. It is not economy to starve the library, and economy in publication must be employed with

great discretion. The dignified quarto which supplies a link with the early days of the society may be suspended, illustrations reduced to the absolute minimum, communications condensed or reduced, and every conceivable means adopted to avoid expense; but with a diminished sum available for printing, and printing costs trebled, it is obvious that the efficiency of the society as a means of publication must be seriously reduced.

This result bears heavily on oversea members. The member within reach of town has all the advantages of the society; he can attend the meetings, consult the library, and meet his colleagues at the society's rooms; the country member is less favourably situated, but he has at least the privilege of borrowing from the library. The only material advantage received by the oversea member is the scientific publications of the society. The oversea members are an important part of the society, which, though "of London" in style, is world-wide in interest and membership. Our colleagues oversea, though in many cases supporting their own local society, consider it an honour to belong to the mother society at home, and the aim of the mother society is to strengthen the bond and to show the worker oversea that he is both welcome and necessary. Any step, therefore, which tends to lessen the advantages reaped by the oversea member must be avoided.

Apart from external aid there remains only the increased contribution from the individual member. An increase in the subscription will fall hard on many members; but the claims of a society which represents one's work or the scientific interest of one's leisure will not easily be set aside. A man or woman does not join a scientific society in a commercial spirit, but because a congenial atmosphere is there found, or, in the highest motive, because it is an obligation and an honour to help forward the society which represents one's own branch of science. If each member will consider seriously the position of his society, the claim for external aid, amply justified by the value to the community of the scientific work of the society, will come with increased power.

A. B. RENDLE.

THE leading article in NATURE of May 6 has so admirably stated the case for assistance towards the publications of scientific societies that it is almost needless to add further arguments. Nevertheless, there is one point which seems to require attention, namely, that during the last two years, when the pressure of enhanced prices in the printing trade has made itself felt, there has been an attempt on the part of societies subject to this burden to palliate it by means which threaten to change the character of the meetings. To avoid the heavy cost of papers embodying recent research, there has developed a marked tendency to arrange for lectures and demonstrations of a kind which do not require publication in detail, to the disadvantage of original memoirs which demand illustration and extensive text. Should this procedure continue, it is plain that research will suffer, investigators will not be ready to produce the results of their work in the meetings, and the value of the societies' issues will be diminished.

If assistance of the kind advocated can be secured, former methods can be resumed; if that assistance is denied, it is to be feared that, in spite of stringent economy or increased subscriptions on the part of the societies, the publications will suffer; for the maintenance charges must first be met before the balance of income is available for printing memoirs.

B. DAYDON JACKSON.

I do not suppose that there is a single editor of a scientific journal who will not read with sympathy and gratitude of your effort to obtain financial support for such publications in view of the enormously increased cost of paper and printing. In the case of the *British Journal of Psychology*, with which I am specially connected, the subscription is being raised for the second time since the war, whilst no class has suffered more as regards income than that from which the subscribers to scientific journals are drawn.

CHARLES S. MYERS.

30 Montagu Square, W.1, May 10.

### The Indian Chemical Service.

SIR P. C. RAY'S objections to the proposal to form an Indian Chemical Service are based upon the fact that the Education Department of India has failed to realise the importance of research in connection with university teaching. However, I feel sure that he would not advocate the abolition of that Department, much less would he wish to see the Indian Education Service a mere adjunct to some other branch of the public services, without even provincial directors to look after the interests of himself and his colleagues. Every member of a Service knows that, in the event of a difference arising between himself and a member of another Service, he will have the support of a senior member of his own Service at each stage until the matter is perhaps settled by the Viceroy himself. Even directors-general and members of council are human, and inclined to support members of their own Department against the world.

Prof. Thorpe does not dwell at any length on the personal aspect of the problem, but I gather from his letter that he appreciates the importance of it. I do not doubt that he has grasped the fact that, while the members of such units as the Geological Survey of India or the Indian Medical Service are contented with the conditions of their service, grave discontent prevails amongst the numerous scientific men attached to, but not members of, organised Services. The fact that many men holding such positions have thrown up their appointments and come home disgusted has added considerably to the difficulty in recruiting scientific men, and particularly chemists, for service in India. There is no alternative to the bureaucratic system of government for India, and the proposed scheme provides for its inherent defects.

It is, of course, essential that the director-general and the directors of provincial institutes should be chemists who have proved their capacity for research. The Geological, Botanical, and Zoological Surveys of India seem to get on fairly well under directors-general who are scientific experts, and I do not see the necessity for assuming that the head and sub-heads of the Chemical Service will be any less competent than those who have done distinguished service for India in other branches of science.

Knowing something of India, I believe that the proposed scheme is sound, and I wish it every success.

M. W. TRAYERS.

Beacon Hall, Priory Gardens, Highgate,

May 15.

### A New Method for Approximate Evaluation of Definite Integrals between Finite Limits.

1. If  $f(x) = a + bx + cx^2 + dx^3 + ex^4 + fx^5 + jx^6 + kx^7 + l^2 + mx^2$ , the value of  $\int_0^1 [f(\frac{1}{10}) + f(\frac{2}{10}) + f(\frac{3}{10}) + f(\frac{4}{10})]$  is

$$a + 0.5000b + 0.3350c + 0.2525d + 0.2028e + 0.1696f + 0.1455j + 0.1270k + 0.1120l + 0.0994m$$

which is approximately identical with

$$a + 0.5000b + 0.3333c + 0.2500d + 0.2000e + 0.1667h + 0.1429f + 0.1250k + 0.1111l + 0.1000m,$$

that is, with

$$a + \frac{1}{2}b + \frac{1}{3}c + \frac{1}{4}d + \frac{1}{5}e + \frac{1}{6}h + \frac{1}{7}f + \frac{1}{8}k + \frac{1}{9}l + \frac{1}{10}m,$$

which is  $\int_0^1 f(x) dx$ .

An approximate evaluation of  $\int_0^1 f(x) dx$  is therefore given by

$$\frac{1}{6} \{ F(\frac{1}{10}) + F(\frac{2}{10}) + F(\frac{3}{10}) + F(\frac{4}{10}) \}.$$

2. The following table shows for several functions the value of the integral and the approximate evaluation by this four-ordinate rule and by two seven-ordinate rules in common use, viz. :—

Simpson's rule :—

$$\int_0^1 f(x) dx = \frac{1}{18} \{ F(\frac{0}{8}) + F(\frac{2}{8}) + 2 \{ F(\frac{4}{8}) + F(\frac{6}{8}) \} + 4 \{ F(\frac{1}{8}) + F(\frac{3}{8}) + F(\frac{5}{8}) + F(\frac{7}{8}) \} \}, \text{ approx.}$$

Weddle's rule :—

$$\int_0^1 f(x) dx = \frac{1}{26} \{ F(\frac{0}{6}) + 5F(\frac{1}{6}) + F(\frac{2}{6}) + 6F(\frac{3}{6}) + F(\frac{4}{6}) + 5F(\frac{5}{6}) + F(\frac{6}{6}) \}, \text{ approx.}$$

$F(x)$	$\int_0^1 f(x) dx$	New rule	Simpson	Weddle
Semicircle $(x-x^2)^{\frac{1}{2}}$	$\frac{\pi}{8} = 0.3927$	0.3949	0.3815	0.3835
Quadrant $(1-x^2)^{\frac{1}{2}}$	$\frac{\pi}{4} = 0.7854$	0.7868	0.7775	0.7789
$(4x-x^2)^{\frac{1}{2}}$	$\frac{2\pi - \sqrt{3}}{3} = 1.228$	1.231	1.217	1.219
$\log(1+x)$	$2 \log 2 = 1.3863$	0.3859	0.3863	0.3863
$e^x$	$e - 1 = 1.718$	1.720	1.718	1.718
$\frac{1}{1+x}$	$\log 2 = 0.6931$	0.6937	0.6932	0.6931
$\frac{1}{2+x}$	$\log \frac{3}{2} = 0.4055$	0.4056	0.4055	0.4055
$\sin x$	$1 - \cos \frac{180^\circ}{\pi} = 0.4597$	0.4593	0.4597	0.4597

3. The approximation is convenient for the practical determination of the area of a closed curve, such as an indicator diagram. The arithmetical mean of the ordinates at one-tenth, four-tenths, six-tenths, and nine-tenths of the range is the mean ordinate for the range.

The decimal division of the range, the use of only four ordinates, the extremely simple arithmetic involved, and the degree of accuracy attained should make the rule of practical value.

A. F. DUFTON.

Trinity College, Cambridge,  
April 30.

**British and Metric Systems of Weights and Measures.**

ARE not those who discuss the relative claims of 4 mills and 5 mills as the substitute for the penny in a decimal division of the pound merely trying to minimise the disadvantages of what must in any case be a change for the worse? It seems that the advantage of any given system of weights or measures lies largely in the facilities that it offers for the division of a sum or quantity into equal parts. In this respect

any decimal system is deficient by the absence of the factor 3, and by the frequency of the factor 5, which is of much less use than 4 for practical purposes. The *reductio ad absurdum* of the metric system seemed to be reached in the issue in Portugal some years ago of a 2½ reis postage stamp (they now call it ¼-cent). A rei is one-thousandth part of a milrei or dollar, about equal to one-twentieth of a penny—surely a small enough unit for any purpose, and yet it is found necessary to halve it!

The following comparison seems instructive :—

No. of farthings in one pound = 960 = 2<sup>6</sup> × 3 × 5.

This has 11 factors between 1 and 20,  
20 factors between 1 and 100.

No. of inches in one mile = 63,360 = 2<sup>7</sup> × 3<sup>2</sup> × 5 × 11.

This has 14 factors between 1 and 20,  
34 factors between 1 and 100.

No. of ounces in one ton = 35,840 = 2<sup>10</sup> × 5 × 7.

This has 9 factors between 1 and 20,  
17 factors between 1 and 100.

No. of grains in one lb. troy = 5760 = 2<sup>7</sup> × 3<sup>2</sup> × 5.

This has 13 factors between 1 and 20,  
26 factors between 1 and 100.

No. of seconds in one day = 86,400 = 2<sup>7</sup> × 3<sup>3</sup> × 5<sup>2</sup>.

This has 13 factors between 1 and 20,  
32 factors between 1 and 100.

Contrast with these :—

No. of millimetres in one kilometre, or of grammes in one metric tonne = 1,000,000 = 2<sup>6</sup> × 5<sup>6</sup>,

which has only 7 factors between 1 and 20,  
14 factors between 1 and 100.

If all the above five English systems be taken together, it will be found that :—

The factor 2	occurs 37 times
" " 4	" " 17 "
" " 8	" " 11 "
The factors 3, 6, and 12	occur 8 "
" " 5, 10, 16, and 20	" " 6 "
The factor 15	occurs 5 "
The factors 9 and 18	occur 3 "
And the factors 7, 11, and 14	" once each.

Now, though it cannot be contended that the man who wants to divide 100l. into seven parts is helped by the fact that there are 28 lb. in a quarter, or he who would divide a ton into eleven parts by the number of yards in a furlong, yet it seems worthy of note that in our admittedly heterogeneous system all the numbers below 20, except 13, 17, and 19, should be represented as factors, and that to an extent so nearly proportional to their probable utility.

M. E. YEATMAN.

Parliament Mansions, May 7.

**Scientific Apparatus and Laboratory Fittings.**

I AM surprised to see that Prof. W. M. Bayliss, who writes in NATURE of May 6 on the proposed Anti-Dumping Bill, has misunderstood the Bill so far as it relates to scientific instruments. This Bill does not propose a tariff, but prohibition, except under licence.

The British Optical Instrument Manufacturers' Association has urged the Government to act by prohibition except under licence rather than by tariff, and this is what the Bill proposes. It has always considered that the effect of a tariff might, as Prof. Bayliss suggests, give "no inducement to the makers to improve the quality"; and it has urged that licences should always be freely granted where articles were not being made in the required quantity or up to the standard of quality of goods that could be imported from abroad.

Prof. Bayliss's desire for "free import of such apparatus until equally good material is to be had cheaply at home" is provided for by the Bill with the exception of the one word "cheaply," and I suggest that he has, perhaps unintentionally, given the impression that a tariff on goods which either are not or cannot be made in this country has been proposed.

The whole question appears to be: Are scientific men prepared to pay more for British-made scientific instruments of approved quality to meet higher wages or the depreciation of foreign currency rather than have the whole industry extinguished in this country?

With the mark at something like one-tenth its pre-war value, it is obvious that no instrument can be produced in this country to compete as regards price with those made in Germany. The Government, through the British Scientific Instrument Research Association, is giving State aid as regards perfecting processes. Sir Herbert Jackson (who is director of the association) is already producing most valuable results; but if financial considerations make it impossible to sell the articles so produced, it does not meet the case.

Quite apart from the danger to the State which will ensue in case of another war if the scientific industry does not exist, surely it must be evident that science cannot develop properly in any country that cannot produce at least the majority of its own scientific instruments.

A much closer combination between scientific and practical men than existed before the war is required. It has already commenced, and I desire to take this opportunity of explaining that the association of which I am president has a technical committee the members of which place their services at the disposal of the scientific world to discuss all questions the solution of which depends on the production or development of scientific instruments.

CONRAD BECK,

President of the British Optical Instrument  
Manufacturers' Association.

2-3 Duke Street, St. James's, West-  
minster, S.W.1, May 10.

PROF. BAYLISS's letter in NATURE of May 6 raises a subject which is of the greatest interest to manufacturers, as well as to users of all classes of scientific apparatus. We do not think that anyone will dispute the contention that scientific workers should have the very best apparatus which is available, and wherever British apparatus is not up to the standard of foreign competitors there is no doubt that the importation of the foreign articles should be allowed. It is, however, quite a different matter when orders are placed by scientific workers, hospitals, etc., with foreign firms on account of the latter being able to quote lower prices than the English manufacturers can do at the present time.

It has recently come to our knowledge that an important hospital supported chiefly by voluntary contributions has placed a large order for X-ray equipment abroad on account of the lower price quoted, not because the staff was of the opinion that better apparatus could be obtained from this source, as, in fact, we were definitely assured that, except for price, our models were preferred. We would ask the committee which was responsible for placing that order whether it had carefully considered the effect of its act, especially should it be repeated to any considerable extent. It is generally acknowledged that, prior to the war, the British manufacturers were not giving to the medical world the very best service, and both medical men and manufacturers

have often asked the reason why. It is too large a question to go into the fundamental reasons, and opinion would no doubt differ as to these; but there is no doubt that in the year 1914 there did not exist a sufficient demand for British X-ray apparatus to allow manufacturers to work on a large enough scale to ensure satisfactory service and economical production. During the war the cutting off of foreign supplies and the increased demand for apparatus enabled the firms concerned to venture on a bolder policy, until by the end of the war there were established in the country adequate manufacturing facilities. After the armistice the Government orders dropped to zero, but the demands for up-to-date equipment from private hospitals, and from foreign quarters which had been starved during the war, were sufficient to fill the gap and to enable various firms to carry on their manufacturing programme without undue alarm for the immediate future.

The past year has been one of great difficulty in the manufacturing world, and, with the publication and issuing of catalogues and price lists scarcely yet complete, a great deal of the heart will be taken out of British manufacturers if they find that, owing to a circumstance over which they have no control, they are going to lose a large part of their home trade. The circumstance to which we refer is that of the rate of foreign exchange, against which tariffs, unless extremely heavy, are of no value whatsoever. It is very difficult to obtain trustworthy information as to the prices at which German and Austrian goods can really be delivered in this country, but in one specific instance we ourselves are being offered one of our staple articles of manufacture at a price which is very considerably below the actual cost of the raw material which we use in the manufacture. Prior to the war the articles were not made in this country at all, and it was only by the employment of considerable research and a heavy initial expenditure that their production was assured and perfected. We do not think that some scientific workers, medical men, and others quite realise that under present conditions high prices are essential in connection with scientific apparatus as with all other commodities, and that if they wish to obtain really good service from British manufacturing firms it is necessary that the amount of apparatus purchased from them should be considerable. Then when our Colonial and foreign friends come to this country for instruction and advice, and find that instruments of British manufacture are employed by the dozens of the scientific world, our foreign trade will develop, and increased production will then lead to lower prices with better quality.

B. H. MORPHY, Man. Director,  
The Cox-Cavendish Electrical Co., Ltd.

Twyford Abbey Works,  
Acton Lane, Harlesden, N.W.10.  
May 12.

REFERRING to Prof. Bayliss's letter on scientific apparatus from abroad, we cannot quite agree with his view that the instruments made in this country are more costly than those purchased from the Continent. We think that when conditions in this country are more settled Prof. Bayliss will find that foreign prices are equal to, if not in excess of, those ruling on this side, owing to the considerable increase in wages and raw materials. At the moment the rate of exchange makes the prices seem low as compared with those in this country, but can Prof. Bayliss obtain delivery at the low prices?

If manufacturers in this country do not receive the



support of the public, they cannot be expected to produce scientific instruments to compete with the standard of excellence obtained on the Continent—for several reasons, amongst which the following are the most important where microscopes are concerned.

The number of skilled lens-workers capable of making high-power objectives is very small, and to train suitable labour for, say, making 1/12-in. oil immersion objectives of the ordinary achromatic series could not be accomplished in less than three or four years. A dozen or so of these skilled workers could be given employment immediately.

The profit on microscopes is not very remunerative, and unless some protection such as importation under licence is established, no fresh capital is likely to be forthcoming; and even if it is, some years will elapse before those investing their money will see any return, on account of the time required to train labour for this highly skilled occupation.

If some protection is granted to the trade, the manufacturers must set a higher standard of excellence on their goods than they did before the war, otherwise they cannot expect support from the public; but if support is forthcoming we feel sure manufacturers will reciprocate by turning out goods not only at a lower price, but also of a better quality.

It was chiefly on account of the excellent standard attained that Continental manufacturers obtained the lead before the war. Individual pieces of apparatus have been made in England equal to any produced on the Continent, but, unfortunately, only a very small percentage of the supplies ever reached the standard. If English manufacturers will only pay more attention to inspection, and set a much higher standard of quality than they did before the war, there is no reason why the purchasing public should buy foreign-made instruments. There is also no reason why any instrument previously manufactured on the Continent should not be produced here.

C. BAKER.

244 High Holborn, London, W.C.1.  
May 14.

WE do not think Prof. Bayliss and Mr. Munby will find that the prices of British-made laboratory apparatus have increased to the same extent as have those of some other manufactured articles—for example, leather or metal goods, soap, stationery, etc.

Last week a catalogue reached us from a well-known German firm specialising in certain optical goods. The pre-war prices are subject to an advance of 200 per cent., the basis of payment being 20 marks=1*l.*, and cash to the value of 50 per cent. of the order is required at the time of placing it. Thus such imported goods are three times as costly as before the war.

At present the prices of our instruments are from 75 to 120 per cent. above pre-war German prices for instruments which are now admittedly more convenient and efficient. This is particularly the case in regard to one instrument, which for forty years prior to the war had been built by a German firm practically upside down.

Again, we supply certain optical testing instruments which are set at the National Physical Laboratory to an accuracy six times greater than was found in the standard instrument of German origin.

It would seem essential that the manufacture of scientific apparatus in this country should be encouraged to the fullest possible extent in order that trained workers may be available in emergency; for even

supposing war to be impossible in the future, if such manufactures become the monopoly of another country we shall, sooner or later, be paying still higher prices by reason of that monopoly.

As no specific kind of apparatus is mentioned by Prof. Bayliss or Mr. Munby, we have replied as makers of two particular classes of optical testing instruments. These instruments are entirely British as regards optical and mechanical design, as no progress is to be made by adopting and copying designs which have easily demonstrable shortcomings.

BELLINGHAM AND STANLEY, LTD.  
71 Hornsey Rise, London, N.19, May 10.

WITH regard to the letters by Prof. Bayliss and Mr. Munby in NATURE of May 6, we would say that, generally, we are in agreement with the report of the Branch Committee on Scientific Apparatus, of which I was chairman, an abstract of which is published in the report of the Engineering Trades (New Industries) Committee of the Ministry of Reconstruction.

We have very little sympathy with those who would bolster up our industry by levying heavy duties on imports, and, generally, we think that the result of such a policy would be to increase the cost of home-made goods without improving their quality; but there is a good deal to be said for preventing goods made abroad being dumped in this country at prices lower than those prevailing in the country of their origin. The inevitable result of permitting this is to discourage or kill our own industry, and this is well exemplified in the case of our watch industry.

Scientific men cannot, however, have dumped and, consequently, cheap scientific apparatus from abroad and at the same time a flourishing apparatus industry at home producing goods of the highest quality at the lowest prices.

WM. TAYLOR.  
(Taylor, Taylor, and Hobson, Ltd.)  
Leicester, May 11.

WITH reference to Prof. Bayliss's letter in NATURE of May 6, members of this association are in complete agreement that scientific workers should be able to obtain the very best quality apparatus.

I quote the wording of our communication to the Board of Trade (Scientific Instrument Branch) in connection with the proposal to form a special Licensing Committee on which scientific authorities would be represented: "They would have power to allow the imports of all apparatus which cannot be produced of efficient quality or in sufficient quantities in this country to meet the demands."

But the menace to British manufacturers is the abnormal rate of exchange with Germany, which enables apparatus to be brought in at anything from one-fifth to one-tenth of the normal value.

No workshop organisation or economy can possibly compete with such values, and it is during this unprecedented and abnormal state of international finance that British manufacturers are asking for temporary prohibition of imported apparatus at purely artificial prices.

H. W. ASHFIELD,  
Secretary, British Lampbrush Scientific Glass-  
ware Manufacturers' Association, Ltd.  
2-3 Duke Street, St. James's, London, S.W.1,  
May 11.

### Naturally Fractured Eocene Flints.

At a meeting of the Geological Society of London, held on May 5, Mr. S. Hazzledine Warren read a paper entitled "A Natural 'Eolith' Factory beneath the Thanet Sand." The discovery of flints fractured by natural pressure at the base of the Eocene is not, however, a novel experience, as, in 1910, M. l'Abbé H. Breuil described ("Sur la présence d'Eolithes à la base de l'Eocène Parisien," *L'Anthropologie*, t. xxi., 1910, pp. 385-408) in great detail, and by means of no fewer than seventy-six excellent illustrations, a series of flaked specimens of the same kind as those now put forward by Mr. Warren. Also, in 1914, I published an account of the flaked flints occurring in the Lower Eocene "Bull-head" bed at Bramford, near Ipswich (Proc. P.S.E.A., vol. i., part 4, pp. 397-404), and gave a full account of this peculiar deposit and the nature of the fractures exhibited by some of the contained flints. It will thus be seen that this question has been fully discussed and threshed out for many years past.

Through Mr. Warren's courtesy I was enabled, before the meeting at the Geological Society's rooms, to examine his material, and I at once recognised that the flake-scars to be seen upon the specimens showed every characteristic of those produced by pressure. Though of interest as corroborating earlier finds, Mr. Warren's flints have no bearing upon the specimens discovered by me in the Sub-Red Crag detritus-bed and other ancient deposits. The flaked flints which I have collected and claimed as humanly fashioned exhibit flake-scars produced by intelligently directed blows, as is clear to anyone examining them and familiar with the obvious and fundamental differences between pressure and percussion flaking. Further, it is also clear that these pressure-fractured Eocene flints are not comparable with the specimens first found by Mr. Benjamin Harrison, which have been known by that much misused term "eoliths."

J. REID MOIR.

Ipswich, May 7.

### International Council for Fishery Investigations.

THE writer (X. Y. Z.) on this subject in NATURE of April 29 seems to beat the air. There is no confusion of the general discussion with the deliberate statement of the council that "the study of the effect of the war in having closed great areas would materially assist the council in arriving at the most practical results." The closure of certain areas, for ten years or more, by the Scottish Fishery Board has already shown that such is without material effect on Nature's ways. Further, it is just the consideration of the almost valueless mass of certain statistics that, amongst other things, has led to the view that, judged by its promises and performances, the "International Council for the Investigation of the Sea," so far as the welfare of the British fisheries is concerned, is a serious waste of public money. The Development Commission's "almost judicial committee" cannot alter that conclusion.

W. C. McINTOSH.

2 Abbotsford Crescent, St. Andrews,  
May 7.

### Sea and Sky at Sunset.

In a note on the Royal Academy in NATURE of May 6 "J. S. D." expresses disbelief in the possibility that a red sunset can give rise to a pure blue colour in the sea.

Last summer and autumn I occupied a small house on the French coast near Boulogne, and I had the good fortune to witness some of the most wonderful sunsets I have ever seen. The sun used to set across the Channel immediately in front of our windows, and the light of the setting sun was reflected not only in the sea itself, but also in the pools left by the tide along the seashore.

On several occasions when the setting sun was a deep crimson in a purple sky the sea was an intense blue, while the reflection on the water suggested molten gold. The contrast between the purple and crimson of the sky and the blue and gold of the sea was very beautiful, and the effect is not one which I shall readily forget.

As the sea is never free from ripples, it is possible that some of the light reaching the eye is transmitted through the water, but whatever may be the explanation there is no doubt about the reality of the effect.

K. E. EDGEWORTH.

Crowborough, May 9.

READERS of NATURE will welcome Col. Edgeworth's description of what a sunset over the sea can be like, but those who have had an opportunity of studying the picture in this year's Academy to which reference was made will not find any difficulty in distinguishing between the reality as described by him and the artist's conception of the reality as seen at Burlington House.

As to Col. Edgeworth's description of sunsets seen over the English Channel, few who have spent holidays on a western sea-coast, or even on the reaches of a winding river like the Thames, can be unfamiliar with the pillar of gold seen in the water through the reflection of the sun's disc on the rippled surface. The golden reflection beneath the sun and the dark blue reflection beneath the sky may give rise to marked contrasts, but there is nothing unnatural in these. In the picture referred to it is far otherwise. The sun is not visible, but the whole sky is red, and where reflected light would cause innumerable spots of red upon the crests of the ripples no colour but blue is shown.

J. S. D.

### Scientific Research.

IN common with other subscribers to the Scientific Research Association, I recently received an intimation from the acting secretary and the treasurer that the support accorded to it was not sufficient to justify the establishment of the proposed organisation. There can, however, be no question of the importance of the aim the association had set itself—the promotion of research, irrespective of the economic advantages it may bring with it; and it may be some satisfaction to those who feel this to know that the National Union of Scientific Workers has formed a research council to promote the interests of research for its own sake. It is desired to make this council as representative as possible of every branch of scientific investigation. Communications from all who have the success of such a movement at heart should be addressed to the secretary of the National Union, Major Church, 19 Tothill Street, S.W.1, or to myself.

JOHN W. EVANS.

Imperial College of Science and Technology,  
South Kensington, May 10.

### Imperial Air Routes.

RECENT long-distance flights have shown that aerial navigation is a practical means of quick transport between distant lands. The long time occupied on the first flight to Australia is no criterion of the possibilities of the future, when the route is better surveyed and adequate aerodromes replete with all facilities are established. Sir Ross Smith recently spoke of six stages, each occupying a day, as a reasonable journey from London to Sydney. Air routes promise to forge a new link in Imperial unity, and to modify to a great extent the geographical relationships of the various parts of the Empire. Until now the

Sykes described some of the most important of the probable Imperial air routes, and showed how they naturally centre on Egypt. The flight from Egypt to India was accomplished in November, 1918, and this route is one of the first which Sir Frederic Sykes advocates developing. From Kantara to Karachi a flight should occupy 36 hours, compared with the 9 days' steamer journey from Port Said to Bombay. Baghdad would gain more, being a 12 hours' flight from Kantara, and by the present mail route 3 weeks by sea from Port Said.

In this connection it is important to realise

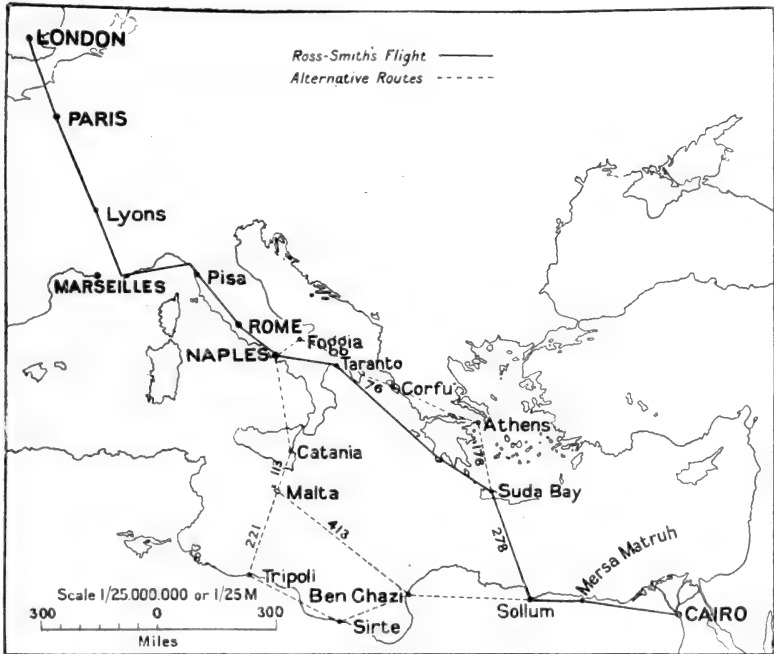

FIG. 1.—Air routes: London to Cairo. From the *Geographical Journal*.

ocean has been the link between the home country, the Indian Empire, the self-governing Dominions, and other oversea possessions. In that respect the British Isles are centrally situated as regards routes throughout the Empire; but for flying, the position of the home country is less favourable. An uncertain climate characterised by rapid changes of weather and much fog militates against successful aviation. Moreover, land connections in provision of aerodromes are an essential in air routes.

In a recent lecture before the Royal Geographical Society<sup>1</sup> Maj.-Gen. Sir Frederic H.

<sup>1</sup> *Geographical Journal*, vol. lv., No. 4, April, 1920.

that air traffic must pay its way if air routes are to become an established feature. Owing to the limitations in the weight that an aeroplane can carry, mails are the most suitable load. In their case also saving of time is a valuable consideration, and a return freight is ensured. Sir Geoffrey Salmond points out that the maintenance of a twin-engined machine, providing for a commercial rate of interest, works out on any route at about 10s. a ton per mile. An aeroplane carrying a ton, which is a fair cargo, must therefore earn 500l. on a 1000-mile flight, or about 1250l. on a flight from Egypt to Karachi. Little but mails could bear this cost, and, their carriage being a Govern-

ment monopoly, could in cases of advantage be partly transferred to air routes. Speed may in time be increased in two ways—first, by the improvement of ground organisation, so as to permit night flying with a relay system; and secondly, by improvement of the engine.

Sir Frederic Sykes quotes some remarkable figures to show the comparatively small risk in flying. During the last eight months of 1919 the total mileage flown by the principal firms engaged in civil aviation was 593,000, and the passengers

large extent controls the course of air routes. From Egypt the route to India is direct from Kantara to Damascus and Baghdad, thence to Basra, Bushire, and along the shores of the Persian Gulf and Arabian Sea to Karachi. Through India two routes to Calcutta are suggested—a northern one *via* Delhi, Cawnpore, and Allahabad, which is part of the route to Australia; and a southern one by Ahmadabad, Bombay, and Nagpur. On both routes aerodromes are already built or under construction, and there is now an

aerial postal service between Karachi and Bombay. The Australian route from Calcutta goes *via* Akyab to Rangoon, whence a stretch of hazardous flying over mountainous country leads to Bangkok. The route continues *via* Singapore, Java, and Dutch Timor to Port Darwin. The latter stages of the journey offer difficulties in suitable landing-places. Alternative routes are proposed, and have been partly surveyed, and it is even suggested that the use of Dutch territory might be avoided by a route from Singapore to Australia *via* Christmas Island. This would entail two stages of 810 and 950 miles respectively, to say nothing of the possible difficulties of aerodrome construction on Christmas Island.



FIG. 2.—Canea from the east. From the *Geographical Journal*.

carried totalled 64,416. During this period only four pilots and one passenger were killed, and six pilots and ten passengers injured. This small proportion of casualties will no doubt be reduced as machines are perfected, ground organisation improved, and air surveys carried out. The close association of the Meteorological Office with the Department of Civil Aviation is a happy augury for the future, and the International Air Convention, to which most of the Allies, and several neutrals, have subscribed, should help to co-ordinate efforts in civil aviation.

The consideration of good landing-places to a

Routes from Egypt to Cape Town, and from England to St. John's (Newfoundland), Toronto, Winnipeg, and Vancouver are also suggested by Sir Frederick Sykes. The route from England to Egypt, although flown numerous times, presents difficulties, especially in Italy and the eastern Mediterranean. An alternative, but longer, route is tentatively suggested from Naples *via* Sicily, Malta, Tripoli, and the northern coast of Africa. The chief problem seems to be in the provision of a suitable aerodrome at Malta, for, once the African coast is reached, favourable conditions are found.

### Helium: Its Discovery and Applications.

By DR. WILLIAM J. S. LOCKYER.

THE year 1868 is rendered memorable in the advancement of solar physics by the fact that the spectroscope was first used on an eclipsed sun. Up to that time the composition of the prominences and corona was unknown, although both these phenomena were then proved to be truly

solar, the result of diligent systematic application of photography to eclipse problems since the year 1860.

On August 18, 1868, a total solar eclipse occurred in the Indian and Malayan peninsulas, lasting for about five minutes and thirty-eight

seconds. This event afforded astronomers an opportunity of applying the spectroscope, in conjunction with the telescope, to determine what the prominences were really made of. On this occasion not only were all the expeditions successful, but an almost identical discovery was also made by the numerous observers.

It was observed that the prominences gave spectra of bright lines, and, with the means of recognition available at the few moments of totality, the red, green, and blue lines which were seen were attributed to the gas hydrogen, while the strong, bright yellow line was stated to be due to the luminous emission of sodium.

During this eclipse the distinguished French astronomer, Janssen, was so struck with the brilliancy of the prominence lines in his spectroscope that he considered it certain he would be able to see the bright lines without an eclipse at all. This

It is interesting as a matter of history to refer here to the first communication which Lockyer made to the Royal Society with reference to his first successful observation.

October 20, 1868.

SIR,—I beg to anticipate a more detailed communication by informing you that, after a number of failures, which made the attempt seem hopeless, I have this morning perfectly succeeded in obtaining and observing part of the spectrum of a solar prominence.

As a result I have established the existence of three bright lines in the following positions:—

- (i) Absolutely coincident with C.
- (ii) Nearly coincident with F.
- (iii) Near D.

The third line (the one near D) is more refrangible than the more refrangible of the two darkest lines by eight or nine degrees of Kirchhoff's scale. I cannot speak with exactness, as this part of the spectrum requires re-mapping.



FIG. 1.—Medal struck by the French Government in honour of the joint discovery of the composition of the prominences by Janssen and Lockyer in the year 1868.

he did during the following seventeen days which he spent at the eclipse station, observing the prominences on the limb of the sun.

The achievement of Janssen was based upon principles which in 1866 had been placed before the scientific world by Sir Norman Lockyer. Owing, however, to regrettable delays in the delivery of the instrument which was ordered in the beginning of the year 1867, and being specially made for him from funds supplied from the Government Grant Committee, Lockyer did not receive it until October 16, 1868. He first used it on October 20, observing the bright lines which had been recorded in the August eclipse.

Both Janssen and Lockyer communicated the results of their discoveries to the Paris Academy of Sciences, and these despatches arrived a few minutes of each other on the same day. In honour of the joint discovery the French Government struck a special medal (Fig. 1).

NO. 2638, VOL. 105]

From the above it will be noticed that Lockyer gives the position of the bright yellow line as near D, and not coincident with D, D being the lines of emission of sodium previously referred to.

With regard to the behaviour of this line, Le states in a later communication (November 13, 1868):—

There is a line in the yellow, most probably proceeding from the substance which gives off the light at C and F, as the length of this line, as far as the later observations with the more correctly adjusted instrument go, is the same as that of those in C and F.

This statement shows that the yellow line behaved like the lines of hydrogen, and the view put forward then was that probably this line might be due to hydrogen also. The line was called  $D_3$  to differentiate it from the double line of sodium  $D_1$  and  $D_2$ .

A considerable amount of work was now done

with regard to  $D_3$ , for no substance was found in the laboratory which could produce this line.

By studying the behaviour of  $D_3$  in relation to the hydrogen lines, throwing the image of the sun's limb on to the slit of a spectroscope, Lockyer found that the lines were distorted—i.e. there were changes of wave-length due to movements of the material in the sun. The orange line was, however, observed to behave quite differently from either of the hydrogen lines, showing that a different substance was in question.

Hence [as Lockyer remarks] we had to do with an element which we could not get in our laboratories, and therefore I took upon myself the responsibility of coining the word *helium*, in the first instance for laboratory use. At the time I gave the name I did not know whether the substance which gave us the  $D_3$  was a metal like calcium or a gas like hydrogen, but I did know that it behaved like hydrogen, and that hydrogen, as Dumas had stated, behaved as a metal ("Sun's Place in Nature," p. 33).

In the following years numerous other lines in the sun and stars were found associated with the yellow line, but the origins of these were all *unknown* and designated as such.

It was not until the year 1895 that the terrestrial equivalent of this well-known yellow and other lines was discovered. "In the course of investigations on argon," so wrote Sir William Ramsay in a communication to the Royal Society (Proc. Roy. Soc., vol. lviii., p. 65) on March 26, 1895, "some clue was sought for which would lead to the selection of one out of almost innumerable compounds with which chemists are acquainted with which to attempt to induce argon to combine."

Acting on a suggestion by Sir Henry Miers, who directed attention to the work of Dr. Hillebrand in 1888 on the occurrence of nitrogen in uraninite, etc., Sir William Ramsay employed the mineral *clèveite*, essentially a uranate of lead containing rare earths. He treated this mineral, and from it extracted a small quantity of gas, which he subjected to spectroscopic examination. To use his own words, as printed in the above-mentioned communication:—

Several vacuum tubes were filled with this gas and the spectrum was examined, the spectrum of argon being thrown simultaneously into the spectroscope. It was at once evident that a new gas was present along with argon.

Fortunately, the argon tube was one which had been made to try whether magnesium poles would free the argon from all traces of nitrogen. This it did; but hydrogen was evolved from the magnesium, so that its spectrum was distinctly visible. Moreover, magnesium usually contains sodium, and the D line was also visible, though faintly, in the argon tube. The gas from *clèveite* also showed hydrogen lines dimly, probably through not having been filled with completely dried gas.

On comparing the two spectra, I noticed at once that while the hydrogen and argon lines in both tubes accurately coincided, a brilliant line in the yellow, in the *clèveite* gas, was nearly, *but not quite*, coincident with the sodium line D of the argon tube. Mr. Crookes was so kind as to measure the wave-length of this remarkably brilliant yellow line. It is 587.49

millionths of a millimetre, and is exactly coincident with the line  $D_3$  in the solar chromosphere, attributed to the solar element which has been named *helium*.

Thus was the terrestrial equivalent of the helium line discovered after an interval of twenty-seven years.

Solar observations had shown that this line was observed high in the chromosphere, indicating that the density of the gas should be very low. Special interest, therefore, attached to the determination of this important property. In a preliminary experiment Sir William Ramsay obtained 3.9 as a maximum number for the density of helium, oxygen being 16, thus showing that the surmise was correct. Soon after this discovery Lockyer prepared some of the gas from *bröggerite*, and established the fact that numerous lines, designated "unknown," in the spectra of the chromosphere, nebulae, and stars, were due to this gas.

Thus from an observation of the sun a new terrestrial gas was discovered, and from this terrestrial gas the origins of a host of unknown lines in the spectra of the heavenly bodies were explained.

Like hydrogen, helium has a wide diffusion in space, for not only is it in strong evidence in the hot stars, but it also must occur in such cooler stars as Arcturus, since this star is at about the same temperature as our sun, in which we know helium is present. In our atmosphere helium is one of the rarer constituents, being present in the proportion of about one volume in 250,000.

Up to the last few years the amount of helium which has been collected has been small, owing to the costly process of obtaining it, but during the war a demand for it in large quantities arose because of its lightness and non-inflammable nature. Helium is the lightest gas known next to hydrogen, of which it has about 92 per cent. of the buoyancy or lifting power. It was intended to supply a fleet of airships with this gas, and great fractionating plants were laid down in the United States of America capable of separating helium from natural gas at a very moderate cost. It was due to the above-mentioned demand that helium became more widely known, and attention was at once paid to bring together all the information that had been published about it as an aid to that enterprise.

The U.S. Department of Commerce took the matter in hand, and under Dr. S. W. Stratton, the director of the Bureau of Standards, a bibliography of scientific literature relating to helium was compiled. The information (more than 400 references) thus brought together has since (September 10, 1919) been published in pamphlet form in a Circular of the Bureau of Standards (No. 81), and will be found a very valuable source of reference.

The importance of helium to-day may be briefly summarised from the following extract from the introduction to this circular:—

Helium has probably been the most interesting of

all the elements to the theoretical scientist on account of the romantic history of its discovery, its occurrence in a remarkable condition of solid solution in many minerals, its formation as a product of the disintegration of the radio-active elements, its liquefaction after a decade of unsuccessful attempts by some of the world's greatest experimenters, the attainment by its use of temperatures below those at which the resist-

ances of pure metals vanish, its many unique physical properties, and the many important theoretical conclusions which have been drawn from its behaviour.

All of these points of interest have been the subjects of very thorough investigation. The important developments of the future will probably be along the line of the applications of helium, many of which have already been suggested.

### New Conceptions of Psychology.

THE results of Dr. Henry Head's clinical investigations<sup>1</sup> are exceptionally interesting from the philosophical point of view, for they are utterly incompatible with the older ideas of the introspective psychologists. In fact, his work is "a complete scientific refutation of all psychological theories which build up knowledge out of original sense-material" (NATURE, November 6, 1919, p. 267). Dr. Head has demolished the old psychology and created a new conception, in accordance with which "sensations depend neither for their existence nor for their psychical quality on the cerebral cortex, which has a purely interpretative function in regard to them."

The function of the cerebral cortex in sensation is to endow it with spatial relationships, with the power of responding in a graduated manner to stimuli of different intensities, and with those qualities by which we recognise the similarity or difference of objects brought into contact with the body. The old psychologists held that there was something in the external universe corresponding to primary sensations, which they regarded as being combined into the elements of perception. In accordance with such views the changes at the periphery were simple and became more complex the nearer they approached the highest centres in the brain. By submitting himself to a surgical operation in 1905 Dr. Head was able to demonstrate the complexity of the peripheral changes and the diffuseness of the impressions received. Moreover, by his clinical studies—monuments of patient research and marvellous insight—he has shown how these multitudes of diffuse peripheral changes gradually become integrated and rendered more specific in quality, space, and time as they approach the highest physiological levels in the central nervous system. The recognition of these facts gives an indication of the mode by which evolution has brought into existence such a nervous system as that of man. Lower, more impulsive, and less specific reactions become dominated by those that admit of choice. This conception turns orthodox psychology upside down.

Man's conceptions of space, time, and material rest ultimately on the nature of the spatial and temporal elements in sensation. These in turn are founded on complex physiological activities, many of which may never disturb consciousness directly; although they do not enter into the province of introspective psychology, they are responsible for much that is usually attributed to

the action of the mind. Dr. Head's work on the cerebral cortex represents the culmination of an intensive investigation of the sensory system upon which he has been engaged for more than a quarter of a century. In 1893 he was studying the phenomena of the localisation of the pain associated with visceral disturbances and incidentally mapping out the distribution of the sensory nerves. Then he began the analysis of the components of the sensory nerves; and to test the problems that called for solution he invited Mr. James Sherren to cut one of the main sensory nerves of his (Head's) arm, and with the help of Dr. Rivers he studied the process of the restoration of function in the severed nerve. By this means he was able to differentiate between the three kinds of sensory nerves distributed to his arm:—

(a) The deep afferent system supplying the connective-tissues, muscles, joints, and tendons, in virtue of which is conferred the power of recognising movement and appreciating the position of any part of the limb, as well as of localising pressure and responding to certain aspects of pain;

(b) A punctate afferent mechanism in the skin, which Dr. Head has called "protopathic," the primitive nature of which is shown by the early restoration to activity (a little more than six weeks in Dr. Head's arm) of its end-organs after the nerve has been reunited, by the specific nature of the response of each set of end-organs, and by the diffuse "all-or-nothing" nature of the response, *i.e.* the absence of any graduation corresponding to the intensity of the stimulus; and

(c) Superimposed over this older mechanism another cutaneous system of later development and higher functions, which Dr. Head calls "epicritic." Epicritic sensibility is not restored for many months after the reappearance of protopathic sensibility, the diffuse reaction of which is then checked and controlled; and the effects of stimulation are modulated according to the intensity and locality of the exciting agent. It is concerned with the finer degrees of tactile and thermal discrimination and is opposed to, and controls, the diffuse "all-or-nothing" reaction of protopathic sensibility.

It has long been known that the sensory paths in the central nervous system had a twofold terminus, represented by the thalamus and the cerebral cortex. It remained for Dr. Head to interpret the meaning of this arrangement. He

<sup>1</sup> "Sensation and the Cerebral Cortex," *Brain*, vol. xli., part ii., 1918.

showed that the thalamus is concerned with the affective side of consciousness, and deals with crude awareness to contact, heat, cold, and pain; while the sensory cortex exercises the rôle of discrimination and endows the basic functions of the thalamus with spatial qualities, intensity and relativity.

The war afforded Dr. Head the opportunity for testing his theories as to the functions of the sensory cortex on a large scale. He made an intensive study of fifty men with strictly localised bullet wounds of the post-central convolution and the areas adjoining it in front and behind: as the result he has revolutionised our conceptions of the nature of the work of the cerebral cortex.

Destruction of the sensory cortex causes a dissociation between the spatial and the qualitative aspects of sensation. The patient loses the power of recognising movements or the posture of the affected parts: he can no longer localise the position of the stimulus, or respond adequately to variations in its intensity: he has no idea of the size, shape, weight, or texture of an object in contact with his body. Yet he can appreciate the tactile, painful, and thermal aspects of the impressions it evokes.

Thus it is possible to recognise the qualitative aspects of a sensation without of necessity obtaining any information concerning the stimulating object, as a constituent of the external world. Sensory qualities, and the affective states with which they are associated, are in themselves discontinuous. They are relative to ourselves, and

appear and disappear in consciousness, without leaving any connective factor in the activities of the mind.

On the other hand, the projected aspects of sensation relate these qualities, not to ourselves, but to the external world. An "object" might be defined as a complex of projected sensory responses. These functions of the cortex are not only responsible for sensory projection in space, but also ensure recognition of sequence in time.

The power of recognising serial movements in both space and time seems to be based on the same physiological processes. They give us a direct appreciation of succession: this is translated into sensations of serial movement in either space or time, according to the nature of the concomitant sensory impulses.

These physiological responses, which are so clearly bound up with the activities of the sensory cortex, are characterised by a strict dependence on past events. All projected sensations leave behind them a coherent train of physiological dispositions: thus a movement occurring at one moment is measured against the consequences of those which have preceded it.

It is difficult to estimate the magnitude of the vast revolution in our conception of the functions of the cerebral cortex that we are witnessing. Moreover, Dr. Head's work lays the foundation of a new and true psychology and illuminates the age-long problem of the relationship of body and mind. It is a matter for just pride that we owe this new vision to an Englishman.

### Obituary.

PRINCIPAL R. M. BURROWS.

KING'S COLLEGE and the whole University of London have suffered grievous loss by the death of Dr. Ronald Burrows. Born on August 16, 1867, Dr. Burrows went from Charterhouse to Christ Church, Oxford, with a scholarship, and took his degree in 1890 with first class honours in Classical Moderations and *Literae Humaniores*. After five years as assistant to Prof. Gilbert Murray, who then held the Greek chair at Glasgow, he was appointed professor of Greek at Cardiff in 1898, and rejoined his Cardiff colleague, Dr. R. S. Conway, as Greek professor in Manchester in 1908. By travel, during these years, in the Mediterranean, he had gained valuable experience of topography and excavation, and also that firsthand knowledge of the modern politics of Greece and the Balkan States which served him so well in later years. His published work, mainly about Greek battlefields, ancient sites in Beotia (where he conducted most instructive excavations at Rhitsona and the Delion), and the newly revealed Minoan civilisation, gained him the degree of D.Litt. in the University of Oxford in 1910, and his "Discoveries in Crete," published in 1907, went into a third edition.

An excellent scholar, a vigorous and fluent

writer, and a teacher of untiring drive and wide humanity, Dr. Burrows contributed much to "save Greek" during a difficult period by the simple and characteristic method of making his pupils interested in it, and infecting them with his own keenness; and this did not stop "out of school." His lifelong interest in young lads, and his strenuous and successful work for the Cardiff University Settlement and for the Ardwick Lads' Club at Manchester, were for him all of a piece with the "humanities" of which his Greek studies should be the crown. He enjoyed life and enjoyed people, and his sunny temper and good fellowship were the happy counterpart of his learning and judgment.

Dr. Burrows moved from Manchester to King's College as principal in 1913, at a time of crisis and manifold difficulty. Apart from other qualifications, he had, as was said, "more bishops in his family" than had all the other candidates put together, and more experience, too, than most of other "happy families" where sciences and arts could "live and let live." His width of interests and sympathies, enabling him to bring in new subjects to restore the balance between them and the old; his ready speech and debating skill; and his real grasp of principles and policies, gave him a position which experience con-



firmed. The college organisation for modern languages, literatures, and national histories, which best commemorates him, was conceived and founded just in time for the war, which so fully endorsed his foresight and amplified his opportunities, less perhaps among the Romance languages than in the Slavonic and modern Greek departments which lay nearest to his personal interests. Knowing as intimately as he did the problems and the possibilities of the city-state world of ancient Greece, he was able in an exceptional way to interpret here the ideals, no less than the failures, of the Balkan peoples, whom he understood and impressed like the naughtier boys in his settlement clubs. Honours conferred by the Greek and Serbian Governments, and the close personal relations which he maintained with leaders such as M. Venizelos and President Masaryk—the latter one of his professors until his own country claimed him—are testimony enough on this side, and he just lived to see in the act of realisation much for which he had long striven. Such a man would not spare himself, and he would lavish help and encouragement along the whole breadth of his interests at times when only the greatest prudence could have preserved his health; but so he loved to live.

WE regret to announce the death in London on May 6 of DR. J. HAMILTON FULLARTON, so long associated with scientific fishery research in Scotland. Dr. Fullarton was born at Brodick, Arran, in 1856. He had a distinguished career as a student at Glasgow University, taking many prizes and bursaries, and graduated M.A., with the highest honours in natural science, in 1881, and D.Sc. ten years later. After acting for some years as assistant to the professor of natural history in his *alma mater*, Dr. Fullarton entered the service of the Fishery Board for Scotland as a naturalist on the scientific staff in 1889, a post which he held for eight years. On quitting the Fishery Board service, Dr. Fullarton studied medicine with a view to a medical career, and received the qualifications of L.R.C.P. and L.R.C.S.(Edin.). After serving for a short period as medical officer on an Atlantic liner, he settled in London as a consultant, and gradually built up a considerable practice. Prior to this, on the initiation of the international fishery investigations, Dr. Fullarton re-entered the service of the Fishery Board, and did valuable work for a year in the supervision of the scientific investigations on board the research steamer *Goldseeker*. It is as an expert on fisheries that he will be chiefly remembered in scientific circles. He devoted himself in particular to the study of shellfish, such as the common edible mussel, the oyster, the cockle, and the "clam," and wrote numerous papers on their cultivation and natural history. In connection with this branch of his fishery work Dr. Fullarton on more than one occasion visited the districts in France and Holland where oyster-culture and mussel-culture are principally carried on. He also made

a useful series of researches on the breeding and development of the European lobster.

THE death is announced at Copenhagen of the well-known Danish philologist, PROF. L. F. A. WIMMER, at eighty-one years of age. Prof. Wimmer was the author of an important book on the Runic alphabet, "Runeskriftens oprindelse og udvikling i Norden," published in 1874, in which he suggested that the Runes were really Latin letters adapted for carving in wood, and of four volumes on Runic inscriptions in Denmark. In several of the Sagas it is recorded that Runes were inscribed on round pieces of wood, called *Kefli*, or Runic sticks. It has been suggested that the Eddas were recorded in this way, but the evidence is not quite satisfactory.

THE bearer of a name highly esteemed in botanical circles has just passed away in the person of AUGUSTIN PYRAMUS DE CANDOLLE, who died at Vallon, near Geneva, on May 9, at the age of fifty-one, surviving his father only eighteen months. The family is of French origin, but for four generations it has been settled at Geneva, adopting the local fashion of employing a capital letter for *De*. Born in England in 1869, the late botanist visited our shores on many occasions; in 1889 he came to London to receive the Linnean gold medal awarded to his grandfather by the Linnean Society of London, and in 1904 he attended the British Association meeting at Cambridge. He published but little, only about a dozen short memoirs on systematic descriptions of new plants from Madagascar and Tonquin, on parthenogenesis, and on the influence of electricity on the germination of seeds. He filled the office of president of the Société Botanique de Genève in 1905. The brilliancy of the line was shown in the great-grandfather, A. P. De Candolle (1778-1841); grandfather, Alphonse De Candolle (1806-93); and father, Casimir De Candolle (1836-1918).

BY the death, on February 27, of ALFRED J. MOSES, professor of mineralogy at Columbia University, the science of mineralogy has lost (says "H. P. W." in *Science*) one of its most eminent and valued exponents. Prof. Moses's work as a teacher, as a writer, and as a scientific investigator can scarcely be too highly esteemed, and his loss to all branches of his profession is most keenly felt. His text-book on "Mineralogy, Crystallography, and Blowpipe Analysis" will for many years remain the standard in a large majority of the universities in which courses in these subjects are given. His work on "The Characters of Crystals," published in 1899, is the first treatise published in America upon physical crystallography, a branch of crystallography which was early recognised by him as of primary importance to chemists, geologists, and mineralogists, and has within very recent years assumed a scope and developed practical applications which have more than justified his early visions of its future.

### Notes.

THE general meeting of the Linnean Society on June 17 will be devoted to a celebration of the centenary of Sir Joseph Banks (1743-1820) with essays on various aspects of his life-work, and an exhibition.

DR. H. D. CURTIS, astronomer at the Lick Observatory, has been appointed director of the Allegheny Observatory in succession to Dr. Frank Schlesinger, who assumed charge of the Yale Observatory on April 1.

THE Linnean Society has elected the following as foreign members:—Prof. Gaston Bonnier, Prof. Victor Ferdinand Brotherus, Prof. Giovanni Battista de Toni, Prof. Louis Dollo, Prof. Paul Marchal, and Prof. Roland Thaxter.

THE Natural History Museum Staff Association has arranged a special scientific reunion to be held at the museum (by permission of the Trustees) on Thursday, June 3, at 3.30 p.m., in connection with the Imperial Entomological Conference. The exhibits which will be shown will illustrate some of the problems of economic interest, or arising out of the war, which have been studied at the museum during the past few years.

THE motion for the second reading of the Importation of Plumage (Prohibition) Bill was carried in the House of Commons on May 14. Lt.-Col. Archer-Shee expressed a wish to propose that it be an instruction to the Standing Committee by which the Bill will be considered to insert a schedule of the birds the plumage of which should be prohibited from importation, but the Speaker pointed out that it would be out of order to give a mandatory instruction to a Standing Committee, which could, if it wished, take such action without any instruction.

A NOTICE from the Department of Anatomy, Johns Hopkins Medical School, Baltimore, Maryland, informs us that the Ellen Richards research prize offered by an association of American college women, hitherto known as the Naples Table Association, is available for the year 1921. This is the tenth prize offered. The prize has been awarded four times, twice to American women and twice to English-women. The competition is open to any woman in the world who presents a thesis written in English. The thesis must represent new observations and new conclusions based upon laboratory research.

THE medal of the Society of Chemical Industry for 1920 has been awarded to M. Paul Kestner in recognition of his distinguished services to chemical industry. The medal is awarded biennially, and among the recipients in recent years have been the Right Hon. Sir Henry Roscoe (1914), Mr. C. F. Cross (1916), and Sir James Dewar (1918). M. Kestner was born in Alsace prior to the German occupation in 1871; he was one of the chief founders and the first president of the Société de Chimie Industrielle in France, which was established in 1917. He has been connected with engineering as applied to chemical industry throughout his career, and among his more notable achieve-

ments are the use of forced draught in acid towers, automatic acid elevators, the climbing film evaporator, the scaleless water-tube boiler, and several inventions in connection with beet-sugar manufacture.

AN invitation from the Mayor and Corporation of Barrow-in-Furness to hold the annual autumn meeting of the Institute of Metals in that town on Wednesday and Thursday, September 15 and 16 next, has been accepted by the council of the institute. Particulars of the meeting can be obtained from the secretary, Mr. G. Shaw Scott, 36 Victoria Street, S.W.1; who will also be glad to forward tickets for the tenth annual May lecture, which will be delivered by Prof. C. A. F. Benedicks, of Stockholm, at 8 p.m., on June 10, at the Institution of Mechanical Engineers, Westminster, the subject of the lecture being "The Recent Progress in Thermo-Electricity." The president, Engineer Vice-Admiral Sir George Goodwin, K.C.B., will preside.

A SHORT account of the Department of Scientific Research and Experiment, which the Admiralty has set up under the Third Sea Lord, was given in NATURE of April 22, p. 245. A vote for 302,000*l.* for scientific services under the Navy Estimates was agreed to in Committee of the House of Commons on May 17. Mr. Long, in reply to points raised concerning this vote, said that after an investigation into the conditions the Government decided to ask the Lord President of the Council, who was specially charged with the care of all scientific work in the country, to set up a Committee to inquire into the whole of the work done in the Government Departments in order to prevent overlapping, and to prevent two Departments doing the same work. The Admiralty had appointed a Director of Scientific Research at Teddington, where they were going to concentrate on naval scientific research. When it came to sea-water research they proposed that that should be carried out at the sea-ports. Teddington would be carried on this year, but they hoped that before the end of that time they would have the benefit of the report of the Lord President's Committee, and they would then be in a position to avoid overlapping and duplication of work. The Admiralty would not hesitate to ask Parliament for such money as they thought necessary to give the fullest effect to scientific research and the development of the results of that research. The sum of 430,300*l.* was voted for educational services, and Mr. Long said in connection with it that the departure, taken only recently, under which reception was secured at the University of Cambridge for a certain number of naval officers as undergraduates, had abundantly justified itself. He assured the Committee that the Government is extremely sympathetic to this scheme, and hopes to increase the number of officer undergraduates.

AN interesting conference on "The Relations of the Inventor to the State," organised by the Institute of Inventors, was held at the rooms of the Royal Society of Arts on May 13. The discussion was opened by Mr. D. Leechman, who gave a good *résumé* of the present state of the patent law in the light of the new Patent Act. It was remarkable that in a meeting

of this kind the whole of the speakers were unanimous in condemning the present attitude in official circles towards inventors. It was stated by more than one speaker that those who came forward during the war with ideas and inventions that had made our success possible had not only received no reward, but had in several cases been deprived even of the merit of their ideas by officials who were themselves devoid of the necessary technical or scientific knowledge. The chairman, Mr. Walter F. Reid, stated that the working of the Royal Commission on Awards to Inventors supplied abundant evidence of the difficulty experienced by inventors in obtaining any recognition. Although large sums were now being devoted to research, he pointed out that such work was only the raw material for the development of industry; it was the application of that raw material by the inventor which resulted in the advance of industrial processes. The mass of facts as ascertained by research was already enormous; what is now required is inventive genius to make use of those facts, which Mr. Reid compared to the bricks and stones with which an architect might produce a building, but which by themselves were of little practical use.

INFLUENZA, according to the Registrar-General's return for the week ending May 1, continues greatly on the decline over the whole country, the deaths for the ninety-six great towns numbering only 202 and in London 45. For the twenty-eight weeks from October 25, 1919, to May 1, 1920, during which influenza was practically epidemic, the deaths from the disease in London were 1160, and the deaths from all causes 35,276. Deaths from influenza were 3 per cent. of the total deaths, whilst the deaths from pneumonia were 11 per cent. and from bronchitis 10 per cent. Between the ages 0 and 20 the deaths from influenza were 15 per cent. of the total, 20 to 45 years 36 per cent., 45 to 65 years 28 per cent., and above 65 years 21 per cent. The age-incidence of the deaths calculated on the total deaths for the several ages was respectively 4 per cent. for 5 to 20, 8 per cent. for 20 to 45, and 4 per cent. for 45 to 65. The insignificance of this is shown when compared with the deaths during the virulent epidemic of 1918-19, in which during thirty-one weeks from October 19, 1918, to May 10, 1919, the deaths from influenza were 47 per cent. for ages 5 to 20 of those for the corresponding ages from all causes, 52 per cent. for 20 to 45, and 22 per cent. for ages 45 to 65. During the three weeks ending April 10, the worst stage of the present epidemic, the deaths between 20 and 45, the ages attacked most severely, were only 21 per cent. of the total deaths from all causes, whilst in the epidemic of 1918-19 the deaths for ages 20 to 45 in the three weeks ending November 16, 1918, were 73 per cent. of the total at the corresponding ages from all causes. In the present epidemic deaths were most numerous during a spell of exceptionally mild weather.

A BRIEF, but very interesting, study of the pygmies of Central Africa by Mr. Herbert Lang appears in *Natural History*, the journal of the American Museum of Natural History (vol. xix.), and its value is further enhanced by a number of most excellent photographs. Anthropologists will welcome this contribution, since

it summarises the results of a prolonged study of these people made during the American Museum Congo Expedition (1909-15). During that time more than a hundred life-masks, representing sixteen different tribes of Central African races, were taken. Some extremely useful observations on the physical characteristics of the pygmies are made, as well as on their mode of life, customs, and language. By way of a supplement, perhaps, to Mr. Lang's paper, this number also contains an essay on "The Pygmy Races of Man," by Mr. Louis R. Sullivan, of the Anthropological Department of the American Museum, illustrated by a number of useful tables and diagrams.

THE eighteenth annual report of the Rhodesia Museum, Bulawayo, affords instructive reading. It is evident that but for the assistance the museum is able to afford the mining industry it would cease to exist. The public generally seems to regard the institution, at most, with but a mild interest. Hence, from lack of funds, every aspect of its work is hampered. The building is all too small to house its collections, and the provision made for the storage and exhibition of specimens is utterly inadequate. It is more than probable that if a better display could be made enthusiasm might be kindled. This state of affairs is lamentable, for, as matters stand, it is impossible to secure that record of the fauna and flora of this important area of Africa which is so essential in a country being rapidly transformed by the march of civilisation. Dr. G. Arnold, the curator, is evidently having an uphill fight; but, in the interests of science, it is to be hoped that the tremendous possibilities of a well-organised museum will soon be realised.

THE Pueblo stage of culture in south-western Colorado, New Mexico, Arizona, and Utah, the domain of the cliff-dwellers, has naturally attracted much attention. The material for studying it is wide and scattered, and it is well that a competent archaeologist, Mr. J. W. Fewkes, has prepared a monograph on the subject, entitled "Prehistoric Villages, Castles, and Towers of South-Western Colorado," published as Bulletin No. 70 of the Bureau of American Ethnology. The general conclusions at which Mr. Fewkes has arrived are: The buildings express the communal thought of the builders, since they were constructed by groups of people rather than by individuals. The view that either the Pueblo people were derived from Mexican tribes or, as it was customary in the seventeenth and eighteenth centuries to suppose, their descendants had made their way south and developed into the more advanced culture of the Aztecs, is not supported by architectural data observed among these two peoples; it is preferable to assume that the custom of building stone houses was not derived from any locality not now included in the Pueblo area, but that it developed as a local growth, the earliest stages, as well as the most complex forms, being of local origin. That the buildings antedate the coming of the white men is shown by the absence of mention of them in any history; no European objects have been found at the Pueblos, and the buildings and pottery have no affinity with any villages inhabited when the Spanish entered the south-west.

EXPERIMENTS with the Amphipod *Gammarus chevreuxi* by E. J. Allen and E. W. Sexton at the Plymouth Marine Biological Laboratory (*Journal of Genetics*, vol. ix., No. 4) have disclosed several mutations in eye-colour. In the wild animal the retinal pigment is black. A single individual with red eyes appeared in the second generation from animals brought into the laboratory, and the new character was inherited as a simple recessive. An albino-eyed type also appeared, in which the eyes differed in many structural features from the normal type. Another mutation, by no means uncommon, consists in the loss of the white pigment normally present between the ommatidia of the eye. This may appear suddenly or gradually, or may develop in the animals as they grow older. White-spotting also occurs on the bodies of these animals occasionally, but the rules of its inheritance show complications, and a pure spotted race has not been obtained.

In March of 1917 the Board of Agriculture and Fisheries appointed a Committee to consider the fresh-water fisheries. Attention was directed to the use of coarse fish as food, to the development of the eel fisheries, and latterly to the improvement of the salmon fisheries. Two interim reports were issued, and as a result of these the Board made an Order in March, 1918, extending, as a war emergency measure, the season of capture of coarse fish by one month. This Order was revoked in the spring of 1919. A further Order removing restrictions on eel-fishing and abolishing the close season for pike was made in April, 1918, and revoked in October, 1919. Dealing with the eel fisheries, the Committee recommended that the factory on the Severn owned by the German Fisheries Union should be taken over, and, "after prolonged negotiations," this was done. The factory exported some five millions of eelers annually to Germany before the war. Arrangements were made to carry it on, and in 1918 and 1919 about 2½ millions of eelers were distributed throughout this country. The Committee hopes this work may be continued regularly. In its final report, now published, practical methods of eel cultivation are dealt with, and the necessity for investigation into the biology of fresh-water fishes in general is discussed. Recommendations are made with regard to the pollution of rivers, improvements of the latter as breeding-grounds, and the consolidation of the law as to fresh-water fisheries. Practical suggestions for the cultivation of carp are given in an appendix.

MR. W. B. WRIGHT, of the Geological Survey of Ireland, has made "An Analysis of the Palæozoic Floor of North-East Ireland, with Predictions as to Concealed Coalfields" (*Sci. Proc. R. Dublin Soc.*, vol. xv., No. 45, 1919, price 1s. 6d.). Mr. Wright accompanies his careful reasoning as to the synclines and anticlines produced by the Armorican and later foldings by a coloured geological map showing the intersections of two systems of folds, and therefore the probable domes and basins. He relies much on the repetition of similar fold-features in the same area during successive geological periods—that is, on the

principle of posthumous folding on which R. A. C. Godwin-Austen based his prediction of the Dover coalfield. It is no secret that the deep boring put down recently by the Ministry of Munitions on the west shore of Lough Neagh in accordance with the arguments of Mr. Wright has more than proved his main contention, the Carboniferous rocks, on the line of the Armorican syncline of Central Scotland, having been carried down by Cainozoic sinking to depths completely unexpected.

THE issue of the *Revue scientifique* for February 14 contains Prof. G. Friedel's opening address on his installation in the chair of mineralogy at the University of Strasbourg. Prof. Friedel, himself an Alsatian by birth, looks forward to the development of research in a university that will never become the slave of politics or the mere servant of industrial ideals. He says finely: "La science n'est pas la servante de l'industrie, elle en est la mère." His address deals with the insight given by the use of X-rays into crystalline and molecular structure, and he describes the work inspired by Laue, of Munich, in 1912 as "la plus belle assurément et la plus riche en promesses de la cristallographie récente." In the developments made by Sir W. H. and Prof. W. L. Bragg he perceives the end of our conception of the existence of molecules as such within a crystal, and a realisation of the crystal as one enormous molecule, in which the grouping of the atoms does not permit of a division into similarly constituted particles corresponding with the molecules of the chemist.

WE have received from Koninklijk Magnetisch en Meteorologisch Observatorium, Batavia, the volumes of rainfall records in the Dutch East Indies for the years 1915, 1916, and 1917 (*Regenwaarnemingen in Nederlandsch-Indië*). The records are remarkably complete, and comprise data from several thousand stations scattered throughout the islands. There is no discussion of the data, but the volume for 1915 gives the mean of more than three hundred stations for the period 1879 to 1915. The same volume gives useful notes on the position and equipment of the various stations.

THE Koninklijk Nederlandsch Meteorologisch Instituut has published the first part of an oceanographical and meteorological folio atlas of the Atlantic Ocean under the editorship of Dr. E. van Everdingen, director of the institute. The present part covers the months of December, January, and February, and is based on observations from 1870 to 1914. It follows the lines of the previous work on the Indian Ocean, and utilises mainly the observations of Dutch vessels, but these are supplemented by data from the Meteorological Office, London, and the Deutsche Seewarte. Maps for each month show the distribution of wind, currents, sea- and air-temperature, cloudiness, and floating ice. The volume of data which was to accompany the atlas has been delayed in publication.

THE current (April) part of the Proceedings of the London Mathematical Society is of melancholy

interest because it contains the conclusion of the late E. K. Wakeford's paper on canonical forms. The paper is remarkable for its generality and the simplicity which it gains by the use of the theory of apolarity. Moreover, certain results follow almost intuitively from known geometrical facts, e.g. the general ternary quartic cannot be expressed as the sum of five fourth powers, because the square of the conic through five points may be regarded, in this connection, as a quartic with double points at all of them. This example is interesting historically, because the original (and different) proof of the theorem in question was one of the first to show the untrustworthiness of the method of counting constants. Wakeford's premature death will be deplored by all who can appreciate the brilliance and originality of his work.

THE April issue of the Journal of the Röntgen Society contains the communication made to the society at a recent meeting by Prof. E. T. Jones on the action of the induction coil. By means of an electrostatic oscillograph Prof. Jones has investigated the effects on the potential of the secondary of the coil, both on open circuit and when connected to an X-ray tube, of changes in the capacity of the condenser shunting the break, and in the degree of coupling between the primary and secondary of the coil. He finds that the effects correspond closely with those to be anticipated on the theory that in the secondary on open circuit the potential after break consists of two component waves, which begin in opposite phase and have amplitudes inversely proportional to their frequencies. He considers that induction coils can be further improved by investigating and reducing the losses in the iron cores of the coils, by introducing interrupters which will break stronger currents without such large capacities in parallel with them, and by determining the best method of adjusting the coupling between the primary and secondary, either by alteration of their relative lengths or widths or by other means.

A VERY interesting example of the progress which has taken place during recent years in electric power supply is presented in a paper by Mr. J. S. Watson read on April 30 before the North-East Coast Institute of Engineers and Shipbuilders, in which he gave a brief historical sketch of the development of the generating stations of the Newcastle-upon-Tyne Electric Supply Co., the principal pioneer of electric power supply on a large scale in this country. Dividing the twenty-nine years of this company's activity into stages, Mr. Watson traced the progress from a small station with 2400 kw. in 200-kw. units to the latest addition, the Carville "B" station, with its five 10,000-kw. turbo-generators. Among the many important features referred to is the gradual decrease in steam consumption per kw.-hour from 28.5 lb. to 10 lb. An equally interesting comparison lies in the plant capacity per square foot of floor-space occupied, which is 15 kw. as against 0.3 kw., and other figures showing gain in economy are those of kilowatt capacity per man employed in the station—633 kw. and 141 kw.

respectively. These improvements are attributable mainly to increases in boiler pressure, steam temperature, speed of revolution and size of unit, and to more complete utilisation of labour-saving appliances. Another no less important feature of the scheme is the running in parallel with the steam-driven stations of "waste-heat" generating plants at various points on the network utilising on a considerable scale by-product energy from coke-ovens and blast-furnaces.

IN a paper on the economics of the petroleum industry read recently by Mr. R. S. Dickie at the Imperial College of Science and Technology, there appears a series of well-justified criticisms relative to the geological, chemical, and engineering procedure of the producing companies. Such subjects as the proper spacing of well-sites, the economical utilisation of fuel by the provision of heat and cold inter-changers, the preposterous waste in the current use of boiler-stills, the insufficiency of our present knowledge of lubrication and lubricating oils, the need for research on blended motor-fuel, and the possibilities of recovering valuable components from the crude oil by methods other than distillation were briefly touched upon. Among the more interesting statements made is the following: The greatest producing well is No. 4 Potrero del Llano (Mexican Eagle Co.), which ran wild for ninety days, flowing at the rate of 100,000 barrels per day. In the eight years of its life it produced 100,000,000 barrels of oil (1 barrel = about 45 English or 50 U.S.A. gallons).

We have received from Messrs. A. Hilger, Ltd., 75A Camden Road, N.W.1, an attractive catalogue of their well-known wave-length spectrometer with high resolving power accessories, including the Lummer-Gehrcke parallel plate, the Fabry and Perot etalon, and the Michelson echelon diffraction grating. At a time when the structure of spectra is receiving so much attention from physicists it is good to know that a British firm can still assist in supplying the very necessary "munitions" in the form of efficient scientific apparatus. As is well known, this firm has been able very largely to control the effects of lack of homogeneity in glass by interferometer methods, which should considerably improve the performance of such instruments.

READERS of NATURE in search of book bargains should obtain and consult Catalogue No. 187 just issued by Messrs. W. Heffer and Sons, Ltd., Cambridge, in which some 331 books in new and perfect condition are listed at greatly reduced prices. Among the works relating to science we notice the "Scientific Papers" of Prof. J. C. Adams; sets in different bindings of "Biologia Centrali-Americana," also separate sections of the work; Prof. J. Stanley Gardiner's "The Fauna and Geography of the Maldives and Laccadive Archipelagoes"; Hagen's "Atlas Stellarum Variabilium"; Hewitson's "Exotic Butterflies" and "Illustrations of Diurnal Lepidoptera"; Leech's "Butterflies from China, Japan, and Corea"; and a set of "The British Bird Book," edited by F. B. Kirkman.

### Our Astronomical Column.

A BRIGHT FIREBALL.—A splendid meteor was seen on May 9, 9h. 10m. G.M.T., from Bristol, Cardiff, London, Weston-super-Mare, and other places. Special interest attaches to the object, for it appears to have descended to very near the earth's surface, if, indeed, it did not actually fall to the ground. The meteor traversed a path of about 60 miles in  $\frac{5}{8}$  seconds, and fell from a height of 54 to 12 miles. Combustion occurred over Radnor Forest, and the meteor apparently disappeared over a point 10 miles east of Barmouth. If the object was enabled to travel in a compact form about 15 miles further, it must have alighted on the ground in the region some ten miles south of Bangor, Carnarvonshire, but no intimation has yet been received that a meteorite has been found, or was seen to fall, there.

CONJUNCTION OF MERCURY WITH  $\epsilon$  GEMINORUM.—Mr. A. Burnet, of Oxford University Observatory, makes a special study of occultations of stars by planets. He now points out a close approach of Mercury to the third-magnitude star  $\epsilon$  Geminorum on June 11. The position of the star is R.A. 6h. 39m. 1.73s., N. decl.  $25^{\circ} 12' 33.8''$ . Mercury is in the same R.A. at 9h. 7m. G.M.T.,  $14''$  south. The semi-diameter and parallax are  $2.9''$  and  $7.7''$ , so that an occultation will not happen at any part of the earth. The hourly motion of Mercury is  $+194s.$ ,  $S. 55.8''$ . Hence conjunction in declination occurs at 8h. 52m. Micrometer measures of the differences of R.A. and declination of planet and star will be of value, especially as Mercury is a difficult object to observe on the meridian. The sun sets in London at 8h. 14m., and Mercury at 9h. 50m. The times throughout are given in G.M.T., not summer time. It is rather unfortunate that the date coincides with that of the Royal Astronomical Society's meeting, as that will prevent some astronomers from observing it.

LONGITUDE BY WIRELESS TELEGRAPHY.—This subject was discussed at the geophysical meeting at the Royal Astronomical Society on May 7. Prof. Sampson, Astronomer-Royal for Scotland, pointed out that wireless telegraphy supplied the long-sought desideratum of signals that could be received simultaneously over the greater part of the earth's surface; in the past eclipses of the moon or Jupiter's satellites, lunar distances and occultations had been employed, but the new method gave far higher accuracy. He formulated a scheme in which three observatories at longitudes some  $120^{\circ}$  apart, or, if preferred, four observatories  $90^{\circ}$  apart, should each receive the signals of suitably placed wireless stations and note their local time in the usual manner by meridian observations. The method would determine both the longitudes of the stations and the periodic errors in the assumed clock-star places, since different clock-stars would be on the meridian of each observatory at the time of each signal. No extreme accuracy is called for in the time of sending out the signal, since the method is wholly a differential one. Interchange of observers is not contemplated; this has hitherto been the practice in longitude determinations, but the new method contemplates using the ordinary observations with the standard instrument of each observatory for a considerable period. There will thus be several observers, and if the travelling-wire method is adopted very little error will be introduced by personal equation. Plans are already far advanced for connecting Greenwich with Sydney in this manner.

A demonstration was given of the method of recording the wireless signals on a chronograph by the use of a Fleming valve. The ticks of a chronometer,

transmitted by a microphone attached to the glass, were simultaneously recorded. The chief difficulty was stated to be not the weakness of the transmitted wireless signal, but the frequent confusion produced by atmospherics.

### Periodicity in Weather and Crops.

IT is generally understood that the principal source of terrestrial weather changes is to be found in solar radiation. Inasmuch, therefore, as the yield of crops depends very largely on the weather, it is quite natural to assume that any periodicity in the solar radiation is likely to be reflected in the world-harvests and the price of food. Many investigations have had for their object the testing of a direct correlation between solar activity, as evidenced by sun-spots, and such terrestrial phenomena as the Indian monsoon in regard to drought and famine. The mechanism of world-weather is exceedingly complex, but progress is steadily being made in elucidating the cause of the numerous departures from obedience to any simple general law.

The next step, after comparing terrestrial phenomena with the known sun-spot period, was to analyse various sets of data in search of unknown periodicities, and Prof. Turner, for example, goes so far as to connect what he calls "chapters" of meteorological history with the movement of the earth's pole that produces latitude variation. There is, however, one very great difficulty in fixing any period the physical basis of which is unknown, and that is the incommensurability of all the suggested periods with that of the earth's revolution round the sun. It is obvious that a dry period occurring exactly at sun-spot maximum, for example, if such a phenomenon should be persistent, and if, which is another difficulty, the sun-spot maximum were an exact predictable moment, would have a totally different influence on the harvest according to the time of year at which the drought occurred. The effect would also be quite different in different parts of the world, notably on the two sides of the equator.

On Wednesday, May 12, Sir William Beveridge, Director of the London School of Economics and Political Science, delivered a lecture on the subject of a hitherto unrecognised periodicity in the weather and the crops. From the *Times* report of the lecture we gather that he rather discredits the "sun-spot" influence, at least in the form advanced by Prof. Jevons nearly half a century ago, and produces ostensibly consistent evidence in favour of a period of  $15\frac{1}{2}$  years during the past three centuries. The argument rests upon historic records of poor harvests, of Indian famines, of tropical droughts and equally disastrous wet summers in higher latitudes, and also to a great extent upon official statistics of food prices.

There is no indication in the report that attention was paid to such obvious matters as war and plague, which would have an enormous effect on prices. The meteorologists of the next century will not, we hope, attribute the high prices under which we are now suffering to a periodic meteorological influence. Sir William Beveridge has succeeded in setting forth a list of dates at approximately equal intervals, and claims that every one corresponds to a period of high prices. He admits that there were other times of similar conditions not belonging to the series he claims to have discovered, and he also allows an occasional uncertainty of something less than five years, but he warns us to expect most unseasonable weather, bad harvests, and high prices, with possible famines, in one or more of the years 1924, 1925, and 1926.

From the summary of the evidence produced it is quite possible to extract some comfort. Sir William Beveridge's appeal to the barometer makes it clear that he regards a low mean annual pressure as a direct indication of bad harvests, and points to the years 1878, 1893, and 1909 as the three years of lowest pressure in a forty-year period over the greater part of the habitable globe. It is, on the face of it, practically impossible that the pressure over the whole earth should vary from year to year; so perhaps we are to assume a higher selective pressure over the ocean areas in such years. In any event, we were very fortunate in this country in 1893 with a glorious summer, shared also by France, in spite of the world-conditions. There is another aspect which must not be ignored, and that is the physical basis on which the period depends. The lecturer contented himself with suggestions of a combination of periods of shorter length, hinting that 15½ years is a sort of least common multiple of two or more of these. The actual figures given are, however, singularly unconvincing. Sir William Beveridge mentions a meteorological period of just over five years, without any details in support of it, and couples this with "the important 2½-year cycle." Is this a period in itself, or is it merely one of the harmonics of the 11-year sun-spot period? He says eleven of these make two of his 15½-year periods; so if the 2½-year period is really "important," his new one should be 30½ years. What is apparently important, as we remarked before, is the 12-month period, and this would indicate 46 years as a super-period, but there is no indication of any specially bad harvests at every third period in his table.

Sir William Beveridge's forecast for 1924-5-6 is given with some diffidence, showing that he is not too confident of the reality of the period, and it is not likely that he has made much impression on the devotees of the sun-spot period, which has been claimed to show direct correlation with such different phenomena as the price of wheat and the number of fellows of the Royal Astronomical Society.

One last question we might raise is: Does fine weather necessarily mean lower food prices, considered in the light of the suggestion that strikes and labour unrest are generally regarded as fine-weather phenomena? W. W. B.

### The National Food Supply.

SIR DANIEL HALL, in the first of his three recent Chadwick public lectures on "Gardening and Food Production," dealt with the national food supply and the possibility of self-support. According to the values obtained by a committee of the Royal Society for the five-year period prior to the war, only 42 per cent. of the total food supply consumed in the United Kingdom was produced at home. At the beginning of the nineteenth century the country was practically self-supporting, but since that time the population has greatly increased, while the productivity has decreased. In 1872 there were 14 million acres under the plough in England and Wales, but by 1914 nearly 4 million acres of this land had been put down to grass. Grass land is comparatively unproductive of food as compared with arable land, for, according to Sir Thomas Middleton's calculation, 100 acres of arable land in this country normally produce food that will maintain eighty-four persons, whereas the same 100 acres under grass will maintain only fifteen to twenty persons. The great difficulty is that arable land requires much more labour than grass land, and farmers naturally refrain from ploughing up their land when

the cost of labour has risen very much more than have the prices of the produce. In 1917-18 another 2½ million acres were added to the acreage already under the plough, but the food crisis is not yet over. It is essential that we should increase our productivity, and to attain this end we must agree to pay the prices necessary to make arable farming reasonably profitable to the farmer. Moreover, the population will have to change its habits and eat more bread, potatoes, etc., than meat, while pork will have increasingly to replace the more expensive animal foods.

The second lecture was concerned with the development and uses of allotments. The history of allotments appears to go back to a very early date; for from the time of Henry III. onwards there are statutes dealing with pieces of cultivated land of the allotment type. The first period of active growth of the allotment scheme was in the nineteenth century, when the industrial system and the large towns developed. A noteworthy example is the still flourishing group of allotments started by the late Sir John Lawes on his Rothamsted estate, in connection with which a club-house for the use of the allotment-holders was built as early as 1857. Without doubt the greatest extension of the allotment movement occurred during the years 1916 onwards, when the country was threatened with a serious food shortage. At the present time it is estimated that about one million allotments are in use. The typical allotment of one-sixteenth of an acre is rarely capable of providing all the potatoes and vegetables needed by an ordinary small household, but when a million of such allotments are considered, it is clear that they do bring about a marked saving in the national food bill. Unfortunately, the typical allotment is not always cropped to the best advantage, but it is hoped that this will be improved through the publication of a detailed scheme for allotments by the Ministry of Agriculture. In dealing with fertilisers the lecturer pointed out that many allotments are deficient in humus, and must be supplied with stable manure in addition to artificial fertilisers. Town-dwellers are faced with further difficulties over the tenure of their allotments, but it is hoped that all building schemes in the future will provide for a reasonable amount of allotment land.

"Social and Hygienic Conditions Respecting Gardens and Allotments" provided the subject for the third of Sir Daniel Hall's lectures. Under this heading was discussed the extreme importance of "vitamines," of which three at least have been found to be present in food. These vitamins occur mostly in living plants, although they are found also in certain animal foods. They are essential for the healthy development of human beings. In this connection appears one of the great values of allotments, for by their means a large number of people are provided with fresh vegetables containing the all-important vitamins, without which various diseases are liable to occur. The lecturer next dealt with the social value of allotments. Passive amusements, such as picture palaces, etc., fail to satisfy completely one's need for amusement, but there is enormous satisfaction in growing things; moreover, some of our best varieties of flowers and vegetables are the result of the efforts of working-men, who found much to interest them in the allotments which provided a welcome diversion from work that was often monotonous and carried out under unpromising conditions. The growth of the allotment movement will surely put men on a sounder economic basis, in addition to providing an active interest in life and to ensuring the better health of their families.

### The Research Associations.

NOTHING could be more satisfactory than the account that Dr. A. W. Crossley gave on Friday last to the Conference of Research Associations of the constitution and methods of the British Cotton Industry Research Association, of which he is director. It embraces every activity that contributes to the production and utilisation of cotton, and represents more than 95 per cent. of the firms engaged in the industry. Among its members are some of the Labour leaders, and these take the keenest interest in its work. It aims to obtain, in the first place, more exact knowledge of the chemical and physical properties of the fibre and the scientific facts which lie at the base of the processes employed; for it is considered that it is only in this way that the true solution of the problems which present themselves can be assured. It is to be hoped that the same broad and scientific spirit may animate all the associations that have been formed under the Department of Scientific and Industrial Research.

It appeared to be generally agreed that one of the most important conditions of the success of the movement was its close association with the universities and colleges where scientific research has hitherto been mainly carried out. It is to them that research associations and the research departments of private firms must look for their supply of science workers, and it is obviously important that those who are engaged in preparing men and women for the task of industrial research should be acquainted with the lines on which it is carried on. It is for this reason to be desired that the scientific staffs of these institutions should take their share in the technical research required by our industries, and it is a matter of congratulation that the Imperial College of Science and Technology has already led the way in this direction. Lord Crewe, who presided, referred in this connection to the "industrial fellowships" established at Pittsburgh and elsewhere in the United States to facilitate the investigation of technical problems. The work is carried out in close co-operation with the universities, and at the joint expense of the manufacturers concerned and of the endowment.

The question of the publication of the results of industrial research presents serious difficulties. As Dr. Crossley remarked, those employed upon it must keep in close touch with those engaged in pure research, on whose conclusions their work is based, but they cannot be always taking without giving something in return. He urged that a large proportion of the work carried out should ultimately be published even if for commercial reasons it had to be held back for several years; and Dr. Lawrence Balls reminded the conference that the stimulus of the prospect of future publication was required to secure the accurate record of the data obtained in the course of a research.

Not less important are the closely allied questions of the remuneration and superannuation of the scientific workers employed by the associations. This was discussed by Mr. J. W. Williamson in an interesting paper. He came to the conclusion that under present conditions 400l. per annum is the minimum that should be offered to a science graduate who has already had two or three years' training in research. He pointed out that a post under a research association did not afford the same security of tenure as one at a university. The desirability of extending to the staffs of research associations the federated superannuation system for universities was acknowledged on all sides.

J. W. E.

### Solid Lubricants.

ALTHOUGH the report of the Lubrication Committee has not yet been issued, a "Memorandum on Solid Lubricants," prepared for the Committee by one of its members, Mr. T. C. Thomsen, has recently been published (Bulletin No. 4 of the Department of Scientific and Industrial Research Advisory Council). This pamphlet of twenty-eight pages contains a digest of the existing knowledge in this branch of the subject, and will be found most useful to all engineers and users of machinery. The solid lubricants referred to are natural and artificial graphite (which are by far the most important), talc, mica, and such substances as flowers of sulphur, white lead, etc., which are occasionally used for curing hot bearings. The greater part of the bulletin is concerned with graphite, and although there is not much matter which is new, there is a great deal of information which will be of interest to many users of lubricants. The action of solid lubricants and the conditions under which they can be usefully employed are clearly explained.

The natural graphite used for lubrication is usually of the flake variety, and varies in the size of its particles from 1/10 in. to less than 1/200 in. The lubricating graphite produced artificially is amorphous. It is ground even finer than the natural graphite, and by chemical treatment is further reduced to particles of colloidal dimensions and sold under the trade-names of "Aquadag" and "Hydrosol" when in admixture with water, and "Oildag," "Oleosol," and "Kollag" when in admixture with oil. Analyses of the different varieties of lubricating graphites are given in the pamphlet, and it is seen that some are almost chemically pure carbon, whilst others contain mineral matter in variable proportion. Solid lubricants are applied dry in cases where for special reasons it is inadvisable or impossible to use liquid or semi-solid lubricants, but they are usually employed in admixture with oil or as an ingredient of greases. When mixed with oil ordinary graphite settles out, owing to its high specific gravity. Colloidal graphite does not settle so long as the vehicle remains neutral, and is carried with oil through the finest orifices, even through worsted trimmings, but it has the disadvantage of being easily caused to coagulate in presence of acid or alkali.

"Oildag" and "Aquadag" have been on the market for a number of years, and the experiences of users of these and other forms of graphite which Mr. Thomsen has collected for general information will be found of considerable value. Perhaps the most interesting experience is that of Mr. E. W. Johnston, who has successfully employed "Aquadag" as a cylinder lubricant and eliminated all the trouble caused by the presence of oil in condensed steam. Experiments made at the National Physical Laboratory showed that the addition of "Oildag" to mineral lubricating oil was advantageous where solid friction occurred, as in worm gear, but quite as good results were obtained with natural flake graphite, so that the lubricating value of graphite seems to depend upon its chemical purity, and the special advantage of the colloidal graphite is due to its property of remaining naturally suspended in the liquid medium without requiring to be stirred constantly by artificial means. The remarks on the use of graphite in internal-combustion engines, in the lubrication of ropes and chains, and in metal-cutting and wire-drawing will be found of great interest and practical use.

All who are interested in lubricants should obtain a copy of this pamphlet, which can be purchased through any bookseller for sixpence.

L. A.



### Greek Science and Philosophy.

ON Wednesday, May 12, Dr. C. Singer delivered his inaugural address as lecturer in the history of medicine at University College, London. Sir Robert Hadfield presided over a large and distinguished audience. After alluding to the neglect of the history of science in this country, Dr. Singer referred to the organised effort now being made by Dr. Wolf and others to remedy it at University College. The institution in which Augustus De Morgan spent the whole of his active life was a peculiarly appropriate place for such an experiment. The history of science was a necessary element in any curriculum that sought to give a view of the mental history of the human race. Turning to the various stages through which science has passed, Dr. Singer made some interesting comparisons between the science of the ancient East, the science of Greece, and modern science. Among the characteristics which distinguished Greek science from Oriental science and allied it to ours were the individuality and eponymity of its discoveries, as distinguished from the anonymous thought of preceding civilisations, which always appeared as a social rather than as an individual product. Another and more important feature of Greek thought was the conviction of the reign of law, the idea that order rules in Nature. This belief, almost an article of faith with the Greeks, has been justified more and more with the advance of natural knowledge. On the other hand, Greek science differed from ours in various ways. The most obvious difference was the intimate relation between Greek science and Greek philosophy. This was due to the fact that Greek science was originally a department of Greek philosophy. The divorce between our science and philosophy had many advantages, but also some drawbacks. Another important difference between Greek and modern science is to be found in the method of record. The Greeks were interested in results rather than in methods, and almost always neglected to give an account of their methods. As a consequence, their results cannot be relied upon, and, except by hard research, we can get no glimpse of their methods of working. The mathematical group of sciences, however, formed an exception in this respect. In these the Greeks recorded their methods as well as their results.

### Life-history of the Periwinkle.

UNTIL 1908 the life-history of the common periwinkle, *Littorina littorea*, L., was unknown. In that year Dr. W. M. Tattersall published a brief announcement of some investigations made that included the discovery of its ova. He reserved a more detailed account until further observations and researches could be carried out, but this proved impracticable, and Dr. Tattersall has now issued the notes of his work so far as it went (Department of Agriculture and Technical Instruction for Ireland (Fisheries Branch), Scientific Investigations, 1020, No. 1, pp. 11, 1 plate), being largely instigated thereto by the publication in 1911 of a paper on the same subject by MM. Caullery and Pelseneer. From Dr. Tattersall's account it appears that the breeding season lasts from the middle of January to June, and the pink eggs are enclosed singly or in pairs (sometimes three and exceptionally four) in small, curiously shaped, transparent capsules resembling a soldier's "tin" hat, the eggs occupying the crown. These capsules are unattached, and vary from 0.6 to 0.9 mm. in diameter, the eggs being from 0.15 to 0.16 mm.

Segmentation is completed during the first day, and at the third day the circumoral ring of cilia is complete and the embryo begins to rotate. At the sixth day the embryo breaks out from the capsule and swims freely about in the water. The chief food of *Littorina littorea* appears to be the hyphal hairs of *Fucus serratus* and allied seaweeds, and the animal swallows indiscriminately the diatoms and other microscopic organisms clinging to the seaweed. The climbing habits of these molluscs suggested to the author the possibility of establishing "farms" for their more easy collection for the market. Experiments were made by erecting stakes in their intertidal haunts, but, though the snails of all ages would ascend, they seemed incapable of retaining their hold save in calm weather, hence the farming had to be abandoned. In conclusion, the author advocates the grading of the winkles into sizes before dispatching them to market, using two sieves of  $\frac{3}{8}$  in. and  $\frac{1}{4}$  in. respectively, and rejecting all that pass through the smaller as unmarketable.

### The Royal Society Conversazione.

THE first of the two annual conversazioni of the Royal Society was held at Burlington House on Wednesday, May 12, when the president, Sir Joseph Thomson, received a large company of fellows of the society and other workers of distinction in the scientific world. As is usual upon such occasions, many exhibits of recent methods and results of investigation were displayed, and much interest was taken in them. Mr. A. A. Campbell Swinton gave a most successful demonstration and exposition of wireless telephony with apparatus supplied by the Marconi Wireless Telegraph Co., Ltd. Gramophone records and musical instruments played at the company's works at Chelmsford were loudly reproduced in the meeting-room of the society. The apparatus used consisted of an amplifying detector and note magnifier, to which was connected a loud-speaking telephone enabling speech to be heard distinctly over the whole ground floor. The aerial consisted simply of a frame 3 ft. square, wound with a few turns of wire, and placed on the lecture-table in the meeting-room. The subjoined descriptions of most of the exhibits, arranged so far as possible in related subjects from man to machine, are abridged from the official catalogue:—

*Mr. M. C. Burkitt:* (1) Tracings of prehistoric rock engravings from the shores of Lake Onega, North Russia, the only site in Russia west of the Urals where prehistoric engravings occur. (2) Palaeolithic stone implements from North Africa, showing that there is a series comparable in general form with the regular sequence in France and Britain.

*Mr. S. H. Warren:* Specimens from a factory of Neolithic stone axes at Graig-lwyd, Penmaenmawr. The axes were made from the scree which fell down the mountain-side from a line of crags formed of the fine-grained (chilled) margin of the Penmaenmawr intrusion. Axes are found in every stage of manufacture, discarded on account of breakage or unsatisfactory shape, the most frequent fault being excessive thickness of blade. Palaeolithic resemblances are abundant and striking.

*Mr. L. Treacher:* A large Palaeolithic implement from the Gravel at Furze Platt, near Maidenhead. The gravel in which this implement was found has also yielded a very large number of palaeoliths, mostly belonging to the Chellean type, although a few Moustertian flakes have been found. The surface level is

about 140 O.D., being 20 ft. lower than that of the Boyl Hill terrace in the neighbourhood.

*Mr. Herbert Bolton:* Enlarged photographs of fossil insects from the British Coal Measures. The first recorded fossil palaeozoic insect from any country was discovered in the Coal Measures of Coalbrookdale in the early part of last century. In 1908 only twelve additional types from Great Britain had been made known. Mr. Bolton's researches during the last ten years have revealed the fact that at least fifty distinct types had lain unrecognised in various museums and private collections. The photographs exhibited were made by Mr. J. W. Tutcher.

*Dr. W. K. Spencer:* Palaeozoic starfish and their habits. Recent work by the Danish Fisheries Board upon the habits of recent forms throws considerable light on the mode of life of the fossil starfish. Recent starfish can be divided into (1) starfish, carnivores, and (2) brittle starfish, detritus feeders living on vegetable remains in the mud on the sea-bottom or on very young marine animals. Both these series of forms are modified for their respective mode of life. The exhibit showed that both classes of forms were present in the palaeozoic rocks, and that some of the forms from the very old rocks were strikingly similar in mode of life to those of the present day. Forms which are transitional in structure between the two series were also shown.

*Dr. F. A. Bather:* Stalked Echinoderms with a horizontal habit of growth. In a normal stalked Echinoderm the stalk, body, and five arms are symmetrical about the long axis, which is vertical, and the waste products are carried away from the vent at the upper end. But all the Cystids found in the Upper Ordovician starfish bed of Girvan, Ayrshire, have a body flattened in the plane of the stalk, and this shows that the long axis was stretched horizontally. Extreme modification for this mode of life is reached in three different ways by three genera of diverse origin: Dendrocystis, which floated, with its stalk attached probably to seaweed; Pleurocystis, which was possibly attached, but rested its body on the sea-floor; and Cothurnocystis, probably free, with its body resting on the sand by short legs. Cothurnocystis had no arms, but from thirteen to forty-two mouth-slits.

*Mr. R. D. Oldham:* Model to illustrate an hypothesis of the origin of mountains. If the variation in density, and consequently in bulk, of the matter underlying mountain ranges is also the cause of the surface elevation, and if the outer crust is possessed of a considerable degree of strength and stiffness, resting on material of a more yielding character, systematic departures from complete equivalence of surface elevation and compensation would result. The model is intended to visualise this.

*Mr. A. V. Hill:* Thermopiles for investigating the thermal or the thermo-elastic properties of muscles. When a muscle is stimulated, heat is produced in four separate stages: (a) in the development, (b) in the maintenance and (c) in the disappearance of the mechanical response, and (d) in the processes of oxidative recovery. This heat-production is recorded by employing delicate insulated thermopiles and a sensitive galvanometer with photographic recording.

*Prof. E. Mellanby:* The effect of an accessory food factor (vitamine) on: (1) The production of rickets in puppies. Soft bones and other signs of rickets are produced in puppies (five to eight weeks old) when fed on diets unbalanced in that they contain too little of an accessory food factor (vitamine)—probably fat-soluble A. (2) The development of the teeth in puppies. Diets deficient in a vitamine, possibly fat-soluble A, produce teeth defectively cal-

cified and more or less irregularly placed in soft jaws.

*Mr. Julian Huxley and Mr. Lancelot T. Hogben:* The relation of the thyroid to metamorphosis. The exhibits illustrated (1) acceleration of frog's metamorphosis by thyroid-feeding; (2) metamorphic changes in the axolotl induced by iodine; and (3) metamorphosis of *Amblystoma* by thyroid-feeding with a control.

*Prof. R. Newstead:* Samples of mite-infested flour. Flour which is heavily invested with mites (chiefly *Aleurobius farinae*) is certainly ruined. It has a most unpleasant odour, and in the early stages becomes discoloured owing to the quantities of excrement with which it is charged. Prevention from attack may be secured by storing flour with a low moisture content, i.e. below 11 per cent. in the temperate zone and from 6-7 per cent. in the tropics.

*Prof. G. H. F. Nuttall and Dr. D. Keilin:* Hermaphroditism in *Pediculus humanus*. The microscopic specimens illustrated hermaphrodites of intersexual type and included a complete series of forms from those of male type to those of female type, the co-existing characters of both sexes being present to a varying degree. The intersexual forms which occur among *Pediculi* in Nature are derived from the crossing of the races of *P. humanus*, i.e. *capitis* and *corporis*. Some of these crosses yield up to 20 per cent. of hermaphrodites.

*Mr. J. E. Barnard:* Photomicrographs obtained by means of ultra-violet light. It is well known that resolving power in the microscope is dependent on the N.A. of the objective and the wave-length of the light used. Decrease of wave-length results in proportionate increase of resolution, and this method opens up a promising field of investigation. There is the further advantage that biological preparations, particularly bacteria and other micro-organisms, are sufficiently opaque to ultra-violet light of suitable wave-length to render staining unnecessary. The result is that they can be photographed in the living state.

*Dr. J. C. Mottram and Dr. E. A. Cockayne:* Demonstration of fluorescence in Lepidoptera by ultra-violet radiation. The beam of ultra-violet rays is produced by means of a quartz mercury vapour lamp in a box with a window of the glass invented by Prof. Wood. This is transparent to radiation of wave-lengths lying between 3900 and 3100 A.V., but opaque to light. Only a small proportion of the Lepidoptera examined have proved to be fluorescent, and all of these are whitish or yellow in colour.

*The Botany Department, Imperial College of Science and Technology:* Recording perometer. This instrument records the rate at which air, under slightly reduced pressure, is drawn through the stomata (pores) into a glass cup fixed on the under-surface of the leaf. It thus gives a measure of the size of these pores. Every time a bubble of the air so drawn in escapes from the lower tube it momentarily makes contact between the mercury and a platinum wire; the current passing then moves the recording pen on the surface of the revolving drum.

*The Cambridge and Paul Instrument Co., Ltd.:* A new microtome. This instrument is designed on similar lines to the well-known Cambridge "rocking" microtome, but the object is in a much more convenient position for observation and orientation, and the microtome cuts plane sections in either paraffin or celloidin, and the design is suitable for freezing objects by ethyl chloride spray.

*The Royal Geographical Society:* Method of mounting panoramic views of wide angle. A photographic panorama of wide angle, made up from a number of separate pictures, gives a false impression

of the country if shown flat. The pictures should be enlarged to an equivalent focal length greater than the distance of distinct vision, and mounted in a polygon circumscribing a circle of radius equal to the focal length.

*The Meteorological Office:* New instruments and diagrams: (1) Land aneroid and sea aneroid. (2) Barometer with micrometric adjustment. (3) Two similar synchronous charts and the weather of the following fifteen days. (4) Normal weather on the Cairo to Cape route. (5) Charts of the average distribution of rainfall, cloudiness, and temperature over the northern and southern hemispheres in January and July. (6) Map of the annual rainfall in the English Lake District. (7) Records of the magnetic disturbance of March 23-24, 1920, and photographs of aurora for height-measurements. (8) Frequency of thunderstorms on the route between England and Australia and at selected stations in Africa and South America. (9) The flow of air over Kew Observatory, Richmond, during the last three years.

*Air Ministry Laboratory:* Apparatus for air navigation. (1) Four alternative methods for the quick solution of spherical triangles necessary for the obtaining of position lines from astronomical observations taken from aircraft: (a) The d'Ocagne nomogram. (b) A slide-rule based thereon. (c) The Veater diagram. (d) The Bygrave slide-rule. (2) Wimperis wind-gauge bearing plate, to enable the velocity and direction of the wind to be measured whilst in flight, (i) by flying on two courses and noting the drift angles, and (ii) by flying on one course and using a chronometer. (3) Capt. Weir's (Littrow projection) diagram applied to the purpose of obtaining position lines from W/T bearings.

*The Admiralty Compass Department:* (1) Two standard types of aircraft compasses. (2) Examples of aperiodic compasses for use in ships and aircraft. The aperiodic system adopted in these compasses is a result of the investigations of Mr. G. T. Bennett and the late Lt.-Comdr. C. Campbell.

*Mr. E. A. Rees:* Apparatus for showing the existence of a true north and south directive force in the electricity of the atmosphere. This apparatus consists of a large glass bottle with an india-rubber stopper, from which is suspended by a fibre of unspun silk a gold-leaf paper indicator. The inner side of the stopper is covered with paraffin wax, and the bottle is coated inside and out with shellac varnish. The whole is mounted on a tripod stand. On a calm, clear day, when the apparatus is set up in a high open space and screened from the direct rays of the sun, it is found that after the paper is electrified by touching it with vulcanite rubbed on dry cloth, and left for some time, it will oscillate about evenly on either side of the true north and south line, or come to rest approximately in that direction.

*Mr. C. V. Boys:* (1) Noon reflector. The noon reflector is a very simple form of transit instrument intended to be set on a window-sill facing south and producing a pinhole-reflected image of the sun on the ceiling or opposite wall, from which the time may be obtained with an accuracy of about one second. (2) Azimuth declination time-chart. The azimuth declination time-chart is a graphic representation of the hour angle of the sun for all declinations at a particular latitude and azimuth from which the hour angle may be read with an accuracy of one-tenth of a second of time. This is for use with the noon reflector when set at some azimuth other than south.

*The National Physical Laboratory:* Oriented lustre of etched crystalline surfaces. The etched crystalline surface of metal is covered with a number of minute plane facets the orientation of which is uniform throughout each individual crystal, but varies from

one crystal to the next. A beam of oblique light falling on such a surface is selectively reflected by these facets in such a way that the area of certain crystals appears uniformly and brightly illuminated, while other crystals remain dark. By illuminating such a surface by means of three separate beams of coloured light falling upon the crystals at various angles of incidence a striking effect is produced. Each crystal reflects into the eye of the observer a portion of one of the beams falling upon it at a suitable angle, and the various crystals consequently appear of different colours (Dr. W. Rosenhain and Mr. J. H. Haughton).

*Messrs. Adam Hilger, Ltd.:* Vacuum grating spectrograph for the extreme ultra-violet. A concave grating spectrograph, specially designed for the investigation of the Schumann and Lyman regions of the spectrum. No refractive substance (e.g. quartz or fluorite) is introduced, but the whole spectrum is obtained with one setting of the grating by the use of two slits. These are disposed in the end plate of the instrument, just above the plate-holder, which is cylindrical in form and provided with a plate for sealing purposes.

*The Osmosis Co., Ltd.:* Clays treated by electro-osmosis: Photomicrographs and specimens of articles made with osmosed clay. The phenomena of electrical osmosis, whereby matter in a very finely divided state is capable of being influenced by an electrical potential, have an important practical use in the purification of clays. Low-grade and discoloured china clays become usable as paper clays and pottery clays, and all china clays are improved in colour as a result of treatment.

*Messrs. J. Crosfield and Sons, Ltd.:* Synthetic products for perfumery. Synthetic perfumes of British manufacture were shown, most of which were formerly produced entirely in foreign countries. The manufacture was undertaken owing to the difficulty, in some cases impossibility, of obtaining such products during the war.

*Mr. A. Mallock:* Apparatus used in the determination of the variation of rigidity with temperature. The specimen to be tested forms part of a torsion balance, in which the restitutive couple is supplied by the torsion of a long thin wire, together with that of the specimen, the latter being in the form of a short wire or narrow strip about 2 in. long. The specimen and lower part of the balance can be immersed in a tube of fluid kept at any desired temperature. The periods of oscillation are automatically recorded for various temperatures, and the ratio of these periods furnishes the necessary data for determining the ratio of the rigidities. In making an experiment the oscillations are maintained continuously, the specimen being immersed successively in water at 100°, at room-temperature, in carbonic acid, in alcohol, and in liquid air.

*Mr. C. R. Gibson for Mr. Joseph Goold:* Experiments in rotational dynamics. The exhibit illustrated is a new development of Mr. Goold's earlier experiments in vibrating bars, the most remarkable of these being the vortex phenomenon demonstrated about a quarter of a century ago. The new experiments showed a rotational effect which is independent of the vortex phenomenon. A light clamp is fitted across the steel bar carrying an upright needle or rod, upon the free end of which is supported a light metal vane or "spinner." On setting the plate in vibration the spinner rotates with considerable energy. This rotation results from the interplay of two systems of vibration acting at right angles to each other. The following explanation is suggested by Mr. Gibson, who gave the demonstration: In one of the systems the bar vibrates between nodal lines which cross the width of the bar; this is termed a normal system.

In the other system of vibration the bar has a nodal line running along the longitudinal centre of the bar, while cross-nodes are also present; this class of vibration is termed a *dual* system. In the latter we may picture the sections of the bar on opposite sides of the central line to be out of phase with each other, so that one section is going upwards at the moment the other section is going downwards. This will give a slight rocking motion to the clamp, causing the free end of the needle to move to and fro in direction across the bar. Similarly, the bar is vibrating between the cross-nodes, so we may picture the sections divided by these to be upwards on one side of the cross-node and downwards on the other, thus giving a rocking motion to the needle in a direction lengthwise with the bar. These two motions (dual) combine to give the free end of the needle an elliptical motion; hence the rotation of the spinner.

*The Hon. Sir Charles Parsons:* Water-hammer cone demonstrating the destructive effect of collapsing vortex cavities. The apparatus consists of a hollow cone. At the small end is fitted a die-cap through which passes a hole of the same diameter as the small end of the cone. Between this cap and the cone thin metal plates are inserted. The cone is placed in water in the tank, allowed to fill with water, and then thrust quickly downwards, its mouth striking on to a rubber block at the bottom. The sudden arrest by the rubber block gives a high rate of relative acceleration of the water in the cone, producing momentarily a cavity at the apex, which, however, immediately closes again with a perceptible metallic hammering sound, and with sufficient pressure, due to the concentrated energy of the closing cavity at the apex, to puncture metal plates above 0.03 in. in thickness, indicating a pressure of 140 tons per square inch.

*Mr. Edwin Edser:* The concentration of minerals and coal by froth flotation. Many valuable minerals, particularly metallic sulphides, can be concentrated from low-grade ores by crushing these to a fine powder, mixing them with water, adding a small quantity of a suitable reagent, and agitating the mixture so that air is entrained in the form of fine bubbles. On allowing the mixture to come to rest, the bubbles carrying the mineral particles rise to the surface, and find a mineralised froth which can be removed. The barren rock (gangue) is not floated. Demonstrations were given of (1) the recovery of galena (lead sulphide) and blende (zinc sulphide) as separate products from Broken Hill ore; (2) the recovery of coal from waste dumps.

*Sir Robert Robertson:* Instrument for determining the pressure developed by detonators by Hopkinson's principle. This instrument, which was designed by Mr. H. Quinney at the Research Department, Woolwich, illustrated the quantitative measurement of the pressure of the blow delivered by a detonator according to the principle enunciated by Hopkinson. This principle depends on the separation of momentum into pressure and time. When the blow is applied to one end of a steel bar, a short length of the bar, attached by means of a faced joint to the other end, is thrown off as a result of the application of the pressure of the blow. The momentum of this short length (the "timepiece") is measured by catching it up in a ballistic pendulum. As the rate of transmission of the impulse in steel is known, the time taken for the pressure-wave to pass twice the length of the "timepiece" is also known, and so the pressure can be deduced.

*Prof. F. W. Burstall:* Optic indicator for internal-combustion engines. An instrument for obtaining the power and the pressure in internal-combustion engines. The objects aimed at are to obtain accurate readings of the pressures up to 600 lb. per square inch and speeds up to 2500 revolutions per minute.

## University and Educational Intelligence.

CAMBRIDGE.—Mr. E. A. Milne, fellow of Trinity College, has been appointed assistant-director of the Solar Physics Observatory.

The new professorship of physical chemistry is declared vacant.

It is proposed to make it possible for students to take the first M.B. examination before coming into residence on account of the greater facilities now provided in schools for the teaching of chemistry, physics, and biology.

The discussion on the syndicate's report on the relation of women to the University is fixed for October 14.

The Local Lectures Summer Meeting will be held from July 29 to August 18. The main subject of study will be the history, literature, and art of Spain, but courses in physical science (historical and biographical) and in elementary astronomy are being arranged in co-operation with the Association of Science Teachers. Further information can be obtained from the Rev. Dr. Cranage, Syndicate Buildings, Cambridge.

LIVERPOOL.—Dr. Charles Walker has been appointed associate-professor in cytology and lecturer in histology.

Mr. J. Wemyss Anderson, dean of the faculty of engineering, and associate-professor of engineering in the University, has been appointed to the recently established John William Hughes chair of engineering-refrigeration.

Messrs. Alfred Holt and Co., Ltd., of Liverpool, have contributed 15,000l. to the University Appeal Fund. The Association of West African Merchants and the African Section of the Chamber of Commerce, Liverpool, have decided to raise 12,000l. by voluntary contributions from their members to provide a chair of Colonial commerce, administration, and history at the University and to increase the endowments of the School of Tropical Medicine.

LONDON.—The following courses of advanced lectures will begin shortly:—Three lectures on "The Early Civilisation of Malta," by Prof. Th. Zammit (of the University of Malta), at University College, at 5.30 p.m., on May 20, 27, and 28; four public lectures on "High-frequency Alternators for Radio-Telegraphy," at the Institution of Civil Engineers, S.W.1, by M. Marius Latour (of Paris), at 5.30 p.m., on May 26, 27, 28, and 31; and four lectures (in French) on "Divers Modes de Dynamisme des Eruptions Volcaniques et les Phénomènes de Latéritisation," at the Imperial College (Royal School of Mines), by Prof. A. Lacroix, at 5 p.m., on June 14, 15, 16, and 17. Admission to the courses is free, without ticket.

ANNOUNCEMENT is made of the impending retirement of Mr. T. P. Gill, who has been Secretary of the Department of Agriculture and Technical Instruction for Ireland since it was established.

THE Regional Association, in co-operation with the Civic Education League, proposes to hold a meeting at Glastonbury from August 21 to September 11. The purpose of the meeting will be (1) to make a regional survey, rural and civic, of Glastonbury and its surroundings, and (2) to proceed, from the material so obtained, to a critical study of social life and institutions. Particulars may be obtained from Mrs. Fraser-Davis, hon. secretary of the Regional Association, 1A Lancaster Place, Belsize Place, N.W.3, or 65 Belgrave Road, S.W.1.

THE Sorby research fellowship has been awarded to Dr. F. C. Thompson, of the department of applied sciences of the University of Sheffield, for research into the constitution of the alloy steels. The fellowship, which is tenable for five years, is awarded by a committee appointed by the council of the Royal Society and the University of Sheffield from a fund bequeathed by the late Dr. H. C. Sorby. Dr. Thompson holds the degrees of Doctor of Metallurgy (Sheffield) and Bachelor of Science (London). He was a Carnegie research scholar of the Iron and Steel Institute, is a member of many bodies concerned with physical and metallurgical matters, and has published a number of papers on metallography and allied subjects.

THE Dr. Jessie Macgregor prize for medical science, of the Royal College of Physicians, Edinburgh, is to be awarded in July to the applicant who presents the best record of original work in the science of medicine, published or unpublished, but must not have been published earlier than three years prior to the date of award of the prize. The prize, which is of the value of 75*l.*, is open to women medical graduates of the University of Edinburgh, or to those who have taken the triple qualification and before being qualified studied medicine for at least a year in Edinburgh. Applications for the prize, with a record of the work of the competitor, must be sent to reach the Convener of the Trustees, Royal College of Physicians, Edinburgh, by, at latest, June 1.

THE Bureau of Education in India has issued a pamphlet by Mr. R. K. Sorabji entitled "Facilities for Indian Students in America and Japan." Mr. Sorabji warns students that it is unwise for anyone to visit the United States on an allowance of 50 or 60 rupees per mensem, even though the student may make some money in the vacations; he requires from 150*l.* to 200*l.* a year, of which he may earn 50*l.* The facilities for technical education and the cheapness of it may attract the student to Japan, but the candidates for admission to the colleges exceed the accommodation, and when a system of competitive examination is introduced, the youth trained in a Japanese school possesses greater advantages than the Indian. As is the case in the United States, the student will require an allowance of from 100*l.* to 150*l.* per annum, and as the teaching is given in Japanese he must acquire that language before he can derive any advantages from Japanese institutions.

## Societies and Academies.

LONDON.

**Royal Society**, May 6.—Sir J. J. Thomson, president, in the chair.—R. H. Fowler, E. C. Gallop, C. N. H. Lock, and H. W. Richmond: The aerodynamics of a spinning shell. This paper deals with the motion through a gas or a body with an axis of symmetry and a spin about that axis. The range of velocities includes the velocity of sound in the gas. It has special reference to the motion of an ordinary shell through air under gravity. The problem is approached from the aerodynamical viewpoint. The force system imposed by the gas is analysed into its most important constituents by help of the theory of dimensions and by detailed wind-channel experiments. The general equations of motion are obtained in a vector notation, and reduced to tractable approximate forms in certain important special cases; in particular, when the axis of symmetry and the direction of motion of the centre of gravity nearly coincide. An approximate formal solution of these last equations is obtained, and the

errors in the equations themselves and their solutions are shown to be negligible. The solutions obtained are submitted to the test of experiment, and the magnitude of the more important members of the force system determined numerically as functions of the velocity of the shell up to twice the velocity of sound. At the same time the main assumptions made in the analysis are verified. The experimental method used is to fire the shell through a series of cards. The shape of the holes left in the cards determines accurately the angular motion of the axis of the shell. From this the values of the chief components of the force system are deduced. One of the principal results is to determine accurately the spin required to render the shell stable at any velocity. The behaviour of the force components as functions of the velocity appears to be of scientific interest, and of obvious importance in technical ballistics.—Prof. W. E. Dally: Researches on the elastic properties and the plastic extension of metals. This paper relates to a new type of load-extension diagram recorded automatically by an adaptation of an instrument already described to the society. The extension of the test piece is multiplied 150 times by the instrument. With this magnification, about  $\frac{1}{100}$  extension is shown on the negative, and the elastic line appears at a slope of about 60°. The shape of the elastic line can therefore be studied and the process of extension can be watched, so that stretching can be stopped at an assigned value and the load removed and then re-applied. The removal and re-application of the load produce a loop on the diagram, and several such loops can be described on each negative. Looped diagrams taken from metals commonly used were shown. Comparisons of these looped diagrams show that each metal is characterised by its elastic line and loops. A succession of plates was taken from a test piece of high carbon steel stretched almost to breaking. These plates set end to end give a procession of loops, and show that the loop area tends to a maximum. The questions of time-interval between the taking of loops and heat treatment between the taking of loops are examined in relation to loop area. It is shown that in the high carbon steel and alloy steel lapse of time has little or no effect in restoring elasticity, nor is the elasticity restored by boiling in water. New data relating to the strength of materials are given by these diagrams, viz.: (1) The area of the loop. (2) The rate of increase of the area of the loop. (3) The maximum area.—C. T. R. Wilson: Investigations on lightning discharges and on the electric field of thunderstorms. The investigations were carried out at the Solar Physics Observatory, Cambridge, by methods already described (Proceedings, 1916). Apparatus has been added to secure a photographic record of the readings of the capillary electrometer used in the measurements. Changes in the electric field which occupy less than a tenth of a second are recorded. The sudden changes produced in the potential gradient by the passage of lightning discharges recorded in 1017 were positive in 432 cases and negative in 279. The mean value of the electric moment  $2QH$  ( $Q$  being the quantity discharged and  $H$  the vertical height through which this charge is displaced) of a lightning discharge is about  $3 \times 10^{16}$  e.s.u.  $\times$  cm. or 100 coulomb-kilometres. The mean quantity discharged is of the order of 20 coulombs. The magnitude of the potentials attained in thunderclouds is of the order of  $10^9$  volts. The rate of vertical separation of charges in a thundercloud may amount to some coulombs per second, i.e. the vertical current through the cloud is of the order of some amperes. A thundercloud or showercloud may be regarded as an electric generator, capable of maintaining between

its poles an electromotive force of the order of  $10^9$  volts. It tends to maintain an electric current from the earth to the conducting layers of the upper atmosphere or in the reverse direction, according as its polarity is + or -. The difference which must exist in the conductivity of the air above showerclouds of + and of - polarity respectively, owing to the large difference between the mobilities of the negative and positive ions dragged out of the conducting layer by the field of the cloud, furnishes a possible explanation of the normal positive potential gradient at a distance from showerclouds. It is also shown that it will account for the prevailing negative sign of the potential gradients associated with showerclouds and for the preponderance of positively charged rain and positive lightning discharges, *i.e.* discharges which produce a positive change of potential gradient.—L. F. Richardson: The supply of energy to atmospheric eddies. Osborne Reynolds investigated the energy of eddies as a balance between income and expenditure. The income was the activity of the eddy stresses upon the corresponding rates of mean strain; the expenditure was by way of molecular viscosity. His theory refers to an incompressible liquid, but it is shown in the present paper that the same applies to an elastic fluid. In a gravitating atmosphere there is an additional channel for gain or loss, because the eddies act as thermo-dynamic engines, either producing or decreasing inequalities of temperature. They are, however, imperfect engines. It is shown that the activity contributed by the eddies by this process is

$$\frac{g}{\gamma b} c \frac{\delta \sigma}{\delta h} \text{ per volume,}$$

where  $g$  is the acceleration of gravity,  $\gamma b$  the thermal capacity per mass,  $c$  the eddy-conductivity,  $\sigma$  the entropy per mass, and  $h$  the height. In the actual atmosphere this activity is ordinarily an expenditure by the eddies. By balancing it against their income a criterion of turbulence is obtained. Some observations of the quiescence of wind on a clear evening tend to confirm the theory.

**Geological Society,** May 5.—Mr. G. W. Lamplugh, vice-president, in the chair.—S. H. Warren: A natural "colith" factory beneath the Thanet Sand. The paper describes a section in the Bullhead Bed at Grays, where the conditions have been favourable for the chipping of the flints by subsoil pressure. There is evidence of extensive solution of the chalk beneath the Tertiary deposits, and the differential movements thus brought about have occasioned much slickensiding, and remarkable effects in the chipping of the flints. In the author's opinion the section affords the most complete and conclusive evidence hitherto obtained in support of the theory of the origin of the supposed colithic implements by purely natural agencies. There are not only the simpler Kentish types, such as notches, bowscrapers, and the like, but also the larger and more advanced forms of rostro-carinates, which are characteristic of the sub-Crag detritus-bed. Careful digging enables the pressure-points of one stone against another and the resultant chipping effects to be studied in detail; and in many instances the flakes removed can be recovered and replaced. A few examples are more than merely colithic in character. If such exceptional examples were removed from their associates, and also from the evidences of the geological forces to which they have been exposed, no investigator could be blamed for accepting them without question as of Moustertian workmanship. Individual specimens may often deceive: in order to distinguish a geological deposit of chipped

flints from the débris of a prehistoric chipping-floor, it is necessary to base one's judgment upon fairly representative groups, and also to take into consideration the circumstances in which they have been discovered.

CAMBRIDGE.

**Philosophical Society,** March 8.—Mr. C. T. R. Wilson, president, in the chair.—H. H. Brindley: Further notes on the food-plants of the common earwig (*Forficula auricularia*). The observations on the food-plants of the common earwig made on a small scale in 1917 (Proceedings, xix., part 4, 1918, p. 171) were continued in the summers of 1918 and 1919 on earwigs kept in captivity in connection with a statistical inquiry on variation. Altogether about ninety species of common plants, chiefly garden varieties, were used. Among the most favourite foods were the leaves of Jerusalem artichoke, beetroot, pink begonia, garden cabbage, centaurea, delphinium, leek, *Malva sylvestris*, vegetable marrow, mignonette, white pyrethrum, scarlet runner, seakale, and tomato; and the petals of blue Anchusa, China aster, pink begonia, blackberry, different varieties of campanula, white clematis, dandelion, Gesneria, white marigold, mint, corn parsley, white phlox, yellow *Eriogonum*, rose, tomato, red valerian, blue verberna, and varieties of vetches. Among fruits green fig, honeysuckle, and plum were well attacked, while apple was neglected until the skin was removed, and then eaten comparatively little. Potato and artichoke tubers, save dormant buds on the latter, escaped attack in their skins, but when sliced they were thoroughly devoured. The hairy undersides of the leaves of raspberry and blue verberna and the curled edges of Scotch kale leaves are very attractive to earwigs for hiding in in the day-time, and onion inflorescences, poppy capsules, buds of hollyhock, petals of garden chrysanthemums and snapdragon are also popular refuges. The last two and Scotch kale leaves were also nibbled moderately, but the conclusion formed in 1917 that the actual damage done to chrysanthemums by earwigs is usually exaggerated was confirmed by the later observations.—Miss Maud D. Haviland: Preliminary note on antennal variation in an Aphid (*Myzus ribis*, Linn.). The red currant Aphid (*Myzus ribis*, Linn.) shows variation of the antennæ in the winged females, according to whether they are fed upon healthy leaves or upon leaves blistered by the sucking of previous generations. In forms from the blisters the large sense-organs, situated upon antennal joints v. and vi., are placed nearer the articulation of these joints than in forms from healthy leaves. Experiments on transference of blister-fed descendants of a single ancestor to healthy leaves showed but slight change in the first two or three generations. Subsequent generations, however, showed marked increase above the ancestral mean, though identical generations, fed only upon blistered leaves, had a mean similar to that of their ancestors.—Dr. Fenton and A. J. Berry: Studies on cellulose acetate. The authors gave a short account of certain observations of general chemical interest obtained in the course of an investigation on aeroplane dopes.—G. T. Bennett: The rotation of a non-spinning gyrostat, and its effect in the aeroplane compass. "A symmetrical wheel free to rotate about its axle is moved from rest in any position by means of the axle, and is finally restored to a position in which the axle again points in the same direction as formerly. Show that the wheel, again at rest, will have rotated through a plane angle equal to the solid angle of the cone described by the varying directions of the axle" (College Examination Problem Paper, 1898). The kinematics of the angular motion of the wheel is

represented by the rolling of the plane of the wheel on a fixed cone of arbitrary form. The surface-angle of the cone differs from four right angles by the final angular displacement of the wheel. The same angle of rotation is also measured by the solid angle of the reciprocal cone described by the axis of the wheel. This movement is not yet among those that are familiarly recognised, though it has important practical applications. Bodies suspended from a point on an axis of symmetry behave in the same way and for the same reason when swung about by movements of the point of support. Aeroplane compass-cards in particular (found to keep practically parallel to the banked floor of the aeroplane under the action of gravity and lateral acceleration during a turn) would, from inertia alone, and apart from all other sources of control or disturbance, turn with the machine through an angle geometrically calculable from the movement of the aeroplane.—C. G. Darwin: Lagrangian methods for high-speed motion. The general form of the kinetic potential is found for any number of electrically charged particles moving in any field of electric and magnetic force, allowing for the variability of mass with velocity and for the "retardation" of the forces of interaction of the particles. The result is applied to the "problem of two bodies." The relative orbit is a distorted ellipse with moving apse, and there is no simply definable centre of mass for the system. The finiteness of mass of the hydrogen nucleus is found to have absolutely no effect on the separation of the doublets in the hydrogen spectrum.—H. P. Waran: The effect of a magnetic field on the intensity of spectral lines. The paper discusses the changes observed in the general spectrum and in the intensity of the lines when the source is placed in a magnetic field. In the case of mercury the field brings out a few lines previously faint or absent, and the abnormal behaviour of the line 6152, which is very prominently brought out, is discussed. In the spectrum of the monatomic gases helium and neon mixed with the diatomic gases oxygen and hydrogen, only the monatomic lines are enhanced very much in brightness, and on this view the fact of the lines getting enhanced in the magnetic field is attributed to atomic radiation. The differences in the degrees of enhancement are said to depend on the series to which the lines belong, and the enhanced lines in the sun-spot spectrum are attributed to this effect of the magnetic field known to exist there.—C. V. H. Rao and Prof. Baker: Generation of sets of four tetrahedra mutually inscribed and circumscribed. This paper shows how the figure is obtainable by a generalised process of inversion from a single tetrahedron, and applies the same method to a certain configuration in four dimensions.—S. Pollard: The term-by-term integration of an infinite series over an infinite range, and the inversion of the order of integration in repeated infinite integrals.—S. R. U. Savor: Rotating liquid cylinders. This paper applies the method followed by Liapounoff, for the case of ellipsoids, to the consideration of the stability of the so-called pear-shaped cylinder.

## DUBLIN.

Royal Dublin Society, April 27.—Dr. F. E. Hackett in the chair.—Prof. W. E. Adeney and H. G. Becker: The rate of solution of atmospheric nitrogen and oxygen by water (Part iii.). This paper deals with experiments made with bodies of quiescent water, the results of which show that under ordinary conditions mixing of the water takes place to such an extent that a modification of the formula previously deduced can be used to interpret the process. The effect of the humidity of the air above the surface of the water is

also dealt with and its influence on the rate of solution indicated.—Dr. J. Reilly and W. J. Hickinbottom: (1) The influence of electrolytic dissociation on the distillation in steam of the volatile fatty acids. Changes in the distillation constants of the fatty acids are fully accounted for by introducing a correction for electrolytic dissociation. Observations are given on the influence of salts. (2) Some applications of the method of distillation in steam. A survey of the method, discussing its theoretical and industrial applications, especially in the analysis of butter and other edible fats and oils.

## PARIS.

Academy of Sciences, April 26.—M. Henri Deslandres in the chair.—A. Haller and R. Cornubert: The constitution of the methylcyclohexanone prepared by the ethylation of  $\alpha$ -methylcyclohexanone. This compound is shown to possess an unsymmetrical structure, both the alkyl groups being attached to the same carbon atom in the ring.—H. Douvillé: The origin of the Orbitoids.—A. Blondel: Theorems on the transmission of energy by alternating current analogous with those of Siemens on transmission by continuous current. Criticism of these theorems.—E. Mailet: Some properties of transcendental numbers.—C. Camichel: The permanent state in water reservoirs.—A. Perot: The variation with pressure of the wavelength of the lines of the cyanogen band.—F. Bourion: A method of physico-chemical analysis of commercial chlorobenzenes. By fractional distillation the specimen is divided into portions each containing only two constituents; measurements of density serve to determine the composition of each fraction. The accuracy obtained is illustrated by examples.—A. Kling and D. Florentin: The differentiation of masked and apparent sulphuric ions in complex salts. The use of benzidine as a reagent, suggested in a recent paper by P. Job and G. Urbain, was anticipated by the authors in 1914 in a study of solutions of the green chromium sulphate.—V. Auger: The salts of nitrosophenylhydroxylamine (cupferron): uranous salts. Uranic salts are not precipitated by cupferron, and vanadium can be quantitatively precipitated by cupferron in the presence of uranium, as was shown by Turner in 1916. If, however, by zinc reduction the uranic salts are converted into uranous compounds, the uranium can be precipitated also by cupferron, and under these conditions vanadium and uranium can be successively determined by means of the cupferron.—G. Deniges: Iodic acid as a microchemical reagent for calcium, strontium, and barium. A 10 per cent. solution of iodic acid forms a good reagent for the microchemical identification of calcium, strontium, and barium salts, soluble or insoluble. One milligram of material is sufficient for the purpose.—Ch. Manguin and L. J. Simon: The action of chlorine, hypochlorous acid, and cyanogen on cyanamide and its derivatives.—P. Bertrand: Value of the primary centrinetal metaxylem of old or primitive plants.—M. Guilliermond: The evolution of the chondriome during the formation of the pollen-grains of *Lilium candidum*.—H. Devaux and H. Bouygues: The usefulness of sodium fluoride employed as an antiseptic for the preservation of railway-sleepers. The scarcity of creosote has led railway companies to try other antiseptics for the preservation of wooden sleepers, and, among others, sodium fluoride has been extensively used. While there is no doubt as to the efficiency of sodium fluoride as an antiseptic, on account of the ease with which it is extracted by water, it is useless for the preservation of wood exposed to rain, and especially for the case of railway-sleepers.—A. Desgrez

and M. Polonowski : Determination of the total non-amino organic acids of the urine.—H. Colin : The diastatic hydrolysis of inulin. An account of some unsuccessful attempts to isolate products of hydrolysis intermediate between inulin and the reducing sugars.—J. E. Abelous and J. Aloy : Digestive hydrolyses by mechanical ionisation of water. Violent agitation is sufficient to determine a partial hydrolysis of solutions of starch, lactose, neutral fats, and fibrin. The effects increase with rise of temperature.—J. Chaîne : Considerations on the paramastoid apophysis of man.—A. Krepf : Observations on the development of *Pocillopora cespitosa* and *Seriatopora subulata*. Discovery of primitive stages revealing the scyphostrobilary origin of the Anthozoa.—MM. Weinberg and Nasta : Rôle of the hæmolysins in microbial intoxication and the therapeutic properties of normal sera.—A. Marie, C. Levaditi, and G. Banu : Experimental transmission of the triponeme of general paralysis (*virus neurotrope*) by sexual contact.

### Books Received.

The Idea of Progress: An Inquiry into its Origin and Growth. By Prof. J. B. Bury. Pp. xv+377. (London: Macmillan and Co., Ltd.) 14s. net.  
Nauka Polska. Tom ii. Pp. ix+676. (Warszawa.) Cena M.P. 25.  
Dumbartonshire. By Dr. F. Mort. Pp. viii+155. (Cambridge: At the University Press.) 4s. 6d. net.  
Orkney and Shetland. By J. G. F. Moodie and H. and T. Mainland. Pp. xii+167. (Cambridge: At the University Press.) 4s. 6d. net.  
Report on the Quantum Theory of Spectra. By Dr. L. Silberstein. Pp. iv+42. (London: Adam Hilger, Ltd.) 5s. net.  
Problems of Population and Parenthood: Being the Second Report of and the Chief Evidence taken by the National Birth-Rate Commission, 1918-20. Pp. clxvi+423. (London: Chapman and Hall, Ltd.) 25s. net.

### Diary of Societies.

**THURSDAY, MAY 20.**  
ROYAL INSTITUTION OF GREAT BRITAIN, at 9.—A. P. Graves: Welsh and Irish Folk Song.  
ROYAL SOCIETY at 4.30.—Prof. J. N. Collie: Some Notes on Krypton and Xenon.—Sih Lig Ting: Experiments on Electron Emission from Hot Bodies, with a Preface by Prof. O. W. Richardson.—Dr. L. Silberstein: The Aspherical Nucleus Theory Applied to the Balmer Series of Hydrogen.—T. E. Stanton, Miss D. Marshall, and Mrs. C. N. Bryant: The Conditions at the Boundary of a Fluid in Turbulent Motion.  
ROYAL SOCIETY OF ARTS (Indian Section), at 4.30.—Brig.-Gen. Lord Montagu de Beaulieu: Roads and Transport in India  
ROYAL SOCIETY OF MEDICINE (Dermatology Section), at 5.—Annual General Meeting.  
INSTITUTION OF MINING AND METALLURGY (at Geological Society), at 5.30.—G. Rigg: Roasting and Lead-Smelting Practice at the Port Pirie (S.A.) Plant of the Broken Hill Associated Smelters Proprietary, Ltd.—Capt. H. Tatham: Tunnelling in the Sand Dunes of the Belgian Coast.  
INSTITUTION OF ELECTRICAL ENGINEERS (at Institution of Civil Engineers), at 5.30.—(Annual General Meeting.)  
NUMISMATIC SOCIETY, at 6.  
OPTICAL SOCIETY, at 7.30.—B. K. Johnson: The No. 7 Dial Sight, Mk II.—L. L. Gifford: A Short High Power Telescope.  
CHEMICAL SOCIETY (Ordinary Meeting; Informal Meeting), at 8.—D. J. and Mrs. Matthews: Exhibit demonstrating the Methods of Controlling Soil Organisms now being Investigated at the Rothamsted Experimental Station.—Dr. Marie Stopes: Fossil Specimens and Microscopic Slides of Fusulin, Durain, Clarain, and Vitrain, the Four Main Constituents of Banded Bituminous Coal.—E. R. Thomas: Experiments Illustrating the Influence of Temperature, Concentration, Solvent, Constitution, and Catalyst on the Rate of Chemical Change.  
SOCIETY OF ANTIQUARIES, at 8.30.  
**FRIDAY, MAY 21.**  
ROYAL SOCIETY OF MEDICINE (Otolaryngology Section), at 5.—Annual General Meeting.  
WIRELESS SOCIETY OF LONDON (at Institution of Civil Engineers), at 6.—P. Coursey: Some Methods of Eliminating Atmospheric Interference in Wireless Reception.  
ROYAL SOCIETY OF MEDICINE (Electro-Therapeutics Section), at 8.30.—Annual General Meeting.

ROYAL INSTITUTION OF GREAT BRITAIN, at 9.—Prof. J. A. Fleming: The Thermionic Valve in Wireless Telegraphy and Telephony.

**SATURDAY, MAY 22.**

ROYAL INSTITUTION OF GREAT BRITAIN, at 3.—Frederic Harrison: The Reaction and the Critics of the Positivist School of Thought.

**TUESDAY, MAY 25.**

ROYAL INSTITUTION OF GREAT BRITAIN, at 3.—Major C. E. Inglis: The Evolution of Large Bridge Construction.

**WEDNESDAY, MAY 26.**

ROYAL AERONAUTICAL SOCIETY (at Royal Society of Arts), at 8.—Sir Richard T. Glazebrook: Some Points of Importance in the Work of the Advisory Committee for Aeronautics.

**THURSDAY, MAY 27.**

ROYAL INSTITUTION OF GREAT BRITAIN, at 3.—William Archer: Dreams, with Special Reference to Psycho-Analysis

LINNEAN SOCIETY (Anniversary Meeting), at 3.

ROYAL SOCIETY, at 4.30.  
CONCRETE INSTITUTE (Annual General Meeting, followed by an Ordinary Meeting), at 7.30.

**FRIDAY, MAY 28.**

ROYAL SOCIETY OF ARTS (Indian and Colonial Sections, Joint Meeting), at 4.30.—Prof. W. A. Bone: Lignite.

ROYAL SOCIETY OF MEDICINE (Study of Disease in Children), at 4.30.—(Annual General Meeting.)

PHYSICAL SOCIETY OF LONDON, at 5.—Sir W. H. Bragg and Others: Discussion on X-ray Spectra

ROYAL INSTITUTION OF GREAT BRITAIN, at 9.—Prof. W. L. Bragg: Crystal Structure.

**SATURDAY, MAY 29.**

ROYAL INSTITUTION OF GREAT BRITAIN, at 3.—Dr. J. H. Jeans: The Theory of Relativity (Tyndall Lectures).

### CONTENTS.

	PAGE
The Officers Training Corps and the Universities	349
Relativity and Geometry. By E. Cunningham	350
Colloidal Therapy	351
Nature Pictures. By W. E. C.	352
Our Bookshelf	352
Letters to the Editor:—	
The Cost of Scientific Publications.—Prof. G. H. Hardy, F.R.S.; Dr. A. B. Rendle, F.R.S.; Dr. B. Daydon Jackson; Dr. Charles S. Myers, F.R.S.	353
The Indian Chemical Service.—Dr. M. W. Travers, F.R.S.	354
A New Method for Approximate Evaluation of Definite Integrals between Finite Limits.—A. F. Dufton	354
British and Metric Systems of Weights and Measures. M. E. Yeatman	355
Scientific Apparatus and Laboratory Fixtures.—Conrad Beck; B. H. Morphy; C. Baker; Bellingham and Stanley, Ltd.; Wm. Taylor; H. W. Ashfield	355
Naturally Fractured Eocene Flints.—J. Reid Moir	358
International Council for Fishery Investigations.—Prof. W. C. McIntosh, F.R.S.	358
Sea and Sky at Sunset.—Lt.-Col. K. E. Edgeworth; J. S. D.	358
Scientific Research.—Dr. John W. Evans, F.R.S.	358
Imperial Air Routes. (Illustrated.)	359
Helium: Its Discovery and Applications. (Illustrated.) By Dr. William J. S. Lockyer	360
New Conceptions of Psychology	363
Obituary:—	
Principal R. M. Burrows	364
Notes	366
Our Astronomical Column:—	
A Bright Fireball	370
Conjunction of Mercury with $\epsilon$ Gemorum	370
Longitude by Wireless Telegraphy	370
Periodicity in Weather and Crops. By W. W. B.	370
The National Food Supply	371
The Research Association. By J. W. E.	372
Solid Lubricants. By L. A.	372
Greek Science and Philosophy	373
Life-history of the Periwinkle	373
The Royal Society Conversazione	373
University and Educational Intelligence	376
Societies and Academies	377
Books Received	380
Diary of Societies	380



THURSDAY, MAY 27, 1920.

*Editorial and Publishing Offices:*MACMILLAN & CO., LTD.,  
ST. MARTIN'S STREET, LONDON, W.C.2.Advertisements and business letters should be  
addressed to the Publishers.

Editorial communications to the Editor.

Telegraphic Address: PHUSIS, LONDON.

Telephone Number: GERRARD 8830.

**The University of London: A Great  
Opportunity.**

**L**AST week there was made public the details, printed elsewhere in this issue, of the offer by the Government of a site for the University of London. The Government proposes to give to the University about 11½ acres behind the British Museum as a site for the University headquarters and for colleges and institutions connected with it, including King's College, the premises of which in the Strand have long been insufficient for the needs of the college. The Senate has referred the question to a committee the report of which will doubtless shortly be forthcoming.

None of Mr. Fisher's labours in the cause of university education—and they are many—will redound more to his credit than the attempt to provide the University of London with a home worthy of itself and of the capital city of the Empire. Since the reconstitution of the University as a teaching body in 1900, a great deal has been done in the organisation of university teaching and research in London. The professors and teachers of the University include many most distinguished men of science and scholars, and in the number of students it easily takes the lead in Great Britain. In recent years the University has drawn students from all parts of the world, attracted by the unique advantages which London can offer by reason of the resources of its libraries and museums. The establishment in the heart of the City of the School of Oriental Studies, and the association of business men with the foundation of the scheme of degrees of commerce, show also that the University can, by recognising the needs of the commercial interests of the City, obtain their active assistance and support.

It cannot be gainsaid, however, that, in spite

of all that has been done, the University has as yet failed to justify the hopes of those who looked forward at its reconstitution to the creation of a great teaching university. We need not enter into a discussion of all the causes which have prevented or hindered the fulfilment of these hopes. Among them are the heterogeneous nature of the institutions—varying from colleges of the type of University and King's Colleges to polytechnic institutions—in which the teaching and research work are carried on, and the intricacy of its existing constitution.

But unquestionably the chief cause of the failure of the University to take the great place assigned to it has been the discrete nature of its component parts, the inaccessibility of its administrative headquarters, and the lack of a home or a quarter of its own to which one could point as *the* University. It is a commonplace that bricks and mortar do not make a university, but it is undoubtedly true that without a tangible symbol there can be no appeal to the sympathies or imagination of the public, and it is the absence of such a symbol which more than anything else has militated against an understanding of the work that the University has done and is doing. Until the University possesses a building indisputably its own and designed for its own purpose, and until the great incorporated colleges are brought together, there can be no hope of impressing the greatness of the University upon the public, or of overcoming the dissipation of energy which is now such a hindrance to its work.

The question is, of course, not a new one. Its importance has been appreciated for some time, and before the war there were negotiations in the air for the acquirement of a site in Bloomsbury. For various reasons these negotiations did not fructify, and it may be that the site then under consideration was inadequate and in other ways unsuitable. The objections offered to it are not, however, valid in the present case.

The site now offered is excellent in every respect. By reason of its proximity to Bedford College for Women and to University College, it is already the nucleus of the "University Quarter" desiderated by the Haldane Commission. It is sufficient in extent not only for the administrative headquarters, the University library, and King's College, but also for other colleges of the University which are outgrowing their accommodation; and it is capable of extension if still further accommodation is required.

It is, what South Kensington is not, an easily accessible place, and yet is not too noisy for the purpose, and it will have the additional advantage of the near presence of our greatest library and museum. It is safe to say that there is at present no site in London comparable with it, and none so suitable is likely to be available for many years.

The only objection possessing any validity to the acceptance of the Government's offer is the financial one. This is, we admit, a serious question, and it would be foolish to minimise its importance. Hitherto both the University headquarters and King's College have been housed free by the Government. This arrangement will now come to an end, and it is obvious that the cost of covering the site with buildings that shall be worthy of London's University will be considerable. Mr. Fisher feels that in this the University can look with confidence to the generosity and public spirit which have always marked the citizens of London. We think he is right. We are convinced that, if proper efforts are made, enough and more than enough money will be forthcoming for the purpose. The results of the present Vice-Chancellor's appeal to the City in connection with the degrees of commerce of the University afford an index of the support that would be forthcoming from the City Companies and the great commercial houses if the sympathies and the co-operation of the commercial community were enlisted in the greater cause of the University as a whole. Private benefactors would be attracted to a bold and well-conceived plan of creating a great university quarter, and Londoners, if there were some outward and visible sign of the greatness of their University, would not be found wanting either in the civic pride or in the willingness to pay which is found in the provinces or in Continental cities.

We hope the University authorities will take their courage in both hands and go forward boldly. The reasons which forbid the Government from giving further assistance in these days may be regrettable, but they are easily intelligible. We are sure that if the University rises to the occasion neither this nor any future Government will be allowed to leave it to struggle unaided. We are equally sure that if counsels of timidity are allowed to prevail and this opportunity is lost the University will have forfeited irrevocably any claim on the public or the Government for support in the future.

### Manuals on Applied Chemistry.

- (1) *Practical Leather Chemistry: A Handbook of Laboratory Notes and Methods for the Use of Students and Works Chemists.* By Arthur Harvey. Pp. viii+207. (London: Crosby Lockwood and Son, 1920.) Price 15s. net.
- (2) *Chemistry for Textile Students: A Manual Suitable for Technical Students in the Textile and Dyeing Industries.* By Barker North, assisted by Norman Bland. (Cambridge Technical Series.) Pp. viii+379. (Cambridge: At the University Press, 1920.) Price 30s. net.
- (3) *The Chemistry of Coal.* By John Braithwaite Robertson. (Chemical Monographs.) Pp. viii+96. (London: Gurney and Jackson, 1919.) Price 3s. 6d. net.

(1) **M**R. HARVEY'S handbook is intended for the use of the works chemist in charge of the analytical and testing department of a tannery. It is an eminently practical work, well and clearly written with due regard to modern methods, and evidently based upon considerable personal experience. It presupposes that the user of the book has had not only a preliminary course of instruction in theoretical chemistry, but also the opportunity of a laboratory training in manipulation in qualitative and quantitative analysis. In these circumstances the book can be thoroughly recommended as an excellent *vade mecum* to the work of the chemical laboratory of a tannery, or to the student who intends ultimately to specialise on leather chemistry. It will be found to cover practically every problem that the works chemist of a tannery may have to face. The analytical methods described have been thoroughly tested, and are well adapted to practical conditions.

(2) The manual by Mr. Barker North and Mr. Norman Bland is a work of a very different class. It is essentially a text-book of the elementary chemistry of certain of the non-metallic elements and their compounds, together with a somewhat bald account of the chemistry of a few carbon derivatives. The section devoted to technical chemistry as applied to the textile industries occupies only some twenty-eight of the 379 pages of which the book consists. The authors are lecturers in chemistry to the evening classes of the Technical Colleges of Bradford and Huddersfield respectively, both important centres of the textile and dyeing industries, and their object, no doubt, is to attract students who are, or may be, engaged in these industries. In their preface they point out that whilst the cotton and woollen industries occupy most important positions

among the nine leading industries of the country, it is only within recent years that even enlightened employers have begun to realise that "chemistry and physics play a most important part in the various operations used in the production of yarns and finished pieces."

All this may be very true. But it is equally true that the hard-headed Yorkshire manufacturer who turns over the pages of this well-printed and handsomely illustrated book will be slow to perceive wherein it bears directly upon his industry. He will be apt to think that the kinetic theory and Avogadro's hypothesis have as little to do with woollens and worsteds as the binomial theorem has with the common pump. There is not the slightest intention to minimise the importance of a knowledge of the principles upon which chemistry as a science is based, or to depreciate its value when applied to industry. It is admitted, of course, that no technologist is adequately trained who is wholly ignorant of the science. But in compiling a text-book which would seem to be mainly directed to the work of their classes the authors have attempted too much. They have mixed up purely elementary doctrinal chemistry with applications involving a very different kind of knowledge. The problems of textile chemistry are far more recondite than their association with rudimentary chemistry, as in this book, would seem to imply. We have no fault to find with the book as a text-book to accompany an experimental course of evening lectures such as the authors are engaged in giving, except that its price will probably be beyond the means of the ordinary evening-class student.

The course as set out in the book is well arranged, and it is intended that the pupils shall themselves perform many of the elementary experiments described, presumably in a laboratory class. There is no doubt that if they work through the list under competent direction they will acquire a considerable amount of information, and gain some proficiency in chemical manipulation. No special experiments are described in the section devoted to the systematic study of the non-metals and their important compounds, or in that concerned with the chemistry of the hydro-carbons and their derivatives, but the student is directed to "pick out the portions which are suitable for experimental illustration with the apparatus at his command"—a direction which, it may be hoped, will strengthen any latent power of original investigation that he may possess.

The scope of the teaching has presumably been limited to what has been found to be practicable in such courses of evening-class instruction as are possible in the institutions with which the authors

are connected, and there can be no doubt that if the beginner faithfully follows the teaching and supplements it by reading the "larger and more specialised works" to which he is referred, and which, it is to be hoped, he will find in the libraries of the schools to which he may be attached, he will have acquired a very fair acquaintance with the elements of chemistry. But as he pursues his reading, and enters upon the perusal of the more specialised works on the chemistry of textiles, he will realise that he has got no further than the alphabet of the subject. After all, a knowledge of the alphabet is an essential step, and it may be that the authors, *pace* the title of their book, have aimed no higher. The time will come when our technical schools will not mix up elementary with applied teaching, but make each section independent. Applied chemistry must of course be based on elementary and theoretical chemistry, but there are no short cuts to proficiency in any one branch, and it is a bad system of instruction which fosters the idea that there can be.

(3) In about ninety small octavo pages Mr. J. B. Robertson, lecturer in chemistry at the South African School of Mines and Technology, Johannesburg, has sought to give an account of the chemistry of coal. His title may be held to imply more than his little monograph actually covers, as he confines himself to a very limited portion of what in reality is a very wide field, and has very little to say respecting the chemical derivatives of coal, except to the extent that they may be supposed to throw light on the nature of the proximate constituents of coal. In five short chapters, or sections, Mr. Robertson discusses the mode of occurrence of coal, its origin, and the various methods of classifying it; the action of solvents, *e.g.* benzene and pyridine, etc., upon the coal substance; its oxidation and destructive distillation. The summaries are exceedingly short, but they are accurate and fairly up-to-date, and at least serve to show how much remains to be done before the real chemical nature of coal is elucidated. Practically all that we know at present is that coal consists of a variable and indefinite mixture of at least two constituents, one of which appears to be a degradation product of cellulose, and the other a resinoid substance which can be extracted by appropriate solvents; and that it is upon the relative proportion of these constituents that the technical value and industrial applications of coal largely depend. But the precise nature of these constituents is as yet very imperfectly defined, and the suggestions that have been made as to their origin are little more than surmises.

The most detailed sections of the book relate

to the analysis of coal, proximate and ultimate; these, compared with the preceding sections, are remarkably full and evidently based upon personal experience. It would have added to the comprehensiveness of the account if a description of the methods of determining arsenic had been given. Owing to legislation arising out of the arsenic-in-beer scare the value of coal, especially anthracite, for kilning purposes is greatly affected by the presence of even small quantities of arsenic. The method of determining the calorific value of coal would have been rendered more intelligible if the description had been accompanied by an illustration of the calorimeter. Lastly, we deprecate the practice of placing the bibliographical references in the text at the end of the book. This method, at least as regards chemical literature, seems to have originated in Germany. We fail to perceive that it has a single redeeming feature. On the contrary, it produces the maximum amount of inconvenience. It involves constant turning backwards and forwards, which is apt to become tiresome and to lead to error. It is far preferable to embody the references in the text, or at least to place them as foot-notes to the pages on which they occur.

### A Standard Book on Soils.

*The Soil: An Introduction to the Scientific Study of the Growth of Crops.* By Sir A. D. Hall. Third edition, revised and enlarged. Pp. xv + 352. (London: John Murray, 1920.) Price 7s. 6d. net.

IT is pleasant to see that Sir Daniel Hall's book on the soil has now reached a third edition. It will have a permanent place in British agricultural literature as the first book on the subject in the modern period. Its distinguishing feature, which marked it off from its predecessors, is its clear recognition of the complexity of the soil problem, emphasised in the opening words and maintained throughout: "In the scientific study of soils, chemical, physical, and biological considerations are involved." Successive generations of earlier workers had regarded soil fertility as essentially chemical, physical, or bacteriological. This book was the first to show British readers that all these different views had a basis of truth, but that each by itself was too narrow. The study of the soil, in short, cuts across the conventional divisions of science and brings together such apparently diverse workers as the physicist and the protozoologist, the mathematician and the plant physiologist, and others who in an ordinary scientific laboratory would be supposed to have nothing in common.

To write an adequate review of the book, comparing it with the preceding editions, would be to write a history of the development of modern soil science, and could not be done in a short notice. The leading advances have been in our knowledge of the constitution of the soil and of the population inhabiting it. In both directions recent investigations have revealed greater complexity and emphasised still further the need for "team" work to supplement the indispensable, but limited, individual work.

Ten years ago there was only one soil biologist at Rothamsted; now there are nine, and others, it is hoped, will soon be added. Bacteria were at first supposed to be the only organisms concerned; now it is realised that fungi, actinomycetes, algæ, and protozoa are all present in the soil, and probably all concerned in some way in the great changes going on.

Sir Daniel stimulates a living interest in the subject and makes constant reference to the experience of farmers, gardeners, and others in soil management and in the behaviour of plants in different soil conditions. These serve to show the student how much remains to be done in spite of all the advances of recent years; in this way also the book acts as a valuable corrective to the tendency showing itself in certain modern textbooks of regarding the soil as a physico-chemical system the properties of which are expressible in mathematical terms. These analytical methods have their uses, but they would become dangerous if they were allowed to obscure the complexity of the problem.

There is a valuable section on soil types containing much information of interest to the ecologist as well as to the agriculturist. The section on land reclamation is of particular interest at the present time and has a breadth of view and a freedom from extravagant anticipations rarely found in discussing this important subject. Altogether the book keeps up its reputation and will prove invaluable to the serious student of the subject.

E. J. R.

### Savages of the Far Past.

*An Introduction to Anthropology: A General Survey of the Early History of the Human Race.* By the Rev. E. O. James. Pp. ix + 259. (London: Macmillan and Co., Ltd., 1919.) Price 7s. 6d. net.

MR. JAMES aims at introducing the student not so much to anthropology in general as to prehistoric archaeology interpreted in the light of the study of primitive man, modern as well as ancient. After an introductory chapter outlining

the scope of anthropology conceived as the study of man in evolution, he proceeds to sketch the evidence relating to the side of somatology. Considering the limitations of space, his account seems fairly complete. A few slips occur. *Trogontherium* will scarcely do as the name of a kind of elephant. *Rhinoceri* reminds us of *octopi*. More important, it is a pity to adopt Klaatsch's term "Aurignacian man" to describe a physical type (Combe Capelle), seeing that to do so is to correlate a race with a cultural type which may or may not have been confined to that race—nay, probably was not. Next, the characteristic forms of industry are described. We note that Mr. James is inclined to accept the Sub-Crag flints as of genuine human workmanship. He also takes the view that the Mousterian industry is inferior to the Acheulean, representing a set-back in culture and not an advance as effected by a labour-saving device. Mr. James is entitled to judge at first hand, inasmuch as he has worked on a Mousterian site (Jersey), where material was plentiful. Perhaps he does not sufficiently allow for the fact that, if finely wrought pieces were but as one in every hundred fragments forming the workshop refuse, these masterpieces were of a very high quality, symmetrical in outline and smoothly and delicately finished off.

The book then goes on to try to construct some picture of the social organisation and magico-religious beliefs prevailing during the prehistoric period, and especially among the later cave-men. Necessarily the treatment is somewhat speculative, but the analogies provided by modern savages are put forward without dogmatism and so as to invite the student of archaeology to equip himself for his special task by acquiring the elements of anthropology as a whole. Mr. James has already written on the subject of primitive religion, with special reference to the Australian aborigines. The latter, then, naturally provide him with most of his clues, but here he has the support of most writers on this branch of the subject, from M. Salomon Reinach onwards. Certainly it is hard to resist the impression that the drawings found in the deep recesses of caverns, as at Niaux, served a magico-religious purpose; art for art's sake would surely have craved a good light. What, then, more natural than to compare the Australian *intichiuma* ceremony with its rock-drawings demonstrably designed to further the multiplication of animals and plants fit for human consumption? It does not follow, of course, that every institution of the Australians can therefore be fathered on the men of Pleistocene Europe. Totemism is more doubtful than *intichiuma*; delineations of embryonic spirits (*inapertua*) are more doubtful than either;

while *churingas* and Azilian coloured pebbles are not to be identified offhand. Mr. James, however, steers his way warily among these tempting possibilities, and the result is a manual which will make the student think without professing to supply the thought ready-made. R. R. M.

### The Problem of Clean and Safe Milk.

*The Modern Milk Problem in Sanitation, Economics, and Agriculture.* By J. Scott MacNutt. Pp. xi+258+16 plates. (New York: The Macmillan Co.; London: Macmillan and Co., Ltd., 1917.) Price 10s. 6d. net.

THE purpose of the author of this volume is to provide a convenient survey of the practical, economic, and sanitary factors of the milk problem, so as to meet the needs not only of health officers and milk inspectors, but also of dairymen, city milk dealers, agricultural authorities, consumers, physicians, and all others who are interested in the problem.

This survey is almost entirely based upon the experience gained in the United States as set forth in official reports or publications which have appeared in America, mostly since 1910.

The author knows that the milk question has also received the attention of some European workers, and refers in a few words (p. 66) to the communication made by Mr. Ernest Hart at the International Medical Congress held in 1881, in which mention is made of sixty-nine epidemics of disease attributable to milk. The only other English writer specifically mentioned in the text is Smollett (p. 32); the very realistic description of the milk consumed in London introduced by that author in a letter of Mr. Bramble to Dr. Lewis ("The Expedition of Humphrey Clinker") is certainly very interesting, for it shows that the milk problem already exercised the minds of thinking men some 150 years ago.

Although European observers have little to learn from their American colleagues regarding the causes of the deplorable state of the milk consumed in large and other towns, and its serious consequences, it must be acknowledged that greater enterprise has been shown in the United States in the devising of methods and regulations having for their object the improvement of the milk supplies.

It is specially on that account that the book will prove useful to British readers, who will find in it a comprehensive and critical summary of many of the results obtained in America by sanitary and agricultural authorities, as well as by various

committees, associations, and individual observers. The author shows not only that much progress has been made towards the solution of the problem, but also that some of the methods which have been tried, such as the score-card method of inspection, are by no means so useful as some enthusiasts on this side of the Atlantic have proclaimed.

The author is justly impressed by the merits of the North system (p. 78), the object of which is to prevent contamination of the milk at the time of milking by simple but essential precautions which can be taught to any farmer, the part of the work which cannot safely and economically be carried out at an ordinary farm being undertaken at well-equipped stations.

The quality of the milk is determined by the amount of butter-fat and the number of bacteria. A premium is paid for milk containing less than 10,000 bacteria per c.c., and also when the butter-fat exceeds a certain standard—say, 3.7 per cent.

Notwithstanding many repetitions, the book is interesting from beginning to end, and is written in a clear and popular style, which to an English reader derives a certain quaintness from its Americanisms.

SHERIDAN DELÉPINE.

### Our Bookshelf.

*The Whole Truth about Alcohol.* By George Elliot Flint. With an introduction by Dr. Abraham Jacobi. Pp. xii+294. (New York: The Macmillan Co.; London: Macmillan and Co., Ltd., 1919.) Price 6s. net.

The writer of this book is an uncompromising anti-prohibitionist, and a whole-hearted supporter of St. Paul's dictum with regard to the use of alcohol. He considers that alcohol has been greatly maligned, that many of the vicious attacks upon its use have no basis of real evidence, of reason, or of common sense, and that its influence for evil and as a deteriorator of the human race has been, at least, greatly exaggerated. He discusses *seriatim* the many statements that have been advanced regarding the deleterious action of alcohol, even in the most moderate doses, and the better state of total abstinence, and he adduces many arguments and some facts contravening these.

On the whole, the tenor of the book is reasonable, and the conclusion is that moderation never hurt anyone, and in some respects is better than total abstinence. With many of the author's views we are in sympathy, and we fully agree that prohibition is not the best route to temperance. Like him, we doubt if the moderate use of alcohol is in any sense deleterious; but the difficulty is to define what is moderation, and we are sure that many who take alcohol in what they regard as strict moderation are exceeding the harmless

dose. For anyone who desires the anti-prohibition view the book will furnish a wealth of matter, but it is written largely from the American point of view.

Dr. Jacobi contributes a brief but interesting introduction, in which he states that in the worst cases of sepsis and toxæmia—*e.g.* in diphtheria and puerperal fever—alcohol in the largest doses furnishes the only salvation. With this view we largely agree; but the use of alcohol in disease is of course on a very different footing from the general use of alcoholic beverages in health.

R. T. H.

*The Geography of Plants.* By Dr. M. E. Hardy. Pp. xii+327. (Oxford: At the Clarendon Press, 1920.) Price 7s. 6d. net.

THE present volume is a continuation of the introduction to plant geography by the same author issued in 1913 as one of the series of the Oxford geographies designed by the late Prof. and Mrs. Herbertson. It may be regarded as an expansion of part iii. of the earlier work; the slight survey of the continents given there has served as the plan for the new book, which embodies a discussion of the conditions in which plants flourish, and their distribution in the great geographical divisions of the earth. The great continents are considered in successive chapters—Asia, North America, South America, Australia, Africa, and Europe—and each chapter gives a concise account of the physical features and climate, the bearing of these upon the extent and character of the vegetation, and their relation to the support and development of mankind. The book is profusely illustrated with maps and a well-selected number of photographic reproductions of aspects of vegetation. There is a geographical index, and also one of plant names, in which the scientific and popular names of the plants referred to are arranged under the different continents. The little volume should interest alike students of geography and botany, and botanists especially will welcome it as filling a gap in their series of text-books.

*A Handbook to the Vertebrate Fauna of North Wales.* By H. E. Forrest. Pp. v+106. (London: Witherby and Co., 1919) Price 6s. net.

MR. FORREST, the author of "The Vertebrate Fauna of North Wales" (1907), has now published this shorter "handbook," convenient for naturalists and interested visitors. It deals with 28 prehistoric mammals, 8 mammals extinct during the historic period, 43 existing mammals, 227 birds, 5 reptiles, 6 amphibians, and 151 fishes. Under each species is a brief summary showing its status and distribution in the area. Trustworthy information has been collected from many observers, and the whole work is marked by careful precision, an indispensable quality in faunistic census-taking.

### Letters to the Editor.

[The Editor does not hold himself responsible for opinions expressed by his correspondents. Neither can he undertake to return, or to correspond with the writers of, rejected manuscripts intended for this or any other part of NATURE. No notice is taken of anonymous communications.]

#### Scientific Work: Its Spirit and Reward.

THE true incentive of the scientific worker is his work. Through his work he expresses the creative thought within him, which he feels to be his highest life. This expression must through its very nature be free, otherwise he becomes a slave in the worst sense, in that the free exercise of intelligence is denied him.

Because this freedom is sacred to the scientific worker he sometimes has to sacrifice income and the possibility of family life to retain it, but this is a mere misfortune, not in any sense a necessary concomitant of scientific ability. The sentimentalist and the exploiter have promulgated the idea that the scientific worker, being exalted above the need for normal human joys and amenities, works best on the smallest possible income; or, having found that this does not always work out in practice because it tends to reduce the output of useful results, as the reduction of rations to one bean per day led to the unfortunate demise of the horse, the opposite line is taken, and it is supposed that by large remuneration the valuable work looked for can be bought.

Neither the one nor the other point of view is correct. The scientific worker if he is normal needs the means to enable him to have a happy, care-free home-life, and to educate his children in such a way that they in turn may be free as he would be. Therefore to starve him is to eliminate the normal and consequently intelligent worker in favour of the eccentric. For let it be clearly stated, the highest intelligence is always supremely sane. The idea of a scientific worker as a harmless lunatic is by no means confined to sensational fiction, although it might as well be imagined that every long-haired user of a piano is a Paderewski, or every loose-tied splasher of paint on canvas a Sargent.

On the other hand, to believe that creative thought can be purchased with money is to repeat the mistake of Simon Magus. Imitative thought in all its manifestations can be obtained for an adequate remuneration, because it can be produced by outward drill, discipline, and experience. So experts in the orderly routine dear to the official mind can be turned out by mass-production like cheap crockery, and are similarly useful and indispensable.

There is, however, no means of estimating the value of one really original thought either in pure or in so-called applied science. Certainly the possession of anything like its value in money would often be an embarrassment to the scientific worker through whom it is expressed. He also would be the first to disclaim any absolute or exclusive right to it. In the last analysis, humanly speaking, there is no such thing as an absolutely original idea, and it is seldom that any single individual can claim undivided credit for bringing a new idea to birth.

On the other hand, to divide its money-value, if it have any, in such a way that little or nothing comes back to the immediate originator is simply unjust, and therefore ultimately disastrous.

A certain type of person sniffs at Lord Kelvin for having become part owner of numerous important patents. No one will deny Lord Kelvin's position as

a scientific worker; that he was also a business man merely means that his gifts were more readily applied to the good of humanity.

That a scientific worker should be debared from any reward or protection by patents embodying his discoveries, because of his occupying either a public or private salaried position, is not only unjust, but also often unbusinesslike and against the public interest. The equitable adjustment of rights and returns as between public or private capital and the actual inventor is often the only way to prevent exploitation by purely selfish private interests.

To repeat, the true incentive of the scientific worker is his work. Salary, kudos, position, *esprit de corps*—these are incentives to good and useful people, but they are not the true incentives of the real scientific worker. To obtain the best from him, he must before all things have freedom, and, if possible, also a reasonable measure of justice.

"The bearings of this observation," as Capt. Bunsby in "Dombey and Son" remarked, "lays in the application on it."

GILBERT J. FOWLER.

Indian Institute of Science, Bangalore, India.

#### Applied Science and Industrial Research.

At a meeting held at the Birkbeck College on April 28, organised by the National Union of Scientific Workers to urge more public support of scientific research, Prof. Soddy, the principal speaker after Mr. H. G. Wells, who occupied the chair, made a strong attack on the Department of Scientific and Industrial Research and the industrial research associations which have been, and are being, established under its aegis (see NATURE for May 6, p. 309). As much of Prof. Soddy's criticism seems to lend colour to current misconceptions of industrial research and of the functions of the research associations fathered by the Department of Scientific and Industrial Research, I beg the hospitality of your space for the following observations.

No one disputes the vital and urgent need for increasing the facilities for scientific study and scientific research. All those who know the facts will echo Mr. H. G. Wells's just indignation at the national neglect of science and the half contemptuous treatment by the State of our great men of science. I go further and agree with Prof. Soddy that in the extension and intensification of scientific study and research the claims of pure science must be primary and paramount. But I deny emphatically that this involves a similarly short-sighted and contemptuous attitude towards the needs of applied science and industrial research. If English industry has suffered too long from the dominance of mere rule-of-thumb methods; if our manufacturers have, through ignorance, underrated the value of science, the fault has not been wholly and exclusively theirs. The academic people who have contemned applied science and industrial technology as something little better than a crude empiricism must bear some share of the blame. The manufacturer may have kept his feet too much in the mud; the academician has too often kept his head entirely in the clouds. If one has been too disdainful of scientific methods that did not ensure or promise immediate dividends in cash, the other has talked at times as though the mere prospect of a utilitarian issue to a specific research were enough to defile it and make it unworthy of his serious attention. We all know the type of academic science worker to whom an investigation of the internal structure of the atom is a noble and purifying pursuit, and

a research on soap an ignoble and degrading occupation; as though atoms *per se* were inherently dignified and only became disreputable when associated with other atoms to form the molecules of a useful, if homely, commodity. There are many forms of snobbery. Pure science itself has had to put up with a good deal of classical snobbery, as Mr. Wells has more than once testified. I doubt whether matters will be mended by a development of such a form of scientific snobbery as seems often to be the inspiration of the disparagement, in academic circles, of applied science and industrial research.

Fortunately this attempt to erect an arbitrary and artificial barrier between pure and applied science is becoming progressively discredited as the nature of industrial research and its dependence on pure science are becoming better known. Every research in applied science, if it is to be thorough, involves some research in pure science. An industrial problem may be, and often is, the starting-point of a research that may widen the bounds of knowledge as much as any research born of a conception in pure science. Applied science and industrial research have been developed more widely in America than in any other country, if we except Germany. How does American experience confirm the view that to foster industrial research is to starve pure research? In the paper on "Industrial Research in the United States of America" by Mr. A. P. M. Fleming, published for the Department of Scientific and Industrial Research, there is abundant testimony to the recognition, by firms and institutions engaged in industrial research, of the importance of pure science research. Such an industrial leader as Dr. J. J. Carty, vice-president of the American Telephone and Telegraph Co., in his presidential address to the Institute of Electrical Engineers in 1916, emphasised this view: "By every means in our power, therefore, let us show our appreciation of pure science, and let us forward the work of the pure scientists, for they are the advance guard of civilisation. They point the way which we must follow." Mr. Elihu Root, chairman of the board of trustees of the Carnegie Institution of Washington, in a paper on the need for organisation in scientific research, makes the same point: "While the solution of specific industrial problems and the attainment of specific industrial objects will be of immense value, the whole system will dry up and fail unless research in pure science be included *within its scope*." Mr. W. A. Harmor, assistant director of the Mellon Institute of Industrial Research, University of Pittsburgh, bears similar testimony to the needs of pure science: "The wide view is now taken that, in considering the needs of industry, pure science investigation has as essential a contributory function as that specifically devoted to the attainment of some technologic objective." One could multiply almost indefinitely such tributes to the primary and paramount necessity of investigations in pure science from men and organisations concerned mainly with industrial research. Prof. Soddy's argument that for the million of money which the Government has expended or earmarked for scientific research pure science has got little or nothing is, therefore, based on a misconception of the nature of industrial research, and is directly contradicted by past experience and present knowledge.

The assumed antagonism between pure and applied science is baseless in fact and mischievous in tendency. As Mr. Harmor has well said: "Both pure and applied research are of the same order of importance and each has its own related field." The alleged inferior character of applied research as compared with pure research has no better foundation in fact than the alleged inferiority of scientific studies, as

instruments of intellectual training, to classical studies. As Mr. A. W. Mellon, president of the Mellon National Bank of Pittsburgh, in an article on the value of industrial research, aptly expressed the matter: "The fundamental differences between pure research and industrial research are, indeed, traceable to the differences in the poise and personality of the representatives of each type of scientific investigation. Success in genuine industrial research presupposes all the qualities which are applicable to success in pure science, and, in addition, other qualities, executive and personal, more or less unessential in the pure research laboratory."

It would be strange if it were not in line with other experience that every time an attempt is made to extend and foster applied science and industrial research someone raises the cry that pure science is thereby being neglected and starved. This is to argue as though the total fund, both of money and energy, available for the purposes of scientific education and research were a fixed fund, so limited that any amount devoted mainly to the purposes of applied science must thereby lessen the sum available for pure science. It is a fallacy on a par with the trade-union notion that increased production by the individual worker will increase unemployment, and, by augmenting the profits of the employers, diminish the wages of the employees; and it is a proof, if proof were needed, that academic trade unionism can be as selfish and short-sighted as any other kind. Yet, just as the present condition of Europe affords a plain proof of the economic truth that the weakness of one nation impairs the strength of all, so will the cause of pure science not be bettered, but rather worsened, by attempts to crab the progress of industrial research.

The Department of Scientific and Industrial Research, as Sir Frank Heath has well said, is engaged on a great adventure. Thanks largely to its efforts, already the spirit of science is stirring among the dry bones of industries to which it was previously little known. The research associations formed and to be formed, which will cover a wide and diversified area of British industry, are attracting, and are destined to attract, scientific workers of the highest distinction and widest outlook, among them, no doubt, many of the members of the National Union of Scientific Workers, under whose auspices Prof. Soddy made his attack on the Department and the research associations. I submit that the cause of pure science is not well served by inconsiderate attacks on this industrial research movement, which is admittedly a novel experiment, beset by unforeseen, because unprecedented, difficulties, but the success of which must react to benefit pure science as well as to redeem British industry.

J. W. WILLIAMSON.

26 Russell Square, W.C.1, May 6.

### A Rainbow Inside Out.

IN February last Mr. P. H. Hepburn directed my attention to some surprising light-bows he had observed on several occasions on the surface of one of the ponds on Hampstead Heath. On February 24, we examined them together. A footpath lighted by three electric street-lamps runs along the southern edge of the pond. As one passed along this path bright bows of strange forms cast by the lamps were seen to spring out from the edge. The night was dark, the air still and slightly foggy, and the water smooth and covered with a film of scum extending as far as we could see in the dim light. There was no frost. The bows were judged to be on the surface



of the water, which was only about a foot below the level of our feet.

The form of the bows is shown in Fig. 1, which is taken from a rough sketch made by the writer from memory after returning home and before any explanation of the phenomenon had suggested itself. Here O is the observer in three positions, I, II., and III., and the bows seen from these positions are numbered correspondingly. The twin bows seen in position I. and the double curvatures at a in positions II. and III. struck us as remarkable. As the observer moved from the first position to the second, the nearer branch of I. sank into the bank of the pond and the

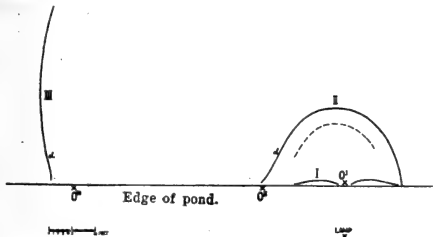

FIG. 1.—O, OII, OIII, three positions of the observer's eye; I, II., III., the bows seen in these positions; a, points of double curvature.

further branch sprang out in a somewhat startling manner until it attained the size roughly shown at II. The observer proceeding towards III., the apex of the bow, became lost in the distance.

The bows were colourless except for a tinge of red on the inside and of light of shorter wave-length on the outside. They formed the limiting inner edge of faint, diffuse luminosity extending over the general surface of the pond, and within the bows was darkness. In position II. a ghost of an inner bow was seen within the principal bow, roughly as shown in the figure. No colour could be distinguished in this inner bow.

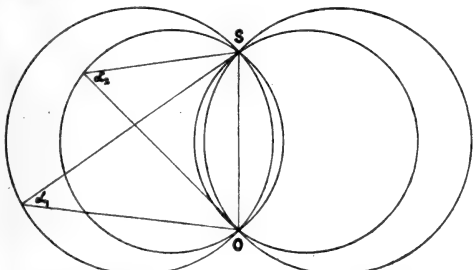

FIG. 2.—S, source of light; O, eye of observer;  $a_1, a_2$ , angles of minimum deviation for primary and secondary bows respectively.

In the first position the surface of the water was only about 5 ft. below the eye, and around the shadow of the observer's head—on the fog as we thought at the time, but on the water-surface as we now believe—the diffuse light was brighter, forming an aureole a few inches in breadth. When the head was turned slightly, so that a ray of light from the lamp to the water could pass close to the eye, the aureole at the edge of the shadow near this eye became brighter, suggesting that a ray reflected directly back on itself was of considerable intensity.

On subsequent nights we returned to the spot in the hope of again seeing the phenomenon, but, doubt-

less owing to a change in the weather conditions, we saw nothing. We took measurements, however, and from these data Figs. 3 and 4 were calculated.

The explanation of the phenomenon appears to be as follows:—In certain weather conditions globules of water are deposited from the fog upon the scum on the surface of the water, and the bows are formed in a way similar to those cast by the sun upon a bedewed field—with this difference: that here the source of light is near the observer. The bows, indeed, are rainbows.

In order that a drop of water shall be so placed as

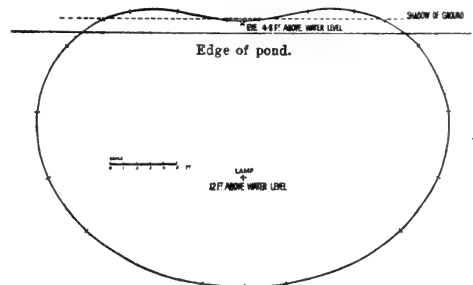

FIG. 3.—Primary bow, position I., as calculated.

to return to the eye a maximum amount of light in the manner that obtains in the rainbow, it is necessary that the line joining the source to the eye shall subtend an angle  $\alpha$  at the drop, where  $\alpha$  is the angle of minimum deviation. The locus of such suitable positions for the drop is the surface of revolution of a circle, of which the line joining the source to the eye is a chord, about this chord (see Fig. 2). The locus, then, is a toroidal figure like a flattened apple. The locus for the secondary bow is such a toroidal

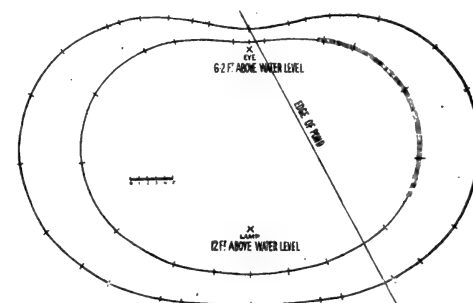

FIG. 4.—Primary and secondary bows, position II., as calculated.

figure within that for the primary bow. When the source of light is at infinity, as in the case of the sun, these figures become resolved into two co-axial conical surfaces having the eye at their common apex. In the present case the drops were confined to the plane surface of the water, and the bows seen were plane sections of these figures.

In order to test the soundness of this explanation, the writer has calculated the form of the bows from the equation of the section of the toroidal figure made by the water-surface, using as data the measurements taken of the positions I., II., and III., and giving  $\alpha$  the values  $42^\circ$  and  $53^\circ$  for the primary and secondary

bows respectively. The results for I. and II. are shown in Figs. 3 and 4. It is unquestionable that these curves faithfully represent the phenomenon as we observed it, the portions shown with thicker lines being those within the limits of the water, which alone we were able to see. The calculated curve for III. (not shown) is equally corroborative. The aureole seen round the shadow of the observer's head is consistent with the attribution of the phenomenon to water globules upon a surface (see J. M. Pernter, "Meteorologische Optik," 1910, p. 424).

It is of interest to note that the closed curve is a rainbow inside out, and with the secondary bow within the primary.

Since writing the above we once again found the bows visible, and a careful examination of them seemed to confirm the conclusions arrived at on every point. On this occasion the film was broken by spaces of clear water, and at these spaces the bows were interrupted. The space within the inner bow was filled with faint, diffuse luminosity, and a marked feature was the blackness of the zone between the inner and outer bows. C. O. BARTUM.

32 Willoughby Road, Hampstead.

#### "All-or-None" in the Auditory Nerve.

PROF. D. C. MILLER ("The Science of Musical Sounds," 1916, p. 184) admits the reality of beat-tones, but says that they are purely subjective, having no physical existence. This seems unsatisfactory. To begin with *beats*, it is wrong to say that it is the places of maximum intensity which are properly called *beats*. This is an illusion, due to too familiar diagrams. The maximum of intensity occurs at no place, but at a point of time which, at its own instant, the maximum not being absolute, is not impressive. At any point of time the next vibration of a sound may be of greater amplitude or it may not, and the listening ear, being unable to foretell, cannot tell us in the present when the maximum is attained. The perception of a maximum is bound to arrive, in fact, the day after the fair, when the sound is on the wane. On the contrary, it is the minimum of intensity which gives the effect of the beat. This is clear if the two primary tones are of equal amplitude and there is a phase of silence, when the difference of sensation is a difference, not of *degree*, but of *kind*. It has been shown that if a musical note is suddenly reduced to silence, the interruption of the series of vibrations restores the last of the series of periodic impulses to its isolated value; the note ends with a kind of shock or tap, comparable to one of a series of hard beats. If periodic beats are rapid enough, the final impulses at the interruptions form a fresh series, and are free to evoke in the sensorium a sensation of tone of the same frequency as the beats, a beat-tone; and this is best observed when the beats are not too violent.

Beat-tones are, therefore, no more subjective and have no less physical existence—although they may have been invisible hitherto in tracings and photographs—than any other real tone; and since both beat-tones,  $p-q$  and  $2q-p$ , are best heard, at least with intervals less than an octave, when the primaries are not powerful, there never has been a good reason for rejecting Young's view of their origin, nor for ascribing to Koenig the discovery of those "upper" beat-tones which were discussed by Young before the Royal Society in 1800. (In Faraday's copy of the 1807 quarto there is a book-mark at p. 544 of vol. ii., perhaps indicating that the chapter on the coalescence of musical sounds has more than an historical interest.)

But beats are produced by primaries of unequal

amplitude, and in such cases there is no phase of silence, and apparently no absolute minimum of intensity. Here we have something comparable to the first  $d$  in "would do" rather than the first  $t$  in "not too," to a *voiced* rather than a *voiceless* occlusive. If in the physiology of hearing we assume similarity of character in the nervous impulse to that which is established for motor nerves, the contribution of a single nerve-fibre, not being greater than the faintest sound audible in a sound-proof room, is in ordinary circumstances imperceptible; in the fluctuating intensity of a beating note many fibres will be implicated at the maximum; at the minimum, relatively few. At a minimum of intensity which is not absolute some fibres will continue to conduct the series of impulses of the note, while others will at this instant discontinue, and the impulse preceding the interruption may evoke the displeasing sensation of a noise, whereas with slow beats, where the discontinuity in many fibres is spread over a longer time, the effect is not so, but pleasant. Hence with two primaries of nearly the same frequency we may hear at the same time beats and the beating note. When the interval between the primaries is sufficient for the frequency of the beats to be that of a real tone, we may in the same manner hear at the same time the separate primaries and either the beats or the beat-tone, or both the beats and the beat-tone. Further application of this principle will be found to offer a solution of other obscure problems in hearing.

W. PERRETT.

University College, Gower Street, May 20.

#### British and Foreign Scientific Apparatus.

My attention has been directed to a letter appearing in the issue of NATURE for May 6 dealing with the subject of scientific apparatus. Your correspondents are extremely moderate in tone, but they do not state the class of apparatus to which they are referring.

Members of the association of which I have the honour to be chairman manufacture a large number of scientific apparatus, not only in glass and porcelain, but also other goods as well. Some of these were manufacturers in this country before the war, and proved by the quality of their products that they were able to stand against foreign competition; other members have entered the scientific trade only since the outbreak of the war, mainly at the request of the Government. The difficulties they have experienced have been extremely great, but they can prove that the quality of most glassware articles turned out is equal in many respects to that of articles previously imported from abroad.

Certain complaints have reached us; these have been most carefully investigated, and in many cases we found that the complaint dealt with glassware which was not manufactured by our members, but had been sold without any mark or badge of the manufacturer. Our members will be only too pleased to co-operate in every possible way with scientific workers, and look to them for the help necessary in establishing this "key" industry and placing it on a thoroughly sound basis.

As regards State aid, we do not want this in the form suggested, but rather we desire the creation of some method by means of prohibition whereby the industry will be enabled to establish itself, and at the same time the customer will not be penalised by being unable to get his material or the quantity of apparatus he desires. Under the form of prohibition which has been suggested, all orders for apparatus from abroad would have to come before a Special Committee of the Board of Trade. This Committee would

issue licences for all articles which were not made in this country either in sufficient quantity or of approved quality. At the present moment the rate of exchange is such that British manufacturers cannot compete even under the most up-to-date methods of manufacture, and it must always be borne in mind that this is a new industry which has not had time to establish itself or to get over the experimental stages of glass as an industry.

DOUGLAS H. BAIRD,  
Chairman.

The British Chemical Ware Manufacturers'  
Association, Ltd., 51 Lincoln's Inn Fields,  
London, W.C.2, May 18.

#### Mortlakes as a Cause of River-windings.

MR. T. S. ELLIS asks us in NATURE of April 29, p. 204, to believe that the curves of a meandering river, instead of being wholly secondary features, are to a large extent primary, arising from the simplification of a "complicated network of channels." He admits, however, that such a network does not occur in existing rivers, and it will require more than deductive reasoning as to what should happen on a newly exposed land surface to prove that it belongs to any stage of their evolution.

On our sandy and muddy shores we have abundant opportunities for studying inductively the genesis of new stream-systems; and the general resemblance between these transient formations and the river-systems which we regard as youthful lends strong support to existing theory. In these primitive streamlets islands are not uncommon, but they are almost always of narrow lenticular form, with the lens-angles pointing up- and down-stream, and the lateral curves moderate. Save, perhaps, in a few exceptional cases, nothing approaching the sweeping curves of a meandering river is ever seen, and a whole volume of inductive reasoning goes to show that such curves belong to the stages of maturity and old age. How far the "primary consequent streams" approach and how far they deviate from straight lines depends largely upon the angle of slope: and this again, on our shores, is often conditioned, quite apart from the coarseness of material, by the rapidity of the tidal movements; for example, the drainage of the mud-flats of Poole Harbour is quite distinct from that of the mud-banks of the Wye near Chepstow; but there is surely sufficient ground for believing that regional uplift has sometimes been comparatively rapid, and in such circumstances straight consequent streams would be the rule.

Even in Mr. Ellis's special case of Mortlake his conclusions are by no means free from objection. In the first place, admitting the former existence of an island, Mortlake would lie at the head of it, and therefore quite outside the area of the "mort-lake" (as defined by Mr. Ellis) now represented by the Beverley Brook. Secondly, it is surely unreasonable to attempt to evolve primary laws from such obviously secondary conditions as we find on the flood-plain of the Thames.

Lastly, I should like to point out that, even when islands occur, their secondary nature is frequently obvious, and that there are many cases in which one of their limiting channels is due, not to the main river, but to a tributary captured by it. Jumièges, on the Seine, affords a fine example of such capture, but the island has become an isthmus. Between Datchet and Old Windsor the island and backwater ("mort-lake") are retained. I am not in a position to say whether the Beverley Brook has been similarly captured and then set free again, but such a double change is not impossible.

HENRY BURY.

Mayfield House, Farnham, Surrey, May 1.

NO. 2639, VOL. 105]

#### Science and the New Army.

THE two letters on this subject in NATURE of April 22 raise some points of considerable interest.

It seems clear that any attempt to train the main body of Army officers thoroughly in science and in scientific methods will be fruitless under present conditions, while it is even more certain that any attempt to train General Staff officers as scientific experts is extremely undesirable. It is, in fact, the duty of the General Staff to rely on its technical corps for advice, and it is unsound in principle and in practice for the General Staff to include within itself a separate body of experts.

On the other hand, the General Staff should possess a wholesome regard for the results which can be achieved by scientific methods, and this regard is all that is necessary to the General Staff, though the technical corps should be strengthened by the addition of scientific experts.

There appear to be three totally different Army requirements, namely:—

1. An organisation permitting the utilisation, so far as possible, of the services of scientific and technical men in time of war: (a) in the Army, through the Territorial Force and Officers Training Corps; and (b) outside the Army, as advisers in a civilian capacity.

2. An organisation which in peace time will keep the technical corps in close touch with the progress of science. This organisation would preferably be associated with the Research Department or Departments of the War Office.

3. Training of the general body of Army officers and the General Staff in scientific methods.

No attempt should be made to convert General Staff officers into scientific experts, for the reasons given above; in the nature of things, the General Staff officer *must not* be a specialist.

There seems to be every desire on the part of men of science to assist the War Office to the best of their ability; it rests with the War Office to prove that it has a sincere desire to avail itself of the opportunities offered.

C. S. WRIGHT.

1 Royston Road, Richmond, Surrey, May 5.

#### Waage's Phytochemical Synthesis of Phloroglucin from Glucose.

It is generally stated that phloroglucin is formed by floating leaves in sugar solutions when exposed to sunlight. This phytochemical conversion of an aliphatic chain into an aromatic ring-compound is based on observations published by Waage in 1890 (*Bericht der deutschen botanischen Gesellschaft*, vol. viii., p. 250), which have found their way into nearly every text-book on the subject (compare, for example, M. Wheldale Onslow, "Practical Plant Biochemistry," p. 7, which has just been published). The fascination of this simple experiment and its general importance to plant chemistry have made me repeat it every summer for the last fifteen years, but not in a single case, out of nearly eighty experiments, did I succeed in detecting even the slightest trace of phloroglucin. For the detection of phloroglucin I used the pine-wood test, as recommended by Waage, and also the bromine-water test after extraction with ether.

It seems to me, therefore, desirable that this very important experiment of Waage's should also be re-investigated by others interested in this question with the view of either definitely confirming or contradicting it.

M. NIERENSTEIN.

University of Bristol, May 8.

### The Development of British East Africa.<sup>1</sup>

IT may be claimed for Lord Cranworth's volume that in a large measure it fulfils the author's main object of placing before intending settlers in British East Africa information and points of view which should be helpful to them. To this end the chapters dealing with agricultural and industrial prospects, primarily in the highlands of the Protectorate, furnish detailed information such as the most suitable areas as to soil and climate; the cost of land, labour, equipment, etc.; the requisite capital for various enterprises; and the return which may be anticipated.

There is one serious omission, however, in

of the book is enhanced by Lady Cranworth's contribution of a chapter giving not only hints on equipment for women, but also a description of the life in the highlands of East Africa, with its varied interests for women, and advice as to the suitability of the climatic and other conditions to women and children. The author himself devotes a chapter to the educational facilities at Nairobi and other centres, which should be helpful to intending settlers who are married.

A short history of East Africa, together with some notes on the native races and the effects of immigration from India, Arabia, and Somaliland,

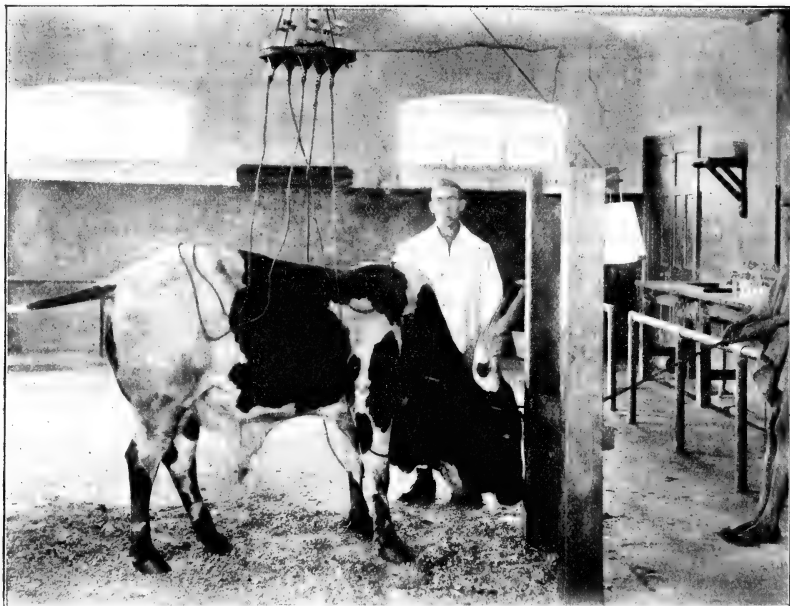

An ox being hyperimmunised to rinderpest. From "Profit and Sport in British East Africa."

that no reference is made to the financial difficulty resulting from the enhanced exchange value of the rupee. This serious handicap to new settlers had not arisen when the author wrote "A Colony in the Making," from which he produced the book now under review as a revised edition; but, since the later volume was not published until 1919, it is surprising that the currency question was not dealt with as a new chapter, or at any rate referred to in the author's preface.

Lord Cranworth points out that the book is not an erudite work, but gives a few plain facts and suggestions for the guidance of those without experience of British East Africa. The usefulness

forms an interesting basis to the general description of subsequent developments and future prospects.

Several chapters deal with big game and with sport and games of many kinds; those on big game furnish information as to the localities where various species are to be found, and how their presence affects the settler, while a chapter is devoted to beasts which the author would place in a black list as having many undesirable proclivities and nothing which may serve to counterbalance their disadvantages. Reproductions of Mr. J. G. Millais's "Buffalo" and his picture of animal life on the Loietta Plains are included in the illustrations.

To those interested in stock-raising an appendix giving notes on remedial measures against stock

<sup>1</sup>"Profit and Sport in British East Africa." Being a Second Edition, Revised and Enlarged, of "A Colony in the Making." By Capt. The Lord Cranworth. Pp. xvi+503. (London: Macmillan and Co., Ltd., 1919.) Price 21s. net.

diseases, compiled by the Chief Veterinary Officer of the Protectorate, should be read in conjunction with the author's chapter on cattle. With reference to measures adopted to combat the spread of rinderpest, there is an interesting illustration showing the method of hyperimmunising cattle.

The book concludes with a chapter detailing the assistance furnished by British East Africa and the sacrifices made by both Europeans and natives in furtherance of the military operations

which resulted ultimately in the conquest of what is now known as Tanganyika Territory.

Those who, like Lord Cranworth, have the interests of British East Africa at heart will welcome this volume, with its purpose of bringing to the Protectorate an influx of recruits of the right standard requisite to further the development of its resources, particularly in view of the existing demand for the raw materials required in the reconstruction of the Empire's industries.

### Weather Notes of Evelyn, Pepys, and Swift in Relation to British Climate.

By CAPT. C. J. P. CAVE.

THE interest in weather notes from old diaries lies in the fact that they may throw some light on the vexed question whether meteorological conditions in Western Europe are changing. The diaries of Evelyn and Pepys have been quoted by both believers and unbelievers in changing conditions, and it must regretfully be admitted that the question is, as yet, by no means easy to answer. Evelyn's diary extends from 1620 to 1706, but during this long period there are, on the average, only about eight weather notes to every three years. As a rule, we find only very outstanding phenomena recorded, such as serious droughts, great storms, or hard frosts. Evelyn's diary has, however, never been published in full, and it is quite possible that the complete diary may contain a great deal more information on the subject. Pepys's diary extends only from 1660 to 1669, and is, therefore, too short to enable us to draw any safe conclusions. His weather notes are, however, far more numerous than Evelyn's, there being remarks bearing on the weather on an average of sixty-two days a year. Like Evelyn, he mentions outstanding features, but he also frequently mentions the weather as it affected his movements or his health, so that we get a much better record for the few years during which Pepys kept a diary than we do for the longer period from Evelyn. Neither writer is by any means infallible in his recollection of past weather, and both can be confuted from their own writings regarding events that they describe as unprecedented in their memories.

The most significant facts from which to gauge weather conditions, in times before instrumental readings, are hot summers, droughts, wet spells, and cold winters. So far as hot summers are concerned, we have little to go on. Both writers complain of the heat at times, but the only really exceptionally hot summer seems to have been that of 1698, mentioned by Evelyn. Nor do we get very much ground to go on in droughts and wet spells. We are, therefore, restricted to cold winters, and especially to the freezing of the Thames, for evidence of any change in climate between the seventeenth century and the present time. The evidence was discussed by several writers in *Symons's Meteorological Magazine* in 1911 and 1912, and different writers came to

diametrically opposite conclusions. Mr. Walter Sedgwick maintained that the intensity of falls of snow was likely to be exaggerated by the seventeenth-century diarists, for when roads were normally bad, traffic would have been far more seriously affected by snow than it is to-day. Mr. W. H. Dines, on the other hand, contended that when roads were always bad during the winter, "it was a matter of indifference whether roads were blocked by snowdrifts." It is also said that the number of references to snow in Evelyn's diary are very few, but it is quite certain that we do not find references to snow on nearly all the occasions when it occurred. In December, 1648, Evelyn says: "This was a most exceeding wet year—neither frost nor snow all the winter for more than six days in all"; but none of these six days are otherwise mentioned in the published diary. The winter of 1657-58 was extremely cold, and it is almost certain that there must have been snow; but none is specifically mentioned.

It is certain that the Thames in London froze more often in the seventeenth than in the nineteenth century, but some hold that this was due to the fact that the river was not embanked, and that Old London Bridge offered such an obstruction that the water above the bridge froze more easily than it does to-day. The Thames in London is recorded to have been frozen, or nearly frozen, on seven occasions during the period over which Evelyn kept his diary, and it is almost certain that it must have been frozen also in 1658. It is noticeable that the freezing in November, 1662, is mentioned by Evelyn, but not by Pepys, while the freezings of December, 1665, and January, 1667, are mentioned by Pepys, but not in the published diary of Evelyn. It seems as though the freezing of the Thames was not looked on as such a very out-of-the-way event, while slight frosts or small falls of snow might pass unnoticed. There were, of course, winters when there was little or no frost or snow, but they were looked on as very exceptional, and caused much apprehension as likely to "threaten a plague," and fasts were ordered by Parliament to pray for "more seasonable weather."

From the evidence in Pepys's diary the present writer thought at first that "there seems no reason to suppose that the weather" in the seventeenth

century "differed much from that to-day,"<sup>1</sup> but a further consideration of Pepys's notes, taken in conjunction with those of Evelyn, has led him to modify his views, and he now thinks that, on the whole, there is a good case for supposing that the winters in the seventeenth century were more severe than they are to-day. Sir John Moore, it is true, maintained in a paper, "Is our Climate Changing?" read before the British Association (Section A) in 1908, that the British climate is not changing; his evidence is based mainly on observations during the nineteenth century, with some from the eighteenth; but the constancy of the climate during the nineteenth century does not seem to preclude a change having occurred since the seventeenth, nor does it follow that a change should be progressive.

There must, however, be a good deal more evidence in scattered letters or diaries that will in time throw more light on this important point. In Swift's "Journal to Stella," which extends only from 1710 to 1713, there are weather references on seventy-eight days a year. The period is short, but I think it bears out the contention that winters with little frost or snow were exceptional. On December 27, 1710, Swift writes: "Did you ever see so open a winter in England? We have not had two frosty days." This was probably a

<sup>1</sup> Qua. t. Journ. Roy. Met. Soc., vol. xlvii., p. 68.

*façon de parler*, for at least two frosts are mentioned previously, and one fall of snow. By a frosty day it must be supposed that the diarists meant more than a slight morning frost of one or two degrees in the screen. If this is so, the warmth of the early winter in 1710 was not very exceptional, judged by present-day standards. December 27, it must be remembered, corresponds to January 8 new style, but in the last fifteen years during which the writer has kept climatological records there have been four, if not five, winters when there has been no frost worth speaking about until after the middle of January, in Hampshire at any rate, and these were probably as "open" as the winter of 1710.

Swift, on the whole, takes rather more interest in the weather for its own sake than does Pepys. He compares notes with "Stella" on the difference between the weather in Ireland and in London, but, of course, most of the references concern the weather as it affected him personally. There are many complaints of cold, wet, and heat, and Swift seems to have had a constitution that was much affected by hot weather. It is curious to find that bad weather is frequently made an excuse for dining with Mrs. Vanhomrigh at the time when Swift was beginning that acquaintance with her daughter "Vanessa" which was fraught with so much tragedy.

### Optical Instruments in Industry.

OPTICAL instruments, which proved their worth in war, are now being more and more utilised in developing the arts of peace. A short account of some of the chief applications of these instruments to industrial requirements, especially the more recent uses, may therefore be not without interest at the present time.

Passing over the microscope with a brief reminder of its modern use, in metallurgy, for showing the structure of iron and other metals, one of the first instruments to note is the refractometer. In many chemical works this, in one form or another, is invaluable as a means of controlling the various operations, by reason of the simplicity of its manipulation and the rapidity with which the results are obtained. The refractive index suffices in numerous instances to determine the strength of chemical solutions. It is ascertained in a few minutes, and only a drop or two of liquid is required for the purpose if an instrument of the Abbe type is employed. No weighings are involved, and no calculations if the temperature is suitably controlled, so that liability to error is greatly minimised. The instrument is thus almost an ideal one for the control of works operations where the degree of strength or purity of a product is required to be ascertained by means of rapid tests, or where a process has to be stopped when the product has reached a certain stage. Specific gravity determinations or simple chemical titrations are often used in such cases,

but the refraction method is always quicker, is generally more accurate, and sometimes possesses other marked advantages. Thus the strength of an aqueous solution of nicotine can readily be obtained, correct within about 0.1 per cent., by the refractometer, whereas the specific gravity method is of no value in this instance, and titration results are vitiated if other basic substances, such as ammonia, are present.

Acetic acid, acetone, ammonia, ammonium sulphate, carbolic acid, cream of tartar, glycerin, and saltpetre may be mentioned as products, made on a large scale, for which the instrument is useful. In the brewing industry the determination of alcohol, extract, and original gravity of beer is readily made by means of the refractometer. In the fats and oils industries, in the fractionation of petroleum products, in the distillation of tar oils, and in the manufacture of many pharmaceutical articles, the refractive index is a valuable aid for controlling the purity of the materials and finished products. It is useful also in the manufacture of various viscous mixtures or semi-solid pastes, in order to determine whether the constituents have been adequately mixed, and thus to obviate local excess or deficiency of the active ingredients.

The polarimeter is an instrument constantly in use for the evaluation of essential oils, whilst makers of starch products, tartaric acid, and alkaloids frequently have recourse to it, and a

specialised form of the appliance, the saccharimeter, is practically indispensable in the sugar factory.

Mention must also be made of the simple polariscope in its application to the glass industry, where it is employed for detecting strains in glassware due to faulty annealing. Not infrequently glass articles, imperfectly annealed, are destroyed on the cutting-wheel after a good deal of time

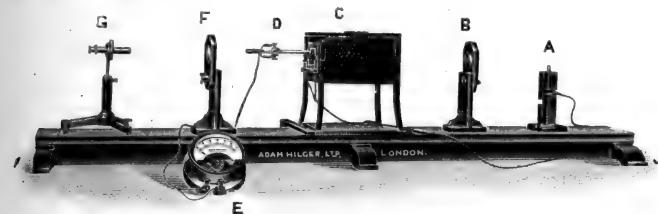

FIG. 1.—Twyman's apparatus for the determination of annealing temperatures. A, B, F, G, optical system; C, electrical furnace; D, pyrometer; E, temperature recorder.

has been spent on their partial decoration. Use of the polariscope to detect strains is not new; makers of optical glass have, naturally, long availed themselves of it; but as regards ordinary glassware the method has been brought more prominently under notice as a result of war conditions, and the "strain viewer" is now becoming more generally known in glass works. The principle involved is merely that of the well-known transmission of polarised light through crossed Nicol prisms when crystalline or semi-crystalline material is placed between them. Well-annealed glass leaves the field of the instrument practically uniformly dark; strained glass produces patches or bands of light, the intensity and colour of which give some idea of the amount of strain.

In this connection it may also be mentioned that certain other faults in glass can readily be detected by means of X-rays. This discovery has proved very useful in making the best qualities of optical glass, by preventing the use of material in which "air-bubbles" had formed.

Twyman's apparatus may also be noted here. It is used for determining the annealing temperature of glass (Fig. 1). The method evolved for this purpose is applicable also to metal objects, so far, at least, as the removal of stress is concerned. Trouble during the machining of metals such as manganese-bronze, owing to distortion through

stress, might often be obviated by proper annealing of the articles.

Among recent developments, perhaps the most notable is the fact that the spectroscope, in one adaptation or another, is beginning to take a definite place as an adjunct to industry. This follows upon the progress which has been made in fitting the instrument to quantitative work. In fact, it is the spectrometer, rather than the spectroscope proper, which is proving its value to the manufacturer. Hartley's work on quantitative spectrum analysis, dating from the eighties of last century, may be regarded as the pioneer investigation. He showed that the ratios of the intensities of lines in the spectrum of an element do not remain constant whilst the quantity of that element is decreased, and he introduced the term "persistence" to indicate

whether a particular line appears at a definite concentration of the substance emitting it—e.g. 1 per cent., 0.1 per cent., and so on, of the total material under examination. This work of Hartley's was followed by that of Pollock and Leonard in Dublin, and of Gramont in France—to mention only three names out of many. Meanwhile, the earlier terms of spectroscope have given rise to the more perfect "constant deviation" wave-length spectrometer

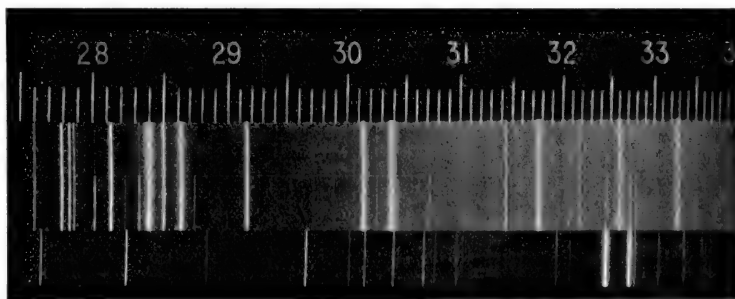

FIG. 2.—Print from negative taken on spectrograph with wave-length scale. Top strip, sample of reputed "pure tin." Middle strip, sample of commercial tin. Bottom strip, short exposure of copper spectrum. The presence of copper in the commercial tin is shown by the presence in the corresponding spectrum strip of the two copper lines at 3247 and 3274. A trace of copper is present in the "pure" tin.

and the quartz spectrograph, with the result that it is now practicable even to carry out quantitative analyses of metals by means of their spark spectra (Fig. 2).

Gramont uses two types of sparking apparatus (see *Comptes rendus*, 1918, clxvi., 95). In one of these the substance under examination is contained in a crater formed in one pole of the apparatus; in the second type the substance is fused in a platinum vessel, a spark being passed from a thin rod into the fused material.

This method has been used by M. Nicolardot in the chemical laboratory of the Technical Section, French Artillery, and according to Gramont it gives very satisfactory results in the control of chemical analyses. The spectrograph has also

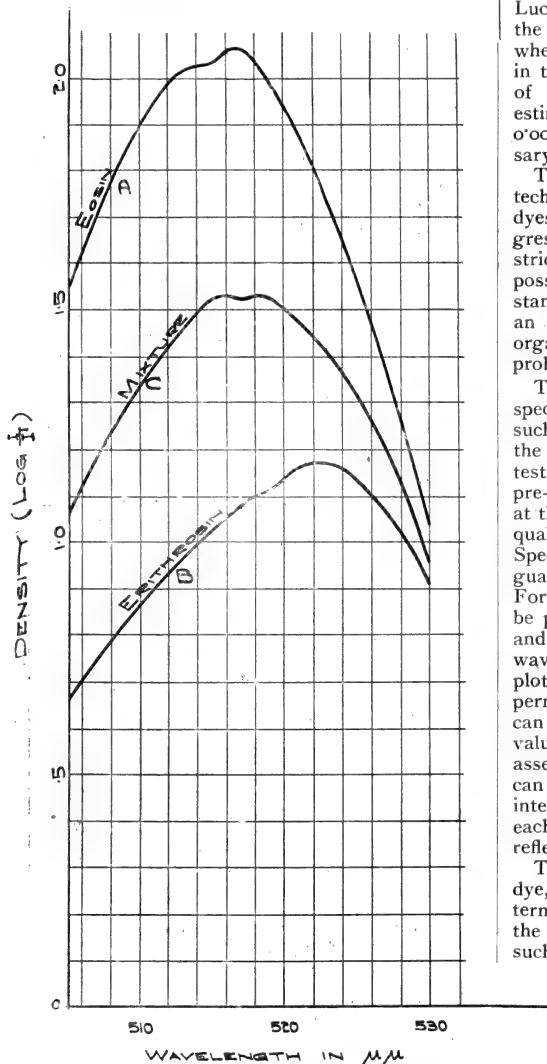

FIG. 3.—Curves plotted from results obtained in examining dyes with the spectrophotometer.

been for some time in use at the Bureau of Standards, Washington, for determining small quantities of impurities in tin and in the analysis of steel, especially as regards chromium and titanium. For estimating small quantities of elements such as niobium and molybdenum, the

spectrographic method is, indeed, stated to be more trustworthy than chemical analysis.

Another analytical method for metals has been described, depending upon a difference in volatility of the elements present. The authors (Hill and Luckey) use the "arc" discharge, and measure the time required for a given line to disappear when a known weight of the material is burned in the crater of the arc. Though this process is of limited application, it can be used for the estimation of lead in copper, within a range of 0.004 to 0.216 per cent., with the accuracy necessary for the work of a copper refinery.

The spectrophotometer, too, is now finding technical application, especially in connection with dyes. As the study of absorption-spectra has progressed, means for making the observations more strictly quantitative have developed also. The possibility of measuring the absorption of a substance for light of each wave-length is, in fact, an important addition to the resources of the organic chemist in dealing with certain technical problems.

The apparatus employed is a spectrograph or spectrometer combined with a suitable photometer such as the "Nutting" instrument. It is used in the control and analysis of dyes, the chemical testing of which is often a difficult matter. In pre-war days purchasers of dyes were very much at the mercy of foreign dye-makers as regards the quality and strength of dyes sent to them. Spectrophotometry can now be employed to safeguard the interests of the user in this respect. For example, a solution of known strength can be prepared from a trustworthy specimen of dye, and its colour-density determined for a series of wave-lengths by the spectrophotometer; a curve plotted from the results can then be kept as a permanent reference with which future supplies can be compared. Similarly the colour-producing value of a dye with various illuminants may be assessed by means of the instrument. Dyeing tests can be quantitatively controlled by comparing the intensity of reflected light from the dyestuff in each part of the spectrum with that of light reflected from a white surface.

The proportion of diluent substance added to a dye, or of two dyes in a mixture, may also be determined by reference to standard curves. Thus in the subjoined diagram (Fig. 3), A and B denote such curves for known strengths of eosin and erythrosin respectively, and C is a curve given by a mixture of the two substances, in unknown proportions. By taking ordinates for two suitable wave-lengths, two equations can be formulated, from which the proportions of the two dyestuffs in the mixture are calculated. From these examples the value, actual and potential, of the instrument to the dyeing industry will readily be understood.

Of other technical uses to which special instruments are applied, a brief mention must suffice. Thus in the iron and steel industry certain rapid



sorting-out tests can be made with the grating spectrometer and with the quartz spectrograph, whilst the projection comparator is a valuable aid, in engineering, for the ready optical gauging of interchangeable parts, such as screw-threads.

An important development, too, is the use of radiography in the examination of metals; but this need not be dealt with here, as it was referred to in an article on "Industrial and Medical Radiology" in NATURE of February 26.

### The British Sea Fisheries.<sup>1</sup>

THE latest book on the sea fisheries comes most opportunely at a time when everyone interested in these matters is looking for a policy. For the last two years a multitude of committees and conferences have been considering a situation

of fish might be utilised, cost of new construction, labour troubles, etc.—these are the matters that immediately and personally concern those engaged in the industry. The conditions are very different from those that obtained half a dozen years ago.



The herring fleet in Fraserburgh Harbour. From "The Sea Fisheries."

that has become acute as the result of war conditions, but which was rapidly developing even in 1913. There was then a great recrudescence of interest in the longshore and inshore fishermen; there were the perennial questions of the impoverishment of the fishing-grounds and of how this might be averted; and there were indications, even then, of troublesome problems relating to the distribution and marketing of the fish caught.

There is no doubt at all that it is these latter difficulties that have been accentuated by the circumstances of the last two years. Such things as landing facilities, railroad and motor transport, market accommodation, cold storage and curing in order that gluts

Then there was practically no control; but one Government Department now has to do with railway facilities; another fixes wholesale and retail prices; while others again have to do with regulations of many kinds. The result is, for the present at all events, a confusion which is apparent to almost everyone.

Under our economic conditions the profit-factor in industry is still the dominant one. The bulk of the fish landed are caught in order that they may be sold so as to yield a "return" on the capital invested; otherwise no fish would be landed except the small fraction taken by individually owned boats and longshoremen who work for a living and sell their fish for whatever it will bring. How is the deep-sea fishing industry to be carried on so as to yield a sufficient profit?

<sup>1</sup> "The Sea Fisheries." By Dr. J. T. Jenkins. Pp. xxxi+299. (London: Constable and Co., Ltd., 1920.) Price 24s. net.

Long ago we should have left that question to the trade itself, but it is now clear that a policy of *laissez-faire* is no longer possible. The people must have food. The State has already taken partial control, and the logical development of such conditions seems to be the public organisation of the means of distribution and, if so, the control of profits as well as of prices.

Dr. Jenkins does not deal with these latter-day economic questions. The conditions are transient, and it is quite impossible for any man to get trustworthy information tending to elucidate them. Probably no administrator or office is big enough to deal adequately with the difficulties of the moment, and the situation must be left to resolve itself in the near future. On the other hand, it would be hopeless to attempt to study it without reference to the other fundamental questions which we have indicated. Is there really an impoverishment of the fishing-grounds, and, if so, what restrictions are necessary that this may be avoided? Regulation being necessary, what is the best form of administration? What is industrial efficiency as applied to the fisheries? Judged by the ratio of fish caught to the man-power employed, the inshore and long-shore fishermen are inefficient, and their methods wasteful. But, that being so, is it in the national interest that a prolific, hardy, and versatile stock should be allowed to decline? What, above all, are the nature and value of the information which we use in order to decide upon these matters?

Even in present circumstances, then, there are fundamental problems that must be considered before we tackle those of the moment, and it is these with which the author deals. He gives a summary of the methods of sea-fishing employed in Great Britain, and an historical sketch of the development of the trawl- and herring-fisheries. This is based on prolonged literary research and is very well done. There are a summary of the legislation applicable to the industry, a short account of the British and foreign administrations, and a *résumé* of the chief results of the fishery commissions of the strictly modern period. A well-selected bibliography should enable the reader to follow the various discussions in greater detail than that which falls within the scope of the book. It is very proper that considerable weight should be given to the scientific side of the subject, and in his introduction the author deals most conveniently with the situation of the industry at the close of the war period, especially with regard to the reconstruction of the national administrations and the development of an adequate machinery for scientific and economic investigation. Altogether, the work is one that must be considered quite essential to anyone who seeks to discover, beneath the confusion of the moment, the natural conditions upon which the continued development of the national sea fisheries, as a whole, must necessarily depend.

J. J.

### Notes.

THE annual meeting of the British Science Guild will be held at the Goldsmiths' Hall on Tuesday, June 8, at 3 p.m. Lord Sydenham, president of the Guild, will deliver an address on "Science and the Nation," and the president-elect, Lord Montagu of Beaulieu, will speak on "Some National Aspects of Transport." The adoption of the report on the Guild's work since the last annual meeting will be moved by Lord Bledisloe, and seconded by Sir Gilbert Parker. The Guild is extending its activities in several directions, and all who believe in the application of scientific knowledge and method to national affairs of every kind should give it support. Tickets of admission to the annual meeting may be obtained upon application to the Secretary, British Science Guild, 6 John Street, Adelphi, London, W.C.2.

At the Imperial Entomological Conference to be held in London on June 1-11, the subjects to be discussed, although mainly relating to agriculture, are not the less on that account of great general interest, and ought to make a wide appeal. Mr. H. A. Ballou, just returned from an investigation of them in Egypt, will read a paper on "Cotton Pests," a subject which he has long studied in other parts of the Empire. Dr. R. S. MacDougall will read one on "Insects in Relation to Afforestation," which is a subject greatly needing attention in our own country at the present day. There will also be read important papers on the special insect pests of tea and other crops, as well as on the local insect pests of various places within the Empire; and amongst other subjects for discussion "The Education of Economic Entomologists" should prove attractive, the more so as Profs. Maxwell Lefroy and Sydney J. Hickson have promised to give their views upon it. The meetings are all to be held at the rooms of the Linnean Society, Burlington House, and visits have been arranged to Oxford, Cambridge, and the Rothamsted Experimental Station, Harpenden. "The Work and Finances of the Imperial Bureau of Entomology" will be considered at the business meeting on the first day, when, doubtless, there will be nothing but greatly deserved praise for the work, and very serious consideration in regard to the finances. It is to be hoped that as an outcome the Bureau will be enabled to carry on, unhampered and unimpaired, the extremely valuable work it has done during the seven years of its existence.

A PAN-PACIFIC Scientific Congress has been organised to meet at Honolulu on August 2-20. The programme of the congress is directed by the Committee on Pacific Exploration of the U.S. National Research Council, and the chairman is Mr. Herbert E. Gregory, director of the Bishop Museum at Honolulu. The papers to be read will deal with the present status of knowledge of anthropology, biology, geology, geography, and related sciences so far as they refer to the Pacific Ocean, and will place emphasis on the research work which it is desirable to inaugurate. The significance and bearing of the research work on other fields of study will be dealt with in considerable detail. It is suggested that in the working out of

the problems only the ability and interest of the scientific workers should be taken into account, nationality and institutional rivalry being submerged for this purpose. Co-operation would eliminate unnecessary duplication of money and energy, and point the way to the best use of funds now available and to the utilisation of further endowments. The director of the museum is also organising a party consisting of an ethnologist, archæologist, botanist, and necessary staff, which will be stationed in 1920-21 at the Marquesas, Austral, Tongan, and Hawaiian Islands to establish standards of the physical form, material culture, traditions, and languages of the Polynesians which may serve as a basis for the determination of the significance of changes produced by the overlapping of other races. A similar expedition is projected for 1921-22 westward to the Caroline Islands, to determine through what place or places the Polynesians reached their present settlements. Funds sufficient for one year's work, contributed by Bayard Dominic to Yale University, have been placed at the disposal of the museum trustees. The urgent need for a scientific study of the fast-changing Pacific is plain. It has been recognised in Australia, where a committee, appointed by the Universities of Melbourne and Sydney, has reported in favour of the establishment of fellowships in Pacific studies. If America studies eastern Polynesia, Australia still has Papua and the Western Islands.

THE preliminary programme of the annual meeting of the British Association for the Advancement of Science, to be held at Cardiff on August 24-28, has been issued from the offices at Burlington House. The previous meeting in that city was held in 1891, and there has been no meeting of the association in Wales since that date. The present president, Sir Charles Parsons, will hand over his office to Prof. W. A. Herdman, professor of natural history in the University of Liverpool, who will give in his presidential address a general survey of oceanography, and deal in detail with certain special problems and recent investigations, with particular reference to sea-fisheries, a topic not only of prime interest in connection with the food supply of the country, but also of special concern to the ports of the Bristol Channel. The programme announces a discourse at one of the general evening meetings by Sir Daniel Hall, of the Ministry of Agriculture, on "A Grain of Wheat from the Field to the Table," another pregnant subject at the present time. Sir Richard Glazebrook, lately Director of the National Physical Laboratory, will also deliver a discourse. A scientific exhibition in connection with the meeting is announced to be given in the museum exhibition room at the Cardiff City Hall, where the general reception room for the meeting will also be established. The sections will meet mostly in the University College and the Technical College, which, with the City Hall, belong to the fine range of public buildings which surround Cathays Park. Scientific excursions will be organised in connection with the work of several of the sections. A civic reception by the Lord Mayor is announced, as is also a garden party for members, given by Lord Treowen, president of the

National Museum of Wales (which has its headquarters at Cardiff). Among other fixtures is a special service in St. John's Church, Cardiff, on the Sunday after the meeting, at which Dr. Barnes, Canon, of Westminster, will preach.

PRINCE ALBERT will preside at the Royal Aeronautical Society's Wilbur Wright lecture, which will be delivered at the Central Hall, Westminster, on June 22, at 8.30 p.m., by Commander Hunsaker, upon the subject of "Naval Architecture in Aeronautics."

THE Academy of Natural Sciences of Philadelphia has conferred the Hayden memorial medal for 1920 on Prof. T. Chowder Chamberlin, professor emeritus of the University of Chicago, in recognition of his distinguished services to geological science. This medal is presented every three years for distinguished accomplishments in geology or palæontology.

THE twenty-fifth annual congress of the South-Eastern Union of Scientific Societies will be held at Eastbourne on June 2-5. On the evening of Wednesday, June 2, the president-elect, Sir Edward Brabrook, will deliver his presidential address. Other items in the programme are:—The Glaciation of the South Downs, E. A. Martin; First Steps in a Local Survey, C. C. Fagg; Recent Discoveries in Insect Mimicry, Prof. E. B. Poulton; Report of Mosquito Investigation Committee; and Migration of Lepidoptera, R. Adkin.

THE possibilities of cotton-growing in South America are discussed at length by Mr. G. McC. McBride in the *Geographical Review* for January (vol. ix., No. 1). Up to the present South America has produced annually scarcely 2 per cent. of the world's total output. Mr. McBride shows reasons for believing this could be greatly increased. The principal increase must come from the eastern highlands of Brazil. In the São Paulo region it is already competing with coffee, which suffers more than cotton from frosts. Labour and transport are the factors which limit its growth at present, but as these are gradually overcome Brazil will be able to export cotton on a considerable scale. Other possible cotton lands occur in the plains of northern Argentina and Paraguay, and in the coastal valleys of Peru.

TOWARDS the end of March last a meeting was held in Brussels of the scientific committee of the Solvay International Institute of Physics, and it was resolved, upon the recommendation of the executive committee, to resume the work of the institute, which had been interrupted by the war. New physical councils will be summoned from time to time, similar to those formed in 1911 and 1913. The president referred to the debt which the scientific committee owed to Dr. R. B. Goldschmidt, of Brussels, for the services rendered by him to the institute during the early years of its foundation. The members of the committee were Prof. H. A. Lorentz (president), Haarlem; Mme. Curie, Paris; Sir W. H. Bragg, London; M. Brillouin, Paris; Prof. H. Kamerlingh Onnes, Leyden; Prof. Knudsen, Copenhagen; Prof. A. Righi, Bologna; Sir Ernest Rutherford, Cambridge; and Prof. E. Van Aubel, Ghent.

MAJORS MCKENDRICK AND MORISON have investigated statistically the occurrence of cases of influenza on shipboard, from which they deduce a mean incubation period in this disease of 32.7 hours, some 90 per cent. of the cases having an incubation period within two days (*Indian Journal of Medical Research*, vol. vii., No. 2, p. 364).

In a general review of influenza in *Medical Science: Abstracts and Reviews* (vol. ii., No. 2) the influenza epidemic of 1918-19 in Switzerland is surveyed. It is estimated that there were 2½ million cases. The case mortality was 1.1 per cent.; 65 per cent. of the cases occurred between fifteen and forty-nine years of age, and only 5 per cent. in persons of fifty and more. The total deaths were 17,575, a much heavier death-roll than that caused by other epidemic diseases.

ATTENTION is directed in a paper by Mr. Mottram and Mr. Clarke (*Archives of Radiology and Electrotherapy*, No. 237, April, 1920) to the reduction in the number of the white blood corpuscles in those handling radium for curative purposes, a reduction amounting to  $\frac{1}{3}$ - $\frac{2}{3}$  of the normal number. They estimate that the physician-in-charge receives daily about 1.4 per cent. of the total radiation received by a patient during a course of treatment for cancer, and in ten weeks the same quantity of radiation as the patient.

THE Committee on Food and Nutrition of the National Research Council, Washington, U.S.A., has just issued a report on meat and milk in the food supply of the nation which gives some interesting facts on the relative values of these two important dietary substances in comparison with the value of the food required to produce them. The Committee supports the British estimates on the same subject, viz. that the good milch cow returns 20 per cent., the poor milch cow 12 per cent., and the good beef steer only 6 per cent. of the energy-value of the food consumed. Crops grown on a given area may be expected to yield four to five times as much protein and energy for human consumption when fed to dairy cows as when used for beef production.

AN address on the work of the Medical Research Committee was delivered by its secretary, Sir Walter Fletcher, to Members of Parliament at the House of Commons on March 9, and has been published in pamphlet form by the Research Defence Society. The history of the committee was first briefly sketched. Some 50,000l. a year has hitherto been devoted to the advancement of medical research, but the Treasury has announced that in the immediate future 125,000l. per annum is to be allocated for this purpose. Sir Walter Fletcher then described some of the researches that have been prosecuted by means of these funds. A disease, bilharziasis, due to a parasitic worm, is very prevalent in Egypt. Its life-history was unknown, and Dr. Leiper, of the London School of Tropical Medicine, was sent out to investigate. He found that the bilharzia worm passes part of its life-cycle in certain fresh-water snails, from which larval forms hatch out; and these constitute the infective agents. They soon die, how-

ever, unless they enter the human host, so that water kept for twenty-four hours is safe. This work cost less than 500l., but bids fair in time to eradicate bilharziasis. Trench nephritis, a kidney disease, was very prevalent during the war. Investigations into its causation indicated that it is probably of an infective nature. Means were devised by which the efficiency of the kidney could be gauged, and it was possible to decide which of the thousands of cases at the base hospitals were likely to grow worse and should be sent home, and which could probably soon go back to duty. The same tests have been employed since in judging claims for pensions based upon supposed damage to the kidneys. By this means it is estimated that the Pensions Ministry has saved, during the first year, no less than 150,000l.; yet the total cost of this piece of work was somewhere between 2000l. and 3000l. Sir Walter Fletcher put in a plea for the better remuneration of scientific research, and the address was followed by an interesting discussion.

In the *British Journal of Psychology* (vol. x., March) Mrs. S. Brierley discusses the present attitude of employees to industrial psychology. She finds, in talking to working-men, much opposition to the suggested introduction of psychological methods into industry—an opposition which cannot be dismissed as characteristic of the more ignorant and less skilled workman. Several reasons for this attitude of mind are considered, of which the most vital seems to be the not unreasonable fear that the introduction of these methods will inevitably lead to an increase of monotony and a diminution in the possibility for initiative or creative work on the part of the individual worker; some of these so-called scientific methods do seem to imply that the manager is to be the brains of the machine, and the worker merely the muscles. It is unfortunately only too true that some enthusiastic exponents of these methods have allowed their enthusiasm to limit their point of view to increased production, and in so doing they have lost sight of the effect on the individual worker. The problems of monotony, mechanisation, specialisation, and self-government must be considered not only as bearing on increased output, but also as affecting the whole development of the worker; work must offer an outlet for the healthy satisfaction of the creative impulse. The author raises many problems connected with present-day industry and shows what psychology as applied to industry has to face before it can win the whole-hearted support of the workers. The paper should prove interesting to all whose scientific work brings them into contact with individual workers in industry.

SINCE the early experiments of Cuénot, Castle, Miss Durham, Little, and others on the inheritance of coat-colour in mice, these animals have been a favourite subject for the study of spotting as well as of self-colour. In a recent paper by Sô and Imai (*Journal of Genetics*, vol. ix., No. 4) the authors distinguish two factors concerned in spotting, one of which (D) is epistatic to self-colour, which it modifies to the "Kasuri" pattern characterised by fine silvered

markings. When the recessive spotting allelomorph ( $S'$ ) of self-colour ( $S$ ) is present with the epistatic factor, a white animal with dark eyes known as "Daruma" (snowman) is produced. Mice which are homozygous for  $D$  fail to develop whether  $S$  or  $S'$  is present in addition.  $D$  is, therefore, a lethal factor, and can only appear in the heterozygous condition, as is well known to be the case with yellow mice. By this analysis it is shown that a varied and apparently continuous series of stages from dark-eyed white through spotting to self-colour depends upon two pairs of factors.

MR. T. W. VAUGHAN furnishes a comprehensive account of the American Tertiary, Pleistocene, and Recent coral-reefs in Bulletin 103 of the U.S. National Museum, pp. 189-524, 1919, as the fore-part of a paper describing fossil corals from the zone of the Panama Canal. No naturalist—and in this term we of course include the geologist who strives to understand the past—can afford to overlook this important summary of recent work. Some readers may be startled by the statement that "the theoretic possibility of the progressive change of a fringing reef into a barrier, and later into an atoll, according to the Darwin-Dana hypothesis, may not be denied, but no instance of such a transformation has as yet been discovered." But the author again and again emphasises the upward growth of coral-reefs in keeping pace with the submergence of the platforms on which they first arose. The discussion of these platforms and of their pre-Glacial age is full of interest; but Mr. Vaughan rightly points out that the question of their modes of origin does not affect the question of reef-growth. Murray's theory of solution to account for lagoon depths is regarded as "entirely disproved," and every credit is given to Dr. Guppy and Admiral Sir J. Wharton for their views on the relation of reefs to submarine platforms. The corals that result in barrier-reefs flourish, as Guppy urged, at some distance from a shore, because they are there removed from deleterious sediments; the reef thickens, as Wharton perceived, by submergence of its base. In the case of Australia, though not as a general proposition, Mr. Vaughan believes that this submergence can be accounted for by the rise of water during "deglaciation." The effects of drift-currents in developing and controlling the form of atolls on an open platform may be regarded as well established.

THE Italian State Department has now resumed publication of its Reports of the Aeronautics Experimental Institution (*Rendiconti dell' Istituto sperimentale aeronautico*). No. 1 of the new series just to hand contains an exhaustive article on the treatment and preservation of wood. The first part of this important monograph deals with the botanical aspect of the subject; the second part with the theory of timber preservation, including drying and seasoning; the third part with the practical side of timber seasoning and impregnation with preservatives; while part iv. is devoted to methods of testing (both physical and mechanical).

MEASURES are being taken to reorganise and extend various scientific services in French Indo-China.

M. Aug. Chevalier, writing in *La Géographie* for April (vol. xxxiii., No. 4), gives some account of the plans. The agricultural, forest, and survey departments had fallen into neglect when the present governor-general in 1917 took steps to revive them. Several experimental agricultural stations and agricultural schools have been founded, and this year work was begun on the building of a central scientific institute at Saigon, to which the agricultural service of Indo-China and the botanic gardens at Saigon are to be attached. The institute will conduct experiments in the growth of rubber, coffee, tea, and rice; study the flora and products generally of Indo-China; and conduct researches on plant diseases. It is also proposed to start a marine station. The Government has provided funds for a scientific library and the issue of a monthly agricultural bulletin.

No. 23 of the Proceedings of the Dutch Meteorological Institute is devoted to three papers by Miss A. van Vleuten on the possibility of accounting for the daily variations of the earth's magnetic field by a system of electric currents external to the earth and the currents within the earth's surface induced by them. In 1889 Schuster concluded that such was the case. Since that date both Fritsche and Steiner have examined the data available, and concluded that it did not support the hypothesis. In view of this difference of opinion Miss van Vleuten has again analysed the daily variation of the field, and resolved it into an external and an internal part. The two show that the principal terms of the Gauss expansion do not support the hypothesis, although the higher and less important terms are in agreement with it. In a further paper the author, by comparing the terms of the potential calculated, first, from the north component, and, secondly, from the east component of the field, shows that the daily variation of the field does not possess a potential, although it is, of course, always possible to deduce part of it from a potential.

THE physiological aspect of flying at high altitudes engages the attention of Dr. Guglielminetti in *Génie Civil* for March 20. The experiences of mountaineers, balloonists, and airmen who have flown to great heights are reviewed in turn. From tests carried out in the laboratory, and from the experience of Mosso and Agazotti (of Turin), Dr. Guglielminetti is inclined to the opinion that the physiological disturbances caused at altitudes below 8000 metres are due to anoxypnoea, and above 8000 metres to acapnia. While the use of respirators having suitable reducing-valves controlled automatically by the varying pressure at different altitudes would no doubt afford a fairly satisfactory solution, the better way lies in the design of suitable closed cabins in which the air-pressure is maintained constant by compressing the air taken in from outside. M. Louis Breguet has already suggested a design of aeroplane in which the pilot and passengers would be so enclosed. The excess of air necessary for the engine at high altitudes would probably be supplied by a turbine driven by the exhaust gases, such as has been suggested by Prof. Rateau.

THE report of the Council of the Illuminating Engineering Society, presented at the annual meeting on May 11, contains an interesting record of the past session's work. Papers and discussions dealing with photometry, camouflage, colour-matching, motor-car head-lights, and lighting conditions in mines have been arranged, the last in co-operation with the Council of British Ophthalmologists and the Royal Society of Medicine. The various committees working under the society, notably that conducting an inquiry into eyestrain in kinemas, afford evidence of similar co-operative effort. Special attention has been devoted to industrial lighting in relation to health and safety, and it is hoped that before long general statutory provision for adequate lighting will be introduced into the Factory Acts. The society hopes now to be able to resume its participation in the international treatment of illumination, and is represented in the person of its hon. secretary at the congress of the Royal Institute of Public Health taking place this month in Brussels. Following the presentation of the annual report, a paper on portable kinema outfits was read by Capt. J. W. Barber, several novel forms of apparatus being shown.

THE work of Willstätter and his collaborators has imparted considerable interest to that branch of biochemistry which includes the formation of anthocyanins in plants. A suggestive paper on the subject is contributed to the April issue of the *Biochemical Journal* by O. Rosenheim. This author has isolated in a crystalline form the red pigment of the young leaves of the grape-vine, and has shown that it is most probably identical with oenidin, the non-sugar component of the pigment of the purple grape. This is the first instance on record in which the red pigment of leaves consists of free anthocyanidin. The vine-leaves have been shown to contain also a colourless modification of the pigment, possibly in combination with a carbohydrate or other complex. For this compound the general name "leuco-anthocyanin" is suggested; it is converted into anthocyanidin by strong acids. The only representative of the family *Vitis* characterised by the production of free anthocyanidin is the European species, *Vitis vinifera*, and it is pointed out that this biochemical test may prove useful in the investigation of genetic problems.

AN interesting paper by Eiichi Yamasaki on "The Chemical Kinetics of Catalase" has recently appeared in the Science Reports of the Tôhoku Imperial University (vol. ix., No. 1). The property formerly attributed to all enzymes of accelerating the decomposition of hydrogen peroxide is really a specific property of catalase, which is contained as an impurity in most enzyme preparations. The catalase used by Yamasaki was obtained from the edible sprout of a certain bamboo, *Phyllostachys mitis*, Riv. The velocity of decomposition of hydrogen peroxide by catalase is, in general, proportional to the concentration of the enzyme and of hydrogen peroxide, but the activity of the catalase decreases in the course of

the reaction. As to the cause of this decrease in activity, the author can only conclude that it is due to the substrate and product of reaction, hydrogen peroxide and oxygen; and the rate of decrease is approximately proportional to the principal reaction. The decrease in activity is not to be attributed to change in concentration of hydrogen ions. It has already been found that in a very dilute solution of hydrogen peroxide and a comparatively concentrated solution of catalase the relative activity increases in the first stage and then decreases gradually. This behaviour may be attributed to the facts (1) that the ordinary reaction would be carried out at a rate somewhat higher than that which is calculated according to a first-order reaction; (2) that the rate is retarded with hydrogen peroxide and oxygen in ordinary cases; (3) that such effects are observed only in the course of reaction in very diluted solutions, because the concentration of both the substrate and the product are very small, *i.e.* the velocity constant has a maximum value; and (4) that the retardation proceeds with the measurable velocity, which is approximately proportional to the principal reaction.

THE Rotary Club of London, composed of about three hundred members, each representing a different trade or profession, and connected with twenty-five other rotary clubs in other parts of the British Isles, has undertaken the urgent and important work of endeavouring to find posts for demobilised men out of employment. We are asked to direct attention to this most praiseworthy task and have much pleasure in doing so. Thousands of capable officers and men who were on active service during the war are now seeking employment, and particulars of vacancies of any kind may usefully be sent to Mr. Edward Unwin, jun., at the "Rotary Room," Horrex's Hotel, Norfolk Street, Strand, London, W.C.2.

MR. H. MARTIN LEAKE, Director of Agriculture, United Provinces, India, is publishing through Messrs. W. Heffer and Sons, Ltd., "The Bases of Agricultural Practice and Economics in the United Provinces, India," in which the history of agriculture is traced; the fundamental facts of agricultural practice and economics are described; the lines upon which agricultural practice is likely to develop are brought out, and emphasis is laid upon the fact that recent advances in scientific knowledge have made it possible for directed, as opposed to undirected or empirical, methods to be employed. It further indicates the weaknesses of the present economic system, and develops the idea of co-partnership in the land between landlord, tenant, and Government.

MESSRS. DULAU AND CO., LTD., 34 Margaret Street, W.1, have just issued a catalogue (No. 82) of an important botanical library recently purchased by them, the volumes in which are now offered separately. The works listed number 593, and many are scarce. The catalogue is one likely to interest all students of botany, and copies may be had of Messrs. Dulau upon application.

## Our Astronomical Column.

**ASTRONOMICAL ANNOUNCEMENTS BY WIRELESS TELEGRAPHY.**—Prof. Kobold, editor of *Astr. Nachrichten*, and director of the Centralstelle, delegated the latter work to Prof. Strömgrøn, Copenhagen, during the war, but has now resumed it, and announces in *Astr. Nach.*, 5044, that arrangements have been made for the distribution of astronomical information by wireless telegraphy from the Nauen station. Such messages will bear the signature "Obs.," and it is suggested that institutions that wish to receive them should make arrangements with the wireless station nearest to them that receives Nauen messages. It is hoped that they will make a contribution to the cost of the service. The idea of using wireless in this manner is certainly a good one, and might be of great service in the case of such unexpected phenomena as the outburst of novæ, where early observations are of special value.

**THE ASTROGRAPHIC CATALOGUE.**—This great undertaking, begun a third of a century ago, is still far from completion, many of the observatories that undertook to collaborate having dropped out, from financial or other reasons. Their zones were afterwards allotted elsewhere, and one of the new observatories (Hyderabad) may be mentioned in particular for its praiseworthy energy. The late director, Mr. R. J. Pocock, unhappily died without seeing the work completed; but thanks to the Nizam's generosity the work is continuing under his successor, Mr. T. P. Bhaskaran, who has just published vol. iii., containing measures of rectangular co-ordinates of 58,743 star-images on plates with centres in decl.  $-10^{\circ}$ . The form of publication is similar to that in the Greenwich and Oxford catalogues.

**TIDAL FRICTION AND THE LUNAR AND SOLAR ACCELERATIONS.**—Dr. H. Jeffreys has a paper on this subject in the Monthly Notices for January, in which he quotes Major G. I. Taylor's result in *Phil. Trans.*, A, ccxx., that tidal friction in the Irish Sea accounts for  $1/56$ th of the required dissipation of energy, assuming that the moon's secular acceleration is  $10.5''$  per century, which is  $4.4'$  above the amount calculated from planetary action on the earth's orbit. The accelerations are here measured, as is customary, by the space gained at the end of a century. Dr. Jeffreys uses the more strictly logical system of the velocity gained, and, consequently, doubles the value of the acceleration. He gives a list of the seas that seem likely to contribute to the tidal effect, and concludes that they are capable of producing the whole of it. The tidal acceleration of the moon is the difference of two terms: (1) the apparent acceleration due to the slackening of the earth's rotation, and (2) the actual retardation due to increase of distance. In the case of the sun only (1) is present, though there may be further acceleration if the earth is travelling in a resisting medium. Dr. Jeffreys finds for the solar acceleration  $1.56''$  on his system—that is,  $0.78''$  on the usual system.

Dr. Fotheringham has rediscussed the accelerations from all available ancient observations. He finds  $10\frac{1}{2}''$  for the moon, and  $1''$ , or somewhat more, for the sun. The corresponding period for the large empirical lunar term is 260 years. Prof. Turner finds that this period agrees well with the periods deduced from Chinese earthquake records and from those of Nile floods. He also confirms it by statistics of tree-growth, derived from a study of their annual rings. He suggests that the earth is pulsating in this period with consequent alteration in its rotation, which produces an apparent fluctuation in the moon's motion, and smaller ones in that of the sun and planets.

## The Iron and Steel Institute.

THE annual meeting of the Iron and Steel Institute, held in London on May 6-7, was rendered noteworthy by the fact that the incoming president was Dr. J. E. Stead. It is somewhat remarkable that Dr. Stead has not been elected to this office before. He has been engaged in metallurgical work for fifty years, has reached the age of seventy, and no metallurgist in this country holds a higher international reputation. He has carried out a considerable number of researches of first-rate importance which are remarkable for their suggestiveness and technique, and he possesses in a striking degree the confidence and respect of those engaged in the industry. The explanation, however, is forthcoming in the opening sentences of his address, from which it is clear that he was invited to fill this office some years ago, but refused as he did not consider he was qualified, to use his own words, "to accept such an exalted position." It is quite safe to say that this misgiving has never been shared by anyone else. Dr. Stead finally yielded to the strong representations of his fellow-members on the council, and his acceptance of the office of president has been received with widespread gratification by the institute.

His presidential address is an attempt to pass in review the progress made in the ferrous industries during the past fifty years. This proved to be a gigantic piece of work, and it is not surprising to learn that Dr. Stead found more trouble in condensing than in collecting the voluminous data so as to bring them within the limits of an address. Even so, it turned out that he was not able to read more than one-third of it. The address is divided into a series of sections which deal successively with the blast-furnace, the puddling process, science in the foundry, the basic Bessemer and basic open-hearth processes, electric furnaces, the production of sound ingots, the recognition of science, the advent and progress of metallography, the application of science to the ferrous industries, the encouragement of science, and technical education. Within the limits of this article it is only possible to touch briefly on the subject-matter of three of these sections.

(1) *Blast-furnace Practice.*—It appears from the accumulated experience of this branch of the industry that no object is gained by increasing the capacity of the furnace above 30,000 cubic feet, and that its working is best controlled by having a separate blowing engine for each furnace. Increased output per furnace can be achieved by widening the diameter of the hearth and increasing the volume of the air blown in. The gases issuing from the furnace-top should be conserved by the adoption of the double bell or some similar system. The maximum proportion of their calorific value should be used by freeing them from dust, controlling the proportion of air for their combustion, and maintaining a low exit temperature. Coke-ovens should be close to furnaces and the coke handled as little as possible after it leaves them so as to avoid the production of "fines," and should be sufficiently hard to resist crushing. Fine coke disorganises the regular working of the furnace and reduces the output of pig-iron. It should, therefore, be sieved off and either used for other purposes or briquetted, if the process be not too costly, and then charged into the furnace. Dr. Stead concludes that there is sufficient evidence to show that given efficient gas-engines it is advisable to use them in preference to steam-engines. One of the still unsolved problems is the utilisation of the heat carried out of the furnaces in the slag. Inasmuch as the gas and the heat obtained from the

blast-furnaces and coke-ovens exceed the requirements of the blast-furnaces, he regards it as probable that in cases where coke-ovens, blast-furnaces, and steelworks are grouped together sufficient gas will be available to do all the heating at the steelworks without using any raw coal.

(2) *Electric Furnaces*.—The electro-thermal steel furnace, which up to 1914 had produced only a very small proportion even of the higher grades of steel, was developed with great rapidity in this country during the war. Germany led in this branch of the industry, and most of the German electric steel was made by refining basic Bessemer steel. Furnaces of 30 tons capacity were used for this purpose. The U.S.A., Italy, and France were all ahead of England in production. To-day the U.S.A. leads, followed by Germany and England. It is stated, however, that the actual number of furnaces and the amount of power used are greater in England than in Germany. By the end of 1918 no fewer than about 140 furnaces of all types were in use in this country, with a production of 150,000 tons per annum. During the war the output in these furnaces was principally used for making steel for bullet-proof plates, aeroplanes, motor-cars, armour-piercing shells, and steel helmets. Stainless steel is being made in increasing quantities, as are also nickel-chromium and other alloy steels. The significant statement is made that on the Tyne electro-thermal steel is being manufactured at a price which can compete with the acid open-hearth steel, since cheap power is available from coke-oven gas. A great advance is foreshadowed in Dr. Stead's reference to the melting of steel *in vacuo*. Mr. Albert Hiorth, of Christiania, has designed an induction furnace of this type in which the steel is melted and then cooled. Afterwards it is removed and cut up into sections for forgings. It is stated that in this way steel free from honeycomb and gases is obtained. While it is probable that this process is likely to be, for the present, applied only to the highest qualities of steel, experience may indicate the desirability of its extension to other varieties later on.

(3) *Technical Education*.—Dr. Stead finally puts in a powerful plea for the better education of the technical staffs and workmen engaged in the industry. He mentions that many years ago he discussed and formulated a scheme with the late Mr. Andrew Carnegie whereby there was to be established in every industrial centre an institute which could be used as the headquarters of local technical societies, consisting of metallurgists, engineers, electricians, chemists, and others. At this centre proceedings of technical societies and all technical publications were to be assembled. Indexes of subject-matter would be prepared by a competent staff, and supplied to the general managers of the various industries. After many years' discussion a step in this direction has been taken in the Middlesbrough district. Suitable premises have been obtained, which are being reconstructed to meet local requirements. The sum of about 10,000*l.* has been subscribed, and there are promises of annual subscriptions. This, however, is only a beginning, and Dr. Stead, who has nothing if not vision, contemplates an annual contribution from the iron and steel industry for the purpose of making the scheme adequate. He suggests a contribution of 0.1 per cent. on the capital invested, or 1 per cent. on the actual dividends. Taking the former at, roughly, about 250,000,000*l.*, the annual charge would be 250,000*l.* A fund of this magnitude should be sufficient in his opinion to enable technical institutes to be established and maintained in the eight principal iron- and steel-making districts and in

London, and to carry on their work with a "fair degree of efficiency." It is to be hoped that this suggestion of Dr. Stead's will be vigorously taken up by his council, and a serious attempt made to bring it to fruition. H. C. H. CARPENTER.

## The University of London.

GOVERNMENT OFFER OF A SITE.

AT a meeting of the Senate of the University of London, held on May 18, the Vice-Chancellor, Dr. Russell Wells, reported that the Chancellor, the Earl of Rosebery, had received from the President of the Board of Education, Mr. H. A. L. Fisher, a communication in the following terms, dated April 7:—

"The Government have watched with sympathetic interest the efforts which the universities have been making to fit themselves for the task that the period of reconstruction imposes on them, and to take advantage of the opportunities for extending their usefulness which are offered by the steadily growing public recognition of the national importance of a good system of university education. Nowhere are the opportunities more favourable than in London; for as the capital city of the Empire, with the unmatched facilities for many branches of study and research which its great national collections, hospitals, and public institutions provide, London has always attracted a large number of students, not only from all parts of the United Kingdom, but also from overseas. The war has deepened the general sense of Imperial and international solidarity and has spread more widely an understanding of the mutual benefits which the different peoples derive from drawing closer the relations between their educational systems; and it is accordingly to be anticipated that in the near future many more university students will be coming to London from our Dominions and Colonies and from foreign countries. This will inevitably place a very serious strain upon the teaching resources of the University of London and will add considerably to the already grave difficulties of organisation by which the University has long been confronted. The Government have, during the past year, sanctioned large increases in the grant to the teaching institutions included in the University of London, as in the grants to the other universities and colleges throughout the country, and no doubt these additional grants should go some way towards enabling the University to meet its increased responsibilities. The mere increase of the grants to individual colleges will not, however, by itself dispose of the special problem which London University has to solve, and the Government are accordingly prepared to take a further step which they consider likely to prove of very material assistance to the University at this critical stage of its development.

"It has seemed to the Government that this is a suitable time at which to make an offer which they have long had under consideration and which they think should help to remove a good many of the administrative difficulties involved in the housing of the University headquarters in the Imperial Institute at South Kensington. The Government are now in a position to acquire a site of about 11½ acres behind the British Museum, and they offer to devote it gratis and in perpetuity to the provision of a site for new headquarters of the University and for colleges and institutions connected with it, including King's College, whose premises in the Strand are now



inadequate for its needs. It would be out of place for me to enlarge on the advantages to be expected from securing the concentration of the headquarters of the University and its two incorporated colleges on a single site, in a quiet residential quarter close to our greatest National Library and Museum, and capable of expansion in the future as the need may arise. The merits of this site, as of other alternative sites which have from time to time been suggested, have, I know, been the subject of much discussion by the friends of university education in London, and I have no doubt that the University is fully apprised of the considerations which need to be weighed. I have no desire to persuade the University against its will. No one recognises more fully than I do the right of universities to control their own destinies and shape their own policies. The responsibility for accepting or declining the Government's offer must rest wholly with the University, which alone is in a position to estimate how far the proposal I communicate to you is likely to advance what it conceives to be its true interests. The view of the Government is, I think, sufficiently indicated by their willingness to provide for the University a site of great value in the heart of London, at a time when there is no temptation to incur expenditure upon any but objects of first-rate urgency and importance.

"It had at one time been my hope that the Government would be able to offer not only the site of which I have spoken, but also the buildings for the new University headquarters: the Government have, however, reluctantly come to the conclusion that, while they are prepared to make such provision as will secure the University from loss in respect of maintenance charges on the new University headquarters, the state of the national finances did not justify their undertaking to provide the cost of the buildings themselves from public funds. They feel that in a matter in which the honour and dignity of the City of London are so nearly concerned, the University can look with confidence to the generosity and public spirit which have always marked the citizens of London: it can do this with the greater assurance that recent years have shown an increasing readiness upon the part of the great business community to respond to appeals for University purposes.

"I am aware that a matter of such importance to the University needs to be fully discussed, and that I cannot fairly expect an immediate answer to the Government's offer. At the same time the University will understand that the Government are naturally anxious to know as soon as possible whether their offer will be accepted or not, since, if it should be declined, they propose to make early use of the site for other purposes. I have, therefore, to ask that the University's answer may not be unduly delayed."

The matter was referred to a special committee for consideration and report as speedily as possible.

### Genetic Studies of *Drosophila*.<sup>1</sup>

NO single animal has provided such a rich field for discovery in genetics as the little fruit-fly *Drosophila* (usually known as *D. ampelophila*, but now called *D. melanogaster*), and in this large and handsomely illustrated volume Prof. Morgan and his collaborators bring together the results of some of their

<sup>1</sup> Contributions to the Genetics of *Drosophila melanogaster*. I. "The Origin of Gynandromorphs." By T. H. Morgan and C. B. Bridges. II. "The Second Chromosome Group of Mutant Characters." By C. B. Bridges and T. H. Morgan. III. "Inherited Linkage Variations in the Second Chromosome." By A. H. Sturtevant. IV. "A Demonstration of Genes Modifying the Character 'Notch.'" By T. H. Morgan. Pp. v+388+12 plates. Publication No. 278. (Washington: Carnegie Institution of Washington, 1919.)

recent work upon it. Of the four parts into which the book is divided, the most interesting is the first, dealing with the gynandromorphic specimens that have appeared in Prof. Morgan's and Dr. Bridges's experiments, and including a most valuable summary and discussion of gynandromorphism in other animals. In *Drosophila* it appears that about one individual in every 2200 is gynandromorphic, but these gynandromorphs are most varied in their combination of male and female characters. A considerable proportion of those described are bilateral, with male secondary sex-characters on one side and female on the other; a smaller number are "fore and aft"; while the majority are irregular mosaics, most often with a preponderance of female characters. It is a remarkable fact, however, that in *Drosophila*, contrary to what is usual in animals of other groups, the two gonads are always of the same sex—doubtless, as the authors point out, in consequence of the very early separation of the primitive germ-cells in the Diptera. As a result of this, it may happen that a fly is externally almost entirely of one sex while containing germ-cells of the other sex, so that Nature here confirms the conclusion reached by Meisenheimer and by Kopeč from transplantation experiments, that the sex of the gonad in insects has no influence on the secondary sexual characters. Flies externally chiefly male, but having ovaries instead of testes, court normal females, but attract males.

The authors believe that in all but very exceptional cases gynandromorphs of *Drosophila* are derived from fertilised eggs which would normally produce females, i.e. from eggs containing two X-chromosomes, and that the male portions arise from cells in which one X-chromosome has been lost through an abnormal mitosis in one of the early segmentation divisions. The evidence for this conclusion is that in almost every instance the sex-linked factors borne (according to the chromosome hypothesis) by the two X-chromosomes introduced from the parents are distributed as might be expected between the male and female portions of the fly. For example, a wild-type female (heterozygous for eosin eye and miniature wing) was crossed with an eosin-miniature male. A gynandromorph among the offspring was female on the left side, with red eyes and long wing, while the right side was male with eosin eye and miniature wing. The explanation offered is that elimination of the maternal X-chromosome on the right side allowed the recessive eosin-miniature characters borne by the remaining X-chromosome to appear. Morgan's earlier hypothesis of the production of gynandromorphs by the entrance of two spermatozoa into the egg, and Boveri's of the division of the egg-nucleus before conjugation with the sperm-nucleus, are excluded by the fact that the non-sex-linked characters borne by the two parents are not divided between the parts showing different sexes. In respect of these characters, all parts of the gynandromorph, whether male or female, bear the dominant characters, whether they are introduced by the male or female parent. The analysis of these gynandromorphs thus gives important confirmation to the theory of chromosomes as bearers of hereditary characters. It is remarkable, in this connection, that although elimination of the paternal and maternal X-chromosome is equally common, evidence for the elimination of other chromosomes, which would give mosaics in characters unconnected with sex, is very rarely obtained.

Analysis of the records of gynandromorphs in other groups of animals shows that most are susceptible of the same explanation. In a few cases some other hypothesis, such as that of a binucleate egg, must be invoked. It should be noted that in part i. there

are several slips and misprints; on plate ii., Figs. 4 and 5 are transposed, according to the description; on p. 28 the word "visible" appears to be a misprint for "recessive"; and on p. 86, l. 26, "female" is printed for "male," etc. But apart from these slips and the rather inconvenient arrangement of the subject-matter, the work is the most valuable on the subject of gynandromorphism with which we are acquainted.

Space does not allow of more than a brief reference to the other three parts. Part ii. discusses in detail all the mutant characters that have occurred in "the second chromosome," *i.e.* those characters belonging to the second linked group which are not sex-limited (sex-linked) in inheritance. Full data of crossing-over ratios are given, and on the basis of these a map of the chromosome is constructed, like those previously published for the X-chromosome. Part iii. deals with inherited linkage variations in the same group, and it is concluded that two factors, the position of which in the series is determinable by their linkage relations, reduce the amount of crossing-over between certain factors without altering their sequence in the series. Part iv. describes the isolation by selection of a factor which affects the extent of development of the character "notch" in the wing, and proves that change resulting from selection is due, not to an alteration in the factor for "notch," but to the presence of a distinct modifying factor. It is also shown that Castle's hypothesis of contamination by heterozygosis is untenable.

Finally, it is impossible to read the facts presented in this volume without being impressed by the great strength of the evidence for Morgan's theory that Mendelian factors are borne by chromosomes and arranged in definite sequence within them. Difficulties remain, but a theory which enables predictions to be made and verified cannot lightly be disregarded.

L. DONCASTER.

### The Conservation of Fuel.

IN view of the importance of national economy in our fuel reserves, it is not surprising to find that Sir Dugald Clerk selected the subject of the conservation of fuel in the United Kingdom for the James Forrest lecture which he delivered at the Institution of Civil Engineers on April 20. The coal raised in 1913 was about 287.4 million tons, of which 189 million tons were retained and consumed here. The total coal reserves at 2 per cent. per annum increase will be exhausted in about 250 years, but fuel will be so expensive long before that time has elapsed that we shall be hard pressed to maintain the existing population. A return to the agricultural civilisation of 1750 would require the reduction of our population to one-third. It is of the utmost importance to study the engineering problems arising.

A great part of the lecture was taken up in criticising the figures given by the Coal Conservation Committee. It will be remembered that this Committee advocated the establishment of large turbo-electric stations at about sixteen centres, and the covering of the country with a network of mains capable of supplying our whole power needs by electric motors. By this scheme the Committee expected to save 55 million tons of coal on power alone. Many competent electricians and capable motive-power engineers have the gravest doubts as to the accuracy of the data presented, and as to the outcome of the ambitious scheme advocated. The Committee adopted the figure of 5 lb. of coal per horse-power-hour as the present consumption; Sir Dugald gave estimations arrived at

by two different methods: one of 3.9 lb. per b.h.p.-hour and another of 4.05 lb. per b.h.p.-hour. The first value is based on a census of production data corrected by allowing for steam production other than for motive power, and for an error in total h.p.-hours as determined by the Committee. The second value of 4.05 lb. is estimated by considering the average of many typical steam engines. Taking the whole of the facts into consideration, and assuming electricity in the future to be used for the generation of power and light only, then a reduction to 1.56 lb. of coal per b.h.p.-hour would give a possible saving of not more than 37½ million tons of coal per annum. The saving of 55 million tons expected by the Committee is, in Sir Dugald Clerk's opinion, based on fallacious reasoning.

The Committee in its report clearly intends also to generate heat, and expects to do so with economy superior to the existing systems of coal and gas combustion. Sir Dugald went into the question of the comparison of gas with electricity for domestic heating, and arrived at the figure of 43.6 per cent. of the heat used at the gasworks as the proportion which the consumer receives at his premises; taking the efficiency of the gas at 42 per cent., the final efficiency, referred to the heat consumption at the gasworks, is  $43.6 \times 0.42 = 18.3$  per cent. In electric heating the consumer receives 11.7 per cent. of the heat consumed in the thermodynamic transformation at the super-station, and using this with an efficiency of 59 per cent., the consumer obtains in his apparatus  $11.7 \times 0.59 = 6.9$  per cent. of the heat units consumed at the generating station. Assuming the gasworks to be abolished, and electric generating stations to be expanded so as to supply current for heat supply at the same generating efficiency as for power, and taking all facts into consideration, Sir Dugald estimates that the whole assumed saving on power will be lost, and that 68.6 million tons of coal per annum will be consumed instead of 67.5; he therefore considers that the super-stations will not justify their existence, that the Government scheme is wrong, and that the sweeping conclusions arrived at by the Coal Conservation Committee are unjustifiable.

Sir Dugald gives some methods of saving fuel which are immediately applicable. Great changes are now in operation throughout the gas industry due to the adoption of the thermal unit standard for sale. In a few years the majority of gasworks will deliver to the consumer in the form of gas 75 per cent. of the whole heat of the coal, and the improvements in gas apparatus, etc., are so great that the efficiency of use of the gas will rise from 42 to 55 per cent. He estimates that a saving of 4.8 million tons of coal on the present consumption will result from these changes. On the assumption of the complete displacement of coal in households by gas, we should use only 17.5 million tons instead of 35 millions.

Mr. D. Brownlie's figures for coal consumed in boiler furnaces were quoted. If boiler attendants be better trained, and masters take some pride in obtaining best efficiencies, a saving of 4 million tons per annum would result. Collieries consume about 17 million tons per annum in boiler furnaces at an average efficiency of 55.5 per cent. If this be raised to 75 per cent., the saving on this item would be 4.4 million tons per annum.

The notion of the great gain to be expected from very large steam turbines is held to be quite erroneous. Even with the most modern plant an increase in power per turbine from 10,000 to 100,000 kilowatts only reduces the steam consumption from 9 to 8.5 lb. per kilowatt-hour. A recent examination by Sir

Dugald of the limits of thermal efficiency of gas and oil engines shows that 45 per cent. b.h.p. may be obtained in the near future. Sir Charles Parsons at the same time prepared an estimate of the limiting efficiency of the steam turbine as 28 per cent. Steam, internal-combustion, and gas engineers welcome the free competition with electricity supply, but consider that any attempt to crush out the smaller power units by a great Government scheme will act against the best interests of the country as to both coal conservation and economy in cost.

Sir Dugald also referred to the principle of heating towns by utilising the exhaust steam from steam turbines in central stations, and to Lord Kelvin's proposal to heat rooms by means of reversed Carnot cycle engines. By making full use of our water-power, three million horse-power could be added to the work of the country without consuming any additional coal.

### Buddhism in the Pacific.

AT a meeting of the Royal Anthropological Institute on Tuesday, May 18, Sir Everard im Thurn, president, in the chair, Sir Henry Howorth read a paper on "Buddhism in the Pacific." The paper discussed the disintegrated distribution of the Polynesian race, and the occurrence, especially in the Hawaiian archipelago and that of New Zealand, of two of its factors which are separated by the whole length of the Pacific Ocean, one occurring in the extreme north and the other in the extreme south, and separated by an intervening area occupied largely by Melanesians. The two factors in question agree very closely in language, while they differ materially in the art and form of the objects which they use. Inasmuch as the Maoris almost certainly migrated to their present quarters at the beginning of the fifteenth century, this is the only way to account for the virtual identity of their speech with that of the Hawaiians, and the general character of their ornamental work with that of the Melanesians. The Hawaiians, on the other hand, present us with a series of objects, *i.e.* helmets and cloaks, made of feathers which, in their form and colour, differ entirely from those made by other members of the Polynesian race. They agree in an extraordinary way in colour and form with those of the Reformed Lamaists of Tibet, who, like other Buddhists, were great travellers and evangelists at a time when Chinese and Japanese vessels, as has been so completely proved in recent years, were traversing the Indian Ocean and visiting the whole of the eastern archipelago at least as far as New Guinea, and apparently even reaching New Zealand, where many years ago a very interesting bronze figure was found.

Sir Henry Howorth quoted instances of the drifting and wreckage of Chinese and Japanese vessels on the central and eastern Pacific during the time which has elapsed since Europeans first visited that ocean, and also the tradition of the Sandwich Islanders that several Japanese and Chinese ships had been wrecked among them in early times. It was not wonderful, therefore, that we should find their kings and gods adopting the stately dress used by the Lamas, the colours of which they imitated in feathers. All the details of the helmets exactly equate, while the cloaks are ornamented with patches of red on yellow or yellow on red, just as the Lamaist cloaks are, in the latter case in pursuance of the injunction of their founder that their cloaks must be ragged and patched.

In the interesting discussion which followed the reading of the paper, Dr. Glanville Corney cited examples, some of which had come under his own

observation, of the drifting of boats with native crews for long distances in the Pacific, and pointed out that the Polynesians were always ready to put out to sea. The Chinese had it on record that Buddhists visited Mexico at a very early date. The similarity shown by the helmets and cloaks of Hawaii and Tibet was very striking, and the explanation offered by Sir Henry Howorth was most probable.

Mr. Ray said that he himself for some years had been of the opinion that certain elements had been carried into Polynesia at least from Malaya, if not from farther—possibly Japan. The characteristic of the Polynesian was that he was very prone to imitate anything which took his fancy, as, for instance, European hats had been imitated. The Cambridge Expedition to the Torres Straits had found a club which was clearly an imitation of a Loyalty Islands club.

Mr. Hocart said that in dealing with the wanderings of the Polynesians too much stress had been laid on drifting, but deliberate purpose should be more emphasised. There was among the Polynesians a distinct passion for finding out new lands.

Dr. Forbes adduced as evidence of early movement Chinese objects which he had seen taken from Peruvian graves which were certainly pre-Inca in date.

Sir Everard im Thurn, in bringing the discussion to a close, said that Buddhist monks might well have accompanied the early voyagers in the Pacific. His attention had recently been directed to the question of the Hawaiian helmets, and he wished to point out that the native peoples of the Pacific were very fond of making head-coverings for use on ceremonial occasions. They paid great attention to the ornamental dressing of their hair, and if their hair were not suitable for this purpose they made artificial hair out of grass seed. He himself had brought back from Fiji an example of a native wig used in a ceremonial dance, which was now in the Pitt Rivers Museum at Oxford. It was probable, therefore, in view of this particular tendency, that the Hawaiians would take readily to copying the head-dress of the Buddhists. This particular form of head-dress or helmet was not confined to Hawaii; objects ornamented with men's heads wearing head-dresses like those of Hawaii occurred in Hermit Island, near New Ireland.

### Astronomy at Oxford during the War.

WE have recently received from Prof. H. H. Turner, of the Oxford University Observatory, a collection of papers published during the years 1914-19. These for the most part are reprints from the Monthly Notices of the Royal Astronomical Society, and represent researches carried out during this period by Prof. Turner and various members of his staff, including several volunteer workers who have rendered some valuable assistance. It is, of course, impossible adequately to discuss a miscellaneous collection of papers such as this in any detail, but there are several outstanding features of interest which call for special remark.

In the first place, a considerable number of the papers is devoted to an important research of Prof. Turner's on "A Proposal for the Comparison of the Stellar Magnitude Scales of the Different Observatories taking Part in the Astrographic Catalogue." This was first outlined at Paris in 1909, the proposal being: "That the number of images recorded under each unit of the magnitude scale be counted and tabulated." The chief objects in view were to detect systematic errors of scale at the various collaborating observatories, and to test Prof. Kapteyn's conclusion that the Galaxy is relatively richer in faint

stars than the remaining parts of the sky—a theory upon which some doubt had been cast by earlier work of this nature. The method, although of extreme simplicity, has certainly proved efficient for the first of these objects, and various systematic errors of scale have been clearly exhibited. With regard to the second object, an examination of the ratio of the number of faint stars to bright in the various regions investigated appeared at first to negative Prof. Kapteyn's conclusion; but, although this ratio was not found to vary with galactic latitude, certain changes were detected in different parts of the sky. Prof. Turner has thus been led to the interesting conclusion that regions of "obscuration" exist which tend to obliterate the fainter stars, and these regions appear to form a spiral in the heavens, the central line of which is approximately given by the equation

$$\alpha + 3.66\delta = 247^\circ,$$

where  $\alpha$  denotes right ascension and  $\delta$  declination. There appears to be a fairly sharp boundary to this "spiral of obscuration" on the side of smaller R.A. in the northern hemisphere, and on the side of greater R.A. in the southern hemisphere.

Another very valuable piece of work is represented by a series of papers on "Baxendell's Observations of Variable Stars," edited by Prof. Turner and Miss M. A. Blagg. A very considerable amount of painstaking work must have been expended on this task of revising and editing Baxendell's observations of some twenty-three long-period variables. The greater part of the work appears to have been done by Miss Blagg, and the result as a whole is certainly a most valuable contribution to the study of this particular branch of astronomy. In connection with this subject we may also mention two papers by Prof. Turner "On the Classification of Long-period Variables," in which the alternative classifications of the author and of the Rev. T. E. R. Phillips are discussed and compared at some length. Both methods are considered to be useful, and a suggestion is made that some stars might pass from one of Phillips's groups to the other during the course of their evolution. This latter idea is more fully discussed in the particular case of W Cygni, which appears to be changing from Phillips's Group I. to Group II.

There are many other shorter papers of considerable interest, but these are too numerous to be noted here individually. The whole collection pays ample tribute to the energy and resource with which work has been carried out at the observatory during the trying period of the last few years. Apart from the many difficulties directly resulting from the war, there have been other troubles with which the staff has had to contend. In particular, we regret to note the decease of the caretaker, Mr. J. Mullis, who had been with the observatory since its erection in 1874. There is at present no second assistant or resident computer, and Prof. Turner and his staff must certainly be congratulated on the way in which the work has been carried on in the face of these and numerous other difficulties. D. L. E.

### The Alligator Pear.

THE cultivation of the Avocado or alligator pear is the subject of articles by Mr. W. G. Freeman and others in the Bulletin of the Department of Agriculture, Trinidad and Tobago (vol. xviii., part 3). The Avocado (*Persea gratissima*), a member of the family Lauracæ, is a pear-shaped fruit with a large central stone, the amount of covering flesh varying considerably according as the kind is good or poor.

It is one of the most important of the fruits which have become widely distributed since the discovery of the New World. It is probably a native of tropical America, and was introduced at an early date into the West Indies, where it is now naturalised. Sir Hans Sloane, in his "History of Jamaica" (1707-25), gives a long description of the tree and its fruit, and Dr. Patrick Browne (1756) is eloquent on the flavour of the latter and the esteem in which it is held. The edible portion of the fruit varies from a little under one-half to more than three-quarters of the weight of the whole, according to the thickness of the rind and the relative size of the seed. Its food-value is mainly due to its high fat content, which in some varieties approaches that of the olive, and is especially high in the fruit grown in Florida and California.

Although so long cultivated in the West Indies, yet little attention has been given until recently to the selection and propagation of good varieties. It is an extremely variable plant, and the method of selecting seeds from trees bearing the best fruit and of high productiveness gives uncertain results, as the varieties do not come true from seed. But by budding or grafting from good varieties these may be fixed, and by this means poor trees will be converted into good varieties. Mr. Freeman suggests the probability of a seedless Avocado being obtained, as occasional seedless fruits have been reported from the United States and Honolulu. The Avocado needs no very special care in cultivation, and does very well on the poor soil of parts of the northern range in Trinidad. Budding has been practised at the St. Clair Experiment Station for the last four years, and the curator, Mr. R. O. Williams, gives details of the operation. The method is the same as that generally adopted for roses and citrus. The full-grown tree is fairly free from insect pests, but the plant is more susceptible in early stages and when recently budded. Mr. F. W. Ulrich describes the various insect pests and means for combating them. A more serious disease which attacks the fruit is the so-called anthracnose, very closely related to the fungus which causes anthracnose of the mango. In the case of fruits packed for export this disease causes complete rotting of the whole consignment. Repeated sprayings with Bordeaux mixture are necessary to prevent its development.

### The Improvement of Grassland.<sup>1</sup>

IT is too often the case that grassland is left to take care of itself, and that no steps are taken for its improvement. Even where manuring is carried out it is usually confined to occasional dressings of farmyard manure; little or no use is made of artificial fertilisers, and the beneficial effects of lime upon the herbage are far less widely known than they should be. The consequence is that much of the finest pasture and meadow land in the country is carrying only a second- or third-rate herbage simply from lack of knowledge of the most effective treatments to bring about improvement. For the education of public opinion in this respect nothing is more useful than demonstration plots, and the Ministry of Agriculture and Fisheries has issued a most valuable and comprehensive pamphlet outlining schemes of experiments suitable for this purpose. The schemes intended for farmers are simple in character and direct and practical in their object, while those drawn up for the agricultural colleges and institutes deal with experiments requiring considerable attention and supervision.

<sup>1</sup> "The Improvement of Grassland: Suggestions for Demonstrations and Experiments." Miscellaneous Publications No. 25. Ministry of Agriculture and Fisheries.

As a preliminary, the necessary tables are given to enable the manures used to be standardised to ensure uniformity of treatment so far as possible, and the method of noting and reporting the results is clearly outlined. It is recommended that the attention of farmers should be devoted to the improvement of the various classes of grassland on different types of soil, and particulars are given for the manuring of meadow hay, "seeds" or rotation hay, and pastures of different grades. Emphasis is laid on the value of liming experiments, which should be carried on at the same time as the manurial tests.

The attention of agricultural colleges and institutes is directed to the need for various experiments other than manurial trials. Grazing trials properly carried out would provide valuable information as to the best methods of dealing with pasture land, and mechanical operations are suggested to show the effect of mole-draining, cultivation, breaking, and reseeded. In addition, it is suggested that a good deal of attention might profitably be directed to a consideration of the seeds used for sowing down, with regard to the permanence of different varieties, the most suitable mixtures for leys and for renovating permanent grass, and to the possibility of harvesting supplies of seed.

The pamphlet is so suggestive and so broad in its scope that it should find its way into the hands of all interested in grassland, and it is much to be hoped that the official nature of the publication will not prevent it from reaching the general farming public.

W. E. BRENCHEY.

### Levelling Errors.<sup>1</sup>

A DEPARTMENTAL paper lately published by the Survey of Egypt contains an interesting investigation of a systematic error which has been found to occur in the levelling carried out in Egypt and in the Sudan. The effect of this error, which has the same sign over all kinds of ground, acts in the direction of making the backstaff reading systematically too small and the forestaff reading too great. Movement of the staves or level and other sources of error having been eliminated, the author draws the conclusion that the effect of refraction is not wholly removed by keeping the distances between the level and the staves equal in the conditions under which the work is done. Precise levelling in Egypt is carried out in the winter months and during about three hours after sunrise and three hours before sunset. Experiments have shown that at sunrise a temperature lapse-rate of the order of  $1^{\circ}$  C. to  $2^{\circ}$  C. per metre often exists, the air being colder near the ground than higher up. In two or three hours this lapse-rate has disappeared, and a little later becomes reversed, so that with hotter air near the ground setting up convection currents, insteadness of the staff-image sets in, preventing further work. In the afternoon the ground cools very slowly, so that the change in the temperature lapse-rate, and consequently in the refraction, is then very gradual.

The error is, therefore, traced to the very rapid change in refraction during the early morning hours, of which the effect is noticeable in observations taken at a few minutes' interval. To eliminate it, all staff readings are now taken with as little delay as possible, and the observer reads alternately the backstaff first and the forestaff first—a procedure which has very materially reduced the systematic error, not only in precise levelling, but to a much greater degree in second-order levelling, where the time taken between successive readings is much longer.

<sup>1</sup> "Systematic Error in Spirit Levelling." By J. H. Cole. Survey of Egypt Departmental Paper No. 35. (Cairo, 1919.)

It has been recognised for some time that a systematic error may be caused by such a temperature inversion when levelling over sloping ground, but in the present report the rapid change of the temperature lapse-rate from a maximum value to zero is indicated as a cause which may be expected to operate even on level ground in any region where hot days follow clear, cold nights with effective radiation. In the last annual report of the Ordnance Survey such a systematic error, almost invariably of one sign, is referred to as being still unexplained. It would seem that here also local temperature inversions near the ground may be concerned to some extent.

H. G. L.

### University and Educational Intelligence.

BIRMINGHAM.—Sir John Cadman is resigning his post as professor of mining at the end of the current session.

CAMBRIDGE.—On May 19 the degree of Doctor of Law *honoris causa* was conferred upon Lord Plymouth, Admiral of the Fleet Lord Jellicoe, Field-Marshal Lord Haig, Rear-Admiral Sir W. R. Hall, M.P., the Abbé Henri Breuil, Institute of Human Paëontology, Paris, and Sir John Sandys, Orator Emeritus.

LEEDS.—At a meeting of the University Council held on May 19, it was resolved that a chair of physical chemistry should be instituted, and Dr. H. M. Dawson was selected to be the first occupant of the chair. Since 1905 Dr. Dawson has been lecturer in physical chemistry at the University, and has carried out extensive researches in various branches of physical chemistry—in particular, investigations bearing on the constitution of solutions and on the mechanism of chemical change.

LONDON.—The degree of D.Sc. (Engineering) has been conferred on Mr. B. C. Laws, an external student, for a thesis entitled "Elasticity and Distribution of Stress in Thin Steel Plates," and other papers.

From the report of the Principal Officer (Sir Cooper Perry) for 1919–20, it appears that the University can look forward to a period of unprecedented development. Admissions by all channels in 1919–20 amounted to 12,608, almost double the corresponding number for 1913–14. Candidates for first degrees were 936, comparing with 1636, reflecting the diminished numbers of those who matriculated "during the lean—the honourably lean—years of the war." It is of interest to note that of the 1086 candidates for all degrees, 613 were internal and 473 external. This is gratifying evidence that the "private" student is tending to disappear, or, rather, to study under more favourable conditions. The list of benefactions to the University and its colleges is most encouraging. The outstanding gift is from the trustees of the Sir Ernest Cassel Educational Trust of 150,000*l.* and 4000*l.* a year for five years. New University chairs have been established in aeronautics, modern Greek, Portuguese, Imperial history, Dutch, bacteriology, physiology, pathology, and physics. The question of hostel accommodation is being considered by a special committee. The report concludes on "a justified note of congratulation." The duty of the universities is plain; their province, though extensive and varied, is defined; their way is illuminated; "into the universities the nation looks in a unique degree for hearts and minds fitted to enrich the blood of the race—for the constant supply of men and women of trained insight and enlarged sympathies, apt for the higher offices of citizenship. This is our peculiar duty—to

conduct the Lampadephoria of the inspiration of humanity, and to guard and develop the most precious and enduring aspects of the most comprehensive of all the arts—the art of Life itself.”

The new building of the Department of Applied Statistics and Eugenics (including the Galton and Biometric Laboratories) at University College, London, will be opened by Dr. Addison, Minister of Health, on Friday, June 4. The Vice-Chancellor of the University will preside.

Two lectures on Factors in the Froth-flotation of Minerals will be given at the Sir John Cass Technical Institute, Aldgate, E.C. 3, by Mr. H. Livingstone Sulman, on Wednesdays, June 2 and 9, at 5.30 p.m. The chair at the opening lecture will be taken by Mr. F. Merricks, president of the Institution of Mining and Metallurgy.

The Glasgow Technical College is preparing for its entrance hall a monument in bronze and marble to the 612 students and members of its staff who gave their lives in the war. To show the quality and quantity of the war work of the 3218 members, students, and past students of the college who served in the Army or Navy, or on special national duty, the college has issued, in a volume of 211 pages, a list of their names and services. The preface, by Sir George Beilby and Mr. Stockdale, the director, summarises the contributions of the college to research on fuels and explosives, the testing of war materials, and the training of munition workers. The normal classes had to be maintained for the thousands of evening students as well as for the many foreigners and refugees, for whom most of the day classes had to be continued in spite of the reduction in the staff. The successes enumerated include three awards of the Victoria Cross and 336 orders and crosses. Amongst the ranks, attained, one student became colonel, fifteen were lieutenant-colonels, and seventy-seven majors. The letters quoted from the Government Departments express high appreciation of the research work conducted at the college. Of its contributions, both of men and mind, to the national strength, the college and science may well be proud.

The recently issued report on the war work of the College of Technology, Manchester (faculty of technology in Manchester University), gives an interesting account of the services rendered by members of the college in his Majesty's Forces—particularly in connection with the Royal Engineers and the technical branches of the Royal Navy—and in the many fields of scientific research opened up by the war. The greater part of the report is concerned with college war work other than that of supplying men. It appears that before the war was over the college was by no means large enough to undertake all the work which the military authorities—including the Air Board as well as the Admiralty and the War Office—were anxious to entrust to it. The mechanical and electrical engineering departments of the college were intimately concerned with the work of the Lancashire Anti-Submarine Committee, which had its headquarters in the college, and produced and developed several instruments, including, in particular, a deep-sea hydrophone for detecting and combating enemy submarines. The same departments helped to solve certain problems relating to the fitting of wireless apparatus to aeroplanes; for instance, a high frequency alternator, designed and manufactured in the college, was largely adopted for both naval and military planes. A new type of gas furnace designed in the college led to important improvements in the heat treatment of machine tools, involving an increase of

30 per cent. in the speed of the machining of shells and other munitions. The same research enabled the college to supply the Admiralty with special blades for cutting mine mooring cables, and when the demand for these blades was greater than the college could supply, the Admiralty required its manufacturers to employ the method of heat treatment devised in the College of Technology. An improved cast iron of high tensile strength, produced under the direction of the metallurgical department of the college, was usefully employed in the manufacture of gas shells. The college departments of applied chemistry and textiles carried out a number of investigations upon fabrics used in aircraft manufacture. A thorough investigation of the structure and scouring of airship fabrics led to the development of a process which was afterwards applied to all R.N.A.S. fabrics. The giant airships R33 and R34 were treated with a special dope produced at the college before starting on their long-distance flights. The chemical laboratories were also engaged during the war in investigating processes for the manufacture of explosives, pharmaceutical products, dyestuffs, rubber derivatives, and foodstuffs.

## Societies and Academies.

LONDON.

**Royal Society**, May 13.—Sir J. J. Thomson, president, in the chair.—Dr. A. D. Waller: Demonstration of the apparent "growth" of plants (and of inanimate materials) and of their apparent "contractility." In Sir J. C. Bose's original demonstration an amputated leaf was fixed up in connection with a crescograph, at a magnification stated to be  $\times 10^7$ , and the indicator was shown to be moving in a direction and at a speed that were stated as representing the growth of the petiole. Alternating currents were now sent through the leaf, causing a sudden reversal of the movement of the indicator, e.g. in the demonstration that the present author witnessed at the Royal Society of Medicine the indicator (a spot of reflected light) moved to the right at what he judged to be something like 1 metre per sec. in the direction of elongation (by growth?), and flew off scale in the opposite direction, at least ten times as fast, as soon as the buzz of the exciting coil was heard ("degrowth"). The demonstration was, in Dr. Waller's opinion, illusory. The movement to the right (indicating an elongation of petiole = 0.1 m. per sec.) was indeed consistent with "growth," although its rate was surprisingly high under the conditions of experiment. The elongation might, however, have been due to, or modified by, many accidental variations of conditions—heat, moisture, handling of plant during preparation, etc.—and was precisely similar to the gradual elongation that takes place in a damp fiddle-string under similar conditions. The second part of the experiment, when the "excited" plant shortened and caused the indicator to fly off to the left, is held to afford conclusive proof of fallacy. The fact belonged to the familiar phenomena of heat contraction aroused by electrical currents in all kinds of (doubly refracting) moist conductors, whether living or dead, to the study of which attention was directed by Engelmann in his Croonian Lecture of 1895. These are demonstrable with a low-power crescograph ( $\times 10^6$ ), and play a part in masking or simulating physiological changes when a high power ( $\times 10^7$ ) is employed.—W. N. F. Woodland: The "renal portal" system (renal venous meshwork) and kidney excretion in vertebrata. The first three parts of this memoir contain, in the first place, proof that the assumption, commonly made in physiological literature, that the venous blood "supplied" to the kidneys of lower vertebrata mixes with

the arterial blood and traverses the system of channels known in mammals as the intertubular plexus, is erroneous—the renal afferent vein-blood does not supply the kidney tubules. The renal artery-blood traverses the intertubular plexus proper, and the renal afferent vein-blood a system of wide sinusoids (renal venous meshwork), which has no connection with the intertubular plexus, save that the latter opens into the former where the venous blood flows into the renal efferent veins. In the second place, much experimental and other evidence is provided to prove that the "renal portal" system is devoid of function so far as kidney secretion is concerned. Evidence is also adduced to show that the urine is solely secreted by the renal tubules, the glomeruli taking no part. The glomeruli (as will be explained in the forthcoming Part iv.) are solely to be regarded as retia mirabilia and function as such. This is the tubule-cum-rete theory of kidney secretion.

**Zoological Society**, May 11.—Prof. J. P. Hill, vice-president, in the chair.—Dr. W. J. Dakin: Fauna of Western Australia. III. Further contributions to the study of the Onychophora.—C. Forster-Cooper: Chalicotheroidea from Baluchistan.

## PARIS.

**Academy of Sciences**, May 3.—M. Henri Deslandres in the chair.—C. Moureu and J. C. Bongrand: New researches on carbon sub-nitride. The action of the halogens, haloïd acids, and alcohols. Numerous attempts to prepare the compound  $CN-C\equiv C-CN$  in quantity proved unsuccessful, and hence experiments on this substance had to be confined to those requiring little material. The sub-nitride combines with bromine. Hydrobromic acid gives bromobutene dinitrile,  $CN-CH=CBBr-CN$ , and hydriodic acid furnishes the corresponding iodine compound. Hydrochloric acid acts differently, addition and partial hydrolysis taking place simultaneously, giving chlorobutene nitrile amide,



Ethyl alcohol forms an addition product, probably ethoxybutene-dinitrile.—J. Constantin: The fossil chalk Siphonæ of Munier-Chalmas.—A. Blondel: Best conditions to be fulfilled by long-distance electric cables for energy transmission. Practical solutions.—A. de Gramont: The spectrographic detection of metals, especially zinc, in animal organisms. Details of the application of the spectrograph to the detection of zinc in the ash from snake poison.—G. Julia: Families of functions of several variables.—B. Jekhovskiy: Differential equations of the second order verified by Bessel's functions of several variables.—J. Kampé de Fériet: The use of generalised differentials for the formation and integration of certain linear differential equations.—MM. Descolas and Prétet: The macrographic study of the propagation of cooling in the interior of a steel ingot starting from its solidification. The method is based on the appearance of the specimen after etching with dilute sulphuric acid (17 in 5).—D. Hondros: The integration of the Laplace equation between two non-concentric spheres.—M. de Broglie: The properties of reinforcing screens with respect to X-ray spectra and on a splitting of the  $\beta$  line of the K spectrum of tungsten.—G. Chaudron: Reversible reactions of water on tungsten and the oxides of tungsten. The constant  $K = \frac{\rho(H_2O)}{\rho H_2}$  has been studied at temperatures between 600° C. and 1000° C. The results are given in both numerical and graphical forms.—C. Zengheli and B. Papaconstantinou: Colloidal rhodium. Sodium rhodium chloride was reduced in presence of sodium protobinate by various reducing agents, hydrazine sulphate,

hydrogen gas, and formaldehyde, the last of which gave the best preparation. After dialysis and drying in a vacuum, brilliant scales are obtained which are very stable. Solutions have remained unchanged for two years. The crystals contain 33 per cent. of rhodium. Colloidal rhodium absorbs about 2700 times its volume of hydrogen, and from 300 to 1800 times its volume of carbon monoxide, according to the conditions.—O. Bailly: The action of neutral methyl and ethyl sulphates on alkaline phosphates in aqueous solution.—J. B. Senderens and J. Aboulenc: The catalytic decomposition of the fatty acids by carbon. The vapours of the fatty acids, from acetic to isovaleric, give no gas at 460° C. in the absence of a catalyst; but in presence of purified animal charcoal decomposition takes place at 360° to 380° C. The products of the reaction include carbon monoxide and dioxide, unsaturated hydrocarbons, hydrogen and methane, a liquid containing water, and traces of ketones and aldehydes. Sugar carbon is less active as a catalyst, and a much higher temperature is required to effect the decomposition.—P. Guérin and A. Goris: A new plant containing coumarin, *Melettis melissophyllum*. The presence of coumarin in this labiate has been proved: it probably occurs as a glucoside hydrolysable by emulsin.—Ad. Davy de Virville: Note on the comparative geographical distribution of *Primula officinalis*, *P. grandiflora*, and *P. elatior* in the west of France. *P. grandiflora* grows best in damp, shady spots, whilst *P. officinalis* prefers dry soil and positions exposed to sun; hence, although hybrids of these two species are readily formed, they rarely occur in Nature. In railway cuttings the conditions favourable to each species may occur in close proximity, and hence the hybrid is particularly abundant along railway lines. It is suggested that *P. elatior* may have originated as a hybrid between the two species above-mentioned.—H. Coupin: Seedlings which turn green in the dark. The green colouring matter of pine seedlings grown in the absence of light is not identical with that of pine seedlings grown in daylight. The differences are marked in *Pinus sylvestris*, less marked in *P. pinea*, and slight in *P. maritima*.—A. Mayer: The mode of action of the poison gases utilised during the war.—I. Nagotte: Formation and structure of blood-clots.—H. Violle: Milk and hæmolytic. Normal milk does not produce hæmolytic of red blood corpuscles, not even when mixed with 30 per cent. of its volume of water. Any milk producing hæmolytic after this addition of water is abnormal.—M. Marage: The limits of debility and pretuberculosis.—P. Wintrebert: Medullary conduction in *Scyllorhinus canicula*, and the supposed function of the transitory dorsal giant cells of Rohon-Beard.—M. Lécaillon: Eggs intermediate between the summer and winter eggs produced in the cocoon of the silkworm.—L. Hudelo, A. Sartory, and H. Montlour: Eczematoid endemiomycosis due to a parasite of the genus *Endomyces*.—F. Diéner, F. Wandenbulke, and Mlle. M. Launey: The action of activated sludges.

## Books Received.

The Social Diseases: Tuberculosis, Syphilis, Alcoholism, Sterility. By Dr. J. Héricourt. Translated, with a final chapter, by B. Miall. Pp. x+246. (London: George Routledge and Sons, Ltd.) 7s. 6d. net.

Animal and Vegetable Oils, Fats, and Waxes: Their Manufacture, Refining, and Analysis, including the Manufacture of Candles, Margarine, and Butter. By Dr. G. Martin. Pp. x+218. (London: Crosby Lockwood and Son.) 12s. 6d. net.

Department of Statistics, India. Agricultural Statistics of India, 1917-18. Vol. i. Pp. xvi+321. (Calcutta: Superintendent, Government Printing, India.) 2 rupees.

Geology of the Mid-Continent Oilfields, Kansas, Oklahoma, and North Texas. By Dr. T. O. Bosworth. Pp. xv+314. (New York: The Macmillan Co.; London: Macmillan and Co., Ltd.) 3 dollars.

Chemical Services Committee, 1920, Report. Pp. xii+121. (Simla: Supt., Government Central Press.)

Diary of Societies.

THURSDAY, MAY 27.

ROYAL INSTITUTION OF GREAT BRITAIN, at 3.—William Archer: Dreams, with Special Reference to Psycho-Analysis.  
LINNEAN SOCIETY (Anniversary Meeting), at 3.  
ROYAL SOCIETY, at 4.30.  
CONCRETE INSTITUTE (Annual General Meeting, followed by an Ordinary Meeting), at 7.30.—Major H. Best: The Mystery Fort, Richborough.  
ROYAL SOCIETY OF MEDICINE (Urology Section), at 8.30.—Sir Peter Freyer: Modern Progress in Urinary Surgery.

FRIDAY, MAY 28.

ROYAL SOCIETY OF MEDICINE (Study of Disease in Children Section) at 4.30.—(Annual General Meeting.)  
PHYSICAL SOCIETY OF LONDON, at 5.—Sir W. H. Bragg and Others: Discussion on X-ray Spectra.  
JUNIOR INSTITUTION OF ENGINEERS, at 7.30.—A. Arnold: Two Years as an Engineer in the Grand Fleet.  
ROYAL SOCIETY OF MEDICINE (Epidemiology and State Medicine Section) (Annual General Meeting), at 8.30.—Dr. P. Hartley and Prof. C. J. Martin: The Apparent Rate of Disappearance of Diphtheria Bacilli from the Throat after an Attack of the Disease.  
ROYAL INSTITUTION OF GREAT BRITAIN, at 9.—Prof. W. L. Bragg: The Packing of Atoms in Crystals.

SATURDAY, MAY 29.

ROYAL INSTITUTION OF GREAT BRITAIN, at 3.—Dr. J. H. Jeans: The Theory of Relativity (Tyndall Lectures).

SUNDAY, MAY 31.

ROYAL SOCIETY OF ARTS (Indian Section), at 4.30.—A. Howard: The Improvement of Crop Production in India.  
VICTORIA INSTITUTE (at Central Buildings, Westminster), at 4.30.—Rev. S. A. McDowall: The Meaning of the Æsthetic Impulse.  
STURGEON'S INSTITUTION, at 5.—(Annual General Meeting.)  
ROYAL GEOGRAPHICAL SOCIETY (at Aeolian Hall), at 5.30.—(Anniversary Meeting.)  
ROYAL SOCIETY OF MEDICINE (Odontology Section) (Annual General Meeting), at 8.—C. A. Clark: Relation of Teeth to the Floor of the Antrum.

TUESDAY, JUNE 1.

INSTITUTION OF GAS ENGINEERS (at Institution of Mechanical Engineers), at 10.30 a.m.—Sir Ducald Clerk: Presidential Address.—Report of Refractory Materials Research Committee: (a) The Casting of Gas Retorts; (b) Some Comparative Tests of Machine-made and Hand-made Silica Bricks; (c) The Specific Heats of Refractory Materials at High Temperatures.—Report of the Life of Gas Meters Research Committee: The Internal Corrosion of Mains, Services, and Meters.—Dr. S. F. Dufton and Prof. J. W. Cobb: Report of Institution Gas Research Fellowship: Some High Temperature Reactions of Toluene and Benzene.  
ROYAL HORTICULTURAL SOCIETY (at Royal Gardens, Chelsea), at 3.—Dr. E. J. Russell: Some Modern Aspects of Manuring.  
ROYAL INSTITUTION OF GREAT BRITAIN, at 3.—Major C. E. Inglis: The Evolution of Large Bridge Construction.  
ZOOLOGICAL SOCIETY OF LONDON, at 5.30.—Dr. G. M. Ververs: Report on the Entomozoa Collected from Animals which Died in the Gardens during the Past Nine Months.—Prof. R. T. Leiper: Exhibition: Experimental Transmission of some Helminth Infections.—Dr. W. T. Calman: Notes on Marine Wood-boring Animals, 1. The Shipworms (Teredinidae).—Dr. P. Chalmers Mitchell: Notes on an African Trip, with Lantern Illustrations.  
ROYAL PHOTOGRAPHIC SOCIETY OF GREAT BRITAIN (Technical Meeting), at 7.—C. P. Crowthor: Japanese *Mélange*, including Photographs and Examples of Japanese Crafts.  
ROYAL ANTHROPOLOGICAL INSTITUTE, at 8.15.—Dr. B. Malinowski: The Economic Pursuits of the Trobriand Islands.  
RÖNTGEN SOCIETY (at Medical Society of London), at 8.15.—(Annual General Meeting.)  
ROYAL SOCIETY OF MEDICINE (Psychiatry Section) (Annual General Meeting), at 8.30.—Dr. D. Forsyth: The Psycho-Analysis of a Case of Early Paranoid Dementia.

WEDNESDAY, JUNE 2.

INSTITUTION OF GAS ENGINEERS (at Institution of Mechanical Engineers), at 10.30 a.m.—Third Report of the Gas Investigation Committee.  
ROYAL HORTICULTURAL SOCIETY (at Royal Gardens, Chelsea), at 3.—Dr. A. B. Rendle: Plants of Interest in the Exhibition.  
SOCIETY OF PUBLIC ANALYSTS AND OTHER ANALYTICAL CHEMISTS (at Chemical Society), at 8.—R. Leitch Morris: Perchlorate Method for Potash; H. Droop Richtmyer: Estimation for Nitroglycerine.—E. K. Dovey: Apparatus for Evolution Methods of Analysis: An Improved Form of U-tube.

THURSDAY, JUNE 3.

INSTITUTION OF GAS ENGINEERS (at Institution of Mechanical Engineers), at 10.30 a.m.—Society of British Gas Industries: Carbonisation.—H. J.

Hodsman and Prof. J. W. Cobb: Oxygen in Gas Production.—J. Fisher: Electricity Supply by Gas Companies.—G. Warburton: Contemplations on the Report of the Fuel Research Board.

ROYAL HORTICULTURAL SOCIETY (at Royal Gardens, Chelsea), at 3.—Capt. H. J. Page: Green Manuring—Its Possibilities in Horticulture.

ROYAL INSTITUTION OF GREAT BRITAIN, at 3.—William Archer: Dreams with Special Reference to Psycho-Analysis.

ROYAL SOCIETY, at 4.30.—Sir Ernest Rutherford: The Nuclear Constitution of the Atom (Bakerian Lecture).

LINNEAN SOCIETY OF LONDON, at 5.—R. Swainson-Hall: Exhibition of 50 Drawings of the Oil-Palm, *Elaeis guineensis*.—A. Whitehead: Objects Observed near Basra during the War.—Prof. W. J. Dakin: Whaling in the Southern Ocean.—Dr. R. K. Gates: Demonstration of Chromosomes in the Pollen Development of Lettuce.

CHEMICAL SOCIETY, at 8.

ROYAL SOCIETY OF MEDICINE (Obstetrics and Gynecology Section), at 8.—Dr. P. Turner: Traumatic Rupture of the Pedicle of a Sub-Peritoneal Fibroid.—Dr. F. Andersen: A Case of Rupture of the Uterus.—Dr. F. Shaw and Dr. Burrows: Radical Cure of Advanced Carcinoma of the Cervix, made Possible by the Application of Radium.—G. Ley: The Pathology of Ante-Partum Haemorrhage.

FRIDAY, JUNE 4.

ROYAL SOCIETY OF ARTS (Indian and Colonial Sections, Joint Meeting), at 4.30.—Prof. Sir John Cadman: The Oil Resources of the British Empire.

ROYAL INSTITUTION OF GREAT BRITAIN, at 9.—Sir Ronald Ross: Science and Poetry.

SATURDAY, JUNE 5.

ROYAL INSTITUTION OF GREAT BRITAIN, at 3.—Dr. J. H. Jeans: The Theory of Quanta.

CONTENTS.

	PAGE
The University of London: A Great Opportunity	381
Manuals on Applied Chemistry	382
A Standard Book on Soils. By E. J. R.	384
Savages of the Far Past. By R. R. M.	384
The Problem of Clean and Safe Milk. By Prof. Sheridan Delépine	385
Our Bookshelf	386
Letters to the Editor:—	
Scientific Work: Its Spirit and Reward.—Dr. Gilbert J. Fowler	387
Applied Science and Industrial Research.—J. W. Williamson	387
A Rainbow Inside Out. (With Diagrams.)—C. O. Bartrum	388
“All-or-None” in the Auditory Nerve.—Dr. W. Perrett	390
British and Foreign Scientific Apparatus.—Douglas H. Baird	390
Mortlake as a Cause of River-windings.—Henry Bury	391
Science and the New Army.—C. S. Wright	391
Waage's Photochemical Synthesis of Phloroglucin from Glucose.—Dr. M. Nierenstein	391
The Development of British East Africa. (Illustrated.)	392
Weather Notes of Evelyn, Pepys, and Swift in Relation to British Climate. By Capt. C. J. P. Cave	393
Optical Instruments in Industry. (Illustrated.)	394
The British Sea Fisheries. (Illustrated.) By J. J. Notes	398
Our Astronomical Column:—	
Astronomical Announcements by Wireless Telegraphy	403
The Astrogaphic Catalogue	403
Tidal Friction and the Lunar and Solar Accelerations	403
The Iron and Steel Institute. By Prof. H. C. H. Carpenter, F.R.S.	403
The University of London: Government Offer of a Site	404
Genetic Studies of <i>Drosophila</i> . By Prof. L. Doncaster, F.R.S.	405
The Conservation of Fuel	406
Buddhism in the Pacific	407
Astronomy at Oxford during the War. By D. L. E.	407
The Alligator Pear	408
The Improvement of Grassland. By Dr. W. E. Brenchley	408
Leveling Errors. By H. G. L.	409
University and Educational Intelligence	409
Societies and Academies	410
Books Received	411
Diary of Societies	412



THURSDAY, JUNE 3, 1920.

*Editorial and Publishing Offices:*

MACMILLAN &amp; CO., LTD.,

ST. MARTIN'S STREET, LONDON, W.C.2.

Advertisements and business letters should be  
addressed to the Publishers.

Editorial communications to the Editor.

Telegraphic Address: PHUSIS, LONDON.

Telephone Number: GERRARD 8830.

### Present State of the Dye Industry.

ON the occasion of the annual general meeting of the British Dyestuffs Corporation held on May 21 Sir Henry Birchenough, who has succeeded Lord Moulton as chairman of the company, emphasised the importance of a great dye-making industry as an instrument of national defence, pointing out that practically the whole of the poison gases used by the German Army in the war were made in the establishments of the German dye manufacturers, as well as large quantities of high explosives and synthetic nitric acid. Chemical warfare, in any future conflict, will no doubt be greatly extended, and its successful prosecution will depend on the equipment, skill, and experience of the dyestuff industry.

Scarcely less important is it in peace, for, as the chairman explained, "the group of textile trades of this country constitute the most striking and important single group of allied industries in the civilised world," and "the magnitude and very existence of a very large part of our export trade in textiles depend absolutely upon there being . . . a sufficient supply of dyestuffs available."

What is being done to establish a great dyestuff industry in this country? There is no doubt that progress has been very considerable, and it is a remarkable fact that the output of dyes in this country (given by the Board of Trade as 25,000 tons annually) exceeds the total consumption before the war.

The range and variety of these dyes are, however, admittedly limited, and, indeed, Mr. A. Hoegger, chairman of the British Cotton and Wool Dyers' Association, at the annual meeting

held on the same day as the above, stated that, had it not been for the importation of certain Swiss dyes during the war, and the arrival recently of certain "reparation" colours from Germany, some of the branches of the association would have been seriously embarrassed.

There are two rather important points that require comment here. Sir Henry Birchenough stated that "an unprecedented demand for finished dyestuffs prevents the creation of stocks, and thereby places difficulties in the way of the maintenance of uniformity in our products." This is no doubt a reply to complaints as to lack of uniformity in the dyes supplied. There are two ways in which this can occur, viz. as regards shade and as regards strength.

If the preparation of a dye has been properly worked out in the laboratory and in the small-scale plant (such as exists at Huddersfield), the large-scale manufacture should present few difficulties. Granted that the first few batches may leave something to be desired, succeeding batches made under careful scientific control should certainly be very close to the standard required, and the stock necessary to allow this difference to be adjusted should not be more than three or four batches—say a ton at the utmost. With regard to the strength of the dye sent out, Mr. Hoegger states that a great proportion of the 25,000 tons is not so highly concentrated as were pre-war German colours. Almost every dye coming from the drying chamber is stronger than the standard, even taking as standard the German pre-war dye, and it is exceedingly bad policy to reduce the strength below it. This cannot be other than deliberate, and is very objectionable, as the quality of the dye is thereby depreciated in the mind of the user, and in this connection there is evidence that the Canadians are not altogether satisfied with the quality of the dyes imported from this country.

"Why," it will be asked, "cannot we make here those dyes which are being imported from Switzerland and vicariously obtained from Germany?" The answer to this question is: First, lack of plant; and secondly, lack of raw material. The former is referred to by Sir Henry Birchenough, who points out the great delay in delivery of plant owing largely to the moulders' strike. The provision of the multitudinous variety of pans, autoclaves, and acid-resisting vessels required by the industry is proceeding only slowly, and especially is this true of enamelled appliances. Even

the refuse of the engineering shops, iron borings, was no longer forthcoming during this strike, with the consequence that the manufacture of aniline was seriously retarded.

How the lack of special plant prevents the supply of certain dyes is well illustrated in the case of rhodamine. The intermediate products required for this are diethyl-*m*-aminophenol and phthalic anhydride. The former is prepared from diethylaniline, for which, unlike dimethylaniline, enamelled autoclaves are required, and the latter requires special plant for the oxidation of naphthalene by means of a mercury catalyst. Although indigotin is no longer prepared by the Badische process from phthalic anhydride, the importance of this intermediate is still great, and as the English rights of the new process of the American Bureau of Chemistry, oxidation in the vapour phase in the presence of a catalyst, have already been purchased, it may be expected that this product will soon be manufactured here at a comparatively very low cost. It will readily be understood that, in view of the necessity of installing two special plants for the intermediates required, manufacturers both in England and in America have not succeeded in placing anything but insignificant amounts on the market.

With regard to the provision of other intermediate products there is still much to do, and at the present time the demands for such elementary materials as aniline and  $\beta$ -naphthol greatly exceed the supply. The latter is required for the manufacture of such important intermediates as *y* acid and *J* acid, and when it is considered that  $\beta$ -naphthol was not made in England at the outbreak of war, it will be realised that it is necessarily a slow operation to produce these acids, involving as it does three distinct plants.

It must not, however, be concluded that British manufacturers have confined themselves to the dyes which are made with least trouble. The Solway Dyes Co., in particular, was first in the field with a range of important vat dyes, and this firm, as well as the British Dyestuffs Corporation and others, has placed a useful series of fast dyes on the market. The erection of a large works in Trafford Park, Manchester, by the British Alizarine Co. must lead to a greatly increased output of alizarine dyes, and there is little doubt that slow but steady progress is being made. The time should not be far distant when British manufacturers will not only supply all requirements for the home market, but also make their products known all over the world.

### Poetry and Medicine.

*Philosophies.* By Sir Ronald Ross. Pp. viii + 56. (London: John Murray, 1911.) Price 2s. net.  
*Psychologies.* 69 pp. (Same author and publisher, 1919.) Price 2s. 6d. net.

THESE slender volumes, by Sir Ronald Ross, deserve to be read with sympathetic interest for more reasons than one—not least because they reflect the mind, and throw light on the spirit which has guided the work, of a man whose services to medical science are great indeed. In the long history of medicine and of poetry we can call to mind many a physician who has been also a poet. No great physician has ever likewise been that rare and wonderful thing, a great poet, for the toilsome life of the one is not to be combined with the fine freedom, the careless rapture of the other. But there is a certain excellence which, though it fall far short of supreme perfection, is still a very fine and splendid thing, and to such excellence I think Sir Ronald Ross has certainly attained.

The poet-physicians whose names first cross our minds are men attached by but a slender link, a titular claim, to the profession of medicine; nevertheless, the profession is proud to have had enrolled among its brotherhood Dr. Oliver Goldsmith and the great apothecary whom a foolish critic bade "go back to his gallipots." In Goldsmith's footsteps follows Crabbe, bringing us his "Village" and his "Parish Register," bidding us, in lines scarcely less finished and less memorable than Goldsmith's own, "Behold the Cot, where thrives th' industrious swain, Source of his pride, his pleasure and his gain . . ."; or, moving quickly to sadder themes, "When the sad tenant weeps from door to door, And begs a poor protection from the poor." A little shred of Keats' great mantle (and more perhaps of Shelley's) fell upon that fine poet, and not unlearned physician, Thomas Lovell Beddoes, the friend of Blumenbach and Schoenlien and Frey—Beddoes of "The Bride's Tragedy." "Death is more a jest than life; you see Contempt grows quick from familiarity. I owe this wisdom to Anatomy"—so he wrote from Göttingen while he was a student of medicine there; and the same contemptuous familiarity lasted him to the end, when he used his physiological knowledge of a new and terrible drug—curare—to "creep into his worm-hole," to introduce him to that grim pageantry of Death which his verse had described with a fearful reality. "The power of the man," said Browning, "was incontestable and immense"; and in his happy hours he had written very lovely and most

musical things. The song about "How many times do I love thee, dear?" is not to be forgotten; nor do those who have read it ever forget his exquisite "Dream-pedlary"—"If there were dreams to sell, What would you buy?"

To another order of poets belongs a little cluster of seventeenth- and eighteenth-century physicians, Garth and Akenside and John Armstrong and Erasmus Darwin. They are of that quiet, humourless, didactic school for which we have lost our relish, and for which Dr. Johnson (apart from his bitter quarrel with the last, the Lichfield, physician) had all too kindly a word.

We no longer read Garth's "Dispensary," any more than we read his once celebrated Harveian oration, although the poem was "on the side of charity against the intrigues of interest, and of regular learning against licentious usurpation of medical authority." In other words, it was a pedantic account of a quarrel between the College of Physicians and the Society of Apothecaries. "It appears," says Johnson, "to want something of poetical ardour, and something of general delectation"—a fair and honest verdict, which we might illustrate and support by any stray line or two—by those, for instance, where the poet describes "Why bilious juice a golden light puts on, And floods of chyle in silver currents run; How the dim speck of entity began T' expand its recent form and stretch to Man."

Akenside was a much better poet, and seems also to have been a more learned physician. His "Discourse on the Dysentery" "entitled him to the same height of place among the scholars as he possessed before among the wits"; and "The Pleasures of the Imagination" is still worth our while to read, if it be only for some few noble and exalted passages. We may lay it down, as Pope did, with the feeling that "this is no everyday writer!" There runs through it a sincere and almost prophetic belief in the value of research and the progress of science—in "Science herself . . . the substitute Of God's own wisdom in this toilsome world, The Providence of Man." Of Armstrong, who contributed some "medical stanzas" to "The Castle of Indolence," and wrote his "Art of Pursuing Health" in indolent Thomsonian verse, we need scarcely speak. He was admired in an age by no means devoid of polished culture, but content to read and even eager to buy such dreary, sluggish blank verse as "Hail sacred flood, May still thy hospitable swains be blessed In rural innocence," and so on, to the end of the quarto volume.

Erasmus Darwin's "Botanic Garden" and "Loves of the Plants" have merits of their own,

and an historic interest not to be gainsaid; but in his poetry there is a *je ne sais quoi qui manque*, though it was wont at one time to be spoken of in the same breath with Cowper's "Task," and even with "Paradise Lost." They are the most didactic of didactic poems. The good doctor revels in facts, in the communication of knowledge, or rather of information. The world is ransacked for objects of wonder and contemplation. As his biographer, Miss Anna Seward, tells us, "the operations of the weather-glass and air-pump are described with philosophic accuracy and poetic elegance." There is "a grand picture, though of somewhat forced introduction," of the crocodile bursting from its egg on the banks of the Nile. The embryo plant is introduced to us by "Lo! on each seed, within the tender rind, Life's golden threads in endless circles wind, etc." We turn the page and come to "where the humming-bird, in Chili's bowers, On fluttering pinions robs the pendent flowers; Seeks where fine pores their dulcet balms distil, And sucks the treasures with proboscis bill." The sinuous track of the serpent glides, with no apparent reluctance, into "So, with strong arm, immortal Brindley leads His long canals, and parts the velvet meads." Yet the simple mind of this old poet-physician, utterly destitute of humour or romance, had (as we all know) a vast deal of wisdom commingled with its simplicity.

In our own day, or within our immediate recollection, there have been many members of the medical profession who could put on their singing robes once in a way, and write creditable verse or sing still better convivial songs. There was a whole brotherhood of them in Edinburgh a generation ago, with such men as Douglas Maclagan and Andrew Wood and James Sidey and J. D. Gillespie and John Smith, who touched art with the humour, and now and then with the pathos, of their post-prandial lyrics. But we had better not pause over the "Nugæ Canoræ Medicæ," or "Mistura Curiosa," or "Alter Ejusdem"—certainly not over that triumphant outburst of "old Sidey's" hilarious conviviality, "The Cat's got the measles and it's deid, puir thing!" scarcely even over the soft lowland accent and the tender lilt of "The burnie that wins to the sea"—"Up near the scaur where the hoodie-craw bides, Up near the foot of the keelie-craighie, Deep in the hidie-heugh, riv'd frae its sides, Rises the burnie that wins to the sea." In the same town of Edinburgh we had very lately the Cornishman, Ricardo Stephens, another poet-physician, writer of strange ballads and dreamer of rich, imaginative dreams. It was he who

wrote "The Piper of Hell"—"O have ye heard of Angus Blair, Who lived long since in black Auchmair?" and a more terrible and cruel ballad still—"Who hath not met Witch Margaret? Red gold her rippling hair. . . . Come up and you shall see her yet, Before she groweth still; Before her cloak of flame and smoke The winter air shall fill; For they must burn Witch Margaret Upon the Castle Hill."

Together with these Edinburgh worthies we may say a passing word of two Dublin physicians of the last generation, George Sigerson and John Todhunter. They were both of them fervid writers of Celtic poetry, and have a notable place in their country's undoubted literary renaissance. Irish patriotism inspired them both, in a way that we little understand—as when Todhunter cries out "O thou Swan among the nations, enchanted long, so long That the story of thy glory is a half-forgotten song." He was a powerful and influential singer, a true Irish Tyrtaeus; for it was he who wrote "There's a spirit in the air, Says the Shan Van Vocht"; just as another learned brother-scholar and fellow of Trinity College, Dublin (not a physician, however), boldly sang: "Who fears to speak of '98?" and sang it to only too receptive ears.

But I have gone farther afield than I ever meant to go, and I have left myself all too little room to write of Sir Ronald Ross, the last of our poet-physicians. Most of his poetry was written in India, in Madras or Burma or the Andamans, while he was engrossed in the study of the pathology of malaria, and during earlier years when he began to think and dream over the eternal problems of the East. Sir Ronald's love and reverence for science, and his admiration for those who have shown and followed the way of discovery, are deeper because far more experienced than Akenside's: "Tho' we may never reach the peak, God gave this great commandment, Seek."

It is not the wealth and splendour of the East that touch his imagination; but, looking with the physician's charitable eyes, he broods over the decadence, the misery, the widespread sickness of its people: "The leprous beggars totter trembling past, The baser sultans sleep." A famine-stricken girl is suckling her three-year-old: "'I am too poor,' she said, 'To feed him otherwise,' and with a kiss Fell back and died." It is all a gloomy picture. But if its blackness be somewhat overdrawn (and I hope and think it is) its pessimism is inspired and redeemed by charity and pity, by resolution to understand, and

by ambition to relieve. Sir Ronald's second volume, though tragic enough, is in a happier strain.

Only a few days ago, lecturing to my class of some eighty young men and women newly entered a week before upon their medical course, I tried to tell them what the Protozoa meant to our fathers, and what (thanks 'to Pasteur and Grassi and Manson and Bruce and Ross and many another) they have come to mean to us. In my student-days, an Amoeba, a bell or slipper animalcule, a little ooze from the Atlantic, a few pretty radiolarian or foraminiferal shells, gave us our outline-concept of the Protozoa. To-day a new world is opened, in which we hear of tiny things with strange life-histories, of momentous chains of cause and consequence wherein rat and louse and gadfly and mosquito play their insidious part, bringing fever to the swamp and murrain to the plain; we are told at last of mysterious maladies explained, of epidemics held at bay, of territories and peoples emancipated from disease. And then, as an example of the spirit of the scientific physician, of aims conceived, of dreams come true, I ventured to read them a couple of Ronald Ross's early verses, written before he and his fellow-workers had brought their hopes to fruition:—

In this, O Nature, yield, I pray, to me.

I pace and pace, and think and think, and take  
The fever'd hands, and note down all I see,

That some dim, distant light may haply break.

The painful faces ask, Can we not cure?

We answer, No, not yet; we seek the laws.

O God, reveal thro' all this thing obscure

The unseen, small, but million-murdering cause.

My students listened and went quietly away, and I could see by their faces that they had heard the words of the poet and the physician as though he were speaking straight to them.

D'ARCY W. THOMPSON.

### Movements of Plants.

*Transactions of the Bose Research Institute, Calcutta.* Vol. ii., *Life Movements in Plants.* By Sir Jagadis Chunder Bose. Pp. v + xiv + 253-597. (Calcutta: The Bose Research Institute, 1919.) Price 10s. 6d.

**I**n this the second volume of the *Transactions* of the Bose Institute, Sir Jagadis Bose continues to pour out his almost overwhelming wealth of observations. The first chapter of the volume deals with a piece of apparatus to be used with

the "high magnification crescograph" which magnifies the rate of growth up to ten million times. As, even with much lower magnifications, the spot of light or point of the lever would soon move off the scale or recording surface, the author has devised a method of balance different from the optical method originally used. In this new method the plant-holder is connected with a series of gear-wheels driven by a falling weight and controlled by a fan governor. By this means the plant-holder can be made to fall at various rates, and thus the growth of the plant is compensated, and we have what is termed the "balanced crescograph." When the rate of growth is exactly balanced the record will show a horizontal line, and any increase or decrease in the rate will be indicated by a rise or fall in the curve. By this means it is claimed that a change in the rate of growth of only 1 part in 27,000 can be detected. The method is one of great delicacy, it is clear, but, in view of the fact that the control of the speed of movement is in part frictional resistance, and also of the effect of grit and of inequality in the cutting of the gear-wheels, one would have liked to see the inclusion of a record which would demonstrate that a speed of  $0.5 \mu$  per sec. was kept constant to 1 part in 25,000 for many hours.

The volume contains thirty chapters on various plant reactions which exhibit themselves either by movements or by electrical response. Of these perhaps the most striking is the interesting contribution which the author makes to the problem of the mechanism of geotropic response. In the statolith theory of geotropism one link in the chain of reactions which bring about geotropic curvature is the shifting, under the influence of gravity, of comparatively large starch grains in a tissue such as the endodermis of the stem. This theory is upheld by the author as a result of the exploration of the plant by means of his "electric probe." The probe consists of a fine glass tube (0.15 mm. diam.) with a still finer platinum wire fused into, and projecting just beyond, it. The probe can be pushed into the tissues of a stem, while the other end of the platinum wire is connected with one terminal of a galvanometer, the other terminal being connected with some other part of the plant, e.g. a leaf, which is always kept horizontal. The probe is first placed on the surface of the organ, and the deflection is observed when the stem is placed horizontal; the stem is then returned to the vertical position, the probe advanced a little into the tissues, the stem again placed horizontal and the deflection observed. It is found that as the probe penetrates the deflec-

tion rises to a maximum and then falls to a minimum at about the centre of the stem. *The point of the probe in the position of maximum deflection is found to lie in the endodermis.* If the probe is carried forward towards the other side of the stem, a new maximum is found when the point reaches the endodermal layer on the other side, *but the deflection is in the opposite direction.*

This observation does not, of course, prove that the endodermis is the geo-perceptive layer, but it provides circumstantial evidence in favour of that view, since it demonstrates that the endodermis is the only tissue exhibiting a marked electrical reaction to geotropic stimulus. In one case where the angle of the stem was gradually increased there was no deflection until a critical angle of about  $33^\circ$  was reached, but above this there was a marked electrical response. There appears to be some frictional resistance to the displacement of the starch grains, which is not overcome until the critical angle is passed. By comparing the electrical response (which can, of course, be observed without the use of the "probe") of organs placed at angles of  $90^\circ$  and  $45^\circ$ , respectively, with the vertical, evidence is obtained in support of the view that the geotropic response is proportional to the sine of the angle.

The marked effect of temperature on the degree of geotropic response, which leads to decided diurnal movements of many stems, is a thesis which is further elaborated in this volume, as is also the difference between "direct" and "indirect" stimulation. The volume is filled with numerous and often stimulating observations carried out with the author's well-known mastery of the technique of experimentation. One must be grateful for the new weapons which he has forged and for the new fields of work which he has opened up, but, like Sir J. C. Bose's previous volumes, the present one is often sadly lacking on the plant-physiological side. The work done is never properly related to that of previous investigators, the author confining himself to the quotation of text-books, which are often of no very recent date; in dealing with phototropism the work even of Blaauw is not mentioned. Again, Sir J. C. Bose seems so anxious to add to his collection of "plant-records" that he passes rapidly from observation to observation and from problem to problem, shedding on the way a beam of light into some of the dark places of plant physiology, but never satisfying us with a problem fully envisaged and worked out.

V. H. B.

### Applications of Electricity.

- (1) *Telephonic Transmission: Theoretical and Applied.* By J. G. Hill. (Manuals of Telegraph and Telephone Engineering.) Pp. xvi+398. (London: Longmans, Green, and Co., 1920.) Price 21s. net.
- (2) *The Principles of Electrical Engineering and their Application.* By G. Kapp. Vol. ii., *Application.* Pp. viii+388. (London: Edward Arnold, 1919.) Price 18s. net.

(1) **T**HE applications of electricity in the telegraph and telephone services are now so numerous and so highly specialised that no one can claim to have an expert knowledge of every branch. It has been decided, therefore, to produce a series of handbooks which will cover the whole of the ground involved. The editor of the series is Sir William Slingo, late engineer-in-chief of the Post Office, and most of the authors are on the staff of the Engineering Department. Judging from the present volume and from the names of the authors preparing the other volumes of the series, we shall soon have a very complete and thorough account of English telegraphic and telephonic practice.

This book is written for experts engaged in the practical applications of telephony, and must be judged from this point of view. It is now ancient history how the early telephonists did their best to diminish the capacity and resistance of their lines with the object of securing good communication. In 1887 Oliver Heaviside pointed out that this rule was quite fallacious. The two qualities of the line which it is necessary to study are the attenuation of the signals and the velocity with which they are propagated. Heaviside stated this clearly and showed that his "distortionless" circuit gave the complete solution of the problem. In 1900 Prof. Pupin showed how a distortionless circuit might be secured very approximately by putting inductance coils at certain intervals in the line. When the distance between the coils is small there will be little reflection of the waves by them, and in this case the practical working will be satisfactory.

There are many engineers employed in telephone work who have great difficulty in following the advanced mathematical reasoning of Heaviside and Pupin, and yet they have to evaluate their complicated formulæ in everyday work. For their benefit the author introduces additional chapters describing the transmission of direct currents along a leaky line and getting the equivalent circuits. This should give those engineers confidence to attack the complete mathematical problem which is given in appendices.

NO. 2640, VOL. 105]

The symbols and general arrangement of the formulæ are mostly those used by Kennelly and Fleming, whose work is much appreciated by the British Post Office. To the general man of science most of the book will appear to be endless variations of complicated formulæ, involving complex variables, deduced from comparatively simple differential equations. But a study of the book will show him how laborious it is to get numerical solutions, and how ingenious are some of the methods employed to get the constants of the line. The chapter on "the human voice in telephony" is illustrated by excellent oscillograms of the alternating currents produced by certain words. There is also a chapter on the thermionic valve as a telephonic relay which is of great interest. Very instructive characteristic curves of the valve are shown. A curve is also given which proves the enormous variation of magnification with input. The use of these telephonic relays is most promising, and great developments may shortly take place.

The book will be of great value to the telephonic engineers for whom it is written. We were much interested in the electrical constants of many of the cables used in practice which have been calculated by the author. They prove conclusively the great value of advanced mathematical theory in telegraphy and telephony.

(2) As a pioneer of the applications of electricity Prof. Kapp has had the pleasure of seeing many of his theorems become incorporated in the routine teaching of technical colleges and many of his methods widely adopted in everyday practice. The technical student, therefore, will find much that is familiar in this volume; but he will also find that the proofs given in many cases have been appreciably simplified. The author invariably keeps practical considerations in the foreground and rarely, if ever, digresses on points of abstruse theory. In discussing the running of machines he makes little endeavour to elaborate the theory, but gives, in most cases, a clear first approximate solution. The book, therefore, will be welcomed by the engineer and the student. The former will gain a clearer view of the principles on which his machines work, and the latter will find that many long mathematical solutions can be much shortened by elementary graphical methods.

In the earlier chapters direct-current machinery is described. The treatment of the critical speed of turbo-dynamos is very neat, and the results agree with experiment. Little space is given to losses which are relatively unimportant—bearing friction, for instance. The methods of coupling dynamos for parallel running are fully described.

A clear description of the Thury system of direct-current high-tension transmission is given. There seems to be little chance, however, of this system being adopted on a large scale in this country. Chap. v. describes the uses of a storage battery in connection with a dynamo. Brief descriptions of the various types of booster used in this connection are given and will be helpful to the student.

In chap. vii. a brief reference is made to Fourier's theorem. The coefficients are obtained by drawing the graphs of curves the equations of which are of the form

$$y = f(x) \cos(2\pi nx/\lambda),$$

and then getting their area by the planimeter. Although theoretically correct, we think that the method would prove laborious in practice. We think also that the error for high harmonics would probably be large, as the planimeter reading gives the difference between many areas.

The author suggests that large choking coils should be constructed in the form of a toroid, the diameter of the circular cross-section of which equals  $0.311D$ , where  $D$  is the mean diameter of the toroid. This is Maxwell's solution for the most economical coil; and the author has found practically that the expression  $0.35n^2D$  gives its inductance, where  $n$  is the number of turns. This is in good agreement with Maxwell's formula,  $3\pi n^2D$ —i.e.  $9.43n^2D$ . It has to be remembered, however, that Maxwell's formula is only a rough approximation. If we use Rayleigh's formula we get  $0.69n^2D$  for the inductance. The 4 per cent. difference between theory and experiment is probably due to the assumption that the current is uniform all over the cross-section of the toroid. If we use Rayleigh's formula it will be found that we get very appreciably different dimensions for the most economical choking coil.

The discussions of parallel running, transformers, converters, and induction and commutator motors are all instructive and suggestive. The last chapter, on phase advancers, is a strong and convincing plea for their more general adoption in practice. Considerable economies can be effected by their use.

A. RUSSELL.

### British Iron Ores.

*The Iron Ores of Scotland.* By M. Macgregor, Dr. G. W. Lee, and G. V. Wilson. With contributions by T. Robertson and J. S. Flett. (Memoirs of the Geological Survey, Scotland: Special Reports on the Mineral Resources of Great Britain: Vol. xi. *Iron Ores (continued).*)

Pp. vii + 240. (Edinburgh: H.M.S.O.; Southampton: Ordnance Survey Office.) Price 10s. net.

THE present volume forms a continuation of the important series of memoirs on the iron ores of Great Britain which the Geological Survey has been issuing for some time past. Unlike some of the previous ones, the subject here discussed affords little scope for original geological investigations, the principal deposits of iron ore being very well known and having often been described. As is, however, very truly remarked by Sir Aubrey Strahan, the information concerning them is scattered throughout a large number of publications, and it is a great advantage to the student of the subject to have it all brought together in one volume. The authors have done their work carefully and painstakingly, and the result of their labours has been to render available a very complete and minutely accurate record of the known Scottish iron-ore deposits.

The book is divided into seven chapters. The first gives an introductory and historical account of the subject, containing much interesting matter; attention should, however, be directed to a mistake as to the nature of the old Catalan furnace. The author writes: "These furnaces were of the Catalan type, . . . and castings were apparently made direct from the furnace itself." These two statements are incompatible, for the essential feature of the Catalan process was that it produced malleable iron, and not cast iron, direct from the ore.

The next four chapters are devoted to the bedded iron ores of Carboniferous age, these being subdivided mainly according to their geographical distribution. In a sixth chapter the bedded Raasay ironstone of Jurassic age is described, and in the last chapter a number of minor occurrences, which are grouped together under the heading "Hæmatite in Veins and Beds"—a somewhat infelicitous title, seeing that true hæmatite is conspicuous by its absence.

As in the previous volumes of the series, the least satisfactory portion of the present one is that relating to the estimated tonnage of ore reserves. It ought to be made thoroughly clear that the tonnage of ore as estimated by a geologist represents a quantity many times greater than that which the miner can hope to recover in actual practice. The iron industry of Scotland requires some  $2\frac{1}{2}$  million tons of ore annually, about one-fifth of which is obtained from native Scottish deposits, and it is poor consolation to the Scottish ironmaster, who for a good many years past has

been in the greatest difficulty to know whence to draw his ore supplies, to be informed officially that the probable reserves are more than 94 million and the possible reserves more than 435 million tons, he meanwhile knowing but too well that only a very small fraction of even the smaller figure is ever likely to find its way to his furnaces. H. LOUIS.

### Our Bookshelf.

*Practical Pharmacology: For the Use of Students of Medicine.* By Prof. W. E. Dixon. Pp. viii+88. (Cambridge: At the University Press, 1920.) Price 7s. 6d. net.

We welcome the appearance of Prof. Dixon's manual; it is certainly the most practical and useful guide to students of experimental pharmacology which we know. The experiments are extremely well chosen to illustrate the underlying principles of therapeutics, and the text, with its illustrations and tables, is so clear and logical that a student can at no time be in doubt as to the methods for performing the experiments, or fail to appreciate their bearing on the practical application of the drugs in disease.

The experiments, some seventy-eight in number, are classified to explain the action of drugs on the various systems of the body, and while use is made mainly of the pithed frog, suitable experiments with mammalian tissues are introduced. Experiments with decerebrated mammals are not described, the author considering that their use in large classes is impracticable and that they may be replaced by suitable demonstrations under Certificate C. A chapter is devoted to a description of the essential physical properties of important drugs, and there is appended a useful table of the doses required to produce typical pharmacological effects in animals.

We have no hesitation in recommending this book as an excellent guide to the study of practical pharmacology. It is one which will be extremely useful to students of medicine, whether they are receiving experimental tuition in the laboratory or not, and it will also be read with much profit by medical men who have not had the advantages of a practical training in the action of drugs.

*The Teaching of Science in the Elementary School.* By Gilbert H. Trafton. (Riverside Text-books in Education.) Pp. x+293. (New York: Houghton Mifflin Co.; London: Constable and Co., Ltd., 1918.) Price 6s. 6d. net.

In a brief introduction Prof. Cubberley states that the author's aim was "to construct a simple and helpful volume for the teacher who is called upon to teach elementary science lessons, and yet has neither scientific training nor apparatus for the work." The statement prepares the reader for the limitations of the book. Mr. Trafton's scheme includes practically no chemistry, and the physics is both exiguous and scrappy; by far the

greatest part consists of simple observational work upon plants and animals. Within these limitations, however, there is much that is both attractive and useful, and the limitations themselves correspond to those of most rural elementary schools in this country.

Mr. Trafton classifies his subject-matter under the headings of biological, agricultural, physical, and hygienic science, and rightly insists that, however rudimentary the work along these lines may be, it should be done in the genuine scientific spirit. In his introductory chapters he gives a good deal of sound and practical advice with regard to the choice of subject-matter and the methods of teaching, and the bulk of the book consists of sections in which typical parts of the curriculum he recommends are worked out in detail. The curriculum is, of course, chosen with reference to American conditions, but the English teacher should be able to profit by Mr. Trafton's suggestions. There is a carefully compiled bibliography, covering practically the whole field treated in the book, but consisting entirely of American titles.

*Peoples of the Philippines.* By Prof. A. L. Kroeber. (American Museum of Natural History: Handbook Series No. 8.) Pp. 224. (New York: American Museum of Natural History, 1919.)

The interest of the Philippine Islands to the ethnographer lies in the fact that they are the largest of the possessions of the United States, and the only one of importance in the Eastern hemisphere; that they form a considerable and growing nationality; and that they display in an unusually complete manner the stratification of races and cultures. Three types of race can be identified in the present population, and these may be arranged in the probable order of their arrival—the Negritos of the interior, a short, black people with an elementary type of religion and culture; the Indonesians, of the Mongoloid family, but presenting fewer specific Mongoloid features than the third race, the Malaysians, occupying the coastal areas. As regards culture, the remarkable fact is the predominance of Indian influence as compared with that of China, which provided little more than certain manufactured products. India did not furnish the Filipinos with a definitely crystallised religious cult, or, if so, this cult had already disappeared before the Europeans appeared on the scene. But there came from the Indian races, probably by Malay intervention, a mass of religious practices, ideas, and names, a considerable body of Sanskrit words, a system of writing, the art of metallurgy, a vast amount of mechanical and industrial knowledge, and unquestionably a much higher degree of civilisation than their predecessors had acquired. These facts are clearly brought out in the present handbook, which provides in small space much information, and is furnished with good maps and illustrations.



Letters to the Editor.

[The Editor does not hold himself responsible for opinions expressed by his correspondents. Neither can he undertake to return, or to correspond with the writers of, rejected manuscripts intended for this or any other part of NATURE. No notice is taken of anonymous communications.]

The Flight of Flying-fish.

It is disputed whether the flight of flying-fish is a genuine flight or simply a leap and a glide. The question is referred to in the section devoted to flying-fish in the Natural History Museum, South Kensington. Recently I have had ample opportunity to study these fish in the tropical waters of the Atlantic and Pacific Oceans.

The observations which I have made and the conclusions at which I have arrived are corroborated by the officers of the R.M.S. *Victoria*. Many of these gentlemen were surprised to hear that there was any doubt on the matter. That the flight is a genuine one is proved by the following facts:—

(1) During flight these fish are able to turn at right angles, and even at a very acute angle. More than once I have seen a fish turn with great rapidity at an acute angle and come back in a direction opposite to the direction in which it set out. A mere glide will not enable any animal to do this.

(2) Standing at the bow of the ship directly above some flying-fish which were in a hurry to get out of the way, I saw the wings flap as distinctly as the wings of any frightened bird.

(3) Some of these fish fly for a distance of from 150 to 200 yards without rising more than a couple of feet above the surface. They rise over the crests of the waves and sink into the hollows. They could not do this by a mere leap and a glide.

(4) Besides flying low over the surface of the waters, they are also able to rise to a considerable height, and not infrequently come on board large steamers. When they fall on deck their wings can be seen, as well as heard, flapping. It is true that they are unable to rise from the deck, but the same is true of many sea-birds.

(5) When in full flight the outlines of the wings are indistinct and blurred in contrast with the clear outline of the body. This can only be due to the very rapid movement, as in the case of hovering flies and humming-birds.

J. McNAMARA.

3 Holland Road, Kensington, W.

An Experiment on the Spectrum.

In school and college courses little experimental work is done on the infra-red and ultra-violet parts of the spectrum. The student is, of course, told about these regions, and how they can be detected respectively by the heating and actinic properties of their rays. But he is not allowed to investigate these rays himself, nor are their properties demonstrated before him. This is on account of the elaborate nature of the apparatus necessary; the infra-red region requires a thermopile or bolometer, together with an expensive galvanometer, and the ultra-violet requires photographic methods and a spectrograph. So much apparatus cannot be afforded for one experiment, and besides is apt to distract the student's attention from the simple nature of the facts involved.

If, however, a very intense spectrum is used, the infra-red can be mapped roughly with an ordinary thermometer, and the ultra-violet with a photographic exposure-meter. Neither galvanometer nor spectrograph is necessary. The thermometer I have used is

a Fahrenheit one, range 0° to 220°, the bulb of which is blackened by dipping it into lamp-black shaken up with methylated spirits; the bulb is 5 mm. in diameter. The exposure-meter is the Imperial exposure-meter for dull light and interiors, which costs 1s. 6d. together with a refill. In this instrument a piece of sensitive paper is exposed to the light, and the time noted that it takes to darken to a standard tint. The sensitive paper supplied darkens two or three times as fast as ordinary P.O.P. As source of light I have used a little 5-ampere arc lamp, which is run off the lighting circuit through a rheostat. The anode is horizontal and the cathode vertical; they are both enclosed in a glass cylinder which restricts the supply of oxygen, and so lengthens the life of the carbons. Lamps of this pattern burn very steadily, and have come into wide use during the past ten years. It is because so many laboratories have these lamps that I describe this experiment here. An arc of this pattern is absolutely necessary; a pointolite or half-watt lamp is of no use for the purpose.

As lens I have used a spectacle lens of 25 cm. focal length, and as prism a single equilateral dense flint 1½ in. high. The spectrum and arc are equidistant from the lens. As slit I have used the crater of the arc, which measures about 3 mm. in diameter, since the carbons in this type of lamp are only 5 mm. thick. If the rays of light from the anode fell squarely on the lens we should have a point image of a point source, and the spectrum would be only 3 mm. high, but by setting the lens obliquely, rotating it through 30°, an astigmatic line image is formed, and we get a reasonably sharp spectrum 12 mm. high. Stray light is excluded by enclosing the arc in a box.

The following table gives a set of results taken in somewhat less than an hour:

Scale cm.	Colour	Rise of temperature ° F.	Photographic action
7.0 ...	—	... 0.0 ...	—
7.5 ...	—	... 0.8 ...	—
8.0 ...	—	... 3.4 ...	—
8.5 ...	—	... 5.4 ...	—
9.0 ...	Infra-red	... 3.4 ...	—
9.5 ...	Red	... 2.0 ...	—
10.0 ...	Yellow	... 0.5 ...	0.5
10.5 ...	Green	... — ...	2.7
11.0 ...	Blue	... — ...	1.5
11.5 ...	Violet	... — ...	2.4
12.0 ...	End of visible	... — ...	5.0
12.5 ...	Ultra-violet	... — ...	5.0
13.0 ...	—	... — ...	0.57

The ends of the visible spectrum were at 9.2 and 12 cm. The first column gives the readings on a centimetre scale placed along the spectrum, the second column the name of the colour, the third the rise of temperature experienced by the thermometer in three minutes, and the fourth the reciprocal of the time in minutes taken by the paper to darken to the standard tint. In the case of the last two readings the exposure-meter was illuminated by stray light. It is possible to go further into the ultra-violet if a crown glass prism is used. The infra-red measured goes to 2.2μ or thereabouts. If a piece of P.O.P. is exposed to the spectrum for a couple of minutes, it shows bands—one from 10–11 cm., another from 11.3–11.7 cm., and a third from 11.8–12.7 cm., the positions all being measured on the centimetre scale above referred to.

It is interesting to remember that when Sir William Herschel discovered the heat spectrum in 1800 he used thermometers. The source of light was the sun, and the arrangement was similar to Newton's original one—the prism was placed close up to a slit at a window, no lenses were used, and the spectrum

was consequently very impure. Three thermometers were placed apparently at a distance of about 4 ft. or 5 ft. from the prism—one in the spectrum, and the other two in the shadow beside it—and the difference of temperature produced by the rays was noted. The bulbs of the thermometers were blackened; one of them measured  $\frac{1}{4}$  in. in diameter, but the others were smaller. One and a half inches beyond the red there was a rise of  $3\frac{3}{4}^{\circ}$  in 10 min., 1 in. beyond the red  $5\frac{1}{4}^{\circ}$  in 13 min., and  $\frac{1}{2}$  in. beyond the red  $6\frac{3}{4}^{\circ}$  in 10 min. In the violet there was a rise of  $1^{\circ}$  in 15 min. The spectrum was about 3 in. long, and the heat rays could be detected a distance of  $2\frac{1}{4}$  in. into the infra-red.

R. A. HOUSTON.  
University of Glasgow, May 19.

### Anti-Gas Fans.

In a note in NATURE for May 13 you intimated that my "allegations" concerning the treatment of my anti-gas fans by the War Office and the suffering and loss of life thereby entailed could not be accepted without question, and you called upon the "well-accredited men of science," who, you say, largely staffed the Anti-Gas Service, to make a "plain statement of the facts." I waited to see if such a statement would be forthcoming, though I judged it scarcely likely; and now, since it has not appeared, I ask you, in fairness, to grant me space for a few remarks on your note.

You suggest that such an indictment as I have brought against the War Office, reinforced as it is with their own letters, reports, and pamphlets, can be refuted by the bare word of certain "well-accredited men of science." I pass over the implied slur on myself of being less well-accredited than they, my word of smaller value than theirs. No unprejudiced person who has read that indictment and that evidence with any care will agree with you that they can be thus easily disposed of.

In my dealings with the War Office I had to do with innumerable officials, some of them men of science, most not. From their behaviour I judged the larger number (and the exceptions were not, I regret to say, men of science) to be mere puppets, acting under the direction of some leading spirits behind. Who those leading spirits were I had no means of knowing; I was carefully kept in the dark. You, sir, intimate that they were "well-accredited men of science." If this was indeed so, then surely you will agree with me that, for the sake of science even more than in the interests of the nation at large, it is essential that this matter should not be hushed up, but that a public inquiry should be instituted. I am not only willing, but also most anxious to submit my case to some impartial tribunal. Will the men of science whom you have asked to speak, but who do not answer, come out into the open and join with me in demanding such an inquiry? If not, both the world of science and the general public will know what to think.

HERTHA AVRTON.

41 Norfolk Square, Hyde Park, W., May 23.

[We did not express an opinion upon the charges made by Mrs. Avrton, but limited ourselves to a statement of the indictment, and pointed out that it was really directed against the men of science associated with the Gas Service of the Army. Possibly these officers are not free to enter into a discussion of reasons for the neglect of the use of the fans, and nothing short of a public inquiry will elicit the whole of the facts in regard to them.—ED. NATURE.]

NO. 2640, VOL. 105]

### A New Method for Approximate Evaluation of Definite Integrals between Finite Limits.

THE subject has a particular interest for naval architects, inasmuch as the majority of calculations relative to displacement, stability, strength, etc., of ships involve the finding of areas and volumes bounded by curved lines and surfaces.

The particular rule enunciated by Mr. A. F. Dufton in NATURE of May 20 has been in use at this college for some years, and gives very accurate results in obtaining areas and volumes, and also, by a further application, the positions of their centres of gravity.

The method of its derivation was from one of Techebycheff's rules.  $f(x)$  in this particular case is taken as  $(a+bx+cx^2+dx^3+ex^4)$ . It can readily be shown that the value of

$$\int_0^1 f(x)dx = \frac{1}{4} [f(x_1) + f(x_2) + f(x_3) + f(x_4)],$$

where

$$\Sigma x_1 = 2, \Sigma x_1^2 = \frac{1}{3}, \Sigma x_1^3 = 1, \Sigma x_1^4 = \frac{1}{5},$$

whence  $x_1 = 0.1027$ ,  $x_2 = 0.4062$ ,  $x_3 = 0.5938$ , and  $x_4 = 0.8973$ . The approximation to one-tenth, four-tenths, six-tenths, and nine-tenths was obvious, and all the more welcome because it is our usual practice to divide the ship's half-length into ten sections. No special sections have to be drawn, calculations being readily made with the aid of the existing drawings.

This rule was briefly referred to by Mr. W. J. Luke at a meeting of the Institution of Naval Architects in 1915 (Trans. I.N.A., vol. lvii., p. 210).

The application of Simpson's ordinary rule to find the area of a quadrant or semicircle, as quoted, manifestly shows Simpson's rule at its worst, owing to the wide divergence of the curve from the assumed curve from which the rule is derived. Where curves approximate to these forms, as in many sections of a ship, it is common practice in the use of this rule to interpose intermediate ordinates where the curve is "steep"—relative to the base line—to get greater accuracy.

An interesting paper dealing with this subject and giving a great variety of rules for approximate integration was read at the Institution of Naval Architects in 1908 (Trans. I.N.A., vol. 1.) by Sir W. S. Abell entitled "Two Notes on Ship Calculations."

C. F. MERCHANT.

Royal Naval College, Greenwich, S.E.,

May 27.

### Applied Science and Industrial Research.

YOUR correspondent Mr. J. W. Williamson says in NATURE of May 27 that much of my criticism of the Department of Scientific and Industrial Research "seems to lend colour" to current misconceptions of industrial research, which he proceeds to construct out of his own imagination, having first fathered them on me, and then submits that the cause of pure science is not well served by inconsiderate attacks on the industrial research movement, such as he would have it believed I made. I judge from this that he was not present at the meeting, and I therefore wish it to be known that the full text of my address to the National Union of Scientific Workers can be obtained by forwarding a stamped addressed foolscap cover to the General Secretary, 19 Tothill Street, Westminster, S.W.1. If Mr. Williamson will have the goodness to read it and the full report of the meeting published in the current issue of the *Scientific Worker*, the official organ of the union, and then say, if he still desires, what he objects to, it would help rather than confuse the issue.

FREDERICK SODDY.

MR. WILLIAMSON'S letter in NATURE of May 27, in which he criticises the attitude of Prof. Soddy and that of the National Union of Scientific Workers towards the Department of Scientific and Industrial Research and the struggling research associations, confuses the issue. To attack the Department or association entrusted with industrial research is tantamount neither to attacking industrial research nor to making invidious distinctions between pure and applied research.

In the minds of the members of this union there exists no belief in the superiority of pure science over industrial research; it has always been our expressed opinion that there is no difference in their scientific value. In one of our explanatory pamphlets this view is expressed: "It [the union] aims at including within a single scheme both academic and technical members. . . . The separation of science and industry has been a principal cause of our disastrous neglect of science in the past, and if continued will remain harmful to both in future. The present organisation, by ensuring the intercourse of the two sides, is therefore desirable on both national and scientific grounds." Embodied in our rules we have as avowed objects: (1) To advance the interests of science, pure and applied, as an essential element in the national life. (2) To promote and encourage scientific research in all its branches.

Our criticism is that in any scheme put forward by the Department inadequate facilities are given to that type of research which, though it has less immediate application, is probably of greater ultimate importance through leading to the better understanding of more phenomena. It would be quite unfair to expect particular industrial research associations to contribute more than others to the prosecution of research which might have a common application to industry or to some aspect of the national life. Obviously this type of work is best carried out at the universities or at institutions such as the National Physical Laboratory. Yet how is this research fostered at the universities? According to the last report of the Department, sixty-eight research workers and their assistants and thirty-five students in training received allowances and grants for equipment amounting to 14,170*l.*; this is at the rate of 53*s.* a week, and includes equipment. Contrast this grant with the salary of 4000*l.* a year for the director of the Glass Research Association—an appointment which is an affront to all scientific workers. Millions have gone into State-protected industries to the accompaniment of an astounding appreciation in the value of the shares held by individuals in the State-aided industry. But the universities are begging for funds to provide decent bench accommodation and instructors for their science students. Speaking at Liverpool on May 28, Dr. Adams is reported to have said that if the university raised the salaries of its demonstrators to a proper standard it would lead to bankruptcy.

It is unfair to suggest that we are criticising the Department for the starvation of pure scientific research because industrial research is fostered; on the contrary, we are anxious for the advancement of both. We are of the opinion that neither branch of science is receiving adequate support, but that research carried out in the general interest is in the more unfavourable position. If we attack the Department it is because we honestly believe it is for the betterment of research—a maximum of efficiency in the administration of the funds available which must inevitably tend towards the better appreciation of science.

At the conference of research associations held under the auspices of the Department of Scientific and Industrial Research on May 14, I heard several

representatives express opinions almost identical with those of the National Union of Scientific Workers; suggestions were made and questions asked which are provoked by Prof. Soddy's address. Mr. Williamson himself dealt with the economic position of the research workers, and made suggestions for improvement which might have been those of a member of the executive of this union.

We entirely concur with Sir Frank Heath that the Department of Scientific and Industrial Research is embarked on a great adventure. Mr. Williamson will agree that it is our concern to work for the safety, honour, and welfare of the adventurous scientific workers. So far we have heard too much of the rights of the financial interests concerned to work out their own salvation with money provided largely by the State, but very little of the rights of the scientific workers to safeguard their own interests. We wish to be assured that the leading spirit in the adventure is sufficiently well advised to guide him in his choice of officers for this army of truth-seekers, and that his army is not defeated by ignorance, mishandled by an unsympathetic staff, or starved to feed the parasites of science.

A. G. CHURCH,  
Secretary.

National Union of Scientific Workers,  
10 Tothill Street, Westminster, London,  
S.W.1, May 31.

**The Great Red Spot on Jupiter.**

WHEN this remarkable object came into striking prominence and attracted general observation in 1878, the rate of its rotation period was slightly increasing, and it continued to increase until the end of the century. Then in the early part of 1901 a large irregular spot appeared in the south tropical zone of Jupiter. This new feature, moving swifter than the red spot to the extent of about 23 seconds per rotation, soon affected the motion of the latter by accelerating its rate as it overtook it, and this influence has been repeated prior to the seven occasions on which the two objects have been in conjunction during the last twenty years.

The rate of rotation indicated by the red spot has, in fact, been a very variable feature in recent times, and the marking named has exhibited an increased velocity and a shortening period. In the years from 1894 to 1901 the mean period was 9h. 55m. 41.3*s.*, but in the last eight years it has been 9h. 55m. 35.7*s.*

I have shown the annual differences in Fig. 1, and the rate of rotation determined each year I have also tabulated for inspection and comparison:

	h.	m.	s.		h.	m.	s.
1878	...	9 55	33.7	1899	...	9 55	41.6
1879	...		34.1	1900	...		41.4
1880	...		35.2	1901	...		40.7
1881	...		36.3	1902	...		39.6*
1882	...		37.3	1903	...		40.2
1883	...		38.2	1904	...		39.7*
1884	...		39.0	1905	...		41.2
1885	...		39.6	1906	...		39.5*
1886	...		39.9	1907	...		40.9
1887	...		40.1	1908	...		39.6*
1888	...		40.2	1909	...		40.3
1889	...		40.4	1910	...		37.4*
1890	...		40.5	1911	...		37.4
1891	...		40.6	1912	...		37.2
1892	...		40.8	1913	...		34.8*
1893	...		40.9	1914	...		35.5
1894	...		41.0	1915	...		37.5
1895	...		41.1	1916	...		36.4
1896	...		41.3	1917	...		34.5
1897	...		41.5	1918	...		33.7*
1898	...		41.7	1919	...		35.5

The values are smoothed up to 1900, but not in later years.

I have placed an asterisk in the table and diagram to those years in which a conjunction occurred between the red spot and the south tropical spot. In every case it will be seen that the red spot moved at a more rapid rate in those years when conjunctions were observed.

The south tropical spot or disturbance is a totally different object both in form and nature, and probably in origin, from the great red spot. The latter has preserved its symmetrical oval form since it was observed by Dawes in 1857, but the former has varied enormously in its length and detail. In 1901 it was scarcely more than  $20^\circ$  long, in 1902 July  $87^\circ$ , in 1903  $48^\circ$ , in 1905  $44^\circ$  to  $60^\circ$ , in 1911  $115^\circ$ , in 1912  $65^\circ$ , in 1913 March  $140^\circ$ , and in 1918  $180^\circ$ , so that in the last-mentioned year it extended half-way round the vast diameter of Jupiter.

This marking exhibited undue faintness in 1918 and the early part of 1919, and it appeared to be on the eve of disappearing, like the hollow in the great south equatorial belt where the red spot lies. How-

Phillips and Mr. F. Sargent, and I take this opportunity of acknowledging their kindness in furnishing the necessary materials. My abstention from planetary work has been practically enforced, but, amid the regret caused thereby, I feel great satisfaction in the fact that others are pursuing it with much ability and energy.

W. F. DENNING.  
Bristol, May 11.

#### British and Foreign Scientific Apparatus.

Now that we are living in an age of "trusts" there is no need to fear foreign competition in respect to prices. The only points our home manufacturers should lay stress upon are quality and quantity, and should these be maintained at a high level they can hold their ground against foreign manufacturers; that is, so long as the manufacturers throughout the world have confidence in their respective associations. Whenever these commercial associations begin to fall asunder we may expect competition in prices to operate, and then it will mean a commercial war, not between nations, but between

individual manufacturers in Europe and America. The result will mean financial benefit to the users of scientific apparatus, just as the recent slump in prices of the necessities of life may soon prove to be advantageous to consumers generally throughout the world.

Scientific apparatus is as necessary to the maintenance of healthy life as are hygienic clothing and wholesome food; and if protection for British manufacturers is required in the form of prohibition except under licence to induce them to improve the quality and the output, with the ultimate object of developing an optical industry within the Empire of such importance that there would be less danger to the State in the event of another war, why should the users of scientific apparatus be expected to bear the hardships in regard to poorer quality and higher prices even for a temporary period? Surely it is a question for the Government to decide

as to what amount of State aid is required to develop a key industry that the whole nation may be called upon to bear the expense instead of an extremely small minority of the population.

In pre-war days our principal foreign competitor was Germany, not so much in price as in quality, and if German manufacturers were able to develop an industry of very considerable importance without State aid, why cannot British manufacturers do likewise?

There was one person in Germany who was more responsible than all other makers together in lowering prices, viz. Leitz of Wetzlar. He always appeared satisfied with a comparatively small profit, and aimed at a very large output; and, I believe, he was the first to sell 1/12-in. oil immersion objectives at 5l., and curiously this ultimately became a uniform price throughout the trade in Europe and America. The same maker sold students' microscope stands at 55s., which, with suitable optical equipment, was a serviceable instrument with highest magnifications. The prices of these articles to-day are 9l. and 8l. 5s.—higher than the British equivalents.

Since the armistice German manufacturers have



FIG. 1.—Rates of rotation of the Great Red Spot on Jupiter.

ever, there has recently been some intensification in the material forming the south tropical spot, so that observations are being made to trace its position and developments. It is satisfactory also to know that the red spot itself continues to retain its definite form, and is sufficiently distinct to be within easy recognition when a steady air conduces to good seeing. This spot seemed to be breaking up or wearing out early in 1919, but it has recovered something of its old-time aspect, and is well within reach of the telescopes usually in the hands of amateurs.

Since Schwabe first saw the hollow on the south side of the great south equatorial belt of Jupiter in 1831 September 5, the planet has rotated more than 78,000 times. There is every reason to conclude that the object he saw is the same as that which has been so prominently visible in recent years in close contiguity to the red spot. The two features appear to have participated in one and the same fluctuating rate of rotation, a mean of which was 9h. 55m. 36.8s. during the 88½ years included in the observations.

The observations upon which my deductions for recent years are based were made by the Rev. T. E. R.

been obliged to adjust their prices in accordance with the rate of exchange for each country to which they export, and for our country their prices are at present 100 per cent. on average above pre-war English prices. The wages in the German optical industry have increased more than 400 per cent., and are likely to rise still higher. Opticians and mechanics earning the equivalent of 1s. per hour before the war now receive 5s. 6d. and have a working week of forty-eight hours. They are living in a state of semi-starvation, passing through an experience at present much worse than anything we endured in the war, and unless foodstuffs are sent from England and America the Germans may be forced to conditions similar to those experienced by them during the last two years of war, until the next harvest provides better supplies. The low value of German money makes it exceedingly difficult for manufacturers to import raw materials. Many iron and steel works are closed for want of coal, and most of the coal delivered from the mines is what our miners call "dust." The French take the coal and leave the rubbish, "which is good enough for the Germans." Motor lorries are standing idle for want of petrol or benzol; and, for transport, horses are employed instead. Manufacturers do not pay a percentage on excess profits, but have to deliver up the whole of these profits to the State.

I fully appreciate the question which Mr. Baker raises in his letter appearing in NATURE of May 20: "The rate of exchange makes the prices seem low as compared with those in this country, but can Prof. Bayliss obtain delivery at the low prices?" Having spent six weeks recently in the German interior and purchased a considerable quantity of optical apparatus, I found it impossible to get the goods exported to England at the rate of exchange, but had to pay English prices in English money; also it was necessary to obtain licences from the German Government before goods could be exported.

The foregoing statements indicate briefly some of the conditions prevailing in the scientific apparatus trade in Germany, and there is evidence of their having to continue for a very considerable period.

I believe our manufacturers have had the opportunity of a lifetime since the armistice, and there is still time to reorganise British workshops to compete successfully with foreigners without State aid, but with courage, capital, and enterprise.

The proposed Anti-dumping Bill is a misnomer. There is no dumping done in scientific apparatus in our country, and never has been any. We could produce quality equal to or better than that of any other nation if we set ourselves to the task. One example during the war—the best aerial photographic lenses were made by an English firm. Germany came second. The tests were made by disinterested officials in the Royal Air Force. J. W. OGILVY.

Hill View, Westerham Hill, Kent, May 25.

THE letters from manufacturers on the subject of the supply of scientific instruments are interesting and fairly unanimous, but appear to me to miss the whole point of the situation. That is, that after five years' freedom from competition our manufacturers cannot in many classes of scientific instruments compete successfully with German firms.

If the rate of exchange is the cause of the importation of German instruments, what is the cause of hundreds of American microscopes and lenses being sold during and after the war with the rate of exchange adverse to us? The Germans are selling their goods in England at *current English rates* and above, yet find a ready sale. At first, it is true, some individuals

smuggled in German instruments at mark rates, but as soon as the extent of the demand was realised, German firms put up their export rates to 60–100 per cent. above pre-war rates, to be paid in *English money*, and by some firms payment in advance is insisted upon. This is more than confirmed by Messrs. Bellingham and Stanley in their letter. What more do our manufacturers want?

The German goods are sold simply because they are superior to similar goods produced at reasonable prices in Britain. Mr. B. H. Morphy and Mr. C. Baker state that this was the case before the war, and most scientific workers will tell them that it is so still.

One firm complains of a voluntary hospital buying apparatus cheaper abroad, and thinks that an English firm should have been given the contract at higher rates. Whose money is to do this? I hope that the voluntary subscribers would protest against their money being paid to subsidise British manufacturers.

A small concrete example of what actually occurs may not be out of place. A German diamond object marker before the war cost 10 marks. Early this year I sent to a leading firm of British opticians for one. It arrived, but was absolutely useless, having no spring safety device and no means of screw adjustment, both present in the German one. It cost 1l. 10s. Months later, with considerable trouble, I procured from Messrs. Leitz, of Germany, the pre-war article at 100 per cent. advance, namely, 1l. The German article was bought because it was superior, not because it was cheaper.

It should be borne in mind that some scientific articles, e.g. photographic plates, can be produced well and cheaply here, and need not fear German competition. If, as Mr. Baker states, the profit on other classes of goods is too small, why not allow them to be imported from Germany?

Glasgow, May 21.

J. S. DUNKERLY.

#### Cost of Scientific Publications.

LIKE other societies which exist mainly for the publication of the results of scientific research, the Royal Society of Edinburgh finds its activities greatly hampered by the present cost of publication. The statements contained in the leader in NATURE of May 6 and in the correspondence which has followed it are fully borne out by the experience of this society. Taking into account all present sources of income and all necessary expenses, it may safely be said that the output of scientific literature must be cut down to fully one-third of what it was in pre-war days.

The point to be emphasised is that publication of scientific results is absolutely necessary for the true development of science. A year and a half ago the council of the Royal Society of Edinburgh, on realising the seriousness of the situation, appealed to the Chancellor of the Exchequer for an increase in the annual grant solely in the interest of scientific publication. The appeal was unsuccessful, but in reply the Chancellor of the Exchequer stated that "he would be ready to reconsider the question along with other similar claims when the financial situation is more favourable."

It certainly seems necessary that suffering societies which publish original memoirs should take steps to press on the attention of the nation and on the conscience of the Government this consideration in the interest of scientific investigation, viz. the provision of adequate funds for the publication of the results of research.

C. G. KNOTT,

General Secretary.

Royal Society of Edinburgh,

22 George Street, May 31.

Natural History Studies in Canada.<sup>1</sup>

(1) A REVISED edition of Mr. Ernest Thompson Seton's "Arctic Prairies" (first published in 1911) is very welcome. It is a well-told story of a canoe journey of 2000 miles in search

life (in 1907) in the Far North-west of America. "I have lived in the mighty boreal forest, with its Red-men, its Buffalo, its Moose, and its Wolves; I have seen the Great Lone Land with its endless plains and prairies that do not know the face of man or the crack of a rifle; I have been with its countless lakes that re-echo nothing but the wail and yodel of the Loons, or the mournful music of the Arctic Wolf. I have wandered on the plains of the Musk-ox, the home of the Snowbird and the Caribou."

The author has fine things to tell us of—such as the love-song of Richardson's owl, sung on the wing, "like the slow tolling of a soft but high-pitched bell"; a herd of wild buffalo amid a great bed of spring anemones; a troop of caribou, about 500 strong, charging at full trot through the taint of man; and the wealth of flowers in the so-called "Barren Grounds." There are grim pictures too—of the malignancy of the mosquitoes which for two and a half months make a hell of a land which for half the year might be an earthly paradise; of the epidemics that periodically wipe out the all too prolific rabbits (billions in the Mackenzie River valley in 1903-4, and none to be seen in 1907); of the Canadian lynx that "lives on rabbits, follows the rabbits, thinks rabbits, tastes like rabbits, increases with them, and on their failure dies of starvation in the unrabbitted woods"; of the aged dwarf spruces which testify to the rigour of the environmental conditions, for one which was at least 300 years old was only 8 ft. high and 12 in. through. Mr. Seton's skill as a descriptive naturalist needs no praising, and his narrative is full of human interest as well. The book is generously illustrated with pen-and-ink drawings and photographs. The reference in the preface to the scientific appendices might have been judiciously omitted, for appendices there are none.

(2) Capt. Buchanan tells of his wanderings in "the great unpeopled North, which even to-day comprises more than half of the large Dominion of Canada." He explored the country between



FIG. 1.—The sandhill crane. From "Wild Life in Canada."

of the caribou (a kind of reindeer), and it discloses a cheerful picture of the abundance of wild

<sup>1</sup> (1) "The Arctic Prairies: A Canoe-Journey of 2000 Miles in Search of the Caribou. Being the Account of a Voyage to the Region North of Aylmer Lake." By Ernest Thompson Seton. Pp. xii+308. (London: Constable and Co., Ltd., 1920.) Price 8s. 6d. net.

(2) "Wild Life in Canada." By Capt. A. Buchanan. Pp. xx+204. (London: J. Murray, 1920.) Price 15s. net.

the Saskatchewan River and the Arctic "Barren Grounds," and his collection of birds from the area drained by the Churchill River was the first to be made from that remote region. Of this collection a list is given at the end of the book, and birds predominate throughout the pages of what is really a naturalist's journal—unvarnished, graphic, and with a strong personal note. A chapter is given to the rare sandhill crane, which he saw and heard and stalked. He found the nest and saw the eggs through the field-glass, but, having waited overnight in the hope of the parents return-

ward migration, so it is leisurely; moreover, many of the does are with young. The southward movement of great herds in the fall is largely conditioned by the absence of trees, for an icy crust, difficult to break, forms over the snow. "As the thermometer drops in the Far North and food and shelter become difficult to find, the animals will band together and grow restive, and pause from time to time to sniff the wind from the south with question on their countenance. And one day, with proud heads up and anxious eyes, they will commence their long travel through sheltering

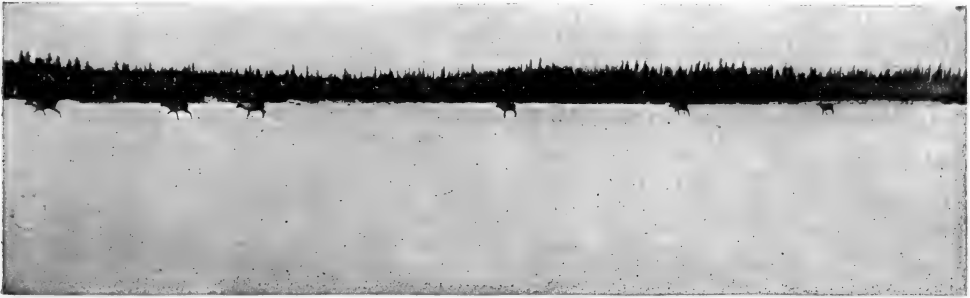

FIG. 2.—Caribou travelling in typical Indian file. From "Wild Life in Canada."

ing, he was baulked in the end, for the nest was empty in the morning.

A fine picture is given of Reindeer Lake, a vast sheet of water stretching 140 miles north and south, and 40 miles across at its widest. Its shores form the favoured winter-haunt of the barren-ground caribou (*Rangifer arcticus*), which digs through the snow to get at the white moss and marsh grass. Early in the year the does and yearling fawns begin to move northward, and the bucks follow later.

There is no weather-change urging the north-

forests where snows are soft and food is plentiful beneath its yielding surface."

The picture that the author gives of the caribou is a fine piece of work. Another chapter deals with the admirable sled-dogs, which will gamely do their best, for two or three days on end, in bitter weather and without food, to save an anxious situation. Very good reading, too, is Capt. Buchanan's appreciation of the Cree and Chipewyan Indians, "quaintly friendly and unselfish in their hospitality," "resourceful, magnificent fellow-travellers on the trail."

### Tidal Power.

THE idea of utilising the rise and fall of the tides for power purposes has long been a favourite one. Up to the present, however, no power development of this kind, of any appreciable size, has been carried out. The comparatively recent arousing of interest in water-power development in general, and the great advance in the cost of fuel, have been accompanied by a corresponding interest in tidal-power schemes, and their commercial possibility is at the moment the subject of serious investigation in this country and in France.

The power which may be developed from a tidal basin of given area depends on the square of the tidal range, and since the cost per horse-power of the necessary turbines and generating machinery increases rapidly as the working head is diminished, the cost per horse-power of a tidal-power installation, other things being equal, will

be smallest where the tidal range is greatest. It is for this reason that the western, and especially the south-western, coasts of Great Britain, and the western coast of France, are particularly well adapted for such developments, since the tidal range here is greater than in any other part of the world, with the possible exception of the Bay of Fundy, Hudson's Bay, and Port Gallelos, in Patagonia.

In Great Britain the highest tides are found in the estuary of the Severn, the mean range of the spring tides at Chepstow being 42 ft., and of the neap tides 21 ft. In France the maximum range occurs at St. Malo, where it amounts to 42.5 ft. at spring tides, and about 18 ft. at neap tides. The tidal range in the Dee is 26 ft. at springs, and 12 ft. at neaps, while the mean range of spring tides around the coast of Great Britain is 16.4 ft., and of neap tides 8.6 ft.

Many schemes of tidal-power development have been suggested from time to time. Briefly outlined, the more promising of these are as follows:—

(a) A single tidal basin is used, divided from the sea by a dam or barrage, in which are placed the turbines. The basin is filled through sluices during the rising tide. At high tide the sluices are closed. When the tide has fallen through a height the magnitude of which depends on the working head to be adopted, the turbine-gates are opened, and the turbines operate on a more or less constant head until low tide. The maximum output from a given area of basin is

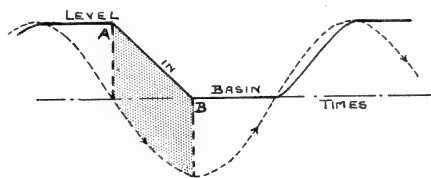

FIG. 1.

obtained when the working head is approximately one-half the tidal range, and the cycle of operations under these conditions, and with a constant rate of fall in the tidal basin, is shown in Fig. 1. Here the dotted sine curve represents the level of the sea on a time base. The working period extends from A to B.

(b) A single tidal basin is used, with the turbines operating on both rising and falling tides. The cycle of operations is now indicated in Fig. 2. The working period for complete tide extends from A to B and from C to D. Slightly before low water, at B, the basin is emptied through

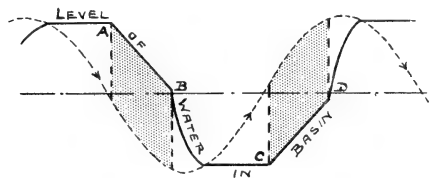

FIG. 2.

sluice-gates, and at D, a little before high water, the basin is filled through the sluice-gates. With a working head equal to one-half the tidal range, the period of operation is approximately 50 per cent. greater than in system (a), and the work done per complete tide is approximately 50 per cent. greater.

(c) A single tidal basin is used with the turbines operating on both rising and falling tides. Instead of filling and emptying the tidal basin through sluice-gates at high and low water, and working under an approximately constant head, the water is allowed to flow through the turbines and to

adjust its own level. Under these conditions the rise and fall inside the basin are cyclical, with the same period as the tide, but with a smaller rise and fall and with a certain time-lag. The range in the basin and the time-lag depend on the ratio of the surface area of the basin and of the effective discharge area of the turbines. The working head during each tide varies from zero to a maximum. The cycle of operations is shown in Fig. 3. The working period is from A to B and from C to D, where the head at the points A, B, C, and D is the minimum under which the turbines will operate. The total working period per tide is greater than with either of the preceding

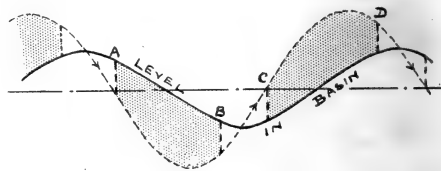

FIG. 3.

systems, and the possible output is somewhat greater. On the other hand, the variation of head during any one tide is very large.

(d) Two tidal basins of approximately equal areas are used, with turbines in the dividing wall. Each basin communicates with the sea through suitable sluice-gates. In one of these basins, called the upper, the water-level is never allowed to fall below one-third of the tidal range, while in the lower basin the level is not allowed to rise above one-third of the tidal range. The working head then varies from 0.53 H to 0.80 H, and operation is continuous, as indicated in Fig. 4, which shows the cycle of operations. The upper

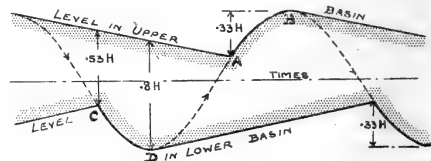

FIG. 4.

basin is filled from the sea through the appropriate sluice-gates from A to B, and the lower basin discharges into the sea from C to D. For a given total basin area and a given tidal range the output is only about one-half that obtained in system (a), and one-third that obtained in systems (b) and (c), so that, except where the physical configuration of the site is particularly favourable, the cost per horse-power is likely to prove very high.

(e) Two tidal basins of approximately equal size are used. Turbines are installed in the walls dividing the sea from each basin. Fig. 5 shows



the cycle of operations. From A to B the upper basin discharges through its turbines into the sea. From B to E the sea enters the lower basin through its turbines. The upper basin is filled from the sea through its sluice-gates between C and D, and the lower basin is emptied through its sluice-gates from F to G. The head varies from 0.25 H to 0.62 H, and the output is some 25 per cent. greater than in system (d), but the number of turbines required is much greater than in (d).

It is possible, at the expense of additional complication, to arrange in each of these systems that the head shall be maintained constant during any one working period, but since this means that the working head must then be the minimum obtaining during the period, a loss of energy is involved, with a great additional cost of construction and complication in manipulation, and with little compensating advantage.

The great difficulty in developing a tidal scheme as compared with an orthodox low head water-power scheme arises from the relatively great fluctuations in head. In any scheme in which the working head is a definite fraction of the tidal range, the working head at spring tides is much

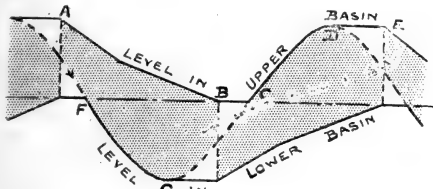

FIG. 5.

greater than at neap tides. In the case of the Severn, for example, the working head at springs would be twice as great as at neaps, and the energy output per tide would be four times as great at springs as at neaps, while at St. Malo the output would be 5.5 times as great at springs as at neaps.

Not only is the installation subject to this cyclical fluctuation of head, but in any simple scheme the turbines also cease to operate for a more or less extended period on each tide; and as this idle period depends on the time of ebb or flood tide it gradually works around the clock, and will, at regular intervals, be included in the normal industrial working day. It is true that schemes of operation such as have been indicated are feasible in which this idle period may be eliminated and continuous operation ensured, but only at a considerable reduction of output per square mile of tidal basin area. Even in such schemes, unless the working head is fixed with reference to the tidal range at neap tides, the variation of head between springs and neaps causes the output to be very variable.

In any installation, then, designed for an ordinary industrial load, unless the output is cut down to that obtainable under the minimum head

available at the worst period of a neap tide, in which case only a very small fraction of the total available energy is utilised and the cost of the necessary engineering works per horse-power will, except in exceptionally favourable circumstances, be prohibitive, some form of storage system forms an essential feature of the scheme.

Various storage systems have been suggested. Electrical accumulators must be ruled out, if only on account of the cost, and the same applies to all systems making use of compressed air. The only feasible system appears to consist of a storage reservoir above the level of the tidal basin. Whenever the output of the primary turbines exceeds the industrial demand, the excess energy is utilised to pump water into the reservoir, and when the demand exceeds the output from the primary turbines it is supplied by a series of generators driven by a battery of secondary turbines operated by the water from the storage reservoir.

Evidently this method is available only when the physical configuration of the district affords a suitable reservoir site within a reasonable distance of the tidal basin. Unfortunately also, considerable losses are inevitable in the process, and the energy available at the switchboard of this secondary station is only about 50 per cent. of the energy of the water utilised by the primary turbines. Where two tidal schemes at some distance apart differ sufficiently in phase, it is possible, by working the two in conjunction, to reduce or eliminate the idle period between tides, and thus to reduce the necessary storage somewhat; but this does not affect the necessity of storage as between spring and neap tides.

Since storage reduces the available output by one-half, and at the same time complicates the system, besides adding considerably to the first cost and maintenance charges, the prospects of tidal-power schemes would be much more promising if the whole of the output could be utilised as it is generated. By feeding into a distributing main in conjunction with a large steam station and/or inland water-power scheme, and delivering to an industrial district capable of absorbing a comparatively large night load, such a state of affairs might be realised, at all events approximately. There is also the possibility that the intermittent operation of certain electro-chemical processes may be developed so as to enable any surplus power to be absorbed as and when available, and, if so, power developed tidally will probably prove cheaper in this country than that developed from any other source.

Owing to the relatively large variations in working head in any simple scheme, and to the small working heads, the design of hydraulic turbines capable of giving constant speed with reasonable efficiencies, and of moderately high speeds of rotation, is a matter of considerable difficulty. Modern developments, however, promise much better results in both these respects than would have appeared possible only a few years ago, and turbines are in existence

which are capable of operating under a variation of head equal to 50 per cent. on each side of the mean, with efficiencies which do not fall below 70 per cent. over this range, and with reasonably high speeds of rotation under the heads available.

Even with such turbines, the number of technical problems to be solved before a tidal scheme of any magnitude can be embarked upon with confidence is large. The questions of single-*versus* double-way operation, of storage, of the effect of sudden changes of water-level due to strong winds, of wave effects, of silting in the tidal basin and of scour on the down-stream side of the sluices, of the best form of turbine and of generator, and of their regulation and of that of the sluice-gates, are probably the most important, though not the only, subjects to consider.

On the other hand, the possibilities of tidal power, if it can be developed commercially, are very great. Assuming a mean tidal range of only 20 ft. at springs, and 10 ft. at neaps, and adopting the single-basin method of development with

operation on both rising and falling tides, each square mile of basin area would be capable, without storage, of giving an average daily output of approximately 110,000 horse-power-hours. In such an estuary as the Severn, where an area of 20 square miles could readily be utilised with a spring tidal range of 42 ft., the average daily output, without storage, would be approximately 10,000,000 horse-power-hours.

At the present time it is difficult to obtain an even rough estimate of the total cost of such a scheme, owing to the uncertainty regarding many of the factors involved. The whole question would appear to merit investigation, especially on matters of detail, by a technical committee with funds available for experimental work. As a result of such an investigation, it is at least possible that a definite working scheme could be formulated capable of generating power at a cost at least as small as, and possibly much smaller than, that of power generated from any coal-fired installation.

### Obituary.

PROF. C. A. TIMIRIAZEFF, FOR.MEM.R.S.

THE death is announced of Clement Arkadievitch Timiriazeff, emeritus professor of botany in the University of Moscow. Timiriazeff was the only Russian botanist who was at all a familiar figure in England. In earlier days he came to England and saw Charles Darwin, while his last visit was made as a delegate to the Darwin celebration in Cambridge in 1909. His earliest publication appeared in 1863—a Russian book on "Darwin and his Theory," which ran through five editions. Here he made his mark as an attractive expounder of science for the general reader, and he followed this work with books on "The General Problems of Modern Science," "Agriculture and Plant Physiology," and "The Life of the Plant." The last was in great demand, there being seven Russian editions between 1878 and 1908, while in 1912 it was translated into English, and is widely read to the present day. Its characteristic note is an exposition of plant structure and function based on the chemical and physical processes at work in the living plant. Without comparison of the early editions we cannot tell at what date this book took the form in which it appeared in English, but it looks as if Timiriazeff was one of the earliest writers to take up this essentially modern outlook. His attitude was no doubt an expression of his early training under chemists and physicists. Born in 1843, he studied under Bunsen, Kirchhoff, Helmholtz, and Berthelot before working with Boussingault.

Timiriazeff made himself famous by work on one single problem—the participation of the different rays of the visible spectrum in the photosynthetic activity of the green leaf. The technique which he brought to the attack on this problem seems almost an exact expression of the

combined influence of his teachers: good methods of gas-analysis, pure spectral illumination, and experimentation on isolated leaves; combined with the sound conception that rays utilised for work in the chloroplast must be rays abundantly absorbed by the pigment chlorophyll. Working with a micro-eudiometer, concentrated sunlight, and a narrow spectroscopy slit, he was able to disprove the accepted view that the yellow region, which is so bright to the eye, is the most effective region of the solar spectrum, and to locate the efficiency in the red region where absorption by chlorophyll is greater. Afterwards he demonstrated the secondary maximum of photosynthetic effect in the blue region, where also absorption is great.

This work was published in different forms, at various dates, in scientific journals of most European countries, the final presentation being the Croonian lecture to the Royal Society in 1903. The actual experimental work seems to have been all done between 1868 and 1883. There is no evidence that he published research work on any other subject, so that we have in Timiriazeff the remarkable case of a man who, having achieved fame by one important line of research at forty, was content to devote the remaining half of his life to teaching and exposition.

THE announcement of a new book, "A Nation's Heritage," by HARDWICKE DRUMMOND RAWNSLEY, sadly coincides with the record of its author's death. Born on September 28, 1851, the distinguished canon died on May 28, to the last pursuing the self-imposed task of persuading his fellow-countrymen to take care of their own treasures. His mother was a niece of Sir John Franklin, the Arctic explorer. In education Canon Rawnsley had the good fortune to be at Upping-

ham under Edward Thring, and at Balliol under Benjamin Jowett, with fellow-undergraduates who in various ways became men of light and leading. As a poet and preacher, and in general a quickener of life and energy wherever demands were made upon his active genius, he met with well-deserved appreciation. As the obituary notice in the *Times* observes, "perhaps his chief work was the founding of the National Trust for the Preservation of Places of Historic Interest and Natural Beauty." For the qualifying word "perhaps" it would be better to substitute the word "undoubtedly." Men like Canon Rawsley, by setting a courageous example, often accomplish much more than their immediate object.

By the death, at fifty-eight years of age, of DR. GEORGE ERNEST MORRISON, "Morrison of Peking," as he was familiarly known, the Empire has lost a great explorer and expert in the politics of the Far East. An Australian by birth, Dr. Morrison began by explorations in that continent, New Guinea, and the South Sea Islands, his most notable exploit being his famous crossing from the Gulf of Carpentaria to Melbourne in 1882, when he marched 2043 miles on foot in 123 days. Coming to Europe, he took his degree of M.D. at Edinburgh, and wandered in the United States, Spain, and Morocco. Reaching China, he crossed to Rangoon and explored Siam. His life-work really began in 1897, when he was appointed correspondent of the *Times* at Peking. Here he recorded from day to day with the prescience of a statesman and the accuracy of a historian the momentous struggle which resulted from the German occupation of Kiao-chao, and he took an active part in the defence of the Peking Legations during the Boxer rising of 1900. In 1907 Dr. Morrison crossed China from Peking to Tonquin, and in 1910 he rode from Honan City to Andijan in Russian Turkestan. Two years later he resigned his post as correspondent of the *Times*, and became political adviser to the first President of the Chinese Republic. During his stay in Peking he collected one of the most comprehensive libraries of Chinese literature. His contributions to the study of the Far East, except his well-known book, "An Australian in China," largely consist of newspaper articles.

We much regret to announce the death, on May 28, in his forty-third year, of PROF. LEONARD DONCASTER, F.R.S., fellow of King's College, Cambridge, and Derby professor of zoology in the University of Liverpool.

We notice with regret the announcement in the *Times* of the death in India, at the early age of thirty-two years, of PROF. SRINIVASA RAMANUJAN, F.R.S., fellow of Trinity College, Cambridge, and distinguished by his brilliant mathematical researches.

## Notes.

THE Romanes lecture at Oxford was delivered on May 27 by Dr. Inge, Dean of St. Paul's, before a large audience, by whom the lecturer's brilliant epigrams and trenchant criticism of conventional catchwords were evidently much appreciated. Dealing with the "idea of progress," the Dean made it clear that he had no belief in any natural law of continued progress in the sphere of morals or intellect, or even of physical organisation. The conception of such a law was, in fact, of comparatively recent growth, and had no foundation in the thought of antiquity or of the Middle Ages. At the same time he would not deny a temporary improvement of the race in fulfilment of a finite purpose, though he found little or no evidence of any advance during the historical period in either physical organisation or morals. The results of accumulated experience must not be confounded with a real progress in human nature. Dean Inge would scarcely be concerned to deny that the emergence of rational humanity from previous non-human conditions deserved in some sort the name of "progress," but he saw no warrant for the belief that such "progress" would be continued indefinitely under the domain of natural law. Huxley had pointed out in a previous Romanes lecture that ethical improvement ran counter to the process of cosmic evolution. Progress was a task for humanity, not a law of Nature. "Civilisation was a disease that had hitherto been invariably fatal. The ancient civilisations had fallen by the attacks of outer barbarians; "we breed our own barbarians." But progress was possible for the individual, if not for the race, and hope was not only a virtue, but also a solid fact.

On May 17 Mr. H. Morris, of Lewes, read a paper to the Oxford University Archæological Society on the evolution of Wealden flint culture from pre-Palæolithic times, including that of Piltown Man. He exhibited many flints, which he claimed as intermediate between the early Harrison types of the North Downs plateau and the recognised Palæolithic types, representing man's transition from the stage in which he subsisted on a vegetable diet to the hunting stage. The earliest spear-head accompanies the Piltown skull and marks the beginning of man the hunter. The flints are confined to a limited number of patches, and many prolific "river gravel" areas fail to produce anything resembling them; the proportions in which the various types appear are found to agree closely in all the patches. When the cortex of the flint did not interfere with the design of the implement, it has been cleverly and intentionally preserved; many of the fractures are of thermal origin, but man utilised these natural fracture-surfaces in the same way as he utilised cortex. It is significant that signs of man's work appear only in the places where it is essential for the attainment of the required form. Sir Arthur Evans, Prof. Sollas, Dr. Marett, Mr. Henry Balfour, Mr. Reid Moir, and others discussed Mr. Morris's paper, and hesitated to accept his conclusions.

A SUDDEN flood swept through the Lincolnshire town of Louth on Saturday afternoon, May 29, causing immense havoc in its path. The torrent took the course of the small stream known as the River Lud, which runs through the town, and rose 15 ft. in half an hour. The disaster, which occurred shortly before 5 o'clock, is described as a huge wall of water sweeping down upon the town and carrying away bridges and buildings opposed to its course. The River Lud in normal times is a stream from 12 ft. to 15 ft. wide, and about 2 ft. or 3 ft. deep. The flood is said nowhere to have been less than 8 ft. to 10 ft. high and fully 200 yards wide. It was apparently accompanied by no warning sound, and the torrent of water is said to have exceeded the rate of 40 miles an hour. The loss of life is reported to be from 25 to 40 persons, and the damage to property is roughly estimated at 250,000. to 500,000. A heavy thunderstorm had raged for two hours in the afternoon. The disaster was, without doubt, due to intense thunderstorm rains swelling the river far beyond the capacity of its channel. The "Meteorological Glossary" published by the Meteorological Office describes a "cloud-burst" as a term commonly used for very heavy thunder-rain, and in this sense the term seems applicable to the cause of the Louth disaster.

THE new by-laws of the Chemical Society came into force on June 1, and women are now eligible for fellowship of the society.

THE annual visitation of the Royal Observatory, Greenwich, will be held on Saturday next, June 5. The observatory will be open for inspection by invited visitors at 3.30 p.m.

DR. FREDERICK G. COTTELL has been nominated by President Wilson as Director of the U.S. Bureau of Mines, Department of the Interior, in succession to Dr. Van. H. Manning, resigned.

THE Stewart prize of the British Medical Association has been awarded by the council to Dr. Harriette Chick, who has been an assistant in the department of experimental pathology at the Lister Institute since 1906, and has published numerous papers on bacteriology and physical chemistry.

By the courtesy of the council of the Institution of Mechanical Engineers, the next ordinary scientific meeting of the Chemical Society on June 17 at 8 p.m. will be held in the lecture-hall of the Institution of Mechanical Engineers, Storey's Gate, Westminster, S.W.1, when Prof. J. C. McLennan, of Toronto University, will deliver a lecture on "Helium."

A JOINT meeting of the Association of Economic Biologists and the Imperial Entomological Conference will be held at the Rothamsted Experimental Station, Harpenden, on June 4. The party will leave St. Pancras Station by the 10 a.m. train and, on arrival at Harpenden, proceed direct to the park, where the experimental plots will be demonstrated by Dr. W. E. Brenchley.

SIR WILLIAM J. POPE has accepted the nomination of the council of the Society of Chemical Industry to be president for the year 1920-21. Prof. H. Louis has

been elected foreign secretary in succession to the late Dr. Messel, and Dr. C. C. Carpenter has been appointed the society's representative on the governing body of the Imperial College of Science and Technology.

At the meeting of the Franklin Institute, Philadelphia, on May 19, the Franklin medal awarded to the Hon. Sir Charles A. Parsons was received by Sir Auckland Geddes, British Ambassador; and Mr. W. A. F. Ekengren, Swedish Minister, also received a Franklin medal for Prof. Svante A. Arrhenius. Papers were presented on "Some Reminiscences of Early Days of Turbine Development" by Sir Charles A. Parsons, and on "The World's Energy Supply" by Prof. Arrhenius.

THE national memorial to the late Capt. F. C. Selous at the Natural History Museum, Cromwell Road, South Kensington, will be unveiled by the Right Hon. Viscount Grey of Fallodon, K.G., on Thursday next, June 10, at 3.30 p.m. The presentation will be made by the Right Hon. E. S. Montagu, M.P., chairman of the committee. The granite of the bas-relief which forms the memorial is from the Matoppe Hills, the burial-place of Cecil Rhodes and Sir Starr Jameson, and was presented to the Selous Memorial Committee by the Government of the Union of South Africa.

THE Imperial Entomological Conference was opened in London on Tuesday, June 1, by Lord Harcourt. The official delegates to the conference are:—Canada, South Africa, Basutoland, Bechuanaland, and Swaziland, Mr. C. P. Lounsbury; Australia, Prof. R. D. Watt; New Zealand, Dr. R. J. Tillyard; India, Mr. C. F. C. Beeson; Queensland, Mr. F. Balfour Browne; British Guiana, Mr. G. E. Bodkin; Ceylon, Mr. F. A. Stockdale; East Africa Protectorate, Mr. T. J. Anderson; Federated Malay States, Mr. P. B. Richards; Gold Coast, Mr. W. H. Patterson; Imperial Department of Agriculture for the West Indies and Leeward Islands, Mr. H. A. Ballou; Mauritius, Mr. G. G. Auchinleck; Northern Rhodesia, Dr. Aylmer May; Southern Rhodesia, Mr. R. W. Jack; Seychelles, Dr. J. B. Addison; Sierra Leone, Mr. H. Waterland; Straits Settlements, Mr. P. B. Richards; Sudan, Mr. H. H. King; Trinidad, Mr. F. W. Urlich; and Uganda, Mr. C. C. Gowdy.

In the May issue of the *Fortnightly Review* Mr. Edward Clodd gives an account of the prevalence of occultism at the present day. This results from the fact that though man calls himself *Homo sapiens*, his instincts and elemental passions and emotions remain primitive. Prof. Elliot Smith in a recent paper on "Primitive Man" remarks that, "so far as one can judge, there has been no far-reaching and progressive modification of the instincts and emotions since man came into existence beyond the acquisition of the necessary innate power of using more complex cerebral apparatus which he has to employ." *Plus ça change, plus c'est la même chose*. The influence of the present movement, and the mischievous play on the hopes and fears of crowds of dupes of all classes of society, are strongly reprobated. "Its exponents lack the harmlessness of the cranky theory-

mongers who, if they have wasted our time in the pamphlets they thrust upon us, at least in some degree condone this nuisance by the amusement which they supply."

SIR W. RIDGEWAY AND DR. L. D. BARNETT have reprinted a paper read by them before the Cambridge Philological Society on "The Origin of the Hindu Drama: Additional Evidence." The theory that this type of drama had its origin in dances connected with the cult of the dead is supported by a new series of facts. Krishna, whether he be regarded as a deity from all time or merely a vegetation abstraction, was, as was suggested by S. Lévi in 1892, the chief element in the Hindu drama. The defeat of the Asura demons by Indra took a dramatic form, in which the god's flagstaff became the emblem of the stage, recalling the pole known to the Japanese as Mitegura, "Lordly-Cloth-seat," and to the Chinese Gohei, "Imperial Presence." In the same way the Vir, or spirits of men who died on the battlefield, are "danced" by the Mahrattas. Other evidence to the same effect has been collected from other parts of India, and the writers sum up the discussion by remarking that "there can therefore be no longer any doubt that Hindu serious drama arose in the worship of the dead."

IN the Journal of the Royal Society of Antiquaries of Ireland (vol. xlix., part 2, December, 1919) Mr. R. J. Kelly, K.C., discusses the question of the famous Donnybrook Fair. On the authority of the great Irish scholar, Dr. Todd, the name seems to be derived from Domhnach broc, "the Church of Broc," a saint who seems to have flourished before the eighth century. By a charter of Prince John, bearing date 1192, the city of Dublin was authorised to establish a fair "at Doniburn annually to continue for eight days on the Feast of the Invention of the Holy Cross," and this was confirmed by a charter, 26th of Henry III., dated 1241. The rude merriment, crime, and degradation which occurred during the fair finally led to its abolition in 1855, after it had lasted nearly six and a half centuries. Mr. Kelly's article contains an excellent collection of extracts from contemporary writers describing the famous fair. Further details are given in the same issue of the journal in an article by Mr. H. Bantry White on "An Old House at Donnybrook."

MISS ANNE L. MASSY gives (Sc. Proc. Roy. Dublin Soc., vol. xvi., No. 4, April, 1920) a revised list of the twenty-five species of Holothurioidæ ("sea-cucumbers") of the coasts of Ireland. Since the publication in 1905 of Mr. Kemp's paper on the Echinoderms of the west coast of Ireland, the naturalists of the Fisheries Branch of the Department of Agriculture have taken three species of Holothurians which are new to the British and Irish area, namely, *Stichopus regalis*, *Mesothuria Verrilli*, and *Benthogone rosea*. The first of these occurs in the Mediterranean, and is known as far south as the Canaries, but has not hitherto been observed north of the Bay of Biscay. The other two appear to inhabit the warmer parts of the Atlantic, and probably reach their northern limit at about 52° N.

NO. 2640, VOL. 105]

DR. H. A. PILSBRY'S "Review of the Land Mollusks of the Belgian Congo, chiefly based on the Collections of the American Museum Congo Expedition, 1909-1915" (Bulletin of the American Museum of Natural History, vol. xl., art. 1, 1919), is a very important contribution to our knowledge of the African fauna. The collections on which it is based are very extensive, comprising more than 6000 specimens representing 214 species and subspecies, and a complete record of all the land mollusks hitherto known from the region (compiled by Dr. J. Bequaert) is included. Large numbers of carefully preserved spirit-specimens were available, and Dr. Pilsbry was able to study the anatomy of the soft parts with important results. In the case of the Helicidæ, of which the tropical African representatives have hitherto been known by the shells alone, he has been able to show that their affinities are not, as had been supposed, with the European genera of the family, but with the Asiatic. The field notes are contributed by Mr. Herbert Lang, whose account of the bionomics, economic uses, and folk-lore of the giant Achatinidæ is of particular interest. His remarks on the dispersal of certain species over large areas by the agency of man are worthy of note as having possibly a wider application. The memoir is very fully illustrated, and some of the coloured plates are of exceptional beauty.

WE seem to have much to learn about even the commonest of marine organisms, and the exceedingly abundant and almost cosmopolitan protozoon Noctiluca—a frequent cause of luminescence in the sea—has just received at the hands of Prof. C. A. Kofoid, of the University of California, a new interpretation which, if accepted, will necessitate a change in classification involving the removal of that supposed Cystoflagellate from its accustomed position and its incorporation in another group of the Flagellata ("Noctiluca," Univ. of Cal. Publicns. in Zool., vol. xix., No. 10, February, 1920). Prof. Kofoid is the recognised authority on the groups in question, and no one is more competent to express an opinion on the matter. In describing several new and remarkable genera of the Dinoflagellata from the Pacific related to Gymnodinium, he points out that Noctiluca may have its essential morphological characters homologised with those of various new highly specialised tentacle-bearing forms, such as *Pavillardia tentaculifera*. Noctiluca, then, according to these new investigations, is not exceptional amongst Dinoflagellates in bearing a tentacle, and may be interpreted as having a girdle, a sulcus, and two flagella like any other more ordinary Peridinium. The statement, however, that the "tooth" or prehensile organ represents the degenerate transverse flagellum may possibly be regarded as open to doubt. The acceptance of this work means that the order Cystoflagellata, established by Haeckel in 1878 for the reception of Noctiluca, and adopted by most writers since, should be either suppressed or emended. Noctiluca is no longer its type for text-book and lecture.

A CONCISE record of botanical exploration in Chile and Argentina is given in the *Kew Bulletin* (1920, No. 2) by W. B. Turrill. Among the earliest explorers

were the French botanist, Philibert Commerson, who was surgeon and naturalist to Bougainville's expedition (1767-68), and Sir Joseph Banks, who with Daniel Solander accompanied Cook on his first voyage round the world (1768-71), and brought home extensive botanical collections from the southern hemisphere. The collections of the Spanish naturalists, Ruiz and Pavon, at the close of the eighteenth century were the foundation of an important work on the flora of Peru and Chile. John Miers spent several years in La Plata and Chile, accumulated a large herbarium (now at the British Museum), and published monographs of various South American families of plants. Charles Darwin visited Argentina, Chile, and Patagonia, and Sir Joseph Hooker in his work on the Antarctic flora contributed largely to our knowledge of the botany of the Magellanic area. Valuable botanical exploration was also carried out by collectors sent out by the firm of Veitch—William Lobb and Richard Pearce. The Philipps, father and son, worked for nearly fifty years, collecting and publishing extensively on the flora of Chile. These are a few only of the long list of botanists and collectors chronicled by Mr. Turrill, who, in conclusion, points out that there is still scope for botanical exploration, especially on the Argentine side of the Andes.

IN view of the present high prices of sugar, considerable interest is being taken in the question of the possibilities of sugar-beet production in England. The Weekly Service for April 3 from the Ministry of Agriculture and Fisheries contains some useful information on this point. Even apart from the production of sugar, sugar-beet is a useful crop to grow. The food for stock would not be materially reduced by substituting sugar-beet for roots in the rotation, while both leaves and by-products make excellent cattle food. To ensure good crops the land has to be very thoroughly cultivated—a process which reacts favourably on subsequent crops—and there is the further advantage that the crop gives a direct monetary return. Extensive trials were made before the war, and these showed that many parts of the country are suitable for large-scale production of sugar-beet for the manufacture of sugar; but it must be clearly understood that, owing to the bulky nature of the crop and the consequent difficulties of transport, it is advisable to grow beet for sugar production only when the land is within reasonable transport distance of a factory.

STUDENTS of the continental deposits of the Old Red Sandstone and Triassic days may well take note of the illustrative matter provided in South Africa and described concisely by Mr. Wm. Torrance ("Observations on Soil Erosion," Union of S. Africa, Dept. of Agric., Bull. 4, 1919, price 3d.). The numerous photographs are small; but some, like that of the infilled yeli at Grootfontein, are highly suggestive.

AMONG the many well-produced Water-Supply Papers of the United States Geological Survey which have reached us are several dealing particularly with the surface water-supply for the year ending September 30, 1916. Work of this nature was begun many

years ago in connection with studies of irrigation problems in arid areas, but a particular effort was made in 1915-16 to obtain synchronous observations of the flow of streams. The data supplied for each gauging station in the area covered by each report include a description of the station and tables giving the daily, monthly, and yearly discharge. Illustrations of current meters and water-stage recorders are given.

THE reclamation of salt soils is an important agricultural problem in India. Without a soil survey it is impossible to say what area is affected, but in Sind, and to a less extent in the Punjab and the United Provinces, it must be considerable. These so-called alkali lands are either uncultivable or injurious to the growth of crops. "Notes on Practical Salt-Land Reclamation" is the title of a paper published as Bulletin No. 91 by the Agricultural Research Institute, Pusa. Mr. G. S. Henderson, the author of the paper, examines the methods employed in Egypt in the reclamation of Lake Aboukir in the Nile delta, and draws some useful conclusions as to comparable work in India. He insists that the Egyptian method of washing the salt into the subsoil is the only effective way of dealing with the problem. Periodical surface washing is unsatisfactory. It is pointed out, however, that until the Indus barrage is completed there is not enough water in Sind for this purpose, all the available supply being required for irrigation.

THE Germans during the war, when materials were short, gave a certain amount of attention to the utilisation of blast-furnace slags, and succeeded in obtaining a satisfactory cement after many experiments. A new use for slag is foreshadowed in an article in *Stahl und Eisen* (March 4), viz. for the manufacture of light bricks for building purposes. By passing molten slag horizontally through water, the steam generated blows out or extrudes the slag jet, and forms what the Germans term "spume" slag or artificial pumice-stone. This material has been patented under the name of "thermosite," owing to its excellent heat-insulating properties. The patentee has also invented a press for pressing bricks formed of small pieces of this artificial pumice and a mixture of slag, sand, and slaked lime which is used as a binder. The bricks thus formed are strong and light, and resemble in their properties the alluvial (tuff) stone obtained in the neighbourhood of Andernach. As, in addition, they can be pressed to large dimensions, less mortar will be required in building operations. The German authorities have approved of the new type of brick for house-building.

IN the *Revue générale des Sciences* for April M. Florentin gives an interesting account of the French experience of German gas warfare, with full chronological details of its development and an account of the properties of the substances used, as well as of their mode of manufacture. The section of the French Gas Service under M. Kling, director of the Paris Municipal Laboratory, examined about 2400 samples of material, of which half were shells and projectiles, M. Grignard devoting himself specially to the detection

of impurities which might reveal the modes of manufacture. Reference is made to the Central Laboratory of the British at Hesdin under the late Prof. Watson, and the great rapidity with which new enemy materials were detected is attributed to the excellent *camaraderie* which always prevailed between the French and British Gas Services. The article also contains a summary of the report of the French Mission on the chemical works in the area of occupation, including statistics of the output. In conclusion, M. Florentin expresses the hope that the war has demonstrated the inseparability of chemistry and national defence and the importance of developing the scientific and industrial research which was initiated in France by gas warfare.

We have received from Messrs. Wood Bros. Glass Co., Ltd., of Barnsley, a copy of their catalogue of English chemical glassware. The list of apparatus is a comprehensive one, well-arranged and neatly illustrated. Judging by the particulars given, chemists should have no difficulty in obtaining any of the usual flasks, beakers, burettes, gas pipettes, absorption tubes, or other glass instruments employed in the laboratory from the selection offered; and as regards any special apparatus in glass that experimenters may want the makers invite inquiry. Messrs. Wood are old-established glass manufacturers who took up the making of chemical glassware in 1915, and they claim that, following the indications given by Sir Herbert Jackson's work on the composition of various special kinds of glass, supplemented by the investigations of their own staff, they are able to produce ware superior to the best Jena glass in its resistance to the action of strong chemicals. It does not withstand sudden extreme changes of temperature quite so well, but will, it is claimed, stand being plunged whilst at a temperature of 150° C. into cold water, and this is more than sufficient for all ordinary requirements. The shapes and designs of ware adopted are those approved by the Glass Research Committee of the Institute of Chemistry, and it would appear generally that the aim of the makers is the praiseworthy one of producing apparatus of high quality in close relation to scientific needs. A feature is made of standard volumetric apparatus verified and stamped by the National Physical Laboratory.

MR. S. EVERSLED read a paper on permanent magnets in theory and practice to the Institution of Electrical Engineers on May 13. He practically adopts Ampère's theory that the molecules of iron in a magnet are equivalent to electric circuits of no resistance in which electric currents are always flowing. On this hypothesis, and adopting Hopkinson's formula connecting magneto-motive force, reluctance, and flux, he discusses the design and predetermination of permanent magnets. He points out that since in practice the demagnetisation curve of the steel is known, the problem that has to be solved is to find the shape of the minimum volume of steel required to produce a given quantity of external magnetic energy. By making assumptions as to the reluctance of the paths of the magnetic flux, Mr. Evershed proves that the performance

of a permanent magnet can be predicted in certain cases with accuracy. We are not sure, however, whether this is due to the fact that the errors made in his assumptions cancel out one another. We fail to understand his formula for the magnetic conductance between two spherical poles. It would be true if they were at an infinite distance apart, but appreciable errors come in when the distance between them is less than a hundred times the radius of either. It is easy to show that the magnetic conductance between two spherical poles equals  $4\pi$  times the electrostatic capacity between their surfaces. Hence, as the electrostatic capacities have been tabulated, the magnetic conductances could be written down at once with high accuracy. From the engineering point of view the paper is valuable, as the subject is of practical importance to manufacturers.

PROF. W. W. WATTS, lecturing to the South Kensington Branch of the National Union of Scientific Workers on May 27 on "The Evolution of the Bicycle," showed that the development of this, as of any mechanical apparatus, took a similar course to that observed in biological evolution. It was largely a process of trial and error; advance was usually in small details of specialisation, and, as in the case of the high bicycle, development was apt to take place in a "blind lead" by following out a wrong principle. The lecture will be reported in the next issue of the *Scientific Worker*, copies of which can be obtained from the Secretary, N.U.S.W., 19 Tothill Street, S.W.1, by sending a stamped addressed envelope.

KODAK, LTD. (Wratten division), have just issued a new series of nine circular light-filters to facilitate visual work with the microscope. They are 35 mm. in diameter, and so fit the standard turn-out ring usually available in sub-stage fittings. Six are for increasing the contrast in stained or coloured preparations, one is blue and serves for getting the highest resolving power, one a neutral tint for modulating the intensity of the illumination, and the ninth converts the light from metal filament vacuum lamps into the equivalent daylight. This last is also of service with other light sources, such as the new thorium pastille gas lamp and the usual paraffin lamps. Its use gives the same colour values as daylight, and so reduces or eliminates eye-strain when observations are long continued.

IN a small leaflet entitled "Radium Facts," received from Messrs. Watson and Sons, are collected numerous data relating to radio-active substances useful to intending purchasers. From it we learn that, whereas the total production of radium to date by the Standard Chemical Co., of Pittsburgh, was 50 grams of radium element, its present output is at the rate of 18 grams of the element per annum. We understand that this output could be increased to 50 grams of radium element yearly if the demand for such a quantity should arise—a very considerable national asset. It is interesting to observe that the present total available supply of high-grade purity radium in the world is estimated to be about 120 grams.

## Our Astronomical Column.

RETURN OF TEMPEL'S COMET.—Tempel's second periodic comet, discovered in 1873, was detected by Mr. Kudara at Kyoto, Japan, on May 25d. 7h. 10m. G.M.T., in R.A. 20h. 55m. 7s., S. decl.  $4^{\circ} 53'$ . The approximate time of perihelion passage is 1920 July 10-36. The other elements are approximately as follows:— $\omega$   $186^{\circ} 38' 43''$ ,  $\Omega$   $120^{\circ} 37' 59''$ ,  $i$   $12^{\circ} 45' 17''$ ,  $\phi$   $33^{\circ} 54' 21''$ ,  $\mu$  685.881 $''$ . The following ephemeris has been computed for midnight:

		R.A.	S. Decl.	Log $r$	Log $\Delta$
	h. m. s.	° ' "	° ' "		
June	4 ... 21 28 0	4 34	0-1402	9-8077	
	12 ... 21 54 28	4 41	0-1330	9-7739	
	20 ... 22 21 44	5 7	0-1274	9-7440	
	28 ... 22 48 40	5 58	0-1236	9-7166	
July	6 ... 23 15 20	7 15	0-1216	9-6950	

The comet is probably faint, but as it is approaching both sun and earth its brightness should increase perceptibly. It rises half an hour before midnight, and is fairly well placed for observation just before dawn.

DOUBLE STARS.—Since its erection in 1894, the 28-in. equatorial at Greenwich has been mainly used for the observation of double stars; the list included many of special difficulty owing to faintness or close proximity. Mr. J. Jackson has discussed the observations made at Greenwich and elsewhere in Monthly Notices for March, and publishes twenty revised orbits. One of the stars is Struve 2525, for which very discordant values of the period have been found. The new value, 354.9 years, is larger than those previously found, which range from 138 to 307 years. The semi-axis major is  $1.1''$  and the eccentricity 0.93, so that at the time of periastron, 1887.3, the star could not be separated.

The star Struve 2055 had given much trouble to computers; two observations by Sir William Herschel in 1783 and 1802 were mutually inconsistent. Mr. Jackson has unearthed a note that the micrometer reading was not written down at the time, and that the reading entered may be wrong. The quadrant noted is shown to have been correct, and Herschel's other observation in 1802 is well satisfied. The period assigned is 110 years and the eccentricity 0.86.

With respect to notation, he directs attention to diversity in the method of reckoning the angle  $\omega$ , and recommends the general adoption of the system used by Campbell, Aitken, and Hussey, in which it is measured in the direction of motion in the orbit plane.

DIFFRACTION IMAGE OF A DISC.—Mr. H. Nagaoka contributes a useful article on this subject to the *Astrophysical Journal* for March. Diagrams of the "isophotes" are given, and it is shown that the results explain the black drop observed in transits of Venus, and the projection of bright stars upon the moon's disc that has often been observed in occultations at the illuminated limb. A striking case of this phenomenon has lately been noted in the reappearance of the star Leipzig I 4091 from behind Saturn on March 22 last. Messrs. Reid, Dutton, and McIntyre, observing in South Africa, saw the star reappear within the limb of the planet, its conspicuous orange colour facilitating its detection. They give the explanation that the outer portion of Saturn is composed of transparent clouds, but it would seem that the expansion of the disc by diffraction is sufficient to account for it. (*B.A.A. Journal*, April.)

It is of interest to note that in South Africa the star at disappearance passed behind the ring, while in Europe, owing to parallax, it did not. It was clearly visible through the ring, showing that the separate particles composing the ring are not very densely massed.

## Monument to Charles Gerhardt.

NOW that Alsace is once more united to France, it is peculiarly fitting that Strasbourg, his native place and where he lies buried, should be the site of the long-delayed monument it is proposed to erect to the memory of Charles Gerhardt. British chemists who are at all familiar with the history of their science scarcely need to be reminded of the part played by Gerhardt in its development, or of the influence which his writings exercised in the search for methods of elucidating the structure and constitution of chemical compounds.

His "*Traité de Chimie organique*" may be said to mark an epoch; it was a significant feature of a movement which characterises the middle of the nineteenth century, and which the book itself greatly accelerated. Although much of its teaching, as the systematised expression of the facts of organic chemistry, is obsolete, the work is, and will remain, a classic, for it forms the basis upon which the superstructure of modern chemistry is erected. Gerhardt, however, was not only a speculative philosopher of the highest type; he was also an experimentalist of uncommon power and insight who framed his theoretical conceptions in the light of his own ascertained facts, and tested them by further investigations designed either to substantiate or to disprove them. His name is associated with the discovery of many new substances, some of which, like the acid anhydrides, are of the greatest theoretical and practical importance. It may be claimed for him that, together with Dalton and Berzelius, he was one of the principal founders of the atomic theory and the originator of the notation which immediately flows from it.

An influential committee has now been formed to discharge the debt—long overdue—which the chemical world owes to Gerhardt's memory. It comprises the names of some of the most eminent of French men of science and of those of Allied countries, under the presidency of M. Armand Gautier, member of the Institute, with an executive consisting of M. Haller, member of the Institute, as chairman; M. Chenal, treasurer of the French Chemical Society, as treasurer; and M. Tiffeneau, assistant professor of the Faculty of Medicine, as secretary. The object is well worthy of the consideration of British chemists, and may be specially commended to the notice of the Chemical Society and the Society of Chemical Industry if these bodies have not already responded to the appeal.<sup>1</sup>

T. E. THORPE.

## Biological Papers from Bengal.

THE publications of the Asiatic Society of Bengal during the years 1916 to 1919, which we have lately received for review, contain a large number of contributions to biology, showing an activity in this department that has not been surpassed before. If we consider also the publications issued by the Indian Museum, the Calcutta Botanic Gardens, and the flourishing Bombay Natural History Society, we have reason to rejoice over the prosperous state of this branch of knowledge in our Indian Empire. Attention should be made also to the enterprise of Dr. N. Annandale, who, alone or with other members of the Zoological Survey of India, of which he is the director, has in the last seven years investigated the

<sup>1</sup> A circular signed by Sir James J. Dobbie, president of the Chemical Society, has just been issued inviting fellows of the society to contribute to the memorial fund. Such contributions should be sent to the Treasurer, Chemical Society, Burlington House, London, W.1.—ED. NATURE.



macroscopic fauna of various Asiatic lakes, with results that are of the greatest interest.

The Asiatic Society of Bengal issues Memoirs in quarto, and Journal and Proceedings in octavo. In the Memoirs, parts ii. to v. of Dr. Annandale's "Zoological Results of a Tour in the Far East" further testify to the author's wonderful activity and versatility, which are known to all zoologists. In these parts he deals himself with the Hydrozoa and Ctenophora, the Batrachia, the Sponges, and the Mollusca, together with additions to ethnography; whilst other groups have been entrusted to C. A. Paiva (aquatic Hemiptera), Col. J. Stephenson (aquatic Oligochaeta), Dr. Asajiro Oka (Hirudinea), Sir Charles Eliot (Mollusca Nudibranchiata), Tokōi Kaburaki (brackish-water Polyclads), and Stanley Kemp (Crustacea Decapoda and Stomatopoda). Numerous text-figures and five plates illustrate these contributions.

Dr. Annandale's paper on the Hydrozoa and Ctenophora is one of special interest, our knowledge of the Oriental fresh-water forms of these two groups being of rather recent date and, as the author observes, still very imperfect. A new Medusa is described under the name of *Azenathia piscatoris*, g. et sp. nn., from the tidal creeks containing water of low but extremely variable salinity in the vicinity of Port Canning, in the Gangetic Delta. It is referred to the family Olindiadiidae of Mayer (order Trachymedusae), and is regarded as not improbably the sexual generation of the hydroid *Annulella gemmata*, Ritchie.

In the part devoted to the Batrachians, Dr. Annandale deals chiefly with the Oriental frogs of the groups of *Rana tigrina*, *R. limocharis*, and *R. Liebighi*, as well as with the species clustering round *R. Tyleri* and *R. erythraea*; also with various tadpoles from Japan, China, the Malay Peninsula, Burma, and Ceylon. The author's views on *R. tigrina* have since been a subject of discussion between him and Mr. Boulenger in the Records of the Indian Museum, and further differences of opinion between the two authorities will shortly appear in a monograph of the Oriental species of *Rana* to be published by the Indian Museum.

The two marine Sponges (*Reniera implexa*, Schmidt, and *Amorphinopsis excavans*, Carter, var. n. *Robinsonii*) discussed by Dr. Annandale were found growing on the wooden piers of a landing-stage at Port Weld in Perak, Malay Peninsula, and their chief ethnological interest lies in the fact that they grew immediately below high-tide level, and were, therefore, exposed daily for a considerable time to the air and to the heat of a tropical sun. Several new fresh-water Sponges from Japan, China, and the Malay Peninsula are described, and a list of the Spongillidae of Asia, with synonyms, is appended.

Among the Mollusca the hybrid name *Pseudovivipara* for a new genus is a regrettable choice.

A paper in French is a revision of the fungi of the genus *Nocardia*. Toni and Trevisan, by Capt. Froilano de Mello and Dr. St. Antonio Fernandez, of the Portuguese India Bacteriological Service.

The Memoirs contain also a revision of the lizards of the genus *Tachydromus*, with two plates, by Mr. G. A. Boulenger, in which this genus is shown to be very closely connected with *Laereta*, instead of occupying a quite isolated position in the family to which it belongs, as hitherto believed. Two new genera are proposed under the names of *Platyplacopus* and *Apeltonotus*.

In the Journal and Proceedings we have a paper by Bainsi Parshad on the seasonal conditions governing the pond-life in the Punjab. There are three papers on Mollusca: two by E. Vredenburg on the occurrence of *Cypraea nivosus* in the Mergui Archipelago, the only previously recorded habitat of this species being

Mauritius, and of *Dolium variegatum* at Mascat and Karachi, a species hitherto regarded as special to the living fauna of Australia, but recorded from the Pliocene of Java; and one by Dr. Annandale and B. Parshad on the taxonomic position of the genus *Campoceras* and of *Lithotis japonica*. W. H. Phelps describes the weaving habits of the spider *Cyrtophora citricola*, and Maude L. Cleghorn has experiments on the vitality and longevity of silkworm moths during the cold and rainy seasons in Bengal.

Botany is represented by four contributions: Notes on the flora of the Anaimaly Hills, by C. Fisher; on the pollination of flowers, by I. K. Burkill; on the Burmese sesamum varieties, their variation and growth, by A. McKerrall; observations and experiments on the rust of *Launaea asplenifolia*, commonly known as Jangli Gobi, by Karm Chand Mehta; and on the constituents of the bark of *Hymenodactylon excelsum*, by C. L. Gibson and J. L. Simonsen.

### Attainment of High Levels in the Atmosphere.

SCIENCE for March 19 has an article by Prof. Alexander McAdie, of Blue Hill Observatory, on "The Attainment of High Levels in the Atmosphere." A period of 135 years is dealt with, during which various methods and agencies have been employed for exploring the high levels of the atmosphere. Dr. John Jeffries crossed the English Channel in January, 1785, and attained a height of about 2012 metres, and in the following twenty years heights of more than 4000 metres were attained. In September, 1862, Glaisher and Coxwell reached a height of 11,200 metres. Three other noteworthy records by manned balloons are mentioned. Tissandier, Spinetti, and Sivel, acting for the French Academy, attained a height of 8530 metres in April, 1875; Dr. A. Berson reached 9600 metres in December, 1894; and Berson and Stüring in 1901 attained a known elevation of 10,500 metres, and probably 10,800 metres, both men being unconscious at the higher level. Dealing with other than manned balloons, the extreme elevations noted are:—By kites, 7044 metres in 1907; by rigid dirigibles, 6200 metres in 1917; by sounding balloons, 37,000 metres in 1912; and by pilot balloons, height determined by theodolite, 39,000 metres. The aeroplane record has rapidly advanced. In 1909 Latham made 161 metres, and Drexel in 1910 made 1820 metres. Prior to 1914 the maximum height attained, according to Prof. McAdie, was 6000 metres by Perreyon in March, 1913. The war gave a great impetus to the development of the aeroplane, and since the war, in February, 1920, Major R. W. Schroeder, chief test pilot at Dayton, U.S.A., is stated to have attained 10,979 metres; in this ascent the oxygen-supply was exhausted. The 10-km. level is the bottom of the stratosphere or isothermal region, and the top of the troposphere or convective region—an exceedingly important elevation to meteorologists. Schroeder's thermograph indicated a minimum temperature of  $-55^{\circ}$  C., or  $99^{\circ}$  below the freezing point on the Fahrenheit scale.

In *Science* for April 9 Dr. J. G. Coffin, director of aeronautical research of the Curtiss Aeronautical and Motor Corporation, suggests that Prof. A. McAdie has sometimes accepted too readily unauthorised statements made in the Press as to altitudes reached. A criticism is made of expressing results without air-temperature correction, which is not only unsatisfactory, but also scientifically incorrect. The correction is the larger the colder the air encountered in the flight. It is pointed out that it is essential so far as possible for all concerned to work on the same un-

biased scientific basis. Dr. Coffin, to bring out the importance of the air-temperature correction, assumes two cases, both with identically perfect barographs, with no instrumental errors, one ascent in summer and the other in winter to an altitude that both read 8 in. of mercury as the minimum pressure. He assumes that in the summer case the average temperature of the air is  $10^{\circ}$  C., and in the winter  $-30^{\circ}$  C., which values correspond closely to actually observed figures. The true altitudes of these are 33,475 ft. (10,203 m.) for the summer instance and 30,929 ft. (9,427 m.) for the winter, although the altitude uncorrected for air temperature is 36,020 ft. (10,979 m.) for both. Dr. Coffin states that the flight made by Roland Rohlf, the test pilot of the Curtiss Engineering Corporation, on September 18, 1919, attained an altitude of 34,910 ft. (10,640 m.), partially corrected, but uncorrected for the average temperature of the air column; the true altitude was 32,450 ft. (9,890 m.) corrected for air temperature. The altitude attained by Major Schroeder, similarly corrected for temperature, is 30,751 ft. (9,373 m.).

In *Science* of April 30, Prof. McAdie gives as approximate values, corrected for mean air column temperature, vapour pressure, gravity, altitude, and latitude: Rohlf, 32,418 ft. (9,880.5 m.), and Schroeder, 31,184 ft. (9,505 m.).

The *Meteorological Magazine* for March, in an article "The Highest Aeroplane Ascent," mentions Major Schroeder's ascent on February 27 last referred to above, and expresses the hope that it will be authenticated in due course. The record of Berson and Süring, who, it is stated, reached 35,400 ft. (10,789 m.) in a balloon on July 31, 1901, is mentioned as being generally accepted as the greatest height hitherto attained by aeronauts. The article seems to throw some doubt on the lowest temperature observed in the ascent by Glaisher and Coxwell.

### Physical Problems in Soil Cultivation.<sup>1</sup>

UP to the outbreak of the war the farmer could generally rely upon an adequate supply of cheap labour. He had no great necessity to introduce labour-saving machinery into the routine of the farm. But the increasing demands of the Army for men and the menace of the submarine campaign brought him face to face with the difficult problem of growing more food with a greatly reduced staff. In such conditions the employment of machinery was the only solution, and although at the time it was introduced mainly as a temporary measure, it is now quite evident that economic conditions will cause it to be retained permanently. During the war the rate of progress in the industry of agriculture was necessarily forced above the normal, and the urgent need at the present time is to take stock of the position, so that future developments may be guided along the right lines. In this connection the report of the Departmental Committee of the Ministry of Agriculture on Agricultural Machinery appears at an opportune moment. The report deals with "the further steps which should be taken to promote the development of agricultural machinery," and, so far as tillage implements are concerned, falls naturally into two sections, dealing with (1) fundamental research on the physical properties of soil as affected by cultivation operations, and (2) the application of the knowledge thus gained to the design of new implements and the improvement of old ones.

Taking the second section first, the Committee lays great stress on the fact that all development in the design of machinery has proceeded on empirical lines. "Although searching questions were addressed to several witnesses, we could not discover that any real attempt had been made in the past to determine the principles which underlie the design of the variety of implements in use in modern farming." As a result an enormous number of patterns of the same implement are made, one manufacturer alone having more than two hundred and fifty patterns of plough. The Committee considers that much of this overlapping and wasted effort will be avoided when the Ministry of Agriculture sets up its projected Research Institute in Agricultural Machinery.

The first section—research into the physical properties of soil—is regarded, rightly, as of primary importance. "Progress in research as regards tillage implements must depend largely upon the results of investigations into soil physics and the problem of tilth." It is clearly pointed out that this research must not be pursued with the immediate object of obtaining "practical" results. A sound theory of the interesting but complicated physical phenomena shown by soil must first be built up. Once this is achieved, the practical deductions will follow almost automatically. The very nature of this work precludes the possibility of forcing the pace, but it is suggested that, as the work has been in progress for some time at Rothamsted, it should be further developed by the appointment of additional scientific assistants.

If this were done it would be possible to pay more attention to those physical problems concerned with the soil tilth than is practicable at present. Tilth is related to the production of compound particles or aggregates in the soil, and to the factors causing plasticity, cohesion, etc. At the same time a study of the mechanical action of the plough could be started having as its aim the specification of the design of mould-board to meet different soil conditions. This is an unsurveyed field and full of promise.

The report also deals with the educational and research work which should be carried out at the projected Research Institute in Agricultural Machinery, especially from the engineering point of view. It also advocates the appointment of an Advisory Committee, composed of representatives from the research institutions, implement-makers, and agriculturists, to co-ordinate the whole of the work.

In the present article attention has been confined mainly to the sections dealing with the physical questions involved. The report covers a much wider field. It is closely reasoned and convincing, and can be cordially recommended to all concerned in the industry of agriculture.

B. A. KEEN.

### The Anomaly of the Nickel Iron Alloys: Its Causes and its Applications.<sup>1</sup>

THE lecturer began by a reference to the work of John Hopkinson, and to his own early work on the perfecting of standards of length. His first experiments were on nickel, which had two great advantages over brass for metrological work, viz. its smaller coefficient of expansion and its greater freedom from corrosion. He would probably not have looked further but for the difficulty at the time of getting large bars of the material free from flaws. In investigating the

<sup>1</sup> Report of the Departmental Committee of the Ministry of Agriculture on Agricultural Machinery. (H.M. Stationery Office.) Price 12s. net.

<sup>1</sup> Abstract of the Fourth Guthrie Lecture delivered before the Physical Society on April 23 by Dr. C. E. Guillaume.

ferro-nickel alloys, his first experiments were on their magnetic properties, as these were easier to investigate than the coefficients of expansion. Dr. Guillaume showed and explained curves representing the variation of magnetic properties, and of the coefficients  $\alpha$  and  $\beta$  in the expansion equation  $l = l_0(1 + \alpha\theta + \beta\theta^2)$  for alloys in both the irreversible and reversible categories, and showed from the curves how it was possible to obtain alloys with any desired coefficient. The anomalous magnetic behaviour of some of the alloys was illustrated by demonstration experiments of the effect produced on the magnetic condition of bars of the materials by dipping in hot water or liquid air. The lecturer then dealt with the properties of ternary alloys containing iron, nickel, and a third element. Manganese alloys were those most extensively used. He exhibited a cardboard model of Guthrie's three-dimensional diagram for ternary alloys. The addition of the third element raised the minimum expansion. In the case of carbon and chromium the elastic constant is raised. The curve connecting Young's modulus with the percentage of nickel in ferro-nickel alloys also showed an anomaly in the same region as the expansion.

The chief weakness of the alloys from the point of view of the metrologist was instability. If a piece of invar was cooled from a high temperature in air at  $100^\circ\text{C}$ . its length reached a steady value in about 100 hours. If it was then cooled to  $50^\circ\text{C}$ . its length would increase to another steady value, reached in about 1000 hours or so. If it were then cooled to zero it would still further lengthen, a steady state not being reached for a very long time. If the temperature were then raised again to  $100^\circ$ , the length would diminish to its initial value for  $100^\circ$ . The total change of this character between  $0^\circ$  and  $100^\circ$  amounted to about 30 millionths of the length.

With increasing carbon content the instability very rapidly increased. It was possible from the amount of the instability to estimate the carbon to 1/100th per cent. Moreover, the curve connecting the instability and the carbon content passed through zero, showing that the instability was due to the carbon. It was therefore possible to get an invar of perfect stability.

Among the applications to which invar had been put, the lecturer instanced pendulum rods, leading in wires for electric lamps (an alloy being chosen from the curves so as to have the required coefficient of expansion), wire standards for base measurements in surveying, etc., and showed curves of the variation of height of the Eiffel Tower with temperature, as measured relatively to invar wires.

Another important application of these alloys was in chronometer construction. The temperature coefficient of the rate of a watch was due to variation of the elasticity of the hair-spring. This was corrected in the Graham compensation by a variation of angular momentum of the balance wheel, depending on the difference in expansion of two metals; but it was possible to choose for the spring a nickel steel having a temperature coefficient of elasticity nearly zero. If chosen to give the same rate at  $0^\circ$  and  $30^\circ$ , there would be a secondary error of only 20 seconds per day at  $15^\circ$ . But a more important chronometric application was the correction of the secondary error of 2 seconds in Graham's compensation. This error, discovered by Dent in 1832, is due to the fact that the variation of elasticity of the hair-spring is not a linear function of the temperature, whereas the variation of angular momentum of the balance wheel is. If, however, for one component of the bimetallic compensator a nickel steel of negative  $\beta$  be chosen, it is possible to get a curve connecting the momentum

with temperature which exactly compensates the elasticity variation over the whole range.

Reverting to the curves for Young's modulus, the lecturer predicted that an alloy would shortly be produced having a practically constant modulus over a range of  $200^\circ\text{C}$ .

### Technical Education and Mind Training.

THE proceedings of the annual conference of the Association of Teachers in Technical Institutions, which was held in the Polytechnic, Regent Street, London, on Whit-Monday, were full of interest. The president, Mr. E. L. Rhead, of Manchester, gave a stimulating address, in the course of which he reviewed unfavourably the attitude of the Workers' Educational Association towards technical education as tending to narrow the workers' educational outlook, and as merely serving to create a human tool better calculated to promote the interests of employers and the sordid aims of industry. He claimed, on the contrary, that, rightly presented, technical education has in it all the elements of mind training and of a wide view of life and its problems. It may, in short, be properly interpreted, constituted as the pivot of a liberal education. He deprecated the exclusive devotion of much of modern higher education to dead languages, dead history, and ancient philosophy, but that is surely to ignore a prime element in the evolution of mankind—the progress of man in his endeavour to search into and to solve the phenomena of Nature. Mr. Rhead went on to consider the status of the technical teacher as compared with that of the secondary-school teacher, and contended that the former should be at least as liberally considered as the latter, not only by reason of his long and arduous practical training in the processes of industry, but also in respect of the claims of industry itself upon his services. He urged the desirability of transfer from lower to higher schools at different periods in the course of the educational life of the capable pupil, and especially dwelt upon the value of the junior technical school, which he would in no wise desire to convert into a trades school, and pleaded that restrictions on their present aims and curricula should be removed. A far more liberal system of scholarships, including maintenance, should be established in co-operation with widely extended administrative educational areas, which should have regard not only to the pupils in day institutions, but also to the equally urgent requirements of the promising evening students, enabling them to devote themselves to whole-time study in their special vocation. There should likewise be an efficient representation of teachers on all education authorities, so that the present and future problems of technical education should be better considered. Resolutions were passed urging a large increase in salaries for the several grades of technical teachers; that all works continuation schools should ultimately be provided by the local education authorities and the present schools be open to inspection by the local and central authorities; and that a national Whitley council for teachers should be set up.

### University and Educational Intelligence.

CAMBRIDGE.—Prof. J. T. Wilson, professor of anatomy in the University of Sydney, has been elected to the chair of Anatomy rendered vacant by the death of Prof. A. Macalister.

We are informed by the secretary of the Cambridge Philosophical Society that the adjudicators of

the Hopkins prize have made the following awards:—For the period 1903-6 to Dr. W. Burnside, of Pembroke College, for investigations in mathematical science; for the period 1906-9 to Prof. G. H. Bryan, of Peterhouse, for investigations in mathematical physics, including aerodynamic stability; and for the period 1909-12 to Mr. C. T. R. Wilson, of Sidney Sussex College, for investigations in physics, including the paths of radio-active particles.

Dr. T. G. Adami, Vice-Chancellor of the University of Liverpool, has been elected to an honorary fellowship at Christ's College.

An offer of 30,000*l.* has been made to the University by the Committee of Council for Scientific and Industrial Research for the erection, equipment, and maintenance at Cambridge of a low-temperature station for research in biochemistry and biophysics. The proposal emanates from the Research Board of the Department charged with the co-ordination of researches related to the scientific problems arising out of the preservation and handling of food. It is desired to erect the new station close to the existing biological laboratories, where a large proportion of the researches initiated by the Board have been carried out. It is proposed to vest the management of the station in a committee of the Senate containing some members nominated by the Department of Scientific and Industrial Research. The director of the station would be appointed by the Lord President of the Council after consideration of a report by the committee.

LIVERPOOL.—A Congregation of the University was held in St. George's Hall on Friday, May 28, when honorary degrees were conferred. Mr. J. W. Alsop, Pro-Chancellor of the University and chairman of the Liverpool Education Committee; Sir Alfred Booth, chairman of the Cunard Steamship Line; Sir Alfred Dale, the former Vice-Chancellor of the University; Mr. John Rankin, a leading citizen and merchant of Liverpool; and Sir Michael Sadler, Vice-Chancellor of the University of Leeds, received the degree of Doctor of Laws. Sir Reginald Blomfield, a member of the Royal Academy and past-president of the Royal Institute of British Architects, and Mr. Frederick Powicke, professor of medieval history in the University of Manchester, received the degree of Doctor of Letters. The degree of Doctor of Science was conferred on Prof. F. G. Dornan, formerly professor of physical chemistry in the University, and now professor of chemistry in University College, London, and on Prof. W. A. Herdman, formerly Derby professor of natural history, and now professor of oceanography, in the University. Mr. Henry Martin, chairman of the St. Helens Higher Education Committee, and representative of the borough on the Court of the University, and Father Thomas J. Walshe, a distinguished scholar, and formerly chaplain and lecturer at the Notre Dame College in Liverpool, were given the degree of Master of Arts. Mr. Joseph Gibson, a leading engineer and president of the Liverpool Engineering Society, received the degree of Master of Engineering.

LONDON.—Two lectures, entitled "Emploi des métaux ammoniums en Chimie Organique" and "L'Œuvre Scientifique d'Henri Moissan," will be given at King's College, Strand, W.C., by Prof. P. Lebeau, professeur à l'École Supérieure de Pharmacie, Université de Paris, at 5 p.m. on Monday, June 28, and Wednesday, June 30. The lectures, which will be delivered in French, are addressed to advanced students of the University and to others interested in the subject. Admission is free, without ticket.

OXFORD.—The honorary degree of Doctor of Letters has been conferred on Dr. Temistocle Zammit, professor of chemistry in the University of Malta and curator of the Valetta Museum.

It was resolved by Convocation on June 1 to confer the title of professor on Dr. T. R. Merton, Balliol College, so long as he continues to hold the office of reader in spectroscopy.

ST. ANDREWS.—The Senatus Academicus will confer the following honorary degrees at the public graduation ceremonial to be held on July 2:—LL.D.: Sir Dugald Clerk; Dr. Léon Frédéricq, for nearly forty years professor of pathology in the University of Liège, Belgium; Mr. R. A. Herman, fellow and lecturer of Trinity College, Cambridge; Mr. W. J. Matheson, New York, U.S.A.; Dr. N. K. Smith, professor of logic and metaphysics in the University of Edinburgh; and Dr. N. Walker, his Majesty's Inspector of Anatomy for Scotland.

THE medal of honour of the University of Brussels was presented by the Vice-Chancellor on May 22 to Lord Dawson of Penn, Sir Leslie Mackenzie, and Prof. Sir William Smith.

PROF. E. F. NICHOLS has resigned the chair of physics held by him at Yale University to take up the post of director of pure science in the Nela Research Laboratories of the National Lamp Works of the General Electric Co. at Cleveland, Ohio.

In connection with the London County Council's lectures for teachers on recent developments in science, a lecture on "The World-Problem of Nitrogen" will be given by Prof. F. G. Dornan at University College, Gower Street, W.C.1, on Monday next, June 7, at 6 p.m. The chair will be taken by Lord Moulton.

A PUBLIC meeting in support of the claim of the Imperial College of Science and Technology for degree-conferring power and university status will be held at the Central Hall, Westminster, to-morrow, June 4, at 5 p.m. Lord Morris will preside, and will be supported by Sir Arthur Acland, Bart., Sir Alfred Keogh, Col. Sir Pierre van Ryneveld, Mr. H. G. Wells, Mr. J. A. Spender, and others.

THE foundation-stone of the new wing of the London School of Economics was laid by the King on Saturday last, May 29. His Majesty was accompanied by the Queen and Princess Mary, and the Royal party was received by Dr. Russell Wells, Vice-Chancellor of the University of London. In an address Dr. Wells referred to the meeting held at the Mansion House in 1918, when it was determined to institute London degrees in commerce, and to collect funds in order to found and endow in the University what it is hoped would ultimately become the greatest school of commerce in the world. As a result of the response to the appeal of the University by the bankers, shippers, and merchants of London, and the substantial contribution of Sir Ernest Cassel, through the Cassel Trustees, the sum of more than 300,000*l.* was obtained towards the founding and endowing of the scheme for commercial education. In the course of his reply the King said:—"I am fully sensible of the patriotic work which has been accomplished by the universities during the war, of their instinctive and immediate response to the call of duty, of their heavy burden of sorrow and loss, of their varied and brilliant contributions to the science of modern warfare, and of the extent to which their normal activities have been suspended or deflected by five years of national peril. It is for this reason the more gratifying to me to note that the University of London, which has grudged nothing of its youth and valour to our armies in the field, has been planning the development of

new spheres of usefulness in the furtherance of the fruitful arts of peace. Three centuries ago Francis Bacon censured the universities of his own age as the homes of ignorant dogma and sterile disputation. The bad and narrow tradition which was then attacked has long since disappeared, and the circle of academic studies has been steadily enlarged by the pressure of scientific ideas and of practical needs without injury to the claims of a broad and humane education. When estate management, horticulture, and commerce are included in the curriculum, a university can no longer be described as a place in which nothing useful is taught. It is right and fitting that the new faculty of commerce should be linked to the London School of Economics, which has for many years enjoyed the reputation of being one of the principal centres of economic inquiry in my Empire, and I regard it as no less appropriate that a university situated at the very heart of our commercial system should now resolve to turn the dispassionate and illuminating eye of science upon the facts and principles of commercial life."

### Societies and Academies.

LONDON.

**Royal Society, May 20.**—Sir J. J. Thomson, president, in the chair.—Prof. J. N. Collie: Some notes on krypton and xenon. In the paper the measurements of a considerable number of new spectroscopic lines at the red end of the spectrum are given; and a curious property of xenon has been noted. In tubes containing xenon, when a strong current from an induction coil is passed, much splashing of the electrodes occurs, and the xenon disappears as a gas. What becomes of the xenon is not clear, as it does not seem to be liberated again, either by strongly heating the metallic splash or by dissolving up the splash in suitable solvents.—Sih Ling Ting: Experiments on electron emission from hot bodies. Experiments on the electron currents from a platinum disc in a uniform field made by Prof. Richardson in 1907-9 showed that under the conditions of these experiments the distribution of velocity among the emitted electrons was very close to the requirements of Maxwell's law for a gas of equal molecular weight and temperature, but it was noted at the time that rough tests made on the liquid alloy of sodium and potassium, on platinum coated with lime, and on platinum saturated with hydrogen indicated an exceptional behaviour. The further investigation of these substances was postponed owing to technical difficulties and to the pressure of other problems. In 1914 Schottky investigated the electrons emitted from tungsten and carbon, and found a distribution of energy in close accordance with Maxwell's law, except that the mean energy varied between 2 per cent. and 25 per cent. in excess of that calculated from the filament temperatures. Errors in the estimation of these temperatures and in other directions might, however, have accounted for these discrepancies. The present experiments show that deviations from Maxwell's law, if not general, are at any rate quite common. With tungsten and platinum in a well-exhausted enclosure a common distribution is one which satisfies the requirements of Maxwell's law, except that the average electron energy is in excess of (frequently about twice as great as) that corresponding to the temperature of the source. Other cases have been recorded in which the velocity distribution has a different functional form.—L. Silberstein: The aspherical nucleus theory applied to

the Balmer series of hydrogen. The general formulæ for spectrum emission by atomic systems containing an aspherical nucleus, given by the author in a previous paper (*Phil. Mag.*, vol. xxxix., p. 76), are now applied to hydrogen atoms the nuclei of which are treated as axially symmetrical charged distributions. The asphericity and the value of the Rydberg factor are determined from Mr. Curtis's observations of H $\alpha$  up to H $\gamma$ . The series formula thus resulting (and containing but two constants) is shown to agree well with the six observations. The value of the asphericity coefficient is then used to determine the fine structure of the members or groups of the Balmer series, more especially of the groups H $\alpha$  and H $\beta$ , which are discussed in some detail.—T. E. Stanton, Miss D. Marshall, and Mrs. C. N. Bryant: The conditions at the boundary of a fluid in turbulent motion. Observations were made on air flowing through long pipes of circular cross-section at mean rates of flow covering as wide a range as possible below and above the critical speed. Dimensions of pipes used were 0.269, 0.714, and 12.7 cm. in diameter. Range in experimental conditions varied from  $vd/\nu=460$  to  $vd/\nu=325,000$ , where  $v$  is mean speed of flow,  $d$  diameter of pipe, and  $\nu$  kinematic viscosity of air. Estimation of velocity of fluid in neighbourhood of boundary was made from observations of difference in pressure existing in a small Pitot tube facing the direction of flow, and that in a hole in the wall of the pipe. The Pitot was of rectangular section, external dimensions at orifice being 0.1×0.8 mm. and internal dimensions 0.05×0.75 mm. By this means observations could be made up to a distance of 0.05 mm. from the wall. For distances less than this, by a special device the wall of the Pitot nearest the wall of the pipe was cut away and its place taken by the wall of the pipe. By this means observations could be taken at a distance of 0.01 mm. from the walls. From a comparison of the curves of velocity distribution near the boundary, obtained from observations with the Pitot and the composite tube, it was found that in the case of the former the interference with the flow near the orifice by side of tube adjacent to boundary was considerable. Velocity curves obtained from the composite tube, when further corrected for interference, were found to tend to a definite slope at boundary, which was identical with that which would exist in a layer of fluid in laminar motion and having the same surface friction as that actually measured.

**Linnean Society, May 6.**—Dr. A. Smith Woodward, president, in the chair.—Dr. G. P. Bidder: Sponges. (1) The fragrance of calcinean sponges. Clathrinidae have a noticeable aromatic scent, probably due to the excretory granules which give their bright colours. These granules especially surround the pores. May this be to attract the spermatozoa? The author has not seen the fine-lashed spermatozoa of Poléjaeff, but in Sycon has observed a stiff-tailed organism—possibly the result of curious gregarine-like objects produced in cells resembling gonocytes. (2) *Syncrypta spongiorum* (wrongly assigned to *Pandorina* in his MS.) the author gives as a name to the "alga" above-mentioned. He suggests that it is a dangerous parasite, against which *Grantia compressa* has a successful phagocytosis, but that certain other sponges are hosts for its Palmella stage. (3) Notes on the physiology of sponges. (a) Cercids, proposed as a name for the "minute wandering cells." (b) Cessation of the current in sponges. (c) Differences between *Calcinea* and *Calcaronea* in their porocytal granules and odour. (d) The excreta of collar-cells are gelatinous globules containing dark particles. Probably Dendy is right in comparing these to the "spermatozoon-heads" of Poléjaeff, which may be the ultimate residue of victorious

phagocytosis. (e) Origin of sponges. Archæocytes may have been differentiated into external excretory cells and internal reproductive cells; the former engulfed ceroids, but only to pass them on to the latter. By abbreviation of this process the excretory cells may have become self-perforating porocytes, which were then adapted to supply water to flagellate cells in the centre of a Protospongia-like colony, thus converting it into an elementary Olynthus.

**Royal Meteorological Society, May 19.**—Mr. R. H. Hooker, president, in the chair.—Dr. Griffith Taylor: Agricultural climatology of Australia. The author, after indicating briefly the diversity of climates in Australia, pointed out the extreme importance of the rainfall, more so than in most other countries, as the controlling factor in the settlement of the country; also that the season at which rain falls and the certainty of its occurrence (its "reliability") were as important as the total amount. The greater proportion of the wheat-lands lay in regions receiving less than 20 in. of rain per annum, while the crop can be grown with as little as 7 in. if it falls at the right time. Sugar-cane is confined to the eastern coast, where the rainfall exceeds 40 in. and the temperature 68° F. The hay crop is also important, and in dry seasons when the grain fails includes a large bulk of cereals. Ninety per cent. of the sheep are in the south-eastern third of the continent; a rainfall of at least 10 in. and a temperature below 77° are required for them. Cattle are reared more in the north-east. The great variability of the rainfall frequency results in serious droughts and consequent failure of the cereal crops and reduction of flocks and herds; but it is hoped that these recurrent losses will become less serious in time with the progress of irrigation, though Dr. Taylor is not sanguine that irrigation will open up to settlement the enormous areas that seem to be anticipated by some writers.—J. E. Clark and H. B. Adames: Report on the phenological observations for the year 1919. The dominant factors in 1919 were the excessive wetness until April and drought in May and early June, lasting or reappearing until October or later. The abnormally warm December of 1918 was followed by four months universally cold, closing with heavy snow in the last week of April. Then hot summer weather in May and early June preceded a detrimental six weeks or more of abnormal cold. Cold recurred after August, culminating in a November deficiency beyond most records. In consequence, summer-growing garden crops (such as celery and cauliflour) were poor and most field crops short, though fairly good, especially potatoes. Of tree-fruits only plums and apples cropped heavily, the latter ripening and colouring to a degree rarely known, and excelled only by the wonderful autumn tints—both, no doubt, due to the dry and sunny autumn. As to the tables, the four earliest flowers were nine days late, but the effect of May was to make the last four decidedly early. The early migrants were late, especially the nightingale. The 1919 isophenes were seven days further south than in 1918. The number of observers has been further reduced from war effects, barely exceeding 100, but 1920 prospects are such that at least a 100 per cent. increase is probable. The areas worst represented are Wales, the south-west of Ireland, and the north-west of Scotland. Observers from these parts will be most welcome.

#### MANCHESTER.

**Literary and Philosophical Society, April 20.**—Sir Henry A. Miers, president, in the chair.—W. J. Perry: The origin of warlike States. In previous papers the author has put forward the theory that, speaking generally, warlike States are those with an hereditary

military aristocracy. In an examination of the ruling groups of the chief historical peoples, Teutonic, Turkic-Tartar, Semitic, the facts suggest their beginning as small groups claiming divine descent. These groups seem to be of "matriarchal" origin, and the chief religious feature was the cult of the Great Mother. Just after the new groups of rulers had been formed, the institutions became patrilineal, and the Great Mother was replaced by gods. Study of the practice of heraldry verifies the author's theory. This law of "dynamic continuity," if true, leads to the conclusion that all ruling classes in the world are derived from one original group; and this result harmonises with Prof. Elliot Smith's claim that all civilisation originated in the *Ægypto-Sumerian* region.

#### PARIS.

**Academy of Sciences, May 10.**—M. Henri Deslandres in the chair.—C. Guichard: Networks and congruences conjugated with respect to a linear complex.—Prof. W. H. Perkin was elected a correspondant for the section of chemistry in succession to M. Ciamician, elected foreign associate.—P. Bouteux: A family of multifunctional functions defined by differential equations of the first order.—M. Janet: Systems of equations of derived partials.—G. Cerf: The analysis of anti-symmetrical tensors and the symbolic forms of differentials.—C. Camichel: Application of the principle of images to water-vessels.—Th. De Donder and H. Vanderlinden: New fundamental equations in generalised co-ordinates.—J. Carvallo: A new universal method of measuring and compensating instrumental astigmatism.—A. Kling and A. Lassieur: The separation of tin and antimony. The estimation of tin by cupferron. The antimony is separated as sulphide in hydrofluoric acid solution, boric acid added to the filtrate to convert the hydrofluoric acid into fluoboric acid, and the tin precipitated by cupferron.—F. Bourion and Ch. Courtois: A method of modified enrichment in the analysis of commercial chlorobenzenes. Some refinements on a method described in an earlier communication.—G. Tanret: Pelletierine and methyl-pelletierine. Hess and Eichel were unable to isolate the optically active alkaloid pelletierine, and could only obtain the inactive isomer isopelletierine; hence they propose that the name isopelletierine should be dropped. In the present paper experimental confirmation of the work of Ch. Tanret on the optically active alkaloid is given.—A. Mailhe: A new preparation of amines by catalysis. The hydrazines obtained from acetaldehyde, isobutyraldehyde, and from valerolaldehyde heated with hydrogen in presence of nickel give mixtures of primary, secondary, and tertiary amines.—A. Guéhard: The planet Mars and "igneous sedimentation."—R. Souèges: The embryogeny of the Solanaceæ. Development of the embryo in Nicotiana. Nine diagrams are given showing the principal steps in the development of the embryo. The statement of Hanstein, that the embryo of Nicotiana develops according to laws comparable with those observed in Capsella, is shown to be inexact.—A. Chevallier: Researches on the Amygdalaceæ and the apple-trees of the cooler parts of Indo-China and of the south of China.—A. Piedallu, P. Malvezin, and L. Grandchamp: The treatment of the blue casse of wines. Oxygen gas in very minute bubbles, produced by forcing the gas under pressure through the walls of a porous porcelain filter, can rapidly convert the ferrous salts into ferric salts. The wines clarify readily, and are reduced to a normal state.—L. Bertin: Remarks on the buccal and feeding apparatus in some Coleoptera.—P. Courmont and A. Rochaix: The action of the microbial flora of sewage effluents purified by the activated-sludge method on carbohydrates.

May 17.—M. Henri Deslandres in the chair.—G. **Bigordan**: Lechevalier at the Observatory of Saint-Geneviève. The co-ordinates of this observatory.—M. **Hamy**: A particular case of diffraction of the images of circular stars of large diameter.—L. E. Dickson was elected a correspondent for the section of geometry in succession to M. Cosserat, elected non-resident member.—P. **Humbert**: The general solution of the system which satisfies the function  $W(x, y)$ .—N. **Pipping**: A criterion for real algebraical numbers, based on a direct generalisation of Euclid's algorithm.—J. **Drach**: The spiral compensator and new problems of the mechanics of regulation. The spiral compensator of M. Guillaume, obtained by addition of a third or a fourth metal to an iron-nickel alloy, is the first example of a solid the elasticity of which increases with the temperature. The application of this to the control of chronometer balance-springs is discussed, and reasons are given for supposing that the chronometer will equal the astronomical clock in accuracy.—Ch. **Frémont**: The genesis of cracks in certain axes.—P. **Morin**: The study of flow over a weir with the aid of chronophotography.—M. **Battestini**: The optimum magnification of a telescope. The magnification of a reading telescope should be reduced proportionally to the square root of the illumination of the field.—L. **Thielemans**: Calculations and diagrams of lines carrying energy to great distances.—G. **Bruhac**: The properties of fluids in the neighbourhood of the critical point and the characteristic equations.—J. **Villey**: The discussion of Michelson's experiment.—C. **Zenghells** and B. **Papaconstantinos**: The acceleration of the decomposition of hydrogen peroxide by colloidal rhodium. From measurements of the velocity constants the reaction is shown to be unimolecular. If the solution of colloidal rhodium is treated with a current of hydrogen or carbon monoxide the reaction is accelerated.—F. **Bourion**: The impurities of the benzene extracted from commercial chlorobenzenes. Normal hexane and heptane have been isolated, and also chloroform, from benzene extracted from commercial chlorobenzene.—C. **Matignon** and Mlle. **Marchal**: The prolonged action of carbon dioxide on silicates and quartz. Six minerals and glass were submitted to the action of a solution of carbon dioxide in water under a pressure of 10 atmospheres for a period of ten years and three months. The quantities of silica in solution were estimated, and the minerals after this exposure examined microscopically for evidence of attack. Quartz, wollastonite, mica, talc, diopside, and asbestos showed signs of corrosion. With glass the corrosion was scarcely perceptible.—J. **Bougault** and J. **Perrier**: The action of hydrocyanic acid on glucose: Kiliani's reaction. In solutions faintly acid, even as weak as hundredth normal, the combination between hydrocyanic acid and glucose does not take place, and this would also appear to be the case in neutral solution. A slight alkalinity, even as small as that derived from the glass containing vessel, determines the reaction, which is therefore probably between glucose and alkaline cyanide. The reaction between potassium cyanide and glucose was quantitatively studied, and proved to be bimolecular.—L. **Cayeux**: The Hettangian iron minerals of Burgundy. The iron mineral at Beauregard is not oolitic, but the whole of the oxide of iron is a substitution product for calcium carbonate.—Ph. **Négris**: The alternatives of the Glacial and Inter-Glacial epochs during the Quaternary period.—G. **Ferrounnière**: An Eifel layer of the Basse-Loire synclinal.—A. **Boutaric**: The intensity of nocturnal radiation at high altitudes.—E. **Rothé**: A new electrical anemometer. For observations of wind velocities at high altitudes the anemometer is carried in a small captive balloon, and

the anemometer vane serves as an interrupter, which at each contact puts in action a small electrical oscillator. At the base of the cable holding the balloon is a small receiving apparatus for detecting wireless signals. The indications of several instruments fixed at different heights up the cable can be received simultaneously.—G. **André**: The exosmosis of the acid principles and sugars of the orange.—P. **Bugnon**: The structure of certain fibro-vascular bundles in the stems of the Gramineæ.—H. **Piéron**: The variation of the energy as a function of the time of stimulation for peripheral vision.—A. **Mayer**, H. **Magne**, and L. **Plantefol**: The reflexes provoked by irritation of the respiratory passages. Action of the general exchanges of the organism. The irritation of the terminations of the trigeminal nerve in certain mammals has the effect of causing, for more than half an hour, a reflex diminution of the general exchanges of the organism. These may be lowered to a value very small compared with the normal.—A. **Desgrez** and H. **Bierry**: Nitrogen equilibrium and lack of vitamins.—R. **Hovasse**: The number of chromosomes in parthenogenetic tadpoles.—M. **Delage**: Remarks on the preceding communication.—J. **Legendre**: The food régime of *Carassius auratus* in Madagascar.

### Books Received.

- The Story of a Cuckoo's Egg. By H. Terras. Pp. 95. (London: The Swarthmore Press, Ltd.) 6s. net.
- A Primer of Air Navigation. By H. E. Wimperis. Pp. xiv+128. (London: Constable and Co., Ltd.) 8s. 6d. net.
- The Identification of Organic Compounds. By the late Dr. G. B. Neave and Prof. I. M. Heilbron. Second edition. Pp. viii+88. (London: Constable and Co., Ltd.) 4s. 6d. net.
- The Blind: Their Condition and the Work being done for them in the United States. By Dr. H. Best. Pp. xxviii+763. (New York: The Macmillan Co.; London: Macmillan and Co., Ltd.) 21s. net.
- Australian Meteorology: A Text-book, including Sections on Aviation and Climatology. By Dr. Griffith Taylor. Pp. xi+312. (Oxford: At the Clarendon Press.) 12s. 6d. net.
- Keys to the Orders of Insects. By F. Balfour-Browne. Pp. vii+58. (Cambridge: At the University Press.) 7s. 6d. net.
- Beauty and the Beast: An Essay in Evolutionary Aesthetic. By S. A. McDowall. Pp. vii+93. (Cambridge: At the University Press.) 7s. 6d. net.
- Thermodynamics for Engineers. By Sir J. A. Ewing. Pp. xiii+383. (Cambridge: At the University Press.) 30s. net.
- A Text-book of Physiology. By Prof. R. Burton-Opitz. Pp. 1185. (Philadelphia and London: W. B. Saunders Co.) 32s. 6d. net.
- Intermediate Text-book of Chemistry. By A. Smith. Pp. vi+520. (London: G. Bell and Sons, Ltd.) 8s. 6d. net.
- An Elementary Treatise on Differential Equations and their Applications. By Prof. H. T. H. Piaggio. Pp. xvi+216+xxv. (London: G. Bell and Sons, Ltd.) 12s. net.
- Problems in Physical Chemistry: With Practical Applications. By Dr. E. B. R. Prideaux. Second edition. Pp. xii+204. (London: Constable and Co., Ltd.) 18s. net.
- La mort et son mystère: Avant la Mort. By C. Flammarion. Pp. 401. (Paris: E. Flammarion.) 6.50 francs net.
- An Introduction to Entomology. By Prof. J. H.

Comstock. Part I. Second edition. Pp. xviii+220. (Ithaca, N.Y.: The Comstock Publishing Co.) 2.50 dollars net.

Plant Indicators: The Relation of Plant Communities to Process and Practice. By F. E. Clements. Pp. xvi+388+92 plates. (Washington: Carnegie Institution of Washington.)

Carnegie Institution of Washington. Year Book No. 18, 1919. Pp. xvi+380+plate. (Washington: Carnegie Institution of Washington.)

Egyptological Researches. Vol. iii. By W. Max Müller. Pp. 88+40 plates. (Washington: Carnegie Institution of Washington.)

Elementary Agricultural Chemistry. By H. Ingle. Third edition. Pp. ix+250. (London: C. Griffin and Co., Ltd.) 5s.

## Diary of Societies.

### THURSDAY, JUNE 3.

INSTITUTION OF GAS ENGINEERS (at Institution of Mechanical Engineers), at 10 a.m.—Society of British Gas Industries: Carbonisation.—H. J. Goddard and Prof. J. W. C. Orr: Experiments in Gas Production.—J. Fisher: Electricity Supply by Gas Companies.—G. Warburton: Contemplations on the Report of the Fuel Research Board.

ROYAL HORTICULTURAL SOCIETY (at Royal Gardens, Chelsea), at 3.—Capt. H. J. Page: Green Manuring—Its Possibilities in Horticulture.

ROYAL INSTITUTION OF GREAT BRITAIN, at 3.—William Archer: Dreams with Special Reference to Psycho-Analysis.

ROYAL SOCIETY, at 4.30.—Sir Ernest Rutherford: The Nuclear Constitution of the Atom (Rakerian Lecture).

LINNEAN SOCIETY OF LONDON, at 5.—R. Swainson-Hall: Exhibition of 50 Drawings of the Oil Palm, *Elais guineensis*.—A. Whitehead: Objects Observed near Basra during the War.—Prof. W. J. Dakin: Whaling in the Southern Ocean.—Dr. R. R. Gates: Demonstration of Chromosomes in the Pollen Development of Lettuce.

CHEMICAL SOCIETY, at 8.—M. O. Foster and W. B. Saville: Studies in the Camphor Series. Part XXXVIII. The Cyanohydrate of Camphorquinone.—R. G. Fargher: Arsenic Acids derived from Guaiacol and Veratrole.—G. T. Morgan and D. C. Vining: Diphenylarsenous Chloride and Cyanide. (Diphenylchloroarsine and Diphenylcyanarsine).—J. F. Challenger and A. E. Goddard: Organo-derivatives of Bismuth. Part III. The Preparation of Derivatives of Quinquevalent Bismuth.—I. N. Ray: Modification and Extension of Friedel-Crafts' Reaction. Part I.—F. Arnall: The Determination of the Relative Strengths of some Nitrogen Bases of the Aromatic Series and of some Alkaloids.—J. C. Ghosh: The Electrical Conductivity of Pure Salts in the Solid and Fused States; Determination of the Activity Coefficients of Ions in Solid Salts.—W. J. Sanderson and W. J. Jones: Anethole as Solvent in the Cryoscopic Method of Determining Molecular Weight.

ROYAL SOCIETY OF MEDICINE (Obstetrics and Gynaecology Section), at 8.—Dr. P. Turner: Traumatic Rupture of the Pedicle of a Sub-Peritoneal Fibroid.—Dr. F. Anderson: A Case of Rupture of the Uterus.—Dr. F. Shaw and Dr. Burrows: Radical Cure of Advanced Carcinoma of the Cervix, made Possible by the Application of Radium.—G. Ley: The Pathology of Accidental Haemorrhage.

### FRIDAY, JUNE 4.

ASSOCIATION OF ECONOMIC BIOLOGISTS AND IMPERIAL ENTOMOLOGICAL CONGRESS.—Joint Meeting (at the Rothamsted Experiment Station), St. Pancras Station to a.m. train.

ROYAL SOCIETY OF ARTS (Indian and Colonial Sections, Joint Meeting), at 3.—Prof. Sir John Cadman: The Oil Resources of the British Empire.

ROYAL INSTITUTION OF GREAT BRITAIN, at 9.—Sir Ronald Ross: Science and Poetry.

### SATURDAY, JUNE 5.

ROYAL INSTITUTION OF GREAT BRITAIN, at 3.—Dr. J. H. Jeans: The Theory of Quanta.

### MONDAY, JUNE 7.

INSTITUTE OF ACTUARIES, at 5.—(Annual General Meeting.)  
ROYAL INSTITUTION OF GREAT BRITAIN, at 5.—(General Meeting.)  
SOCIETY OF CHEMICAL INDUSTRY (at Institute of Chemistry), at 8.—(Informal Meeting.)

ROYAL INSTITUTE OF BRITISH ARCHITECTS, at 8.—(Election of Council.)  
ROYAL SOCIETY OF ARTS, at 8.—Dr. W. Rosenhain: Aluminium and its Alloys (Cantor Lecture).

ROYAL GEOGRAPHICAL SOCIETY (at Eolian Hall), at 8.30.—Prof. G. A. F. Molengraff: Ocean Research in the Dutch East Indies.

### TUESDAY, JUNE 8.

ROYAL PHOTOGRAPHIC SOCIETY OF GREAT BRITAIN, at 7.—Dr. W. H. Mills and Sir Wm. J. Pope: Studies on Photographic Sensitizers. Part II. (Sensitizers of the Type of Pinaconol or Sensitol Red.)—G. I. Higson: A Simple Form of Non-intermittent Exposure Machine.—Mr. Offer: Examples of Photographs in Colour taken during Theatrical Performances.—(Lectures under the Control of the Scientific and Technical Group.)

### WEDNESDAY, JUNE 9.

GEOLOGICAL SOCIETY OF LONDON, at 5.30.—Dr. C. G. Knott: Earthquake Waves and the Elasticity of the Earth.  
INSTITUTION OF ELECTRICAL ENGINEERS (Wireless Section) (at Institution of Mechanical Engineers), at 6.—M. Latour: High Frequency Machines.  
BRITISH PSYCHOLOGICAL SOCIETY (Education Section) (at College of Preceptors), at 6.—W. H. Winch: Equal Additions versus Decomposition in Teaching Subtraction: An Experimental Research.

### THURSDAY, JUNE 10.

INSTITUTION OF MINING ENGINEERS (at Geological Society), from 11 a.m. to 5.—(General Meeting.)—Prof. H. Louis: Compensation for Subsidence.—W. Maurice: The Fleissner Singing-flame Lamp.—W. Maurice: The Wolf-Pokorny and Wiede Acetylene Safety-lamps.—G. Oldham: The "Oldham" Cap Type Miner's Electric Safety-lamp.—Discussion on "First Report of the Committee on the Control of Atmospheric Conditions in Hot and Deep Mines."—D. S. Newey: A New Method of Working Thick Seams of Coal at Baggeridge Colliery.—T. G. Bocking: Protractors.—T. G. Bocking: Magnetic Meridian Observations; A Method of Utilising the Key Observatory Records.

ROYAL SOCIETY, at 4.30.—*Probable Papers*.—A. V. Hill and W. Harree: The Thermo-Elastic Properties of Muscle.—Sir James Dobbie and J. J. Fox: The Absorption of Light by Elements in the State of Vapour: (1) Selenium and Tellurium; (2) Mercury, Cadmium, Zinc, Phosphorus, Arsenic, Antimony.—H. G. Cannon: Production and Transmission of an Environmental Effect in *Simonephalus vetulus*.—E. C. Grey: The Enzymes of *B. coli communis* which are Concerned in the Decomposition of Glucose and Maltitol. Part IV. The Fermentation of Glucose in the Presence of Formic Acid.—L. T. Hogben: Studies on Synapsis. II. Parallel Conjugation and the Prophase Complex in *Paripentaria*, with Special Reference to the Premiotic Telophase.

LONDON MATHEMATICAL SOCIETY, at 5.

ROYAL COLLEGE OF PHYSICIANS OF LONDON, at 5.—Dr. A. F. Hurst: The Psychology of the Special Senses and their Hysterical Disorders (Croonian Lecture).

OPTICAL SOCIETY, at 7.30.—Miss A. B. Dale: Accuracy of Setting.—Dr. J. S. Anderson: A New Method of Immersion Refractometry.  
INSTITUTE OF METALS (at Institution of Mechanical Engineers), at 8.—Prof. C. A. F. Benckeds: The Recent Progress in Thermo-Electricity (Annual Meeting Lecture).

### FRIDAY, JUNE 11.

INSTITUTION OF MINING ENGINEERS (at Geological Society), from 11 a.m. to 5.

ROYAL ASTRONOMICAL SOCIETY, at 5.

PHYSICAL SOCIETY OF LONDON, at 5.—Dr. T. Barratt and A. J. Scott: Radiation and Convection from Heated Surfaces.—J. S. G. Thomas: An Electrical Hot-Wire Inclino-meter.—L. F. Richardson: Convective Cooling and the Theory of Dimensions.—J. W. T. Walsh: The Radiation from a Perfectly Diffusing Circular Disc.

## CONTENTS.

PAGE

Present State of the Dye Industry . . . . .	413
Poetry and Medicine. By Prof. D'Arcy W. Thompson, C.B., F.R.S. . . . .	414
Movements of Plants. By V. H. B. Applications of Electricity. By Dr. A. Russell . . . . .	416
British Iron Ores. By Prof. H. Louis . . . . .	418
Our Bookshelf . . . . .	420
Letters to the Editor:—	
The Flight of Flying-fish.—Dr. J. McNamara . . . . .	421
An Experiment on the Spectrum.—Dr. R. A. Houston . . . . .	422
Anti-Gas Fans.—Mrs. Hertha Ayrton . . . . .	421
A New Method for Approximate Evaluation of Definite Integrals between Finite Limits.—C. F. Merchant . . . . .	422
Applied Science and Industrial Research.—Prof. Frederick Soddy, F.R.S.; Major A. G. Church . . . . .	422
The Great Red Spot on Jupiter. ( <i>With Diagram</i> ).—W. F. Denning . . . . .	423
British and Foreign Scientific Apparatus.—J. W. Ogilvy; J. S. Dunkerly . . . . .	424
Cost of Scientific Publications.—Dr. C. G. Knott . . . . .	425
Natural History Studies in Canada. ( <i>Illustrated</i> ). . . . .	426
Tidal Power. ( <i>With Diagrams</i> ). . . . .	427
Obituary . . . . .	430
Prof. C. A. Timiriadze, For Mem.R.S. . . . .	431
Notes . . . . .	430
Our Astronomical Column:—	
Return of Tempel's Comet . . . . .	436
Double Stars . . . . .	436
Diffraction Image of a Disc . . . . .	436
Monument to Charles Gerhardt. By Sir T. E. Thorpe, C.B., F.R.S. . . . .	436
Biological Papers from Bengal . . . . .	436
Attainment of High Levels in the Atmosphere . . . . .	437
Physical Problems in Soil Cultivation. By B. A. Keen . . . . .	438
The Anomaly of the Nickel Iron Alloys: Its Causes and its Applications . . . . .	438
Technical Education and Mind Training . . . . .	439
University and Educational Intelligence . . . . .	439
Societies and Academies . . . . .	441
Books Received . . . . .	443
Diary of Societies . . . . .	444



THURSDAY, JUNE 10, 1920.

*Editorial and Publishing Offices:*MACMILLAN & CO., LTD.,  
ST. MARTIN'S STREET, LONDON, W.C.2.Advertisements and business letters should be  
addressed to the Publishers.

Editorial communications to the Editor.

Telegraphic Address: PHUSIS, LONDON.  
Telephone Number: GERRARD 8830.

### Naval Education.

THE discussion in the House of Commons on May 17 on the vote for educational services in the Navy Estimates raised several points of interest. We note a general wish to open more widely the door from the lower deck to the commissioned ranks. At present the most promising of the younger seamen can rise, through the intermediate rank of mate, to that of lieutenant at an age which does not shut them out from further promotion. Several members expressed a hope that it might be possible to promote ships' boys to the rank of midshipman. The First Lord is reported in the *Times* to have replied that the Admiralty "could do no more than place at the disposal of these lads the very excellent educational facilities now open to the lower deck, but would approach the question with a steadfast determination to remove every possible obstacle which appeared likely to prevent these lads attaining their object."

Lieutenants whose training at Dartmouth was curtailed during the war are now sent to Cambridge for a supplementary course. The special situation which led to this arrangement will pass away, but it is intended to make the Cambridge course a permanent feature of the education of 25 per cent. of the officers, if accommodation at the colleges permits. The young naval officer sees little outside his sea life—a life astonishingly wide in some ways, and equally narrow in others—and intercourse at Cambridge with other young men will broaden his ideas.

Osborne is to be closed in May, 1921. Cadets will go straight to Dartmouth at the age of thirteen and a half and stay there until the age of seventeen; then to sea. The First Lord spoke with regret of the necessity of closing Osborne, which has done good work in education; but the

total number of cadets under training on shore will be not more than 440, as against 1000 before the war, and it would be incompatible with economy to retain a special college for the younger cadets with these reduced numbers. If one of the colleges is to go, clearly it must be Osborne, where the buildings are for the most part temporary structures, whereas Dartmouth is a sumptuous edifice of brick and stone, which will house the whole number.

In an explanatory memorandum issued with the Estimates it was stated that changes were to be made in the curriculum. These are of some importance, and cannot be properly appreciated without some knowledge of the history of the matter. Lord Selborne's scheme of training (1903) provided for the common entry of executive and engineer officers; all were to enter Osborne together, and to receive an identical training between the ages of thirteen and twenty-two. Having reached the rank of lieutenant at twenty-two, they were to select the branch to which they would afterwards devote themselves—gunnery, torpedo, navigation, engineering, or non-specialist. The most difficult problem was the training of the engineer. Up to twenty-two he would not have a more intensive engineering training than all other officers; from twenty-two he would devote himself entirely to engineering. Many consequences followed this decision; in particular, it was necessary to assign one-third or one-fourth of the instructional time from thirteen to twenty-two to engineering. The engineer officers (Lieutenants E) trained under these conditions are understood to be doing well, but the time left for general education at the colleges was restricted rather severely, and in the case of the executive officers this restriction seemed to be a mistake. How could this defect be remedied without impairing the technical training of the engineers? It emerges from the Admiralty memorandum that the following solution is to be tried. The engineering time at the colleges (thirteen and a half to seventeen) is to be greatly reduced, and the time saved to be spent in enriching the cadets' literary education. At the same time, the age of specialisation for engineers is to be lowered from twenty-two to eighteen.

It may be surmised that this increased sense of the value of early general education is not unconnected with comparisons made during the war between the midshipmen from Dartmouth and the "direct entry" midshipmen who entered from the ordinary schools of the country at

eighteen. The latter are understood to have justified their selection, and in the opinion of some officers were superior to the Dartmouth entry in certain respects. One reason for such a superiority, if it really exists, is so dominant that it is unnecessary to look further. The "direct entry" midshipmen finished their education uninterruptedly at the schools, carrying it on to the age of seventeen and a half or eighteen. The Dartmouth boys were sent to sea prematurely, many of them at fifteen and a half instead of at the normal age of seventeen. They were an unfinished product, and from an educational point of view it is satisfactory that this curtailment of general education should have had such a marked effect on efficiency at sea that many officers were led to make the comparison referred to above. For the reason stated, the comparison could not be fair, but it was made, and it set naval officers thinking.

Not so many years ago it was axiomatic in the Navy that sailors "must be caught young," at a tender age, and not when they leave a public school. It is no longer axiomatic. There is acute division of opinion among naval officers on this subject. So long as it was considered necessary that cadets of thirteen and upwards should spend one-quarter of their time in engineering, it was impossible to look to the schools of the country for the secondary education of naval officers. But the amount of engineering to be learnt in future between thirteen and eighteen is not more than could be taught at any well-equipped school. The problem is therefore open whether the Navy is to continue to undertake the secondary education of its officers, or to leave the task to the schools. The First Lord stated that the Admiralty had no intention of abolishing Dartmouth as well as Osborne, and referred to advantages which could be conferred at a naval college on the sons of needy naval officers. But he believed the public-school system of entry—the "direct entry" system—to be thoroughly good, and fifteen midshipmen are to be entered annually from the schools, as against 120 through Dartmouth.

In favour of maintaining a naval college for cadets is urged the advantage of early acquaintance with Navy habits and discipline, the doubt whether the numbers required—very moderate numbers now—could be recruited at the age of eighteen, the present overcrowded state of the public schools, and the special consideration referred to by Mr. Long in his speech. In favour

of relying entirely on the schools of the country, many naval officers argue that a boy's outlook is narrowed by association from so early an age with none but those of his own profession; that there is nothing at a naval college which quite makes up for the influence exerted by a good public-school house master; that "direct entry" saves heavy expense to the Exchequer; and that it is more difficult to select at the age of thirteen than at eighteen.

The debate, therefore, has begun, and the outcome will probably be determined by the eventual balance of opinion within the Service.

### The Ultimate Data of Physics.

*An Enquiry concerning the Principles of Natural Knowledge.* By Prof. A. N. Whitehead. Pp. xii + 200. (Cambridge: At the University Press, 1919.) Price 12s. 6d. net.

**PHYSICISTS** and philosophers can unite unreservedly in an expression of gratitude to the author of this most acute and original work. At the present time, when it is generally recognised that the ultimate concepts of physics require reinterpretation, it is a piece of great good fortune that the task should be undertaken by a thinker who is not only one of the foremost of living mathematicians, but also a metaphysician who sees clearly the wider issues that are involved.

As Prof. Whitehead remarks, the incoherent character of the traditional concepts of speculative physics has long been a commonplace in philosophical treatments of the subject. Instantaneous moments, geometrical points, unextended particles, etc.—these may be convenient, and even essential, notions for the purposes of physical investigation, but, if taken to indicate existent entities, are quite unworkable notions. On such a basis the fact, for example, of change in all its forms would become not merely incomprehensible, but contradictory; to be intelligible, "change must," as Lotze put it, "find its way into the inside of being." In other words, change as mere sequence, as mere alternation, is an impossible thought. Change means, if it means anything, continuous modification in that which preserves a certain identity or unity, without, however, implying that the latter ingredient is something separate from the former. Nothing which is characteristic of force, velocity, energy, and life can exhibit itself at a durationless instant. The slightest functioning of a living organism obviously takes time, but so also does that of a molecule of iron. In Aristotelian language, it may be asserted that the true nature of any real existent

is never that which can be present all at once, but that which is being realised in the totality of phases through which the existent thing in question passes.

Since the appearance of his well-known paper in the *Phil. Trans.* of 1906, Prof. Whitehead has been wrestling with the problem which considerations such as these occasion, and he has now worked out a positive theory of the structure and diversification of Nature, upon the basis of which a rationale can be furnished of the concepts indispensable in mathematical physics. The aim, then, of the present volume may be said to be twofold: (1) To determine by analysis of what is offered in perceptual experience the ultimate data of science and their relations; and (2) to show how the concepts of mathematical physics and their relations can be exhibited as functions of the former.

Nature, so I understand Prof. Whitehead to mean, must be regarded as in its totality a continuous stream of process, of becoming, of creative advance. Within this whole there call to be distinguished two essentially different, yet intimately connected, types of entity—events and objects. Employing, again, Aristotelian phraseology (and in many ways Prof. Whitehead's scheme of Nature more nearly resembles the Aristotelian scheme than any other), events constitute the *ὄλη* and objects the *εἶδος* of things. Events are either durations or bits of a duration, and a "duration" is a "slab of Nature," limited temporally, but unlimited spatially, which is contemporaneous with the specious present of any percipient. The fundamental relation of events is that of extending over each other, and this relation of "extending over" is the common root from which both temporal extension and spatial extension take their origin. Strictly speaking, events themselves do not change; they pass into other events, and in passing become parts of larger events, the passage of events being extension in the making. Moreover, some of the events that are parts of durations (e.g. a specific state of perceiving) have a relation of cogredience to a certain duration—that is to say, they are temporally coextensive with it, and they occupy in it a fixed spatial position. Furthermore, events are the "situations" of objects—an object is located in an event as that event's characteristic or quality. Like Aristotle's *εἶδος*, an object is permanent. When we speak of its change we really mean its diverse relationships to diverse events. Precisely the same object can characterise two or more events. The continuity of Nature is to be found in events. The atomic properties of Nature reside in objects. There is, in short, a

structure of events (an "ether of events" rather than a material ether), and it provides the framework of the externality of Nature within which objects have their subsistence. This structure is capable of being analysed in a number of different ways, and by adopting different modes of analysis we human beings can get at the various kinds of events which are "situations" of different types of objects. The more important of these types are: (a) Sense-objects—e.g. definite sense-data; (b) perceptual objects—i.e. the so-called "things" of ordinary experience; and (c) scientific objects—i.e. the characteristics (electrons, etc.) of events as active conditions. With the exception of those perceptual objects that are delusive, all these types of objects are equally real. Their *esse* is neither *percipi* nor *intelligi*.

For the mathematician the detailed working out of the way in which the concepts of point, instant, particle, etc., may be brought into connection with the data just indicated will probably be the most valuable part of the treatise; but I must be content to record that it is accomplished through persistent applications of what is named the method of extensive abstraction. This method, it is explained, is that which in its own sphere (the sphere, namely, of geometry and mechanics) follows the procedure of the differential calculus in the region of numerical calculation. It converts a process of approximation into an instrument of exact thought. By its means, as Dr. Broad has neatly expressed it, the *convenience* in these concepts is retained, while the *fiction* in them is eliminated.

With the main principles of Prof. Whitehead's philosophy, yielding, as they do, a view of Nature strikingly antithetical to that of the logical atomism developed by Mr. Russell, the present reviewer is in close agreement. One would like to press, indeed, for a fuller elaboration of the notions of "duration," "event," and "passage of events" than is here attempted. For one has an uneasy feeling that a host of embarrassing problems lies concealed in those notions. And then, again, one is uncertain about the mode in which events are supposed to be apprehended. While objects are recognised, events, we are told, are "lived through," by which apparently we are to understand that not only the "percipient event" (i.e. the actual phase of experiencing), but also the whole duration with which it is cogredient is "lived through." Yet obviously it is not meant that the countless other events, some cogredient and others not with that duration, are in like manner "lived through," and one fails to see how there can be any unique process of appre-

hending *them*. Once more, one would be prepared to question whether "sense-objects" are primary as compared with "perceptual objects"—primary, that is, in the sense that the recognition of them is precedent to the recognition of the latter. But the last two of these criticisms turn upon matters of detail, and the first amounts to a large order. When all this is said, the fact remains that in the volume before us we have a really great effort of constructive thinking. Prof. Whitehead modestly observes that his book "raises more difficulties than it professes to settle." He adds, however, with true insight, that "to settle the right sort of difficulties and to raise the right sort of ulterior questions" is to accomplish one step further into Nature's background of mystery.

G. DAWES HICKS.

### Life and Letters of Silvanus P. Thompson.

*Silvanus Phillips Thompson, D.Sc., LL.D., F.R.S. His Life and Letters.* By J. S. and H. G. Thompson. Pp. ix+372. (London: T. Fisher Unwin, Ltd., 1920.) Price 1*l.* 1*s.* net.

**I**F this biography of the late Silvanus P. Thompson, written by his wife and daughter, is perhaps a little wanting in the detached criticism that could have come only from someone outside the family circle, it gives, from an inside and intimate point of view, a good idea of the extent to which its subject appreciated the gospel of work, and how he applied himself, with all his might, to the many varied and interesting things that he found for his hand to do.

The book commences with some account of Thompson's Quaker ancestry and his early training at Bootham School, York, and at the Quaker Training College at Pontefract. Later, Thompson returned to Bootham School as a junior master, and it was during this time that he made the first of many visits to the Continent, which he evidently greatly enjoyed, and which did so much both to widen his outlook and to increase the large number of his foreign scientific friends. His appointment as lecturer on physics at Bristol was the first step in his scientific career, and at Bristol he remained, lecturing to his students and also, farther afield, to various popular scientific societies, attending meetings of the British Association, and making many contributions to electrical science, until his appointment as principal of the Technical College at Finsbury, which was the chief scene of his labours for the remaining thirty-one years of his life.

Essentially fitted by Nature to be a teacher and an exponent, and endowed with habits of industry

to a rare degree, Thompson touched little that he did not to some extent adorn, and while in an age of specialism, by reason, no doubt, of a certain diffuseness of his interests, he never concentrated sufficiently upon any one branch of scientific research for his name to be associated with any first-class discovery, there can be no doubt as to the considerable extent that, by his books, his lectures, and his teaching, he forwarded the progress of science, and especially of its applications, during many years of activity. We learn that with remarkable industry he was the author of no fewer than seventeen published books, besides eleven others that were privately printed, while his addresses and communications to societies during the forty years from 1876 down to the date of his death number 177. Electricity, magnetism, optics, and acoustics were his principal subjects, but he also wrote on educational, religious, and other questions, while not least amongst his writings will be considered his biographies of Kelvin and of Faraday, and his notes on the lives of Peter Peregrinus, the soldier of fortune who penned his treatise on the magnet as early as the thirteenth century; Gilbert, the Elizabethan physician, who also wrote on the magnet; Sturgeon, the inventor of the electro-magnet; and Phillip Reis, whose apparatus, if it was not sufficiently developed to become of practical utility, was, at any rate, the forerunner of that wonderful instrument of sublime simplicity, the speaking telephone of Alexander Graham Bell.

Thompson, too, at an early stage in his career, tried his hand at practical telephonic invention, but his ingenious valve telephone was held by the courts to be an infringement of the Bell-Edison patents, and its sale was prohibited. Only on one other occasion do we find him coming out as an inventor, this time in connection with submarine cables for telephonic and high-speed telegraphic purposes. Here, though his particular arrangement of inductive leaks never came into practical use, it led the way to the Pupin loading coil, with which much has been accomplished.

It is recorded that, as a young man, Thompson cared little for games; but that this did not mean any lack of appreciation of the lighter aspects of life is evidenced by the vein of humour in many of his letters, and by the prominent part he took in connection with the "Red Lion" dinners of the British Association, and with such clubs as the Gilbert Club and the Sette of Odd Volumes, in which latter he bore the appellation of Brother Magnetizer. He also had many hobbies, some of which were not scientific, as, for instance, music, poetry, and painting, while as an artist himself he held no mean place, and occasionally exhibited

at the Royal Academy. An exhibition of his sketches held after his death comprised more than a hundred separate pictures.

Himself probably the most eloquent of scientific exponents since Tyndall, it is interesting to learn that Thompson fully realised, as has many another, the difficulties pertaining to the giving of a Royal Institution discourse, where it is not unusual for some few of the audience to know quite as much as, if not more than, the lecturer, while the majority can fully understand but little of what they hear. Of interest also is the account of the slender beginnings of his library, which his proclivities as a collector and as a learned bibliophile led him to accumulate, until, enriched as it was by many ancient works and a whole host of rare pamphlets, it developed into one of the most complete and valuable existing collections of electrical publications.

It is satisfactory to know that the skill and labour expended in making this collection will not be thrown away, as the whole library is to be preserved intact at the Institution of Electrical Engineers, where it will form a worthy monument to Thompson's industry and discernment.

A. A. CAMPBELL SWINTON.

### Academic Research and Industrial Application.

*The Chemistry and Technology of the Diazo-Compounds.* By Dr. J. C. Cain. Second edition. Pp. xii + 199. (London: E. Arnold, 1920.) Price 12s. 6d. net.

THE important chapter in organic chemistry which is summarised so admirably by the author of the treatise under review affords a striking illustration of the difficulty of explaining the details of a chemical synthesis to a non-chemical, although scientific, audience.

The element carbon furnishes the framework or skeleton of all organic compounds, but much of the chemical liveness appertaining to the more reactive of these substances is due to nitrogen, an element endowed with a dual personality. In the free state inert and loath to enter into chemical combination, when combined it becomes extremely active. Everything living that grows contains nitrogen, and this element is also present in all organic explosives and in the physiologically active alkaloids. It is, therefore, not surprising that the study of organic nitrogenous substances has always had a great fascination for chemists, who have never grown tired of speculating on the molecular structure of these compounds. It was from this academic point of view that about

sixty years ago Prof. Kolbe, of Marburg, set his pupils to work on the action of nitrous acid on various aromatic amines, nitrogenous compounds of the ammonia type derived from the aromatic hydrocarbon, benzene. One of these workers was Johann Peter Griess, who, on treating picramic acid with nitrous acid, discovered the first diazo-compound, so called because its molecule contained a very reactive group,  $N_2$ , consisting of two atoms of nitrogen or azote.

Purely as a matter of scientific curiosity and without any thought of possible applications, Griess proceeded to generalise this reaction and succeeded in showing that the common primary aromatic amines yielded diazo-compounds. These diazo-derivatives, he found, were very reactive compounds, and he tried their action on all possible substances. He was thus led to make a discovery of the utmost technical importance, namely, the synthesis of the azo-colouring matters. The diazo-reaction itself was discovered in 1858, and Griess obtained the first azo-colour in the years 1861-62. This dye was first manufactured in 1865 by Caro, a German chemist then employed by Messrs. Roberts, Dale, and Co., of Manchester. The greater part of Griess's work was carried out in England, first in London in Hofmann's laboratory, and afterwards while engaged with Messrs. Allsopp, of Burton-on-Trent.

From those early days to the present time the diazo-reaction has gone on becoming increasingly useful both in technical and in academic chemistry. The azo-colours produced a revolution in the art of dyeing because a large and important group was found to have the valuable property of dyeing cotton directly without the intervention of a mordant. Other azo-dyes have found useful application as extremely fast mordant dyes on wool. A third group, the azo-pigments or ingrain dyes, are formed within the textile fibre by impregnating this material successively with the components of the azo-coupling. All students of organic chemistry are familiar with the Sandmeyer and Gattermann reactions, by means of which diazo-compounds become synthetic agents useful in elucidating the constitution of aromatic or benzenoid derivatives. The diazo-reaction has been of service in the production of synthetic drugs, notably those of the salvarsan group. It was employed during the war in the manufacture of stannatory materials for chemical warfare. These synthetic developments are all duly noted in Dr. Cain's treatise, which includes many references to original literature. To the student of historical chemistry not the least interesting chapters will be those on the theories of the constitution of diazo-compounds. This discussion

deals fully with the celebrated Hantzsch-Bamberger controversy, which was maintained for several years. The author has himself formulated a theory of the constitution of diazonium salts which, with a modification suggested by the reviewer, is sufficiently elastic to account for the properties of aromatic diazo-compounds and also for the existence of a rapidly increasing group of heterocyclic and non-aromatic diazo-derivatives. A new chapter on the latter group has been added to this second edition of a unique monograph.

G. T. M.

### Ancestral Studies of Compositæ.

*The Origin and Development of the Compositæ: Thesis approved for the Degree of Doctor of Science in the University of London.* By Dr. James Small. (*New Phytologist* Reprint, No. 11.) Pp. xi + 334 + 6 plates. (London: William Wesley and Son, 1919.) Price 15s. net.

THERE is perhaps a tendency among systematic botanists to fight shy of the Compositæ, on account largely of the enormous size of the family and the difficulties of properly classifying its members. Those, however, who once succeed in passing these lions in the path soon become enthusiastic students of the group, and Dr. Small is no exception to this rule. His contribution to the investigation of the origin and development of the family is by far the most important that has appeared for many years.

After a general discussion of previous literature, in which the most important names are those of Cassini and Bentham, the author goes on to deal with the various morphological and ecological features of the family one by one, considering, for example, the pollen-presentation mechanism, the corolla, the pappus, the involucre, the receptacle, the phyllotaxis, and the fruit dispersal. From all of these, similar general conclusions are drawn, to the effect that the Senecioneæ are the most primitive type of the family, and that from them, directly or indirectly, and ultimately from Senecio itself, as the basal genus from which the Senecioneæ arose, there sprang all the other tribes and genera of the family. This is then very strikingly confirmed by a study of the geographical distribution, which shows what would be expected upon this theory of mutational origin, and upon the hypothesis of age and area, which is likewise adopted. It is shown that the distribution of Senecio (the oldest genus) is the widest of all, and that of other tribes and genera less and less in proportion to their lesser age.

NO. 2641, VOL. 105]

Senecio is supposed (and the evidence is fairly clear) to have arisen from the Siphocampylus group of Lobelioideæ, and probably in the Bolivian highlands after the upheaval in the Cretaceous period had provided available land above the limit of trees. Once formed, its pappus fruit and the great area of open land available in the mountain chains which with few breaks run all round the world enabled it to spread rapidly over America, Asia, Africa, and Europe.

In the final chapter an interesting sketch is given of an hypothetical evolution of the Compositæ from Senecio, based upon the various conclusions drawn in the course of the work, summed up largely in a diagram on p. 297, which illustrates this evolution in time and space. The latest great genus to evolve is supposed to have been Gnaphalium (from which the Inuleæ are descended), then Spilanthes (Heliantheæ), Solidago (Eupatorieæ and Astereæ), and so on. The whole is a striking and interesting illustration of the way in which our whole outlook upon phylogeny has been altered by the acceptance of the modern theories of evolution and geographical distribution.

In the course of the work many minor points are further elucidated, such as irritability in the pollen-presentation mechanism. Good reasons are brought forward for supposing the pappus to be of trichome nature, and by an ingenious mechanism the dispersal of the seed was studied, and it was shown that a very slight wind was sufficient to keep the seeds aloft in sufficiently dry air, so that there is no need for land bridges to explain the distribution. Many other points are also dealt with, for which reference must be made to the original.

### Our Bookshelf.

*Monarch: The Big Bear of Tallac.* By Ernest Thompson Seton. Pp. 215. (London: Constable and Co., Ltd., 1920.) Price 7s. 6d. net.

THIS is a composite picture of a grizzly bear, or, more exactly, the personality of one remarkable bear still living in prison has been credited with the adventures of several of his kind. Beginning with the growth and education of the cub, the book tells the story of many ups and downs, such as the first sheep-stealing, the escape from the forest fire, the circumvention of the hunters; the affair of the ten-gallon empty sugar-keg with the delicious smell, into which the bear thrust his head; and the final capture (by means of drugged honey) of an adventurer with many aliases. Mr. Thompson Seton is a fine raconteur, but we wish he had put a little more stuffing into the book; and his literary facility sometimes gets

the better of his judgment. "And still he lives, but pacing—pacing—pacing—you may see him, scanning not the crowds, but something beyond the crowds, breaking down at times into petulant rages, but recovering anon his ponderous dignity, looking—waiting—watching—held ever by that Hope, that unknown Hope, that came." Throughout the book we get glimpses of a river that does not reach the sea, and a poetic parallelism is sustained between river and bear—both ending in imprisonment. "The river, born in high Sierra's flank, that lived and rolled and grew, through mountain pines, o'erleaping man-made barriers, then to reach with growing power the plains and bring its mighty flood at last to the Bay of Golden, a prisoner there to lie, the prisoner of the Golden Gate, seeking forever Freedom's Blue, seeking and raging—raging and seeking—back and forth, forever—in vain." So with the bear. The book is delightfully printed and got up, and many of the thumb-nail drawings are very graphic. We are told on what pages they occur and on what pages the chapters begin and end, but there is no pagination!

*Religion and Culture: A Critical Survey of Methods of Approach to Religious Phenomena.*

By Dr. Frederick Schleiter. Pp. x+206. (New York: Columbia University Press; London: Humphrey Milford, 1919.) Price 8s. 6d. net.

It is well to be reminded by such an acute critic as Dr. Schleiter that anthropology, one of the youngest of the sciences, is still in search of the one scientific method of analysing and co-ordinating the enormous mass of material which has been, and is still being, collected. The object of this book is to review the methods in use at present and to point out certain difficulties which each involves. Though in his preface the author tells us that he has in some degree modified his iconoclastic attitude towards the comparative method, his criticism still remains sufficiently drastic. Thus he remarks that "in his immensely voluminous works" Sir James Frazer has embodied "several mutually irreconcilable types of research." Again, the method of intensive study of a limited group of cultural facts—the Australian culture, for instance—"bristles with fallacies and insupportable pre-suppositions." In dealing with Mana, Dr. Marett "appears to have expressed bewildering varieties of opinion on this subject." Sir E. Tylor postulates "a single coherent and systematic view of the world, or what he repeatedly refers to as a 'philosophy of nature.'" But "all ethnological evidence tends to show that no such universal systematisation of experiences has ever taken place." In short, "ethnographical literature, as a whole, presents to us little more than groups of classifications carried out from mutually irreconcilable points of view—the advocates of the separate principles being gathered into schools which profoundly distrust each other's results."

Dr. Schleiter, though an acute critic, is not a lucid writer, and his work is critical rather than

constructive. He supplies a bibliography, but, strange to say, no index. We can do no more at present than indicate the scope of this important review of methodology applied to ethnography.

*Manuel Pratique de Météorologie.* By J. Rouch. Pp. viii+145+xiv plates. (Paris: Masson et Cie, 1919.) Price 6.50 francs net.

THIS book, the outcome of war experience especially with aviators, is designed to give those who receive weather forecasts some knowledge of the principles on which they are based. The greatest measure of success is likely if the recipients have this knowledge, and are also in personal contact with the forecaster.

The construction of weather charts, the interpretation of their broader features, and the travel of large weather systems are dealt with in the first eight chapters. The greatest danger, however, often attends the passage of smaller travelling systems. Accordingly, chap. ix. discusses in great detail secondary phenomena, line squalls, thunderstorms, etc. Fog has a separate chapter, and an account is given of the main results of recent upper-air research. A useful feature is a list of the chief barometric situations of the year 1917 to serve as examples supplementary to those given in the book. The published daily charts of the Bureau Central Météorologique may be obtained for this purpose.

Detail is not lacking, and physical explanations are given of many phenomena. The book should appeal to meteorologists, as well as to "those who, without being meteorologists, wish to know what the weather will do." M. A. G.

*Wireless Transmission of Photographs.* By Marcus J. Martin. Second edition, revised and enlarged. Pp. xv+143. (London: The Wireless Press, Ltd., 1919.) Price 5s.

A CERTAIN amount of experimenting has been done from time to time on the transmission of sketches, photographs, etc., electrically along ordinary telegraph circuits, but in the case of long lines success has been limited by the difficulty of obtaining sufficiently sharp current impulses owing to the capacity effects in the line. This difficulty disappears with wireless transmission, and it is chiefly for this reason that the author anticipates greater success, as well as greater convenience, in the apparently more delicate methods which it is his purpose to describe. In his own system a bichromate print made on a metal film is rotated on a drum at the same time fed axially, and a stylus is caused by the presence of the picture to make intermittent contact and to send a series of impulses from an ordinary wireless transmitting set. A synchronised drum at the receiving end carries a photographic film, and a beam is directed on to it, which is made intermittent by the movement of a small shutter controlled by the receiving apparatus. Considerable ingenuity has been exerted to overcome the many practical difficulties encountered. The additions to this the second edition relate chiefly to optical and photographic matters.

### Letters to the Editor.

[The Editor does not hold himself responsible for opinions expressed by his correspondents. Neither can he undertake to return, or to correspond with the writers of, rejected manuscripts intended for this or any other part of NATURE. No notice is taken of anonymous communications.]

#### The Organisation of Scientific Work in India.

AS NATURE waited for more than a year to criticise the Indian Industrial Commission's Report which was published in October, 1918, it will probably tolerate this additional delay of a few weeks (due to my absence in India) in attempting, on behalf of my colleagues, to demonstrate that the impressions conveyed by the leading article in the issue of February 19, and by the letters which followed in three later issues, bear little resemblance to the Commission's proposals for "the organisation of scientific work in India."

We are well aware out here that the writer of the article borrowed many of his expressions, and that the correspondents who furnished the subsequent applause obtained their impressions of the Industrial Commission's scheme from a memorandum which was privately composed and circulated among a few scientific men in England after the departure of the only two members of the Commission who were at home last year on leave. If I had seen the private memorandum only, I, too, should have added my vote to the others in condemning a scheme apparently designed to tamper with the form of liberty that is essential to scientific research; and I doubt if I should have shown the canny wisdom of a distinguished chemist who, in reply to the author of the memorandum, cautiously commented on "proposals said to have been set forth in the report of the Indian Industrial Commission." That most of your distinguished correspondents had not read the Commission's report itself is obvious enough from their letters, though only one of them frankly says so. One writer, for example, states that "under the centralisation scheme the work of an investigator would depend on the previous sanction of the head of the Service, who would probably not be of any scientific eminence, or might even be without scientific qualification." The one obvious and plainly stated object of the Commission's scheme is to release isolated scientific research workers from control by non-scientific officials, and it is so designed that even the scientific officer suggested for the head of each Service cannot do more than criticise and advise without interfering.

According to the privately circulated memorandum, "two policies are at present in the field: (a) absolute centralisation with the formation of distinct, water-tight, graded departments of science (botany, zoology, chemistry, etc.) being controlled by a separate departmental head." This is intended to represent the policy of the Industrial Commission, and the literal agreement between the statement in the leading article of February 19 and three-quarters of this quotation is as important to notice as the additions made by the writer of the article. Both, like your correspondents, have confused the wholly distinct terms "services" and "departments," which are clearly distinguished in the Commission's report; but the writer of the article has also gratuitously added a statement which neither the Industrial Commission nor any other responsible body here has ever suggested, namely, the placing of "botanists, zoologists, and so on," under the proposed Imperial Department of Industries.

Your correspondents, out of the fullness of their  
NO. 2641, VOL. 105]

successful experience, reproduce many well-worn platitudes on the freedom necessary for research, but they overlook the fact that many young scientific officers are employed for such accessory routine duties as analyses and identifications, which may be dull, but are essential to the operations of agriculture, forestry, and mineral development. They forget, too, that most of the so-called research work of many others is purely descriptive, which is equally essential in a country stocked with raw materials of unknown nature. Unless their work comes to the notice of a senior authority of their own caste, young scientific officers so employed in departments or institutions controlled by non-scientific officials would rarely get a chance of showing their worth or of justifying their desire for research opportunities; unless they are members of some "service," and thus come automatically to the notice of their scientific chief, they must either remain low-paid "hewers of wood" or refuse to renew their agreements and quit.

Then among those who already enjoy opportunities for research there are some who need the support of an independent senior authority in their desire to obtain the necessary freedom and funds from the local authorities in control; and it matters little whether the "constituted authority" be a committee, a board, a hidebound official, or our most senior of scientific councils, which Prof. Soddy regards as the obsolete product of inbreeding, for all have learnt the danger of taking unchecked the average man's estimate of his own worth. There are some, too, among our isolated scientific workers who have not sufficient confidence in themselves to close their inquiries for publication; they need the crystallising influence of a senior worker who has the right to ask them how they are getting on with that piece of research which was in progress last year; there are others who, distracted by the abundance of their ideas and the wealth of available raw material, pass from one inquiry to another without finishing any; there are some who, in their isolation, unwittingly waste time in pursuing lines already more completely developed but not yet published elsewhere. Then there are isolated workers who, for want of a pace-maker, grow weary in well-doing; and, finally, there is the inevitable residue who, through uncontrolled freedom, become charlatans. But although all these well-known species of scientific men are represented in India, I doubt if we have any here who have yet attained such experience and dexterity in the use of "scientific method" as to justify their criticising a report that they have never seen.

Your leading article of February 19, after referring to the research work done in existing institutions of various sorts, asserts that "the present system has proved successful in practice." It would not be fair, nor would you find space, to describe the painfully numerous exceptions; but if the situation must be summed up in only a few words, the following two statements are sufficient: (1) During its tours the Industrial Commission received complaints nearly everywhere of the disabilities that handicap scientific workers under the present "system"; and (2) the most conspicuous success is also the most centralised institution of all, namely, the Geological Survey, which is a Department as well as a Service.

We cannot hope to provide for other scientific workers the amenities now secured by the geologist; he inherits the results of the forethought of a distinguished scientific worker who had also a genius for administration—Dr. Thomas Oldham. But it was the hope of the Industrial Commission to devise a scheme which (taking into account established vested interests, the tendency towards provincial autonomy,



and the transfer of some provincial scientific institutions to the control of popular representatives necessarily anxious for visible results) would retain for scientific workers the security of a central Service, and, so far as their research activities are concerned, the advantages of the support and criticism of a senior officer of their own caste. Our scheme is not an attempt to impose arbitrary control, but a simple response to a general petition from scientific workers for protection and support.

It cannot be applied, however, without suitable modification to fit established interests and institutions. There are, for example, forest botanists who are forest officers first and botanists after; their bond with the Forest Service is closer than with the Botanical Survey, and both should be developed as complementary, not competing, Services. There are agricultural chemists whose community of interests with the rest of the Agricultural Service forms a stronger service link than their affinities to other chemists; they might more appropriately be termed chemical agriculturists, and, having one of their own, they need not form part of the suggested Chemical Service.

To find out whether the general principles suggested by the Commission are applicable at all to each of the major sciences, and, if so, to adjust the scheme to established conditions, requires examination by special committees. One such committee for chemistry under Prof. J. F. Thorpe has just published its report, from which it will be seen that a committee composed of six chemists and one administrative officer, after examination of witnesses and institutions in various parts of India, accepts for chemists the scheme which your correspondents, rashly believing a privately concocted memorandum, label as "servitude undisguised," a "means of encouraging mediocrity," "bureaucratic centralisation," and other epithets.

To those of your readers who do not know the motive of the private memorandum referred to above, the special reasons for delaying the date for its distribution to every member of the Royal Society's Indian Advisory Committee—except myself, its chairman—and the selection of "the solid ground of NATURE" as the *point d'appui*, this "mass attack" on the Industrial Commission's scheme has doubtless all the appearance of spontaneity and honest conviction.

By an official accident, not foreseen by the author of the private memorandum, I have now before me (1) a proposal from a committee of botanists for the enlargement of the Botanical Survey, and (2) the unsought advice of a forest botanist who, through commendable but over-jealous regard for his own institution, submits opinions collected from ingenious scientific men and the correspondence in NATURE in support of his proposal, not for the expansion, but for the limitation of the Botanical Survey to one cryptogamic botanist and three specialists in medicinal plants. And this in a tropical and semi-tropical country covering 1,750,000 square miles! Fortunately, there is enough evidence available to justify further support for, and the independent maintenance of, both botanical institutions: but the petty jealousies of those who suffer from this form of mental astigmatism scarcely reinforce one's efforts to secure for isolated unorganised workers in other sciences the benefits now enjoyed by the geologist, or to secure for all scientific workers in India the privileges and recognition long ago accorded to engineers, doctors, and the members of the Indian Civil Service.

THOMAS H. HOLLAND,

President, Indian Industrial Commission.

Simla, May 5.

NO. 2641, VOL. 105]

[The leading article to which Sir Thomas Holland refers described the proposals of the Indian Industrial Commission and discussed the policy of centralisation and the creation of graded scientific Services in comparison with the present system under which research is carried on in India. In the correspondence which followed attention was given chiefly to the general principles of "Organisation of Scientific Work," and it was not necessary to be familiar with the Report of the Commission in order to express opinions upon these, or to urge that creative investigators produce their best results when they are given perfect freedom of action. The proposed scientific Services of India may, as regards their aims, be compared with the Industrial Research Associations at home, and are similarly capable of promoting progress in both pure and applied science. But the work carried on at universities and research institutes by men outside official Services has even greater need of financial support, because its value is not so readily understood. This is the aspect of productive research with which we are particularly concerned, and for which we ask full consideration.—ED. NATURE.]

#### Anti-Gas Fans.

I HAVE read Mrs. Ayrton's letter in NATURE of June 3, after, unfortunately, missing the note in the issue of May 13, as well as the *Times* correspondence referred to. I have no intention of entering into a controversy, polemical or otherwise, with Mrs. Ayrton, but should like to put my views before your readers, as I believe them to be shared generally not only by Headquarters Gas Service officers, but also by regimental soldiers of all ranks, including Gas *personnel*.

The crux of the matter is this: The problems involved in gas defence after July, 1917, when the enemy commenced using "mustard gas," were of a totally different nature from those which had to be faced before that date. Then, apart from small quantities of the annoying, but otherwise practically innocuous, "tear gas," we had to deal with moderate quantities of lethal gas shell, containing the *volatile* "diphosgene," and, very occasionally, with waves of cloud gas. Under those conditions the gas, except in very cold weather, disappeared quickly (a matter of minutes) from the open, or even from trenches of average depth, but was liable to collect and remain in shelters for hours, or even days. When such shelters had been once cleared they were habitable, as no "gas" remained outside in the neighbourhood to contaminate them further. For this purpose the Ayrton fan was found to be useful, and large numbers were issued as trench stores. Later the more simple, and quite as efficacious, method was introduced of merely lighting a small fire in the shelter, and thus causing a through draught. This was found to be distinctly superior for deep shelters, such as those in the chalk country of the Somme battlefield, and, moreover, was far less fatiguing to the men employed. Working an Ayrton fan, even in the most approved fashion, when wearing a gas-mask on a hot day, is a tiring task.

After the date mentioned we had essentially to deal with a relatively *non-volatile* shell-filling, which produced its well-known effects at concentrations far below those at which the volatile fillings became innocuous, and was used by the enemy in very large quantities. This gave little warning of its presence to the uninitiated, soaked much of the ground and pervaded the whole atmosphere in the shelled area for days afterwards, made great demands on the endurance and discipline of the soldier, and called for quite new measures. This is not the place to discuss these measures, but it is clear that the use of either fire or

fan to remove gas from shelters could really be effectual only after first dealing with the area round the shelter. That is one reason for the relative decline in the fortunes of the Ayrton fan. I say *relative*, as large numbers of such fans were issued even during the winter of 1917-18, and, for all I can remember, still later. Other reasons were the natural and rooted objections of the regimental officer and soldier respectively to be responsible for, or to load himself with, stores of (to him) problematical value, and the growing favour shown to the alternative fire method. (It was said, perhaps not without malice, that Ayrton fans were often used for clearing shelters from gas—by fire!)

However that may be, there was no demand by troops for the fans towards the end of the war; on the contrary, we were besought to withdraw them. I know this myself from many personal interviews with regimental officers and from reports furnished by Gas *personnel* of every type of unit and formation. There were, of course, up to the end of the war gas casualties caused by men sleeping in shelters which might have been successfully cleared of gas either by the fan or by fire. They were, however, owing to the particular properties of "mustard gas," a small proportion of the whole; and fatigue and ignorance and the exigencies of the battle were their causes.

I must, therefore, characterise as quite unfounded the view that much suffering and loss of life could have been avoided by increasing the provision of Mrs. Ayrton's fan. Regimental and Gas Services *personnel* were both far too anxious to reduce gas casualties in every way practicable. It was ultimately the fighting soldier who decided, after weighing all the facts of the situation, that the fan, useful in sound and well-established trenches, was scarcely "worth while" during the advances and retirements of 1917-18 or in the mud and pill-boxes of the Ypres salient—this apart from the question of "mustard gas." Mrs. Ayrton is very obviously sincere, but, like another distinguished civilian who has recently written on camouflage, is not quite *au fait* with the realities of the battlefield. Exaggerated attacks of this nature on the War Office are liable to defeat their own ends, and also to neutralise the efforts of others who are trying to ensure the application of scientific methods to military problems in a more systematic manner than has been the case in the past.

A. J. ALLMAND.

(Late Chemical Adviser to Fourth and to Second Army Headquarters.)

King's College, W.C.2, June 7.

#### Attainment of High Levels in the Atmosphere.

I MUST confess that I am very sceptical as to a sounding balloon having reached 37,000 metres or a pilot balloon 39,000 metres, as mentioned in NATURE for June 3, p. 437, although such heights would be possible if sufficiently large balloons were employed.

A sounding balloon as commonly used is a small india-rubber balloon expanded by hydrogen to about twice its natural diameter, and then securely tied up. The rubber stretches as the balloon ascends, until finally it can stretch no further and the balloon bursts. Under the supposition that the pressure and temperature of the gas inside are the same as those of the air outside, and under average conditions of temperature for Europe, the following rules hold: The starting diameter is doubled at a little more than 16 km., trebled at a little more than 24 km., and quadrupled at 30 km. Since the starting diameter is about double the natural diameter, this means that at 30 km. the rubber has

stretched eightfold linearly and its thickness been reduced sixty-fourfold. I do not think any rubber that will stand this treatment can be found.

On the other hand, a precise calculation of a great height is in practice impossible. We can only measure the pressure, and when the air pressure is greatly reduced a very small error in the pressure makes a large error in the height.

For a pilot balloon, if the balloon is near the zenith and the base line for the theodolites a long one, there is not so much risk of error; but if, as is usually the case, the balloon has drifted a long way, particularly if it has drifted in the direction towards which the base line points, then a small error in the setting of the theodolites or in reading the angles will make a great error in the height.

It is desirable that when the recorded height has reached an abnormal value the computer should give full details and state his reasons for believing it to be genuine, otherwise one is apt to think some mistake has crept in.

W. H. DINES.

Benson, Wallingford, Berks, June 4.

#### Central Wireless Station for Astronomy.

IN the "Astronomical Column" of NATURE of May 27 it is stated that "Prof. Kobold, editor of *Astr. Nachrichten*, and director of the Centralstelle, delegated the latter work to Prof. Strömgren, Copenhagen, during the war, but has now resumed it, and announces in *Astr. Nach.*, 5044, that arrangements have been made for the distribution of astronomical information by wireless telegraphy from the Nauen station."

It will be remembered that, in pursuance of resolutions adopted by the International Scientific Academies at London and Paris in 1918, there was established at an international conference held at Brussels in July, 1919, among other Commissions, a Commission of Astronomical Telegrams, with a central bureau at the Royal Observatory of Belgium (Uccle), to replace Kiel, for the purpose of receiving, centralising, and dispatching information concerning astronomical discoveries, observations, and calculations, either by telegram or post, to the various institutions or private persons subscribing to it.

Surely with such an organisation in full working order this Commission should undertake the dispatch by wireless of astronomical information of great urgency, such as the appearance of a new star, etc., if such information is going to be distributed by wireless at all!

Practically every observatory in Western Europe now takes in the time and weather signals from the Eiffel Tower, and any news of an astronomical nature could be easily transmitted to that station from the central bureau at Uccle (or Brussels) and re-transmitted from the Eiffel Tower at, say, 10.00h. and 16.00h., the standard times of transmission of the time and weather signals.

Before the war the Central Bureau of Astronomical Telegrams was located at Kiel, but this organisation has *ceased to exist* from an international point of view. There seems no object, therefore, in reviving it at Nauen (near Berlin) purely for the sake of this wireless astronomical information, when this mode of dispatch can be as easily adopted in Western Europe for this purpose.

Prof. Kobold seems not only to ignore the existence of the new International Central Bureau in Belgium, but also assumes that the war has made "no difference."

WILLIAM J. S. LOCKYER.

Hill Observatory, Sidmouth, S. Devon,  
May 28.

**The "Flight" of Flying-fish.**

I HAVE on frequent occasions (in the Mediterranean, the Red Sea, and the Indian Ocean) carefully observed with a field-glass ( $\times 8$ ) the supposed "flight" of flying-fish, and have always concluded that the "leap and glide" theory is the correct one, with one or two modifications. Dr. J. McNamara, in *NATURE* for June 3, p. 421, cites five facts in support of the theory of true flight, but I may point out that all these five facts can be otherwise interpreted. Flying-fish undoubtedly leap out of the water and gain their initial impetus by tail action, and when out of the water the pectoral fins serve as planes. While gliding the fish can not only renew its impetus to a limited extent by an occasional flick of its tail against the crest of a wave, but, as our correspondent says, can also change the direction of its glide. I have, however, never observed a fish "come back in a direction opposite to the direction in which it set out," and I am tolerably certain that it could not do this without re-immersion in the water, unless perhaps a strong wind were blowing in this opposite direction. Flying-fish can certainly rise and fall during the glide, but this, as well as change of direction, can be easily explained by assuming inclinations of the planes of the fins—a very different process from actual "wing-flapping sufficient to cause flight. The fins can, like those of most fishes, move on their bases, but I fail to understand how, in the absence of the required musculature, it can possibly be supposed that the fins show "rapid movement, as in the case of hovering flies and humming-birds." If seagulls can glide for hundreds of yards, rise and fall, and change direction without wing-flapping, why not flying-fish? In gliding the outlines of the pectoral fins naturally appear to be indistinct, because, compared with the rest of the body, the fins are thin and irregular in outline on their posterior edge.

Granting that the body can gain fresh impetus by an occasional flick of the tail against a wave-crest (and this can be easily seen to occur, and is certainly less difficult to understand than the initial tail action which enables the fish not only to emerge from the water, but also to acquire an impetus which carries it the greater part of its glide), and that the planes of the wings can be inclined, all the movements of flying-fish which I have observed are fully intelligible.

W. N. F. WOODLAND.

"Kismet," Lock Mead, Maidenhead, Wood 4.

As another observer of Nature at sea I must beg to differ entirely from Dr. McNamara's conclusions on the "flight" of the flying-fish.

- (1) Turning at an acute angle can be brought about by an extra puff of wind, and indicates no power on the part of the fish.
- (2) It is impossible for a flying-fish to flap its pectoral fins as a bird does its wings.
- (3) The rise and fall over waves are due to the forcing up or lowering of the air immediately over the surface of the water.
- (4) The impetus is quite sufficient to send flying-fish up to a height of 50 ft. or even more, and to extend the soar to 300 yards. They naturally flop about on deck until dead.
- (5) It is quite possible (though I have never seen it) for the tips of the fins to be vibrated by the wind during flight.

The matter has been dealt with more fully in "Nature Notes for Ocean Voyagers," by Capt. Alfred Carpenter and myself, and also in the *Nautical Magazine* for May, 1894, and in the *Shipping World* for April, 1901. The late Capt. Cromie, at my request,

made a series of very careful observations from torpedo-boat destroyers and submarines, and was most emphatic that they did not "fly."

As in many other interesting problems, the help of a super-kinema camera fitted with a telephoto lens would be of great service. DAVID WILSON-BARKER.

**Fellow-Workers.**

IN *NATURE* for June 3, p. 416, Prof. D'Arcy Thompson refers to me and to my "fellow-workers" who helped me to bring our "hopes to fruition" in connection with the old malaria-mosquito business. My own memories remind me of seven years' almost continuous solitary labour, during which time my numerous "fellow-workers" had many opportunities, as good as mine or better, for doing the same work, but, oddly enough, did not use them; and it was not until I had solved the problem that they arrived on the scene in a body, fully armed with paper, pens, and cameras, and resolved "to join the victory group" at any cost. Prof. Thompson puts one of these gentlemen in the place of honour next to Pasteur—who, by the way, had little to do with the development of animal parasitology. The true history of the subject is given in my "Prevention of Malaria" (Murray), and still more trenchantly in Robert Koch's letter to me, dated February 10, 1901, and published in *Science Progress* for April, 1917.

But this is a detail: and I should like to thank Prof. Thompson for his kindly references to my medical verses, and for his interesting conspectus of the medical poets. Oddly enough, the day after it appeared in *NATURE* I lectured at the Royal Institution on "Science and Poetry," and upheld the thesis that a higher view of both will show how frequently and how closely they are connected. But honesty compels me to add that my own interest in medical matters is quite secondary, and a matter of duty rather than of predilection. RONALD ROSS.

36 Harley House, London, N.W.1, June 4.

**The Approximate Evaluation of Definite Integrals between Finite Limits.**

(1) THE four-ordinate rule given in my letter published in *NATURE* of May 20, p. 354, viz.

$$\int_0^1 F(x)dx = \frac{1}{4}[F(\frac{1}{10}) + F(\frac{4}{10}) + F(\frac{6}{10}) + F(\frac{9}{10})],$$

is obtained by dividing the range into two and to each half applying the simple two-ordinate rule,

$$\int_0^1 F(x)dx = \frac{1}{2}[F(\frac{1}{2}) + F(\frac{3}{2})],$$

the parabolic or cubic approximation for two ordinates being

$$\begin{aligned} \int_0^1 F(x)dx &= \frac{1}{2} \left[ F\left(3 - \frac{\sqrt{3}}{6}\right) + F\left(3 + \frac{\sqrt{3}}{6}\right) \right] \\ &= \frac{1}{2} [F(0.2113) + F(0.7887)]. \dots (a) \end{aligned}$$

(2) Closer approximations may be obtained by dividing the range into a greater number of parts and applying this rule to each, thus:

$$\begin{aligned} \int_0^1 F(x)dx &= \int_0^{\frac{1}{3}} F(x)dx + \int_{\frac{1}{3}}^{\frac{2}{3}} F(x)dx + \int_{\frac{2}{3}}^1 F(x)dx \\ &= \frac{1}{3} \left\{ \int_0^{\frac{1}{3}} F\left(\frac{x}{3}\right)dx + \int_0^{\frac{1}{3}} F\left(\frac{1+x}{3}\right)dx + \int_0^{\frac{1}{3}} F\left(\frac{2+x}{3}\right)dx \right\} \\ &= \frac{1}{3} [F(\frac{1}{9}) + F(\frac{4}{9}) + F(\frac{7}{9}) + F(\frac{10}{9}) + F(\frac{13}{9}) + F(\frac{16}{9})] \end{aligned}$$

The following table shows for several functions the value of the integral and the approximate evaluations from two, four, six, and eight ordinates:

F(x)	$\int_0^1 F(x) dx$	Number of ordinates used.				
		2	4	6	8	
Semicircle $(x-x^2)^{1/2}$	0.3927	0.4000	0.3949	0.3939	0.3934	0.3934
Quadrant $(1-x^2)^{1/2}$	0.7854	0.7898	0.7868	0.7862	0.7859	0.7859
Parabola $x^2$	0.3333	0.3400	0.3350	0.3341	0.3337	0.3337
$\sin x$	0.4597	0.4580	0.4593	0.4596	0.4595	0.4595
$\log(1+x)$	0.3863	0.3850	0.3859	0.3861	0.3862	0.3862
$e^x$	1.7183	1.7234	1.7197	1.7187	1.7186	1.7186
$\frac{1}{1+x}$	0.6931	0.6945	0.6937	0.6934	0.6933	0.6933

(3) If  $F(x) = a + bx + cx^2 + dx^3$ ,

$$\int_0^1 F(x) dx = \frac{1}{3} \left[ F\left(\frac{2-\sqrt{2}}{4}\right) + F\left(\frac{1}{2}\right) + F\left(\frac{2+\sqrt{2}}{4}\right) \right]$$

$$= \frac{1}{3} [F(0.1464) + F\left(\frac{1}{2}\right) + F(0.8536)]. \quad (b)$$

A simple three-ordinate rule is therefore

$$\int_0^1 F(x) dx = \frac{1}{3} \left[ F\left(\frac{1}{4}\right) + F\left(\frac{1}{2}\right) + F\left(\frac{3}{4}\right) \right].$$

In practice this is not quite so convenient as the application of the two-ordinate rule.

A. F. DUFTON.

Trinity College, Cambridge, May 20.

P.S.—I thank Mr. C. F. Merchant for pointing out in NATURE of June 3 that the four-ordinate rule is already in use, and for giving a reference to Tchebycheff's rules, with which I was unacquainted. The positions of Tchebycheff's ordinates, as in (a) and (b) above, are inconvenient, and the rules obtained by taking neighbouring ordinates attain simplicity without great loss of accuracy.

A. F. D.

June 5.

**The Cost of Laboratory Fittings.**

It is evident from the correspondence which has followed the publication of the letter from me on the subject of laboratory fittings that I must again ask leave to trespass on your space in order to explain that my remarks referred solely to fixed fittings, as stated, embracing working benches, lecture tables, and the like. I have no doubt that questions of actual instruments and apparatus are of much greater importance, but of these I have no right to speak.

Perhaps I may be allowed to make myself clear by reference to one or two specific directions in which research on fixed fittings might possibly prove useful. The present price of teak as bought in bulk from a merchant is 30s. per cubic foot, and if impregnated soft wood could be substituted for bench and table tops much saving would result. This impregnation might be effected by precipitation, electrolysis, oxidation (oils), or evaporation (e.g. silica solutions). Again, bituminous materials with perhaps barytes rolled into them might be investigated for use as a thin layer on wood or concrete. Soapstone is much used in America and *lave émaillee* in France, but not as yet in this country. There are, further, certain hard flooring plasters which should be very inert chemically. An investigation is much needed into the proper composition of bituminous materials for coating laboratory drains. Drains executed in wood thus coated are in many cases much cheaper than glazed ware drains.

For repetition work such as locker doors and even drawers pulped and stamped material might prove economical if some standard could be agreed upon. It should not be a very expensive matter to set on foot some researches of this nature, and any effective results would, I imagine, be very welcome to institutions at present faced with additions to their material equipment.

ALAN E. MUNBY.

9 Old Square, Lincoln's Inn, W.C.2.

**The First Act of a Young Thrush.**

SINCE observations of the first acts of wild birds immediately after hatching are very difficult, the following may be worth recording. Last week I went to look at a thrush's nest which I had found a fortnight before, with four eggs in it. Two eggs were hatched and two were not. As I was watching the young birds, one of the two remaining eggs cracked right across, and I saw the bird wriggle out and toss the two halves of the shell out of the nest by a convulsive movement of its back; but the curious thing was that, before the bird was properly free from the shell, it opened its beak—as if for food. I dug up a worm near by and offered it to the bird, which swallowed it eagerly. I purposely dug for the worm in a place from which I could see the nest, and I feel sure that the parent bird did not come and feed the nestling meanwhile. A few minutes later the other egg hatched, and the bird behaved just as in the former case, opening its beak before it was out of the shell.

Now the question is: Was the opening of the bird's beak a reflex or an "instinctive" act? If it were reflex, it would presumably have been induced by sudden exposure to the new environment of open air; and, obviously, such a reflex act would serve the purpose of an "instinctive" one in this case. Moreover, is it not a question whether any "instinctive" act at so early a stage can be anything more than a reflex act thus adaptable to survival purposes—by natural selection if need be?

HONOR. M. M. PERRYCOSTE.

Polperro, Cornwall, May 30.

**Marat and the Deflection of Light.**

CARLYLE'S vivid portraiture of Marat as "horse-leech" and savage revolutionist has rather obscured the fact that this "friend of the people" was a learned doctor of medicine, a physicist, and a physiologist. It is true that Carlyle refers to him as "Renovator of Human Science, Lecturer on Optics," but the mistake about the "horse-leech" is repeated in the same passage.

In Marat's "Notions élémentaires d'optique" (1784), p. 16, the following statement is made:

"Il est hors de doute, que les rayons de lumière changent toujours de direction dans le même milieu, lorsqu'ils passent à certaine distance d'un corps. Se trouvent-ils dans la sphère d'attraction? ils se replient jusqu'à certain point à sa circonférence, et se prolongent ensuite en droite ligne."

This at first glance may appear a remarkable anticipation of recent discoveries in physics, but in reality the conclusion is based on wholly false premises, as further reading of the pamphlet will disclose.

W. A. OSBORNE.

University of Melbourne, April 22.

**British and Metric Systems of Weights and Measures.**

ON p. 355 of NATURE of May 20 Mr. M. E. Yeatman in a letter on the above subject says: "It seems that the advantage of any given system of weights or measures lies largely in the facilities that it offers for the division of a sum or quantity into equal parts"; and I have seen "facility of factorisation" claimed before as one of the merits of the British system. As an engineer who "figures frequently," I fail to appreciate this fetish of factorisation. One uses a slide-rule and logs, and never worries about factors. Will Mr. Yeatman, or someone else, demonstrate the use of factors in practical calculations, bearing in mind the use of slide-rules, calculating machines, and logs?

The metric system seems to be gaining ground in spite of the lack of factors disclaimed for it.

ALFRED S. E. ACKERMANN.

## Aircraft Photography in the Service of Science.

By H. HAMSHAW THOMAS.

AIRCRAFT photography as developed during the war possesses great potentialities as an instrument of scientific research. The value of the aeroplane in geographical and geological exploration has already been emphasised in these pages, and its employment in the reconnaissance of little-known countries need not be further mentioned; but if aeroplane exploration is valuable, its worth is greatly enhanced by systematic photographic work. For, while a trained observer notices many features, it is quite impossible for him to observe and note more than the salient points seen from a swiftly flying machine, while the camera instantly records every feature in the field of view. Again, from a safe height of, say, 10,000 ft. only the larger elevations or depressions are visible to the human eye, but if paired photographs are taken for the purpose of stereoscopic examination with a wide base of, perhaps, 500 yards, then the whole of the ground relief becomes visible in a most striking manner. But not only do photographs provide a means of obtaining and recording information; they also show the relative positions of objects, and, if taken on an organised system, provide a topographical survey for use in map construction.<sup>1</sup> In addition, I was frequently struck with the value for scientific purposes of material obtained in the course of the R.A.F. work in Egypt and Palestine, and the purpose of this article is to indicate some types of information which may be furnished.

Air photographs may serve either as useful illustrations of known scientific facts, or as a means of discovering new facts, and while they are mainly of geographical or geological interest, they may also assist the botanist, archæologist, and meteorologist.

*Geography and Geology.*—As examples of the illustration of known facts, we may mention the remarkable photographs of Vesuvius taken by Group Capt. A. E. Borton, C.M.G. One of these has already been published in the Press, and it would not be easy to find a more striking demonstration of the structure of a volcanic cone. Among the photographs taken in Palestine we had many good illustrations of erosion and river development. The soft lake-beds of the Jordan valley were shown in the process of weathering out to form what the Americans term "bad-land topography." In this region marls and clays which have been baked by the hot, rainless summer are denuded at a great rate by the heavy winter rains, and give rise to a complex system of steep-sided wadis spreading back from the main drainage channels. The sides of these wadis are bare of vegetation, but their bottoms become filled with scrub when reduced to the base level of erosion.

The contrast between the wadi forms produced in these lacustrine or alluvial deposits and those carved out of the adjacent Cretaceous rocks is very noticeable, and we have also illustrations of the different erosion forms produced on steep or gentle slopes.

The River Jordan, which had never been very accurately surveyed before the war, has now been photographed over a considerable distance, and furnishes striking examples of some of the phenomena of river development. In its lower part it has cut down a distinct and well-marked meander-belt below the level of the surface of the lake-beds of the old valley. The river is constantly changing its course in this belt (see Fig. 1), which in most places is well covered with vegeta-

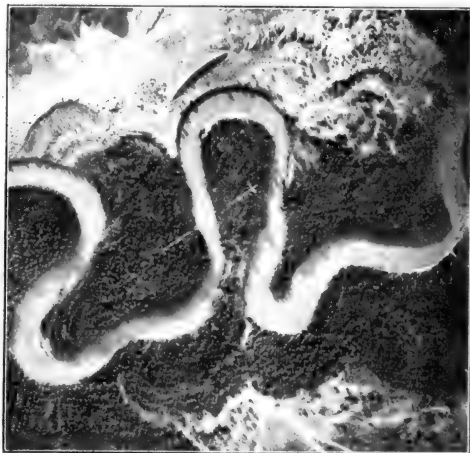

FIG. 1.—Meander belt of the River Jordan north of Jericho, showing the formation of an "ox-bow" and the cusp-shaped terraces. The dark area near the stream is the belt of willow scrub.

tion, and the old courses of the stream are often plainly visible where the vegetation has not yet had time to colonise the former river-bed. We see "ox-bows" and loops of the river in all stages of development, while sometimes a heavy spring flood appears to have resulted in the stream taking an entirely new course. At the sides of the flood-plain cusp-like terraces often show the stages in the cutting down of the gorge, while the presence of hard beds may produce nodes in the series of meanders.

The illustrations of such features as have been mentioned are often so striking and convincing that they would be valuable to teachers and students if they could be made available.

But by the study of photographs and the maps

<sup>1</sup> See *Geographical Journal*, May, 1920.

made from them we may observe other features of research interest. The story of the earth movements in the Jordan rift is not yet clear, while there has been much discussion about the climate of the region during recent and prehistoric times. In some of the photographs taken, we have good evidence of very recent faulting, and we may distinguish a fault scarp in the lake-beds (Late Tertiary). We find that the trough faulting has resulted in the incision of many of the tributary streams, and in several places in cañon formation. When we look at the drainage system from the point of view of climatic change we find evidence of a former period of abundant precipitation, during which much of the present surface sculpture of the Judæan hills was effected; but this period was a remote one, and preceded the drying up of the Jordan lake to give the present valley. Passing up to the north of Palestine, we have good evidence from a dry gorge, terraced valleys and drainage forms, that at a former period the River Jordan originated in Central Syria; but afterwards the Syrian portion of the river was captured by the Litani. This capture was largely the result of a general uplift of the country, and several of the oblique air views of the coastal plain of Palestine, especially near Mount Carmel, show very well the plain of marine denudation stretching from the present shore to the foot of the hills.

It is in the portrayal of the geographical features in the most complete and detailed fashion, so that their developmental story can be studied and deciphered, that aeroplane photography excels. If the whole of the Palestine material could be carefully studied by the physical geologist, a great deal of information would result, for the above-mentioned deductions have been made from the study of a few small sets of photographs which had been chosen at random for other purposes.

The investigator of solid geology has naturally little to learn from photographs, but in some places, where the climate is arid and the ground almost devoid of soil, the boundaries of some of the harder beds may become visible, while in other cases the bedding is clearly seen, and the underlying structure may be brought out by surface weathering. A photograph taken during the first flight ever made from Egypt to India showed an interesting locality in western Persia, where a well-marked anticline had been laid bare by surface erosion.

*Botany.*—The student of vegetation who may be sufficiently fortunate to obtain aerial photographs of the ground is at once in possession of the basis of an ideal vegetation map. Different types of vegetation show up very clearly, and also, of course, the transition from desert to open and closed plant associations (see Fig. 2). It is naturally necessary to go over the ground with the photographs, but after a short time the characteristic tones and appearance of different vegetation types can be readily picked out. Even among crops it is possible to distinguish barley, wheat, and

maize, besides other plants, like cotton, which have a distinct habit and growth period. Practical use of these facts was made in Mesopotamia for ascertaining the acreage under wheat cultivation, and trials have been made in India with the view of carrying out crop-surveys by aeroplane photography.

I have not had the opportunity of making many observations on this subject, but it may be of interest to mention a small point observed in connection with the distribution of the willow and tamarisk scrub of the Jordan valley. This vegetation is limited by the water supply from the river, and succeeds in following the stream right down to the Dead Sea. Here, at the mouth of the Jordan, although surrounded by salt lagoons, a narrow belt of vegetation manages to survive as a fringe to the river with its rapidly flowing stream of fresh water.

*Archæology.*—The utility of aerial photography to the archæologist was strikingly illustrated in



FIG. 2.—Photograph showing the distribution of vegetation in the Sinai desert. The partial colonisation of sand-hills by dwarf scrub vegetation—the black spots—is well shown, also some small groups of date palms:

the case of the ninth-century city of Samarra,<sup>2</sup> in Mesopotamia, where views taken from above the apparently formless heaps of earth and rubble give the outlines and plan of streets and buildings. It may be only rarely that similar cases may arise, but experience shows that if ruins or remains exist in any regular form, their arrangement will be well depicted by the aeroplane camera. We may by this means be able to locate interesting sites which have been more or less obscured by superimposed material. A feature which was brought to light in Palestine as the result of air survey was the ancient irrigation system in the south-eastern part of the Jordan valley. An extensive series of old connected channels, now filled with scrub vegetation, was seen; this must be a relic of the days when the Jordan valley was under general cultivation,

<sup>2</sup> See Lt.-Col. G. A. Beazley, *Geographical Journal*, vol. liii., p. 330, 1919.

and very different from the desert condition which it possesses to-day. While nothing was found in Palestine of the same type as the Samarra ruins, the ancient Græco-Roman temples of Jupiter and Bacchus at Baalbek, in Central Syria,

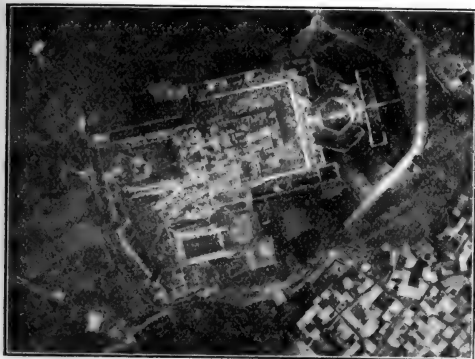

FIG. 3.—Temples of Jupiter and Bacchus at Baalbek in Central Syria, showing the ground plan and some remains of later Saracenic building.

furnished some interesting photographs. A vertical view from about 3000 ft. gives a remarkably good ground plan of the present state of these beautiful remains (see Fig. 3).

*Meteorology.*—The study of clouds by the

photography from aeroplanes of their forms and features has been recently discussed by meteorologists, and need not be further mentioned.

It would be outside the scope of the present article to deal with the methods of obtaining, using, and interpreting the aerial pictures which have been referred to. It may be seldom possible for a scientific expedition to employ aeroplanes, owing to their expense; but, when it can be done, useful knowledge is bound to accrue. In other cases, however, as in Palestine, photographs may be taken for mapping or other purposes, which will also yield important scientific material to those who can make use of it; and possibly photographs taken for the purpose of training airmen may become of great value, even in this country, if certain areas are included. Sometimes the evidence furnished is clear and unmistakable, but in other cases the photographs have to be examined by a trained and experienced worker. The general public has not been very fully informed of the work of the R.A.F. photographers during the war, and to most people the air photograph is a curiosity which seems to have little value in times of peace. Though in some countries the civil importance of aerial photographic survey is realised, in England air photography is in a somewhat languishing condition. In these circumstances it is well to remember that, though the aerial camera has not been extensively employed apart from military work, it nevertheless appears to have no inconsiderable value in the domain of pure science.

## The Dynamics of Shell Flight.

By R. H. FOWLER.

THE object of this article is to give a short account of some features of the motion of a spinning shell through air. Our knowledge of this phenomenon has been somewhat increased by war-time researches. To determine the motion of a shell from the equations of rigid dynamics, we require to know the complete force system which represents the reaction of the air on the moving shell; but, just as in the case of an aeroplane, the components of this reaction are utterly unknown *a priori*. The problem that arises, therefore, is that of determining these components by observation and analysis of the actual initial motion of shells. Once they have thus been determined, they can be applied, provided the essential conditions remain similar, to the calculation of the complete motion of a shell along its trajectory.

In the simplest case of all this procedure is classical. The air resistance to a shell, moving so that the directions of its axis and the velocity of its centre of gravity coincide, has long been determined thus as a function of the velocity, and trajectories have been computed assuming that this coincidence subsists throughout the motion. Under this assumption the problem is merely one

of particle dynamics, of which the solution may be regarded as completely known. The comparison of calculations and observations shows good agreement in range and height when the shells are suitable and the total angle turned through by the tangent to the trajectory is less than, say,  $50^\circ$ . The calculated trajectory, however, is a curve lying in the vertical plane containing the original direction of projection, while the observed positions of the shells do not lie in this plane, but appreciably to the right of it when their axial spin is right-handed. This well-known departure from the original vertical plane is called *drift*, and converts the trajectory into a twisted curve. It cannot be accounted for on the original assumption.

It is with these cases, in which particle dynamics fails to explain the observations—such as the drift, trajectories of large total curvature, and (as we shall see) initial motions—that we are mainly concerned here. For their study we must abandon the assumption that the direction of motion of the centre of gravity and the direction of the axis of symmetry coincide, and study the whole motion as a problem in rigid dynamics.

In order to do this we must, first of all, deter-

mine experimentally the complete reaction of the air on the moving shell when the directions of its axis and the motion of its centre of gravity no longer coincide. In such a case the angle between these two directions is called the *yaw*. Until recently the reaction on a yawed shell had never been studied experimentally. The necessary data, however, can be obtained by observation and analysis of the initial motion of the shell in the first few hundred feet after leaving the muzzle of the gun, for in this interval the axis of a shell oscillates periodically over an appreciable range of yaw.<sup>1</sup> The motion is a little complicated, and its interpretation is not yet completely worked out in terms of the reaction of the air. Moreover, a really satisfactory experimental method has not yet been devised. But a start has been made on the problem, and approximate values of the more important components have been determined.<sup>2</sup>

The somewhat crude experimental method so far used consists in firing a shell through a series of cardboard screens. The shape of the hole in the card determines the size and direction of the yaw at the instant of passing through the card. From such observations the motion of the axis can be plotted out against the time (if the velocity of the shell is known), and the period of its oscillations determined. The disturbing effect of the cards themselves can be determined by suitable control experiments and roughly estimated. Two specimen observed curves<sup>3</sup> traced out by a point on the axis of the shell relative to the centre of gravity are shown in Figs. 1 and 2. These two paths are strictly comparative, as the only difference between their circumstances is an alteration of the axial spin. The slowly spinning shell (Fig. 1) has oscillations of comparatively long period and large amplitude. These curves are closely analogous to the curves which represent the oscillations of a spinning top near its vertical position. They differ only in showing slight damping and variation of period.

Let us consider further this analogy between a shell and an ideal spinning top. The centre of gravity of the shell and the point of support of the top are analogous; so are the moments of inertia about these points and the axial spins. To the direction of motion in the case of the shell corresponds the vertical in the case of the top; to the disturbing couple due to the reaction of the air on a yawed shell corresponds the gravity couple on a displaced top. The analogy so far is practically exact; it is modified by the following facts:—

(1) That the centre of gravity is not a fixed point like the point of a top, for its velocity varies both in magnitude and in direction under the reaction of the air; it describes a helical curve, thus modifying the couple.

(2) That an appreciable frictional couple exists which, in conjunction with the helical motion of the centre of gravity, serves to damp out the axial oscillations completely.

(3) That, in addition to (1) above, the magni-

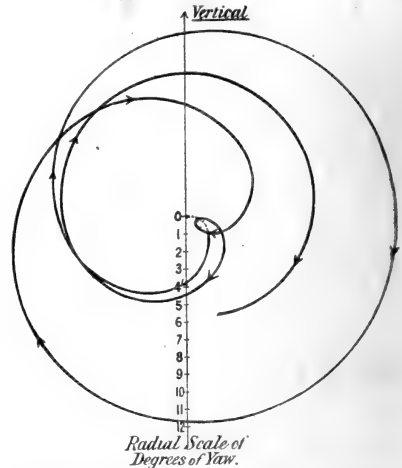

FIG. 1.—Observed path of the nose of a shell, muzzle velocity 1565 f.s. Rifling 1 turn in 40 diameters of the bore. Total time taken to describe curve shown 0.38 sec.

tude and direction of the velocity of the shell are steadily altered by gravity.

Experiments so far carried out have determined approximately the values of the couple analogous to the gravity couple for velocities from 900 f.s.

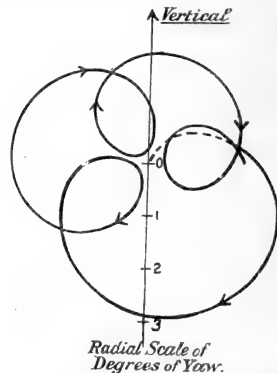

FIG. 2.—Observed path of the nose of a shell, muzzle velocity 1563 f.s. Rifling 1 turn in 30 diameters of the bore. Total time taken to describe curve shown 0.20 sec. [The scale of Fig. 2 is three times that of Fig. 1.]

to 2200 f.s. for two different shapes of shell, when the yaw is not too large. By determining these couples for various different positions of the centre of gravity, rough values of the resulting sideways thrust on a yawed shell were deduced.

<sup>1</sup> Such experiments are described in a forthcoming paper in the Royal Society Transactions by R. H. Fowler, E. G. Gallop, C. N. H. Lock, and H. W. Richmond.

<sup>2</sup> The forces on a model shell at rest in a steady current of air of low velocity can also be measured directly in a wind channel; the results are probably applicable to a shell moving at velocities up to 700 f.s.

<sup>3</sup> The observations were made for the Ordnance Committee at H.M.S. Excellent, Portsmouth.



The study of initial motions is intimately connected with the question of the *stability* of a spinning shell at zero yaw. The motion of a shell (or a top) is said to be stable if a small disturbance only produces a small maximum displacement from the position of symmetry, proportional to the disturbance. The condition of stability for small disturbances is the same in the two cases; it must be fulfilled in order that the shell may travel along its trajectory approximately at zero yaw as desired. A knowledge of the disturbing couple enables us to lay down how much spin is required to allow a reasonable margin of stability.

We have said that the usual approximation of motion at zero yaw is inadequate in the case of trajectories of large total curvature. The complete theory indicates that, under the effect of gravity (see (3) above), the yaw tends to attain a sort of equilibrium value which increases along the trajectory, and may reach  $20^\circ$  or more at the end of a sufficiently long arc. A study of initial motions with slightly unstable shells in which such values of the yaw can be realised experimentally will provide the material required for the proper discussion of such trajectories.

The following approximate theory accounting for the drift of a shell has long been known. Owing to the change of direction of motion due to gravity (see (3) above), a shell cannot continue to move steadily at zero yaw. The proper equilibrium state of affairs is attained when the yaw is just such as will enable the axis to keep pace

with the changing direction of motion by precession about it. This equilibrium value of the yaw depends on the above-mentioned disturbing couple due to the reaction of the air, which may be determined by a study of the initial oscillations. The resulting yaw in ordinary cases is too small to alter seriously the range at any given time, and does not affect the height because the equilibrium position of the yawed axis lies in a plane which is always very nearly at right angles to the vertical plane containing the original direction of projection. It produces, however, the lateral deviation known as drift. This approximate theory leads to a formula for the drift depending on the ratio of the sideways thrust to the disturbing couple. With the values of this ratio recently roughly determined, the drift has been calculated by this classical theory, and compared with direct observations of the drift of similar shells. The observed and calculated values are in fair agreement, and there is no doubt that the classical theory is substantially correct.

In conclusion, it is perhaps worth mentioning that the interest in such investigations mainly arises from the fact that we can thus study the phenomena of motion through a compressible fluid at velocities both greater and less than the velocity of sound in the fluid. The investigation, however, has scarcely begun, and much work will be required before it is possible to describe adequately the complete reaction on a shell of given shape moving through air. •

### Obituary.

PROF. L. DONCASTER, F.R.S.

LEONARD DONCASTER'S death from sarcoma at the age of forty-two has stopped a career of exceptional distinction. When I lately saw him, apparently in his usual health, presiding over his laboratory as the newly elected Derby professor of zoology at Liverpool, I had comfort in the thought that by his appointment a fresh centre of genetics was safely begun. Doncaster was a natural investigator. From his student days there was never a doubt as to the purpose of his life. The problems of biology were always in his mind. For him the materials were everywhere. Though circumstances led him into academic zoology, he was an excellent field entomologist and botanist, with a fair knowledge also of the domesticated forms. Latterly he became more and more drawn towards cytological methods, but he always kept in touch with the other lines, knowing that the next advance may begin anywhere.

Doncaster started at Naples with experiments on hybridisation of Echinoderm larvæ, which produced evidence of value as to the effects of temperature in modifying dominance; but many aspects of that vexed question remained, and still remain, obscure. He returned to England at the moment when the early struggles of Mendelism were acute. Though constitutionally predisposed to caution, he

new enough of the general course of variation and heredity to be in no doubt of the essential truth of the new doctrines, and undoubtedly his adhesion did much to spread confidence among his contemporaries. He at once joined in breeding work, and at various times experimented with many forms, particularly rats, cats, and pigeons. With insects of several orders he was especially successful. The seemingly more fundamental nature of microscopical work made it very congenial to him, and he always had a mass of cytological material on hand. These studies enabled him to take a prominent part in that comprehensive codification by which the confused and contradictory observations as to the sexes of parthenogenetic and other forms in the Hymenoptera and Hemiptera were ultimately reduced to order.

In the history of biology Doncaster's discovery as to the determination of sex in the currant moth (*Abraxas grossulariata*) will have a permanent place. From the Rev. G. H. Raynor, a fancier of the species, he learnt facts which suggested that the variety *lacticolor* was what we now call "sex-linked," being predominantly associated with females, as colour-blindness in man is with males. After verification and extension this mass of facts provided (1906) the first clear genetic proof of

sex-determination in the gamete, a discovery of astonishing novelty at that time, though now so familiar to us all that we have forgotten how hard it was to achieve. Being greatly struck with Wilson's cytological proof that many *male* insects are heterozygous for sex, and having himself proved that in *Abraxas* the female is in this condition, Doncaster devised a scheme in which both sexes are thus represented, dominance being attributed to the female gamete; but he afterwards accepted a simplifying emendation in which the male is taken to be homozygous. After this, finding a curious strain in which half the females produce daughters almost exclusively, Doncaster showed that these females generally had only fifty-five chromosomes instead of the normal fifty-six. By reasoning analogous to that afterwards used by Bridges in his famous paper on "non-disjunction," he attempted a cytological interpretation, though, as he admitted, the solution was imperfect, and the case is still mysterious.

Progress was also made with the paradox of tortoiseshell cats, known by fanciers to be almost exclusively females. Doncaster proved that tortoiseshell is the female heterozygote of orange and black, the corresponding male being orange; and in the course of wide inquiries he discovered the new fact that the rare tortoiseshell tom is often *sterile*. In his last paper he conjectured, not without probability, that, in view of Lillie's extraordinary discovery as to the free-martins of cattle, these males may owe their peculiarities to the intra-uterine influence of other embryos. Most of these subjects are discussed in his text-book, "The Determination of Sex," 1914. Just before his death Doncaster published an admirable "Introduction to the Study of Cytology," in which he declared himself with reservation a convert to the views of Morgan—a judgment which, from so critical an observer, must carry great weight.

His death will be cruelly felt. At a time when cytology is becoming a subject of primary importance, the loss first of R. P. Gregory and now of Doncaster leaves us bereft indeed.

Doncaster was one of the clearest-headed men I have known, and, being full of both enthusiasm and knowledge, he taught extraordinarily well. In Cambridge he served in various capacities, and was for four years in the University of Birmingham. As Prof. Herdman has written, his death is "nothing less than a calamity to Liverpool University." Doncaster was slight in figure and of a nervous temperament, feeling and thinking of everything with intensity, though nevertheless a fluent speaker. He came of a Quaker family, being the son of Samuel Doncaster, manufacturer, of Sheffield, in whose beautiful garden he developed his love of plants. Educated at the Friends' School at Leighton Park, Reading, he went up as a scholar to King's College, Cambridge, of which he afterwards became a fellow. He married in 1908 Dora, daughter of Walter Priestman, of Birmingham, and leaves three children.

We did not speak of such matters, but it was known to his friends that Doncaster had religious instincts strongly developed. The years of the war were to him more hateful even than to most thoughtful men. He held the Friends' attitude of the unlawfulness of war, but, feeling that alternative service was a duty, he gave up his researches and qualified as a bacteriologist, working in the 1st Eastern Hospital, Cambridge, and afterwards in the Friends' Ambulance Unit at Dunkirk.

W. BATESON.

MR. JOHN W. HYATT, of Newark, New Jersey, whose death is reported at the age of eighty-two, was the inventor of celluloid. He was a printer by trade, and was using collodion in the course of his work when he accidentally overturned a bottle, and the idea of celluloid came to him from watching the collodion solidify. He took out 250 patents in all, a large majority of which had an important bearing on manufactures. They included a billiard-ball composition, a roller bearing, a system of purifying water for domestic use, a sewing machine capable of sewing fifty rows of lock-stitches at once, a machine for extracting juice from sugar cane, and a new method of solidifying American hardwoods. In 1914 Mr. Hyatt was awarded the Perkin medal of the New York Society of Chemical Industry.

WE much regret to see the announcement in the *Times* that PROF. AUGUSTO RIGHI, For. Mem. R.S., died suddenly at Bologna on June 8 at seventy years of age.

### Notes.

THE list of honours conferred in celebration of the King's Birthday includes the following names of men associated with scientific work:—*Irish Privy Councillor*: Mr. H. T. Barrie, Vice-President, Irish Department of Agriculture. *K.C.B.*: Sir A. W. Watson, president of the Institute of Actuaries. *C.B.*: Mr. A. W. Flux, Assistant Secretary, Board of Trade. *Baronet*: Mr. P. J. Mackie, who financed the Mackie Anthropological Expedition to Uganda and other expeditions. *Knights*: Prof. F. W. Andrewes, F.R.S., pathologist at St. Bartholomew's Hospital; Capt. D. Wilson-Barker, captain-superintendent of the training-ship *Worcester*, and past-president of the Royal Meteorological Society; Dr. J. C. Beattie, Principal of the University of the Cape of Good Hope; Mr. W. B. M. Bird, founder of the *Salters' Institute of Industrial Chemistry*; Dr. H. H. Hayden, Director of the Geological Survey of India; and Prof. J. B. Henderson, professor of applied mechanics, Royal Naval College, Greenwich. *C.I.E.*: Mr. C. M. Hutchinson, Imperial Agricultural Bacteriologist, and Mr. R. S. Pearson, Forest Economist, Research Institute, Dehra Dun. *K.B.E.*: Dr. J. Dundas-Grant, eminent aural specialist; Dr. J. C. Stamp, distinguished economist; and Col. W. Taylor, ex-president of the Royal College of Surgeons in Ireland. *Companions of the Imperial Service Order*: Mr. R. B.

Newton, assistant in the Department of Geology, British Museum (Natural History); Dr. W. Eagle Clark, keeper of Natural History Department, Royal Scottish Museum, Edinburgh; and Mr. R. Duncan, Staff Officer, Veterinary Branch, Department of Agriculture and Technical Instruction, Ireland.

THE following decorations have been conferred upon scientific workers in recognition of valuable services rendered during the war, and the King has granted permission to wear them:—Conferred by the King of Italy—Order of the Crown of Italy: *Chevalier*: Mr. H. D. Roberts, director of Public Library, Museums, and Fine Art Galleries, Brighton. Order of St. Maurice and St. Lazarus: *Officer*: Sir Douglas Mawson, Dr. T. M. Lowry, F.R.S., and Prof. P. F. Frankland, F.R.S. Conferred by the King of the Belgians—Order of the Crown: *Grand Officer*: Sir Alfred Sharpe. *Commander*: Prof. W. Somerville. *Officer*: Dr. E. J. Russell, F.R.S. *Chevalier*: Mr. C. E. Fagan, Mr. A. R. Hinks, F.R.S., secretary of the Royal Geographical Society, and Mr T. McRow. Order of Leopold II.: *Commander*: Dr. W. R. Dunstan, F.R.S., director of the Imperial Institute, and Prof. G. H. F. Nuttall, F.R.S.

It is announced in *Science* that the U.S. National Academy of Sciences has recently elected the following foreign associates:—Frank Dawson Adams, McGill University; Marie Ennemond Camille Jordan, Collège de France; François Antoine Alfred Lacroix, Musée d'Histoire Naturelle, Paris; Heike Kamerlingh Onnes, University of Leyden; Sir David Prain, Royal Botanic Gardens, Kew; and Santiago Ramon y Cajal, University of Madrid.

MR. O. F. BROWN, assistant inspector of wireless telegraphy in the Post Office, has been appointed Technical Officer to the Radio Research Board, which has been formed recently under the chairmanship of Admiral Sir Henry Jackson, in connection with the Department of Scientific and Industrial Research.

SIR W. J. POPE, F.R.S., was elected an associate of the section for the mathematical and physical sciences of the Académie Royale de Belgique on June 5.

COL. H. G. LYONS has been appointed director and secretary to the Science Museum, South Kensington, in succession to Sir Francis Ogilvie, who has been transferred to the Department of Scientific and Industrial Research.

PROF. FLINDERS PETRIE in *Ancient Egypt* (1920, part ii.) describes a remarkable statue of ebony 27 in. high. "The pose of the standing position is more thrown back than in the Old Kingdom, from the waist upward. The head has had inlaid eyes, now missing. The expression is marvellously vigorous and full of vitality, and it differs from other Egyptian figures not only thus, but also in the type. The very wide jaw, short chin, and high cheek-bone have hardly a parallel in other statues. It is clearly one of the great masterpieces, and of a rare style of work." It is stated to have come from the Eleventh Dynasty temple at Deir-el-Bahri, and may represent one of the Mentuhotep kings, but the provenance is so uncertain that it is

difficult to identify it. "When workmen are not well rewarded for the objects found, much is taken away without any record of the original place and connection. If we knew the position to which the figure belonged, the burial chamber, the royal shrine, the family shrines, or elsewhere, we might have fixed the historic value of one of the most striking portraits known from Egypt."

MR. J. BRONTÉ GATENBY, whose papers on the cytoplasmic inclusions of the germ-cells have formed such a conspicuous feature of the *Quarterly Journal of Microscopical Science* during the last few years, contributes to the last number of that journal (vol. lxiv., part 3) a valuable account of the modern technique of cytology, which, taken in conjunction with his recently published paper on "The Identification of Intra-cellular Elements" (*Journal of the Royal Microscopical Society*, 1919), should prove of great use to students of microscopical zoology. These papers will place within reach of all many of the numerous modern refinements of technique which are indispensable to future progress, and the use of which bids fair to increase to a very great extent our knowledge of cell morphology and development. We are glad to learn that the author has also undertaken to edit a new edition of that classical and widely appreciated work, Bolles Lee's "Microtomist's Vade Mecum."

IN sending the Report of the Curator of the Somerset County Museum, Taunton Castle, for the year ended September 30, 1919, Mr. H. St. George Gray directs our attention to three graphs showing (1) the annual increase in membership of the Somersetshire Archaeological and Natural History Society since 1880; (2) receipts from entrance fees to the museum for the years of this century; (3) fluctuations in the number of visitors during the same period. We are not prepared to admit offhand that this is the first application of graphic curves to society and museum statistics, but the results are undoubtedly illuminating, and, in this case, raise interesting questions for the consideration of those directing the policy of the museum. If such charts, with more frequent time-intervals, were prepared on a consistent plan by all institutions of the kind, their comparison would bring new light to social and economic studies.

THE *Museums Journal* for April-May prints a weighty report on the relation of museums to the advanced student, presented to a British Association Committee by a strong sub-committee. It is claimed that the interests of the serious student should not be sacrificed to those of the general visitor. The needs of the researcher, university student, private student, and collector are considered, and practical recommendations are based on experience. In view of the proposed site of London University, it is interesting to find the report urging closer co-operation between universities and museums. "The student may fairly be asked to help by doing some curatorial work. . . . The museum will profit by the improved arrangement of the objects, and the student will learn how to utilise specimens and how to discover the relevant literature." The student should be supported by "a

system of scholarships, held on the double condition of carrying out in the museum research work and curatorial work satisfactory to the professor and the curator respectively."

An interesting addition to the literature on the subject of the relationship between light and plant-growth appeared recently in the *Journal of Agricultural Research* (vol. xviii., No. 11, March, 1920). In this paper W. W. Garner and H. A. Allard discuss the effect of the relative length of day and night, and of other environmental factors, on growth and reproduction. Their results show that the relative length of the day is a factor of the first importance in plant growth, particularly with respect to sexual reproduction. The effect on sexual reproduction of environmental factors such as temperature, water-supply, etc., seems to be simply one of acceleration or retardation so long as these factors are within a normal range. The seasonal length of day, however, may actually initiate the reproductive processes or inhibit them, according as to whether the given length of day is favourable or unfavourable for the particular species. If the length of day is unfavourable to sexual reproduction, but favourable to growth, then vegetative development is continued indefinitely; but if the length of day is favourable to both reproduction and growth, then the period of sexual reproduction is extended. The seasonal range in the length of day is therefore an important factor in plant distribution, and, moreover, the relation between length of day and reproduction emphasises the great necessity for seeding crops at the proper time.

In Publication No. 295 of the Carnegie Institution of Washington, entitled "A New Type of Hereditary Brachyphalangy in Man," Messrs. Otto L. Mohr and Chr. Wriedt illustrate the heritability of a trivial character for six generations. The character is a symmetrical shortening of the second joint of the second fingers and toes which recurred without any break for six generations within a Norwegian family, some members of which emigrated to America. Without exception the peculiarity was restricted to the particular phalanx mentioned, the hands and feet being in other respects quite normal. There was no associated shortness of stature. The anomaly manifests itself under two distinctly different somatic types, one "slightly" shortened and generally overlooked by the affected individuals, the other "much" shortened and very striking. No case of an intermediate condition was observed. The brachyphalangy is inherited as a dominant, not as a sex-linked, character. The numerical ratio between the affected and unaffected individuals in the offspring of brachyphalangous members of the family is in accordance with the theoretical Mendelian expectation. All the brachyphalangous individuals are heterozygous for the gene in question, with one possible exception. The material includes a case of identical twins, both showing the same type of brachyphalangy. A genetic explanation of the occurrence of the "slightly" shortened and the "much" shortened types is suggested. The authors are to be congratulated on their careful working out of an interesting case.

ON Friday, June 4, the Association of Economic Biologists and the Imperial Botanical Conference held a joint meeting at the Rothamsted Experimental Station, Harpenden. The greater part of the day was devoted to an examination of the field experiments which were demonstrated by Dr. E. J. Russell and Dr. Winifred E. Brenchley. The park grass plots have been under grass for some centuries; it is not known that seed has ever been sown, and at the beginning of the experiments (1856) the herbage on all the plots was apparently uniform. The twenty-three plots are each manured differently, the same treatment being maintained year after year, and the southern half of each plot is limed. The difference in the vegetation on the several plots is now most remarkable, and, quite apart from the great and immediate practical value of the experiments, they are an ecological demonstration of the very first importance. The Broadbalk wheat field is perhaps the most famous single field in the world. Here wheat has been grown continuously since 1843, the eighteen plots receiving different manurial treatment which has been maintained year after year. The knowledge already yielded by Broadbalk has served almost to revolutionise the earlier ideas concerning the growth and needs of the wheat-plant and the nature of the soil, and the attention now being concentrated upon it by physicist, chemist, statistician, protozoologist, entomologist, mycologist, and algologist should continue the good work begun by Lawes and Gilbert, and so ably sustained by Sir Daniel Hall and the present director. After tea Dr. A. D. Imms opened a discussion on "Tropisms," giving a brief account of his own investigations on chemotropism, and relating these to the general theory of tropisms formulated by Loeb. A paper specially contributed by the latter author was read, and Dr. Tillyard, of New Zealand, Mr. E. E. Green, Dr. Williams, Sir J. C. Bose, Mr. W. B. Brierley, and Prof. Neilson Jones took part in the discussion that followed.

An interesting case of extreme differentiation of types of igneous rock, in which the whole series is accounted for by gravitational separation, is described concisely by Mr. H. C. Cooke in "The Gabbros of East Sooke" (Canada Geol. Survey, Museum Bull. No. 30, 1919). In view of the use of the mineral name "anorthose" for soda-microcline, objection may be taken to the term "anorthosite" for rocks with feldspar akin to anorthite.

PROF. G. CESÀRO sends us a paper on minerals from Monte Somma and Vesuvius, which is of interest as having been prepared for issue in the *Bulletin de la Classe des Sciences de l'Académie royale de Belgique* in 1914, and actually circulated by its author in 1919. Prof. Cesàro has meanwhile, by the stress of war, become personally known to a circle of British mineralogists, who will maintain cordial relations with him despite his return to his own country. As an appendix to the paper Prof. Cesàro describes an apatite from Cornwall as having a low birefringence, and therefore a high fluorine content, and in dealing with similar apatite from Vesuvius he quotes from his previous work the relations between the fluorine present and certain angles of the crystals.

BULLETIN No. 22, part i., of the Geological Survey of New Zealand, on the limestone resources of the country, by Mr. P. G. Morgan, is really a treatise on limestone and its uses, illustrated from occurrences in New Zealand. It is thus exactly suited to local requirements; but both it and its successor on the phosphates will be welcomed in a much wider field. Attention is well given to the use of lime and of ground limestone on the land. The literature to be consulted is wide, but we note that all the papers named as of a general character are of American origin. We thus miss the work of Messrs. Hutchinson and MacLennan at Rothamsted, published in the *Journal of Agricultural Science* in 1915. Mr. J. A. Hanley's account of his experiments with various limes in Yorkshire (*Journ. Soc. Chem. Indust.*, 1918) is probably too recent for inclusion, since communications have been disturbed by war; but for some years past there have been indications that authors and publishing bodies in the United States have been more mindful than ourselves of libraries in the Pacific region. This should be a reminder for Britons, who are the true begotten of the enterprising island folk.

THE Executive Committee of the Advisory Council of Science and Industry of the Commonwealth of Australia has issued the third and concluding part of an exhaustive report by Dr. F. L. Stillwell upon the factors influencing gold deposition in the Bendigo goldfield. As is well known, the mode of occurrence of the gold reefs in this field is quite unique, and its peculiarities have given rise to much discussion, so that the thorough investigation here presented should be of great interest to all students of mineral deposits. The general conclusions arrived at are that the form of the reefs is due primarily to that of the original fracture through which the depositing solutions have percolated; that all the large and important reefs have been in some way associated with faults, the latter being generally contemporaneous and connected with the folding of the rocks, the faults having given rise to a network of fractures which afforded a passage to the mineralising solutions; and that the deposition of the gold from these solutions has been brought about in three ways: (1) Precipitation from the auriferous solution; (2) crystallisation from a supersaturated solution; and (3) crystallisation from solutions the supersaturation of which is due to decreasing temperature after the main portion of the gold has been precipitated. The first of these is the most important method of deposition, and appears to be closely connected with the presence of carbonaceous matter.

In his address to the Royal Geographical Society at the anniversary meeting on May 31, Lt.-Col. Sir Francis Younghusband pleaded for a wider outlook in geography and freedom from a strictly utilitarian viewpoint. A knowledge of the beauty of the earth may be legitimately included within the scope of geographical science. Beauty of scenery in many instances is the most noteworthy characteristic of a country and its most valuable asset. Advertisements of tourist organisations, railway and steamship companies, and even emigration departments, bear con-

stant witness to the importance of this aspect. Moreover, natural beauty is inexhaustible, while mineral wealth is limited and agricultural productivity not unbounded. Sir Francis Younghusband contended that the geographical knowledge of a country was incomplete without a knowledge of its beauty, and that by this means alone can the geographer gain a sense of the earth "as live, supple, sensitive, and active." Continuing, he pointed out that there should be less hesitation in accepting this principle when it is realised that natural beauty affects the movements of man, and that man is having an increasing effect on natural beauty, often, but not always, with disastrous results. This relationship between man and the beauty of the earth is one of which geography should take as much cognisance as it does of the relationship between man and the productivity of the earth. The knowledge of beauty must be carefully gathered. Careless snapshots and shallow rhapsodies in guide-book style are unsatisfactory. We require the best photographs as well as paintings and accurate descriptions of literary merit. The artist both in pencil and in words is essential in geographical work.

In the *Meteorological Magazine* for May a notice is given of the circulation of forecasts by wireless telegraphy from collective weather reports for London and south-east England. Hourly reports of meteorological information prepared by the Forecast Service of the Meteorological Office are sent out from the wireless station at the Air Ministry. The message is given in a code form, which is practically the same as that prescribed in Annex G of the "Convention relating to International Air Navigation," Paris, 1919. The forecasts, which are being issued eight times a day, are based on observations taken about half an hour before the time of issue. Detailed explanation of the code can be obtained on application at the Meteorological Office. A new device is also mentioned for making the meteorological reports rapidly available to the public. A large weather map is exhibited daily at the Air Ministry in one of the front windows on the ground floor of Empire House, Kingsway. All the principal reporting stations in the British Isles, as well as a few neighbouring Continental ones, are marked on the chart, which is on the Mercator projection, and is 10 ft. high and 6 ft. wide. The information on the chart is changed at about 3h., 5h. 30m., and 14h. 30m. G.M.T., the data exhibited referring to observations made at 1h., 7h., and 13h. G.M.T. The exceptionally wet character of April is well shown in the Thames Valley Rainfall Map, where upwards of 5 in., and in places more than 6 in., of rain occurred during the month over the western portion of the valley. Districts with less than 3 in. are rare, and almost entirely confined to the neighbourhood extending from London to the mouth of the Thames. In England and Wales the general rainfall for April was 204 per cent. of the average.

FOR many years the utilisation of the water-power of the Rhone has attracted attention in France. The shortage of coal has renewed interest in the problem,

which is now on the road to solution. The Chamber of Deputies has taken the matter in hand, and agreed to proposals which now await consent by the Senate. According to an article by M. M. Fourniols published in the *Revue générale des Sciences* for May 15, the plan is to divide the river into six sections, to be managed separately or preferably by a single body. Concessions are to be for seventy-five years' duration, and will be helped by State loans. Besides the utilisation of water-power, the project embraces the improvement of navigation, the creation of river ports, and the construction of irrigation works. At present the conditions are not favourable for navigation, but the recently opened canal from Marseilles to Arles opens a new vista of possibilities in cheap river connections with the sea. It is proposed to erect a number of power stations between Genissiat, near the Swiss frontier, and Comps, near Tarascon. Genissiat with 200,000 h.p. will be the largest, and will probably supply power to Paris. Other important stations will be near Lyons, Valence, Montelimar, and Mondragon. A form of dam and locks is projected which will interfere as little as possible with navigation.

In an article in the *Revue Scientifique* for May 22 M. A. de Gramont de Guiche, president of the council of the Institute of Optics of France, describes the arrangements made for the first session of the institute, April to July, of the present year. The institute is divided into three sections: (1) A school of higher studies intended to provide the training requisite for the specialists in the subject; (2) a laboratory for research and practical instruction; and (3) a school for the training of the workmen and craftsmen both in glass- and in instrument-making. At the opening of the course on April 12 M. Jobin, one of the members of the council, described in detail the objects of the institute and the steps that were being taken to carry out those objects, and Dr. Dunoyer gave the first lecture of a course on optical instruments. Other lecture courses are provided on "The Calculation of Optical Systems," "Spectroscopy," "Glass: Its Nature and its Applications," "The Applications of Polarised Light," "The Microscope," and "The Properties of X- and  $\gamma$ -Rays." The fee for the session is 150 francs, and, although no one is excluded, it is pointed out that to profit as much as possible from the course students should have a fair knowledge of mathematics.

In a paper published in the *Mathematical Gazette* for 1919-20 Dr. S. Brodetsky, reader in applied mathematics in the University of Leeds, brings forward a graphical treatment of differential equations as of special value in certain cases which are not soluble by the usual analytical methods and as of general value for purposes of instruction. There is justice in his view that the average student of mathematics regards the usual methods of solution as a series of tricks which he learns to apply with more or less success to such equations as are presented to him. A graphical treatment cannot fail to be of great value in teaching the meaning of differential equations and

in giving the student confidence in their use. The paper contains numerous examples, and illustrates the meaning of singular solutions, cusp loci, etc. Not the least interesting example is the solution of the equation

$$\frac{dy}{dx} = -\frac{x}{y} - (x^2 + y^2)^{\frac{1}{2}},$$

which occurred in discussing the motion of a plane lamina moving in air under the earth's attraction—one of the simple types of aeroplane motion. The equation was insoluble by any of the standard methods, but easily soluble graphically.

DURING the war considerable quantities of acetone were prepared by the fermentation of starchy material. Hitherto, however, no investigation of the mechanism of this fermentation has been described, and Messrs. J. Reilly, W. J. Higginbottom, F. R. Henley, and A. C. Thaysen publish in the April issue of the *Biochemical Journal* an account of a quantitative examination of the process. These authors find that the fermented mash contains varying proportions of acetic and butyric acids, the ratio of the latter to the former increasing with the increase (during fermentation) in the acidity of the mash and reaching a maximum at the stage of greatest acidity. Not until the latter stage is reached are appreciable quantities of acetone and *n*-butyl alcohol produced. With the production of "oil" the ratio of butyric to acetic acid diminishes, and finally the mash contains an excess of acetic acid. During the period of the increase of acidity, of the mash the rate of gas evolution rises steadily for some time, then becomes constant; and as the acidity falls the rate of gas evolution rises quickly to a maximum, and then falls rapidly until the end of the fermentation. The gas consists of hydrogen and carbon dioxide in a proportion varying from 3:1 at first to 2:3 at the latter part of the fermentation. It is extremely probable that acetic and butyric acids are not the only acids formed, and evidence is given of the presence of an acid less volatile in steam. Lactic acid results from the type of infection most frequently observed. If the fermentation is carried out in the presence of calcium carbonate it proceeds as far as the point of maximum acidity, but the production of acetone and *n*-butyl alcohol is almost entirely suppressed.

In the *Wiener Denkschriften* (Math.-Naturwiss. Kl., Bd. 96, pp. 671-750, 1919) Dr. A. Defant continues his important researches on tides in landlocked and border seas, bays, and channels. After a theoretical discussion of the influence of friction against the ocean-bed in channels, he deduces an average value of the coefficient of skin friction from a consideration of the tides in the Gulf of Suez and in certain lakes which exhibit seiches. He then enters upon a careful detailed study of the tides in the English Channel, using a step-by-step numerical method for the solution of the differential equations of the tides between successive cross-sections of the Channel. He thus succeeds in demonstrating the truth of a conjecture made long ago by Airy to the effect that the complicated tides of the Channel are governed mainly

by the definite tidal oscillations of the Atlantic Ocean and the North Sea at the two ends of the Channel; this view had been contested by Börgen, but the consequences of the view were misinterpreted by the latter. Dr. Defant shows that not only the co-tidal lines and tidal ranges, but also the phase and speed of the tidal currents in the Channel, can be explained on the basis of Airy's ideas, taking surface friction at the channel-bed into account, and also the rotation of the earth. He finds that the latter affords an explanation of why the tidal range on the French coast of the Channel is greater than that on the English coast. For the sections of the Channel near the east opening into the North Sea the calculations cannot be executed with the accuracy elsewhere obtained, owing to the approximation of the ocean-tidal period to the free period of lateral oscillation across this broad part of the Channel. But even here the chief features can be derived by interpolation, and throughout the remainder of the Channel all the important features of the complex Channel tides receive satisfactory theoretical explanation.

THE paper read by Gen. Squier to the U.S. National Academy on April 27 on "Multiplex Telephony and Telegraphy over Open-circuit Bare Wires Laid in the Earth or Sea" has excited great interest amongst radio-telegraphists, who find it difficult to make out whether we are on the eve of important developments or not. Gen. Squier has established communication for a distance of three-quarters of a mile over the Potomac River by means of a bare No. 12 phosphor-bronze wire laid directly in the water. The transmitter consisted of an electron tube oscillator, which produced a current of about 270 milliamperes at a frequency of 600,000. At the receiving end of the line an electron tube and a six-stage amplifier were used without any earth connection. With this arrangement good tuning could be obtained at either end of the line, and satisfactory telegraphic and telephonic transmissions secured by means of the bare wire immersed in fresh-water. In another experiment telegraphic and telephonic transmission were obtained between two stations three-quarters of a mile apart by means of a No. 16 copper wire buried in the earth to a depth of about 8 in. It will be seen that if the method develops satisfactorily it will have commercial possibilities. The best Atlantic cable cannot operate at a frequency greater than 10 per second, and 80 volts is the highest voltage that can be applied to work it. There is scope, therefore, for development in submarine telegraphy. Gen. Squier suggests that experiments should be made with bare wires in sea-water to determine what arrangement will give the best results. He points out that with this method there will be no distortion of the signals, and so there is no limit to the distance of transmission, and the receiving apparatus will be comparatively simple. It is also possible to transmit simultaneously several signals, both telephonic and telegraphic, over the same wire by using different frequencies. The method is an attractive one, and seems to have arrived at the stage where commercial research can usefully be started.

## Our Astronomical Column.

PHOTOGRAPHS OF THE BRORSSEN-METCALF COMET.—The *Astrophysical Journal* for March contains some photographs of this comet taken by Prof. Barnard on 1910 October 5, 6, 20, and 22. The tail is shown as fully 6° long, composed of several narrow straight streamers forming a fan. They radiate from a point somewhat behind the centre of the head. About October 20 the comet discarded its tail, and formed a new one inclined 12° to the old. Prof. Barnard notes that similar phenomena have been observed in Borrelly's comet, 1903 July 24, in Morehouse's comet on several dates in 1908, and in Halley's comet on 1910 June 6 (probably also in April).

In each case the new tail appears to move out faster than the rear portion of the old tail. Prof. Barnard conjectures that the latter is formed of larger particles, the motion of which would be slower.

He has combined successive cometary photographs in the stereoscope in the endeavour to determine the configuration of the tail in three dimensions. Care is, of course, required to distinguish true stereoscopic effects from spurious ones. It is stated that the tail of Morehouse's comet on October 15, 1908, resembled "part of an open sack, or a partly opened scroll."

THE PLANETARY FAMILIES OF COMETS.—The report of the nineteenth meeting of the American Astronomical Society contains a paper on this subject by Prof. H. N. Russell. He notes that the orbits of the six comets of the Neptune group all pass considerably closer to the orbits of Jupiter and Saturn than they do to that of Neptune. His first conclusion was that these comets had been captured not by Neptune, but by Jupiter. He analysed the orbits of the periodic comets with the following result:—

Thirty-six comets on his list have periods of less than ten years. The orbits of all these, except Encke's, pass within 0.65 of Jupiter's orbit, while seventeen of them pass within 0.15 of it.

Thirty-one comets have periods between ten and one thousand years. Of these, seven pass within 0.5 of Jupiter's orbit, five within the same distance from Saturn's orbit, and two within this distance from Uranus's orbit, the nearest approach to Neptune's orbit being 1.22.

Prof. Russell has calculated the proportion of the thirty-one comets that would pass within 0.5 of each orbit on the hypothesis of chance approach, and finds that it is six for Jupiter, three for Saturn, one and a half for Uranus, and one for Neptune. Hence he concludes that the observed figures give little evidence of capture by any of the planets.

There is, however, a point not noticed by Prof. Russell, which is that the periods under a century range themselves into four definite groups, the mean period of each group being about 0.4 of that of one of the giant planets. This gives strong ground for postulating a connection with these planets. Since Halley's comet has been observed for more than two thousand years, there is no difficulty in assigning to it a life dating back to the time when its orbit intersected that of Neptune. The longer the period of a comet the less frequent are the occasions when it is subject to serious disruptive influences, and consequently its disintegration is likely to be less rapid. It appears to the writer of this note that Proctor's suggestion that the periodic comets are the products of eruptions from the giant planets deserves more attention than it has generally received.

## The Thunderstorms of May 29 and the Louth Disaster.

THE last week of May was marked by hot weather all over the country and by numerous thunderstorms, which culminated in the notable downpours of rain which occurred on Saturday, May 29. The highest temperatures were reported on Tuesday, May 25, when 82° F. was reached in London and the Thames Valley. In London the magnificent cumulus clouds made a fine spectacle, but it was further north, in the neighbourhood of Luton, that thunderstorms occurred. Paris suffered from a severe storm on the same day.

On Wednesday, May 26, when an area of comparatively low pressure extended across England and Ireland, there were thunderstorms in London and in other parts of the country during the afternoon. The rainfall in the west of London was exceptionally heavy. The area affected was somewhat sharply outlined on the west. At Hammersmith the roads were flooded and wood pavements burst up by the water, but at the Meteorological Office, a couple of miles away, only 2 mm. of rain fell. At Uxbridge 33 mm. fell in half an hour.

The distribution of pressure remained irregular, but lower over the British Isles than over neighbouring countries, and on Friday evening a "low," which appears to have originated over the South of France, began to deepen and to move northward. The map for 7h. G.M.T. on Saturday, May 29, indicates the depression by the isobar 1012.5 mb. over the Bristol Channel. At 13h. pressure was below 1012 mb. over the Midlands. By 18h. it had fallen to 1009 mb. in the same region. On Sunday morning the depression was over the North Sea, and by the evening, when it had deepened to 1004 mb., it was centred at the Shetlands.

The rainfall on May 29 was insignificant in the South of England, but falls of half an inch or more were general from Nottingham northwards. The exceptional falls in Lincolnshire and Lancashire occurred before the northward passage of the trough of lowest pressure. As to the downpour in Lincolnshire, to which the damage and loss of life at Louth are to be attributed, records are available from Hallington, in the valley west-south-west of the town, and from Elkington Hall, on the hills to the north-west. In each case the measurement was about 120 mm. in two hours, giving a mean rate of fall of 1 mm. per minute. According to newspaper reports, 100 mm. fell at Horncastle, twelve miles south-south-west of Louth.

The area with an exceptionally heavy rainfall included Bucknall, sixteen miles south-west of Louth, with a total fall of 54 mm.; at Lincoln, twenty-four miles away, the fall was 52 mm.; and at Spurn Head, to the north, it was 35 mm. The boundary of the area of heavy rain is marked by 34 mm. at Cranwell and 12 mm. at Fulbeck, these places being about four miles apart on either side of the Ermine Street, south of Lincoln. At Skegness only 12 mm. fell. There were two thunderstorms in the afternoon, both carried westward by the wind on the north side of the cyclone. One was at Skegness at 13.15 G.M.T., and at Lincoln at 14.30. The other, which was the more severe, moved more slowly, passing Skegness at 16h. and Lincoln between 18.30 and 19h.

The Louth disaster seems to have been associated with the former storm. From the evidence at the inquest of a witness from Benniworth, a village on the far side of the Wolds, in the Bain Valley, it appears that after a little rain between 12h. and 14.15 the weather cleared, but that at 14.30 the rain suddenly poured so fast that the house-pipe could not

carry it. "In a moment the fields were at least 8 in. deep in water. I saw a huge cloud in the shape of an egg which kept twisting round. There were three flashes of lightning, very vivid and very shocking. One seemed to pierce through the cloud, and immediately afterwards the cloud seemed to come earthward."

Examination of the ground by the deputy coroner indicated that the heavier rainfall had been on the north side of the line from Louth to Lincoln, and that it was more severe higher up the valley than at Hallington, where the rain-gauge, which measured 120 mm., was situated. It is likely that the 120 mm. is a fair average for the fall over the basin of the Lud above Louth. This basin contains three or four brooks which unite above the town and drain an area of about 20,000 acres. The Wolds are chalk hills, however, and no doubt the greater part of the normal drainage is underground. This may account for the absence of any provision for the passage of flood-water, but much of the ground slopes at about 100 ft. to the mile, so that water would run off rapidly. Rainfall at the rate of 1 mm. per minute over an area of 80 sq. km. would feed a stream 5 metres deep and 100 metres wide rushing along at 160 metres a minute, and the Lud does not appear to have reached such a magnitude as this. The town seems to have been singularly fortunate in escaping floods in the past, as a rainfall of even one-quarter of that on the present occasion could scarcely have found its way through the narrow bridges of the town.

With regard to the heavy falls in Lancashire, we are so fortunate as to have the autographic record from the rain-gauge at Leyland, to the south of Preston. The total fall for the twenty-four hours, 9h.-9h. May 30-31, is about 80 mm., "the like of which the proverbial oldest inhabitant cannot remember." The heaviest downpours were from 16.30 to 17h. and from 17.55 to 18.15. In the latter interval of twenty minutes no less than 40 mm. were recorded. The more dramatic exploits of the flood-water due to this storm appear to have been to the north of Preston, where the main line of the London and North-Western Railway was interrupted by the destruction of the embankment near the crossing of the River Brock. In spite of the long duration of the rain at Preston, the fall at Blackpool, fifteen miles to the west, amounted to only 5 mm. in the twenty-four hours.

## Annual Meeting of the British Science Guild.

THE annual meeting of the British Science Guild was held in the Goldsmiths' Hall on Tuesday, June 8, the chair being taken by Lord Sydenham, president of the guild.

In his address on "Science and the Nation" the president referred to the strike evil as one of the great industrial problems of the day. The moulders' strike had seriously affected many industries; loss in coal had reached 50,000,000 tons a year as compared with 1913, with serious consequences to the export trade. The evil was due partly to an abnormal state of mind arising from the war, but was originally fostered by the industrial changes of the last century, namely, the general use of machinery, rendering labour monotonous and leaving less room for the individual skill of the craftsman, and the formation of large companies, whereby the personal touch between master and man was lost. Capital unduly concentrated in a few hands might lead to tyranny. This country needed a wider distribution of capital. Labour and capital must be reconciled, and science must find an



antidote for the deadening influence of the machine. In the latter portion of his address Lord Svydenham emphasised the importance of a more general knowledge of science, especially amongst members of the Government and the Civil Service, and alluded to the efforts made by the Guild in the dissemination of scientific knowledge and methods. He concluded by quoting Goethe's saying that "there is no more dreadful sight than ignorance in action."

Lord Svydenham then introduced the president-elect, Lord Montagu of Beaulieu, who delivered an address on "Some National Aspects of Transport," and afterwards occupied the chair. Lord Montagu remarked upon the growing difficulties of railways, which, although subsidised by the State, were working with a diminishing margin of profit owing to the vast increases in cost of materials and in wages. Some of the largest tramway systems, such as the L.C.C. in London, were incurring actual loss, and a general increase in fares and rates seemed inevitable. Some economies might be achieved by more scientific methods of handling traffic and the elimination of competition, but the saving from this source appeared relatively small. The possibilities of road transport, therefore, assumed importance. Already the comparative cheapness of short-distance road-borne traffic had deprived the railways of much revenue. Existing roads, however, were unfitted to bear very heavy mechanical traffic. On a tar-macadam road the tractive force was 40-45 lb. per ton, three times the force on rails, and on bad roads up to 100 lb. per ton may be needed. In the pre-railway period roads carrying metal tracks 2 ft. wide were constructed for carts carrying coal, minerals, etc. It might be feasible to lay such a plateau from London to Birmingham with a tractive force of only 20 lb. per ton. The cost of a double track would be about the same as for a single line of railway, as gradients up to 30:1 could be used. The cost of operation would be on a smaller scale than on railways, and goods could be delivered direct from door to door. The idea could be extended to other large towns, and it was conceivable that overhead roadways, for the exclusive use of fast-running vehicles, might be made from the suburbs. The creation of such routes would lead to a material increase in the value of property through which they passed, and part of the cost might be met by a local transport benefit tax, applied in such cases.

Lord Montagu also referred briefly to other possible developments, such as the use of the airship for long distances and aeroplanes for shorter services, and the possible use of gas suction plant for propelling locomotives, motor-lorries, and ships, and of benzol and alcohol in the internal-combustion engine.

In view of the national importance of these problems, the creation of a chair of transport at one of the leading universities would be a deserving object for private beneficence. The two Institutions of Civil Engineers and Mechanical Engineers should be more frequently consulted by the Government in regard to road transport, and the National Physical Laboratory had done excellent work. The problem, however, was so vast as to demand continuous research at a special establishment.

The adoption of the annual report of the Executive Committee was proposed by Lord Bledisloe, and seconded by Sir Gilbert Parker, both of whom are vice-presidents of the Guild. A cordial tribute was paid to the valuable services Lord Svydenham had rendered to the Guild during his tenure of office, and both speakers expressed the general appreciation of Lord Montagu's acceptance of office as the new president.

The report, summarised by Lord Bledisloe, dealt with various aspects of the work of the Guild. The

second British Scientific Products Exhibition, held in 1919, was honoured by a visit from both King George and Queen Mary, accompanied by Prince Henry and Princess Mary, and demonstrated the growing appreciation by British manufacturers of the value of applied science. During the present year it is hoped to arrange a conference on science and labour in association with the Labour Party. A representative committee is being set up to collect full data on the utilisation of science, not only in the Civil Services, but also in all Government Departments, and the Parliamentary Committee, which has already intervened with good effect in the Forestry Bill, will watch all prospective legislation involving scientific and technical issues. The Education Committee of the Guild is still pressing for a real survey of the existing provision of university and higher technical education in the country, considering that the new Standing Committee on University Grants, acting under the Board of Education, is inadequate as regards composition and reference. The revised specifications of the Technical Optics Committee in regard to microscopes have already been adopted by two British firms.

The adoption of the report having been carried unanimously, the proceedings were terminated by a vote of thanks to the Master and Wardens of the Goldsmiths' Company for permission to hold the meeting in their hall.

### Annual Visitation of the Royal Observatory, Greenwich.

**D**URING the war this annual function was restricted to the official visit of the members of the Board. It has now returned to the conditions that prevailed many years ago, a large and representative gathering of astronomers and their friends being present on Saturday, June 5, to take part in the inspection of the observatory and instruments.

The return of many members of the staff who had been at the Front has naturally brought about a large increase in the number of observations. Those made with the transit circle exceed eight thousand in each element. In addition to the customary observations of sun, moon, planets, and clock-stars, the observing list now includes the stars selected by Packlund and Hough as secondary standards distributed with fair uniformity over the sky. Observations for this catalogue will be completed at the end of 1921.

The error of the moon's place in longitude for 1919, as predicted in the Nautical Almanac, was  $-12.26''$ , showing a notable diminution of nearly  $2''$  from the value for the three preceding years. The Astronomer Royal explains that this change is due to the omission in Hansen's tables of several sensible planetary terms. In view of the imperfections of these tables, it is satisfactory to note that Brown's new lunar tables have now been printed and are used in the Nautical Almanac, starting with the year 1923.

Two of the equatorials are now out of use. The 28-in., the mounting of which dates from 1851, requires renewal of the upper pivot; this work has been entrusted to Messrs. T. Cooke and Sons. The driving clock of the astrophysical equatorial was sent to Sir H. Grubb for repairs, which are still in progress. The observations of double-stars made with the 28-in. since its erection have been discussed by Mr. Jackson, who has published more than twenty new orbits in the Monthly Notices for March and April last. Fuller details of these and other systems will be printed in the Greenwich annual volumes. There are many systems for which orbits cannot yet be deduced, but where relative motion is shown; hypo-

tical parallaxes are being deduced in these cases, recent research having proved that such parallaxes are of considerable value for statistical purposes; they are, indeed, as trustworthy as those directly measured when the latter are of the order of 0.02".

The photographic determination of parallaxes with the 26-in. photographic equatorial has been resumed, and twenty new parallaxes have been determined with an average probable error of 0.008". It is anticipated that in future forty new parallaxes will be determined annually. The plan adopted for the measurement of the star images on the eclipse plates (that is, the preparation of a key plate with reversed images, which is placed film to film with the plates to be measured) is now being adopted for the parallax plates. Instead of producing the key plate by photography, short lines will be ruled on a glass plate in a north-and-south direction corresponding with the positions of the stars on each set of parallax plates.

A few photometry plates of the Kapteyn selected areas in N. decl. 30° have also been taken.

Two Star Catalogues are in process of being printed, viz. the zone catalogue of stars down to the 9th magnitude in N. decl. 24° to 32°, and the proper-motion catalogue of stars near the North Pole (vol. iii. of the Greenwich Astrogographic Catalogue).

The proper motions of the stars in both these catalogues have already been discussed in several papers in the Monthly Notices.

The reduction of the solar photographs fell into arrears owing to the impossibility of transmitting plates from India and the Cape to fill the gaps in the Greenwich series. Work is now being pushed on as rapidly as possible, and has been brought up to the middle of 1917. There were considerable solar outbursts in August and March last, both accompanied by magnetic storms, but the general spot activity is now on the decline.

The Astronomer Royal makes allusion in his report to the successful result of the eclipse expeditions of 1919. Transparencies from the plates secured then were on view, and showed both the star images and the splendid prominence 300,000 miles in length which was on the sun's eastern limb.

It is proposed to repeat the investigation of the star-shift at the eclipse of 1922 September 20. According to present plans, Messrs. Jones and Melotte will observe it from Christmas Island, Indian Ocean. They will use the astrogographic, mounted equatorially, discarding the cœlostæt, which is a source of trouble in work where great refinement is needed. Plans have been mooted for utilising the presence of the instrument in low latitudes to take a series of plates with the view of linking together the northern and southern magnitude scales.

The mean magnetic declination for 1919 is 14° 18.2': it is diminishing about 0.6' annually, so that it should reach zero about the end of the century.

As regards the weather of the twelve months ended on April 30 last, it is interesting to note that the period October–November was the coldest for eighty years, while the period December–April was the warmest for eighty years. This accounts for the exceptionally early appearance of the blossoms, which was three weeks in advance of the average.

The daily sunshine register has been supplemented since last January by a small fixed camera pointing to the pole, which records trails of circumpolar stars throughout the night, forming a gauge of the clearness of the sky.

The reception of wireless time-signals from Paris, Nauen, Lyons, and Annapolis now forms part of the daily routine. The times of their reception will be printed in the Greenwich volumes, and will be available for longitude determinations. It has lately been

announced that the Lyons signals can be read at Adelaide, so that it is hoped that improved values of the Australian longitudes will shortly be available.

The Astronomer Royal notes the loss that the observatory has sustained in the recent retirement of Messrs. Maunder, Thackeray, and Hollis, and expresses warm appreciation of their long and zealous services.

### Applied Statistics.

IT is only twenty-five years since Prof. Karl Pearson gave at University College, London, his first course of lectures on the mathematical theory of statistics, and the opening at University College, London, on Friday, June 4, of the handsome building provided by the generosity of Sir Herbert Bartlett, Bart., for the Department of Applied Statistics, including the Galton Laboratory and the Drapers' Company Biometric Laboratory, marks another stage in the progress of what is more than a new branch of science, for there is scarcely a single field of scientific work in which the fundamental importance of the methods of research which have been developed by Prof. Pearson and his pupils has not been recognised.

The Drapers' Company in 1902 was the first to provide funds to carry on research work in what was then known as the Biometric Laboratory, and is now appropriately called the Drapers' Company Laboratory, and its annual grants have been continued up to the present time; while nine years later Sir Francis Galton bequeathed the residue of his estate to the University of London for the establishment of the Galton professorship of eugenics. Sir Francis expressed the wish, however, that so far as possible the capital of the endowment should be preserved intact, and the University accordingly issued an appeal for the building and equipment of a Francis Galton laboratory. Immediately afterwards Sir Herbert Bartlett offered to provide a building for both the Galton and Biometric Laboratories.

The building was nearly ready for occupation when, on the outbreak of war, not only had it to be given up for use as a military hospital, but also the voluntary services of the staff of the laboratories were offered to and accepted by the Government. In the early days of the war hundreds of diagrams were prepared weekly of the extent of unemployment in all the important towns of Great Britain, and when unemployment ceased to be a serious problem the laboratories were engaged in statistical inquiries into the seasonal use of shipping and rates of exchange and in investigations into aeroplane propeller stresses and ballistics. The computation of sights for various types of machine-guns to be used against low-flying German aeroplanes was carried out by very strenuous and continuous labour in six weeks.

One result of the delay in completing the equipment of the building is that funds which were insufficient in 1914 are now wholly inadequate, and this splendid building can only be partly used. Equally essential is the provision of funds for the salaries of the staff, and it is estimated that to complete and maintain the equipment of the new building and to carry on and develop the work of the laboratories in accordance with the intentions of its founders there is required an additional income of 5000*l.* a year. The Senate of the University of London has accordingly authorised an appeal for this endowment.

At the opening ceremony, at which Dr. Russell Wells, the Vice-Chancellor of the University of London, presided, Dr. Addison, Minister of Health, said that his work in the Ministry of Munitions had

been hindered by the constant struggles to find out what we had and what we wanted, and it was only when they obtained the services of trustworthy statisticians that the Department got into clear order. In the field of public health trustworthy statistics were of equal importance, and he therefore recommended to the public the appeal which had been made for additional funds, and promised to do all he could to help on the work of the laboratories. D. H.

## The Imperial College.

### CLAIM TO UNIVERSITY STATUS.

A MEETING in support of the claim of the Imperial College of Science and Technology for power to confer degrees and for university status was held at the Central Hall, Westminster, on Friday, June 4. Lord Morris, who presided, stated that the meeting was not called in hostility to any university or Government Department, or in disparagement of the atmosphere created by the universities. The governing body, the professorial staff, and the students, now numbering 1300, were unanimous in support of the claim of the Imperial College for power to confer degrees in its own subjects or faculties. The students were seriously handicapped by having to go to an external body for a degree, because of the current preference in the industrial and professional worlds for a degree to a diploma. Lord Morris moved a resolution urging the Prime Minister, the Lord President of the Council, and the President of the Board of Education to take the matter into serious consideration. The resolution also declared that any further delay would cause a growing sense of injustice.

Prof. W. W. Watts, who seconded the motion, pointed out that the report of the Departmental Committee, the recommendations of which in 1906 led directly to the establishment of the Imperial College, was based on a vision of a vast technological and Imperial institution, not confined to mere technical instruction, but devoted to the highest education and training in research in both pure science and technology. The Departmental Committee had stated clearly the reasons against incorporating the Imperial College in the University of London, pointing out that if the college was to be able to adapt itself to the ever-changing conditions of industry it must be free from the academic trammels of an education regulated, and rightly regulated, by other aims.

Mr. H. G. Wells, speaking in support of the motion, warned the meeting that in approaching the Lord President of the Council and the President of the Board of Education the delegates would have to combat the suspicion that their proposal involved a system of education and training likely to turn out men and women of narrow culture, mere technical experts without broad views. The curse of education in London had been the grandiose ideas of people who could not distinguish between the Universities of Oxford and Cambridge and the university conditions of London. It was almost impossible to conceive the widely separated college units in London co-operating successfully to form a single efficient university.

Sir Ernest Rutherford, speaking as a representative on the governing body of the Imperial College of the Dominion of New Zealand, said it was not generally recognised how much energy is spent in developing the pure science side of the Imperial College. It was only right and proper that the students, and particularly the overseas students, should have a degree where degree-work had been done, and the degree should be conferred by the teachers, and not by any

outside body. Surely we might broaden our ideas of university education in general. We had never before had an institution teaching technology on such a vast scale and to such a high standard as the Imperial College does. There was no precedent for the college, and therefore there could be no precedent against its claim to confer its own degrees. Subsequent speakers included Mr. J. A. Spender, Sir Richard Redmayne, and the Rector of the Imperial College, Sir Alfred Keogh. The resolution, modified slightly in accordance with suggestions made by Mr. H. G. Wells and others, was carried with one dissident.

## The Smoke Nuisance.

THE Manchester City Council is one of the few local authorities which have gone out of their way not only to put the smoke clauses of the old Public Health Act into force, but also to investigate the cost to the community of the smoke nuisance. With true wisdom it has realised that the æsthetic sense of the average man is controlled by his pocket, and that the direct road to reform is to make him understand how much he might save by a clean atmosphere.

We have received from the Air Pollution Advisory Board of the Manchester City Council a pamphlet entitled "The Black Smoke Tax," and although it deals mainly with an elaborate investigation into the relative cost in fuel, soap, and starch in an industrial and a residential centre, there is an introduction which reviews in brief but expressive language other causes of loss and damage which follow in the train of black smoke. The Board says:—"The damage is both æsthetic and economic. The look of things suffers. The value of things suffers. Everybody suffers and, since everybody suffers, it is a long time before anybody protests. If the damage were done suddenly there would be a general outcry, but it is done gradually. Thousands of Manchester people live their lives from start to finish in the midst of black smoke and have come to regard it as a normal condition of life. It is only in modern times that we have realised that the nuisance is preventable and that public economy, public health, and happiness alike call for its prevention."

The investigation has been conducted on the lines adopted in Pittsburgh, U.S.A., which showed an annual loss amounting to 4l. a head of the population. A large number of different classes of houses in Manchester (industrial) and Harrogate (residential) were personally visited and the weekly washing bill as nearly as possible ascertained. The net result was an additional expenditure in Manchester of more than 242,000l. annually on this item alone. The committee employed on this investigation concludes its report as follows: "As a result of years of patient investigation, coupled with strict rejection of all doubtful evidence, they can state emphatically that it would well repay Manchester to expend a large amount of thought and money on any measures that would help to reduce its enormous yearly smoke tax of at least three-quarters of a million pounds per annum."

The Ministry of Health has now taken the matter in hand and appointed a Smoke Abatement Committee to consider ways and means of abolishing smoke. The report of this committee will no doubt contain recommendations which will give local authorities greater facilities and stronger inducements for dealing with this pest of industrial towns. Coal smoke is opposed to every principle of economy, health, comfort, and cleanliness. It is a national scourge which has been too long tolerated.

J. B. C.

### The Molecular Energy in Gases.

BY request of the council of the Royal Society of Edinburgh, an address on "Molecular Energy in Gases" was delivered on May 3 by Principal Sir Alfred Ewing, who began by referring to a series of papers on the foundations of the kinetic theory which were communicated to the society thirty years ago by a great teacher and a great master of the subject, Prof. Tait. Since those days the kinetic theory had received what might be called ocular demonstration through Perrin's investigation of the Brownian movements, which exhibited the buffeting of visible bodies by the blows of the molecules. Much had come to be known regarding the probable structure of the atom. There had been substantial advances in the study of specific heats of gases and of their absorption and emission of heat in the form of infra-red rays. But the difficulty referred to by Tait of reconciling the known facts about specific heat with the theory of the equipartition of energy, as developed by Maxwell and Boltzmann, still remained, and had led to various applications or extensions of Planck's quantum theory, not only to the vibrations of gaseous molecules, but also to their rotations.

Some of these applications of the quantum theory appeared to the lecturer to be highly artificial, and also unnecessary. He proceeded to discuss the correspondence between the observed values of the specific heats and those that might be expected by applying ordinary dynamics to the translations and rotations of the molecules of a gas, and pointed out that the results presented a consistent scheme, which had, however, to be supplemented by taking account of the energy of vibration, especially at high temperatures. Vibratory energy became developed in a manner which was clearly not consistent with the principle of equipartition. It was now known that in all except monatomic gases the specific heat became notably increased at high temperatures, when the vibrations within the molecules began to be an important part of the whole energy. The experimental facts as to this increase were no doubt well expressed by means of Planck's quantum formula, but the type of curve which it gave was one that was found in other departments of physics. It was therefore open to question whether, if the nature of the constraints were understood, the development of vibratory energy in the molecules might not be interpreted in terms of other ideas than those of quanta, and without disturbing the old-fashioned principles of Newtonian dynamics.

### University and Educational Intelligence.

**BIRMINGHAM.**—In common with other universities, that of Birmingham has been overcrowded with students during the past session, and, in order that the necessary arrangements may be made to accommodate the maximum number for the ensuing year, public notice has been given that intending students should make application for entry not later than June 30. Already temporary buildings are being erected to cope with the certain increase in number of second-year students. The problem of adapting the number to be admitted to the available accommodation is undoubtedly difficult, but any method of restriction adopted will be devised with the object of securing admission to the fittest.

**CAMBRIDGE.**—Announcement is made in the *Times* that the directors of the Commercial Union Assurance Co. have allotted the sum of 165,000*l.* for a building of biochemistry, on a site provided by the University,

for the provision of adequate incomes for the professor and his staff and for the endowment of research.

**LIVERPOOL.**—At a meeting of the Senate of the University held on June 2 the following resolution was passed: "The Senate records with profound regret the death of Prof. Leonard Doncaster, F.R.S., Derby professor of zoology in the University. But a short time in Liverpool, Prof. Doncaster had taken a prominent place in the University, serving on the University Council as representative of his faculty, and had added to the reputation of the University by his contributions to science, and notably by his text-book upon cytology, published within the last few weeks. As colleague and friend he will be mourned by all members of the University. To Mrs. Doncaster and the members of his family the Senate would offer its most sincere sympathy."

THE Ramsay Memorial Trustees will proceed to the election of not more than three fellows at the end of this month. Applications must be received not later than June 15. Application forms, containing full particulars of the award, can be obtained from the Organising Secretary of the Ramsay Memorial Fund, University College, London. The fellowships are of the value of 300*l.* a year each, and tenable for two years. They are for the advancement of chemical research.

THE annual vacation course in Snowdonia for field-work in geography, geology, botany, map-making, and regional survey methods is being held under the auspices of the Geographical Association on August 7-21, with Llanberis as a centre. Particulars of the arrangements may be obtained by sending a stamped address envelope to Mr. H. Valentine Davis, "Noddfa," Wistaston, Crewe. The course is primarily intended for teachers of geography in public and other secondary schools.

LORD ERNLE presided at a meeting held last week at Chelsea House, Cadogan Square, to establish the training of women as skilled scientific cultivators on a national basis. In recognition of the magnificent work achieved, especially during the war, by Swanley Horticultural College in increasing every class of home-grown foods, and also in food preservation, the Ministry of Agriculture proposes to allot a Treasury grant of 10,000*l.* for the re-equipment and further development of this unique training college, provided the public contributes an equal sum. Never has the national need for scientific food production on one hand, and for remunerative and healthy employment for educated women on the other, been greater. Swanley has full capacities for carrying out both these works of national importance once the ravages of five years of war-shortages have been repaired, and the urgently needed new laboratories, lecture-rooms, library, and students' hostels have been erected and equipped. The great demand for women workers in agriculture and horticulture is proved by the fact that the applications from employers for Swanley students rose from 130 in 1914 to 648 in 1918. Prof. Keeble, of Oxford University, pointed out that the future cultivation of England would become more and more intensive, and that this intensive cultivation is now of the greatest national value, significance, and economic justification. Plans for the new science buildings at Swanley are now ready and the site is selected. It only remains for the public to provide the 10,000*l.* required to secure the Treasury grant for this urgent work of national utility. The appeal recently issued is signed by Lord Ernle, late President of the Board of Agriculture and Fisheries; Lord Lambourne,

president of the Royal Horticultural Society; Prof. J. Bretland Farmer; Prof. Keeble; Lady Northcliffe; and Viscountess Falmouth, chairman of the governing body, Swanley College. Donations may be sent to Messrs. Child and Co., 1 Fleet Street, London, E.C.4. Ten thousand pounds is needed at once, and 50,000l. for the complete installation of the science department and for the reconstruction of the college and of the intensive training grounds.

**Societies and Academies.**

LONDON.

**Physical Society**, May 14.—Sir W. H. Bragg, president, in the chair.—Dr. F. Lloyd **Hopwood**: Experiments on the thermionic properties of hot filaments. The experiments shown were some of those described by Dr. Hopwood in the *Philosophical Magazine* for March, 1915, p. 362, in which the glowing filament of a carbon lamp and glowing filaments of nichrome and platinum in air are made to move under the influence of positively and negatively charged rods brought into or withdrawn from their vicinity, the character of the effects observed being such as to give a qualitative indication of the thermionic emission from the filaments. In addition, he showed a type of tilted electroscope in which the gold-leaf was replaced by a narrow loop of Wollaston wire. When a current is passed through the wire so as to make it glow, it forms an electroscope of different sensitivity for +ve and -ve charges.—G. D. **West**: A modified theory of the Crookes radiometer. The paper gives a short account of a theory of the Crookes radiometer worked out by Sutherland in 1896, but, unfortunately, much neglected. The theory as it stands will not explain many radiometric phenomena, but it is shown that when modifications depending on the modern knowledge of thermal surface conditions are made, such explanations become possible. Radiometer action, especially at the higher gas pressures, would appear to depend essentially on the formation of gas currents near the radiometer vane. These currents are distinct from convection currents, but are closely associated with the phenomena of thermal transpiration.—A. **Campbell**: The magnetic properties of silicon iron (stalloy) in alternating magnetic fields of low value. Measurements are described of the hysteresis losses in silicon iron sheet and wires in very low alternating magnetic fields at low and telephonic frequencies, using an alternating-current method described in a former paper. The equations giving the hysteresis losses as a function of  $B_{max}$ , are deduced in the case of the sheet material at low frequencies for ranges of  $H_{max}$  from 0.0002 to 0.02. Comparisons are made between sheet material and wires of different diameters, and curves are given showing the great improvement in the permeability of wires when they are annealed. The behaviour of the material is studied, both by ballistic tests and at telephonic frequencies, as regards the alternating field when direct-current fields of various values are applied at the same time.—T. **Smith**: Tracing rays through an optical system. Equations for tracing rays in an axial plane through an optical system have the normal refraction terms separated from those representing aberrations. By expressing the latter as a fraction with the first-order aberration as the numerator and a correcting factor, which may take various forms, as the denominator, rays may be traced exactly through the system, using a short table of cosines in terms of sines in place of the extensive tables, giving sines in terms of angles generally employed. A considerable saving of time is effected in the calculations, and the estimation, without calculation, of the aberrations of other rays is facilitated.

**Geological Society**, May 19.—Mr. R. D. Oldham, president, in the chair.—Dr. H. H. **Thomas**, with chemical analyses by E. G. **Radley**: Certain xenolithic Tertiary minor intrusions in the Island of Mull (Argyllshire). The paper deals with a series of minor intrusions, generally tholeiitic but occasionally composite in character, which are well represented in the western peninsula of Mull, lying between Loch Scridain and Loch Buie, and are remarkable for the number and mineralogical peculiarities of the xenoliths that they contain. Xenoliths of a highly siliceous nature (quartzites, sandstones, etc.) are met with, but more commonly the inclusions are of a type rich in alumina (shales and clays). Cognate xenoliths of noritic and gabbroic affinities occur in several of the intrusions, and these, together with the accidental siliceous xenoliths, are briefly described; but the communication deals more particularly with the aluminous inclusions which are crowded together in most of the intrusions, range up to several feet in diameter, and are characterised by well-crystallised minerals such as sapphire, spinel, sillimanite, cordierite, and anorthite. These xenoliths offer the clearest evidence of the modification of a more or less pure aluminous sediment by permeation of magmatic matter, more particularly by the diffusion of lime, ferrous iron, and magnesia. It is held from the evidence afforded by the xenoliths that the metamorphism is of a deep-seated character, and has been effected by a tholeiitic magma on the walls of its basin, which were composed mainly of aluminous sedimentary rocks.

CAMBRIDGE.

**Philosophical Society**, May 3.—Sir Ernest Rutherford, vice-president, in the chair.—W. J. **Harrison**: Notes on the theory of vibrations. (1) Vibrations of finite amplitude. (2) A theorem due to Routh. Rayleigh determined, in trigonometric form, the approximate effect of small terms varying as the square and cube of the displacement in the equation of simple harmonic motion. In the former of these notes exact Fourier series are determined by the theory of elliptic functions, and tables are computed. The latter note relates to the theorem that an increase of inertia of any part of a vibrating system increases all the periods in such a way that the new periods are separated by the original periods. If the effect of the increased inertia be represented by an addition to the kinetic energy of the square of a linear function of the velocities, it is pointed out that the theorem does not hold unless this linear function involves all the velocities.—W. **Burnside**: On cyclical octosection. The complete solution of the problem of cyclical quartisection was first given by V. A. Le Besgue in *Comptes rendus*, vol. li., 1860, without proof; he forms the quartic equation satisfied by the sum of  $\frac{1}{2}(\beta-1)$  distinct primitive  $\beta$ th roots of unity,  $\beta$  being a prime number of the form  $4n+1$ . If  $\beta=L^2+4M^2$ , where  $L \equiv 1 \pmod{4}$ , the equation involves  $\beta$  and  $L$ , being

$$\{y^2 + \beta[z(-1)^{\frac{\beta-1}{4}} - 1]\}^2 = 4\beta^2 y - L^2,$$

where  $y$  is one more than four times the sum in question. The only proof as yet published appears unnecessarily long. The present paper deals with the case when  $\beta$  is a prime of the form  $8n+1$ ; it forms and solves the equation satisfied by the sum of  $\frac{1}{2}(\beta-1)$  distinct primitive  $\beta$  roots of unity, which is capable of eight values, by a method capable of extended application. Expressing  $\beta$  in both the forms  $a^2+b^2$ ,  $a'^2+zb^2$ , this equation involves  $\beta$ ,  $a$ , and  $a'$ .—Dr. G. F. C. **Searle**: (1) A bifilar method of measuring the rigidity of wires. The upper ends A, C of two equal

wires are attached to two torsion heads, and the lower ends B, D to a bar loaded with a considerable mass. When the wires are free from torsion, they are in a vertical plane. The distances  $AC=2a_1$ ,  $BD=2a_2$ , are nearly equal. If the torsion heads are turned through  $\phi$  from their zeros, the bar will turn through  $\theta$  in the same direction, until the bifilar couple balances the couple due to the torsion of the wires. Then  $\sin \theta = C(\phi - \theta)$ , where C is, for practical purposes, independent of  $\phi$  and  $\theta$ . By observing  $\theta$  and  $\phi$ , C is found. Then, if  $r$  is the mean radius of the wires and M the load supported by them, the rigidity,  $n$ , is given by

$$n = \frac{8a_1 a_2}{\pi r^4} \cdot MC.$$

A damping device is provided so that steady readings can be obtained in a room subject to vibration. Bends in the wires near the upper ends have the same effect as if the points A, C described small horizontal circles. Errors due to this cause are eliminated by a rough harmonic analysis. (2) An experiment on a piece of common string. When a mass M is suspended by a piece of common string from a fixed support, it begins, when set free, to rotate about the axis of the string. The string, therefore, exerts a couple, G, on the body, and the relation of this couple to M is studied in the experiment. If, starting from rest, the body makes  $n$  revolutions in time  $t$ , the angular acceleration  $\alpha$ , assumed constant, is given by  $\frac{1}{2}at^2 = 2\pi n$ . If K is the moment of inertia of the body,  $G = K\alpha$ . If the length of the string is of the order of 2 metres, the angular acceleration is approximately uniform for at least the first 10 or 20 revolutions. The load is supplied in the form of a number of equal inertia bars which can be threaded on a light rod carried by the string. Then K is practically proportional to M. It is found that the time for, say, 10 revolutions from rest is nearly constant. Hence G is nearly proportional to M. (3) Experiments with a plane diffraction grating, using convergent light. A lens forms a real image B of a vertical slit S illuminated by sodium light. A plane diffraction grating, with its rulings vertical, is placed between the lens and B, so that the vertical central plane of the beam, which cuts the grating in O, makes an angle  $\theta$  with the normal to the grating, and  $BO = u$ . If C is one of the "real" diffracted images of order  $p$ , and if CO or  $v$  makes an angle  $\phi$  with the normal, then

$$u \sec \theta = v \sec \phi \dots (1)$$

If the grating interval is  $d$ , the wave-length is given by

$$p\lambda = d(\sin \phi - \sin \theta) \dots (2)$$

In the experiment the relation (1) is tested, and the wave-length is found by (2). The images are received on a glass scale moving along an optical bench, the length of the scale being horizontal and perpendicular to the bench.—Major P. A. **MacMahon**: Congruences with respect to composite moduli. This paper deals with the primitive roots of the binomial congruence the exponent of which is any divisor of the totient of a composite modulus. Numbers being divided into categories according to the number of their different prime divisors, tables of primitive roots are given for the cases of the second and third categories.—A. **Kienast**: Equivalence of different mean values. This is a continuation of a former paper by the author, and deals with the equivalence of conditions for the existence of the limit of the mean sum of a continually increasing number of terms.—Prof. H. F. **Baker**: Construction of the ninth intersection of two cubic curves passing through eight given coplanar points. Let A, B, C, M, N and P, Q, R be the given points; take T external to their plane; let TP, TQ, TR meet a quadric containing

A, B, C and the lines TM, TN, in further points P', Q', R'; let the twisted cubic curve through T, A, P', Q', R' which has BC for chord meet the quadric again in O'; then TO passes through the required ninth point.—W. E. H. **Berwick**: Quintic transformations and singular invariants. This paper deals with the arithmetical solution of a certain sextic equation arising in the theory of modular functions, the coefficients of which are functions of a certain algebraical number. The arithmetical character of the number of fields which arise is determined in detail.

MANCHESTER.

**Literary and Philosophical Society**, May 4.—Mr. William Thomson, vice-president, in the chair.—Major T. **Cherry**: The origin of agriculture. The annual flood-cycle of the Nile provided perfect conditions for the growth of cereals. Since none other of the great rivers on the banks of which civilisation first appeared afforded such natural possibilities for the growth of cereals, it was claimed that man must have learned in Egypt irrigation and the cultivation of cereals. The author, in discussing the origins of wheat and barley, claimed that the originals of our cultivated barley probably evolved in the Nile Valley, and those of our wheat on one of the islands of the Ægean Archipelago.

**Literary and Philosophical Society** (Chemical Section), April 30.—Mr. J. H. Lester, chairman, in the chair.—Dr. J. A. R. **Henderson**: Alchemy and chemistry among the Chinese. The early objects of the alchemists were discussed, and their discoveries in metallurgy, mineralogy, and botany detailed. The latter included the manufacture of pigments, lacquers, porcelain, paper, and the early discovery of the explosive properties of gunpowder. The exploitation of vast coal deposits and of iron and other metallic ores, and the production of oils and medicinal substances, are taking place.

May 12.—Mr. J. H. Lester, chairman, in the chair.—Prof. F. L. **Pyman**: The relation between chemical constitution and physiological action.

DUBLIN.

**Royal Irish Academy**, May 10.—The Most Rev. the Right Hon. J. H. Bernard, president, in the chair.—J. N. **Halbert**: Acarina of the Intertidal Zone. The various forms, several of which are new to science, were studied in their relation to the well-known zones, or belts, of the orange lichen, *Pelvetia*, and *Fucus* usually present, where there is sufficient foothold for them, on the sea-shore. Excluding the families Halacaridæ and Hydrachnidæ, the species are distributed in the four terrestrial families as follows: Gamasidæ 28, Oribatidæ 17, Tvrogllyphidæ 2, and Trombididæ 18.—Miss Jane **Stephens**: The fresh-water sponges of Ireland number only five species. Their habitat, mode of growth, and distribution are discussed. Among the points of interest are the following: It has been found that the sponges do not occur in mountain streams, unless there is a lake, however small, in the course of the stream, and that, on the other hand, they occur most luxuriantly in a stream just below its exit from a lake. One species avoids the limestone areas. The variations of the commoner species are traced at some length. The paper is illustrated by numerous drawings of spicules and by maps showing the distribution of the species.—T. A. **Stephenson**: The genus *Corallimorphus*. *Corallimorphus* is a genus of deep-sea Actiniaria, first described by Moseley in 1870, and later by Hertwig in 1882 and 1888. There are two specimens of *C. rigidus* in the collection of anemones made by the Fisheries Branch

of the Department of Agriculture and Technical Instruction for Ireland from 1890 to 1913. These specimens are described externally and anatomically in the paper, and compared with the eight other specimens described by Moseley and Hertwig. The possibility of all these specimens belonging to one species is suggested and discussed, with the conclusion that it is quite likely that the genus contains one variable species only. On the other hand, further material is required for a final decision, and if the three species, *C. rigidus*, *profundus*, and *obtectus*, should prove valid, the Irish specimens would probably require a fourth species. It is further pointed out that the thick and rigid body of the anemones in question seems to be correlated with deep-sea life, and that although the genus has sometimes been regarded as a primitive one, it has a number of characteristics which it would seem can be considered only as specialisations or advanced features.

## PARIS.

Academy of Sciences, May 25.—M. Henri Deslandres in the chair.—E. Goursat: Some transformations of partial differential equations of the second order.—G. Bigourdan: The instruments and work of the Sainte-Geneviève Observatory. Historical account of the work of Pingré and of Lechevalier done between 1755 and 1836.—J. Bossert: Catalogue of the proper motion of 5671 stars, annotated and published by L. Schulhof.—J. Baillaud: The method of the scale of tints in photographic photometry.—C. Guichard: Congruences belonging to a linear complex such that the lines of curvature correspond on the two focal surfaces.—G. Julia: Families of functions of several variables.—M. Janet: Systems of partial differential equations and systems of algebraic forms.—G. Sagnac: The real relativity of the energy of the elements of radiation and the motion of waves in the æther.—F. Viès: Ultra-violet spectrophotometry of the nitrophenols. Seventeen nitro-derivatives were examined and the spectra found to be, in general, constituted of three elements: a constant band, due to the  $\text{NO}_2$  group; a band related to the presence of the benzene ring; and a third band the origin of which is doubtful.—M. de Broglie: The fine structure of X-ray spectra. Details of a doublet given by rhodium, and comparison with the K spectrum of tungsten.—J. L. Pech: Phenomena of antagonism between various radiations (ultra-violet, visible spectrum, and infrared).—L. Thielemans: Regulation of cables for the transport of electrical energy to long distances.—P. Bunet: The transport of energy to great distances. Remarks on a recent communication by M. Bvrlinski on the same subject.—M. Toporescu: The lime and magnesia carried down by precipitates of ferric oxide. Varying weights of ferric oxide were precipitated in presence of constant quantities of calcium and magnesium salts, and the proportions of lime and magnesia carried down were determined. A second precipitation of the ferric oxide is sufficient to remove calcium salts, but this is not the case with magnesia.—L. Guillet and M. Gasnier: The plating with nickel of aluminium and its alloys. The aluminium or alloy is cleaned and roughened by sand-blasting, and then takes a satisfactory deposit of nickel. The influence of the size of the sand grains and the time elapsed between the sand-blasting and the deposit have been examined, and results are given.—A. C. Vornnazos: A new series of complex combinations: the antimony oxivdides. The mercury compound may be taken as a type of these substances; it has the composition  $\text{Hg}(\text{SbO})_2$ .—R. Cornubert: The constitution of some dialkylcyclohexanones. A study of the ketones obtained by treating cyclohexanone with sodium and then with alkyl halides.—C. Dufraisse:

The stereo-isomeric forms of benzoylphenylacetylene di-iodide. The conditions under which either of the two isomers can be isolated are given.—A. Mailhe: The catalytic hydrogenation of the ketazines.—L. Moret: The tectonic of the eastern bank of Lake Anney.—A. Brives: Some results of a new journey in Morocco. A completion of geological work commenced in 1919.—P. Bonnet: The Permo-Triassic limit in the Himalayan-Armenian geosynclinal.—L. Dunoyer and G. Reboul: The prediction of the weather.—G. Truffaut and H. Bezsonoff: The influence of partial sterilisation on the composition of the microbial flora of the soil.—R. Souèges: The embryogeny of the Solanaceæ. Development of the embryo in *Hyoscyamus* and *Atropa*.—P. Bertrand: The constitution of the vascular system in ferns, in Pteridosperms, and in all ancient Phanerogams.—L. Blaringhem: The stability and fertility of the hybrid *Geum urbanum* x *G. rivale*. From the morphological point of view the descent of this hybrid is uniform and regularly fertile. Its mixed characters are sufficiently distinct from those of its parents to give a precise diagnosis, and as it propagates without variation in the wild state it can be described as a good systematic species.—J. Feytaud: The kings and queens of *Leucotermes lucifugus*.—A. Mayer, A. Guieysse, and E. Fauré-Fremiet: Pulmonary lesions determined by suffocating gases.—A. Trillat and M. Mallein: The projection of micro-organisms into the air. The influence of humidity.

## Books Received.

- Calcutta University Commission, 1917-19. Report. Vol. vi. Appendices and Index. Pp. vii+341+plates. (Calcutta: Superintendent, Government Printing, India.) 1 rupee or 1s. 6d.
- A Monograph of the British Orthoptera. By W. J. Lucas. Pp. xii+264+xxv plates. (London: The Ray Society.) 1l. 5s. net.
- The British Charophyta. By J. Groves and Canon G. R. Bullock-Webster. Vol. i. Nitellæ. Pp. xiv+141+xx plates. (London: The Ray Society.) 1l. 5s. net.
- Ozone. By Prof. E. K. Rideal. Pp. ix+198. (London: Constable and Co., Ltd.) 12s. net.
- Thomas Henry Huxley. By Dr. L. Huxley. Pp. vii+120. (London: Watts and Co.) 3s. 6d. net.
- Auguste Comte. By F. J. Gould. Pp. v+122. (London: Watts and Co.) 3s. 6d. net.
- Is Spiritualism Based on Fraud? By J. McCabe. Pp. vii+160. (London: Watts and Co.) 3s. net.
- The Systematic Treatment of Gonorrhœa in the Male. By N. Lumb. Second edition. Pp. viii+123. (London: H. K. Lewis and Co., Ltd.) 5s. net.
- Optical Projection. By Lewis Wright. Fifth edition. Rewritten and brought up to date by R. S. Wright. In two parts. Part i.: The Projection of Lantern-Slides. Pp. viii+87. (London: Longmans and Co.) 4s. 6d. net.

## Diary of Societies.

THURSDAY, JUNE 10.

- INSTITUTION OF MINING ENGINEERS (at Geological Society), from 11 a.m. to 5.—(General Meeting.)—Prof. H. Louis: Compensation for Subsidence.—W. Maurice: The Fleissner Singing-Safety Lamp.—W. Maurice: The Wolf-Pokorny and Wiede Acetylene Flame-Lamps.—G. Oldham: The "Oldham" Cap Type Miner's Electric Safety-lamp.—Discussion on First Report of the Committee on "The Control of Atmospheric Conditions in Hot and Deep Mines."—D. S. Newey: A New Method of Working Thick Seams of Coal at Baggeridge Colliery.—T. G. Bocking: Protractors.—T. G. Bocking: Magnetic Meridian Observations: A Method of Utilising the Kew Observatory Records.
- ROYAL SOCIETY, at 4.30.—Prof. A. Y. Hill and W. Hartree: The Thermodynamic Properties of Muscle.—Sir James Dobbie and J. F. Fox: The Absorption of Light by Elements in the State of Vapour: (1) Selenium and

Tellurium (2); Mercury, Cadmium, Zinc, Phosphorus, Arsenic, Antimony.—Dr. A. E. H. Tutton: Monoclinic Double Selenates of the Copper Group.—H. G. Cannon: Production and Transmission of an Environmental Effect in *Sinonchophora setacea*.—E. C. Grey: The Enzymes of *E. coli communis* which are concerned in the Decomposition of Glucose and Mannitol. Part IV. The Fermentation of Glucose in the Presence of Formic Acid.—L. T. Hogben: Studies on Synapsis. II. Parallel Conjugation and the Prophase Complex in *Periplaneta*, with Special Reference to the Premiotic Telo- and Pachytene Stages.

LONDON MATHEMATICAL SOCIETY, at 5.—G. E. Taylor: (1) Tidal Oscillations in Gulfs and Rectangular Basins. (2) Diffusion by Continuous Movements.—H. B. C. Darling: Proofs of certain Identities and Congruences enunciated by Mr. S. Ramanujan.—M. J. M. Hill: The Irreducibility of the Solution of an Algebraic Diophantine Equation.—F. B. Piddock: Functions of Limiting Matrices.—W. F. Milne: The Relation between Apolarity and a certain Porism of the Cubic Curve.

ROYAL COLLEGE OF PHYSICIANS OF LONDON, at 5.—Dr. A. F. Hurst: The Psychology of the Special Senses and their Hysterical Disorders (Croonian Lecture).

CRETECE INSTITUTE, at 7.30.—E. L. Joseph: Ventilation and Air-Purification as applied to Modern Concrete Buildings.

OPTICAL SOCIETY, at 7.30.—Miss A. B. Dale: Accuracy of Setting.—Dr. J. S. Anderson: A New Method of Immersion Refractometry.

INSTITUTE OF METALLURGS (at Institution of Mechanical Engineers), at 8.—Prof. G. A. B. Parry: Recent Progress in Thermo-Electricity (Annual May Lecture).

SOCIETY OF ANTIQUARIES, at 8.30.

## FRIDAY, JUNE 11.

INSTITUTION OF MINING ENGINEERS (at Geological Society), from 11 a.m. to 5.

ROYAL ASTRONOMICAL SOCIETY, at 5.—E. E. Barnard: Nova Persei No. 3 (Anderson).—A. S. Eddington: Radiation-pressure in Solar Phenomena.—R. A. Sampson: Geophysical Discussions, 1920 May 7: Determination of Longitude by Wireless Telegraphy.—Gén. Ferris: Note sur les procédés actuels d'emploi de la télégraphie sans fil dans la détermination des Longitudes.—R. A. Fisher: A Mathematical Examination of the Methods of Determining the Accuracy of an Observation by the Mean Error and by the Square Mean Error.—H. S. Plaskett: The Intensity Distribution in the Continuous Spectrum and the Intensity of the Hydrogen Lines in  $\gamma$  Cassiopeiae.—J. Lunt: The Spectra of Nova Aquilæ No. 3. Third Paper.

PHYSICAL SOCIETY OF LONDON, at 5.—Dr. T. Barratt and A. J. Scott: Radiation and Convection from Heated Surfaces.—J. S. G. Thomas: An Electrical Hot-Wire Inclinerometer.—L. F. Richardson: Convective Cooling and the Theory of Dimensions.—J. W. T. Walsh: The Radiation from a Perfectly Diffusing Circular Disc.

MALACOLOGICAL SOCIETY OF LONDON (at Linnean Society), at 6.

MONDAY, JUNE 14.

VICTORIA INSTITUTE (at Central Hall, Westminster), at 4.30.—Very Rev. Dean Inge: Freedom and Discipline (Annual Address).

SOCIETY OF CHEMICAL INDUSTRY (London Section) (at Central House, Finsbury Square), at 5.—(Annual Meeting).

SOCIETY OF ENGINEERS (at Geological Society), Special Summer Meeting, at 5.30.—E. J. Perry: Great Engineering Adventures.

FARADAY SOCIETY (at Chemical Society), at 8.—Dr. A. Fleck and T. Wallace: Conduction of Electricity through Fused Sodium Hydrate.—Dr. H. F. Haworth: The Measurement of Electrolytic Resistance using Alternating Currents.—J. L. Haughton: The Measurement of the Electrical Conductivity in Metals and Alloys at High Temperatures.—N. W. S. Knibbs and H. Palfreeman: The Theory of Electrochemical Chlorate and Perchlorate Formation.—J. B. Firth: The Sorption of Iodine by Carbon.—F. H. Jeffery: The Electrolysis of Solutions of Sodium Nitrate using a Copper Anode.—Dr. R. M. Williams: The Pressure Variation of the Equilibrium Constant in Dilute Solution.—Miss Nina Hosali: Description of Models illustrating Crystalline Form and Symmetry.

## TUESDAY, JUNE 15.

ROYAL HORTICULTURAL SOCIETY, at 3.—Dr. A. B. Rendle: Plants of Interest in the Day's Exhibition.

ROYAL COLLEGE OF PHYSICIANS OF LONDON, at 5.—Dr. A. F. Hurst: The Psychology of the Special Senses and their Hysterical Disorders (Croonian Lecture).

ROYAL STATISTICAL SOCIETY, at 5.15.—G. F. Shirras: Some Effects of the War on Gold and Silver.

MINEOLOGICAL SOCIETY (at Geological Society), at 5.30.—W. A. Richardson: The Fibrous Gypsum of Nottinghamshire.—F. P. Mennell: Rare Zinc-Copper Minerals from the Rhodesian Broken Hill Mine, Northern Rhodesia.—Prof. R. Ohashi: The Plumbeiferous Barytes from Shikokuro, Prefecture of Akita, Japan.—W. A. Richardson: A New Model Rotating Stage Petrological Microscope.

ZOOLOGICAL SOCIETY OF LONDON, at 5.30.—Dr. P. Chalmers Mitchell: Report on the Additions to the Society's Menagerie during the Month of May, 1920.—Prof. J. E. Duerden: Exhibition of, and Remarks on, Ostrich Eggs.—Mrs. Joseph B. Procter: (1) A Collection of Tailless Batsrachians from East Africa made by Mr. A. Loveridge in the Years 1914-16. (2) The Type-specimen of *Ka-a holsti*, Bouenger.—R. I. Pocock: The External and Cranial Characters of the European Badger (Meles) and the Amer. Can. Badger (Taxidea).—Dr. K. J. Tillyard: The Life-history of the Dragonfly.

ROYAL ANTHROPOLOGICAL INSTITUTE, at 8.15.—Prof. F. G. Parsons: Distribution of Hair and Eye Colour in the British Isles.

## WEDNESDAY, JUNE 16.

ROYAL METEOROLOGICAL SOCIETY (at the Royal Astronomical Society), at 5.—W. H. Dines: The Ether Differential Radiometer.—Prof. S. Chapman and E. A. Bagnall: The Composition, Ionisation, and Viscosity of the Atmosphere at Great Heights.

INSTITUTION OF ELECTRICAL ENGINEERS (at Institution of Mechanical Engineers), at 6.—Discussion on paper read by Sir Dugald Clerk before the Royal Society of Arts, entitled Distribution of Heat, Light, and Motive Power in Gas and Electricity.—Sir Dugald Clerk, Prof. A. Smithells, and Prof. J. W. Cobb: The Report on the Coal-Gas and Electrical Supply Industries of the United Kingdom to the President of the Institution of Gas Engineers.

ROYAL MICROSCOPICAL SOCIETY, at 8.—Sir Horace Darwin and W. G. Collins: A Universal Microtome.—L. Hogben: The Problem of Synapsis.

## THURSDAY, JUNE 17.

ROYAL SOCIETY, at 4.30.—Prof. W. Bateson: Genetic Segregation (Croonian Lecture).

LINNEAN SOCIETY, at 5.—Celebration of the Centenary of Sir Joseph Banks, Bart. (1743-1820).—Dr. E. Daydon Jackson: Banks as a Traveller.—Dr. A. B. Rendle: Banks as a Patron of Science.—J. Britten: Banks as a Botanist.

ROYAL COLLEGE OF PHYSICIANS OF LONDON, at 5.—Dr. A. F. Hurst: The Psychology of the Special Senses and their Hysterical Disorders (Croonian Lecture).

CHEMICAL SOCIETY (at Institution of Mechanical Engineers), at 8.—Prof. J. C. McLennan: Helium.

## FRIDAY, JUNE 18.

ROYAL SOCIETY OF ARTS (Indian Section), at 4.30.—Sir Valentine Chirol: The Enduring Power of Hinduism (Sir George Birdwood Memorial Lecture).

GEOGRAPHICAL COMMITTEE (at Royal Astronomical Society), at 5.—Commander H. D. Warburg, Prof. H. Lamb, Dr. J. Proudman, Prof. A. F. Dodson, Major A. J. Wolff, and H. L. P. Polly: Discussion on Tides.

## SATURDAY, JUNE 19.

BRITISH PSYCHOLOGICAL SOCIETY (at University College, Gower Street), at 3.30.—Dr. J. Dreyer: The Emotional Phases of Affective Experience.

PHYSIOLOGICAL SOCIETY (at Physiological Laboratory, University of London, South Kensington), at 4.30.—G. Aurep and C. Lovatt Evans: The Mode of Action of Vasodilator Nerves.—C. Lovatt Evans: The Lactic Acid Content of Plain Muscle.

## CONTENTS.

	PAGE
Naval Education	445
The Ultimate Data of Physics. By Prof. G. Dawes Hicks	446
Life and Letters of Silvanus P. Thompson. By A. A. Campbell Swinton, F.R.S.	448
Academic Research and Industrial Application. By G. T. M.	449
Ancestral Studies of Compositæ	450
Our Bookshelf	450
Letters to the Editor:—	
The Organisation of Scientific Work in India.—Sir Thomas H. Holland, K.C.I.E., F.R.S.	452
Anti-Gas Fans.—Prof. A. J. Allmand	453
Attainment of High Levels in the Atmosphere.—W. H. Dines, F.R.S.	454
Central Wireless Station for Astronomy.—Major William J. S. Lockyer	454
The "Flight" of Flying-fish.—Prof. W. N. F. Woodland; Sir David Wilson-Barker	455
Fellow-Workers.—Sir Ronald Ross, K.C.B., F.R.S.	455
The Approximate Evaluation of Definite Integrals between Finite Limits.—A. F. Dufton	455
The Cost of Laboratory Fittings.—Alan E. Munby	456
The First Act of a Young Thrush.—Honour M. M. Perrycoste	456
Marat and the Deflection of Light.—Prof. W. A. Osborne	456
British and Metric Systems of Weights and Measures.—Alfred S. E. Ackermann	456
Aircraft Photography in the Service of Science. (Illustrated.) By H. Hamshaw Thomas	457
The Dynamics of Shell Flight. (With Diagrams.) By R. H. Fowler	459
Obituary:—	
Prof. L. Doncaster, F.R.S. By Prof. W. Bateson, F.R.S.	461
Notes	462
Our Astronomical Column:—	
Photographs of the Broseen-Metcalf Comet	467
The Planetary Families of Comets	467
The Thunderstorms of May 29 and the Louth Disaster	468
Annual Meeting of the British Science Guild	468
Annual Visitation of the Royal Observatory, Greenwich	469
Applied Statistics. By D. H.	470
The Imperial College: Claim to University Status	471
The Smoke Nuisance. By J. B. C.	471
The Molecular Energy in Gases	472
University and Educational Intelligence	472
Societies and Academies	473
Books Received	475
Diary of Societies	475



THURSDAY, JUNE 17, 1920.

*Editorial and Publishing Offices:*MACMILLAN & CO., LTD.,  
ST. MARTIN'S STREET, LONDON, W.C.2Advertisements and business letters should be  
addressed to the Publishers.

Editorial communications to the Editor.

Telegraphic Address: PHUSIS, LONDON.  
Telephone Number: GERRARD 8830.**University Stipends and Pensions.**

NO one disputes that "there is no organised intellectual unit higher or more comprehensive than a University," and few, on reflection, would differ from Sir John Seeley in affirming that the education in England is what the Universities choose to make it. Not only are the Universities and institutions of University rank the highest product of our educational system, but they also have the power of influencing the trend of thought and ideals in education to an incalculable degree. To a large extent, therefore, the advance to a higher plane of civilisation is dependent upon their free and untrammelled development. In pursuit of truth, whether in philosophy, or science, or technology, independent of material considerations, they are pioneers of research, blazing the trail for industry, commerce, and those human efforts which add to the sum of life's happiness. Anything which acts as an impediment or hindrance to this development cannot be viewed simply as an injury to the institutions themselves; it is an injury to the community, to the nation, and to civilisation. If this be true, one or two facts of capital importance require to be considered in the light of a few principles. For the moment, however, let us examine the broad relations of the State to the University.

The State can no more dispense with the co-operation of the Universities than the Universities with the co-operation and assistance of the State. Their interests are mutual and their services reciprocal. The influence of the University ramifies through the whole of the administration of the country, its great Departments of State and its two legislative Houses, its local governing bodies and its courts of justice. Obviously the State cannot afford to see the Universities or the University colleges wilt under economic pressure. Now this is precisely what will happen if it does not take a clearer view of its responsibilities and their

logical implications. The University grant, demonstrably insufficient in pre-war times, is absurdly inadequate now. Not merely have money values changed to an extraordinary extent, but the demands upon the Universities in regard to accommodation, equipment, and facilities for research have increased to an almost equal degree. If to these be added the necessary adjustments in salaries of the staffs, the inadequacy is still more apparent.

The State will have to recognise these facts and, if for no other reason than that of enlightened self-interest, to assume heavier financial responsibilities. As matters stand at present, those borne by the State are altogether disproportionate to the services rendered by the Universities to the nation. In consequence, the statement is as true to-day as it was when made ten years ago that our newer Universities are "a composite figure in which progress and poverty are the prevailing hues." But such increased financial responsibility should not absolve the State from preserving in its traditional integrity that freedom which is the life-blood of an institution coeval in origin with Parliament itself. It is platitudinous to say that no one wishes to see the Universities, new or old, in any sort of intellectual subjection. Unfortunately, however, intellectual subjection is too often the outcome of material subjection. A wise State will show its wisdom in preserving in all its integrity that from which it derives, indirectly though it be, its vital energy, and through which it renews its spiritual life from generation to generation.

On broad and general grounds we have argued that the State has responsibilities to the institutions of higher learning of which it cannot divest itself, and that these responsibilities are such as can be fulfilled only by much more generous financial support than is given at present. It is necessary, therefore, to indicate how seriously these institutions are affected by the lack of this support. The question of stipends and pensions alone will be considered. Too often a university is conceived in terms of stone and mortar; essentially, however, it is a corporation, a society of human beings, a body of teachers and students. To say that an efficient and highly qualified staff is fundamental is simply to express a truism. Such a staff is the product of many years of patient and unremitting study. If by any mischance or lack of vision the flow of able and gifted students to this higher teaching is checked, the loss will be irreparable. That such a result

is not a remote possibility is becoming sufficiently obvious to those who are watching the present trend of University affairs. A teacher does not enter on his career in the hope of amassing riches. With such an ambition the teaching profession is among the last to which he would resort. Debarred from the financial prizes possible to a business career, he has the right to expect emoluments which will enable him to live decently and to move in a social circle to which his education and training entitle him. This is especially true of the University teacher.

Now, as a matter of fact, the stipends of University teachers in this country at the present time, particularly in the non-professorial staff, do not conform to this standard, but fall miserably short of it. A large proportion of assistant lecturers and demonstrators, full-time teachers, receive no more, and some much less, than 250*l.* a year—a salary or wage which, under present conditions, would be accepted by no self-respecting mason or miner. The grade of lecturer, comprising as it does a great number of men and women who can never hope to attain professorial rank, however well qualified for it by ability and experience, fares little better. The average salary of this class ranks somewhere near 400*l.* a year, and one may take it that the pre-war value of this sum is approximately equal to 200*l.* a year. If the average rate of remuneration of such posts remains at these figures, it requires no gift of prophecy to predict that the flow of talent to the teaching staffs of the Universities and University colleges will inevitably be checked.

The question of the remuneration of the non-professorial element is most important. The numbers are great, the aggregate hardships intolerable. But the stipends of professors as a whole also show little relation to the emoluments in corresponding positions outside the University. A large number of professors receive less than 800*l.* a year, and considerably more than 80 per cent. less than the professorial salary indicated by the Association of University Teachers as a minimum—viz. 1100*l.* a year. Obviously, again, the gift of prophecy need not be conjured up to predict the result. Already the professorial ranks have been, and are being, depleted by the superior inducements offered in industrial, scientific, and commercial business organisations. It is futile to argue that public benefactions should make good these pressing needs. One cannot dragoon public benefactions. It is too much to expect the local authorities and the students to make good the

deficiencies. Generally speaking, both contribute reasonable proportions. The matter is a State affair, and the State must implement to the full its responsibilities.

The present position regarding superannuation is very unsatisfactory. As a general principle, it may be laid down that anything which restricts the field from which the University recruits its staff is inimical to University interests, and hence, in the long run, to education in general. Now the effect of the School Teachers (Superannuation) Act, 1918, is to restrict this field. Any school teacher eligible for its benefits cannot accept an appointment in a University without sacrificing pension rights, in whole or in part. Thus it interposes a barrier—in some cases insurmountable—between the University on one hand, and the technical colleges, the training colleges outside the University, and the schools on the other. The free transfer of teachers to the University is hampered. Already cases are on record of candidates refusing University appointments on finding that acceptance would entail a loss of pension benefits accruing from the Act. It would be most unfortunate if service in schools—a most useful experience for a future University teacher—is to be a bar to later service in the University.

Another effect of the Act is to draw an invidious distinction between existing University teachers and other teachers. Ninety-five per cent. of the whole teaching profession are now eligible for pension benefits incomparably superior to any previous teachers' scheme; while 5 per cent., the University teachers, are excluded, and excluded without any compensation. The position is illogical, unjustifiable, and detrimental to education. One or two illustrations will make this clear. In the University of London some schools of the University come within the provisions of the Act; the rest do not. Thus transfers from one school to another within the same University are made difficult or even impossible. The principal of the Government School of Art attached to a certain University college is said to be the only principal of such a school who is not qualified under the Act—this solely because his school forms part of the University college. In other districts neighbouring institutions engaged in the training of teachers are distinguished from one another in the matter of superannuation, because one forms a department of a University and the other does not. This is in spite of the fact that the two institutions are doing the same kind of work, for the same purpose, under the same authority (the

Board of Education), and that their students do their teaching practice in the same kind of schools under the same local education authority. These facts would be highly diverting were their consequences not so serious.

This anomalous state of affairs has provoked much criticism in University circles. What complicates matters is the fact that there exists a contributory pension scheme in the Universities—the federated superannuation scheme—which is thought by some to be superior to the Teachers Act in certain respects, such as in cases of death during service and of retirement before the age of sixty, and in the form of benefit on retiral. As against these the Teachers Act is non-contributory, it is retrospective, and its benefits are calculated upon the average salary in the last five years of service. The whole question has been considered by a conference of representatives from the Universities of England and Wales, at which it was unanimously resolved to lay the case before the Chancellor of the Exchequer in terms of the following resolutions:—

"(1) That this Conference is of opinion that the interests of English and Welsh education as a whole demand the institution of a scheme of superannuation for University teachers and administrative officials conferring benefits not inferior to those granted under the School Teachers (Superannuation) Act, 1918, and of a like retrospective character; (2) that such a scheme should make due provision (a) for the superannuation of persons who enter the service of a University or University college so late in life as to be unable to acquire the service qualification necessary under the School Teachers Act; (b) for meeting the case of persons who retire before the normal age of retirement; and (c) for meeting the case of persons who die on service. (3) That any scheme of superannuation for University teachers and administrative officials should be of such a nature as to allow (without loss in respect of superannuation) the transfer of a person employed at a University or University college to another approved educational or scientific institution in Great Britain or *vice versa*."

The term "institution," of course, includes schools. These resolutions have been accepted by the Association of University Teachers. Whatever be the result, it is a great step forward to have secured unanimity on essentials. The resolutions have clearly demonstrated the present absolute inadequacy of the federated superannuation system and the difficulty of patching up its deficiencies as regards retrospective benefits, interchangeability of teachers, and the amount of retiral allowances or annuities.

## Aerography.

*The Principles of Aërography.* By Prof. A. McAdie. Pp. xii+318. (London: G. G. Harrap and Co., Ltd., 1917.) Price 21s. net.

FROM time to time it has been a subject of remark by the learned that a book on meteorology has to be a collection of essays, because the available material does not lend itself to exposition in a connected treatise. The substitution of the new name aerography for the older meteorology has not changed the leopard's spots. Indeed, Prof. McAdie has made the peculiarities of the subject more remarkable by presenting a work which is partly a collection of meteorological essays, and partly the note-book of a physicist interested in the study of the atmosphere.

Out of eighteen chapters, the first four are a recitation of the physical meteorologist's "credo," which includes absolute units as a theme with variations, preceded by a brief history. There follow nine chapters, which are partly note-book and partly essay; then the essay gradually extends its claim in chapters on atmospheric electricity, precipitation, floods, and notable storms, until it fully asserts itself in a chapter on frosts. Finally, a couple of pages of solar influences lead us to an appendix of conversion-tables and an excellent index.

It is the characteristic of the note-book which will appeal most to the reader. We find a summary of references to the results of modern aerological research which are frequently wanted and not elsewhere at hand. Very useful information about investigations with kites, pilot balloons, and sounding balloons is put in an attractive form. It includes, on p. 19, a table of extreme elevations reached by various means, and much other information of like character. The whole is well illustrated by photographs, maps, and diagrams. It is rather discursive. It begins with the troposphere and stratosphere; winds follow the "major circulation" and the "minor circulation." Ocean currents get a "look in" with the major circulation.

The "credo" is interesting; it shows how careful one has to be in choosing words to express one's meaning. The student has to think when he reads: "The gas constant for the air is not constant. It varies . . . owing to the non-adiabatic character of the atmosphere." "It should be remembered that a gram of ice is by weight a little more than a cubic centimetre, and if pure ice is used only 73 calories are needed" (for liquefaction). Very little unorthodoxy is

allowed to escape through the meshes of the author's critical net, but he is apparently not concerned with the prevalent yet distracting use of the word "gradient" to mean rate of loss per unit length either in the vertical or horizontal direction when speaking of temperature. In this country we are becoming accustomed to confine the word "gradient" to what is commonly understood when it is used with pressure, and to use "lapse" for vertical changes, which are normally losses, with increasing height.

As readers of NATURE already know, it is part of Prof. McAdie's "credo" that pressure should be expressed in "kilobars," which are now commonly known as "millibars," and that temperature should be expressed in new absolute units of which 1000 go to 273 degrees of the Centigrade scale. In the reviewer's experience of units the whole world is divided into three very unequal parts. By far the largest part is made up of persons who think that absolute units for practical concerns are obviously impossible because the man in the street does not "understand" them at all; the next largest of those who think that absolute units in practice are quite unnecessary because any competent man of science fully understands them and can make the transition whenever he requires them; and the third is a small body of persons who are devoted to their use because the scientific future of meteorology lies that way. To change once more the already changed in order to remove an apparent historical inconsistency conveys no promise of ranging the well-informed minority on the side of progressive action, but would hand us over helpless to the judgment of the great majority who do not "understand," and who are obsessed with the idea that scientific results are nought if they cannot be used without thinking.

Among the excellent illustrations of the book are some photographs of cloud-forms. Its author is very insistent that Luke Howard's classification of cloud-forms on the basis of appearance, as extended by the international conferences, is wrong in principle. He thinks they should be classified according to origin. Unfortunately, the appearance is all that an observer can record, and to ask the ordinary observer to differentiate between similar appearances according to some general instruction as to origin would add materially to the difficulties of the student. What is most wanted is some effective means for the individual observer to ascertain the height of the cloud which he sees. Some simple form of range-finder for clouds suitable for the chief observatories ought not to be beyond the limit of possibility.

The book comes from Blue Hill Observatory, now a part of Harvard University, and contains NO. 2642, VOL. 105]

much incidental information as to the great services which that establishment has rendered to meteorology. Its many friends and admirers in this country will welcome the attempt of its present chief to set out the leading principles of aerography which the observatory has done so much to elucidate. \*

### Paper-making and its Machinery.

*Paper-making and its Machinery: Including Chapters on the Tub-sizing of Paper, the Coating and Finishing of Art Paper, and the Coating of Photographic Paper.* By T. W. Chalmers. (The Engineer Series.) Pp. xi + 178 + vi plates. (London: Constable and Co., Ltd., 1920.) Price 26s. net.

THE author in his preface has rightly stated that the chemist interested in paper-making finds ample technical literature at his disposal, whereas the engineer is not provided with any books dealing with the peculiar mechanical problems of his industry. Since the publication of Hofmann's treatise on "The Manufacture of Paper" in 1873 no serious attempt has been made to supply the paper-maker with an intelligent and comprehensive text-book devoted to a study of the economic and efficient control of the machinery peculiar to the manufacture of paper.

Mr. Chalmers's effort in this direction, admirable as it is, regarded in its proper aspect as a pioneer to some such technical treatise, falls far short of our expectations in this direction. It is doubtful whether a really practical and useful text-book on the engineering problems of the paper industry will ever be written. The utility of the book we have in mind will depend on a free and frank *exposé*, by an engineer thoroughly acquainted with the art and practice of paper-making, of conditions, methods, economics, power costs, capacities, output, means for overcoming difficulties, and the hundred "wrinkles" born of long apprenticeship. The description of paper-machines and subsidiary appliances, essential as it certainly is, constitutes only one part, and that the minor part, of an ideal manual.

The causes which have contributed to this lack of information may be traced to the somewhat natural reluctance on the part of a practical engineer to "give away" his knowledge. Every engineer fondly believes he has a monopoly of this kind, and the difficulty of shaking him from such an idea may fully account for the absence of a text-book which would be gladly welcomed by the trade. We may therefore reasonably hope that the present work will inspire some paper-maker to write a supplement.

Mr. Chalmers has done good service in showing that the processes involved are so many as to justify the issue of a book giving detailed descriptions of the special machinery.

After a brief introductory chapter dealing with sundry historical facts the author proceeds to classify the machinery and apparatus under the several processes of manufacture, beginning with rag-choppers and dusters, as required for cleaning material preparatory to chemical treatment. The well-known types of cutters and dusters are clearly illustrated.

The section devoted to the boiling of fibrous material is incomplete owing to the omission of multiple-effect evaporators, the rotary incinerator furnace, causticising pans, and the plant necessary for the recovery and causticising of spent liquors. This is to be regretted.

The processes for washing, breaking, and bleaching the boiled materials are next described, being accompanied by drawings of machinery in common use. Masson and Scott's bleaching-tower system is shown as dependent for its efficiency on the continual circulation of bleached stock. Experience has proved that intermittent circulation gives good results with economy in power. Plant used for pulping is well represented by the Kollergang and various kneading machines.

The important and difficult subject of beating is fairly handled, the temptation to describe "freak" beating engines being avoided. The merits of beaters with separate circulating devices are discussed, and the special functions of refiners clearly described. The value of this section of the book would have been greatly enhanced by the inclusion of precise details as to power consumption, capacity, output, and costs of maintenance. The author appears to have confined his attention to the description and illustrations of the machinery.

Chaps. vii. to xi. are devoted to the production of an endless sheet of paper, and give an excellent account of the Fourdrinier machine used for this purpose. The illustrations are mainly produced from the machine in operation at the *Daily Telegraph* paper-mills, Dartford.

The wear-and-tear of the machine wire is amply shown by the statement that the load on a 100-in. machine wire may be  $1\frac{1}{2}$  tons, due to the vacuum at the suction-boxes. No reference is made to the much-advertised suction-roll which came into prominence some years ago.

The importance of a stuff-catcher, or economiser, for saving the fine fibres and loading in the backwater is referred to, and Füllner's save-all stands as the typical machine for the purpose. This appliance is now almost entirely superseded

by the vat-mould type of save-all with large, hollow cylinder and endless felt.

The many designs of pulp-strainers are fully illustrated, from the original flat type of early days to the circular, oscillating forms of modern times. The finishing processes of paper-making are illustrated by tub-sizing machines, calenders, and cutters.

Chap. xiv. is devoted to a description of wood-pulp and its manufacture, necessarily brief because very little wood-pulp is made in this country. Only one or two mills are seriously occupied with its manufacture.

The two most interesting chapters in the book are those dealing with "The Coating of Art Paper" and "The Coating of Photographic Paper." The author is probably correct, so far as our memory serves us, in saying that the information given in this connection is in many respects quite new, and much fuller than any previously published.

A full description of a plant for coating art paper, manufactured by Messrs. Mather and Platt, Ltd., is illustrated with excellent drawings and diagrams. It is, of course, well known to our readers that the paper when coated is formed up into long loops, or festoons, which are carried along on endless chains, being gradually dried by warm air. A long room is used for the purpose. In some cases the trackway has to be made longer by bending, so that the festoons can be carried to and fro in a short room. This is effected by the use of "bends" in the trackway, and a complete lay-out of an installation of this kind made by Messrs. Masson, Scott, and Co. is given in the text.

We should not be surprised if many readers interested in paper-making were to obtain a copy of this book on account of the last sections, devoted to the coating of photographic paper. The author rightly emphasises the absolute importance of the body paper, its cleanliness and freedom from iron and metallic particles. The use of baryta, or barium sulphate, is described, and also the special machinery for imparting the sensitised emulsion.

Taking the book as a whole, we are glad to recommend it to those associated with the paper industry. The average engineer of experience may not find much with which he is not already familiar, but to a large class of readers a book of this type must be welcome. It is copiously illustrated by drawings and diagrams, most of which have been supplied or lent by two Scottish engineering firms who understand the value of being obliging and courteous.

R. W. SINDALL.

### The Structure of the Nucleus.

*Cytology: With Special Reference to the Metazoan Nucleus.* By Prof. W. E. Agar. Pp. xii + 224. (London: Macmillan and Co., Ltd., 1920.) Price 12s. net.

CYTOLOGY as a science is of relatively recent growth, and its development was made possible only by improvements in the microscope. Yet the study of the details of cell structure and activity is now fundamental to almost every phase of biology. Nevertheless, biologists are too frequently content with a superficial or second-hand acquaintance with this fascinating field.

Previous to 1900 the process of mitosis had been investigated, the general constancy of the chromosomes from one cell generation to another was recognised, and their relations to fertilisation and reduction were understood in a general way, through the studies particularly of Strasburger and Hertwig: the foundations of the present cytology were laid. Synapsis had been recognised by Moore as a unique phase of the nucleus, and this led to a decade of active research by Farmer, Moore, Wilson, Strasburger, Grégoire, and a host of other plant and animal cytologists to elucidate the intricate course of events during the meiotic or reduction period.

But it is during the present century that improvements in method and increasing accuracy of observation have made possible the remarkable series of discoveries which have led to the present outlook on cytological problems. Particularly noteworthy has been the intimate linking up of the chromosomes with the problems of heredity, sex, mutation, and morphogenesis. This era of work began with the discovery of Montgomery in 1901 that the chromosomes in the nuclei of certain animals were in pairs, the members of which are respectively of maternal and paternal origin. Sutton in 1903 clearly established this relationship in an insect in which the chromosomes were of different sizes, and it is now a commonplace of observation in a large number of animals and plants. Several writers had already, shortly before the Mendelian phenomena became known, pointed out the theoretical possibilities for heredity which lie in the reduction division where the pairs of chromosomes are separated to enter different germ-cells. In the following two decades of research, the chain of evidence connecting the chromosomes with heredity and also with variation has drawn ever closer, until now the relationship must be regarded as definitely established.

One of the earlier stages in this proof was the discovery of the sex chromosomes in insects and

afterwards in other animals. The initial suggestion of McClung, linking a particular chromosome with sex, was followed by notable discoveries by Wilson, Morgan, Doncaster, and a host of other investigators. Then a constant relationship between chromosome numbers and external characters was shown in the case of the *Enothera* mutations; and still more recently the work of Morgan and Bridges on the non-disjunction of chromosomes and its relation to inheritance in *Drosophila*, combined with an enormous contemporary accumulation of collateral evidence of many kinds, has added the final link in the chain of evidence.

Recent work tends more and more not only to analyse the chromosomes themselves into their visible microscopic elements, but also to show the relationships which these bear to the hereditary Mendelian units. The chromatin morphology in related species is also being compared, and even chromosome phylogeny is no longer a visionary hypothesis.

All these and other recent developments in the field of cytology are admirably set forth in the work before us by Prof. Agar, who has thereby placed all biologists in his debt. The book will be chiefly useful to cytologists as a summary of the facts and the literature connected with a particular field—the nucleus in animals above the Protozoa. Within this purview are discussed many of the problems connected with nuclear structure. The author deals with mitosis and meiosis, syngamy and parthenogenesis, with a detailed discussion of these phenomena in various animal forms. He points out that the fundamental fact of meiosis is the segregation of the members of each pair of homologous chromosomes, and compares the parasynaptic and telosynaptic methods of meiotic pairing. We cannot agree with him that the telosynaptic method has been definitely disposed of, as it is still the best authenticated account in a number of plants and animals. Nor can we find any difficulty in the belief that both methods may exist in different organisms, a view first expressed ten years ago.

The account of meiosis in parthenogenetic eggs is welcome, but the discussion of the germ track in animals might have included a greater variety of forms.

The later chapters give a useful account of the sex chromosomes, theories of chromosome individuality and structure, and variations in chromosome number. An interesting chapter on heredity and morphogenesis considers the chromosome behaviour and sterility in hybrids, the cytological basis of mutation, and general questions

relating to the rôle of the nucleus and the chromosomes in development. Another section gives a short account of the chondriosomes, while the final chapter is concerned with the nucleus in the Protista and the nuclear relationships in plants.

The book is well illustrated and excellently produced. While it can scarcely appeal to a wide circle of readers, it will be of great service to all those who wish to be informed concerning the results arising out of the work of the last twenty years on this subject. The cytologist will find it indispensable for reference, and biologists generally will turn to it for the more recent work relating to these problems. R. R. G.

### Our Bookshelf.

*Aircraft in Peace and the Law.* By Dr. J. M. Spaight. Pp. viii+233. (London: Macmillan and Co., Ltd., 1919.) Price 8s. 6d. net.

THIS is a useful attempt to put before the public the main issues of international law relating to the air. In every new development of modern invention, law-making authorities are faced with the difficult task of applying old principles to developments not contemplated when those principles were formulated, and with such a revolutionary departure as the modern aircraft there is a grave risk of deception by a false analogy. The British method has been to apply as far as possible the principles of the Merchant Shipping Acts to aircraft. The idea is lacking in boldness and imagination, for there is little parallel between the two forms of navigation in relation either to the problems of the navigators themselves, or to the rights and liabilities of the public at large. Generally speaking, however, a wise caution has been exercised by those who framed the International Convention. From another point of view the fundamental issue in aerial navigation is the sovereignty of the air, and on this England reserved her opinion. Continental Powers, without exception, clearly realising the serious military problems before them if all comers were allowed unrestricted flight above their territories, maintained in full their dominion in the air above their lands and territorial waters. England, on the other hand, had a different problem to face. No aerial highway of any importance crosses her frontiers in any part of the world, but nearly all the aerial routes which link up her scattered dominions do almost invariably cross the territories of other nations; she ought, therefore, her aerial experts maintained, to hold out for free flight.

It would seem that this view exaggerated the difficulties put in the way of innocent traffic by the maintenance of sovereignty, and minimised the dangers of sudden invasion. We must not forget that the economic interests of Great Britain are just as dependent on military security as they

are on theoretical freedom of transport, and therefore Dr. Spaight would seem to be quite correct in urging the maintenance of the doctrine of the sovereignty of the air. Popular panic is a disaster only less serious than actual assault. The book is well arranged and indexed, while the writer's comments on what is as yet almost an untested department of law of exceptional difficulty, are acute, unprejudiced, and well-informed. W. B. F.

*Wireless Telegraphy and Telephony: First Principles, Present Practice, and Testing.* By H. M. Dowsett. Pp. xxxi+331. (London: The Wireless Press, Ltd., 1920.) Price 9s.

THE object of this work is to provide a connecting link between the various elementary textbooks, intended for those taking up the study of wireless telegraphy, and advanced treatises dealing with particular aspects or branches of the subject. It does not aim at completeness, but usefully develops certain parts of the theory and practice involved. The author insists upon an adequate appreciation of the structure of the atom and the part played by its constituents for a clear understanding of the phenomena met with in wireless working, and puts forward conceptions which, if not presenting a perfectly true scale model of the atom, at any rate are helpful in fixing the ideas. Another theoretical chapter leads up to explanations of some of the methods used in spark and continuous-wave transmission; and perhaps the most important sections of the book deal with the thermo-ionic valve and the modern methods of its employment for both reception and transmission, upon which so much of the recent advances depends. Other developments dealt with are high-speed automatic transmission and direction finding. A considerable portion of the book is devoted to systems of measurement of electrical quantities adapted to wireless telegraph testing. The author concerns himself only with up-to-date methods, and historical matter does not form part of his scheme.

*Chimica delle Sostanze Esplosive.* By Prof. Michele Giua. Pp. xvi+557. (Milano: Ulrico Hoepli, 1919.) Price 28 lire.

THIS treatise is written from the point of view of the laboratory chemist, and contains a very full account of the chemistry of explosive compounds. The author bases his work on that of Berthelot, and develops the theoretical treatment of explosive reactions on thermochemical lines. When dealing with the propagation of explosions through gases, the work of British investigators is practically unnoticed, and although a few references to papers do indeed appear in a table, they are omitted from the index. The treatment of this part of the subject thus appears to be rather superficial. The explosive compounds are described fully, and brief, but clear, accounts are given of the plant used in their manufacture. This section, with its numerous references to the litera-

ture, should prove of value to the organic chemist, but there is little attempt to compare the relative advantages of the compounds so described as constituents of technical explosives, and a comprehensive review of the whole subject is lacking. A later section contains the compositions of a large number of explosive mixtures, drawn mainly from the patent literature. It may be noted that, whilst many complex mixtures containing ammonium nitrate as their principal constituent are cited, there is no mention of the simple amatol mixtures which were so extensively employed during the war. The closing chapter describes the usual methods of testing explosives, and of performing the analysis of the raw materials and finished products. The illustrations include numerous photomicrographs of crystalline compounds, nitrated fibres, and prepared mixtures.

C. H. D.

*Lad: A Dog.* By Albert Payson Terhune. Pp. 309. (London and Toronto: J. M. Dent and Sons, Ltd., 1920.) Price 6s. net.

Those who like dogs will find this tribute very interesting, and will, we think, be able to confirm much of it from personal experience. Those who begin the book with a prejudice in the other direction are, we think, likely to change their position. The story is told enthusiastically, but there is no nonsense about it, and the anthropomorphism is restrained. Some comparative psychologists of the severer sort have said that the fatal thing is a personal interest in the creature observed, and the danger of mingling emotion with inference, and inference with observation, is well known. We might admit this, and yet hold that comparative psychology is likely to be advanced by intimate studies such as Mr. Terhune has given us of "Lad." There may be glimpses of reality to be got in this way which the analytic method does not reveal. In any case, the author has told, in a very delightful way, the story of a charming companion endowed with considerable complexity of character which nurture enhanced. For "Lad" was a "real" dog, and the chief happenings in nearly all the stories about him are "absolutely true." He lived out a full span of sixteen years, and his epitaph reads "Thoroughbred in Body and Soul."

*A Theory of the Mechanism of Survival: The Fourth Dimension and its Applications.* By W. Whately Smith. Pp. xi+196. (London: Kegan Paul, Trench, Trubner, and Co., Ltd.; New York: E. P. Dutton and Co., 1920.) Price 5s. net.

THERE is nothing striking or new in this argument, neither is there anything extravagant in its application. The author expounds in a clear and easy manner the familiar notions of flatland and of a possible fourth dimension, and suggests that a hypothesis is necessary to explain the somewhat doubtful phenomena with which psychical research deals. These notions, he thinks, afford the basis of a hypothesis.

NO. 2642, VOL. 105]

## Letters to the Editor.

[The Editor does not hold himself responsible for opinions expressed by his correspondents. Neither can he undertake to return, or to correspond with the writers of, rejected manuscripts intended for this or any other part of NATURE. No notice is taken of anonymous communications.]

### London University Site and Needs.

I HAVE been surprised that no word of protest has been raised against the scheme of locating the University of London on a limited plot of land in the centre of the city. If the site were for administration purposes alone, combined, perhaps, with lecture-rooms for those subjects which require no practical instruction, the area offered might be adequate, but could only be rendered suitable for its purpose at such an enormous cost for site, removal of existing buildings, and erection of new edifices, that nothing but the most urgent necessity could justify; nor would the new position be one whit better or more convenient than South Kensington. It is, however, understood that the buildings to be erected are not only for administration purposes and lectures, but also to meet all requirements of the scientific departments.

Now it can be easily shown that provision for scientific subjects will require a far greater area of land than the amount suggested in the Government's offer. For the population of London one thousand would be a moderate estimate for the number of students who might be expected to need instruction in any one of the great departments of science, of which not fewer than twenty would need to be provided. Taking into consideration passages, staircases, preparation rooms, and assistants' rooms, for every working place in any practical department a floor area of at least ten square yards is wanted. Therefore, for each of the twenty subjects not less than ten thousand square yards of floor-space would be necessary. In addition to this, each will require lecture theatres, demonstration rooms, and research rooms; and for this, on a moderate estimate, we must add 50 per cent. to the above figure. This gives a total requirement for the twenty practical departments of not less than fifty acres of floor-space, in addition to the area wanted for administration purposes, libraries, museums, and for the subjects which do not need accommodation for practical work. Unless, therefore, the "skyscraper" system is to be utilised for university buildings, the 1½-acre plot proposed to be given up for the purposes of the University of London is absurdly inadequate, especially since not more than 8 acres of such a site could possibly be covered by actual buildings.

The problem is, however, much more complex than is represented by a mere computation of floor area. Anyone who has experience of a practical department knows the supreme importance of placing it in an entirely separate, self-contained building or institute, thereby allowing abundance of light for all rooms and furnishing space for any necessary future extension. Such institutes cannot be erected on a limited site. They require far more land than can ever be provided in the centre of a town. It is, therefore, certain that a single university adequate for the needs of London cannot be established in the situation proposed by the Government; and it is not too much to assert that its purchase and the cost of erecting buildings upon it would be a most wasteful expenditure, involving at the lowest estimate a total of five millions sterling!

The alternative is to decentralise the teaching by placing several university centres—say four to begin



with—on the outskirts of London in places where each could be furnished with at least one hundred acres of land at a total cost of no more than is asked for the 11½ acres now proffered.

The advantages of such outlying centres would be : (1) The students could live in the neighbourhood of the institution, either at home or in hostels, and would not be compelled to take a long journey twice a day. (2) There would be abundance of room for all purposes, including recreation. (3) Each subject would be able to have its own area of ground for the erection of a suitable institute, and for permitting future extension. (4) Temporary buildings might be put up until experience has shown what character of permanent buildings ought to be erected. (5) The classes would not be of an unwieldy size; for we might assume for each of the four centres two hundred and fifty students, instead of the one thousand assumed for the central institute, i.e. for each practical subject.

American experience has shown that one hundred acres is not too much land to provide for the buildings of a modern university, and a scheme which assumes that a single university for a city the size of London can be accommodated in a space of ten, or even twenty, acres is self-condemned at the outset.

E. SHARPEY CHAFER.

University New Buildings, Edinburgh, June 7.

**High Rates of Ascent of Pilot-Balloons.**

ABNORMAL rates of ascent shown by pilot-balloons have in recent years aroused considerable interest amongst aerologists. These digressions were mostly ascribed to the occurrence of vertical air-currents, but three years ago Wenger (*Annalen der Hydrographie*, 1917, Hamburg) suggested<sup>1</sup> that, for the greater part, the observations did not permit of such an explanation. He advanced the theory that these abnormal rates were chiefly caused by increased turbulence of the air, and he stated, making use of the Lindenberg material, that the rates observed depended on different conditions of the air, as wind, friction, etc., which, no doubt, must have a notable influence on its turbulence.

In the same journal, however, it was shown that a large number of observations made at Sofia (Bulgaria) gave strong evidence that actually large vertical air-currents had occurred, and that the high and low rate should, without doubt, be ascribed to upward and downward movements of the air.

Between 1912 and 1917 much material regarding these rates was gathered by the Batavia Observatory, and peculiar circumstances make this material of critical value, for it consists of three series taken in three localities differing in character, the ascents being made at various hours during the day and night.

The first series was taken at Batavia during the dry, sunny season, when land- and sea-breezes are developed strongly; and the second at Bandung, a town situated on a plateau 700 m. above sea-level, surrounded by mountains. Insolation in the latter case did not differ much from that at Batavia; the mountain- and valley-breezes were only slight.

The third series was taken by Dr. Boerema on a small coral islet in the Java Sea at the end of the west monsoon. There the influence of insolation and of land- and sea-breezes is practically nothing.

Most of the balloons were observed from two points; also, up to 1 or 1½ km., half-minute readings were taken between the usual observations made every minute. Balloons of different weight and pattern were used; those for the night carried a second balloon

filled with acetylene and a burner. For each kind I calculated the average rate observed at the level of 3 or 4 km., and derived from it the rate for the layers beneath by applying the formula

$$v = ad^{-1} \quad (d = \text{air density}).$$

For the light balloons there remained, of course, a change of rate with height, which, however, I was unable to calculate, but I surmise was small.

The accompanying diagram (Fig. 1) gives for the lowest layers up to 3 km. the departures of the mean rates observed from those at 3 or 4 km. Evidently it displays the contrast between the land and the sea influence, i.e. on land the rates are increased by day, but are normal by night, while at sea there is no distinct increase in the average rate.

At Batavia the positive digression runs parallel with the strength of the sea-breeze and with the change of

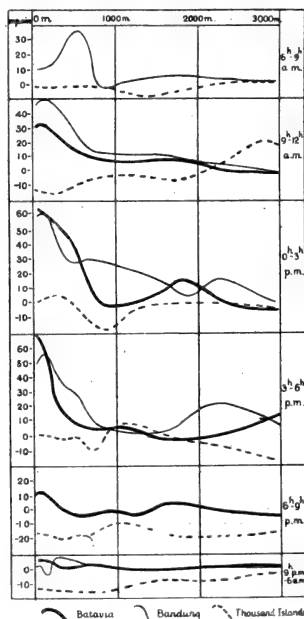

FIG. 1.

wind velocity caused by the Espy-Köppen effect. At Bandung also this parallelism seems to exist.

Consequently, at first sight, the explanation proposed by Wenger might be given: During the day turbulence is enhanced on land by increase of wind velocity, by friction with the surface, and by insolation; at sea, on the contrary, these causes are not present. However, on more detailed examination this explanation is not confirmed. Thus the rate of ascent did not prove to depend on wind velocity, as the following figures clearly show:

Batavia.					
9 a.m.-noon		Noon-3 p.m.		3-6 p.m.	
Δ Rate of ascent m. p. min.	Wind velocity m. p. sec.	Δ Rate of ascent m. p. min.	Wind velocity m. p. sec.	Δ Rate of ascent m. p. min.	Wind velocity m. p. sec.
3	3·8	—	8·7	4	8·0
63	4·0	—64	7·5	56	5·6
—	—	136	6·4	133	6·9

<sup>1</sup> It came under my notice only a few months ago.

## Bandung.

9 a.m.-6 p.m.	
$\Delta$ Rate of ascent m. p. min.	Wind velocity m. p. sec.
10	2.9
39	3.7
103	2.3

Also, the wind velocity scarcely ever reached the values ( $>15$  m. per sec.) at which, according to Wenger, the influence of wind velocity begins to increase turbulence, so that a notable increase in the rate of ascent is to be expected.

Moreover, insolation is strongest between 9 a.m. and noon; afterwards, clouds mostly weaken it or prevent further increase. On the other hand, the rate of ascent at Batavia between noon and 3 p.m. considerably exceeds that between 9 a.m. and noon.

Thus an explanation of the observed rates by Wenger's theory practically fails; on the contrary, the supposition of vertical air movement is tenable.

For some years I supposed that the air had to rise in columns, and, the surrounding air being sucked in, the balloon in most cases would also be sucked in, and afterwards would not leave the ascending air-columns. Later I read that J. S. Dines was inclined to this conception. The criticism of this view offered by Wenger must be accepted; but why should not both causes co-operate in the lowest strata?

Indeed, I have found that my results and those of Wenger coincide regarding the change of rate of ascent when, passing upwards, wind velocity varies.

Denoting this change by  $10^5 \frac{dv}{dz}$  ( $v$ =wind velocity in m. per sec., and  $z$ =height in m.), I found:

Batavia.			Thousand Islands.		
$10^5 \frac{dv}{dz}$	$\Delta$ Rate of ascent m. p. sec.	No. of cases	$10^5 \frac{dv}{dz}$	$\Delta$ Rate of ascent m. p. sec.	No. of cases
1.2	0.7	22	0.7	1.3	28
-1.1	-1.0	42	-0.4	-1.1	38
-2.2	-0.6	20			

As these values show, the change of rate with wind velocity is not developed strongly, the percentage of cases in which  $\frac{dv}{dz}$  and  $\Delta$  rate were of the same sign being respectively for Batavia and the Thousand Islands 63 and 68 only.

Finally, we are obliged to accept the view that in the sea-breeze the air must rise as the breeze dies out at a moderate distance from the coast. Also, the air seems to rise no higher than the sea-breeze itself, the rate of rise, diminishing with its horizontal velocity.

Moreover, I think the material collected on and near Java is not favourable to the idea of such a preponderating influence of turbulence as Wenger accepts; on the contrary, it corroborates the assumption of ascending columns.

The formation of the fine-weather cumuli, to be observed every sunny day in the tropics, is clear evidence of the general occurrence of these ascending air columns.

W. VAN BEMMELN.

On board s.s. *Ijisondari*, Pacific.

### A New Method for Approximate Evaluation of Definite Integrals between Finite Limits.

GAUSS, I believe, gave a very large number of forms for approximate evaluation of definite integrals between finite limits. His formulæ are all based, like Tchebycheff's rules, on the assumption that the integrand is expressible approximately by a finite number of terms of the series  $a+bx+cx^2+dx^3+\dots$ . His plan was to use a minimum number of suitably

weighted ordinates to give him the exact value of the integral for a specified number of terms.

Taking the range of integration to be from  $-1$  to  $+1$ , which can be done without any loss of generality, his simplest integral is

$$\int_{-1}^{+1} f(x) dx = f(-x_1) + f(x_1),$$

where

$$x_1 = \frac{1}{\sqrt{3}}.$$

This formulæ with two ordinates gives exact values for

$$\int_{-1}^{+1} (a+bx+cx^2+dx^3) dx,$$

and is in that respect on a par with Simpson's formula, which has three ordinates weighted in the proportions 1, 4, 1, and situated at the ends and middle of the range.

The next Gauss formulæ is

$$\int_{-1}^{+1} f(x) dx = \frac{1}{3} [5f(-x_1) + 8f(0) + 5f(x_1)],$$

where

$$x_1 = \sqrt{\frac{3}{5}}.$$

This is exact up to and including the term in  $x^4$  in the series. Put in the same form as Mr. Merchant's formula (which is also exact up to the  $x^4$  term) in NATURE of June 3, it becomes

$$\int_{-1}^{+1} f(x) dx = \frac{1}{8} [5f(x_1) + 8f(x_2) + 5f(x_3)],$$

where

$$x_1 = 0.1127, \quad x_2 = 0.5, \quad x_3 = 0.8873.$$

The third formulæ is

$$\int_{-1}^{+1} f(x) dx = \frac{1}{(A+B)} [Af(-x_1) + Bf(-x_2) + Bf(x_2) + Af(x_1)]$$

where

$$A = \frac{1}{2} - \frac{1}{6}\sqrt{\frac{5}{3}}, \quad B = \frac{1}{2} + \frac{1}{6}\sqrt{\frac{5}{3}},$$

$$x_1^2 = \frac{3}{5} + \frac{2}{5}\sqrt{\frac{5}{3}}, \quad x_2^2 = \frac{3}{5} - \frac{2}{5}\sqrt{\frac{5}{3}}.$$

Transferred to the other form, this becomes

$$\int_0^1 f(x) dx = 0.1739f(x_1) + 0.3261f(x_2) + 0.3261f(x_3) + 0.1739f(x_4)$$

where

$$x_1 = 0.0694, \quad x_2 = 0.3300, \quad x_3 = 0.6700, \quad x_4 = 0.9306.$$

This formulæ is exact up to and including the term in  $x^7$ .

It may be noticed that although the weight factors are now incommensurate, they can be written with a very close degree of approximation as  $\frac{1}{25}$  and  $\frac{1}{10}$ , and the integral then takes the form

$$\int_0^1 f(x) dx = \frac{1}{25} [8f(x_1) + 15f(x_2) + 15f(x_3) + 8f(x_4)].$$

Possibly Mr. Merchant might find that this form would be useful in ship design. The positions of the ordinates is not sufficiently close to even tenths to permit of such further modifications being made, but if the ship's half-length were divided into fifteen sections, the ordinates would come very near the first, fifth, tenth, and fourteenth. Some of the higher Gauss integrals might be found to fit in even more conveniently.

THOS. Y. BAKER.

Admiralty Compass Observatory, Slough,  
Bucks, June 10.

### The Royal Military Academy.

SIR GEORGE GREENHILL in an article in NATURE of April 29, entitled "Artillery Science," passes severe strictures on the Royal Military Academy—"The Shop." These reflect on the whole staff, especially the military staff, and as the officers are not permitted

to defend themselves in public journals, I ask permission as a civilian to say a few words in defence.

War is the best test of a military establishment. During the war the R.M.A. worked continuously, and turned out more than two thousand young officers who were able to proceed, either direct or after a short additional course, straight to the battlefields and take their full share of the work with their batteries or field companies. Courses in field telephony were also given to an equal number of officers, n.c.o.'s, and men of the new armies at a critical period when there were few instructors elsewhere. There were many other activities. Owing to the seclusion in which the Academy works, there were few except those immediately connected with it who had any idea of the great amount of work actually done.

Science was encouraged by all three of the Commandants during this period, and dealt with all military applications up to date. The teaching of wireless was commenced in the R.M.A. eighteen years ago, and that it was not used at a much earlier period of the war was certainly no fault of the R.M.A. During the war an opportunity was given for the study in detail of the course given to French artillery officers. In science there was nothing to be learnt from it, and the same was reported in other subjects. There is no reason to believe that the German schools were any better.

The R.M.A. has been submitted to inquiry from outside three times in the past twenty years: First, by Lord Esher's Committee shortly after the Boer War; next, in 1911, an inspection by specialists from the Board of Education; and thirdly, an inspection by the Board of Education in February last. The first two reports were entirely favourable, and no doubt can still be obtained. The latest, which is not yet permitted to be published, gives a fair picture of the place and its work. It also contains criticisms and recommendations which, if adopted by the War Office, would improve the establishment, and consequently the Army. I understood from the inspectors that they had come to the same conclusion as those on a former occasion, viz. "The Academy is very efficient."

The academy is not perfect, but its improvement, not its abolition, is what is desirable. Merely to move it to a new situation while retaining the old system would do no good; and to amalgamate it with Sandhurst would, in my opinion, in these specialising days, be a mistake.

Improvements must commence at Whitehall, for it is at the War Office that all decisions as to courses of study, staffs, etc., are made. Scientific advisers from the learned societies would help, for it is scarcely to be expected that the officers there can be in touch with scientific progress. There are still some who do not yet believe in the importance of science, and are under the impression that any R.E. officer can teach all that is necessary.

The half-dozen civilians mentioned in the article are responsible for mathematics and science. They must now be almost alone amongst those engaged in education in the public service in having no security of tenure and no retiring allowance. Their numbers, now reduced below pre-war level, might be increased with advantage, but I understand that it has been decided to dispense with civilians in science altogether in a year or so, and no doubt the mathematical staff will follow. Their places will be filled by officers. I think that most of those who have an intimate knowledge of these subjects will agree that this is a retrograde step.

Mathematics and science should have adequate civilian staffs of properly trained men. Appointments should be permanent and emoluments correspond to those of the military staff, with retiring allowances on

the Civil Service scale. Members of the civilian staff could then, without anxiety, devote themselves to the work, which necessarily takes a different direction from that at a civil institution, and even the best civilians require a considerable time before becoming familiar with military requirements and military apparatus.

Accommodation for research by the staff should be provided. Officer instructors, in science at least, should be students as much as instructors, so that at the end of their appointments they would rejoin the Army reasonably up-to-date in their subjects. Cadets with a special bent should be given opportunities so far as possible to do extra work, to assist them in deciding on their future course and to prepare them for it. The present two years' course is too short to do much in any direction, as it has to be divided between many subjects. An increase of length would be an advantage.

The R.M.A. is a cadet school, and aims at producing the useful regimental officer, but it cannot produce experts. For the artillery there should be a further selection of young officers, who should receive additional training at the Ordnance College, which should be a genuine artillery university, and not merely a training place for officers desirous of semi-civil appointments. It should be the function of this establishment to turn out the artillery expert, and if it were not done the blame would lie there. The R.E. would probably require a similar establishment or an extension of the "School of Military Engineering." Cooperation between the various military schools is advisable, but, above all, there should be some system established for the regular distribution of information on military matters amongst the departments concerned. At present it is exceedingly difficult for those engaged in one department or school to find out what is happening elsewhere.

The equalisation of pay will now enable cadets to make a free choice between the R.A. and the R.E., but those scientifically inclined will still probably choose the latter.

I do not believe much is to be gained by imitating foreign institutions. In the four years and a half of the war we succeeded in overtaking the German in every direction, in spite of his long preparation. Our aim now should be to avoid retrogression: for that is our chief danger.

J. YOUNG.  
Science Department, Royal Military Academy,  
Woolwich, S.E.18, June 3.

### The Separation of the Isotopes of Chlorine.

ON certain plausible assumptions concerning the nature of chemical equilibria and the properties of isotopes, it should be possible to separate the isotopic varieties of an element like chlorine by means of a reversible chemical change in the gaseous state, provided that the number of atoms of chlorine in the reacting compound is unequal to the number of atoms in the resulting compound.

Thus, for the sake of argument, assume that chlorine contains two isotopes the atoms of which can be represented by Cl and Cl', then there would be three classes of molecules, namely, Cl<sub>2</sub>, Cl<sub>2</sub>', and ClCl', of which the corresponding liquids and solids would have the very nearly same vapour pressure at the same temperature. Accordingly, if it may be assumed that 2 mols. of ClCl' can be converted into 1 mol. of Cl<sub>2</sub>, and 1 mol. of Cl<sub>2</sub>' in the liquid forms at the same temperature without the expenditure of work,

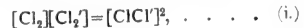

where the square bracket has the usual significance of concentration.

Now in Deacon's process, which is represented by the chemical equation

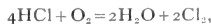

we should have

$$\frac{[\text{Cl}_2]}{[\text{Cl}_2]'} = \frac{[\text{HCl}]^2}{[\text{HCl}]'} \dots \dots \dots \text{(ii)}$$

Taking  $\frac{[\text{HCl}]}{[\text{HCl}]'}$  as 3,  $\frac{[\text{Cl}_2]}{[\text{Cl}_2]'}$  is 9, provided that the temperature and concentration of the oxygen are selected so that the concentration of the chlorine is small at equilibrium.

But the ratio of the atoms of the two varieties of chlorine is given by

$$\frac{[\text{Cl}_2] + \frac{1}{2}[\text{ClCl}']}{[\text{Cl}_2] + \frac{1}{2}[\text{ClCl}]'}$$

and this, by equations (i.) and (ii.), is equal to  $\frac{10.5}{2.5}$ ,

which differs appreciably from 3.

Deacon's process is selected merely for the purpose of illustration.

If the isotopic varieties of chlorine are inseparable by the method above indicated, it is clear that

$$\frac{[\text{Cl}_2] + \frac{1}{2}[\text{ClCl}']}{[\text{Cl}_2] + \frac{1}{2}[\text{ClCl}]'} = \frac{[\text{HCl}]}{[\text{HCl}]'} = \frac{[\text{Cl}_2]}{[\text{Cl}_2]'} \dots \dots \dots \text{(iii.)}$$

whence

$$2[\text{Cl}_2][\text{Cl}_2]'^3 = [\text{ClCl}]' \dots \dots \dots \text{(iv.)}$$

Now consider two solids composed entirely of  $\text{Cl}_2$  and  $\text{Cl}_2'$  molecules respectively. The vapour pressures of the two solids will be very nearly (if not exactly) the same—say  $p$ —at the same temperature  $t$ .

Evaporate a gram-molecule of both the solids. Reduce the pressure of the  $\text{Cl}_2$  isotope to  $p_1$ , and that of the  $\text{Cl}_2'$  isotope to  $p_2$ , and then introduce both unsaturated vapours into a van't Hoff's equilibrium box. The total work done in these operations is

$$Rt \log_e \frac{p^2}{p_1 p_2}$$

Now remove 2 gram-molecules of the  $\text{ClCl}'$  variety (which from equation (iv.) will obviously be at the pressure  $2\sqrt{p_1 p_2}$ ) from the equilibrium box. Increase the pressure to  $p$ , and finally condense at this pressure to the solid form. The work done during this series of operations will be

$$Rt \log_e \frac{4p_1 p_2}{p^2}$$

Therefore the total work performed in effecting the change represented by the equation



is  $Rt \log 4 = A$ .

But it is difficult to understand how the free energy  $A$  could differ appreciably from zero if the molecular heats of the three varieties of chlorine are nearly the same—as they are generally supposed to be—and if the entropy of the reactants  $\text{Cl}_2$  and  $\text{Cl}_2'$  is equal to that of the resultant  $2\text{ClCl}'$  at the absolute zero temperature, as Nernst postulates in his heat theorem.

An attempt is being made in the Jesus College Laboratory to separate the isotopes of chlorine by a method similar to that given above. A negative result would be difficult to reconcile with Nernst's theorem

that  $\frac{dA}{dt} = 0$  at the absolute zero.

D. L. CHAPMAN.

Jesus College, Oxford.

NO. 2642, VOL. 105]

**A Note on Telephotography.**

HAVING examined a number of formulæ for the circle of illumination in telephotography, and found them all to be inapplicable in certain cases, I propose the following, which seem reasonable and are applicable in all cases. These formulæ are particularly vital in the line along which telephotography is at present developing.

- Let  $C_1$  = Full circle of illumination.
- $C_2$  = Circle of equal " "
- $C_m$  = Mean circle of " "
- $M$  = Magnification.
- $f_1$  = Focus of positive lens.
- $f_2$  = " " negative " "
- $b$  = Diameter of positive lens.
- $c$  = " " negative " "

Then

$$C_1 = \frac{M^2(f_1 c + f_2 b) - M f_2 b}{M(f_1 - f_2) + f_2} \dots \dots \dots \text{(1)}$$

$$C_2 = \frac{M^2(f_1 c - f_2 b) + M f_2 b}{M(f_1 - f_2) + f_2} \dots \dots \dots \text{(2)}$$

$$C_m = \frac{M^2 f_1 c}{M(f_1 - f_2) + f_2} \dots \dots \dots \text{(3)}$$

The last formula (3) is not only the simplest, but it is also the accurate value for the circle when the aperture ( $b$ ) of the positive lens is small. It is the mean between the full (1) circle and the evenly illuminated (2) circle. The first (1) is the most usually used. It gives the diagonal of the largest plate that can be employed. The second (2) gives the circle that is equally illuminated. If it is possible to make the aperture ( $b$ ) of the positive lens equal to the diameter ( $c$ ) of the negative lens, this formula becomes the simplest.

$$C_m = M.c.$$

I have received an opinion on the above from a distinguished authority upon geometric optics. He is of the opinion that it is necessary to add that certain assumptions have been made in deciding these formulæ. These assumptions are (a) that the lenses are thin, (b) that the aberrations may be neglected, and (c) that the focal lengths of both lenses,  $f_1$  and  $f_2$ , are definite quantities.

(a) Photographic positive lenses are usually not thin. Negative telephoto lenses, except some high-power lenses, are always thin. With a thick lens the "equivalent planes" for the two sides (the "object space" and the "image space") are different. As all measurements in the above formulæ are made from the back of the positive lens and the front of the negative lens, no confusion can arise between the equivalent planes.

(b) The aberrations of a photographic lens are negligible.

(c) The positions of the equivalent planes of the negative lens move over a small space with a change of magnification. This quantity is negligible in deciding the circle of illumination, which does not need to be known exactly.

The position of the equivalent plane of the whole varies greatly with a change of distance of object. This can be completely corrected by substituting the "back conjugate focus" of the positive lens for the distance, in place of the "principal" focus ( $f_1$ ) in the above formulæ. In telephotography the object is usually "at infinity," and this correction is not necessary.

In a short note it is not possible to do more than indicate the conditions in which these formulæ may be used. Consult Lan-Davis on "Telephotography" and Beck and Andrews's "A Simple Treatise on Photographic Lenses" (Appendix) for "equivalent planes."

A. B.

Recent Researches on Nebulæ.<sup>1</sup>

By MAJOR WILLIAM J. S. LOCKYER.

THE latest volume (No. xiii.) in the series of Publications of the Lick Observatory, situated on Mount Hamilton, California, is completely devoted to a series of well-laid-out investigations of the study of the forms, distribution, velocities, and spectra of the nebulæ. The volume is one of extreme interest and importance, and will become a classic for a considerable time on those interesting objects scattered throughout the heavens.

In these days, when the study of the evolution of the stars is occupying a position in the front rank, the more detailed information of the nebulæ, their composition, structure, and movements, is of fundamental importance, for these bodies are criteria in the evolutionary stages of stars.

Considerations of space will not permit here more than an outline of the contents of this substantial volume, which includes six separate contributions, each devoted to a special research, and a large number of beautifully reproduced plates.

Part i. is contributed by Mr. H. D. Curtis (pp. 11-42), and deals with the descriptions of 762 nebulæ and clusters photographed with the Crossley reflector. It comprises all photographs of these objects which have been taken with this instrument since the year 1898, when systematic work was commenced, forming, therefore, a valuable homogeneous research.

It is interesting to note the types of the 762 entries, which Mr. Curtis divides as follows: 513 spiral, 56 diffuse, 36 globular, 24 sparse, 78 planetary, 8 dark, and 47 unclassified. Mr. Curtis is led to believe that all the many thousands of nebulæ not definitely to be classed as diffuse or planetary are true spirals, and that "the very minute spiral nebulæ appear as textureless discs or ovals solely because of their size."

In estimating the probable total number of the spiral nebulæ, Mr. Curtis concludes that at least 700,000, and very probably 1,000,000, small spirals are within the reach of large reflecting telescopes. A chart showing the distribution of regions on which small nebulæ were counted indicates also the position of the galactic plane, and the paper concludes with reproductions of a few typical nebulæ.

The second part, by the same author, is devoted to a study of occulting matter in the spiral nebulæ (pp. 45-54), and its object is to show that the occurrence of such dark bands running down the length of spiral nebulæ seen edgewise is a relatively common feature. While a description of these appearances is not necessarily satisfactory to those who have not had occasion to observe them or to see the original photographs, Mr. Curtis includes seventy-seven reproductions. By the kindness of Prof. W. W. Campbell, repro-

ductions of some of these spirals are here given (Figs. 1, 2, and 3).

References are made to other evidences of occulting matter in the sky, such as the cutting off in the number of stars round a nebula, "coal sacks" or starless regions, dark nebulæ, etc. (see Fig. 4). The fact that many spectroscopic binaries indicate a constant radial velocity for the H and K lines, different from the periodic shift of the other lines in the spectrum, suggests, according to the author, the interposition between us and the binary of a cloud of non-luminous matter, though, as he says, there are some difficulties in this hypothesis. The subject of the peculiar grouping of the

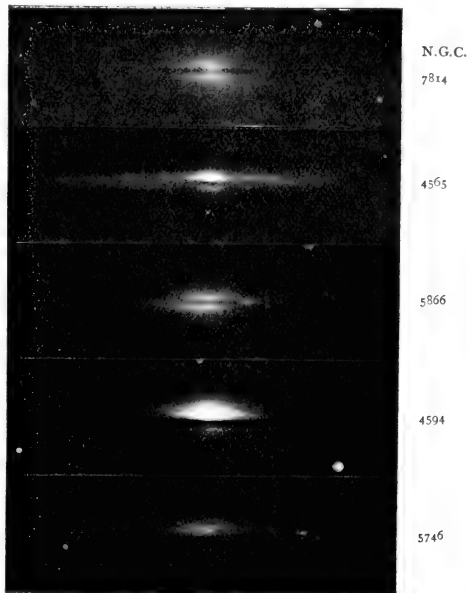

FIG. 1.—Spiral nebulæ seen almost exactly edgewise and showing indubitable evidence of dark lanes. (H. D. Curtis.)

spiral nebulæ about the galactic poles is also mentioned.

Part iii. is entitled "The Planetary Nebulæ," and in it Mr. Curtis brings together the results of a research on a series of photographs of all the planetary nebulæ north of 34° S. declination. Seventy-eight of these objects are dealt with, and they are all reproduced either by photographs or by drawings (with scale). Drawings were resorted to only when the objects were so small that they could not be reproduced by the process of photo-engraving, or when great differences in brightness between the central and the faint outlying portions were encountered, which

<sup>1</sup> University of California Publications. Publications of the Lick Observatory. Vol. xiii. Pp. 268+50 plates. (Berkeley: University of California Press, 1918.)

prevented an adequate representation of all the details of the nebula (Fig. 5). This collection of illustrations, showing the forms assumed by the planetary nebulae, will throw considerable light upon the structure and life-history of these bodies. An important addition to the illustrations is that the exposure for recording a selected portion of the Orion nebula has been used as a standard, and the time necessary for recording the brightest portion of a planetary nebula is given in relation to that standard. Thus

It is concluded, therefore, that these giants may be in the Galaxy, but the nearest to us, and, therefore, would only appear outside, and he suggests their inclusion in parallax programmes, as many of them have central stars sufficiently bright for that purpose.

Further reference cannot be made here to this interesting paper except to add that the author classifies the planetary nebulae according to their appearances, and then discusses these forms in relation to homogeneous oblate spheroidal or

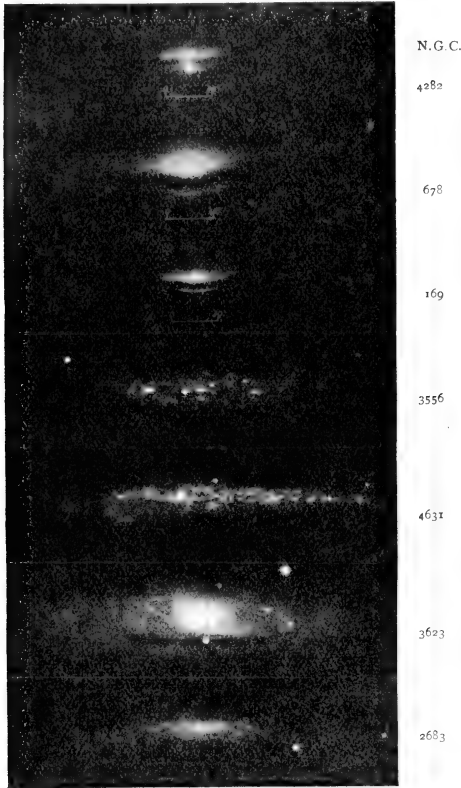

FIG. 2.—Spiral nebulae seen almost, but not exactly, edgewise, and some the planes of which make a small but appreciable angle with the line of sight, showing clear evidence of dark lanes. (H. D. Curtis.)

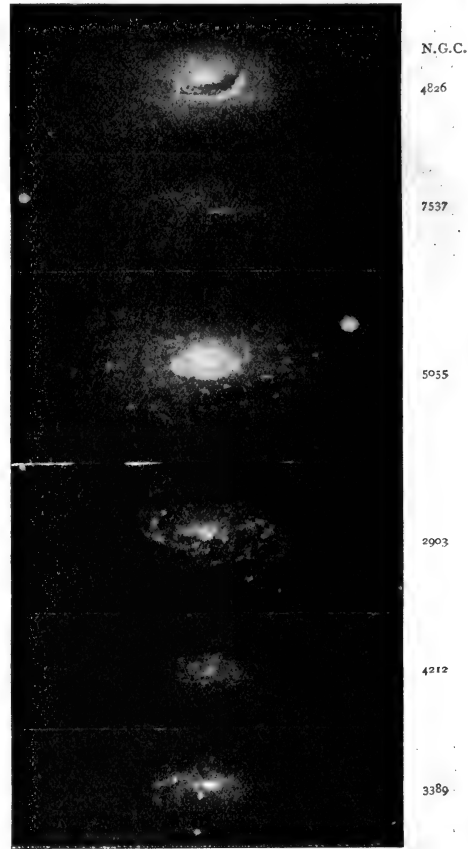

FIG. 3.—Spiral nebulae making a much greater angle with the line of sight, showing clear-cut dark lanes (2903, 4212), and a lane absolutely black and cutting across a whorl at the right end (4226). (H. D. Curtis.)

an approximation to the relative brightness of the planetary nebulae is secured.

With regard to the distribution of these nebulae in space, an interesting diagram of which is given, Mr. Curtis finds that the smallest objects are almost invariably in, or very close to, the Milky Way, while the larger planetaries, "the giants of the class," somewhat more frequent in the vicinity of the galactic plane, are, "on the whole, fairly uniformly distributed over the entire sky."

homogeneous truncated spheroidal shells under various conditions.

Prof. W. W. Campbell and Mr. J. H. Moore are the authors of part iv., which is devoted to the spectrographic velocities of the bright-line nebulae (pp. 77-183). The observations are a combination of those made with the 36-in.

refractor at Mount Hamilton and with the 37-in. Mills reflector at Santiago, Chile, and they were commenced in the year 1913. The list includes 138

displayed from which the internal motion of the nebula was deduced.

The average magnitudes of the derived values for the velocities are as follows: Calling the nebulae less than 5 secs. in diameter "stellar," and those greater than 5 secs. "non-stellar," the mean velocity for thirty-one "stellar" nebulae is 28 km. per sec., and for sixty-five non-stellar nebulae 31 km. per sec. with reference to the stellar system. For evidence of rotation or internal motion in the planetary nebulae, the lines in the spectra of forty-six such objects have been examined in detail and are here discussed. Of these, twenty-five gave evidence of internal effects, while nineteen, and possibly two more, indicated rotations about axes roughly perpendicular to the line of sight. It is worthy of note that the most elongated planetary nebulae showed the highest rotational speeds.

The study of the radial velocities of numerous parts of the Orion nebula shows a range in velocities from +9.7 km. to +24.9 km., and, as the authors state, the results do not favour the hypothesis of a rotation as a whole, but the observed differences appear to be local or regional in character.

Mr. R. E. Wilson contributes part v. of this volume (pp. 187-90), which deals with the radial velocity of the greater Magellanic cloud. In 1914 it was pointed out that several gaseous nebulae in this region exhibited very large and approximately equal radial velocities, so Mr. Wilson presents the results of his study of this view after his survey, for he finds that, observing seventeen planetary nebulae in this region, the radial velocities lie between +251 km. and +309 km., an average of +276 km. Correcting this mean for solar motion,

the mean velocity is +261 km. per sec. This average, compared with the mean velocity deduced in part iv. for other planetary nebulae, points to

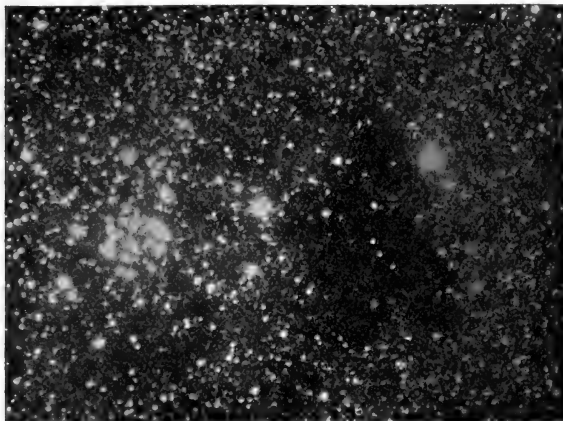

FIG. 4.—A "dark nebula" (17h. 57m., -27°50') visible through its projection upon the background of stars, and not considered to be "a hole" in the Milky Way. Note the circular protuberance at the south-west corner, as clear-cut as an ink-drop and perfectly dark. (H. D. Curtis.)

nebulae with bright lines in their spectra. In the earlier part details are given with respect to the spectroscopes employed, the probable errors of the results, and a description of the observations made at the two stations.

The detailed results of each object are then given in the order of right ascension. Attention may be directed to the fact that the lengths of the slits of the spectroscopes employed were in most cases more than sufficient to cover the width of the images of the objects photographed, so that the spectra of the central and outlying portions of the nebulae should both be recorded.

In a further table the final deduced radial velocities of each object observed are given. The observations recorded are evidence of most extensive and arduous work, and the numerous observations of each object considerably emphasise

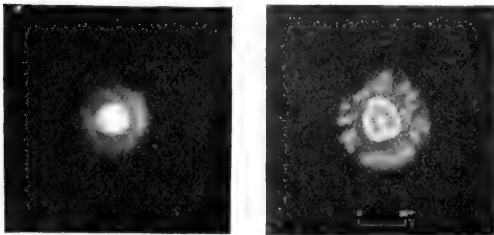

FIG. 5.—On the left a photograph of N.G.C. 2392, a double-ring planetary nebula; and on the right a composite drawing of the same made from several photographs to show details of the structure not attainable from any single photograph. (H. D. Curtis.)

this fact. The accompanying illustration (Fig. 6) shows a photograph of the chief nebular line in N.G.C. 2392, and exhibits the kind of structure

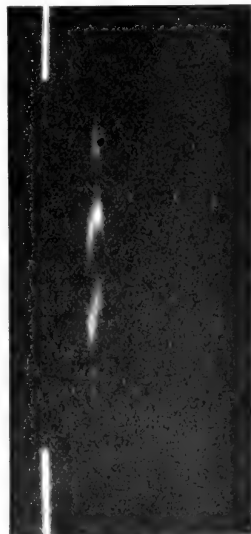

FIG. 6.—A photograph of the chief nebular line in N.G.C. 2392. The slit of the spectroscope was placed along the major axis of the nebula. (W. W. Campbell and J. H. Moore.)

exceptional conditions in this region. Mr. Wilson refers to the spiral appearance of this great cloud and to the high velocities observed in spiral nebulae, nebulae which may be considered as isolated island universes similar to our Milky Way system, suggesting that the great cloud may afford an opportunity for the study of detailed characteristics of spiral nebulae.

Part vi., the last of the series of the important contents of this volume, is contributed by Mr. W. H. Wright, and deals with the subject of the wave-lengths of the nebular lines and general observations of the spectra of the gaseous nebulae (pp. 193-268). The matter falls under three headings: (1) The measurement of wave-lengths and the intensities of the nebular lines; (2) the study of the nebular nuclei; and (3) the investigation of the distribution of nebular radiations throughout the nebulae; and is accompanied by a series of plates, which demonstrate, more than text can do, the fine definition and great scale of the photographs of the spectra of the nebulae which served as his data. Fig. 7 is an illustration of the

career increasing in temperature, reaching a maximum of development and temperature, and afterwards cooling until the invisible stage is reached. In the light of these hypotheses Mr. Wright, as the result of his research, expresses his view as follows:—

There are at present two general conceptions as to the nature of stellar evolution, one of which assumes a falling temperature throughout the period of a star's development, while the other predicates a rise to maximum and a subsequent decline; both of these views assume the nebula as the primordial state. As between these two hypotheses, the present observations undoubtedly favour the first, since they add to the proof that the gaseous nebulae are associated only with the hot stars.

While the above is one of the main conclusions derived by Mr. Wright from this research, there are many other points of particular interest to which limitations of space forbid reference in this article.

It is interesting to compare a direct photograph of a nebula with its spectrum taken with a slitless spectrograph. Nebulae when photo-

3426

3727

3869

H $\gamma$ 

4686

N1-2



FIG. 7.—The spectrum of N.G.C. 6818, which records images of a variety of shapes and sizes, most of them having the appearance of a horse-shoe, the open end of the shoe lying to the north. Some of the images show mottlings or condensations scattered along the shoe or ring. (W. H. Wright.)

spectrum of N.G.C. 6818, taken with the slitless spectrograph with an exposure of four hours. It does not seem that the statement could be contradicted that the wave-lengths and intensities of the nebular lines deduced will be used as a standard in this branch of physical astronomy for some time.

This research is very opportune, because more detailed facts were required to help in the unravelling of the relationships between nebulae as such, nuclei of nebulae, and bright-line stars such as Wolf-Rayet stars. As the whole problem of the nature of stellar evolution is that of the solution of the relationship between nebulae and stars, the study of the question is of vital importance. The idea of a falling temperature continuing throughout the whole life-history of a star has more recently given place to the hypothesis, apparently a very natural one, of a star in its early

graphed with the latter instrument present remarkable varieties of form and size corresponding to different nebular lines in the spectrum, while the direct photograph shows only a form resulting from the integration or the fitting together of the component images of the different forms and sizes. The prismatic images afford a means, therefore, of detecting the differences in distribution of the component gases of the nebula, and indicate that the view of a nebula in a telescope or on a direct photograph is not the best means of studying the complex structure of these bodies.

In conclusion, it may be stated that this addition to the University of California Publications is a valuable contribution, and sustains the high standard of the researches which emanate from the Lick Observatory under the able directorship of Prof. W. W. Campbell.

### The Importance of Meteorology in Gunnery.

By DR. E. M. WEDDERBURN.

AT the commencement of the war the knowledge of the effect of wind and of the density of the air on the flight of a shell was elementary. It was assumed by the gunners that the wind was of the same direction and strength at all heights reached by the projectile, and that

the density of the air decreased with altitude according to an artificial convention. The corrections for wind and density which the gunner was taught to apply were supposed to be referable to the meteorological conditions observed by him at the battery, but he was not taught how



these conditions should be observed, nor that the observation of surface air temperature was an exceedingly difficult matter.

When an Army Meteorological Service was established in 1915 it was a small unit which had to justify its existence, and in the course of exploring fields of usefulness it found the artillery ready and anxious for improved meteorological information. The shell from a high-velocity gun may rise to a height of 20,000 ft. or more, and surface conditions may be a very misleading guide. But to ask the gunner to use detailed observations of wind and of atmospheric pressure and temperature at different heights up to 20,000 ft. under active service conditions, and without previous training, was useless. The meteorologist, having found a sphere of usefulness, had to put his information in a form in which it could be used with the existing artillery organisation. It is already suggested in some quarters that the meteorological service adequately met the artillery's requirements during the war without any peace-time organisation, and that therefore it is unnecessary now to keep any close *liaison* between the gunner and the meteorologist. In the writer's view this is a great mistake. The meteorological service was able to help the gunner by doing work which the gunner could have done if he had received the proper training, and it is necessary that he should do this work for himself in order to make the best use for his particular gun of data supplied to him by the meteorologist.

The artillery organisation for meteorological corrections consisted in the supply to gunners of tables of variations in line and range produced by winds constant in velocity and direction at all heights and of variations in range produced by changes in surface temperature and pressure, based on the assumption that the ratio between the actual air density and that assumed in the construction of the range table was the same at all heights. It was a fairly obvious first step to suggest that the gunner should be supplied with a fictitious wind such that, when used with the usual table of variations, the proper correction was applied for the cumulative effect on the projectile before reaching the target of a wind varying with height. Such a wind came to be called the equivalent constant wind, or the ballistic wind, and methods of estimating it were investigated simultaneously by the Meteorological Section, R.E., and the Anti-Aircraft Experimental Section (A.A.E.S.) of the Munitions Inventions Department (M.I.D.). At first the investigations were entirely independent and from different points of view, but later they were continued in close co-operation under the sympathetic guidance of the Ordnance Committee.

An initial difficulty of great importance was that the ballistic wind is not the same for any two trajectories, even for the same wind distribution. But, fortunately, the height to which a projectile rises when fired on the flat is nearly the same for

all projectiles which have the same time of flight, and also the length of time which such projectiles spend in any particular stratum of the atmosphere is nearly the same. Thus, though the range of a high-velocity gun may be double that of a howitzer for the same time of flight, yet the projectiles in each case rise to nearly the same height, and are affected by the same winds for nearly the same length of time. To a first approximation, therefore, the ballistic wind is the same for every projectile having the same time of flight, and if a selection of such winds for different times of flight is given to the gunner, he can choose the one most nearly suited to the conditions under which a shoot is taking place.

As a first approximation, in the calculation of the ballistic wind it was assumed that the atmosphere was stratified into several layers, and that in each layer the wind was constant in velocity and direction, though varying from layer to layer. It was further assumed that the effect of the wind in any layer on a projectile was proportional to the time spent by the projectile in that layer and to the density of the air. "Weighting factors" for the portion of the total displacement of the projectile caused by unit wind in any layer were thus determined. Subsequent mathematical analysis showed that the "weighting factors" varied materially for each different trajectory, and also differed for winds across and along the line of fire. Considerable refinements were introduced for the analysis of experimental shoots on which the construction of range tables was based. The researches of the A.A.E.S., M.I.D., though principally directed towards anti-aircraft gunnery, included careful and detailed discussions of variations in the trajectory of a shell produced by varying wind and density, and made the careful analysis of such experimental shoots possible. For a considerable period, however, the facilities afforded by the field meteorological service in the different theatres of war made possible much greater accuracy of correction than had been aimed at in the experimental shoots from which range tables were compiled. Ultimately average weighting factors, deduced from theoretical factors computed in a large number of cases, were adopted for different times of flight, and the method of constructing the ballistic wind for use in the field became standardised.

The second step was the introduction of the idea of ballistic density—a fictitious density such that when used with the usual tables of variations the proper correction is applied for the effect of an abnormal vertical distribution of density. Fortunately, the pressure and temperature which practically determine the air's density may be considered separately. If it is assumed that the vertical temperature distribution is known and remains unchanged while changes in pressure are registered at the surface of the earth, it is easily shown that there are proportional changes in pressure, and therefore in density, at all heights. Thus the surface barometer reading affords a real,

though partial, index of the density of the air at any height. From this the third step followed—the idea of a ballistic temperature such that when used in conjunction with surface pressure the ballistic density was arrived at. Methods of computing density weighting factors were developed by the A.A.E.S., M.I.D., and by using these factors temperature weighting factors were computed (which allowed for the variations in the vertical pressure distribution consequent on any variation in the temperature distribution). Here, again, the factors vary for each trajectory, but the differences between trajectories are considerably less than in the case of winds, and there was little difficulty in arriving at the best average factors to employ for field use.

By the employment of wind and temperature weighting factors, very numerous meteorological observations were made available for the use of gunners in the most convenient form. Ballistic winds and temperatures for several selected times of flight were telegraphed to the batteries at frequent intervals, and the information given in the meteorological telegrams, in conjunction with the barometric pressure measured at the battery, gave the gunner data which required no reduction, but could be used directly for applying corrections from the range table. It is, of course, essential that the results of meteorological observations should be provided "red hot" to the gunners, and methods of computation were so perfected, and so high a degree of skill was attained, that the calculation of ballistic winds from pilot-balloon observations kept pace with the observation of the balloon itself, and no time was lost in putting the information in the form in which it was readily usable by the gunner.

A single concrete example may suffice to illustrate the importance of the methods which were introduced by the meteorologists.

If a projectile were fired due south, with a time of flight of 50 sec. (*i.e.* rising to a height of about 10,000 ft.), under the following weather conditions, *viz.* :—

Height in ft.	Wind		Temperature ° F.	Barometer 3000 in. (Normal)
	Velocity f.s.	Direction		
Surface	8	110	50	
2,000	40	175	40	
4,000	45	185	30	
6,000	50	190	19	
8,000	45	190	8	
10,000	60	185	-2	

Then, if surface conditions are used for arriving at the appropriate corrections to apply, we have for a certain gun that the wind will reduce the range of the gun by 13 yards and deflect the projectile towards the west 60 yards. The surface temperature being 10° F. below the range table normal of 60° F., the range will be further reduced by 42 yards—a total loss in range of 55 yards.

But the ballistic wind for the above conditions is a wind of 44 f.s. from direction 185°, and the ballistic temperature is 36° F. For the same gun and projectile this wind would produce a deflection towards the east of 35 yards, a decrease in range due to wind of 600 yards and to abnormal temperature (and density) of 407 yards—in all more than 1000 yards. Thus the corrections applied by pre-war methods would have entailed in this case an error in range of about 1000 yards, and in line of about 100 yards.

Instead of anti-aircraft gunnery being considered as a special department of gunnery, it is more logical to consider fire on the flat as a specially simple case of the more general science of gunnery. In a very real way the development of the science was due to the researches of the A.A.E.S., M.I.D., and to the methods employed by that department in the analysis of fuse trials and in the calibration of guns. For anti-aircraft fire under active service conditions the application of meteorological corrections did not reach the same degree of organisation as for fire on the flat, for the application of corrections is a much simpler problem in the latter case. But in experimental work full account was taken of all the meteorological information available. Thus one of the main sources of errors in shooting was eliminated, and the investigation of many ballistic problems made possible.

### Obituary.

S. RAMANUJAN, F.R.S.

**S**RINIVASA RAMANUJAN, whose death was announced in NATURE of June 3, was born in 1888, in the neighbourhood of Madras, the son of poor parents, and a Brahmin by caste. I know very little of his early history or education, but he became a student in Madras University, and passed certain examinations, though he did not complete the course for a degree. Later he was employed by the Madras Port Trust as a clerk at a salary equivalent to about 25*l.* a year. By this time, however, reports of his unusual abilities had begun to spread, and, I believe owing to the intervention of Dr. G. T. Walker, he obtained a small scholarship which relieved him from the

necessity of office work and set him free for research.

I first heard of Ramanujan in 1913. The first letter which he sent me was certainly the most remarkable that I have ever received. There was a short personal introduction written, as he told me later, by a friend. The body of the letter consisted of the enunciations of a hundred or more mathematical theorems. Some of the formulæ were familiar, and others seemed scarcely possible to believe. A few (concerning the distribution of primes) could be said to be definitely false. There were no proofs, and the explanations were often inadequate. In many cases, too, some curious specialisation of a constant or a parameter made

the real meaning of a formula difficult to grasp. It was natural enough that Ramanujan should feel a little hesitation in giving away his secrets to a mathematician of an alien race. Whatever reservations had to be made, one thing was obvious, that the writer was a mathematician of the highest quality, a man of altogether exceptional originality and power.

It seemed plain, too, that Ramanujan ought to come to England. There was no difficulty in securing the necessary funds, his own University and Trinity College, Cambridge, meeting an unusual situation with admirable generosity and imagination. The difficulties of caste and religion were more serious; but, owing to the enterprise of Prof. E. H. Neville, who happened fortunately to be lecturing in Madras in the winter of 1913-14, these difficulties were ultimately overcome, and Ramanujan arrived in England in April, 1914.

The experiment has ended in disaster, for after three years in England Ramanujan contracted the illness from which he never recovered. But for these three years it was a triumphant success. In a really comfortable position for the first time in his life, with complete leisure assured to him, and in contact with mathematicians of the modern school, Ramanujan developed rapidly. He published some twenty papers, which, even in wartime, attracted wide attention. In the spring of 1918 he became the first Indian fellow of the Royal Society, and in the autumn the first Indian fellow of Trinity. Madras University endowed him with a research studentship in addition, and early in 1919, still unwell, but apparently considerably better, he returned to India. It was difficult to get news from him, but I heard at intervals. He appeared to be working actively again, and I was quite unprepared for the news of his death.

Ramanujan's activities lay primarily in fields known only to a small minority even among pure mathematicians—the applications of elliptic functions to the theory of numbers, the theory of continued fractions, and perhaps above all the theory of partitions. His insight into formulæ was quite amazing, and altogether beyond anything I have met with in any European mathematician. It is perhaps useless to speculate as to his history had he been introduced to modern ideas and methods at sixteen instead of at twenty-six. It is not extravagant to suppose that he might have become the greatest mathematician of his time. What he did actually is wonderful enough. Twenty years hence, when the researches which his work has suggested have been completed, it will probably seem a good deal more wonderful than it does to-day. G. H. HARDY.

#### PRINCIPAL SIR JOHN HERKLESS, D.D., LL.D.

SIR JOHN HERKLESS, whose death we regret to announce, was the son of an engineer in Glasgow; he was born on August 9, 1855, and educated in the High School before entering the University of his native city. His career as a student was varied, and his fellow-students did not think it outstanding. He not only studied arts, but also attended medical classes. Like some men who have

afterwards made their mark in life, he disliked mathematics, but was fond of philosophy, and finally he decided to study for the Ministry, and was duly licensed, though he obtained no degree from his *Alma Mater*. For a short time he lectured on English literature at Queen Margaret College, then became an assistant-minister until 1883, when he was appointed to the parish of Tannadice in Forfarshire.

The death of the eloquent Principal Cunningham made a vacancy in St. Mary's College, St. Andrews, and it was rumoured that Dr. Herkless would be appointed to the post (divinity). Prof. Mitchell, however, resigned his chair of Church history, and he was appointed, whilst Prof. Stewart, of Aberdeen, was made principal. About this time the strained relations with Dundee in regard to the medical school, and the claims of St. Leonard's Parish in connection with the College Chapel, gave the forceful new professor of Church history an ample field for polemics. He took the side of Dundee, and opposed the parish. Besides stray papers, he afterwards published two books, viz. "Francis and Dominic" and "Richard Cameron," whilst, along with Mr. (now Prof.) R. K. Hannay, he edited a volume of documents pertaining to St. Leonard's College, and four volumes on the archbishops of St. Andrews. He was chairman of the St. Andrews School for Girls Company. He was appointed principal of the University by Mr. Asquith on the death of the distinguished educationist, Sir James Donaldson.

Though not a man of original cast of intellect, Sir John Herkless had great versatility and shrewdness, and was not devoid of ambition (as he himself stated), his main field for advancement being politics. He was diligent in his duties as principal, but he had little time to make noteworthy advances. His lamented death on June 11 occurred after an operation, and whilst he was in the midst of plans for the improvement of the University.

THE death of MR. CHARLES E. RHODES is announced in *Engineering* for June 11, and will be regretted by a large circle who knew him through his activity in colliery developments. Mr. Rhodes was born in 1849, and died on June 7 last. Since December, 1873, he held the position of engineering manager for Messrs. John Brown and Co., Ltd., for whom he sank several shafts and developed a number of pits. He became a member of the Institution of Civil Engineers in 1890, and at various times was president of different institutions connected with mining. He was appointed a member of the Standing Committee on Mining in 1916, and joined the Coal Conservation Committee in the same year.

WE regret to note that the death of MR. WILLIAM SHELDON is recorded in *Engineering* for June 11 as having occurred on May 20. Mr. Sheldon was in his sixty-ninth year, and had been connected with the steam plough works belonging to Messrs. Fowler since 1879. He was president of the Leeds Association of Engineers in 1898-99

## Notes.

THE Linnean Society will be engaged to-day, June 17, in celebrating the centenary of Sir Joseph Banks, Bart., who died on June 19, 1820. On the death of Carl von Linné in 1778, Banks endeavoured to buy his herbarium, but that was acquired by Linné's son for the remainder of his short life. Five years later, when the herbarium was again for disposal upon the death of the younger Linné, Banks had changed his mind, for when the collections were offered he passed the offer to Dr. J. E. Smith, recommending the purchase, as it would be of great value to him as a young naturalist. On getting the herbarium Smith spent the winter of 1784-85 in collating his new acquisition with the Banksian collection, with the invaluable help of Jonas Dryander, Banks's factotum; then, after a tour abroad, Smith took counsel with his friends, and the Linnean Society came into being. Banks was chosen as honorary member immediately, and retained that position until his death. Besides continual gifts of books, the cast from Inlander's relief of Linné, which was the model for Wedgewood's plaque, and objects of natural history, he paid for the entire cost of illustration for the first volume of the Transactions. It is well that such liberal actions should be recalled to the memory of the present generation.

We have received from the secretary of the Rubber Growers' Association particulars of a competition which has been organised by the association with the view of extending the industrial uses of rubber. A sum of 500*l.* is offered for ideas and suggestions in this connection, the amount to be divided into the following awards, viz. one prize of 100*l.*, three prizes of 50*l.* each, ten prizes of 10*l.* each, and a sum not exceeding 1500*l.* to be divided amongst the remaining competitors whose suggestions are considered to be practical, according to the relative value of the proposals. Among the conditions of the competition it is noted that special value will be attached to ideas of a thoroughly practical nature, supported by detailed information likely to make them effective; and that the relative value of the suggestions which are deemed practical will depend upon the quantity of raw rubber which their adoption would absorb, special consideration being given to proposals likely to utilise rubber in large quantities. The most important condition, however, is that relating to the protection by letters patent of any process, method, or apparatus submitted by competitors; this regulation is too long to quote in detail here. Full particulars of the competition may be obtained from the Rubber Growers' Association (Department C), 38 Eastcheap, E.C.3.; the closing date of the competition is December 31 next.

THE Albert medal of the Royal Society of Arts for 1920 has been awarded to Prof. A. A. Michelson, For.Mem.R.S., professor of physics in the University of Chicago, and Nobel laureate for physics in 1907.

THE enterprise of the Royal Horticultural Society in holding a three-days' show at Cardiff on July 6-8 marks a new departure in the society's history. Not in the present generation has it held such a meeting

in the provinces, and it has now taken this step to foster the interest in gardening and the production of home-grown produce that it did so much to develop during the war period. The scientific section will contain exhibits showing how to identify and overcome the various garden pests, as well as displays of the various appliances used in repelling their attacks.

THE David Syme prize, with medal, for the year 1920 has been awarded to Mr. Frederick Chapman, palæontologist to the National Museum and lecturer in palæontology in the University of Melbourne. Mr. Chapman, before his first appointment in Australia, was known to a wide circle in London through his work under Prof. Judd and his association with Prof. T. Rupert Jones in the investigation of fossil Foraminifera. Foraminifera have always remained his special object of research, but he has published a large number of papers in all branches of palæontology, including a revision of the fossil fish-remains of New Zealand. Few men have rendered the results of their observations available with such zeal and regularity, and Mr. Chapman, from the date of his earliest papers, when he described the preparation of thin sections of minute objects for the microscope, has brought to his painstaking studies the enjoyment of an artist in his work.

At the anniversary meeting of the Linnean Society on May 27, the following officers and members of council were elected:—*President*: Dr. A. Smith Woodward. *Treasurer*: Mr. H. W. Monckton. *Secretaries*: Dr. B. Daydon Jackson, Prof. E. S. Goodrich, and Dr. A. B. Rendle. *Council*: Mr. E. G. Baker, Mr. H. Bury, Prof. Margaret Benson, Mr. E. T. Browne, Mr. Stanley Edwards, Prof. J. B. Farmer, Prof. E. S. Goodrich, Capt. A. W. Hill, Dr. B. Daydon Jackson, Mr. C. C. Lacaita, Mr. G. W. E. Loder, Mr. H. W. Monckton, Mr. R. I. Pocock, Dr. A. B. Rendle, the Rt. Hon. Lionel Walter, Baron Rothschild, Dr. E. J. Salisbury, Mr. C. E. Salmon, Miss A. Lorrain Smith, Lt.-Col. J. H. Tull Walsh, and Dr. A. Smith Woodward. The president has appointed Mr. E. T. Browne, Prof. J. B. Farmer, Mr. H. W. Monckton, and Mr. R. I. Pocock vice-presidents. Dame Helen Gwynne-Vaughan was presented at the anniversary meeting with the Trail award and medal, and Sir Ray Lankester with the Linnean medal.

A SUCCESSFUL meeting of the British Lampblown Scientific Glassware Manufacturers' Association, Ltd., was held on June 8 at the Abercorn Rooms, Great Eastern Hotel. Mr. Douglas Baird, vice-president of the association, who occupied the chair, in proposing the toast of "The B.L.S.G.M.A.," gave a short history of the formation of the association. The manufacturers who were members of the association were engaged in work which could be truly designated a "master-key industry," because there was no trade or profession that could be successfully carried on without the aid of one or other of the instruments manufactured by its members. The association was formed during the war because it was found by the Government that there was a great demand for all kinds of instruments for the fighting forces which previous to hostilities had been introduced into this country from abroad,

and more particularly from Germany. The Government experienced great difficulty in getting in touch with manufacturers, and it was at the suggestion of the Ministry of Munitions that the B.L.S.G.M.A. was formed. Mr. Baird emphasised the necessity of each member in the association uniting to their utmost in promoting and fostering the industry. He pointed out that it was only by united effort to turn out instruments of the highest class of manufacture that the country could hope to keep out the importation of foreign glassware.

SIR C. H. READ, in his presidential address delivered before the Society of Antiquaries, does not take an optimistic view of the prospects of archaeological research. While the late German Government lavished treasures on the Berlin museums, the British Museum, our one institution archaeological in its aims, is hampered by lack of funds. Again, the regulations against the export of specimens from countries under our control have proved to be ineffective. For example, specimens found in Cyprus are smuggled to any other art centre rather than to London, and the silver treasures from that island passed easily into the Pierpont Morgan galleries in New York. The same result of Government action is anticipated in India. The president is, however, scarcely fair in his strictures on the Indian Government. Why, he asks, are the Indian museums filled with statuary of the Buddhist age?—things which he believes are hated by Mussulmans and almost equally disliked by Hindus. He forgets that many of the Indian Mussulmans, being converts from Hinduism, have in a measure lost that hatred for representations of the human form which survives in orthodox cities like Cairo. Hindus have recognised Buddha as an incarnation of Vishnu, and the ignorant Hindu villager often worships a figure of the Master as a representation of some local deity, male or even female. But Sir Hercules Read is well justified in pleading for the development of excavation in Babylonia and in Egypt, in which latter country Prof. Flinders Petrie has done admirable work with very limited resources. He also wisely lays stress on the fact that, while our galleries abound in examples of art in its highest forms, we have comparatively little to illustrate the everyday social life of the populations which are now subject to our control.

THE tenth International Cotton Congress was held in Zurich on June 9-11. In the course of its proceedings a highly suggestive paper was read by Dr. W. Lawrence Balls, scientific expert and adviser to the Fine Cotton Spinners' Association, Ltd., Manchester, on "The Nature, Scope, and Difficulties of Research," in which he dealt with the foundation of research, the past and present scope of the research on cotton, the British organisation of cotton researches, and international research. The demand for scientific research, with the view of enlarging the possibilities of the industry, embracing not only the cultivation of the plant, but also every subsequent process in its utilisation, has been induced by various changes in recent years. There is a vast accumulation of experience in the cotton

industry, together with a small stock-in-trade of general knowledge. Most of the work of the first decade undertaken by the scientific workers will have to be spent in defining what the spinner knows, and then in reducing the incoherent mass of details to a small number of generalisations easy to grasp. The question of the method of utilisation of the results of research which may be condensed under the title of publication is summed up in a line: To ascertain the true facts, to conceal nothing known, and to take personal responsibility. There must be individualism in effort and communism in knowledge, which is put forward as the code of the pure scientific worker. With respect to a code of research for industry, the author insists on the need for individual effort, but also that after five years the industrial research worker and his employer-colleague shall make known the true facts ascertained, which, whilst giving full advantage to the business concerned, shall yet give fair and full assistance to the general advance of man's power over his environment.

In *Man* for May Mrs. M. E. Cunnington describes a curious stone mould found on the Worms' Head, Glamorganshire. It is made of two pieces of fine-grained red sandstone about an inch thick. On the corresponding sides of the two stones are matrices for casting four objects: a large ring ornamented with a raised pattern of S-like scrolls enclosed by two narrow rows of irregular chevrons or waved lines, a ring with seven star-like rays, a second ring, and another smaller with a raised pattern of waved lines or loops with seven points. It is suggested that this ornamentation has been designed with some reference to sun-worship, the disc, the rayed star, and the S scrolls being all well-known solar symbols derived from the wheel. From the objects found in association with these moulds it may be inferred that they belong to the Early Iron age. This part of the coast, though difficult of access by land, was easily reached by sea from other parts of Britain and from the Continent. The moulds may thus possibly have been introduced from abroad.

THE Oxford University Press has issued a revised edition of its General Catalogue, which was first produced in 1916. It is not only an excellent description of the varied activities of this great publishing institution, but it is also valuable as a fine example of scientific bibliography, and forms very interesting reading. The Press offers this valuable service to science and literature that the profits derived from school books and other more or less popular works are devoted to the publication of expensive volumes of permanent value which the ordinary publisher may hesitate to produce. One book, Woide's Coptic New Testament, published in 1799, is still on sale. There is an account of the "Dictionary of National Biography," the copyright of which was presented to the University by the family of its founder, the late George M. Smith. Preliminary work under the direction of Mr. H. W. Carless Davis is now in progress with the view of maintaining and extending its usefulness. A history, of course, is given of what is now called the "Oxford Dictionary," which since the

death of Sir John Murray in 1915 has been controlled by Dr. H. Bradley and Messrs. W. A. Craigie and C. T. Onions. Nine of the ten volumes are complete, and as steady progress in the tenth volume is being made we may soon look forward to the completion of this monumental work.

In the Annual Report of the Director of the Field Museum of Natural History, Chicago, for 1919, perhaps the most novel pages are those dealing with the work of the botanical laboratories established by Mrs. Stanley Field. Their main object is to make reproductions of living plants for exhibition in the museum. To accomplish this the plants are studied in the field, wherever they are best to be seen. Thus the first four and a half months of the year were spent in Florida, at a station of the U.S. Department of Agriculture, to secure studies and material for such plants as the coconut palm, the banana, the pineapple, and the Florida cycad. The most perishable parts were cast and coloured, and plaster moulds were made of other parts, formalin material packed and sent to the museum, and photographs, colour sketches, and detail studies secured for use after return. Reproductions were made of many other plants cultivated in the garden of the station. A set of tomatoes attacked by various fungi, then under investigation at the station, was reproduced, and pure cultures of the fungi were obtained with the view of making an enlarged model of each fungus for exhibition alongside the infected fruit.

Few works of the same size have had so wide an influence on geological thought as R. Liesegang's "Geologische Diffusionen," published in 1913. Applications of the author's views on zonal deposition are to be found, with excellent illustrations, in Professional Papers 107 (p. 156) and 104 (p. 45) of the U.S. Geological Survey. In the former case banded jasper-rock is considered; in the latter, the very common occurrence of bands of iron hydroxide. Messrs. Bastin and Laney, in Paper 104, have made useful experiments with interfusing solutions of ferrous sulphate and sodium hydroxide.

A COLOURED geological map of Western Australia, called a sketch-map, but none the less valuable to libraries, accompanies the Annual Progress Report of the Geological Survey of that State for 1918 (published 1919). Its scale, 1 in. to 50 miles, or about 1:3,000,000, is large enough to enable us to appreciate the immense extent of Nullagine (Late Pre-Cambrian?) beds in the north-west, with their auriferous conglomerates; the Jurassic fringe on the west coast; and the Cretaceous overflow on Palaeozoic strata in the south-east. An interesting case of serviceable limestone formed by capillary action in sand-dunes is described on p. 14 of the report.

A SUMMARY of the weather for the spring season, comprised by the thirteen weeks ending May 29, is given in the *Weekly Weather Report* issued by the Meteorological Office. Mean air temperature for the period was above the average in all districts of the

British Isles, the largest excess being  $3.2^{\circ}$  F. in England E. and  $2.9^{\circ}$  F. in England S.E. In Ireland the excess was not more than  $\frac{1}{2}^{\circ}$  F., and in Scotland it was only about  $1^{\circ}$ . At the close of the season the sheltered thermometer exceeded  $80^{\circ}$  F. in most of the English districts. The day-degrees above  $42^{\circ}$  F. were largely in excess of the normal over the whole kingdom, especially in England E. and in the English Channel, whilst the day-degrees below  $42^{\circ}$  F. were largely deficient everywhere, especially in the Midland Counties and in England E. and N.E. Rainfall was everywhere in excess of the normal, the greatest excess being 5.67 in. in England N.W. In the English Channel the excess was only 0.59 in., and in England S.E. and E. 0.63 in. and 0.67 in. respectively. The duration of bright sunshine was normal in Scotland N., but deficient in all other parts of the British Isles. In Scotland W. the deficiency was 109 hours, and in England N.W. and Ireland S. 91 hours.

THE second part of the current volume of the Proceedings of the Royal Irish Academy consists of a paper by the late Prof. J. A. McClelland and Mr. A. Gilmour on the electric charge on rain. The observations were made in a small quadrangle at the back of University College, Dublin, between January 1 and August 31 last year. The results for non-thunderstorm rain are that 73 per cent. of it was charged positively, and 84 per cent. of the electricity brought down was positive. The average charges brought down by the rain were 0.21 electrostatic unit positive and 0.08 negative per c.c. of water. The average vertical currents were  $1.6 \times 10^{-12}$  amperes per sq. cm. positive and  $0.5 \times 10^{-12}$  negative. Drops below  $0.08 \times 10^{-3}$  c.c. were always negatively charged, but there appeared to be no relation between the size of the drop and the magnitude of its charge. Thunderstorm rain was more highly charged than ordinary rain and about equally positive and negative. Snow was more often negative than positive, small hail always negative, and large hail always positive, the charges per c.c. exceeding those on ordinary rain and often those on thunderstorm rain.

In Publication No. 298 of the Carnegie Institution of Washington (1919) Messrs. E. L. Nichols and H. L. Howes, with the collaboration of Messrs. E. Merritt and D. T. Wilber and Miss F. G. Wick, give the results of a very exhaustive investigation of the fluorescence and absorption spectra of uranyl salts. The authors have examined a large number of simple and double salts, the influence of water of crystallisation and of crystalline form, and the polarised fluorescence of crystals at ordinary temperatures and at the temperature of liquid air. The results obtained at low temperatures are of particular interest, for under these conditions both the absorption and fluorescence bands, which at ordinary temperatures are so diffuse that it is difficult even to locate the positions of the maxima with great precision, are resolved into a number of comparatively sharp components the homologous members of which can be arranged in series having constant wave-number

differences. The authors arrive at the generalisation that resolution of the bands on cooling depends on the existence of regular crystalline structure; as an example of this, the broad bands observed in uranium glass are not further resolved on cooling to the temperature of liquid air. It is shown that many of the apparent shifts of the bands with change of temperature are to be referred to the relative enhancement or diminution of the components of the bands. A discussion of different types of phosphoscope is included as an appendix.

THE May lecture of the Institute of Metals on "Recent Progress in Thermo-Electricity" was delivered by Prof. C. A. F. Benedicks, of Stockholm University, on June 10, Engineer Vice-Admiral Sir George Goodwin, president, in the chair. Prof. Benedicks first gave a short summary of his theoretical views upon the metallic conduction of electricity. A consequence of this theory was that one has to conclude that even in a single homogeneous metal thermo-electric currents do occur, and not only when two different metals are present. Prof. Benedicks gave a concise demonstration of the most important experimental evidence of the truth of this conclusion, utilising for this purpose various metals. In liquid mercury it had been possible for him definitely to prove the existence of thermo-electric currents, thus disproving the negative results of previous workers. A consequence of what the lecturer termed his "homogeneous thermo-electric effect" was that there must exist the reverse effect, the "homogeneous electro-thermic effect," including as a special case the well-known Thomson effect. The reality of this effect was duly made clear. A specially interesting demonstration was of a new rotating thermo-electric apparatus made entirely of copper and rotating in a magnetic field, the driving force originating solely from unequal heating (by means of a tiny gas jet) of thin strips of copper. The point at which the new knowledge brought forward by Prof. Benedicks might have some practical interest lay in the possibility of reducing the thermal conductivity of metals by insulated subdivision into fine wires without impairing the electrical conductivity. The demonstrations were carried out with the aid of a galvanometer kindly provided by the Cambridge and Paul Instrument Co.

DRS. A. HARDEN AND S. S. ZILVA, continuing their work on accessory food substances, publish in the *Biochemical Journal* for April a paper entitled "The Antiscorbutic Requirements of the Monkey." The authors point out that as the clinical symptoms of scurvy induced in the monkey are similar to those occurring in human subjects suffering from a similar disease, the monkey has been more and more extensively employed as an experimental animal. On the other hand, comparative scarcity, high price, and greater duration of experiment render the monkey in many instances less suitable than the guinea-pig for the study of experimental scurvy. In order to translate results obtained with one animal into the

terms of the other Drs. Harden and Zilva have attempted to establish a quantitative relationship, as regards dose and time, between them. In the work described five monkeys fed on a scorbutic diet of rice, wheat germ, salt mixture, and butter received respectively 0.5 c.c., 0.75 c.c., 1 c.c., 2 c.c., and 5 c.c. respectively of orange juice daily. The animals receiving only 0.5 c.c. or 0.75 c.c. developed scurvy with fatal results, whilst the one receiving 1 c.c. only suffered from a mild attack, and in the cases of 2 c.c. and 5 c.c. doses the animals remained quite healthy. The authors conclude that the minimum daily dose of fresh orange juice for a monkey (weighing 2-3 kilos.) is 1-2 c.c., which is approximately the amount required by a guinea-pig weighing 300-400 grams. Whilst, however, the minimum dose of antiscorbutic required by the two animals is of the same order, the disease develops in the guinea-pig in three weeks, but only after two months in the monkey.

IN pursuance of his campaign for recognition as a pioneer inventor of oil engine cycles, we have received a number of documents from Mr. Herbert Akroyd Stuart, formerly an assistant at Finsbury Technical College and now of Claremont, in Western Australia. One type of Mr. Stuart's engines has been manufactured on a large scale by Messrs. Hornsby, of Grantham. The cycle in this engine is carried out in a cylinder fitted with a hot bulb, the walls of which are kept hot during ordinary working by the heat developed during explosion. Air is drawn into the cylinder through a side-port in front of the bulb, and oil fuel injected into the bulb during the suction stroke. Compression follows, and at the end of this stroke ignition takes place due to the temperature developed by the hot walls and by the compression. Mr. Stuart's other cycle has not been worked commercially to any extent. It also is carried out in a hot-bulb cylinder, and consists in drawing in air only during the suction stroke, compression of this air, and injection of oil fuel into the bulb during the early part of the working stroke, the temperature being then sufficient to cause the oil to burn readily. Both these cycles were invented in 1890. Mr. Stuart objects, and rightly so, to the name "semi-Diesel" being applied to engines working on these cycles. He has first claim as the inventor of hot-bulb engines, and the term "Akroyd cycle" would be suitable. The Diesel engine proper has no hot bulb; air alone is compressed to a very high pressure (500 lb. per sq. in.), and the temperature due to compression alone is sufficient to ignite the oil fuel which is injected during the early part of the working stroke. The term "Diesel engine" might continue to be used for such engines. The high pressures used in the Diesel engine and the extensive use of the engine for marine purposes gave rise to a demand for an engine working with lower pressures, and the past few years have seen a great development in hot-bulb engines. Someone acquainted with Diesel engines and probably unaware of Mr. Stuart's prior work named these "semi-Diesel," a term which may very well be dropped in favour of Akroyd engines, if only for the sake of historical accuracy.

### Our Astronomical Column.

THE MASSES OF THE STARS.—The mass of a star is perhaps its most important element, but it is one that can be ascertained only in exceptional cases. Prof. H. N. Russell, in a paper read at the twenty-first meeting of the American Astronomical Society, gathered together all the evidence, direct and indirect, on the subject, grouping the results by spectral type.

Method I. is the usual one for visual binaries the orbits and parallaxes of which are known; Method II. is similar, where the parallax and relative motion, but not the orbit, are known; Method III. is from spectroscopic binaries where both spectra are shown, a mean inclination being assumed; and Method IV., the vaguest of all, derives the parallaxes of binaries from their proper motions.

The resulting mean masses for the pairs of stars are:—

Spectrum	I.	II.	III.	IV.
B <sub>2</sub> -B <sub>3</sub> ... ..	—	10.4	17.5	7.1
B <sub>2</sub> -A <sub>5</sub> ... ..	5.9	3.0	4.0	8.4
F-G	—	—	3.9	8.1
K-M } giant {	—	—	—	9.8
F-F <sub>0</sub>	3.5	3.4	—	2.5
F <sub>0</sub> -K <sub>0</sub> } dwarf {	1.8	1.4	—	0.7
K <sub>0</sub> -M	0.7	1.0	—	—

The sun's mass is taken as 1.

The following formulæ are given for the hypothetical parallax ( $h$ ) of systems of mean distance  $a$ , and period  $P$ :  $h = f \frac{a^2}{P^2}$ ; or where  $s$  is the apparent distance and  $w$  the apparent relative motion, in seconds of arc per annum,  $h = 0.409fs^2w^2$ .

The constant  $f$  has the value 0.50 for all giant stars, 0.58 for dwarfs of spectrum A, 0.72 spectrum F, 0.86 spectrum G, 1.00 spectrum K, and 1.14 spectrum M. The probable error is given as 12 per cent. where the first formula can be used, and as 22 per cent. in other cases.

THE PLANET JUPITER.—The Rev. T. E. R. Phillips, director of the Jupiter section of the British Astronomical Association, contributes an interesting article on the planet to the June number of *Scientia*. After giving a *résumé* of Jovian phenomena during the last twenty years, including the red spot and the south tropical disturbance, Mr. Phillips notes the startling change in the aspect of the planet which took place early in 1919; the disturbance and the red-spot hollow both practically disappeared, though the spot itself survived. Discussing the physical condition of Jupiter, he notes the similarity to the sun in density, in varying rotation periods according to latitude, and in the dark belts which are comparable with the spot zones. He suggests that the red spot may indicate a vast cyclonic movement in the atmosphere, noting that this view would explain the rapid passage of the dark matter of the tropical disturbance round the spot when the two are in conjunction. He notes, in conclusion, the importance of Jovian study from the point of view of cosmogony, since it illustrates a stage intermediate between the solar condition and the earliest geological periods.

PARALLAX WORK AT THE SPROUL OBSERVATORY.—The list of stars with known parallaxes is being rapidly extended, thanks to the extensive organised campaign carried on by many observatories which possess large equatorials. Dr. Miller, of the Sproul Observatory, has published a useful list of fifty observed parallaxes (*Proc. Amer. Phil. Soc.*, vol. lix., No. 2). Five stars on the list have parallaxes above 0.1", viz. W.B. (1) V. 592 = 0.146",  $\theta$  Argus = 0.121",  $\iota$  Persei = 0.120", Lalande 17161 = 0.104", and W.B. (1) IV. 1189 = 0.103". The

values found for  $\gamma^1$  and  $\gamma^2$  Andromedæ are 0.021" and 0.005"; those for the preceding and following components of the wide pair 16 Cygni are +0.037" and +0.018". In each of these systems the true parallaxes of the components are presumably the same. The discordances are a measure of the probable errors, which in each case are of the order of 0.01".

An interesting feature is the closeness with which the new figures verify many of Prof. H. N. Russell's hypothetical parallaxes, deduced from assumptions regarding the masses of binaries.

### Nuclear Constitution of Atoms.<sup>1</sup>

By SIR ERNEST RUTHERFORD, F.R.S.

THE idea of the nuclear constitution of atoms was developed from an examination of the scattering of swift  $\alpha$ -particles in passing through matter, and the advance afterwards made was due to the proof by Moseley of the close connection between the atomic number of an element and the nuclear charge. The accurate determination of the nuclear charge is of prime importance. Recent unpublished experiments by Mr. Chadwick in the Cavendish Laboratory indicate that the nuclear charge on an atom in fundamental units is equal to the atomic number within an accuracy of about 1 per cent. It follows that there is a region surrounding the nucleus where the law of the inverse square holds accurately. The problem of the constitution of the atom divides itself naturally into two parts: one the arrangement of the external electrons on which the ordinary chemical and physical properties of the atom depend, and the other the constitution of the nucleus on which depend the mass of the element, the possibility of isotopes, and radio-activity. The nucleus is composed of positively charged units and negative electrons in very close combination, and estimates of its dimensions are possible from a study of the collision of  $\alpha$ -particles with light atoms. Close to the nucleus there is a rapid change in the magnitude and direction of the forces, probably in part connected with the deformation of the nucleus structure under the intense forces which arise in a close collision.

Unless the nuclei are very stable, it is to be anticipated that they would be deformed, and possibly broken up, as a result of a direct collision with swift  $\alpha$ -particles. In previous experiments evidence was given that long-range particles resembling hydrogen atoms were liberated by the passage of  $\alpha$ -particles through pure nitrogen. New experiments have been made to determine by a modified method the nature of these particles by bending them in a magnetic field. The amount of deflection of the particles liberated from the nitrogen of the air was shown to be the same as for H atoms arising from a mixture of hydrogen and carbon dioxide. This showed definitely that hydrogen is one of the products of the disintegration of the nitrogen atom, and is one of the original components of the nitrogen nucleus. The possibility that the long-range particles are atoms of mass 2, 3, or 4 carrying a single charge may be definitely excluded.

The deflection in a magnetic field of the short-range particles which are liberated from nitrogen and oxygen, and were originally assumed to be recoil atoms of these elements, is not only much greater than that to be expected for such recoil atoms, but is also greater than the  $\alpha$ -particle but less than the H atoms liberated from a mixture of hydrogen and carbon dioxide.

<sup>1</sup> Synopsis of the Bakerian Lecture delivered before the Royal Society on June 3.



There is evidence that these particles are atoms of mass about 3, carrying two charges. Consequently the atom of nitrogen can be disintegrated in two ways by collision with  $\alpha$ -particles: one by the escape of an H atom, and the other by the expulsion of mass 3, and both processes occur independently. Atoms of mass 3 are also released from oxygen atoms, but H atoms cannot be detected.

It may be concluded, therefore, that atoms of mass 3, carrying two positive charges, are components of the nuclei of nitrogen and oxygen.

This new atom is to be regarded as an isotope of helium, and should give nearly the same spectrum. The energy of motion of the atom of mass 3 expelled from nitrogen and oxygen is about 8 per cent. greater than the original energy of the  $\alpha$ -particle, showing that energy is liberated as a result of the disintegration. The atoms of mass 3 probably consist of three hydrogen nuclei with one binding electron, and atoms of helium of four hydrogen nuclei and two electrons. Apart from hydrogen itself, these atoms are important secondary units in the building up of atomic nuclei. In the light of the new experimental evidence, examples are given of the possible modes of formation of isotopes and possible structures of nitrogen and oxygen nuclei are considered. It is pointed out that close combinations may exist of H nuclei and electrons, giving rise to atoms of zero nuclear charge, and that such a conception is needed to explain the evolution of the heavy elements.

### The Rockefeller Gift to Medical Science.

AS was announced in the *Daily Mail* of June 11, the Rockefeller Foundation for Medical Research has made the generous gift of a sum of 1,205,000l. for the advancement of teaching and research in the Medical School of University College and Hospital. Owing to the inconsiderate and premature manner in which the statement was made public, it is natural that some mistakes should have been made and the objects of the gift in certain respects misunderstood.

The reason for the delay in making a public announcement is that the Senate of the University of London has as yet had no opportunity of formally accepting the gift. When this had been done it was the intention to make it public through appropriate channels and in such a way that the people of England might appreciate the intention of the donors to give a manifest proof of the friendliness of their feelings towards the work that we are doing here and their appreciation of its value. We have reason to believe that they particularly wish this aspect to be emphasised. It should be remembered that the object of the Rockefeller Foundation is "the welfare of mankind," so that its benefits were not intended to be confined to the United States. The members of the Foundation desire it to be regarded as entrusted to them for this purpose, and the present endowment is not meant in any way as a charitable gift. In view of statements to the contrary, it is necessary to make it plain that no conditions are attached, and that the recipients are left free in a very wide sense to make the best use of the money for the benefit of medical science, and especially as to the details of its application. It will naturally be understood that the manner of its use has been the subject of much discussion between representatives of the Rockefeller Foundation and the institutions receiving the gift.

With regard to the objects to which it is proposed to devote the endowment, a few words on the history of the negotiations may be of interest. Towards the end of last year two representatives of the Rockefeller Foundation, Dr. Wickliffe Rose (General Director of

the International Health Board) and Dr. Pearce (Adviser in Medical Education to the Foundation), arrived in London. Before proceeding further they called at University College. In the absence of Prof. Starling, they were received by the present writer, whom they gave to understand that they had come to make inquiries into the conditions of medical education in London. They were accordingly informed of the recent creation of medical and surgical "units," of their situations and the names of various gentlemen associated with these units from whom they might obtain further information. This they proceeded to do. Early in the present year they made another visit to University College with definite proposals, and were seen by Prof. Starling and Prof. Elliot Smith, who showed them what was necessary to be done for the adequate provision of instruction and research in the fundamental sciences of anatomy, physiology, and pharmacology. It was clear to them that the most pressing need was the building of a new anatomical institute, although the medical sciences themselves naturally required the larger proportion of any proposed gift.

In April four representatives of University College and Medical School visited the United States for the purpose of further conference. These were the Provost (Sir Gregory Foster), Dr. Blacker (Dean of the Medical School), Prof. T. R. Elliott (professor of medicine), and Prof. Elliot Smith (professor of anatomy). On their return they brought back the definite offer of this extremely generous gift, and speak with the greatest appreciation of the friendliness of the manner in which they were received, the spirit in which the offer was made, and in which it was impressed upon them that it should be accepted.

Owing to the premature publication of the scheme it was necessary to call a general college meeting on Friday last, at which the Provost made a statement of its actual terms. In the words of the Rockefeller Executive Committee, they are as follows: "(1) An institute of anatomy. (2) Increase of clinical facilities. (3) Clinical laboratories planned. (4) Increased maintenance costs. (5) Closely unified administration." The Medical School will receive 835,000l. and the College 370,000l. Further details of the ways in which it is proposed to utilise the money will be duly announced. At this meeting Prof. Elliot Smith pointed out that anatomy is to be understood as including in its purview the microscopic structure of the tissues, embryology, and a study of the factors governing the development of form. It is further to be hoped that the working of the scheme will involve a much closer co-operation between the College and the medical departments, to the advantage of both.

It is perhaps advisable to direct attention to the fact that the gift is for the purpose of improving medical education and research. At the same time the hospital, as an institution for the cure of patients, will benefit indirectly, although doubtless its working expenses will be increased owing to the enlargement proposed.

W. M. BAYLISS.

### The Permanent Value of University Benefactions.

AN account of the opening of the new building of the Department of Applied Statistics and Eugenics at University College, London, presented by Sir Herbert Bartlett, was given in last week's NATURE. The speech made by Prof. Karl Pearson in seconding the vote of thanks to the donor contains certain truths which have a wider application than to the immediate audience, and we therefore reproduce it

in the hope that it will help to force the present difficult situation of the universities upon the attention of the public.

Henry VI., 1422-61. You probably all think of him as a weakling, the monarch whose forces were cleared out of the best part of France by Joan of Arc—a man naturally almost imbecile, and dominated by his Queen and a succession of dukes, and finally deposed by the victorious House of York. I feel otherwise towards him. For forty-five years I have worked under his image in a niche of my library. On my rare visits to Cambridge I would raise my hat to his statue on the front lawn of the college he founded. He may have been a poor King, but I owe the six most useful years of my life to the freedom his benefaction gave me to travel and to study. Despised as a King, there are many of us who respect our Royal benefactor as a scholar and a gentleman.

The spirit in which the members of old Cambridge colleges regard their founders and benefactors is one that should take deeper root in our new universities.

It is not merely the recognition of the name, but the insight that shall appreciate what the benefactor desired us to achieve, and the determination of successive generations that the purpose of the benefaction shall be carried out.

There are only too many ways of disposing of money! In 1441 it might be done by wars in France, by endowing monasteries to expedite the passage of your soul through purgatory, but those who founded or extended great centres of learning have remained in men's affection for all time. Nowadays you can dispose of your money to party funds or to charities; your name will survive just as long as your money is unspent or you have more to give. But the man who gives generously to a great academic institute will, if he chooses wisely, be certain of an ever-green memory.

In this institute we have had a number of benefactors, but three stand out for special mention on such an occasion as the present. The Worshipful Company of Drapers, who from 1903 onwards have assisted one section of our enterprise. Sir Francis Galton, who came of a family which has founded no fewer than three academic chairs, the Sedleian, the Savilian, and my own chair. Under his inspiration we work, and we are more than pleased to be better able to keep his memory fresh in our new buildings here than has been possible in the past in our cramped and temporary homes:

Lastly, we come to the benefactor whose benefaction is the subject of our gathering to-day. To him not only I, but every member of my staff feel daily gratitude for providing us with a more fitting, and, I will add, a more healthy environment, than we ever imagined would be ours, and I trust that the tradition will remain long after I have ceased to share the comfort of this building and the possibilities for the studious life it provides.

Those who have gone round this laboratory will have noted that we try to keep before us not only the portraits of great leaders of thought, but the portraits of the men who have made our work possible, and in this respect I should hope to be pardoned if I reminded Sir Herbert Bartlett of how deeply we should all appreciate the addition of such a memorial of his gift, so that we may have his form as well as his good works before us.

The war has left all academic enterprise stranded. In 1914 we could have equipped and fitted this building from basement to top story. Our contracts were rescinded, and for five years this laboratory was used as a military hospital. At present the fine buildings Sir Herbert Bartlett has provided lie to a large extent

unoccupied. In 1871 the German nation made the extension of old and the founding of new universities a first claim on their war indemnities. In 1920 we hear no suggestion that from our universities a new national life has to spring, and that if they are to accomplish their task it can only be if the State and private friends come to their help in the present critical state of affairs. In this respect we can only trust that others will be as wise both for the present and for the future as Sir Herbert Bartlett has been. The winning of the war has been attributed in succession to many causes. One factor is rarely referred to, namely, the unselfish way in which the academic staff of university after university gave up their academic repose, broke through all their scholarly studies and their scientific researches, and where they could not sacrifice their lives, at least sacrificed many of their best years of work for national service. Voluntary, and unpaid, and unpayable gifts for national welfare! It is absurd that the universities should have to prate of such labours; but here is the fact, regard it in what aspect you like, that with a greater task than ever before them, they are left with far less power to carry it out than they had before the war, and it is that knowledge which makes us the more deeply grateful to the special benefactor whom we wish to honour in this vote of thanks. He saw our necessity and responded to it.

### The Imperial Entomological Conference.

THE Committee of the Imperial Bureau of Entomology may be congratulated on the success of the Entomological Conference which met on June 1-11 in the Linnean Society's rooms, Burlington House, London. The conference was attended by twenty official delegates representing most of the British Dominions, Colonies, and Protectorates, as well as by members of the committee of the Bureau, while a number of entomologists were invited to the meetings and discussions which occupied most of the appointed days. At the opening of the conference the delegates were received by Viscount Harcourt, chairman of the committee, and business meetings were held on the first and final days. On Friday, June 4, the conference visited the Rothamsted Agricultural Experiment Station in conjunction with a meeting of the Association of Economic Biologists; an account of this interesting day appeared in last week's NATURE (p. 464). On Tuesday, June 8, the members journeyed to Oxford, and on Thursday, June 10, to Cambridge. Prof. E. B. Poulton acted as host on the former, and Sir Arthur Shipley on the latter occasion. While the entomological collections in the University museums were the chief objects of interest, time was found for brief inspection of some features of the historic cities; for example, after entertaining the conference to lunch in Christ's College, Sir Arthur Shipley took the Overseas delegates into the rooms occupied ninety years ago by Charles Darwin.

Of the meetings held on the other five days of the conference it may be said that several subjects of much importance and of general interest were well and earnestly discussed. On the morning of June 2, under the presidency of Dr. R. Stewart MacDougall (Edinburgh), Mr. C. P. Lounsbury (Entomologist to the Union of South Africa) spoke on "Legislation in Regard to Plant Pests in the British Empire," insisting that the official entomologist should have authority to draft and enforce regulations against the introduction of plants which might harbour harmful insects; he advocated the drastic exclusion of such plants except in certain special cases, and expressed the opinion that little or no reliance can be placed on

certificates of freedom from pests—a view afterwards supported by several others who took part in the discussion. Mr. H. J. Elwes, however, remarked that a long experience in cultivation had convinced him that needless interference with freedom of import had sometimes been exercised by the authorities. On the chairman's suggestion, a sub-committee was appointed to consider the establishment of an Empire Convention on the subject.

"The Education of Economic Entomologists," the subject for discussion at the next morning meeting presided over by Prof. Poulton, was introduced by Prof. H. Maxwell Lefroy (Imperial College of Science). Prof. Lefroy advocated the establishment of entomology as a subject independent of general zoology; and, describing the courses in his own college, emphasised the necessity of a broad scientific training in physics, chemistry, and biology before the specialised entomological work could be profitably taken up; men with exceptional aptitude, however, might be admitted direct to advanced entomological study. The discussion was continued by Dr. R. J. Tillyard (Nelson, N.Z.). Dr. R. Stewart MacDougall (Edinburgh), Mr. F. Balfour Browne (Cambridge), Prof. R. Newstead (Liverpool), Prof. G. H. Carpenter (Royal College of Science, Dublin), Prof. R. D. Watt (Sydney, N.S.W.), and Mr. F. V. Theobald (Wye). While some doubt was expressed as to the advisability of divorcing entomology from general zoological study, there was general agreement as to the need of a sound and comprehensive scientific training, and several of the speakers insisted further that all entomologists in direct contact with cultivators ought to have practical knowledge of farm or garden work.

On Monday morning, June 7, Sir Daniel Morris in the chair, Mr. H. A. Ballou (Entomologist to the Department of Agriculture for the West Indies) opened a discussion on "The Resistance of Plants to Insect Attacks." He believed that in many cases perfectly healthy plants do not afford the best possible conditions for the life of sucking insects, while the food supply derived from weak or diseased plants may stimulate insects to abnormally quick growth and prolific reproduction. This view was supported by the infestation of thrips on cocoa-trees in the West Indies. Prof. R. D. Watt emphasised the possibility of finding strains of cultivated plants immune from insect attack, analogous to those now well known in certain cases as immune from fungus pests. Mr. C. C. Gowdey (Uganda) considered good cultural methods as of great importance in maintaining the resistant conditions.

A cognate subject, "Artificial versus Natural Methods of Control of Insect Pests," occupied the conference on Wednesday morning, June 9, when Prof. R. Newstead presided. Mr. F. W. Ulrich (Trinidad) opened the discussion with an account of various measures adopted in the West Indies, of which the distribution by means of spraying machines of fungus spores for the destruction of cercopids on sugar-cane was the most remarkable. Dr. Tillyard regarded spraying with insecticides as an imperfect palliative, and looked hopefully for results in poisoning aphids and scale-insects from the inoculation of trees with such substances as copper sulphate. Mr. F. Balfour Browne uttered a warning against the possible danger of introducing parasitic insects into new countries in order that they may prey upon previously introduced plant-feeding insects, but Prof. H. Maxwell Lefroy and Dr. A. D. Imms regarded any danger from this now-established practice as remote.

Several interesting papers on more special subjects were read. On the afternoon of Monday, June 7, Mr. G. E. Bodkin gave his experience of the insect pests of British Guiana, and dwelt on the difficulty of con-

trolling sugar-cane insects because of their habits of migration. On the same occasion Mr. F. W. Ulrich described the insect pests of Trinidad, and Mr. H. A. Ballou contributed a general review of conditions in the West Indies. On the afternoon of June 9 Dr. MacDougall lectured on "Insects in Relation to Afforestation," with lantern illustrations, pointing out the bearing of the feeding habits of common British timber- and bark-beetles upon practical questions of forest management. A discussion involving the uniformity of habit among insects of the same species in all parts of its range was carried on by Mr. C. F. C. Beeson (India) and Dr. Munro (Board of Forestry); the latter expressed regret that the Scottish and English Scolytidae follow the rules laid down in the classical German text-books of forest entomology. Mr. F. A. Stockdale (Ceylon) followed with an account of the insect pests of tea in that island. On the afternoon of Wednesday, June 2, when Sir David Prain took the chair, Mr. H. H. Ballou read a paper on "Cotton Pests," dwelling particularly on the boll weevil and the pink bollworm, the latter of which caused a loss of 10,000,000. in Egypt in the year 1917. Cotton insects are controlled by destroying at the end of the season all material in the field in which the species might survive until the next season. Mr. H. H. King described the organisation of entomological work in the Anglo-Egyptian Sudan, and stated that nine field laboratories under the charge of trained entomologists would be necessary for the proper working of the area.

Of the special questions discussed the most noteworthy was the tsetse-fly problem, considered at the meeting on Saturday morning, June 5, appropriately presided over by Sir David Bruce. Several entomologists from Africa spoke, including Messrs. R. W. Jack (South Rhodesia), Dr. A. May (North Rhodesia), and Mr. Li, Lloyd and Dr. G. D. H. Carpenter (Uganda). An experiment as to the effect on the fly of the clearance of "big game" from a district in Rhodesia is now being tried. The opinion was expressed that the result of this will be disappointing, as mammalian blood forms, as a rule, only a small proportion of the food-supply of Glossina. Dr. Carpenter informed the meeting of the success which had followed the erection of inclined screens, under which hundreds of puparia are found; this means of control was suggested by an observation of the large number of puparia present in the shelter of a blown-down tree.

The conference concluded on Friday, June 11, with a business meeting, at which several resolutions were passed; these may be briefly summarised. (1) A conference should be held in London every five years. (2) The Imperial Bureau of Entomology should be established permanently; the cessation or curtailment of its work would be deplorable. (3) The Governments contributing to the expenses of the Bureau should be urged to guarantee their contributions. (4) The funds at present contributed for the upkeep of the Bureau are inadequate; they should be increased so as to provide an income of at least 13,000. a year. (5) The Colonial Secretary should be requested to establish a provident fund for the Bureau staff. (6) The director and committee of the Bureau should have full power to exercise their discretion as to the scope and contents of the publications and the expenditure involved. (7) The director should encourage members of the staff to pay attention to particular groups of insects, especially those for the identification of which no specialist is available. (8) The provision of an adequate number of trained men to carry into effect existing plant-import legislation is of more immediate importance than the revision or extension of such legislation.

Members of the conference had the privilege of attending meetings of the Linnean, Zoological, and Entomological Societies, as well as the Staff Conversation at the Natural History Museum. These gatherings, in addition to the three whole-day excursions to Rothamsted, Oxford, and Cambridge, gave welcome opportunity for informal discussion and pleasant social intercourse. Much gratification was felt and expressed at the presence for the first two days of Dr. L. O. Howard, Entomologist of the U.S. Department of Agriculture. His brief, pointed remarks at some of the discussions were much appreciated; he deplored some recent attempts to destroy "entomology" as a specific economic subject by dividing its subject-matter between "parasitology" and "phytopathology." All who participated in the conference appreciated the untiring efforts of Dr. G. A. K. Marshall and Dr. S. A. Neave, of the Imperial Bureau, who before and during the meetings did their utmost for the success of the gathering.

On the evening of the closing day the members of the conference were entertained to dinner at Lancaster House by H.M. Government, Viscount Harcourt presiding. Thus was pleasantly and fittingly demonstrated the increasing recognition of the importance of the study and practice of science in relation to the interests and industries of the Empire.

G. H. C.

### The Selous Memorial at the Natural History Museum.

THE movement started in 1917 to perpetuate the memory of the late Capt. F. C. Selous, D.S.O., by a national memorial achieved its aim on Thursday, June 10, when Mr. Edward North Buxton, vice-chairman of the Memorial Committee, himself a great hunter in his day, in the unavoidable absence of the chairman, the Right Hon. E. S. Montagu, M.P., unveiled at the Natural History Museum, South Kensington, a bronze bust of Selous—the work of Mr. W. R. Colton, R.A.—before a distinguished and representative gathering.

The bust is mounted in a niche of grey granite from the Matoppo Hills, the burial-place of Cecil Rhodes and Sir Starr Jameson, and is the gift of the Union Government of South Africa. It was brought to this country by the Union Castle Line free of all charges. Below the bust is a bas-relief, also in bronze, depicting a lion and lioness, and in the distance an elephant, a situtunga, and other big-game animals, symbolical of the interests of the great sportsman and explorer. The granite bears the inscription: "Captain Frederick C. Selous, D.S.O., hunter, explorer, and naturalist. Born 1853. Killed in action at Beho-Beho, German East Africa, 4. 1. 1917."

Mr. Buxton in his speech referred to the qualities of Selous which had endeared him to so many friends, and summarised these when he said that "Selous was a great hunter, and a still greater gentleman." On behalf of the committee he asked Viscount Grey of Fallodon, K.G., and the other trustees of the museum to accept the memorial and to preserve it in the museum for all posterity.

In his reply Lord Grey stated that in the museum, which was a national institution, this national memorial would be kept and honoured as a memorial to one who was a great explorer, a great traveller, a great hunter, and, besides that, a most brave and single-minded and attractive character.

The King sent a message to the effect that he felt that no more appropriate place than the Natural History Museum could be selected for a memorial to Capt. F. C. Selous.

It is indeed in the fitness of things that this memorial should have found a permanent place in the museum; for, next to his own home, there was no place in England which more attracted Selous than the museum, and when he was in this country he seldom kept away from it for more than a week; sometimes he was a daily visitor.

A guard of honour composed of officers and men of the Legion of Frontiersmen, many of whom had served with Selous in East Africa, and a detachment of the Kensington Division of Boy Scouts were present.

The response to the committee's appeal for funds for the memorial has been so widespread and generous that they have been able to provide a sum of money for the foundation of a substantial Selous scholarship at his old school, Rugby, on the basis that preference will be given at each election to the sons of officers who have fallen in the war, and in this connection

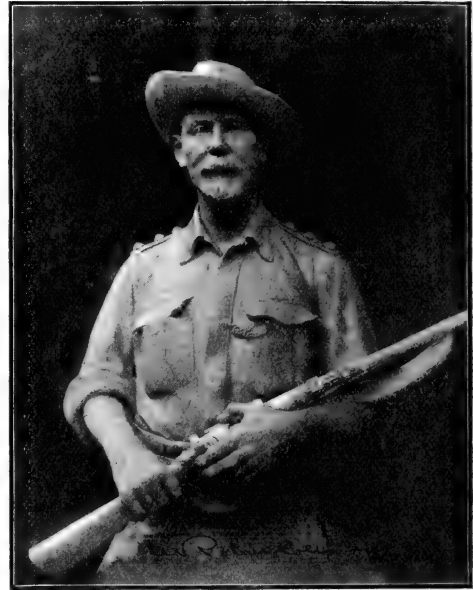

The Selous Memorial Bust in the Natural History Museum. On the right hand side of the memorial, not shown here, is the following inscription:—"Captain Frederick C. Selous, D.S.O., hunter, explorer, and naturalist. Born 1853. Killed in action at Beho-Beho, German East Africa, 4.1.1917."

it is with special satisfaction that we learn that in the examination for the scholarship a love and knowledge of natural history on the part of the candidate will be the deciding factor.

A few words may be said respecting Mrs. Selous's gift to the nation of her husband's splendid collection of big-game trophies and of birds' eggs, a gift for which Viscount Grey, on behalf of the trustees, conveyed to the donor his warm thanks, and at the same time expressed his high appreciation of its value and importance.

The collections have now been received at the Natural History Museum, and the big-game specimens are in course of being catalogued by Mr. Guy Dollman. We understand that it is the intention of the trustees to publish this catalogue, a work which cannot fail

to be of abiding interest to naturalists and sportsmen. The collection consists of 550 specimens—the greater part from South and East Africa—of splendid heads. It also includes nineteen magnificent lion-skins and a skull of the South African white rhinoceros—an extinct species—with exceptionally fine horns.

The collection of birds' eggs consists of 7010 specimens obtained in Great Britain, Europe, and Asia Minor. The great feature of the collection is that Capt. Percival personally took every egg from the nest himself. He would never accept any egg or clutch of eggs offered to him by a friend, nor would he purchase one from a dealer.

At the summons of a friend announcing the discovery of some rare bird's nest he would often travel very long distances, e.g. from one end of the British Isles to the other, in order that he might personally identify the parent birds and personally take the eggs from the nest. For this reason, no less than for the amazing neatness and methodical care with which it was arranged, to say nothing of its comprehensive range, the collection is a particularly valuable one.

## University and Educational Intelligence.

**BIRMINGHAM.**—On the advice of Sir John Cadman, whose appointment as a technical adviser to the Government on matters relating to coal and petroleum is announced, the department of mining is to be re-organised and extended. In addition to the new professor of mining there is to be an assistant-professor of petroleum technology. It is hoped that Sir John Cadman will still retain some connection with the faculty of science.

Prof. F. W. Burstall has been elected dean of the faculty of science, to succeed Sir John Cadman.

**CAMBRIDGE.**—As briefly announced last week, a scheme for endowing a school of biochemistry has been approved by the High Court of Justice, and has now been submitted to the University by Sir Jeremiah Colman, Bart., on behalf of the trustees of the late Sir William Dunn, Bart. The residuary estate of Sir William Dunn was left in trust for certain charitable purposes, including the alleviation of human suffering. The trustees propose, with that object in view, to encourage and endow with the substantial sum of 160,000*l.* the study of biochemistry, one of the fundamental sciences of medicine, the progress of which is essential to the advance of medical knowledge. Having regard to the fact that the study of biochemistry in this country had its first beginnings in Cambridge, and is at present being carried on there without endowment under Prof. Gowland Hopkins, the trustees offer the University 165,000*l.* to found the Sir William Dunn School of Biochemistry. Of this sum they allot 25,000*l.* to endow a professorship and 10,000*l.* to endow a readership in biochemistry, the balance to be used in erecting and equipping an institute of biochemistry and in providing funds for its maintenance and upkeep and an endowment for research work.

This munificent benefaction is a most pleasing tribute to the work of Prof. Hopkins and his colleagues.

Dr. T. G. Adami, Vice-Chancellor of Liverpool University, has been elected honorary fellow of Jesus College.

Mr. J. E. Littlewood, Trinity College, has been appointed Cayley lecturer in mathematics, and Mr. J. H. Grace, Peterhouse, has been re-appointed University lecturer in mathematics.

The Special Board for Mathematics has recommended the substitution of thermodynamics for

elementary optics in Schedule A of Part II. of the Mathematical Tripos.

In connection with the coming meeting of the British Medical Association at Cambridge, honorary degrees are proposed for the Master of Pembroke, Sir T. Clifford Allbutt, Jules Bordet, A. Calmette, H. Cushing, S. Flexner, Piero Giacosa, Major-Gen. Gorgas, Sir George Makins, Sir Patrick Manson, and Sir Norman Moore.

**LIVERPOOL.**—The council of the University has appointed Mr. T. R. Wilton as lecturer in dock and harbour engineering, with the title of associate-professor. Mr. Wilton is closely connected with the Liverpool Engineering Society, and has done valuable work for that body as hon. secretary—a position he has held since 1907. He has been for some years special lecturer in dock and harbour construction at the University, has carried out important investigations on the movement of sand and currents, and has also taken observations of a practical nature on the Mersey.

Mr. H. RICHARDSON, of the Municipal College of Technology, Manchester, has been appointed principal of the Bradford Technical College in succession to Prof. W. M. Gardner.

The Ministry of Agriculture and Fisheries is open to receive until July 15 nominations for a limited number of research scholarships in agricultural science, each tenable for two years, and of the annual value of 200*l.* Candidates must be graduates with honours in science of British universities, with evidence of high proficiency in subjects having a direct bearing on agriculture, and be nominated by a professor or lecturer of a university or college. Nomination forms are obtainable from the General Secretary of the Ministry, 72 Victoria Street, S.W.1.

The *Library Association Record* for May contains a paper on "Technical Libraries and Intelligence" by Major W. E. Simmet, and also an article on "The Technical Library" by Mr. R. Borlase Matthews. Mr. Matthews lays stress on the necessity for making the most recent publications immediately available for reference, and discusses the various ways in which a technical library can be made accessible to readers. Major Simmet, taking the subject of engineering as an example, points out that there are at present in London several libraries containing books and periodicals relating to engineering, and that this involves much overlapping which might be avoided by amalgamation. He also refers to the Transport Library to be formed by the Ministry of Transport. Such a library would be devoted to all aspects and methods of transportation. The importance of an index of technical literature, possibly on the lines of the International Catalogue of Scientific Literature, is carefully explained by Major Simmet, who recommends a combination of indexing and abstracting. At the same time he finds that papers on technical subjects become out of date much sooner than papers on purely scientific topics, so that it is less necessary to preserve all titles of technical papers in a permanent index. Major Simmet gives an account of the *Technical Review*, established since the armistice to continue the work of the *Technical Supplement*, published in 1918 under the auspices of the War Office. As a further contribution to the indexing of technology, the *Library Association Record* for May, 1920, contains a subject-index to papers published in 1917-19 on fuel, including gas and petroleum. The list is prepared by the editors of the "Subject Index of Periodicals," and is an example of the thoroughness which their work always exhibits.

One of the problems at present confronting the Ministry of Agriculture is the provision of advice and supervision for the smallholder. This problem has become more acute now that so many of the men settling on the land are lacking, either partly or altogether, in knowledge of the theory and practice of horticulture. When the question arose of appointing organisers to instruct these men and to look after their interests, it was found that the number of candidates qualified to fill such posts was extremely limited. A man who is to organise the horticultural instruction of a county should have a knowledge of the scientific side of the subject as well as of its practical side. Quite apart from this question of supplying instruction for smallholders, it is obviously desirable, in view of the rapidly increasing importance of horticulture in this country, that the prospective fruit-farmer or market-gardener should be able to obtain instruction in his subject as scientific and comprehensive as that which can be so readily obtained nowadays by the prospective agriculturist. In order that such instruction may be available, the Ministry of Agriculture has made it possible for the University of Cambridge to establish a degree in horticulture and a post-graduate diploma. The course for the degree will extend over three years, and will consist of instruction in the theory and practice of commercial fruit- and vegetable-growing, the practical side of the subject being treated no less fully than its theoretical aspect. It is hoped that the course for the diploma will provide men qualified for research work in horticulture. Hitherto there has been a dearth of such men owing to difficulty in obtaining suitable training, and research work in connection with an important industry has therefore been greatly hampered. The courses will commence in October next, and information concerning them can be obtained from the Secretary, School of Agriculture, Cambridge.

## Societies and Academies.

### LONDON.

**Zoological Society**, June 1.—Sir Sidney F. Harmer, vice-president, in the chair.—Dr. G. M. Vevers: Report on the Entozoa collected from animals which had died in the society's menagerie during the past nine months.—Dr. W. T. Calman: Notes on marine wood-boring animals. 1.: The shipworms (Teredinidae).

### CAMBRIDGE.

**Philosophical Society**, May 17.—Mr. C. T. R. Wilson, president, in the chair.—Dr. F. W. Aston: The atomic nature of matter in the light of modern physics.

### MANCHESTER.

**Literary and Philosophical Society**, May 18.—Mr. R. L. Taylor, vice-president, in the chair.—W. Thomson and H. S. Newman: Further notes on the filamentous growths from aluminium amalgams. Experiments to determine the ratio of the mercury to 100 parts of alumina were detailed, and descriptions of erratic growths given. The action of mercury on zinc was compared with its action on aluminium.—Prof. Sydney Chapman: The effects of lunar tides on the earth's atmosphere. The barometric pressure shows a very minute tidal variation with the period of half a lunar day. This variation can be determined only by a difficult process of averaging out other regular and irregular variations from long series of hourly barometric observations, so that data from very few stations are available. The author described and discussed their theoretical significance. Many questions

suggested by the data have as yet received no satisfactory answer, but their elucidation, as further data accumulate, should add to our knowledge of the atmosphere in some important respects.—Dr. R. S. Willows: Transverse section of cotton fibre illustrating Balls's daily growth rings.

### PARIS.

**Academy of Sciences**, May 31.—M. Henri Deslandres in the chair.—G. A. Boulenger: Remarks on the note of M. Ad. Davy de Virville concerning the species *Primula elatior*, *acaulis*, and *officinalis*.—Ch. Gautier: A sundial giving legal time throughout the year with a sufficient approximation for ordinary purposes, as well as the approximate date. The dial described and illustrated gives the legal time within about one minute. At the equinoxes it gives the exact date, but at the solstices only an approximation to the date.—Alex. Veronnet: The equilibrium figures of a liquid in rotation. Order of succession of the critical figures of bifurcation.—M. T. Huber: The generalisation of a theorem of M. Mesnager concerning the sense of the displacements of a rectangular plate.—J. Fallou: The expansion caused by Joule's effect at the contact of two solids. Two metals in contact when heated electrically expand proportionally to the square of the current or to the heat developed by the Joule effect.—A. Guillet: An auto-ballistic astronomical pendulum. An attempt to realise the conditions laid down by G. Lippmann and B. Baillaud; the impulses being supplied by induced currents.—M. Girousse: The calculation of currents causing electrolysis in metallic masses near an electric traction line.—F. Viès: Contribution to the study of absorption based on the properties of the nitrophenols. By the application of formulæ given in a previous communication it is shown how the absorption spectrum of a compound can be calculated from its composition.—F. Bourion: Kinetic study of the chlorination of benzene. The effects of rate of supply of chlorine, concentration of the benzene in chlorobenzene, and of temperature upon the reaction velocity were examined separately.—L. Vignon: The resistance of tissues to light and ultra-violet rays. Linen and silk tissues were exposed to sunlight and to ultra-violet rays (Heraeus quartz lamp) under dry and moist conditions, and the changes in the strength, as measured by the breaking load, determined. The silk fabric showed greater resistance than the linen to the effects of exposure.—E. E. Blaise: The action of hydrazine on the 1:4 acyclic diketones. Details are given of the products of the reactions between hydrazine and acetonylacetone and hydrazine and dipropionylethane.—A. Gascard: Ceryl alcohol and cerotic acid from China wax. The wax, after a preliminary purification, was saponified by potash in alcohol-benzene solution, the cerotic acid precipitated as calcium salt, and the ceryl alcohol recovered from the filtrate. Brodie's formula for the alcohol was confirmed by preparation and analysis of ceryl iodide, C<sub>24</sub>H<sub>48</sub>I, and for cerotic acid by oxidation of the alcohol and by its acidity figure.—A. Guillermond: Observations on the living chondriome of one of the Saprolegniaceæ.—L. Daniel: A new race of *Asphodelus* obtained by the action of a marine climate. A description of the changes in type produced in *Asphodelus luteus* by twenty years' cultivation on the sea-coast. The modified plant can not only be reproduced by subdivision of the roots, but also by growing from seed.—P. Ammann: The great richness in nitrogenous matter of certain manios from Cambodge.—A. Chevallier: Researches on pear-trees, walnuts, and chestnuts of the cooler parts of Indo-China and the south of China.—E. Foëx: Necrosis of the stem of the potato attacked by the

disease potato leaf-roll.—P. Portier: Regeneration of the testicle in the pigeon deprived of vitamins.—A. C. Hollande: Genocytoids and teracytes in the blood of caterpillars.—E. Fauré-Fremiet: The action of different chemical compounds on the pulmonary epithelial cell.—A. Mayer, H. Magne, and L. Plantefol: Reflex action produced by the irritation of the deeper respiratory tracts. The antagonism of this reflex with that caused by the irritation of the upper respiratory passages.—G. Bertrand and Mme. Rosenblatt: The action of chloropicrin upon yeast and *Saccharomyces vini*. A concentration of 1 milligram of chloropicrin per litre is sufficient to slow down fermentation by yeast, and 5 to 6 milligrams per litre completely arrests the production of alcohol. *Saccharomyces vini* is even more sensitive, growth being stopped by 1 milligram of chloropicrin per litre.

## CAPE TOWN.

Royal Society of South Africa, April 21.—Dr. J. D. F. Gilchrist, president, in the chair.—L. Péringuey: Note on the whales frequenting South African waters. The author describes the various whales which are known to frequent the coasts of South Africa. The number of these is still under discussion. The fact is now well established that certain Northern whales are specifically identical with the Southern whales, and are the kinds of whales found on the South African coasts. That they are migrants, perhaps with the exception of *Balaenoptera Brydei*, is a well-established fact, but what is probably less known is that the animals go to warmer equatorial waters to breed or calve. If they are intercepted on their way there from the Antarctic or on their return the multiplication of the species will be greatly hindered, to say the least. People interested in the whaling industry admit that some measure of protection is necessary.—J. R. Sutton: Overgrowths on diamond. In this paper the author discusses in detail overgrowths of calcite, bort of various kinds, graphite, and diamond on diamond. Experiments were made with the object of determining why certain diamonds from yellow ground are not separated from the concentrates on the grease tables, the conclusion being reached that carbonate of lime readily forms a coating on a diamond surface, causing the diamond to behave like a common mineral in the pulsator gravel. A clear diamond is readily wetted by a solution of carbonate of soda, but not by pure water. Overgrowths of graphite and of black bort are common, and define per saltum stages of crystallisation. Thirteen specimens of "hailstone" structure are described. Laminated diamonds appear to be examples of overgrowth of diamond on diamond with interposing planes of colouring matter.—J. R. Sutton: Some statistics of thunder and lightning at Kimberley. The author gives tables of the results of eye and ear observations of thunder and lightning made at Kimberley during the twenty-three years 1897 to 1919, and classifies the storms according to the classification given by Ley. A phenomenon of interest is the "smell" of a thunderstorm. The author observed this only once strongly in Kimberley. European meteorological literature of the seventeenth and eighteenth centuries has many allusions to the "sulphureous smell" of lightning.—S. H. Skille: Notes on some South African Entomophthoraceae. The material used by the author was collected at Cedara, Natal, in 1919 and 1920. The great majority of the family are parasitic on insects. The author describes and figures South African species of Entomophthoraceae and his experiments of cultivating them from dead and dying flies and grasshoppers and of infecting insects from the cultures.

## Books Received.

- Banff and District. By A. E. Mahood. Edited by Dr. E. I. Spriggs. Pp. xvi+388. (Banff: Banffshire Journal, Ltd.)
- The Glow-worm and Other Beetles. By J. H. Fabre. Translated by A. T. de Mattos. Pp. viii+488. (London: Hodder and Stoughton, Ltd.) 8s. 6d. net.
- A Geographical Bibliography of British Ornithology from the Earliest Times to the End of 1918. By W. H. Mullens, H. Kirke Swann, and Rev. F. C. R. Jourdain. Part 4. Pp. 289-384. (London: Witherby and Co.) 6s. net.
- The Ascent of Man. Pp. 74. (London: The Horniman Museum.) 6d.
- Airplane Photography. By Major H. E. Ives, U.S. Army. Pp. 422. (Philadelphia and London: J. B. Lippincott Co.) 18s. net.
- The Nation's Food: A Statistical Study of a Physiological and Social Problem. By Prof. Raymond Pearl. Pp. 274. (Philadelphia and London: W. B. Saunders Co.) 16s. net.
- Co-Education and its Part in a Complete Education. By J. H. Bradley. Pp. 39. (Cambridge: W. Heffer and Sons, Ltd.) 2s. net.
- The Year-Book of the Scientific and Learned Societies of Great Britain and Ireland. Thirty-sixth Annual Issue. Pp. vii+336. (London: C. Griffin and Co., Ltd.) 12s. 6d. net.
- The Organisation of Industrial Scientific Research. By Dr. C. E. Kenneth Mees. Pp. ix+175. (New York and London: McGraw-Hill Book Co., Inc.) 12s.
- Memoirs of the Geological Survey, Scotland: The Economic Geology of the Central Coalfield of Scotland. Description of Area VII. By the late Dr. C. T. Clough and others. Pp. vii+144. (Edinburgh: H.M.S.O.) 7s. 6d. net.
- Memoirs of the Geological Survey. Special Reports on the Mineral Resources of Great Britain. Vol. vi. Second edition. Pp. vi+241. (London: H.M.S.O.) 7s. 6d. net.
- Contributions from the Jefferson Physical Laboratory and from the Cruft High-tension Electrical Laboratory of Harvard University for the Years 1916, 1917, and 1918. Vol. xiii. (Cambridge, Mass.)
- A Naturalist on the Amazons. By H. W. Bates. Abridged and edited for schools by Dr. F. A. Bruton. Pp. xix+182. (London: Macmillan and Co., Ltd.) 2s. 6d.
- Tables of the Motion of the Moon. By Prof. E. W. Brown, with the assistance of H. B. Hedrick. Sections i. and ii. Pp. xiii+140+39. Section iii. Pp. 223. Sections iv., v., and vi. Pp. 99+56+102. (New Haven, Conn.: Yale University Press; London: Oxford University Press.) 4 guineas net.
- Outlines of the Geology of Brazil, to accompany the Geologic Map of Brazil. By J. C. Branner. Second edition. Pp. 189-338+plates. (N.Y. City: Geological Society of America.) 3.35 dollars.
- War against Tropical Disease. By Dr. A. Balfour. Pp. 219. (London: Baillière, Tindall, and Cox.) 12s. 6d. net.
- The New Psychology and its Relation to Life. By A. G. Tansley. Pp. 283. (London: George Allen and Unwin, Ltd.) 10s. 6d. net.
- A Guide to the Old Observatories at Delhi, Jaipur, Ujjain, Benares. By G. R. Kave. Pp. vii+108+ xv plates. (Calcutta: Supt. Govt. Printing, India.) 3s. 6d.
- A Guide to the Identification of our more Useful Timbers. By H. Stone. Pp. viii+52+3 plates. (Cambridge: At the University Press.) 7s. 6d. net.

Elgie's Weather Book: For the General Reader. By J. H. Elgie. Pp. xii+251. (London: The Wireless Press, Ltd.) 5s. net.

Structural and Field Geology. By Dr. J. Geikie. Fourth edition. Pp. xxiv+454+lxix plates. (Edinburgh: Oliver and Boyd; London: Gurney and Jackson.) 24s. net.

The Evolution of a Coast-Line: Barrow to Aberystwyth and the Isle of Man, with Notes on Lost Towns, Submarine Discoveries, etc. By W. Ashton. Pp. xvi+302. (London: Edward Stanford, Ltd.) 10s. net.

Allgemeine Erkenntnislehre. By M. Schlick. Pp. x+346. (Berlin: J. Springer.) 18 marks.

Letters of Travel. By Rudyard Kipling. Pp. vi+284. (London: Macmillan and Co., Ltd.) 7s. 6d. net.

The Revels of Orsera: A Mediæval Romance. By Sir Ronald Ross. Pp. vi+393. (London: John Murray.) 7s. net.

The Group Mind. By W. McDougall. Pp. xvi+304. (London: Cambridge University Press.) 21s. net.

Malaria at Home and Abroad. By Dr. S. P. James. Pp. xi+234. (London: John Bale, Ltd.) 25s. net.

The End of the World. By J. McCabe. Pp. vii+267. (London: G. Routledge and Sons, Ltd.) 6s. net.

Pharmacology. By Dr. D. Cow. Pp. viii+132. (London: J. and A. Churchill.) 7s. 6d. net.

Oil-Finding. By E. H. Cunningham Craig. Second edition. Pp. xi+324+xiii plates. (London: Edward Arnold.) 16s. net.

Forest Management. By Prof. A. B. Recknagel and Prof. J. Bentley, Jr. Pp. xiii+269+iii plates. (New York: J. Wiley and Sons, Inc.; London: Chapman and Hall, Ltd.) 13s. 6d. net.

Aeronautics. By Prof. E. B. Wilson. Pp. vii+265. (New York: J. Wiley and Sons, Inc.; London: Chapman and Hall, Ltd.) 22s. net.

## Diary of Societies.

### THURSDAY, JUNE 17.

ROYAL SOCIETY, at 4.30.—Prof. W. Bateson: Genetic Segregation (Croonian Lecture).

LINNEAN SOCIETY, at 5.—Celebration of the Centenary of Sir Joseph Banks, Bart. (1743-1820).—Dr. B. Daydon Jackson: Banks as a Traveller.—Dr. A. B. Rendle: Banks as a Patron of Science.—J. Britten: Banks as a Botanist.

ROYAL COLLEGE OF PHYSICIANS OF LONDON, at 5.—Dr. A. F. Hurst: The Psychology of the Special Senses and their Hysterical Disorders (Croonian Lecture).

ROYAL SOCIETY OF MEDICINE (Dermatology Section), at 5. CHEMICAL SOCIETY (at Institution of Mechanical Engineers), at 8.—Prof. F. C. McLaren: Film.

HARVEIAN SOCIETY OF LONDON (at Medical Society), at 8.30.—Dr. E. G. Little: Differential Diagnosis of some Common Skin Eruptions. SOCIETY OF ANTIQUARIES, at 8.30.

### FRIDAY, JUNE 18.

INSTITUTION OF SANITARY ENGINEERS (at Holborn Restaurant), at 11.30 a.m.—The President: The Institution and its Future.—A. J. Martin: Sanitary Socialism. At 2.30.—T. Robertson: Poured Concrete Construction.—G. W. Chilvers: Health, Wealth, and Housing.—A. P. I. Cotterell: A Glimpse at Domestic Engineering in some of the Eastern States of America.

ROYAL SOCIETY OF ARTS (Indian Section), at 4.30.—Sir Valentine Chirol: The Enduring Power of Hinduism (Sir George Birdwood Memorial Lecture).

GROPHYSICAL COMMITTEE (at Royal Astronomical Society), at 5.—Commander H. D. Warburg, Prof. H. Lamb, Dr. J. Proudman, Dr. A. T. Doodson, Major A. J. Wolff, and H. L. P. Jolly: Discussion on Tides. SOCIETY OF TROPICAL MEDICINE AND HYGIENE (Annual General Meeting), at 8.30.—Dr. F. H. Stewart: Recent Work on Round-worm Infection.

### SATURDAY, JUNE 19.

BRITISH PSYCHOLOGICAL SOCIETY (at University College, Gower Street), at 3.30.—Dr. J. Dreyer: The Emotional Phases of Affective Experience. PHYSIOLOGICAL SOCIETY (at Physiological Laboratory, University of London, South Kensington), at 4.30.—G. Aurepan and C. Lovatt Evans: The Mode of Action of Vaso-dilator Nerves.—C. Lovatt Evans: The Lactic Acid Content of Plain Muscle.

### SUNDAY, JUNE 21.

ROYAL GEOGRAPHICAL SOCIETY (at Eolian Hall), at 8.30.—Major L. F. I. Athill: Through South-west Abyssinia to the Nile.

ROYAL INSTITUTE OF BRITISH ARCHITECTS, at 8.30. AMISTOTELIAN SOCIETY (at 74 Grosvenor Street), at 8.—Miss Beatrice Edgell: Memory and Conation.

### TUESDAY, JUNE 22.

ROYAL COLLEGE OF PHYSICIANS OF LONDON, at 5.—Dr. A. F. Hurst: The Psychology of the Special Senses and their Hysterical Disorders (Croonian Lecture).

ROYAL AERONAUTICAL SOCIETY (at Central Hall, Westminster), at 8.30.—Comdr. J. C. Hunsaker: Naval Architecture in Aeronautics (Wilbur Wright Lecture).

### WEDNESDAY, JUNE 23.

GEOLOGICAL SOCIETY OF LONDON, at 5.30.—O. Holtedahl: The Scandinavian "Mountain Problem".

INSTITUTION OF ELECTRICAL ENGINEERS (Wireless Section), (at Institution of Mechanical Engineers), at 6.—B. S. Gosling: The Development of Thermionic Valves for Naval Uses.

### THURSDAY, JUNE 24.

ROYAL SOCIETY, at 4.30.—Probable Papers.—Sir Ray Lankester: Some Rostro-carinate Flint Implements and Allied Forms.—Lord Rayleigh: A Re-examination of the Light scattered by Gases in respect of Polarisation. I. Experiments on the Common Gases.—A. Mallock: Note on the Influence of Temperature on the Rigidity of Metals.—Dis. E. F. Armstrong and T. P. Hilditch: A Study of Catalytic Actions at Solid Surfaces. V. The rate of change conditioned by a Nickel Catalyst and its Bearing on the Law of Mass Action.—Dr. H. Jeffreys: Tidal Friction in Shallow Seas.—Other Papers.

LINNEAN SOCIETY OF LONDON, at 5.—Dr. C. J. F. Skottsborg: Recent Researches on the Antarctic Flora.—Dr. R. J. Tillyard: The Cawthron Institute, New Zealand, and its Biological Function.

OIL AND COLOUR CHEMISTS' ASSOCIATION (at Food Reform Club, 9, Furnival Street), at 7.30.—A. E. Bawill: (1) A Hydrometer for Accurate Determinations of Pastes and Viscous Materials; (2) A Viscosimeter which Combines Increased Efficiency with the Power of Measuring "Stickiness" Independently of Viscosity.

### FRIDAY, JUNE 25.

PHYSICAL SOCIETY OF LONDON, at 5.—Dr. J. H. Vincent: The Origin of the Elements.—W. H. Wilson and Miss T. D. Eggs: The Construction of Thermo-couples by Electro-deposition.—J. Guild: The Use of Vacuum Arcs for Interferometry.—S. Butterworth: The Maintenance of a Vibrating System by Means of a Triode Valve.

## CONTENTS.

PAGE

University Stipends and Pensions	477
Aerography	479
Paper-making and its Machinery. By R. W. Sindall	480
The Structure of the Nucleus. By R. R. G.	482
Our Bookshelf	483
Letters to the Editor:—	
London University Site and Needs.—Sir E. Sharpey Schafer, F.R.S.	484
High Rates of Assent of Pilot-Balloons. ( <i>With Diagram</i> ).—Dr. W. van Bemmelen	485
A New Method for Approximate Evaluation of Definite Integrals between Finite Limits.—Commander Thos. Y. Baker	486
The Royal Military Academy.—J. Young	486
The Separation of the Isotopes of Chlorine.—D. L. Chapman, F.R.S.	487
A Note on Telephotography.—A. B.	488
Recent Researches on Nebulæ. ( <i>Illustrated</i> ). By Major William J. S. Lockyer	489
The Importance of Meteorology in Gunnery. By Dr. E. M. Wedderburn	492
Obituary:—	
S. Ramanujan, F.R.S.—Prof. G. H. Hardy, F.R.S.	494
Principal Sir John Herkless, D.D., LL.D.	495
Notes	496
Our Astronomical Column:—	
The Masses of the Stars	500
The Planet Jupiter	500
Parallax Work at the Sproul Observatory	500
The Nuclear Constitution of Atoms. By Sir Ernest Rutherford, F.R.S.	500
The Rockefeller Gift to Medical Science. By Prof. W. M. Bayliss, F.R.S.	501
The Permanent Value of University Benefactions	501
The Imperial Entomological Conference. By G. H. C.	502
The Selous Memorial at the Natural History Museum. ( <i>Illustrated</i> ).	504
University and Educational Intelligence	505
Societies and Academies	506
Books Received	507
Diary of Societies	508



THURSDAY, JUNE 24, 1920.

*Editorial and Publishing Offices:*

MACMILLAN & CO., LTD.,

ST. MARTIN'S STREET, LONDON, W.C.2.

Advertisements and business letters should be  
addressed to the Publishers.

Editorial communications to the Editor.

Telegraphic Address: PHUSIS, LONDON.

Telephone Number: GERRARD 8830.

### University and Higher Technical Education.

IN 1881 Mr. Mundella, then Vice-President of the Council, and consequently responsible for the policy of the Board of Education, with full knowledge as a manufacturer of the great growth, since the Franco-German war of 1870, of manufacturing industry in all parts of Germany, and sensible of the increasing unrest in British industry caused thereby, induced the Government of the day to appoint a Royal Commission "to inquire into the instruction of the industrial classes of certain foreign countries in technical and other subjects for the purpose of comparison with that of the corresponding classes in this country, and into the influence of such instruction on manufacturing and other industries at home and abroad." The members of the Commission were chosen from representatives of important industries and others engaged in scientific education. They undertook an extensive and exhaustive inquiry into the conditions and range of the teaching of pure and applied science in the chief European countries and in the United States, and visited also the Universities and colleges and some of the chief schools and workshops of the United Kingdom. After three years' investigation they produced in 1884 an exceedingly full and valuable report, which was widely circulated in this and other countries.

The report laid bare our serious deficiency as compared with the great facilities afforded by foreign Governments, especially those of Germany, Switzerland, and the United States, and it aroused a widespread interest in industrial and educational circles, leading, after a considerable lapse of time, to the passing of the Technical Instruction Acts of 1889 and 1890, which resulted

NO. 2643, VOL. 105]

in the establishment of many important technical schools throughout the kingdom.

We have undoubtedly made great progress in science and in its industrial applications during the past generation, but not less marked has been the advance of German industry, which in some spheres of manufacture, notably those of dyes and fine chemicals, in optical glass, and in certain branches of electrical engineering, easily held the first place. The events of the war have demonstrated the resourcefulness of British men of science, inventors, and manufacturers, who to a surprising extent, as shown by the exhibitions held, under the auspices of the British Science Guild, at King's College, London, in 1918, and at the Central Hall, Westminster, in 1919, met the extraordinary demand made upon their knowledge, ingenuity, skill, and adaptability. The time is now again ripe for inquiry as to the means and resources of the kingdom, especially from the point of view of a due supply of adequately educated and equipped men of science to be engaged in industry and commerce, to meet the inevitable industrial and commercial competition which will arise on the resumption of normal conditions and of free intercourse between nation and nation.

The strength of this competition may be illustrated in the instance of a highly specialised product. The balance sheets for 1919 of three of the principal aniline dye companies of Germany are now available. At the nominal rate of exchange, F. Bayer and Co. show a net profit of 1,450,000*l.*, against 654,000*l.* in 1918; Meister, Lucius and Co., 1,210,000*l.*, as compared with 750,000*l.* in 1918; whilst the Berlin Colour Works declare a dividend of 18 per cent., as against 12 per cent. in 1918. On the other hand, the sum available for dividend in the British Dyestuffs Corporation is only 172,505*l.* The report of this company states that there is an unprecedented demand upon it for dyestuffs in both quantity and variety, to meet which requires increased efforts in the direction of production and research. It is recognised that it is of paramount importance to have a department where research work can be carried out along the most modern and scientific lines, and to encourage those engaged on the scientific and research side of the industry.

The production of dyes of high quality in an endless variety of shades, in which the German firms have excelled because of their unlimited command of high-class scientific and technical ability,

the fruit of Germany's technical high schools and universities, is, like some other imported products, essentially a "key" industry, and therefore a dominant factor in the manufacture of finished textiles, which to a very large extent are exported by us to foreign markets, there to meet in competition the goods of other countries. Having regard to the prime necessity of increasing the supply of competent graduates for scientific industrial research, the British Science Guild carefully investigated the subject, and last year issued a report (which has been widely distributed to members of the Government, to the Universities, and to many leaders of industry and commerce) on industrial research and the supply of trained scientific workers. It was shown that in 1914 the number of full-time students of University standard and of students of science and technology in the United Kingdom was relatively small as compared with the number of similar students in the United States and in Germany; and further, that the financial resources of Universities in the British Isles are very much below those of the other countries. Two of the provincial Universities—namely, Manchester and Liverpool—are now engaged in the endeavour to raise the sum of 650,000*l.* and 1,000,000*l.* respectively to enable them to extend their operations so as to meet in some measure the demands made upon them, especially in the departments of science and technology. Leeds and other centres of higher education are also appealing for monetary aid.

There should be, as in 1881-84, a systematic national survey of the conditions now existing and of the requirements necessary to ensure the satisfactory progress of industry and commerce in the United Kingdom. The circumstances arising out of the war have brought about an entire and welcome change of outlook on the part of British manufacturers engaged in the chief industries of the country, evidence of which is to be found in the list issued in April last of nineteen research associations representing various industries which have been approved by the Department of Scientific and Industrial Research, whilst several other industries have submitted, or are engaged in preparing, memoranda and articles of association for approval.

The growing appreciation on the part of the community generally of the advantages of secondary education, together with the requirements of the Education Act of 1918, will of necessity increase the demand for highly qualified teachers,

for whose training the Universities and the chief technical institutions will be responsible, necessarily entailing upon them a large additional expenditure. It is, moreover, increasingly recognised that the nation does not take adequate advantage of the best brains in the poorer classes of the community. A broad highway must be established along which they may travel from the elementary school to the University, but this can be accomplished only by the institution of a large number of national maintenance scholarships operating uniformly all over the country, as local scholarships do not, and so providing the means whereby the capable youth may advance from stage to stage from his twelfth year. This would entail a large expenditure, but the nation would be well repaid in the rich harvest it would reap of highly capable men and women.

These considerations lead to the necessity of largely increased State grants in support of University and higher technical education, which should be closely related to the appointment of a consultative committee mainly composed of representatives of industry and commerce and of universities and technical institutions to advise the Board of Education on matters relating to science and technology and their bearing upon the requirements of industry, and also to the division of the country into provinces roughly corresponding to the areas served by the respective Universities, governed by a council composed of existing local authorities, with the addition of members representative of the Universities and of industry and commerce.

If this were done it would be possible to correlate effectively all forms of education, to prevent overlapping, and to equalise the burden of administration and cost, whilst giving equality of opportunity, without distinction of class, to all residing within the province so created. For these reasons the British Science Guild strongly urges the Board of Education to set up a Departmental Committee to make an exhaustive inquiry into the present provision of University and higher technical education throughout the kingdom, with power to suggest how it could best be arranged and developed according to the needs of each area, whether industrial, commercial, or agricultural in character. Such an inquiry could not fail to be fruitful in its results, and would greatly stimulate the interest of all concerned in the conditions making for national well-being in all its aspects.

### Mathematics of Elasticity.

*A Treatise on the Mathematical Theory of Elasticity.* By Prof. A. E. H. Love. Third edition. Pp. xviii + 624. (Cambridge: At the University Press, 1920.) Price 37s. 6d. net.

THIS is the third edition of the classical treatise in the English language upon the theory of elasticity, and all students of the subject will be grateful to Prof. Love for having brought his masterly exposition of this difficult but fascinating branch of mathematical science up to date. The book is now thoroughly well established as part of the education of such mathematicians as have to deal with the engineering or physical applications of elasticity; indeed, it needs some hardihood, even for a specialist, to criticise it; every fresh perusal convinces the careful reader of the inadequacy of his own knowledge.

The changes made in this edition have been slight in appearance, but attention to details will reveal many improvements in both form and matter. The numbering of the sections has not been changed, which is of great help to those students who have learnt to use the second edition. New sections have been interpolated here and there, and these have been distinguished by a letter—e.g. 79A.

As previously, a great many references are given to the experimental side of the subject, and very rightly, for in many ways the mathematical theory of elasticity is more closely verified by experience (where verification has been seriously attempted) than the cognate theory of hydrodynamics. Where discrepancies have occurred they can usually be traced either to the inherent difficulty of obtaining an exact mathematical solution of the problem, or to unintelligent experimenting. Far too much experimental work, for example, has been done with systematic disregard of the elastic limits, or without due precautions, in anticipation of 5 per cent. accuracy. For various reasons, the engineer does not find it convenient to isolate effects, and he rarely carries out experiments for the express purpose of testing a mathematical theory. Thus what may be called the physics of elasticity has advanced comparatively little. The methods of photo-elasticity, first used by Clerk Maxwell, who applied the effect of stress on polarised light (discovered by Brewster) to the investigation of stress-distributions, and recently developed as a working engineering method by Prof. Coker, promise to do much to remove this reproach and to get rid of the difficulty mentioned by Prof. Love that "the components of stress or of strain within a solid body

can never, from the nature of the case, be measured directly" (p. 94).

New sections have been added in chap. iv. on the results of Hopkinson and Sears concerning stresses maintained for a very short time, and also on elastic hysteresis. The term "perfect elasticity" to denote that condition in which the stress-strain diagram is closed, although the loading and unloading graphs do not coincide, seems unfortunate, as elasticity can scarcely be called perfect when elastic energy is being dissipated. "Perfect recovery" might denote this case, "perfect elasticity" being reserved for the condition in which loading and unloading graphs coincide. "Linear elasticity" explains itself, but surely the statement on p. 113, given on the authority of Bauschinger, that the limits of linear elasticity are higher than those of perfect recovery, can scarcely be right, since the former condition should imply the latter. An important appendix has been added at the end of chap. ix. on Volterra's theory of dislocations in the case of multiply connected bodies. A simpler proof of Weingarten's theorem that the discontinuities in the displacements on crossing a "barrier" correspond to a rigid body displacement can, however, be given. For if  $u_0, v_0, w_0$  be one value of the displacement at a point P, and  $u_1, v_1, w_1$  the displacement at the same point P after describing an irreducible circuit,  $u_1 - u_0, v_1 - v_0, w_1 - w_0$  are solutions of the equations of elasticity which necessarily (since the strains are supposed one-valued) correspond to zero strain everywhere, and such displacements must be rigid-body displacements. In this connection it would make things clearer for the beginner if in the proof of the uniqueness theorem given in § 118 the limitations as to the nature of the functions and the simply connected quality of the space were stated. Todhunter and Pearson have pointed out that the existence of more than one solution for a multiply connected body is immediately evident to anyone who turns a short piece of indiarubber tubing inside out. The realisation of this fact is apt to shake the student's faith if warning has not been given.

In the chapter on the sphere a very valuable new section gives the alternative method developed by the author in his essay on "Some Problems in Geodynamics," and another section gives a number of new and important references to work on geophysical problems, a branch of elasticity which is assuming nowadays an increasing importance. The work of Lamb and of G. W. Walker in connection with seismology is noticed on p. 314.

§§ 226A and 226B deal with the torsion of a

bar of varying cross-section and with end-effects in torsion.

In the chapter dealing with the elastica, the section (265) which gives the computation of the strain energy of the strut has been practically rewritten and much improved. It might be useful, in dealing with buckling, to dispose of a fallacy common among engineers that Euler's limit implies *failure* of the strut, whereas all that occurs is passage from one type of stable equilibrium to another.

Southwell's method of dealing with problems of elastic stability comes in, naturally, for considerable notice. The buckling of a strut (§ 267A), of a rectangular plate (§ 332), and of a tube (§ 341) are discussed as examples of this theory.

An entirely new chapter (xxiv. A) has been added, dealing very exhaustively with the equilibrium of thin shells in the shape of surfaces of revolution, including in particular a discussion of Meissner's work on the spherical and conical shells.

A feature of this edition (as of the previous ones) is the extraordinarily complete and careful set of references to all the original papers and memoirs dealing with the subject. Needless to say, these references, which have been most thoroughly brought up to date, are invaluable to the reader who takes up the book as a guide to research. The example set by such a master as Prof. Love might well be commended to the younger generation of scientific writers. Too often nowadays, especially in papers dealing with applied science, one comes across a statement of references which betrays the author's ignorance of the literature of his subject, both by the omission of work (sometimes of fundamental importance) done by his predecessors, and by the undue prominence accorded to the minor efforts of contemporaries in his own circle.

L. N. G. F.

### Behaviourism.

*Psychology from the Standpoint of a Behaviorist.*

By Prof. John B. Watson. (Lippincott's College Texts.) Pp. xiii+429. (Philadelphia and London: J. B. Lippincott Co., 1919.) Price 10s. 6d. net.

THERE has been a great deal of controversy, especially in the philosophical journals of America, concerning the theory of behaviourism. Prof. Watson is, we believe, the originator of the term and the recognised leader in its application as a method in psychology. The book before us is not an exposition of the theory; it takes it as accepted, and puts forward an elementary, but

nevertheless complete, schematic outline of the science of psychology, its scope and its method, regarded from this point of view. It therefore, better than any detailed exposition, sets before us the advantages and the disadvantages, the limitations and inclusions and exclusions, of psychology as the behaviourist conceives it.

Behaviourism is a theory of the science of psychology based on two postulates. The first is that the only thing the psychologist can study scientifically is behaviour. The second is that there is nothing else in psychology to study but behaviour. When the description of an individual's behaviour is exhausted there is no remainder, no *psyche*, left out of the account. The first postulate is explicit, the second implicit. It is clear at once, however, that the second is fundamental. Analyse the response of an organised material being to the stimulus of a situation, and you have exhausted psychology. Not only have you gone as far as you can go, but there is also no farther to go.

When you have simplified your science to this extent, the difficulty is to justify it at all. What is the subject-matter of psychology which demands a special method? This is Prof. Watson's difficulty. Physiology is already in the field; it has accomplished a vast amount of this very behaviour study. What is there left over for psychology? What sort of responses are there to which the physiologist can be, and is, completely indifferent, and which fall under the class-heading, psychological? The further we read in this book, the more intensely does this inquiry present itself as the crucial question. Three chapters of the book (no inconsiderable portion of the whole) are acknowledged to be pure physiology, and not psychology, and the reader is told in the preface that he may skip these if he likes, and that if he does so he need be at no disadvantage from his point of view as psychologist. But the physiology is not all so easily excised. When Prof. Watson defines an emotion he has to apologise for the impossibility of avoiding physiological terms. How much, one wonders, would be left of the book if all the physiology were taken out and only pure psychology left? The present writer, at least; as he reads the book finds himself in continual expectation that now he is coming to the end of the physiology and the beginning of the psychology, but is continually disappointed, and the reason is clear enough when Prof. Watson gives at last his definition of the distinction of the two sciences. Whenever, he tells us, we are studying the response of a part of the organism to a

situation we are in physiology; only when we study the response of the whole organism to a situation are we in psychology.

So then it is like this—there are two sciences, let us say, of a motor-car, one in which we study the structure and function of the carburettor, the gear-box, the magneto, etc., and another and different science, in which we study the behaviour of the complete car on the road, its hill-climbing power and its responses to the varying situations consequent on the control of the traffic. No doubt there are people who can drive a car in absolute ignorance of the mechanism they are controlling, and in like manner there may be psychologists with complete knowledge of the responses of the individual, though ignorant of the mechanism of the reflexes on which those responses depend. Neither is to be commended; but can we rest satisfied with such a distinction? Is it not false science to separate the science of the parts from the science of the whole? Can the parts mean anything in abstraction from the whole, or the whole mean anything in abstraction from the parts? This, however, seems to be the behaviourist's idea of the subject-matter and scope and method of psychology and of its relation to physiology.

If your interest is in psychology, surely what you want to study is the subject of experience in its living, conscious, self-active subjectivity. You can, easily enough, regard such subjects of experience as objects, accurately describe their behaviour in varying situations, and formulate fairly useful scientific laws in regard to them, just as you may study the behaviour of a magnet in the neighbourhood of different substances and formulate magnetic laws. But is either scientific? Shall we, in the first case, discover by such a method the nature of imagery, conceptual thinking, apperception, perception of reality and unreality, ideality, rationality, and all the complex products of mental life, any more than in the case of the magnet statistical observations will lead us to discover the electro-magnetic constitution of matter? The essence of behaviourism is to translate the mental into terms of bodily integration and leave it there, satisfied that the work of psychology is now done. There is nothing beyond or different in its nature.

Behaviourism is not condemned by anything positive which it recommends, but by its absurdly extravagant claim that in restricting research to methods of observation and description it is actually making science all-inclusive. This book, for example, indicates numerous most useful experimental methods, and may inspire, and will

direct, the student to practical researches of the highest interest to the advance of science. To this extent every psychologist will welcome it. It is difficult to find anything in its principle to disagree with, save only its limitation and negation. It is only when the behaviourist turns to us and says this is all there is—"Thought is the action of language mechanisms"—that we see that from his point of view there is no psychology.

H. WILDON CARR.

### The World's Supply of Animal Foodstuffs.

*Animal Foodstuffs: Their Production and Consumption, with a Special Reference to the British Empire.* A Study in Economic Geography and Agricultural Economics. By Dr. E. W. Shanahan. (Studies in Economics and Political Science.) Pp. viii+331. (London: George Routledge and Sons, Ltd.; New York: E. P. Dutton and Co., 1920.) Price 10s. 6d. net.

THIS book provides a comprehensive and very interesting survey of the production and consumption of animal foodstuffs, considered especially from the economic point of view. An interesting historical survey is included, which starts with the use made of animal foodstuffs by earlier generations and traces the gradually increasing demand for, and consequent development of, the supplies of these materials. Part i. of the book gives a detailed survey of the production of the various animal foodstuffs in the more important countries of the world.

With regard to animal foodstuffs the author states that the following countries show a definite net surplus when the balance of imports and exports is taken by values, namely, the United States, Russia (with Siberia), Sweden, Denmark, Holland, and Italy. When, further, the net imports or exports of animal feedstuffs are considered in conjunction with those of animal foodstuffs, the following results are observed: The surplus position of the United States, Argentina, Uruguay, Canada, and Russia (with Siberia) becomes intensified, while the deficiency position of Great Britain, Germany, and Belgium becomes, similarly, more marked; at the same time the surplus position of Denmark, Holland, Sweden, and Ireland suffers reduction. The author discusses fully the influence on production of such factors as agricultural machinery, cost of labour, co-operation of farmers, etc. Part ii. deals with the consumption of animal foodstuffs, the rate of consumption, and the economic and other factors influencing that rate.

There has been a rapid increase in the meat-

consuming population of the world during the last fifty years. This increase amounts apparently to more than 90 per cent., and some further allowance should also, in the author's opinion, be made for the rise in the standard of living not only in Europe, but also in Asiatic and tropical countries. One of the chief causes for this increase appears to be the less frequent occurrence of devastating wars as compared with earlier times. Also the opening up of vast new regions of agricultural productiveness encouraged the growth of the meat-consuming population outside Europe, while the development of cheap transport, enabling the surplus foodstuffs and feedstuffs of these new countries to be carried to other regions where local supplies were deficient, had a great effect in making possible the increase of the industrial populations in Europe. From a study of the production and consumption of animal foodstuffs it becomes clear that the supply of these is likely to be considerably less than the demand. The author states that this is due to three causes: Owing to the comparative lack of undeveloped fertile regions, the rate of expansion in the surplus production of pasture-fed meat animals and of concentrated feedstuffs from the new overseas countries is slowing down; the white meat-consuming population has increased; with the general improvements in the financial status of industrial and agricultural workers in Europe, their *per capita* consumption of animal foodstuffs tends to rise.

Part iii. of the book is concerned with the above problems as they affect the British Empire. The study of the Empire's deficiencies, both in animal foodstuffs and feedstuffs, points throughout to its lack of widespread intensive systems of agriculture, for, though land resources are abundant, they remain more or less undeveloped in large areas. The author emphasises the fact that throughout those parts of the Empire inhabited by white people only a relatively small proportion are engaged in agriculture, and they work on the extensive instead of the intensive system. His conclusion is:—

"The Empire, as a whole, requires to have an enormously increased area under cultivation for the production of feedstuffs, not only to make good its deficiency in this direction, but also to provide for the maintenance of food-producing animals and of poultry in much larger numbers than at present, if it is to cover in a more satisfactory way its deficiency in meat, dairy produce, and eggs."

A valuable feature of the book lies in the summaries which occur at the end of nearly  
NO. 2643, VOL. 105]

every chapter in Part iii., while for Parts i. and ii. the author gives a full summary of the conclusions to be drawn from the general study of the question of food production and consumption.

### Life and Lore of Birds.

*The Heron of Castle Creek and Other Sketches of Bird Life.* By A. W. Rees. With a memoir of the author by J. K. Hudson. Pp. xi+218. (London: John Murray, 1920.) Price 7s. 6d. net.

A MELANCHOLY interest is attached to this volume, inasmuch as its gifted author selected the articles, which had previously appeared in various serial publications, for re-issue in book form, but did not live to complete their final revision for the press. This task was undertaken by his literary executor and successfully carried through with so satisfactory a result that we are glad to know that sufficient of Mr. Rees's writings still remain to form another of these delightful volumes.

Most of the essays in the series now before us are devoted to bird-life, the various phases of which are graphically described from the personal observations of the author, who did not trust to books for his knowledge, but gleaned his information at first hand from the creatures he loved. The engaging style of writing and the accuracy of the author's notes on the lives and loves of the birds and beasts he watched disarm criticism and form engrossing reading. It is difficult to single out any particular essay as of outstanding interest, but the account of the parent kingfishers teaching their brood to dive for minnows is original, amusing, and instructive, while the observations on the dipper, the efforts of the author to find its nest, and the affection shown by these birds for their mates, entirely captivate the reader. When a cock offered his tribute of a large worm to his lady-love, the author felt, as he watched its antics, that he "could recognise a sentiment subtly different from mere animal passion," and goes on to say:—

"In those rare brief periods of outdoor study when, to my surprise and delight, I have caught a glimpse of what, for want of a better phrase, might be termed the humanity of Nature, I have not merely imagined, but have felt sure, that many of the finest feelings of man—pity, sympathy, devotion, unselfish comradeship—are shared in no small measure by creatures considered to be far beneath our plane of life."

Five essays are given on the life of the part-ridge at various periods of the year, and these

are so graphically penned that one fancies oneself at the author's side, watching intently the behaviour of these attractive birds, and sharing with them the hopes, fears, and passions incidental to all stages of their brief career in the open, fraught as it is with constant danger from hawk, weasel, fox, or sportsman, and yet alleviated by the intense joys inseparable from the sharing with a mate the important duties of founding a home and rearing a brood of tiny fledglings. The book is not without its humorous side too, as the reader will discover when smiling over the "Misadventures of Bird-watching." While the author is endeavouring to identify a pair of warblers and to find their nest, he is himself closely watched, in the first place, by a puzzled keeper, who suspects him of poaching, and, secondly, by an angry bull in unpleasant proximity, to escape the unwelcome attentions of which the enthusiastic naturalist has perforce to bring into action his fullest powers of strategy.

This well-printed and unusually attractive volume can be recommended to the notice of all lovers of Nature and Nature-lore, and the appearance of a further series of posthumous essays will be very welcome.

### Our Bookshelf.

#### *Engineering Descriptive Geometry and Drawing.*

By Capt. Frank W. Bartlett and Prof. Theodore W. Johnson. Part i. Pp. vii+206. Part ii. Pp. v+207-374. Part iii. Pp. v+375-617+xiv plates. (New York: John Wiley and Sons, Inc.; London: Chapman and Hall, Ltd., 1919.) Price 27s. 6d. net.

THIS book gives in full detail the elementary courses of engineering drawing as taught to young midshipmen in the Navy of the United States of America. The instruction is arranged on the assumption that the student is quite without knowledge or experience in the handling of drawing instruments. Part i., occupying about a third of the volume, treats of line drawing in pencil and in ink, lettering, the use and care of instruments and scales, and describes in the minutest detail all the "tricks of the tool's true play" as witnessed in the practice of the draughtsman's art. In these pages the learner has virtually at his elbow, for constant reference, the skilled craftsman and the experienced teacher. His progress should be sure and rapid, even without much help from an instructor.

In part ii. the principles of projection and descriptive geometry are unfolded in close relation to the special needs of engineers.

Part iii. is perhaps the most important section, and the fourteen plates at the end give standard dimensions of such things as bolts, nuts, rivets,

pipes, rolled sections, etc., as adopted by the bureaux of the U.S. Navy Department. We have in this part a finely graduated scheme of work in which the student executes finished drawings of machine details from his own dimensioned hand sketches of the actual parts; becomes familiar with the tables of standards; is trained in the reading of drawings, etc. Although the instructions are again minute and full, almost sufficient for self-tuition, there is no suspicion of spoon-feeding, and the student is left more and more to his own resources as he becomes fit. There are chapters on ships' lines and on structural steel and iron work.

The treatment of the subject has been evolved gradually and embodies the results of much experience in class work. It is characterised by thoroughness, and the text-book is a model of what such a book should be. The volume ought to be in the library of every technical school and drawing class in this country. Teachers as well as students could learn much from it.

*Intermediate Text-book of Magnetism and Electricity.* By R. W. Hutchinson. Pp. viii+620. (London: W. B. Clive; University Tutorial Press, Ltd., 1920.) Price 8s. 6d.

THE writer of a book such as this is a little handicapped by having to work in accordance with schemes laid down by boards of examiners, and has not quite a free hand in the arrangement and development of his material. Covering the subject up to the "Intermediate" standard, the work is suitable more to the science student than to the future electrical engineer, and in view of the vastness of the field the author has been obliged to cut down the practical parts of the subject in order to provide space for the more academical sections. It is not his fault that the pith ball is made as important as the dynamo. Nevertheless, we would urge that it is as essential for the science student as for the engineer to "think in volts and amperes" before he attempts to grasp subtler refinements, and we should have liked to see Ohm's law and the conception of resistance introduced earlier than p. 304. In the author's treatment of magnetism, on the other hand, with which he commences his volume, he boldly brings his reader face to face with the equation  $B=4\pi I+H$  as early as p. 31, adopting "an introductory elementary treatment to acquaint the reader with the general meaning of the terms in use," and giving the fuller treatment in its proper place later. The idea is excellent, and a similar scheme might have been applied to electric currents with advantage.

Taken all round, the work is painstaking and is skilfully compiled. Special attention should be directed to the three concluding chapters on electrical oscillations, passage of electricity through gases, and radio-activity respectively, which form admirable introductions to the portions of the subject founded on the more modern researches in physics.

*A Junior Course of Practical Zoology.* By the late Prof. A. Milnes Marshall and the late Dr. C. Herbert Hurst. Ninth edition, revised by Prof. F. W. Gamble. Pp. xxxvi + 517. (London: John Murray, 1920.) Price 12s. net.

THE principal change in the new edition of this admirable and well-established text-book is the substitution of *Dipylidium caninum* for *Tænia* as an example of a tapeworm. This change has no doubt been determined largely by the common occurrence of *Dipylidium* and the consequent facility in obtaining sufficient material—especially scolices—for class purposes. The account is illustrated by a page of good figures, but there is an error in the magnification given for Fig. 3. From the point of view of the organs of the segment, *Dipylidium*—with two sets of reproductive organs in each segment, and the uterus subdivided into capsules in the mature segment—is not so good as *Tænia* as a type for study by junior students, and for the convenience of those teachers who prefer the latter type a brief description of the organs of the segment of *Tænia* might be added at the end of the account, together with Figs. 4 and 6 on p. 47 of the previous edition.

In spite of the care with which the book has been edited, a few slips have escaped attention—e.g. on p. 12 "Monocystis belongs to . . . the Sporozoa or Gregarines," as if these two terms—one relating to a class, and the other to an order in the class—were synonymous; there is the loose statement on p. 33 that in *Obelia* some of the buds "have no mouth and become medusæ"; and the amount of acid given in the formula for acid alcohol is incorrect owing to the omission of a decimal point.

### Letters to the Editor.

[The Editor does not hold himself responsible for opinions expressed by his correspondents. Neither can he undertake to return, or to correspond with the writers of, rejected manuscripts intended for this or any other part of NATURE. No notice is taken of anonymous communications.]

#### The Separation of the Isotopes of Chlorine.

MR. CHAPMAN'S conclusion (NATURE, June 17, p. 487) that the isotopes of chlorine should on certain assumptions be capable of separation by chemical means, is clearly wrong, unless there is something not stated in the reasoning to prevent it being applied to the case of a "pure" element, such as, for example, according to the results of Aston, fluorine actually is. Denoting an entirely imaginary difference between two kinds of fluorine atoms by F and F', the reasoning seems to lead in this case to the obviously absurd result that these two kinds of identical atoms with a purely imaginary difference must be capable of separation by chemical means.

The error appears to be in the equilibrium equation (i)

$$[Cl_2][Cl'] = [Cl.Cl']^2.$$

Mr. Chapman does not show how he deduces this, and it is of interest to know whether the error is due to a slip in the application of the theory of chemical equilibria to the case or to a fundamental flaw in that theory. In the present case, if the isotopes are

assumed to be chemically identical and the distribution of the two kinds of atoms in the molecules due to pure chance, then if  $n$  is the fraction of Cl atoms and  $(1-n)$  that of the Cl' atoms, the fraction of Cl<sub>2</sub> molecules is  $n^2$ , of the Cl' molecules  $(1-n)^2$ , and of the Cl.Cl' molecules  $2n(1-n)$ . This gives

$$[Cl_2][Cl'] = \frac{1}{4}[Cl.Cl']^2,$$

which is in accord with the ratio 9 to 1 to 6, stated by Merton and Hartley for the case  $n=0.75$  (NATURE, March 25, p. 104), and with Mr. Chapman's own equation (iv) deduced from the assumption that the isotopes are non-separable. FREDERICK SODDY.

#### A Possible Cause for the Diamagnetism of Bohr's Paramagnetic Hydrogen Atom.

ONE of the difficulties which confronts Bohr's structure of the hydrogen atom is the fact that hydrogen, on his hypothesis, should be paramagnetic, whereas it is, like the majority of the simple gases, diamagnetic. Experiments on the magnetism of gases have, however, always been made above absolute zero, and the atoms must therefore be in motion; and if this motion involves vibrations and rotations of the atom as well as translatory movements, then it is possible for the atom to appear diamagnetic, although it may be inherently paramagnetic. In a paper on "The Mean Magnetic Moment and Mean Energy of a Vibrating Magnet" (Mems. Manchester Lit. and Phil. Soc., vol. lvii., 1913, No. 4) I considered in a simple case how such an effect might arise if a magnet were in a uniform field and free from the influence of neighbouring magnets. In these circumstances, when the vibrations exceed  $130^\circ$  on either side of the position of rest, or if the vibrations pass into rotations, then the magnet will appear to be diamagnetic, because the average time during which the positive and negative poles are in the diamagnetic position is longer than the average time during which they are in the paramagnetic position.

Honda (Phys. Rev., Ser. 2, xiii., 1919) has recently examined at length the effect of all the possible rotational movements of a magnet in his kinetic theory of magnetism, and, with certain assumptions as to the shape of the atom, comes to the same conclusion.

Applying this result to a paramagnetic atom, it is possible that such an atom, in virtue of its motion, may appear to be diamagnetic, and the fact that hydrogen is diamagnetic may be quite consistent with Bohr's Paramagnetic model of the atom.

The kind of diamagnetism here considered, which may be called pseudo-diamagnetism, differs from that due to induced electric currents in the atom, which may be regarded as true diamagnetism. Pseudo-diamagnetism will be subject to variation with changes of temperature and with the state of aggregation of the atoms, while true diamagnetism is probably independent of these.

If the diamagnetism of hydrogen should be found to change at a very low temperature and in a very strong field, it would show that the diamagnetism of this gas was probably an effect of the motion of its atoms, and such a result would indirectly help to confirm Bohr's view of the structure of the atom by removing a difficulty.

J. R. ASHWORTH.

Rochdale, June 8.

#### A Stalked Parapineal Vesicle in the Ostrich.

THE ostrich chick on hatching displays an oval, dark-coloured, bare patch towards the hind part of the head. Later, it tends to be hidden by the thick growth of hair-like feathers which cover the head



generally, but even in the adult it can always be recognised by turning the feathers aside. Its position suggests that it is in some way associated with the pineal body, and dissection reveals a large pineal gland directly beneath, though wholly cut off by the skull. Early stages in the developing chick disclose a yet more remarkable formation in the same region, which leaves no doubt that the bare patch is really a brow spot or pineal spot, the ostrich being the only bird in which a permanent structure of this kind has been described.

Ostrich embryos of about twenty-six days' incubation—the full period being forty-two days—display a

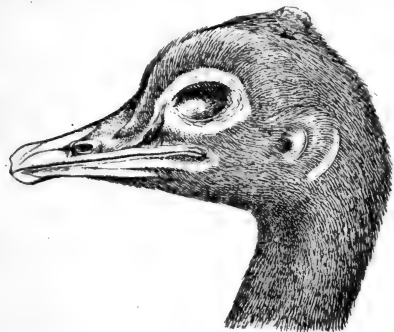

FIG. 1.

large pedunculate vesicle projecting from the middle of the bare patch, surrounded by developing feathers (Fig. 1). The stalk is thick, deeply pigmented, and rounded above, but irregular in outline below, while the vesicle is thin-walled and almost transparent, the whole structure strongly suggesting a stalked eye. The outgrowth persists for a few days only, but all ostrich chicks from about twenty to thirty days' incubation reveal one stage or another in its development or retrogression.

Microscopic sections through the fully developed organ reveal the condition represented in Fig. 2. The

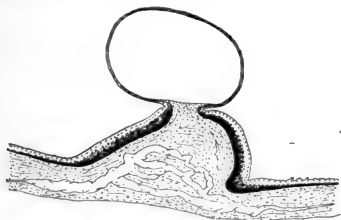

FIG. 2.

stalk is solid and broad below, with a thick epidermis produced into small, irregular fimbriations and deeply pigmented, while the vesicle is extremely thin-walled and filled with a coagulable fluid. The underlying dermal tissue is continued unchanged into the stalk, but below it has undergone a peculiar sclerose modification. The whole structure is thus tegumental and destitute of any special nervous or sensory elements. Beneath it, but not represented in the figure, is the well-developed pineal gland resting upon the pouch-like dorsal sac. Before the vesicle is fully formed, sections reveal that the basal part of the stalk is double, as if two stalks have become fused, but only

one has elongated, and ends in the vesicle. At a late stage in retrogression the two components are quite distinct.

A pedunculate vesicle, arising from the middle of the head, renders the ostrich unique among birds as well as among the entire vertebrate series. Its general association, however, leaves no doubt that it is a part of the pineal complex. The latter has, therefore, been investigated from the earliest chick stage, and many significant features have been disclosed. The primary pineal vesicle or epiphysis appears about the third day of incubation as a simple, globular, median outgrowth of the roof of the thalamencephalon; later, it forms a dense follicular system, and communication with the third ventricle is lost. At the time of its formation a small, solid upgrowth takes place just anterior to it, and situated on the right side, afterwards becoming tubular and detached, and extending upwards and forwards over the left cerebral hemisphere. All the evidence points to this as a vestigial parapineal organ, arising in close association with the pineal organ, but detached from it. It disappears about the tenth day of incubation. A parapsial upgrowth arises in front of the velum transversum, but persists for a few days only, and a dorsal sac situated immediately under the pineal gland is strongly developed.

It is submitted that the vesicle is the embryonic, persistent, integumental covering of a stalked parietal eye which was present in the ancestors of the ostrich. The sensory part of cerebral origin has degenerated, as in all birds, but the protective corneal covering of transparent epidermis and dermis which would envelop it as it pushed its way upwards still reappears in the embryo, remains for a very brief period, and then retrogresses, the pineal patch being all that persists in later life. The unique stalked character of the eye is manifestly a peculiarity to be correlated with the presence of a covering of feathers in birds.

J. E. DUERDEN.

### The Alligator Pear.

THE important notice of *Persea gratissima* in NATURE of May 27 may be usefully supplemented from Madeira, where, during the last sixty years, from ten or a dozen examples, the tree has become familiar in every garden enclosure on the lower 500 ft. of our mountain-sides—cultivated for its attractive form and autumnal yield of valuable fruit.

The revival of the short voyage from Madeira, three days and a half, to Southampton has restored the alligator pear to its former importance in the London market, for no other locality can offer equal facility for presenting this valuable esculent in condition to satisfy the educated palate of those who know the flavour of the fresh fruit.

Grown from seed, *P. gratissima* begins to bear fruit in from seven to ten years, attaining full maturity in twenty years, when it has grown into a spreading tree 30 ft. high or more, with dense light green foliage, maturing an abundant crop in September and October.

A single tree in full bearing will yield a market value of from 8l. to 15l., and the rich nutty-flavoured fruit is in growing demand.

In Madeira no serious efforts have been directed to the improvement of the alligator pear, either by selection or grafting, and the large central seed still remains as a reproach to us; but the stimulus of increasing commercial value is at hand, and preference will be given to increased food value. Some years ago I suggested that the tree might be usefully grafted on to *Persea indica*, one of the four Madeiran laurels, much hardier and with greater range, hoping

thus to spread the pear-tree beyond its present limits and to obtain from a more robust stock an increased thickness of edible flesh, and perhaps improvement in flavour; and parcels of *P. indica* seed were sent to the southern United States to test this means of fruit development. But the wild *Persea* is fast disappearing from our forests through sheer improvidence, and its priceless pink-tinted mahogany will soon be extinct.

The alligator pear—the "midshipman's butter" of other days—is mainly eaten in Madeira as a breakfastable fruit, generally with pepper and salt, and is especially to be commended as a rapid adjunct to a well-made salad, garnished with segments of the fruit as with hard-boiled egg, and sprinkled with the edible flowers of *Cercis siliquastrum* when available.

The Portuguese authorities will some day realise that the fertile valleys into which these mountain-slopes are cloven may be more profitably occupied than with sugar-cane by the custard apple, alligator pear, and other plants the perishable product of which Madeira only, from its situation, can supply in perfection to the European markets; and our perennial green peas, Cape gooseberries, February strawberries, hognuts, and broad beans will then be available in profusion while the Northern markets still wear their wintry aspect.

MICHAEL GRABHAM.

Madeira, June 7.

#### Eye-Colour in Bees.

EVERY biologist is now familiar with the colour-variation in the eyes of *Drosophila*, and the remarkable contributions to biological theory which this variation has made possible. It is not so well known that among the Anthophorid bees there are striking differences in eye-colour, which must have arisen in a manner analogous to those of *Drosophila*. These differences usually characterise species; thus in the genus *Centris* one form has the eyes crimson, another green, another grey. In *Anthophora* two closely related species from New Mexico differ, one having the eyes green, while in the other they are dark purplish. There are other differences, and the species are quite distinct. I have just obtained evidence of mutation in eye-colour within the species. *Anthophora porterae*, Ckll., is a large species with clear green (olive-green or pea-green) eyes. The varieties *Watsoni* and *semiflava* agree with the typical form of the species in this respect. However, on May 23 of this year, at White Rocks, near Boulder, Colorado, Miss Marie Chandler found a male with the eyes dark bluish-green (sea-green). This may be called mut. *Thalassina*. On drying, after death, the eyes became grey marbled with black.

T. D. A. COCKERELL.

University of Colorado, Boulder.

#### British and Foreign Scientific Apparatus.

It may be said at once with emphasis that British scientific instruments cannot be made in factories at the present wage-rates and under prevailing labour conditions at twice the pre-war prices if identical in quality and construction. Mr. Ogilvy discloses the same fact with regard to German instruments when he states in NATURE of June 3 that the wages rates of Germany are 400 per cent. higher than in 1914, and that working conditions are difficult in every way.

The only reason that German firms can sell in English money at from 60 per cent. to 100 per cent. above pre-war rates is on account of the benefit they have under to-day's rate of exchange, which values the mark at 1½d. only. It is obvious that German firms are doing remarkably well for themselves by selling in England at about twice the pre-war price.

The question is not one of free trade, prohibition,

or import under licence, but whether the scientific instrument manufacturing of this country is to continue or not. It is recognised that scientific apparatus is a necessity to the nation, and should properly be maintained as a "key industry." The manufacturers have the courage and the enterprise, and have been making preparations for production by new methods on a large scale for many months under exceedingly difficult conditions, but with the assurance that some degree of protection would be given to them.

I have before me as I write an offer of 11,935 prism binoculars lying in London by leading German makers, all at the same price and far below the cost at which similar binoculars can be made in this country at the present time. This, surely, is a case of "dumping."

It must never be forgotten that the scientific instrument makers in this country were among the foremost in the production of precise instruments for the war. Works were enlarged and plant increased to make instruments of which the Government had never encouraged the manufacture in this country, preferring to buy from Germany in times of peace; and the more effectually a comparatively small firm did its work in war-time, the more it is handicapped now. Several firms are laden with premises and plant, and have excess profits liabilities which are difficult to meet in cash, while capitalists will not put money into scientific instrument manufacturing businesses under present conditions.

Production would be hastened on a scale commensurate with the needs not only of this country, but also of the world, if these facts were faced and met; and it is the opinion of scientific instrument makers that some degree of protection should be afforded during the period that the mark and the franc have such a depreciated value.

There are no "trusts" in the British optical world, as a correspondent in NATURE suggests; there is severe competition between all manufacturers.

British manufacturers have never been slow in throwing open their works for the inspection of those who are interested, and if your correspondents and readers could be induced to pay a visit to some of the works in this country and see exactly what is going on and the possibilities that exist, they might be led to take a view of the subject which would offer encouragement to the hardly pressed, but still optimistic, British scientific instrument maker.

If any readers of NATURE should wish to visit optical works, and would send a note to the secretary of the British Optical Instrument Manufacturers' Association, Ltd., 2-3 Duke Street, St. James's, arrangements would quickly be made.

F. W. WATSON BAKER.

(W. Watson and Sons, Ltd.)

313 High Holborn, London, W.C.

#### Applied Science and Industrial Research.

PROF. SODDY and Major A. G. Church both say in NATURE of June 3 that my letter published on May 27 confuses the issue. It may be so: I have never known a controversy in which each side did not, sincerely, accuse the other of the sins of irrelevancy and confusion. I have no desire to enter on a detailed discussion of personal views. My sole aim was to raise certain principles that seemed to me in danger of being overlooked. I think Prof. Soddy's suggestion will meet the case: that readers of NATURE who are interested should obtain a copy of the full report of his address. They can then judge for themselves how much or how little occasion there was to justify my letter.

J. W. WILLIAMSON.

3 Canterbury Mansions, N.W.6, June 12.

## Wireless Telephony.

By PROF. W. H. ECCLES.

WIRELESS telephony has made such rapid progress during the past six or seven years that it must now be looked upon as a possible rival to wireless telegraphy for communication over distances up to a thousand miles. Although telephonic communication demands on normal occasions the expenditure of more power than does communication by Morse signs, yet the superior rapidity with which thought can be conveyed by voice transmission is a weighty advantage; and, besides, telephony often proves more successful than telegraphy when strays and analogous disturbances are bad, partly because the ear is so skilful in following the voice in the midst of other noises, and partly because the context greatly assists comprehension. Many of the recent improvements by which the present position in wireless telephony has been reached are due to the development of the thermionic vacuum valve with three electrodes—called, for short, the triode.

The essential difference between wireless telephony and wireless telegraphy is that the voice is used instead of the Morse key to produce alterations in the radiated electric waves. In continuous-wave wireless telegraphy the Morse key, and in wireless telephony the voice, may be applied in two ways: (1) for altering the wavelength, and (2) for altering the amplitude, of the oscillations in the antenna. A distant receiving station capable of sharp response to the normal wave-length of the sending station picks up less energy from the altered waves passing over it, whichever type of alteration is in use at the sending end; for if the amplitude at the sender is altered, the amplitude of the electric and magnetic fields produced at the receiver is changed correspondingly, while if the wave-length at the sender is altered, the receiving station responds less, because the incoming waves are out of tune with it. In many telegraph and telephone systems both types of alteration occur together.

Once the source of continuous waves is available, the main problem in wireless telephony is to provide means of exciting the transmitting antenna in accordance with acoustic vibrations produced by the voice. The process of moulding the oscillatory currents by means of the voice has come to be called "modulation," and the apparatus used, if distinct from the rest of the transmitting apparatus, is called the "modulator."

The obvious method of modulating a given high-frequency alternating current is to use the familiar apparatus of ordinary line telephony. In our ordinary line telephone services direct current is passed through a carbon microphone, and is constant in value so long as the granules in the microphone are quiescent, but when the granules are made to vibrate by the voice, the current is correspondingly modulated, and may be made to produce sound by the familiar telephone receiver consisting of an electromagnet and an iron dia-

phragm or reed. In wireless telephony the microphone may be used in a precisely analogous way by being placed in the antenna as shown in Fig. 1, or in an earlier circuit as shown in Fig. 2. In the apparatus of these diagrams the oscillatory current may come from an arc, an alternator, or a triode.

A different method of modulating a given source of supply was advocated, especially by R. A. Fessenden in America, early in the history of wireless telephony. The essence of this method was the employment of a condenser of which one surface could be moved relatively to the other by the voice, and this was usually associated with the antenna of the sender. Alterations of the electrical capacity of the condenser produce departures from resonance, and therefore alter the amplitude excited in the antenna by the source of oscillations. On the other hand, the condenser may be used in the circuit generating the oscillations, especially when the source is an arc or a triode, and in this case the frequency of the oscillations supplied to the antenna is modulated by the voice, and conse-

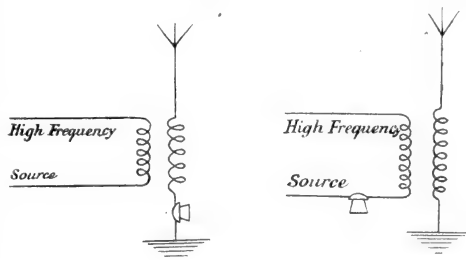

FIG. 1.

FIG. 2.

quently both amplitude and frequency of the oscillations in the antenna are modulated. The condenser has to be of special construction in order that its capacity shall be variable at a frequency of 1000 per second. In the recorded experiments it has consisted of a thin diaphragm placed very close to a fixed parallel plate, and the diaphragm has been acted upon either directly by the voice or indirectly by means of some magnified microphone currents passing through an electromagnet.

The above two methods accomplish modulation by variation of the resistance and of the capacity respectively of one or other of the oscillatory circuits. It is natural to consider the possibility of varying the remaining electrical magnitude—namely, the inductance, self or mutual. The variation of self-inductance has been employed by both German and American experimenters, but perhaps the most successful is that due to E. F. W. Alexanderson, of the General Electric Co. of America. In a broad sense this experimenter takes advantage of the dependence of the permeability of iron upon the intensity of the magnetic

field applied to it. Upon the same core of finely laminated iron there is a winding to carry high-frequency current and one for the microphone current. The microphone current as it varies takes the iron to different magnetic states, alters the permeability accordingly, and therefore varies the self-inductance of the high-frequency coils. Many matters of detail have had to be worked out in perfecting the apparatus; an important one

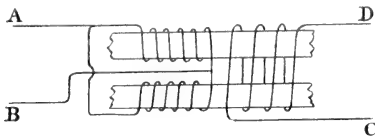

Fig. 3.

may be explained by aid of Fig. 3. Here A, B are the terminals of the high-frequency circuit, and C, D those of the direct-current or microphone circuit. The iron core seen in the figure is part of a closed magnetic circuit; it is in two portions, each of which carries half of the high-frequency winding; the microphone winding encircles both portions of the core. Since the high-frequency windings are wound to exert opposite magnetomotive forces on the halves of the core, they induce negligible high-frequency electromotive forces in the microphone coil.

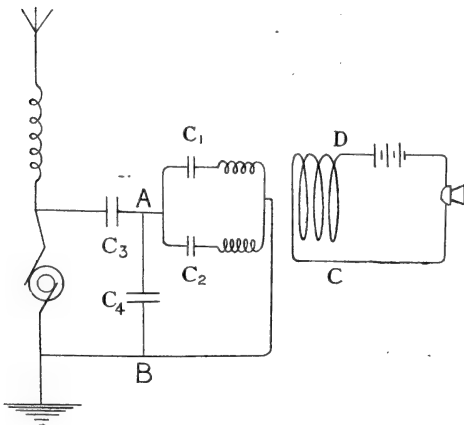

Fig. 4.

The connections of the apparatus to the alternator, the antenna, and the microphone are shown in Fig. 4, which also introduces further details, namely, the four condensers. For simplicity the windings are represented without their cores, though it must be remembered that the operation of the device depends entirely upon the magnetic properties of

iron. The condensers  $C_1$  and  $C_2$  have as their chief function the prevention of the flow of undesired acoustic currents in the high-frequency windings. The condenser  $C_3$  tends to annul some of the non-varying inductance in the circuit comprising the magnetic controller and the alternator, and the condenser  $C_4$  appears to have been introduced for phase adjustment, and enhances the sensitiveness of the whole arrangement to changes of microphone current. The performance of the device is excellent; it is stated that a variation of 0.2 ampere in the direct current through the microphone has been made to alter the power given to the antenna from about 6 kw. to 43 kw.

It was by aid of this device that Ministers in Washington conversed with President Wilson in mid-Atlantic, the voice currents reaching the magnetic controller after passing over land wires from Washington to the New Brunswick wireless station. It will be noticed that in this method of varying an element of the complete antenna circuit the variation is not effected directly by the voice, and in this respect the method is unlike the former two methods.

A related class of methods of modulating the oscillations of the antenna is that in which a voice-varied mutual inductance is employed to transfer the high-frequency energy from the source to the antenna. Perhaps the nearest approach to such a method is that of Kühn, of the Telefunken Co. of Germany, though in his method the self-inductance of the circuits is varied also. The method has not worked out so successfully as that of Alexanderson, and need not be described here.

A third class of methods of modulation aims at varying the activity of the source of high-frequency current; this is in contrast with the preceding methods, in which the functioning of the source is not directly controlled. In the methods to be described the point of application of the control is, so to speak, behind the source, the antenna being supposed to be in front. For example, the direct current that creates the magnetic field of a high-frequency alternator, or the direct current or voltage supplied to one of the circuits of a triode oscillator—that is, an oscillatory circuit sustained in oscillation by means of a three-electrode vacuum valve—might be varied by the voice, and the high-frequency output to the antenna be varied accordingly. Many very miscellaneous schemes have been described; the difficulty is to make a representative selection. The triode oscillator especially lends itself to a multitude of ingenious designs.

In Fig. 5 the circuits of a simple form of oscillator are sketched. The coil marked L is connected at one end to the anode, at the other to the grid, of a triode, the filament being connected to a tapping in the coil. The inductance L of the coil and the electrical capacity C of the condenser constitute the circuit in which oscillations are to be maintained. The action of the circuits may be explained broadly thus: Suppose an oscillatory

current to be flowing in L and C, and that we choose an instant when the grid is, say, at a positive potential relative to the filament and rising in value; in accordance with the properties of these tubes the electromotive force transferred from the grid to the anode circuit of the tube will be from filament to anode outside the tube and rising in value. Thus the electromotive force acting on the portion of the coil in the anode circuit is in phase with the potential difference postulated to exist throughout the coil in virtue of the oscillating current in it, and therefore the electrical motion tends to be maintained.

In such an oscillator the frequency of the oscillations is mainly determined by the inductance and capacity, but every other circumstance of the circuits has its influence. Moreover, the amplitude of the oscillations often varies when the frequency does. Thus if acoustic variations be imposed upon the current employed for heating the filament, or upon the electromotive force in the anode circuit, or upon a source of electromotive force between grid and filament, the high-frequency output of the assemblage varies correspondingly. An ordinary microphone will, it need scarcely be said, be used for converting the voice-made air vibrations into current varia-

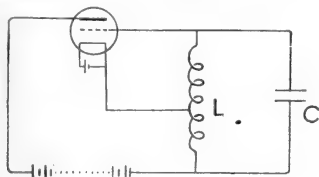

FIG. 5.

tions, and transformers will be used when of advantage for introducing the current variations into the various circuits mentioned above.

One of the most interesting of these methods was described by Major Prince in a paper read recently before the Wireless Section of the Institution of Electrical Engineers, the apparatus being that finally adopted by the R.A.F. for aeroplane work.

The principles employed may be seen from Fig. 6, which is drawn as free from detail as possible. The antenna A is maintained in oscillation by the transmitting triode R<sub>1</sub> in a manner similar to that of Fig. 5; the modulator tube R<sub>2</sub> magnifies the voltages applied to its grid by the microphone currents in the primary of the transformer T. The high voltage for the anode circuits of each tube is supplied by the battery E, which is in series with a large choking coil  $\chi$ . When the microphone is quiescent the full voltage of E acts steadily on the anode of R<sub>1</sub>, but when the microphone produces variable electromotive forces on the grid of R<sub>2</sub> these are multiplied, transferred to the anode circuit of R<sub>2</sub>, and if the choking coil is large enough to be effective, and the condenser C not too large, they reach the anode circuit of R<sub>1</sub>. In consequence the amplitude of the oscillations

generated by R<sub>1</sub> is varied in correspondence with the microphone current variations, and to a small extent the frequency is changed also. This set of apparatus is styled a 20-watt set.

When the normal range of transmission must attain 100 miles, the problem of modulating the necessary power becomes formidable, chiefly on account of the limitations affecting the microphone. It is obvious that direct modulation by means of ordinary microphones is impossible except for small currents, say not exceeding 2 amperes; in consequence, in the endeavour to achieve long-range telephony, special microphones—some of them employing liquid conductors—have been devised, and sometimes many microphones have been used in parallel. At this stage the three-electrode vacuum valve comes to our assistance in various ways, some of which must now be explained. In the first place the triode may be employed as an amplifier of the variable currents or electromotive forces leaving the microphone, and these may be applied to the

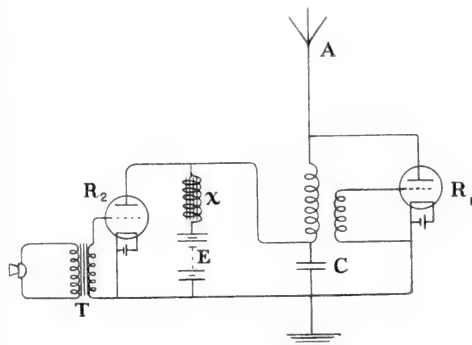

FIG. 6.

modulation of larger high-frequency currents than was before possible; the tube is then the actual modulator. An instance of this appears in Fig. 6. In the second place the triode may be utilised as a by-pass to deflect high-frequency current from the antenna to itself or to other apparatus capable of dissipating the necessary amount of energy—a subtraction method that has proved very successful. The tube may serve in either or both of these functions as modulator of the high-frequency current from arcs, alternators, or other sources of oscillations, not omitting the triode oscillator itself. Evidently the fact that these three-electrode valves can perform the distinct offices of generator of oscillations, magnifier of high and low frequencies, and modulator, and in each office may be associated with a remarkable variety of circuits, may be expected to lead, and is leading, to endless permutations and combinations in the circuits proposed for medium- and long-range wireless telephony.

There is space for brief descriptions of only two examples of large power plants. In 1914

the Western Electric Co. conducted a great experiment from the American naval station at Arlington, near Washington, and succeeded in speaking to the Eiffel Tower (3700 km.), and exceptionally to Honolulu (8000 km.). Triodes were used as oscillators, modulators, and magnifiers. The chain of apparatus was as follows: First came a triode oscillator of small power, which was coupled by means of a high-frequency transformer to the grid circuit of a medium-sized tube. This grid circuit contained also the secondary winding of a transformer, the primary of which carried the currents from the microphone. The anode circuit of this medium triode therefore contained magnified modulated current of the high frequency dictated by

type. A diagram of the chief parts appears in Fig. 7, from which are omitted all details regarding the heating currents for the filaments and concerning the rectifying of the high-voltage current for the anode circuits. The oscillations are generated in the circuit LC by a bank of six large three-electrode valves in parallel marked  $O_6$ , and transferred to the antenna by the coupling  $k$ . The absorption tubes are three in number, and are shown at  $A_3$ ; their three anodes are large enough to dissipate all the energy normally given to the antenna. These absorption triodes are controlled by applying to their grids the speech electromotive forces after these have been magnified by the successive triodes  $M_1$  and  $M_2$ . The total consumption of power is 20 kw., including

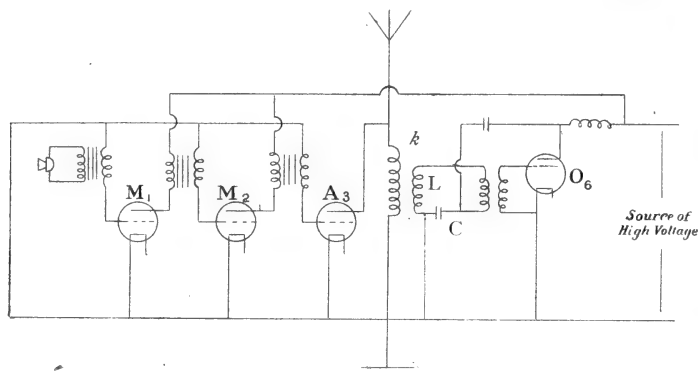

FIG. 7.

the small triode oscillator. The current was next transferred by means of a transformer from this anode circuit to the grid circuit of a bank of medium-sized amplifying tubes connected in parallel, and was again magnified, and finally it was transformed once more into a circuit containing the grids of more than 500 parallel connected tubes. It ought to be remarked that great progress has been made since 1914 in the manufacture of power bulbs, and that the experiment can now be carried out on a larger power scale with a far smaller array of tubes.

The remaining example to be cited is the recently erected 20-kw. plant of the Marconi Co. During the past few weeks it has transmitted good quality speech to a distance of 1500 miles. In principle it is of the subtraction or absorption

all that necessary for heating the filaments, the height of the aerial is 400 ft., and the wavelength 2750 metres.

It will be noticed that the above are all one-way methods—that is to say, the two persons using two stations for conversation must speak in turn, and the listener must wait for the speaker to finish before he switches over from his listening circuit to his speaking circuit. This falls far short of perfection. For perfect telephony it is essential that both persons shall

be able to speak and hear simultaneously if they so desire, as in ordinary line telephony. For information about the most modern attempts at duplex telephony a paper read recently before the Institution of Electrical Engineers by Mr. P. P. Eckersley should be consulted. Until a complete duplex method is devised and proved, wireless telephony must remain a somewhat irksome mode of communication for public use. The ideal method will be such that a wireless station on this side of the Atlantic could be connected over land lines to, say, London, and a station on the other side connected by land lines to New York, and the persons using the apparatus would be unable to tell that wireless telephony across the ocean had been an agency in the transmission of their voices.

## The Meteorology of the Temperate Zone and the General Atmospheric Circulation.

By PROF. V. BJERKNES.

[IN Norway, since the year 1918, an attempt has been made to base forecasts of weather on the application of a very close network of meteorological stations. The study of the corresponding very detailed synoptic charts has led to interesting results even for large-scale meteor-

ology. These are due especially to three young meteorologists, J. Bjerknes, H. Solberg, and T. Bergeron, who have been attached to this service, and will return to the subject in detailed papers.

A very short summary of some of the main

results will be given here. These will be seen to give, to some extent, both verifications and further developments of ideas, which, although advanced by leading theoretical meteorologists, have not yet exerted any noticeable influence upon the development of meteorology.<sup>1</sup>

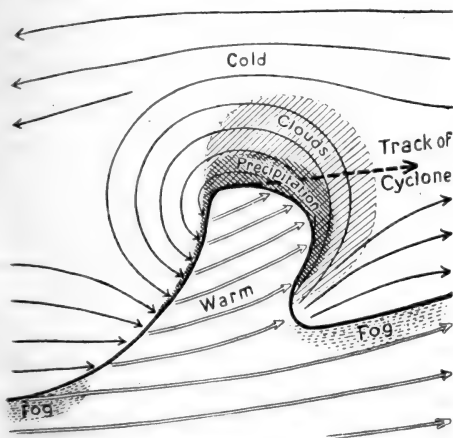

FIG. 1.—Cyclone.

Great changes in the weather in our latitudes have been found to depend upon the passage of a line of discontinuity which marks the frontier between masses of air of different origin. A line of this kind was first found to exist in every

current of cold air (Fig. 1). The whole system moves with the east-bound current, and the cyclonic centre with the lowest pressure is in the region where the cyclonic track touches the border of the tongue. The front border, before this point, is curved like a reversed "S"; the rear border, behind this point, has a uniform concave curvature. Along the front border warm air from the tongue ascends the barrier formed by the cold air, which, in return, passes round the tongue in order to penetrate below the warm air along the rear border. Two bands of rain are thus formed—a broad one in front of the tongue, where the warm air spontaneously surmounts the cold, and a narrow one, generally called the squall line, along the rear border, where the advancing cold air violently lifts the warm air of the tongue.<sup>2</sup>

It has been found by use of the detailed maps that the line of discontinuity exists even outside the cyclone, passing from one cyclone to the other; they follow each other along a common line of discontinuity, like pearls on a string.

When one has become acquainted with all the signs—direct and indirect—which are seen to indicate the position of a line of discontinuity on the very detailed maps, it proves possible to discover them even on less detailed maps. Fig. 2 shows roughly the course of such a line, on January 1, 1907, as it may be drawn upon the Hoffmeyer maps of the Atlantic Ocean for that day. When similar charts are drawn from day to day, as accurately as circumstances allow, a series of large-scale results very distinctly presents itself.

Though we have been able to draw the line only half round the pole, there can be no doubt that

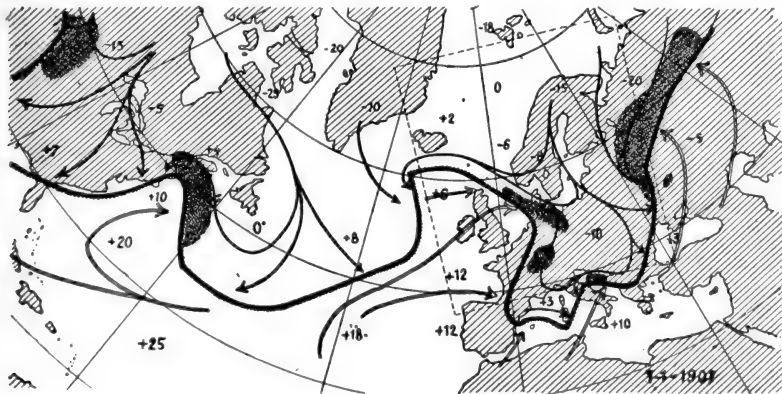

FIG. 2.—Line of demarcation between polar and equatorial air, January 1, 1907.

cyclone which is not perfectly stationary. It here borders a tongue of warm air, which from an east-bound current penetrates into a west-bound

<sup>1</sup> Dove: "Das Gesetz der Stürme." Vierte Auflage (Berlin, 1873).  
 Helmholtz: "Ueber atmosphärische Bewegungen," Sitzungsberichte der K. Preuss. Akad. der Wissenschaften 1885, *Meteorologische Zeitschrift*, 1888.  
 Brillouin: "Vents Contigus et Nages," *Annales du Bureau Central Meteorologique*, 1898.  
 Margules: "Energie der Stürme," *Jahrbuch der K. K. Centralanstalt für Meteorologie*, 1903, Anhang.

it surrounds the polar regions as a closed circuit. On the northern side of this line all signs indicate air of polar origin; it has a low temperature for the latitude, shows great dryness, distinguishes itself by great visibility, and has a prevailing

<sup>2</sup> Cf. W. N. Shaw: "Forecasting Weather," p. 212 (London, 1912).  
 J. Bjerknes: "On the Structure of Moving Cyclones," *Geofysiske Publikationer* (Kristiania, 1919).

motion from east and north. On the southern side of the line the tropical origin of the air is recognised by the corresponding signs—its generally higher temperature, its greater humidity, its haziness, and its prevailing motion from west and south. There can then be no doubt concerning the origin of the line. Heavy, cold air flows out along the ground from the polar regions. It is separated from the overlying warmer air by a surface of discontinuity, the height of which above the ground decreases very slowly until it cuts the ground along our line of discontinuity. Thus this line shows how far the cold air has succeeded in penetrating; it is a kind of *polar front line*.

Along the whole of this front line we have the conditions, especially the contrasts, from which atmospheric events originate—the strongest winds, the most violent shifts of wind, and the greatest contrasts in temperature and humidity. Along the whole of the line formation of fog, clouds and precipitation is going on, fog prevailing where the line is stationary, clouds and precipitation where it is moving.

The line has a wavy form, and is in a continuous undulating motion, thereby sweeping over the whole of what is called the temperate zone. The wavy form comes from alternately cold and warm tongues of air, which extend themselves towards the equator or the pole. The whole system is moving from west to east, while the line, at the same time, changes its form, especially when great masses of accumulated cold air are expelled from the central polar regions. The more wavy the form of the line, the more tempestuous and variable is the weather. At the northern ends of the warm tongues the air motion which characterises cyclones is recognised, and the corresponding areas of rain are seen so far as it has been possible to mark them from the few observations; these are the places of great storms and low barometric pressure. The broad tongues of polar air, on the other hand, bring the clearing up between the successive storms and the corresponding higher barometric pressure.

Two expanding tongues of cold air may occasionally cut off from its base an interjacent tongue of warm air. Then the storm at the polar end is no longer supplied by warm air, and soon loses its power; this is the death of a cyclone. A tongue of polar air which has extended itself too much towards the tropics may be cut off in a similar way; or, as the consequence of a new outbreak of polar air, a more retired front may

be formed behind one too far advanced. In this way great isolated isles of polar air are formed in lower latitudes; this gives the formation of great anticyclones, which generally bring settled, good weather. Thus anticyclones are born as cyclones die. Cyclone and anticyclone and all meteorological events of the temperate zone are in the most intimate way related to the polar front and its motion.

This expulsion of great masses of polar air, which leads to the formation of anticyclones, also enters as an essential element into the great atmospheric circulation. There is a practically continuous flow of warm air along the ground from the "highs" of the sub-tropic calms towards the polar regions. This flow concentrates itself in the warm tongues, and continues into the polar regions in upper levels. Here the air is cooled, and eventually reaches lower levels. Thus increasing masses of cooled air are accumulated behind the polar front. This must continuously advance, with the effect that the tracks of the corresponding cyclones are always moved further towards the south. Finally, at the place of least resistance, great masses of cold air break through and are expelled in the direction of the tropics. The polar front performs a corresponding retreat, the cyclonic tracks are again displaced to the north, and the type of weather is changed. Then the same action repeats itself. This intermittent form of the great atmospheric circulation is especially pronounced in the winter. During the summer the polar front is far back, and the high temperature of the continents exerts a considerable influence; then occasionally a continuous return of polar air may be established along the west coast of the continents, leading direct into the trade winds.

These results cannot fail to exert a considerable influence upon the methods of weather forecasting. All meteorological events of the temperate zone, great and small, are derived from the general atmospheric circulation described above, as we know it from the motions of the polar front. If we succeed in watching it effectively it should be possible not only to give short-range forecasts a hitherto unattained accuracy, but also to complete them by long-range forecasts giving the general character of the weather perhaps for weeks ahead. These two kinds of forecast could be extended to all regions of the temperate zone—oceanic as well as continental. The required survey of the polar front is merely a question of organisation.

### The Cardiff Meeting of the British Association.

PREPARATIONS are going steadily forward in Cardiff for the forthcoming meeting of the British Association from Tuesday, August 24, to Saturday, August 28 inclusive. Owing to the crowded state of the town, the question of accommodation is causing difficulties, but these will, it is expected, be satisfactorily overcome. A list of

hotels and lodgings will be issued at the end of the present week.

The Marquis of Bute has generously offered to give a garden party at the Castle on the Wednesday afternoon, and the invitation has been gratefully accepted by the Lord Mayor on behalf of the local executive committee. Owing to the



difficulties of transport, it has been necessary to give up the proposed reception by Lord Treowen on that afternoon, but it is hoped that arrangements can be made for a visit to be paid to Llanover in connection with one or more of the Saturday excursions.

A long list of works, factories, and other industrial undertakings has been compiled, some of which are sure to be of interest to the various members of the association.

Exhibitions will be a great feature of the meeting. The National Museum of Wales is arranging to display some of its treasures. There will be an exhibition of pictures and charts for school decoration arranged by a committee of the association in connection with the educational section. The botanical section is arranging a special ex-

hibit, whilst collections illustrating the work of the various corresponding societies are being arranged in conjunction with the Cardiff Naturalists' Society.

A reception, specially intended for the members of Section I, will probably be given by Prof. J. Berry Haycraft in the new physiological laboratories of the medical school.

The list of foreign guests who have accepted the invitation to be present includes the names of MM. Bruno and Brioux, representing the French Department of Agriculture; Profs. Cayeux, Laplae, Fauvel, and Yves-Guyot, from France; Prof. Gilson, from Brussels; Profs. Chamberlin, Graham Lusk, and Kofoid, from the United States; Prof. Chodat, from Geneva; Profs. Hasselsbalch and Ostenfeld, from Denmark; and Don. G. J. de Osma, from Madrid.

### Obituary.

PROF. J. R. RYDBERG, FOR.MEM.R.S.

PROF. J. R. RYDBERG, who died in December last after a long illness, made an enduring contribution to science by his investigations of the arrangement of lines in the spectra of the elements. Rydberg was one of the earliest workers on this subject, and he entered upon it with a full realisation of its significance in relation to the structure of atoms and molecules. His classical memoir, "Recherches sur la Constitution des Spectres d'Emission des Eléments Chimiques," was presented to the Swedish Academy in 1889, but he appears to have arrived at his well-known general formula before the announcement by Balmer, in 1885, of the formula connecting the lines of hydrogen.

Notwithstanding the imperfect spectroscopic tables then at his disposal, Rydberg discovered most of the important properties of series spectra, including the relation between corresponding series in the spectra of related elements, and foreshadowed discoveries which were made later, when experimental work had sufficiently advanced. Some of the features noted by Rydberg were observed about the same time by Kayser and Runge, but his work had the special merit of connecting different series in the spectrum of the same element into one system, which could be represented by a set of simple formulæ having but few adjustable constants. He especially insisted that the hydrogen constant, now generally called the "Rydberg constant," should appear in the formulæ for all series, and, apart from slight variations from element to element suggested by the theoretical work of Bohr, nearly all subsequent attempts to improve the representation of series have involved this supposition, and have had Rydberg's formula as a basis.

Other valuable contributions to the subject were made by Rydberg, but the memoir above mentioned is the most comprehensive of his published papers; it is a perfect model of a scientific investigation, and may still be read with advantage by all students of physics.

Much attention was also given by him to the

chemical and physical properties of the elements in relation to the periodic system, and in 1913 he published his suggestive memoir, "Untersuchungen über das System der Grundstoffe." His later work in this connection was seriously interrupted by ill-health.

Rydberg was born at Halmstad, in Sweden, on November 8, 1854, and entered the University of Lund in 1873. He obtained the doctor's degree in mathematics six years later, and after holding appointments in the departments of mathematics and physics, was appointed professor of physics in the University in 1901. About a month before his death he had retired from his professorship on reaching the age-limit of sixty-five years. He was elected a foreign member of the Royal Society in 1919.

THE death is announced of PROF. A. A. INOSTRANSEFF, who was for many years professor of geology in the University of Petrograd. Inostranseff was born in 1843, and began his geological researches in Germany, where he was led to devote special attention to petrology. His first paper, on the microscopic structure of some Vesuvian lava, was published at Halle in 1872. On his return to Russia he made important observations on the opaque minerals in crystalline rocks and on the metamorphic rocks of the Government of Olenez. He also did much geological surveying in the Caucasus in connection with projected railways. His interests gradually widened, and in 1882 he published a volume (unfortunately in the Russian language) on man in the Stone Age round Lake Ladoga. He had much success as a teacher, and among other researches which he encouraged may be particularly mentioned those of his pupil, the late Prof. Amalitsky, on the Permian deposits of northern Russia. The Permian theriodont reptile *Inostransea* commemorates his name.

WE regret to announce the death, on June 19, of Dr. F. A. Tarleton, senior fellow of Trinity College, Dublin, a former professor of natural philosophy, and president in 1906 of the Royal Irish Academy.

## Notes.

By the gracious command of the King, the Society of Tropical Medicine and Hygiene, which was founded in June, 1907, will henceforth be known as "The Royal Society of Tropical Medicine and Hygiene."

WE recorded last week that at the anniversary meeting of the Linnean Society on May 27 the gold medal of the society was handed by the president to Sir Ray Lankester, to whom it had been awarded by the president and council. The president's anniversary address was devoted to an account of our present knowledge of the earliest known fossil fishes—the Ostracoderma—in the investigation of which Sir Ray Lankester was a pioneer, his monograph on Cephalaspis and Pteraspis having been published by the Palaeontographical Society in 1870.

THE first gold medal ever given by the Institution of Sanitary Engineers was presented at the annual summer meeting of the institution last week to Major A. J. Martin "for his services in originating Health Week and in the development of civil and military sanitation before and during the war."

MR. MARCONI, who has just returned from Italy by sea, has favoured us with the following appreciative reference to the late Prof. Righi:—"Although I never had, as is often stated, the privilege of being a pupil of Prof. Righi, I have always had, as is well known, a very deep admiration for him and for his great and far-reaching work in connection with physics, and particularly electric waves. Prof. Righi, whom I knew well personally, was a man of singularly unassuming character, and by his death not only has Italy lost one of her foremost scientific men, but the world also loses a brilliant and original worker in the field of electrotechnics."

DR. F. G. COTTRELL, Director of the U.S. Bureau of Mines, has been awarded the Willard Gibbs medal of the Chicago Section of the American Chemical Society.

THE annual summer meeting of the Anatomical Society of Great Britain and Ireland is to be held at Cambridge on July 2 and 3. Papers on the morphology and development of the central nervous system have been promised, and there will be discussions on the structure of the earliest land vertebrates, the partial transposition of the mesogastric viscera, and avian structure as bearing upon problems of bird migration.

WE are informed by the Secretary of the Department of Scientific and Industrial Research that the Research Association for the British Motor Cycle and Cycle Car Industry has been approved by the Department as complying with the conditions laid down in the Government scheme for the encouragement of industrial research. As the association is to be registered as a non-profit-sharing company, the promoters have applied to the Board of Trade for the issue of a licence under Section 20 of the Companies (Consolidation) Act of 1908. The secretary of the committee engaged in the establishment of this association is Major H. R. Watling, "The Towers," Warwick Road, Coventry.

NO. 2643, VOL. 105]

At the eighty-sixth annual general meeting of the Royal Statistical Society, held on June 15, the following elections took place:—*President*: Sir R. Henry Rew. *Treasurer*: Mr. R. Holland-Martin. *Honorary Secretaries*: Mr. A. W. Flux, Mr. M. Greenwood, and Sir J. C. Stamp. *Honorary Foreign Secretary*: Mr. R. Dudfield. *Council*: Mr. W. M. Acworth, Dr. J. Bonar, Dr. A. L. Bowley, Miss Clara E. Collet, Major L. Darwin, Mr. G. Drage, Mr. R. Dudfield, Mr. A. W. Flux, Sir D. Drummond Fraser, Mr. J. H. Gorvin, Mr. M. Greenwood, Sir Robert Hadfield, Bart., Sir Edgar J. Harper, Mr. R. G. Hawtrey, Sir H. E. Haward, Mr. R. Holland-Martin, Dr. L. Isserlis, the Right Hon. F. Huth Jackson, Mr. A. W. W. King, Mr. H. W. Macrosty, Mr. E. R. P. Moon, Sir Shirley F. Murphy, Mr. H. V. Reade, Mr. C. P. Sanger, Dr. E. C. Snow, Mr. J. C. Spensley, Sir J. C. Stamp, Sir A. D. Steel-Maitland, Bart., Mr. T. H. C. Stevenson, and Mr. H. Withers. It was announced that the Guy medal in gold had been awarded to Dr. T. H. C. Stevenson.

MR. JULIAN BAKER has been re-elected chairman of the London Section of the Society of Chemical Industry, and Dr. Monier Williams is to take the place of Dr. S. Miall as honorary secretary, Dr. Miall having resigned the position. The new members of the committee are Mr. A. Chaston Chapman, Mr. J. Conner, Mr. A. H. Dewar, Dr. B. Dyer, and Prof. W. R. E. Hodgkinson.

THE U.S. National Research Council, a co-operative organisation of leading scientific and technical men of the country for the promotion of scientific research and the application and dissemination of scientific knowledge for the benefit of the national welfare, has elected the following officers for the year beginning July 1:—*Chairman*: H. A. Bumstead, professor of physics and director of the Sloane Physical Laboratory, Yale University. *First Vice-Chairman*: C. D. Walcott, president of the National Academy of Sciences and secretary of the Smithsonian Institution. *Second Vice-Chairman*: Gano Dunn, president of the J. G. White Engineering Corporation, New York. *Third Vice-Chairman*: R. A. Millikan, professor of physics, University of Chicago. *Permanent Secretary*: Vernon Kellogg, professor of biology, Stanford University. *Treasurer*: F. L. Ransome, treasurer of the National Academy of Sciences. The Council was organised in 1916 under the auspices of the National Academy of Sciences to mobilise the scientific resources of America for work on war problems, and re-organised in 1918 by an executive order of the President on a permanent peace-time basis. Although co-operating with various Government scientific bureaux, it is not controlled or supported by the Government. It has recently received an endowment of five million dollars from the Carnegie Corporation, part of which is to be expended for the erection of a suitable building in Washington for the joint use of the Council and the National Academy of Sciences. Other gifts have been made to it for the carrying out of specific scientific researches under its direction.

DR. R. S. MORRELL has been elected president of the Oil and Colour Chemists' Association in succession to Dr. F. Mollwo Perkin.

DR. V. H. MANNING, lately director of the U.S. Bureau of Mines, has been appointed director of research in the American Petroleum Institute.

DR. J. R. ANGELL, chairman of the U.S. National Research Council and professor of psychology in the University of Chicago, has been elected president of the Carnegie Corporation of New York.

MR. E. C. R. ARMSTRONG describes in the June issue of *Man* an interesting acquisition by the Royal Irish Academy of two penannular rings with cup-shaped ends, two bracelets, and an elaborately decorated disc—all of gold—found last year in a bog in Co. Cavan. The gold disc is of special value. The ornamentation, which was probably made by pressing the gold plate into a bronze matrix, is so fine that it is scarcely going too far to describe it as the most delicately decorated gold object belonging to the Bronze age that has up to the present been acquired by the Irish National Collection. The use of these discs has been a matter of doubt, but we have a parallel in a bronze specimen found at Trundholm Moss, in the north of Zealand, and another of Irish origin in the British Museum. The ornamentation is probably connected with sun worship, but the Cavan discovery is of additional importance in that now for the first time a gold disc has been found in Ireland associated with objects, such as the gold rings and bracelets, which can be dated in the later portion of the Bronze age.

In the same journal Mr. J. Reid Moir describes the discovery of an early Neolithic "floor" in the neighbourhood of Ipswich. On the surface of the gravel underlying a stratum of peat a flint implement of grey material, not rolled or patinated, representing a well-recognised type of an early Neolithic axe of the chipped and polished variety, was unearthed. In association with this, flakes, apparently of the Moustertian order, almost certainly more ancient than the Neolithic axe, were discovered. The mammalian bones associated with the "find" were examined by Prof. Arthur Keith, who identifies two varieties of the horse, large and small, of oxen, red deer, a wolf or large dog, pigs, and sheep. The horse-bones had been smashed up, apparently for the extraction of marrow.

In *Sudan Notes and Records* (vol. iii., No. 2, April, 1920) the Rev. D. S. Oyler describes the Shilluks' belief in medicine men. They undergo a rite of initiation. A fact of interest connected with them is that "many of the medicine men have physical defects, their children are usually rickety, and many of them are deformed. The natives say that this is caused by the fact that the shades of his victims bring a curse on the medicine man, and also on his family." Few Shilluks will admit that they believe in his powers, but they seek him constantly, and their whole manner of life is influenced by the witch doctor. "So long as the Shilluks are dominated by

the medicine men they will make very slight advancement in their mode of thought and their manner of living."

The twenty-sixth Report of the Danish Biological Station to the Board of Agriculture (Copenhagen, 1919) contains two valuable memoirs. The first, by Mr. P. Boysen Jensen ("Valuation of the Limfjord, I.: Studies on the Fish-food in the Limfjord, 1909-1917"), summarises the work of several years based on valuations of the bottom invertebrate fauna with its special significance as fish-food. The study of the amount of food present in each year, its variation, rate of growth, and connection with the plaice fishery, shows interesting results. The fauna varies from year to year in both amount and kind, and the breeding seasons of the most important species differ, some breeding yearly, others apparently only once in several years. A careful comparison of the annual production and consumption shows that in certain areas the food is not sufficient to support an unlimited transplantation of plaice, and that the years which were specially bad for fishing were those in which there was an unusually small amount of food available. Prof. C. G. J. Petersen, in the second memoir ("Our Gobies (Gobiidae) from the Egg to the Adult Stages"), adds much to our knowledge of the young stages of these little fishes, so numerous in our seas and so difficult to identify in their early life. We note with satisfaction that he finally allows the specific value of *Gobius minutus* and *G. microps*, hitherto usually regarded as distinct forms of one species, and shows that they can be distinguished throughout their life by skeletal features and by pigment. The very beautiful plates, both coloured and plain, illustrating the various stages in the life-history of the Danish gobies add much to the value of this work.

In part iii. of their remarkable series of memoirs on Old Red Sandstone plants from the Rhyne chert-bed of Aberdeenshire (not younger than Middle Devonian) Dr. Kidston and Prof. Lang give a full and abundantly illustrated account of a third generic type, *Asteroxylon Mackiei*, of vascular Cryptogams discovered by Dr. Mackie, who figured a single transverse section of the stem. Like Rhynea and Hornea, *Asteroxylon* was a terrestrial plant which grew in a peaty soil. The subterranean portion of the plant consisted of slender rhizomes, 1-6 mm. in diameter, without absorbent hairs, having a broad cortex differentiated into an outer and an inner zone, and a simple vascular strand of spiral tracheids surrounded by a cylinder of phloem. Branches of the rhizome passed through a transitional region characterised by the presence of scale-leaves into aerial foliage shoots 1 cm. to 1 mm. in diameter, bearing numerous spirally disposed small leaves; and it is probable that certain slender leafless branches occasionally associated with them represent fertile shoots which bore pear-shaped terminal sporangia without an annulus, and dehiscing at the broad free end. No actual connection between the leafless axes and sporangia or between either and the shoots of *Asteroxylon* has been demonstrated, but there is little doubt that they were parts of one plant. The vascular cylinder of the

leafy shoots had a stellate stele, and from the enlarged ends of the arms small concentric leaf-traces were given off, which passed to the base of each leaf but never entered the free lamina. In habit *Asteroxylon* agrees closely with the well-known older Devonian plant, *Psilophyton princeps*, and to a rather less extent with *Psilotum*. It throws light on the morphology of certain Devonian plants known only as impressions, and raises many questions of theoretical interest which are discussed by the authors.

New light on several problems of Arabian geography has resulted from the war. In the *Geographical Journal* for June (vol. lv., No. 6) Dr. D. G. Hogarth deals with certain discoveries in the Hejaz. It has now been found that the watershed between drainage west to the Red Sea and north-east to the Persian Gulf lies further east than was previously supposed. Its exact course has still to be traced, but it certainly lies some distance back from the coast and runs through the Kheibar *harra* east of the Hejaz railway. Further south in Asir it comes nearer the Red Sea. Much material has been collected for the mapping of the Hejaz, especially in the north, against the Gulf of Akaba, and further south between Wejh and Rabugh. The intervening block, except for the littoral, is most imperfectly known. Considerable additions have also been made to our knowledge of the coast-line between Akaba and Aden. Dr. Hogarth concludes his paper by summarising some new information about Medina, of which a Turkish plan and several photographs have now been obtained. A British aeroplane which flew over the city secured a photograph of the railway station and immediate surroundings, but strict injunctions were given not to photograph the Haram or Great Mosque which contains the Tomb of the Prophet. The photograph secured on this occasion is reproduced, among others, with the paper.

THERE seems now to be evidence that so far back as the beginning of the Cambrian period conditions in the sea round the South Pole were not very favourable to life. In a piece of Lower Cambrian limestone dredged by the Scottish Antarctic Expedition from the bed of the Weddell Sea, and in other fragments of the same rock from the moraine of the Beardmore glacier on the opposite side of the South Pole, numerous remains of the sponge-like Archæocyathinæ have been found closely similar to those discovered in a corresponding formation in South Australia. All the Antarctic forms, however, are comparatively dwarfed, and show various thickenings and irregular additions to the skeleton which denote a struggle with adverse conditions. The specimens are described in great detail, with excellent illustrations, by Dr. W. T. Gordon in the Transactions of the Royal Society of Edinburgh (vol. lii., part iv.), but they do not throw any new light on the affinities of these remarkable fossils. They are associated with ordinary spicules of sponges, fragments of shells and trilobites, and a considerable growth of calcareous alga.

THE *Museums Journal* for June welcomes the chance of increased co-operation between the University and the British Museum that would be afforded by the

new site offered to London University, but points out that concentration is not altogether to the advantage of students arriving from the various residential districts, and that concentration in a restricted area will check the inevitable expansion of both University and Museum. This enforces, from another aspect, the argument put forward by Sir E. Sharpey Schafer in *NATURE* for June 17.

THE advances made in wireless telegraphy and telephony during the war were enormous, and in all the three fighting Services it has established itself as indispensable. A large section of the Signals experimental establishment at Woolwich is now devoted to the development of equipment to meet the requirements of the Army, which differ in several respects from those of the Navy or Air Force. Much of the apparatus has to be specially compact and mobile, and for the circumstances of modern warfare the quantity of messages to be dealt with in a short time renders high speed of transmission essential. The adaptation of the Wheatstone automatic transmitter, working from a previously punched paper strip, to wireless working enables speeds of transmission from 450 to even 1000 words per minute to be attained. The small currents through the contacts which are sufficient for wireless apparatus render the conditions particularly favourable for high speeds. Particular attention is given to the linking-up of line with wireless systems. High-speed messages come in over the wire in the ordinary way, and are automatically handed over to the wireless apparatus without loss of time in re-transmission. Another recent development of wireless working, finding particularly useful application in the Army, is direction-finding, and very compact sets for this purpose with a range up to 250 miles are now being standardised at Woolwich. A point to which special experiment is being directed is the obtaining of a high degree of selectivity by which extraneous waves from near and far can be "tuned out" and the feeblest messages of the required frequency amplified to the extent necessary for satisfactory reception.

THE Deutsche Seewarte is resuming its activity in the direction of publications. We have received a report for the five years 1914-18, thirty-seventh to forty-first year of the institution, and with it an overdue report published in 1914 of a survey voyage of S.M.S. *Möwe* in 1911 to the West Coast of Africa. The course was from Wilhelmshaven to Ferrol, Cadiz, Teneriffe, Dakar, Freetown, Lome, Lagos, Lome, Accra, Lome, Duala, Banana, Boma, Swakopmund, and Lüderitzbucht, the last being reached on October 7, 1911. The expedition went up the Congo as far as Boma. Observations were taken of the depth of the sea and of the currents, temperature, density, and salinity at different depths down to 2000 metres. This oceanography, divided into the three sections, North-West, Equatorial, and South-West Africa, was directed by Drs. G. Schott and B. Schultz. A meteorological log was kept by Dr. P. Perlewitz, including some kite observations. The regular observations were taken at intervals of four hours, whether in harbour or on voyage, and the elements tabulated, in addition to the latitude and longitude, are direction and force of the wind, barometer,

dry- and wet-bulb temperature, relative humidity, cloudiness, sea-surface temperature, strength of current, and rainfall, with notes of any unusual phenomena, including the appearance of albatrosses and schools of dolphins or flying-fish. The charts included with the publication show the salinity and temperature in depth sections, the one for Mogador giving salinity, temperature, and density separately. The salinity seems to decrease southwards, and also generally with increasing depth.

THE March number of *Terrestrial Magnetism and Atmospheric Electricity* contains a summary, by Mr. J. P. Ault, of the results of the magnetic survey of the Atlantic made by the *Carnegie* during her voyage from Washington to Dakar, West Africa, and Buenos Aires during the autumn and winter. While the values found for the magnetic dip differ often by two or three degrees from those given in the last Admiralty Charts 3598, 3603, and 3775, the values of the observed deviation of the compass to the west differ by more than a few tenths of a degree from the charted values in certain limited regions only. Thus in the region between the Gold Coast and the Island of Ascension the Admiralty Chart gives the deviation to the west about one degree too large, and between Trinidad and Buenos Aires there is a considerable area in which the deviation is given too small by the same amount.

OWING to the decrease in research at Harvard during the war, vol. xiii. of *Contributions from the Jefferson Physical Laboratory* covers the three years 1916-7-8, and at least a third of the volume is devoted to Dr. P. W. Bridgman's work on the effects of pressure on the electrical resistance and thermo-electric properties of more than twenty metals. The pressures used reach 12,000 kilograms per sq. cm., and the temperature ranges between 0° C. and 100° C. With the exception of wires of bismuth and antimony, the resistances of metallic wires subjected to hydrostatic pressure decrease with the pressure, following a linear law approximately, and at 10,000 kilograms per sq. cm. have values about 99 per cent. of their values at atmospheric pressure in the case of cobalt and tungsten down to about 90 per cent. in the case of lead, tin, and cadmium. The temperature-coefficient of resistance remains almost unchanged. The effect of pressure on the thermo-electric properties is much more variable. The normal effect is to increase the thermo-electric power of the metal, but in three out of the twenty metals tried this is not the case. In most cases both the Peltier and the Kelvin effects are increased, but there are many exceptions. The author considers that the electron theory is quite incapable of explaining these results.

WE have received from Messrs. C. Baker, High Holborn, W.C., their classified list (No. 69) of second-hand scientific instruments. The list includes microscopes and accessories, telescopes and field-glasses, spectrosopes, surveying, astronomical, projection and physical apparatus, and contains particulars of more than 2000 pieces of apparatus. In these days of high prices intending purchasers would be well advised in the first place to consult Messrs. Baker's catalogue.

### Our Astronomical Column.

MERCURY AN EVENING STAR.—The greatest elongation of Mercury (E. 25° 41') occurs on June 29. On June 24 the planet will set at 0.54 G.M.T., or 1h. 34m. after the sun, and may possibly be detected close to the W.N.W. horizon by anyone with a good eye. A field-glass should render the planet distinctly visible about an hour after sunset.

THE ZEEMAN EFFECT IN FURNACE SPECTRA.—In continuation of his well-known researches on furnace spectra, Mr. A. S. King has recently been investigating the Zeeman effect for iron and vanadium in the electric furnace. Observations of the effect of a magnetic field on spectra have up to the present been chiefly confined to spark spectra, so that it is interesting to compare the effects when different sources are used. The electric furnace possesses, in addition, certain advantages over spark spectra for this purpose, since most of the low temperature lines are much more readily examined. Also, the inverse effect for absorption spectra is easily obtained by introducing a graphite plug to give a background of continuous spectrum. A description of the apparatus and results is given in the *Astrophysical Journal* for March. The furnace tube was placed parallel to the lines of force in a field varying from 6500 gauss in the centre to 9000 gauss near the ends, and observations were made of one hundred iron lines and ninety vanadium lines. The results of these preliminary observations seem to show that the effect is independent of the source used, since the observed separations agree both in character and magnitude with those of corresponding spark lines.

THE LUNAR PARALLAX AND RELATED CONSTANTS.—There is a set of quantities (the radius and figure of the earth, the intensity of gravity, the moon's parallax and the motion of her perigee and node) which are so intimately related that an alteration in one compels corresponding alterations throughout. Prof. W. de Sitter has endeavoured to obtain a mutually consistent series of values, and gives the results in vol. xvii. of the Proc. of the Royal Academy of Science, Amsterdam. It is impossible in a brief note to do more than give his conclusions.

Mean radius of earth—i.e. radius in geogr. lat. the sine of which is  $\frac{1}{3}$ —= 6,371,237 metres.

Value of gravity at that latitude (unaffected by centrifugal force), 9.82014.

$$\pi' = \sin \epsilon \text{ moon's parallax} / \sin \epsilon' = 3422.544''.$$

Compression of earth, 1/296.0.

Constant of precession, 50.250''; luni-solar precession, 50.373''.

Mass of moon, 1/81.50  
 $\frac{C-A}{C} = 0.0032775$ ; where C, A are the principal moments of inertia of the earth.

Also, if A', B', C' are the three principal moments of inertia for the moon, and

$$\alpha = \frac{C' - B'}{A'}, \quad \beta = \frac{C' - A'}{B'}, \quad \gamma = \frac{B' - A'}{C'},$$

$\beta$  is found to be 0.000626, and  $f = \frac{\alpha}{\beta} = 0.92$ .

This value of  $f$  is much larger than those previously found, which ranged from 0.49 to 0.75. In other words, the present paper makes the moon's equator less elongated towards the earth than previous determinations.

Prof. de Sitter's investigation reminds us of the late Prof. Harkness's "solar parallax and related constants." By a combination of all available evidence he deduced, nearly thirty years ago, a value of the solar parallax practically identical with that now accepted.

### The Centenary of Sir Joseph Banks, Bart.

THE commemoration of the centenary of Sir Joseph Banks, Bart., who died on June 19, 1820, was celebrated by the Linnean Society on Thursday last, as mentioned on p. 406 of NATURE for June 17. After the usual formal business, Dr. B. Daydon Jackson read the first communication on "Banks as a Traveller," speaking of his four overseas voyages—first, the visit to Newfoundland in H.M.S. *Niger*, on board which his friend Constantine Phipps, afterwards Lord Mulgrave, was a lieutenant; next, the adventurous voyage of the *Endeavour*, Lieut. Cook commander, when Banks so amply proved his value in many untoward events; third, the voyage to Iceland; and fourth, his trip to Rotterdam in 1773, when he was still eager for an expedition to the North. The second paper, by Dr. A. B. Rendle, was entitled "Banks as a Patron of Science." Banks's life from his return to England in 1771 until its close in 1820 was that of an enthusiastic, liberal, and generally far-sighted patron of science. A friendship began with King George, which steadily increased, and Banks was consulted on important matters of very various kinds. He became botanical adviser to the King in relation to the Royal Gardens at Kew, which developed under Banks's guidance, becoming the repository of plants of economic and ornamental value from all parts of the world. Banks initiated or encouraged voyages of exploration, and kept up an extensive correspondence with men interested in science overseas. His house in Soho Square was the rendezvous of students and men of all classes interested in schemes of philanthropy or science; his magnificent library and herbarium were at the service of other workers, and after his death were bequeathed to the British Museum. For forty-two years he was president of the Royal Society. He was very closely, though indirectly, associated with the origin of the Linnean Society. Mr. James Britten, in the third paper, began by remarking that much of his paper was based upon the daily use of Banksian specimens for nearly half a century in the British Museum. The author showed that the popular belief that Banks left all his botanic work to his secretaries and curators, Solander and Dryander, was a mistaken one, and that Banks displayed great botanic acquirements.

The president remarked that official records of the British Museum testified to the active interest taken by Banks in all matters connected with its advancement, and that keepers and trustees alike referred to him for his advice and decision.

Certain objects closely connected with Banks were exhibited.

### South-Eastern Union of Scientific Societies.

THE twenty-fifth annual congress of the Union was held at Eastbourne on June 2-6, under the presidency of Sir Edward Brabrook, who in his presidential address dealt with progress in anthropology and economics during the past quarter of a century. In regard to the latter, he expressed the opinion that the war seemed to have dismissed all economic orthodoxy into thin air, with unrestricted paper currency, reckless extravagance, trading by Government, and manipulation of markets, all of which had been borne with patience during war-time, but were intolerable in time of peace. Science had done what it could to provide sound instruction by the issue of standard works.

The second day's business began with a paper by  
NO. 2643, VOL. 105]

Comdr. E. A. Martin on "The Glaciation of the South Downs," in which he endeavoured to show that the chalk hills received their final curving by ice-agency, and attributed much of the "clay-with-flints" deposits and the chalk rubble of the dry valleys to the agency of glaciers, having their rise on the Downs when they were at a greater height, with greater precipitation, and a low snow-line. He had mapped out the blocks of sandstones, ironstones, and sarsens, and concluded that short rivers could not have transported them to where they are now found. He compared the ironstones with similar deposits which have been found at Lenham, on the North Downs, to be of Pliocene age. He referred the rounded contours of the chalk hills to the grinding action of ice, resulting in their appearance now as huge *roches-moutonnées*. Striations were not, as a rule, found, because the rocks were such as would rather crumble and perish under the pressure necessary to produce them. One sarsen at Stanmer was found, however, distinctly to be striated. The author thought that there had been two clear periods of glaciation: one before the deposition of the temperate marine muds at Selsea, at the base of which were the famous Selsea erratics, referable to the glaciation at the close of the Acheulian period, and a later one which gave rise to the Rubble-Drift, after the development of the Mousterian culture. In a brief discussion which followed, the glaciation theory was opposed by Mr. T. Sheppard, of Hull.

Mr. C. C. Fagg read a paper on "First Steps in a Local Regional Survey," in continuation of the efforts which he has made for some years to stimulate the regional survey movement. Prof. Boulger, in the absence through illness of Miss G. Lister, read a paper on "The Eastern Extension of the Lusitanian Flora," with special reference to the locality.

Prof. E. B. Poulton delivered a public lecture on "Mimicry and Migrations of Insects," and this was attended by invitation by numerous boys' and girls' schools in the town. A paper was read by Mr. R. Adkin on "Migrations of Butterflies and Moths in regard to the British Islands." Mr. Adkin dealt with flights of migrating Lepidoptera and movements of larvæ by the agency of the wind, and discussed the question of whether such occurrences are to be considered as chance happenings or as the result of voluntary action on the part of the migrants. Some account was given of observed immigrations on the coast near Eastbourne, and further evidence was asked for. Mr. Adkin showed how the geographical position of the British Islands rendered them singularly suitable for the observation of such phenomena, and suggested the lines of movement by which such immigrants would be likely to reach our coasts. The paper was illustrated by maps and diagrams and by exhibits of the insects referred to.

The matter of the enclosing of so much of the Downs during the last year or two by barbed-wire fences was discussed, and a resolution was carried with much enthusiasm asking that joint steps should be taken by several influential bodies to carry through a scheme for the protection of rights of way over the Downs, and for the acquisition for public use of typical stretches of them.

A large collection of wild flowers was on exhibition during the congress. *Phyteuma spicatum* was said to be growing in large quantities in East Sussex this year, and orchids were found in profusion in and about Beachy Head. Excursions to Pevensey, Alfriston, East Dean, Old Eastbourne, and other places added interest to a very successful congress.

After one of the excursions the party returned to "Hodeslea" to tea. Huxley spent the later years of

his life in Eastbourne, and occupied "Hodeslea," which is now the residence of the Union's treasurer. The house was built by Huxley in 1890 and he lived there until 1895, whilst his widow remained there until her death in 1914. Mr. Adkin has recently placed a bronze tablet on the house relating these facts.

### Genetic Segregation.<sup>1</sup>

By W. BATESON, F.R.S.

LATER developments of genetics have been, in the main, attempts to discover the nature and scope of segregation. Mendel proved that certain characters are determined by unit-factors. Their integrity is maintained by segregation, the capacity, namely, to separate unimpaired after combination with their opposites. We have been trying, first, to ascertain specifically what characters behave in this way, whether there is any limit to the scope of segregation or any classes of characters otherwise transmitted. Among characters known to be subject to segregation are illustrations of most of the features by which plants and animals are distinguished. In regard to two classes of characters the evidence for segregation is, nevertheless, rather noticeably imperfect. No quite clear proof exists that differences in number—meristic characters in the strict sense—are governed by factors comparable with those that control, for example, colour. The extra toe of the fowl and the single leaflet of the monophyllous strawberry are perhaps the best examples, but reservations may be entertained. Also, though segregation can be demonstrated in regard to quantitative characters, parental types thus distinguished often fail to re-appear, and the inheritance is subject to special complications.

Groups or complexes of factors are now recognised as sometimes segregating whole. Were it not that on occasion elements of the complex become independent, the group would pass for one unit-factor. The sex-complex is an obvious example. Intermediate flower-colours, like those of modern sweet peas, probably arise by this process. The plausible suggestion that the new terms are only rare cross-overs in a closely linked series does not fit the evidence. A striking illustration appears in *Oenothera*, in which, as Renner lately showed, several groups of characters normally segregate as single factors. These complexes are in several forms not borne equally by the two sexes of the plant, and most of them cannot exist in the homozygous state. By these discoveries the *Oenothera* problem is greatly elucidated.

The second question is to determine when in the life-cycles segregation can occur. Admittedly it is a phenomenon of cell-division. If we knew the animals only we might confidently adopt the view of Morgan that normal segregation happens during the maturation process at the stage of synapsis, when the maternal and paternal chromosomes are believed to conjugate in pairs. Most of the facts of linkage may be thus well represented, but the absence of crossing-over in the sex-heterozygote (*Drosophila* and silkworm) is not readily explicable, nor is there as yet extensive evidence that the number of linkage-systems agrees with that of the chromosomes—a primary postulate of Morgan's theory. The evidence for an orderly anastomosis, or even of any exchange of materials between chromosomes, is weak; and the visible features of chromosomes are scarcely suggestive of the prodigious heterogeneity requisite. Even if the linkage-systems correspond with the chromosomes,

which is a most attractive conjecture, exchange of material between chromosomes need not be essential to crossing-over. It may be doubted, however, whether the general course of cytological evidence does not point to the rôle of the chromosomes being rather passive than active.

That in plants segregation even in its normal course is not limited to the reduction-division is now certain. In *Matthiola*, *Campanula*, *Begonia*, and *Oenothera* the genetic composition of the male and female organs may be normally different, and segregation cannot have happened later than the constitution of these organs. This kind of segregation must result in *Campanula carpatica* (experiments of C. Pelleu) and in *Begonia Davisii* from the peculiar genetic properties of the female complex, for it re-appears in offspring derived from the female side for several generations at least, but not among those derived from the male side. Collins's evidence from *Funaria* proves further that sex-segregation may happen during the growth of a haploid form.

Periclinal chimæras and the production of distinct types from adventitious buds prove that segregation may take place during somatic development, whether in the differentiation of the layers or of the root. In the genetic properties of the tare-like rogues of peas there are features which not only illustrate the occurrence of gradational change in genetic properties, following somatic differentiation, but also show that this gradation affects the male and female organs differently. From these facts it must be concluded that normal and orderly segregation (apart from chance sporting) can occur at various cell-divisions, and not exclusively at reduction. Not improbably these somatic segregations may be accompanied by some visible cytological differentiation, but that question must not be prejudged.

Having regard to the fundamental distinctions between the morphological relations of the germ-cells to the soma in animals and in the flowering plants, it is not surprising that the processes of segregation should be differently effected in these two groups of organisms.

### Colour Index of the British Isles.

AT a meeting of the Royal Anthropological Institute held on June 15, Prof. Arthur Keith, ex-president, in the chair, Prof. F. G. Parsons read a paper on "The Colour Index of the British Isles." He first reviewed the different ways of constructing an index of nigrescence, and directed attention to what he considered their weak points. Prof. Parsons proposed as a simple and workable index that the percentage in any group of individuals with dark brown and black hair should be added to the percentage with eyes in which any brown pigment is present, and the result divided by two. For practical purposes he found it better to record the percentages of dark hair and dark eyes separately. He then proceeded to examine the large mass of statistics collected by Dr. Beddoe in the middle of the last century, and pointed out that the first deduction was that women are in the mass darker than men, and that where the people are fairest the difference between the sexes is greatest, as the following table shows:

	No. of records	In'ex		Diff.
		M'm	W'c'm'n	
4 Northern Counties	... 1767	26.2	33.5	7.3
3 Eastern "	... 1563	34.4	38.2	3.8
2 Western "	... 4057	45.5	46.7	1.2

It therefore became necessary to exclude those

<sup>1</sup> Abstract of the Croonian Lecture delivered before the Royal Society on June 17.

records of Beddoe in which the sexes had not been kept separate. Fortunately, however, nearly fifteen thousand records on males alone remained available. In the Northern and Eastern Counties, in the lowlands of Scotland, and again in Sussex and Hampshire, the correspondence of the tracks of the hair and eye indices was most marked, whilst in the Western and West-Central Counties, in Wales, and in the Highlands of Scotland the darkness of the hair was very much greater than that of the eyes. It was pointed out that those regions in which the hair and eyes correspond in lightness were historically regarded as the sites of the purest Nordic blood in these islands, while those parts in which the hair track was much higher than that of the eyes were the sites in which we have every reason to believe the Mediterranean blood had mixed most freely with the Nordic. Where the two races had mixed it appeared that the light Nordic eyes and the dark Mediterranean hair were the dominant factors. Except in Wales, a percentage of more than 50 dark eyes is unknown in the British Isles.

On comparing town and country dwellers it was noticed that the towns were darker than the country, except in those parts where the nigrescence was very high, when the reverse was the case. It was suggested that one reason for this might be that the town dwellers were more migratory than those of the country, though probably this did not account for all the difference.

The distribution of red hair was worked out and found to be greatest in Scotland and the North of England, where the nigrescence was least. It was also pointed out that the evidence available showed that it was more prevalent among the upper than the lower classes, and that this probably coincided with a lower index of nigrescence in the upper than in the lower classes.

In opening the discussion, Prof. Keith said that Prof. Parsons's paper was of supreme importance to all who were interested in the origin of the peoples of this country. In his opinion, pigmentation was probably the key to the problem, and Prof. Parsons's new method of estimating nigrescence was a real contribution to the study of the subject. His index was, however, in a sense, an average, and must therefore be used with caution. In referring to the lack of correspondence between hair and eye colour, he instanced the dark hair found in conjunction with grey eyes in Wales, Ireland, and West Scotland—a conjunction also occurring in Scandinavia. After thirty years of observation, however, he himself was still in doubt as to the difference between a Celt and a Saxon, and felt it impossible to distinguish between individuals from, say, Suffolk and Connaught. In his view the basis of the population of these islands was predominantly Nordic.

Dr. Brownlea said that he considered the results based upon the distinction of sex were not quite trustworthy. He held that six distinct races went to make up the population of these islands, one of these being a distinct red-haired race.

Mr. H. Peake, while agreeing with Prof. Keith that averages were untrustworthy, said that Prof. Parsons's index was not quite an average, and in any case it was the best method of dealing with observations which had been advanced so far. The conjunction of dark hair and light eyes was a puzzle. Was it due to a tendency in the Mediterranean race towards light eyes, or was it due to a fusion between the Nordic and Mediterranean types? Certain characters seemed to follow sex, and in cases where there had been an immigrant male population intermarrying with the females of the country, the dominant character of the male reappeared in the male line.

Prof. Parsons's results pointed to this, in that where there was a considerable Nordic influence there were wide sex differences; where Nordic influence was small there was little difference between the sexes. He pointed out that not all red-haired people were alike in shape and colour. It had been suggested that red was a variant of fair hair, e.g. in Scandinavia. The older theory was that it was a border-line colour between fair and black. In Ireland, Wales, and Scotland it might arise from a crossing of Nordic and Mediterranean types. On the other hand, in the North of England it might be a variant of fair hair, as in Scandinavia. But even Scandinavia, he pointed out, was not homogeneous; light and dark types occurred, and therefore in that country also red hair might be due to contact.

Dr. Shruballsaid said that in his investigations of the incidence of dark hair in town populations he had found that the longer the town history of a family, the darker the hair. He pointed out that the occurrence of red hair in the March country of Ireland, Wales, and Scotland supported the view that it was due to contact of light and dark types.

Dr. Stannus said that while investigating albinism in Africa he had found a large number of red-haired individuals, but in these cases the pigment was always found in solution. The problem was biochemical, and, in his opinion, microscopical examination was essential to show whether individual cases were cases of black hair in which the pigment had not been thrown out in granular form.

The chairman, in bringing the meeting to a close after Prof. Parsons had briefly replied, said that the discussion had shown the desirability of a much wider survey of the people than had hitherto been made. The results would have an important bearing upon such questions as the relation between health and race. He hoped that the Government might be induced to help in this great undertaking.

### Army Hygiene and its Lessons.<sup>1</sup>

By LT.-GEN. SIR THOMAS GOODWIN, K.C.B.

UNTIL quite recent years it has never been sufficiently recognised that a very large proportion of Army medical effort should be directed towards the prevention of disease. The fact that in all wars in the past more men died from disease than from enemy action appears to have been accepted more or less with resignation, and regarded as inevitable. During the later years of the nineteenth century the increasing advances in science and our more exact knowledge regarding the aetiology and transmission of infective diseases led many medical officers to attempt to create barriers against the spread of disease by known paths, but there was a lamentable lack of co-ordinated effort.

Towards the close of the eighteenth century we begin to glean something in the nature of figures regarding sickness in armies in the field. In 1792 the allied Austrian and Russian armies were in Champagne; they commenced their retreat on September 30, and by the end of October had evacuated France, and during that short month, without any considerable fighting, they lost 25,000 men, or more than one-fourth of their number, every village being filled with dead and dying.

Accurate figures are unobtainable regarding Napoleon's campaign in 1812, but we learn that in June, 1812, he crossed the Niemen with a magnificent army

<sup>1</sup> From three Chadwick Lectures delivered on March 8, 15, and 22 entitled "Army Hygiene prior to the Recent War," "Army Hygiene during the Great War," and "Army Hygiene in the Future."



of 400,000 men; he reached Moscow on September 14, the retreat began on October 19, and on December 13 he recrossed the Niemen, and of his great army more than four-fifths had melted away.

Probably one of our most disastrous campaigns, from a hygienic point of view, was the Walcheren Expedition of 1809, where our mortality from disease amounted to 346.9 per thousand of strength of troops.

Regarding the Crimean campaign in 1854 I shall say but little; we have all read of the trials and hardships of the troops in that campaign, in which the mortality from disease amounted to 230 per thousand of the strength.

In the Afghanistan War of 1878-80 the mortality was 93.7 per thousand, which appeared to be an improvement compared with the terrible figures which we have just considered.

Bad as these figures are, yet those of other nations are even more unfavourable; for example, in the French Sudanese campaign of 1888-89 the mortality from disease amounted to 280 per thousand—worse figures than those of our own Army in the Crimean campaign thirty-five years previously.

I think that perhaps the most striking example of the havoc which may be wrought by disease on an army in the field is that furnished by the French Army in Madagascar in 1895, where the mortality from disease amounted to 300 per thousand of strength. In this campaign 7 men were killed by the enemy and 94 wounded, while the deaths from disease numbered 5600. The actual admissions for sickness amounted to more than 15,000, or 85 per cent. of the whole force.

The evils in the past were mainly due to lack of co-ordination and of real knowledge on which concerted action could be based. Nevertheless, advances were made, and, as an example of the steady, progressive improvement in the health conditions of the soldier and the increased success in disease prevention, it is interesting to note that in India during the five years 1878-82 the following were our sickness and mortality rates per thousand of men serving among European troops:

	Constantly sick	Deaths	Malaria	Dysentery	Cholera
1878-82	68.1	20.5	569	42.8	5.7 (4.2 deaths)
Compare these figures with those for 1912:					
1912	28.8	4.6	82	5.2	0.3 (0.2 deaths)

As regards conditions in the civil community, probably the first really important step towards an improved condition of affairs in England dates from the passing of the Public Health Act in 1875. Two hundred years ago the annual death-rate in London was 80 per thousand; I think it is now about 18 per thousand.

Military hygiene differs little in theory from that relating to the public health of a civil community, and in times of peace is closely allied to that ordinarily carried out in all branches of the Public Health Services.

There are, however, certain considerable advantages in military hygiene which find no counterpart in civil life. The measures which the sanitary officer recommends, when accepted, are carried out with all the power of military organisation and discipline behind them, and insanitary conditions and disease are subject to a far greater control than can usually be obtained with a civil population; so that, before the South African War, great advances had been made in the status and training of the Medical Service generally, but there were still many defects, the chief of which were lack of organisation in the Sanitary Service, deficient education and training in hygiene of the officers and men of all branches of the Service,

and lack of co-ordination between the Medical Service and the rest of the Army.

Now let us consider the South African War. From what I have said you will realise that we entered on that war fairly equipped with knowledge, but with a deficiency of organisation as regards the hygienic requirements of an army in the field. It is true that affairs improved very considerably during the course of the war, but the unpreparedness at the outset bore its inevitable harvest. During this campaign some 14,000 men died from disease as compared with about 7000 killed. As regards enteric fever, we had 57,684 cases with 8022 deaths. Dysentery alone accounted for 86 admissions per thousand of the strength, and from all diseases we suffered 843 admissions with 24 deaths per thousand of the strength; while wounds in action accounted for 48 admissions with slightly less than 3 deaths per thousand.

South Africa saw the dawn of the organised scientific study of disease as regards its actual incidence in the field. Much of the success achieved by field hygiene and sanitation in the recent war may be traced to experience gained in the war in South Africa.

The Army Medical Service emerged from the South African War convinced of the absolute necessity for improving the sanitary organisation on certain definite lines. It was, in fact, at last generally realised throughout the Army that in war nothing is so costly as disease. The main requirements were, first, the *education* of the troops themselves—officers, non-commissioned officers, and men—in the aims and methods of hygiene. The second necessity indicated was the allocation of certain officers and *personnel* for sanitary work alone, and for their special training, in addition to the continued training of all medical officers, in the very latest scientific work. The third, and perhaps the most important, requisite was *organisation for war*.

This organisation was so arranged as to compass a thorough sanitary control of the lines of communication in order to filter off unfit men suffering from contagious or infective disease, and at the same time to maintain a freedom from disease of all *personnel* passing through the various channels and fixed establishments comprising the lines of communication. In France, for example, during the past war, it may be said that, beyond an outbreak of dysentery at one training centre, clearly traced to an influx of "carriers" from the East, the lines of communication during the whole period were maintained almost free from outbreaks of epidemic disease of any serious or extensive nature.

How very different were the conditions under which the Army took the field in 1914 from those of former wars! The scientific investigations of the preceding years had stabilised to a very large extent the hygienic environment of the soldier. Careful work on his food-stuffs as regards quantity, variety, and quality assured him a sound basis on which to wage war.

Undoubtedly much of the low incidence of infectious diseases enjoyed by the troops in the field during the whole war was due to a high resistance maintained by the ample and excellent condition of the food-supply. In the same way the equipment, clothing, and personal hygiene of the troops had all been envisaged on the soundest lines; while the method and practice of sterilising water-supplies and safeguarding foodstuffs, as well as the disposal of waste products, had been carefully thought out and generally inculcated.

Now let us consider the three main essentials to life, namely, food, water, and air. The *food* of the troops and its intimate relation to that important organ

"on which" (we are informed by high authority) "the army marches" likewise gave cause for the most careful study and preparation. In the past the military ration had been arranged upon more or less empirical lines after actual test marches. During the war, however, the menace of a national shortage of food and the importance of avoiding waste led to more exact studies of the needs of the troops by a detailed assessment of their actual energy output by the method of indirect calorimetry. Simultaneously with these studies, the assessment of the needs of the civil population by the Royal Society (War) Committee furnished information of incalculable value both for the future and, indeed, for the present time of world shortage.

It was a matter of no little difficulty to provide the many varied rations required by different peoples in different theatres at differing seasons and under varied military conditions; but, speaking generally, the Army of eight and a half millions had throughout been fed in such a manner as to enable it to fight effectively, to provide the energy and heat required, and to avoid outbreaks of disease traceable to the diet, with the exception of minor outbreaks of neuritis and scorbutic cases in those most distant areas—Mesopotamia and North Russia. In these localities the difficulty of at once arranging for local produce in severe climatic extremes and the dependence on preserved supplies from home were accountable for the outbreaks in question. Steps were quickly taken, however, to provide the necessary accessory food factors, at first by germinating pulses and by yeast, later by the intensive cultivation locally of fresh foodstuffs—measures which proved of great value both to the native inhabitants and to the troops.

The question of *water-supply* is one of the first importance. During the few years before the war experimental work on the various physical and chemical means of sterilisation—or at least of purification—of water had been carried out in several directions. Just prior to the war dependence had largely been placed on the use of filter-candles, but they were found to be unsuitable for active service conditions, and were replaced in every case by chlorination. The net result of war experience was the undoubted value for sterilisation purposes of chloride of lime in the form of bleaching powder. This substance, as is generally known, contains from 30 to 33 per cent. of available chlorine, which in turn liberates nascent oxygen in water, and this is effectively lethal to micro-organisms. Chloride of lime was used throughout the war as the means of dealing with all water-supply, either in bulk, as in the big "water-points," or regimentally in water-carts, pakhals, or containers of different shapes and sizes. As the war proceeded the need for the provision to advancing troops of properly treated water in large quantities led to the development of special Water-tank Companies. These units—first recommended in France by our own sanitary advisers—are capable of collecting, filtering under pressure through sand, sterilising by chlorine gas (by means of an ingenious regulator), and transporting large quantities of water wherever the motor-lorry (which was their basis) could move. In the same way barges for use along the waterways of the various theatres of war were developed. As an example, it may be mentioned that the ordinary barge of Northern France would deal with—and deliver—5000 gallons of pure, sterile, and tasteless water per hour; any suggestion of flavour of chlorine was removed by a "dechlorinating" process with sulphur dioxide gas.

These new water units proved of immense value, and are effective against mineral poisons as well as against

bacterial or protozoal contamination. To meet the varying requirements of the different waters utilised in, e.g., France or Egypt or Murmansk, different amounts of "bleach" were needed. The estimation of the required quantity would have been a matter of some difficulty but for the provision of a special test in the form of the "Horrock's Test Case," the action of which is based on the known fact that, generally speaking, 1 part per million of free chlorine suffices to ensure bacterial sterilisation in water, and that before this amount of free chlorine is available a certain varying amount will be used up indirectly in the oxidation of organic matter and the ordinary non-pathogenic or saprophytic organisms. Similarly, in view of the possibility of mineral poisons, medical officers were supplied with test cases to detect arsenic and the other commoner metallic poisons. Of the detail of the water organisation there is barely time to speak here. It is perhaps enough to say that, despite the variety of the theatres of war and the possible contaminations in these various areas, there was no outbreak of those water-borne diseases which have been so destructive to armies in the past. In this connection it may be of interest to add that the success of water chlorination in the field led to its adoption in certain major schemes at Boulogne and Rouen, where, for example, we were enabled to undertake chlorination of the municipal water-supplies, and so satisfactory was this that laboratory tests showed the tap-water of Boulogne, drawn at random some few weeks after the scheme was initiated, to be absolutely sterile. It is interesting to note that the American Forces adopted a similar scheme in a number of the larger towns in France occupied by their troops with equally good results. It is necessary to say how much of the excellence of the water arrangements was due to the high technical skill of the Royal Engineers in their very difficult task of providing the huge quantities required. In many cases this necessitated the actual boring of wells and the pumping forward to large "water-points," even in some cases to the trenches, by means of rapidly laid pipe-lines. During the offensive in the summer of 1918 the Third Army advanced through a waterless zone having a frontage of 12 miles and a depth of 20 miles; water was obtained by means of 6-in. bore-holes sunk by the Royal Engineers in the chalk, which yielded 9000 gallons per hour. Altogether, 500,000 gallons were obtained daily from the bore-holes and distributed to the troops by the Water-tank Companies. This method was continued until the enemy's water system was available.

I would now briefly touch on the question of *air and ventilation*. At an early date after the Crimea it was recognised that "spacing out" of men in barracks was essential, and the Army Regulations were framed to give every man a space of 600 cub. ft., or, assuming a 10 ft. high room, 60 sq. ft. of floor-space. This very excellent decision was in itself sufficient to reduce markedly the sick-rate and death-rate from tubercular and other respiratory diseases; and, in view of latter-day knowledge, was a remarkable piece of foresight. One need scarcely recall Pflüger's experiments on droplet infection, and how he showed the range of such infection from mouth to mouth to be somewhere within 1½ metres—in other words, that that range should represent the minimum proximity of men's heads in barracks or beds. The importance of that knowledge had not, perhaps, been fully realised, or, at any rate, had been submerged by reason of national necessity. Two instances have, however, recently shown that the principle involved—now known as "spacing out"—cannot be disregarded. These were (1) the cerebro-spinal meningitis outbreak, starting in

1915, and (2) the influenza outbreak of 1918. In both these instances a populace, largely non-immune, was unavoidably—by military and national necessities—concentrated, with a resultant reduction in the spacing-out, and an opportunity arose for "mouth-to-mouth" or "droplet" infection. It is scarcely necessary to say that the pressure of hygienic advice was sufficient to represent the needs of the problem in each case. In the cerebro-spinal meningitis outbreak immediate spacing-out of the affected troops produced a rapid fall in the case and "carrier" incidence; in the same way, strong representations as to the need for drastic reductions in the number of troops carried in confined areas, such as ships, or of the methods of slinging hammocks in respect of the head positions, were later effective in reducing the unfortunately high incidence of influenza on its last appearance as a pandemic.

It may be of interest to note that the experience of the war had led to a reconsideration, and still further enlargement, of the cubic space allowed the troops, particularly overseas; and also of the correlated questions of pharyngeal and pulmonary disinfection. The importance of the former point—pharyngeal disinfection—was early recognised, and all transports were provided with means for dealing with the *personnel* aboard in special inhalation chambers. It is intended that these shall be a permanent feature of transports in the future, and it is of interest in this connection to note the recent encouraging reports from industrial works of the value of certain gases, inhaled in insensible but definite amounts, in inhibiting the incidence of influenza and allied respiratory disorders.

So much, then, for questions affecting all the troops. Now we come to the more special problems affecting particular groups of soldiery, and perhaps the most important is the *control of outbreaks of infectious disease*.

Epidemic disease, with the exception of the influenza pandemic, was noticeably absent, and the care taken to filter off "unfits" on the lines of communication went far to explain the remarkable freedom from disease of the men in the line. In respect of the excremental diseases, with their evil record of morbidity in past wars, and particularly of Enterica, the problem was approached in two ways: First, by the general inoculation of the troops so as to provide a relatively high immunity, and, secondly, by the careful disposal of all infected matter—in other words, by good conservancy methods. Inoculation during the early part of the war was carried out with typhoid vaccine, and a very large proportion of the troops was protected in this way. Later, in 1915, a triple vaccine was used—"T.A.B."—while troops proceeding East were provided also with cholera vaccine.

The sanitary sections were chiefly responsible for the constructional, advisory, and inspectorial duties involved in providing fly-proof field latrines of the deep-pit type, food larders, and safes for units otherwise unprovided, for the continued and varying problems connected with the reduction of the fly population, and for the supervision of large water schemes. The fly question, especially in Eastern theatres, is a vast and difficult one in view of the quantity of horse-litter inevitably associated with the Army, and frequently of the tactical or climatic impossibility of burning such fertile breeding matter. The Army was fortunate in being able to utilise expert advice on the problems raised from prominent entomologists, and in having officers and men who set themselves enthusiastically to carry out the methods adopted or tested.

But while the more serious diseases were largely defeated, it was found that there was a very con-

siderable wastage in all theatres of war from insect-borne diseases of different types. In France a very great deal of the minor sickness of the troops was traceable to louse infestation, either as the cause of various septic skin conditions or from trench fever, which was early recognised as a new clinical entity, and has now been clearly proved to be a louse-borne disease. This question of the infestation of troops with lice is one of the most difficult problems of the sanitary officer, particularly in the case of troops crowded together or living under unnatural trench conditions. To this question the energies of a very considerable *personnel* were directed, and to it all the support of the military authorities was lent. The sufferings of our Allies the Serbs, and since then of a majority of the population of Eastern Europe, from another louse-borne infection, typhus fever, also emphasised the necessity for a vigorous campaign of disinfestation. The problem was met largely by the simultaneous provision of facilities for bathing at intervals not exceeding a week or ten days, and by the increase in facilities for disinfecting personal clothing and blankets at one and the same time.

At this point it appears suitable to mention the development in methods of disinfection by steam. In the early days the troops in the field were dependent on the few box-disinfectors available, while the rearward units were supplied with Thresh disinfectors. With the provision of divisional sanitary sections, portable Thresh machines were also supplied to each division. It was soon apparent, however, that for the regular treatment of clothing required by the anti-louse campaign this was not sufficient. The ultimate development which resulted was the Foden-Thresh apparatus, comprising two large Thresh disinfecting chambers mounted on, and operated under slight pressure by, a Foden steam lorry. In this way the apparatus could be rapidly moved to any area in which it was required, at once commence operations by turning the steam into the chambers, and then be driven to a fresh centre for operations.

The disinfestation centres were of immense value, but were often inadequate to eradicate the louse plague entirely owing to the escape of certain individuals or articles. To meet the needs of men in such circumstances, general issues were made of certain repellent substances of proved value, but more reliance was placed on the regular treatment of clothing and blankets; and the experience gained in this connection will be of lasting value, for there has developed, as one profoundly valuable result, the use of hot air as a practical method of disinfestation—a method even simpler, cheaper, and more rapid than steam, and one destined, it is hoped and anticipated, to hold a permanent place in the larger schemes of control of insect infections of the future. It is of interest to note that flour-millers in Canada are now utilising this method for the destruction of moths in preference to the older and more dangerous "H.C.N." method. The latest "Orr hot-air huts" are models of efficient disinfectors. The subject, however, remains one for further study and co-operative methods of control. The problem to be met during the demobilisation of 20,000 men daily from France (and of smaller numbers from elsewhere), was no easy one, but of the utmost importance in order to avoid the dissemination of infective disease among the civil community. Careful personal inspection was, of course, required in every case, combined with bathing, disinfestation, and the issue of fresh clothing, and this colossal undertaking was carried out to complete satisfaction at a series of stations—at base ports in France each capable of dealing with no fewer than

3000 men per day prior to their embarkation. The absence in the community at home of any noticeable incidence of trench, relapsing, or typhus fevers goes to show the justification of the claim to success of the sanitary officers and *personnel* concerned in these works.

There were other insect-borne infections to be guarded against in different parts of the world where the military situation required our troops to serve. In some of these cases hygienic control was necessarily subservient to military urgency, and outbreaks of sickness occurred, the more readily so, perhaps, in the light of the unprepared soil which our young troops offered on first entry into tropical and sub-tropical zones. There is not time to detail the various minor hygienic campaigns, but the vast amount of anti-malaria work carried on in the various overseas war zones justifies notice. Being carried out, often with most complete success, from the point of view of mosquito elimination, there were at the same time areas where enemy action almost entirely forbade active measures of drainage, canalisation, or oiling. Even in these circumstances, however, it was not uncommon for certain of our officers, accompanied by a guard of two or three men, to push out into No Man's Land to oil certain stagnant waters known to be mosquito-breeding places. As to the extent of work carried out in draining, ditching, filling-in, etc., exact figures are scarcely procurable, but in the aggregate the efforts made must rank among the major schemes of the world, and be of incalculable value both by the improvement made and as an example to the inhabitants of the various areas concerned—Egypt and Palestine, Macedonia, Lower Mesopotamia, etc. In addition, however, to these offensive measures, defensive action against malaria was generally and thoroughly carried out by means of the provision of quinine, of netting of different forms, of special clothing, gloves, head-nets, etc., and of repellent substances, as also by the treatment of infected natives and various schemes for the isolation and removal of infected men who would otherwise act as foci for fresh cases.

From another aspect altogether the sanitary sections rendered valuable service; I refer to the economies effected. These economies were both direct and indirect. In the latter category may be placed the saving effected by the adoption of destruction of excremental matter by unit incineration which otherwise had to be disposed of with considerable expense by contract removal. Even of greater interest, however, was the direct saving resulting from the adoption of improved sanitary technique. In this category may be mentioned, first of all, the saving of fat. One of the most difficult waste-matters to get rid of in a cleanly way is greasy water—wash-up water, kitchen swill, etc. In seeking for better methods of disposal of this sullage the special cold-water grease-trap was devised, and soon pointed the way to an obvious economy. By the careful collection of all such wash-up fat, and of the scrap-fat and bone-fat rendered in cookhouses, a bulk of crude fat was obtainable which proved of immense use in aiding the national resources. A campaign of fat-saving was first initiated by the sanitary sections, and later developed and organised by the Quartermaster-General's Department. It was so successful that many of the war zones were able to make all their own soap locally, and, furthermore, to send home many tons of fat for making glycerine, then so necessary for the manufacture of munitions. As an instance, the saving of an average battalion was some 60 lb. of fat per day at a time when fat fetched at least 40s. per ton.

Another very useful economy was the collection of the solder from the sealing of the myriad tins used as food-containers. Nothing could be more striking than the picture presented by an up-to-date unit destructor consuming in cleanly fashion all the waste matter from a large camp, and at the same time melting out from improvised receptacles streams of solder, which dripped into cold-water receivers, while the heat of the furnace was utilised to heat large tanks of water, of value both for ablution and for the various washing-up processes so constantly required.

During the war many scientific investigations were carried out, both at home and in the actual theatres of war, for the elucidation of disease and the determining of the best modes of prevention. In some cases this necessitated the investigation of certain diseases which were either unknown in former campaigns or had been little studied in the past. Very valuable aid was given by the labours of the Trench-fever Committees at home and in France, and also by the War Nephritis Committee and Medical Research Committee in France. It having been clearly established that trench fever is conveyed by the louse, and diagnosis having been made possible, a great impetus was given to general measures of personal hygiene in the field, and also to improvement in methods of bathing and disinfection. Trench fever was made notifiable in consequence, and a very great improvement resulted from the increased attention to precautionary measures. At the termination of the war the diseases had greatly declined, and no infection was conveyed to England on demobilisation.

By the labours, in short, of the united profession, all doing that work which was required of them and which local authority considered most immediately necessary, the troops were served as few armies have ever before been served.

In France, for instance, in 1918, out of a mean strength of 1,250,000 men of all races, the typhoid admission rate amounted to only 0.2 per thousand per annum, whereas in the case of the war in South Africa the admission rate reached the high figure of 130 per thousand.

In the case of dysentery the total number of deaths from this disease in France during the whole war was fewer than 200. These figures in themselves are a sufficient and lasting tribute to that branch of the Army to which so many of our profession have belonged, and from which we hope they have taken something in exchange for the much they brought to it.

An inevitable result of the war has been the recognition by everyone engaged of the value of "preventive medicine." This has led, on one hand, to the definite recognition of the Sanitary Service in the Army as an organised department, and has aroused, on the other, an increased interest among thoughtful members of the civil community into their own state—an interest which provoked the demand for an organised national effort, and ultimately led to the formation of the Ministry of Health.

In summing up my views, I would say that, in my opinion, the future prosperity and success of our nation depend to an incalculable extent on the improvement of the physical and mental standard of all members of the community; it must not merely be—as I am afraid it has been to a considerable extent in the past—a case of the "survival of the fittest," but rather a perfection of every method by which mortality may be decreased, by which the production of "unfits" may be diminished, and by which the

standard of fitness as regards man, woman, and child may be raised.

To attain this result we must all work together. In the words of Pope:

By mutual confidence and mutual aid  
Great deeds are done and great discoveries made.

### University and Educational Intelligence.

**CAMBRIDGE.**—Dr. Adrian has been appointed University lecturer in physiology, and Mr. F. A. Potts, of Trinity Hall, has been appointed University lecturer in zoology.

The Harkness scholarship has been awarded to E. W. Ravenshear, of Clare, and the Frank Smart prizes in botany and zoology to R. E. Holthum, of St. John's, and G. T. Henderson, of Gonville and Caius, respectively.

A second *ad interim* grant of 30,000*l.* has been made by the Government to the University pending the result of the inquiries of the Royal Commission.

An important report has been made by the Local Examinations and Lectures Syndicate, urging an extension of the provision of both money and men for extra-mural teaching.

The Board of Agricultural Studies has received a donation of 1000*l.*, collected by Sir Arthur Shipley, for the provision of lectures on tropical agriculture for five years. Dr. C. A. Barber, of Christ's, late of the Imperial Department of Agriculture, West Indies, and of the Indian Agricultural Service, has been appointed lecturer in tropical agriculture for five years.

Miss B. A. Clough has been appointed principal of Newnham College in succession to Miss K. Stephen.

**EDINBURGH.**—The University Court has appointed Mr. E. P. Stebbing, lecturer in forestry, to the recently instituted chair of forestry. The Court has also appointed Mr. John Petrie Dunn, a former Bucher scholar of the University, who at the outbreak of the war was Vice-Principal of the Kiel Conservatoire, as a part-time lecturer in the department of music.

The late Dr. I. G. Bartholomew has bequeathed to the University the sum of 500*l.*, to be applied towards the foundation of a chair in geography.

**LEEDS.**—Dr. W. E. S. Turner has been appointed professor of glass technology, Mr. J. Husband professor of civil engineering, and Dr. Mellanby professor of pharmacology. Mr. R. E. Pleasance has been appointed demonstrator in pathology.

**LIVERPOOL.**—Dr. W. I. Dakin, professor of biology in the University of Western Australia, has been appointed to the Derby chair of zoology in succession to the late Prof. Leonard Doncaster. Dr. I. M. Heilbron, professor of organic chemistry at the Royal Technical College, Glasgow, has been appointed to the chair of organic chemistry.

**OXFORD.**—Dr. Benjamin Moore, of the Research Staff, Department of Applied Physiology, Medical Research Committee, has been appointed to the new chair of biochemistry. The Halley lecture is to be delivered by Prof. R. A. Sampson.

**PROF. J. STRONG**, of the University of Leeds, has been elected president of the Association of University Teachers for the ensuing year.

**DR. W. N. HAWORTH** has been appointed to the chair of organic chemistry at Armstrong College, Newcastle-upon-Tyne, in succession to Prof. S. Smiles.

**DR. V. J. HARDING**, associate-professor of biological and physiological chemistry at McGill University, has been appointed professor of pathological chemistry in the University of Toronto.

**MR. J. W. SCOTT**, lecturer in moral philosophy in the University of Glasgow, has been appointed professor of logic and philosophy in the University College of South Wales and Monmouthshire.

A SUMMER school of librarianship is to be held at Bristol from August 30 to September 11, under the auspices of the University of London School of Librarianship. Some twenty-five papers have been promised for delivery.

THE Report of the Librarian of Congress for the year ending June 30, 1919, shows that the work of the principal library in the United States was carried on with success during the war in spite of great difficulties. Members of the staff died in the war and others have not returned, or have resigned on finding more lucrative work elsewhere. The work has also been hindered by a general rise in prices. The number of printed books now in the library is about 2,700,000. The Library of Congress prints a card catalogue of its books, which is justly valued for its accuracy. By June 30, 1918, the number of different titles in this card-index was 789,000. The average stock of each card was 75 copies, making the total number of cards in stock 60,000,000. The number of subscribers to these cards is 2693, and the sale of cards for the year produced 73,000 dollars. A large number of Chinese books has recently been purchased. The Chinese section is a unique feature of the library, and now contains no fewer than 887 Chinese official geographical gazetteers. These gazetteers are of great value in the study of the industry, art, agriculture, and geography of China. The report invites executors or others who may possess manuscript papers relating to persons of national importance in politics, science, literature, or art to submit these papers for examination. The librarian undertakes to return papers of a strictly personal or family character, and to preserve any valuable material that might otherwise be lost or destroyed.

### Societies and Academies.

LONDON.

**Royal Society**, June 10.—Sir J. J. Thomson, president, in the chair.—A. V. Hill and W. Hartree: The thermo-elastic properties of muscle. The employment of a thermopile in a carefully closed-in chamber, immersed in well-stirred water inside a double-walled vacuum flask, together with photographic registering of the galvanometer response, has made it possible to record the thermal consequences of stretching a muscle (or a piece of indiarubber) or of releasing a muscle already stretched. When a muscle, alive or dead, is stretched, heat is liberated in relatively large amount at first, but at a rapidly diminishing rate. When a stretched muscle is released, there is at first a rapid absorption of heat, followed by a more prolonged evolution of heat. In a complete cycle of lengthening and shortening the net result is a production of heat, which is greater the longer the interval between the two processes. These thermo-elastic effects are large enough to afford a notable complication in the measurement of the heat-production of a live muscle excited to contract. Their explanation is as follows:—(a) The muscle, like a fiddle-string, shortens on being warmed; conversely, according to the second law, it will warm on being

stretched and cool on being released. This explains the initial effects. (b) The muscle, like other colloidal jellies, takes some time to reach an equilibrium length on being stressed; consequently, on stretching it more work is done, and on releasing it less work is obtained than is accounted for by the elastic potential energy existing in it when it has reached its full equilibrium length. The balance in either case appears as an irreversible production of heat. This accounts for the secondary effects. The phenomena appear to be of physical as well as of physiological interest.—Sir James Dobbie and J. J. Fox: The absorption of light by elements in the state of vapour: Selenium and tellurium. In a previous communication (Proc. A, 1919, vol. xcv., p. 484) it was shown that the absorption of light by sulphur vapour reaches a maximum at a temperature of about 650° C., and that at this temperature the vapour density corresponds with the average molecular weight  $S_2$ . Selenium and tellurium behave much in the same way as sulphur, the absorption increasing up to a certain temperature, above which it again diminishes. In the case of selenium the maximum absorption occurs between 650° C. and 700° C., and vapour-density determinations show that the average molecular weight at this point corresponds to  $Se_2$ . With tellurium the maximum absorption is found to occur about 1200° C. The vapour of this element consists of diatomic molecules at 1800° C., but nothing is known of its constitution at lower temperatures. Its general similarity, however, to sulphur and selenium as regards absorption of light renders it highly probable that at 1200° C., and below this temperature, the vapour is much more complex than at 1800° C. The absorption spectra of selenium and tellurium are marked by the presence of large numbers of sharp narrow bands, and that of tellurium shows a wide absorption band of which the centre is approximately at  $\lambda$  3800.—Sir James Dobbie and J. J. Fox: The absorption of light by elements in the state of vapour: Mercury, cadmium, zinc, phosphorus, arsenic, and antimony. These elements, unlike those of the sulphur group, do not show channelled absorption spectra when the Nernst filament is used as the source of light. Mercury, cadmium, and zinc, which are monatomic, transmit practically the whole of the light at all temperatures. Cadmium, however, shows a few narrow absorption bands, of which one at  $\lambda$  3261 is the most striking. In the cases of the tetratomic elements, phosphorus, arsenic, and antimony, general absorption occurs and increases regularly with rise of temperature up to 1400° C. There is no indication of a maximum followed by a diminution of absorption. The peculiar absorption phenomena of the elements of the sulphur group are in all probability due to the breaking-down of complex into simpler molecules, e.g.  $S_8$  into  $S_2$ , with the formation of molecules of intermediate complexity. With monatomic molecules no such dissociation can occur. With the tetratomic elements there is undoubted dissociation; but the changes are much less complicated than in the case of sulphur, the tetratomic molecules simply splitting up into diatomic molecules. It is, however, to be noted that the highest temperature at which silica tubes can be used is 1400° C. It is possible that at still higher temperatures further dissociation of the tetratomic elements would result, accompanied by absorption phenomena similar to those observed in the case of sulphur.—A. E. H. Tutton: Monoclinic double selenates of the copper group. This memoir deals with the four double selenates of the series  $R_2M(SeO_4)_2 \cdot 6H_2O$ , in which M is copper and R is potassium, rubidium, caesium, and ammonium. A complete crystallographic and physical investigation has been carried out, similar to the work previously published concerning the mag-

nesium, zinc, iron, nickel, and cobalt groups, and to that on the analogous double sulphates. The results confirm the conclusions derived from all the groups previously studied, and in a peculiarly valuable manner; for the copper-containing group affords crystals with morphological angles and elements and physical constants which differ appreciably in their absolute values from those afforded by the other groups, in this respect resembling the double sulphates containing copper. Yet the relationships between the values for the four salts are precisely the same, leading thus to exactly the same general conclusions as in the cases of those other groups. Every group exhibits its own idiosyncrasies, and the copper groups do so in a specially notable manner. Yet the same progression, according to the atomic weight and atomic number of the alkali metal present, is exhibited in the case of every property, whether morphological, such as the crystal angles and the topic axial ratios, or physical, such as the double refraction and the molecular refraction; also the ammonium salt proves to be practically isostructural with the rubidium salt. The most recent work on the structure of the atom and the further elaboration of Moseley's law connecting the atomic number with the atomic structure and complexity has only strengthened the conclusion that the author's results are a natural consequence of the operation of Moseley's law: the progression in the crystal properties following the progression in the complexity of the alkali-metallic atoms, which exert so dominating an influence in determining the structure and properties of these crystals.—H. G. Cannon: Production and transmission of an environmental effect in *Simocephalus vetulus*. The experiments were undertaken in order to repeat, if possible, Agar's work on the production and transmission of an abnormality in *Simocephalus vetulus*. The magnitude of the abnormality, which consisted in a change in the curvature of the valves of the carapace, could be measured by the length/width ratio L/W. The results indicate that the abnormality can be produced by feeding a culture containing practically no other protozoan than *Chlamydomonas*. The L/W ratio was found to be too variable to allow of its measurement with sufficient accuracy on which to base considerations as to the existence or non-existence of a "reaction" to the abnormality of such a magnitude as that indicated by Agar. The experiments showed that no antibody was produced to eliminate the cause of the abnormality.—E. C. Grey: The enzymes of *B. coli communis*, which are concerned in the decomposition of glucose and mannitol. Part iv.: The fermentation of glucose in the presence of formic acid. By carrying out the fermentation of glucose by bacteria in the presence of calcium formate the author has been able to unset the normal balance which exists between certain of the products, and thus to show that they are in reality formed by separate enzyme actions. Hitherto an approximately constant relationship has been found between the formic acid and carbon dioxide on one hand, and the alcohol and acetic acid on the other. This relationship is shown to be rather accidental than essential. It results probably from the fact that the hydrogen which arises from the decomposition of formic acid co-operates in the formation of alcohol, and thus the two reactions of alcohol formation and carbon dioxide formation tend to keep pace with one another. The addition of more formic acid at the outset of the fermentation tends, however, to prevent the production of formic acid from glucose, and to destroy the ratio which normally exists between this formic acid and the alcohol and acetic acid, thus proving that these products arise by at least two separate enzyme actions. Taken in conjunction with the author's previous finding, that lactic acid is formed

from glucose by *Bacterium coli* by a mechanism which is independent of that which gives rise to the other products, it is clear there that glucose may break down under the influence of these bacterial enzymes in three independent ways, giving rise to the following three groups of products:—(1) Formic acid, carbon dioxide, and hydrogen. (2) Alcohol, acetic acid, and succinic acid. (3) Lactic acid. These groups apparently represent three separate lines of cleavage of the glucose molecule under the influence of the enzymes of the bacterium in question. The author is of opinion that this manner of cleavage is fundamental. The experiments also show that alcohol is produced, in part at least, by reduction, and prove for the first time that such reduction does actually occur by the action of hydrogen liberated from the glucose, as well as that, in certain circumstances, the hydrogen derived from the added calcium formate exerts a reducing action and increases the yield of alcohol.—L. T. Hogben: Studies on synapsis. ii.: Parallel conjugation and the prophase complex in *Periplaneta*, with special reference to the premeiotic telophase. Synapsis in the Orthoptera has been the subject of considerable controversy. The earliest events of synapsis in the ovaries of the cockroach are traceable with much greater facility than in the testes. They involve in either case the parallel conjugation in pairs of the full diploid number of leptotene loops. Morse's account of the origin of the heterotype rings by separation of the diplotene threads along the line of cleavage is confirmed and amplified by a sequential analysis of the metaphase complex. It is seen that two chromosomes at this stage (*d* and *a'*) retain the looped condition of the post-synaptic bouquet until the others have divided—a fact which led earlier workers to interpret the genesis of the heterotype annular chromosomes according to the telosynaptic hypothesis. The accessories are not distinguishable in oogenesis from the autosomes. The vacuolation of the plasmosome during yolk-formation in the oocyte is described in detail, and a re-examination of material for a previous paper indicates that the so-called "chromatin" granules described by so many writers, as emitted during yolk-formation in the insect egg, are in reality products of the plasmosome. There is no evidence that in *Periplaneta* the plasmosome is related in any way to the chromatin organisation of the nucleus.

## PARIS.

Academy of Sciences, June 7. M. Georges Lemoine in the chair.—C. Moureu and G. Mignonaç: Acylketimines. Benzonitrile, magnesium, and an alkyl bromide give the product  $C_6H_5.CR:N.MgBr$ , and with an acid chloride acylketimines are obtained of the type  $C_6H_5.CR=N.CO.CH_3$ . Details of the general method of preparation and the melting points of six acylketimines are given.—G. Bonnier: The changes in plant forms obtained experimentally. Full descriptions of the changes brought about in seventeen species of plants by change of altitude. The plants were grown in similar soil in the plains and in the mountains, and the observations extended for a period of from six to thirty-four years.—A. Rateau: The theory of aerial and marine propulsive helices and of aeroplanes in rectilinear flight.—M. Kamerlingh Onnes was elected a correspondent for the section of physics in succession to the late Sir William Crookes.—G. Julia: Functions of two complex variables and limiting functions of analytical functions, uniform or multi-form, of one variable.—R. Thiry: The conformal representation of doubly connected with rectilinear contours.—H. Villat: The conformal representation of doubly connected areas.—B. Gambier: The surfaces of translation of Sophus Lie.—L. Dunoyer: Magnetic induction in the soft iron compass correctors under

the influence of the needles. Modifications of a formula given in an earlier communication required by the discovery of an error in sign.—L. Barbillion and M. Dugit: The rectilinear scale with equidistant divisions applied to the measurement and division of angles and measuring apparatus of constant sensibility.—Mlle. Paule Collet: The reproduction of speech by galena and sustained waves.—L. and E. Bloch: Production of the band spectra of nitrogen by electrons of low velocity. Earlier experiments of this nature have been made by the electrical method: the examination of the angular points in the curve of the current produced by the electrons. In the work here described a quartz prism spectrograph was employed and the nitrogen bands were directly observed. It was found to be possible to get the nitrogen radiation at a critical potential of about 10 volts. Hence band spectra, like line spectra, can be excited by electron shock with a voltage clearly lower than the ionisation potential (18 volts).—C. Benedicks: The electrothermic effect in a homogeneous conductor of constant section.—C. Raveau: Variance and the means of presuming the value of it without the aid of a formula.—P. Bary: The viscosity of colloidal solutions. A study of the swelling of colloids in suspension based on Einstein's formula for the viscosity of liquids holding solid matter in suspension.—M. Delépine and L. Ville: The chloride of bromine: its combination with ethylene. Forty years ago Maxwell, Simpson, and James showed that ethylene chlorobromide,  $C_2H_4.CH_2Br$ , was the product of the reaction of ethylene on "chloride of bromine" in a solution of hydrochloric acid. Recent physico-chemical work, on the other hand, goes to prove that chloride of bromine does not exist, and that the substance passing under that name is merely a mechanical mixture of bromine and chlorine. The authors have examined the action of ethylene on dry "chloride of bromine," and find that the compound  $C_2H_4ClBr$  is undoubtedly the main product. From this work the conclusion is drawn that, in some cases at least, physico-chemical data cannot be relied upon to prove the non-existence of a chemical compound.—H. Gault and R. Welck: A case of isomerism in the series of the aromatic  $\alpha$ -ketonic acids. The existence of two isomeric phenylpyruvic ethers is proved, and the conditions under which one can be converted into the other determined.—J. Bougault and J. Perrier: New researches relating to the action of hydrocyanic acid on glucose. The fact that in presence of an excess of potassium cyanide the glucoses form cyanohydrins quantitatively suggested that this reaction might be utilised for the exact estimation of glucose, and the conditions for accurate estimations are given. When the glucose is in excess the cyanide is rapidly converted into the non-poisonous cyanohydrin, and an experiment is cited in which 0.25 gram of potassium cyanide mixed with 6 grams of honey and 6 c.c. of water were given to a guinea-pig after the mixture had been allowed to stand fourteen hours to complete the reaction. The animal showed no signs of poisoning. The consequences of these results from a toxicological point of view are discussed.—G. Guilbert: The application of cirrus clouds to the prediction of the weather.—H. Ricome: The phenomenon of torsion comparable to the rolling-up of tendrils produced experimentally.—F. Moreau: The different aspects of lichen symbiosis in *Ricasolia herbacea* and *R. amphissima*.—J. Stoklasa: The action of hydrocyanic acid on the organism of plants. The spores of *B. subtilis* and *B. mesentericus vulgatus* resist the toxic action of air containing 3 per cent. of hydrocyanic acid by volume, but exposure of twenty-four hours to 2.5 per cent. by volume arrests further development. *Mucor mucedo*, *M. stolonifer*, and *Penicillium glaucum* behave similarly, and *Aspergillus*

*glaucus* requires a strength of 4 per cent. for destruction. Micro-organisms offer very great resistance to the action of hydrocyanic acid. The conditions under which seeds can be exposed to hydrocyanic acid vapour without damage have been worked out, and experiments cited showing how this method can be used for the practical disinfection of seeds affected with parasites.—A. **Krempf**: The blastodermic origin of the enteroids and of the enteroido-pharyngeal complex in the Anthozoa.—W. **Kopaczewski**, A. H. **Roffo**, and Mme. H. L. **Roffo**: Anaesthesia and anaphylaxia. The authors have found that anaesthetics and analgesics possess the well-marked property of diminishing the surface tension of serum. On the other hand, it has been proved that all the substances used for the prevention of anaphylactic phenomena, such as lecithin, the alkalis, and soaps, also have the property of lowering the surface tension. Experiments are given on the suppression of anaphylactic shock by anaesthetics. The results obtained confirm the view that it is not the nervous system which is mainly affected by the anaphylactic shock, but a reaction of colloidal flocculation leading to asphyxia from the obstruction of the capillary networks.—A. G. **Pellissier**: Modifications and lesions of the pulmonary epithelial cells due to suffocating gases.—G. **Marinescu**: The modifications of the oxydases during the evolution of the neurone.—R. **Cambier**: The purification of sewage effluents by activated sludge.—H. **Vallée** and L. **Bazy**: Bacteriotherapy by microbial extracts.—A. **Mayer**, H. **Magne**, and L. **Plantefol**: The mechanism of death in the case of acute pulmonary oedema caused by the inspiration of noxious vapours or gases.

### Books Received.

Forest Products. By Prof. N. C. Brown. Pp. xix+471. (New York: J. Wiley and Sons, Inc.; London: Chapman and Hall, Ltd.) 21s. net.

Practical Geometry, pp. xv+256; Theoretical Geometry, pp. xiv+104. By C. Godfrey and A. W. Siddons. (London: Cambridge University Press.) Complete, 7s. net.

A Primer of Trigonometry for Engineers. By W. G. Dunkley. Pp. viii+171 (with Answers). (London: Sir Isaac Pitman and Sons, Ltd.) 5s. net.

Pyrometry. By C. R. Darling. Second edition. Pp. xii+224. (London: E. and F. N. Spon, Ltd.) 10s. 6d. net.

The Chemist's Year Book, 1920. Edited by F. W. Atack, assisted by L. Whinnyates. 2 vols. Vol. i., pp. vi+422; vol. ii., pp. vii-viii+423-1136. (London and Manchester: Sherratt and Hughes.)

Phosphore, Arsenic, Antimoine. By Dr. A. Boutaric and A. Raynaud. Pp. iii+417. (Paris: O. Doin.) 9.50 francs.

Traité de la Lumière. By C. Huyghens. Pp. x+155. (Paris: Gauthier-Villars et Cie.) 3.60 francs.

Food Inspection and Analysis. By A. E. Leach. Fourth edition. Pp. xix+1090+xii plates. (New York: J. Wiley and Sons, Inc.; London: Chapman and Hall, Ltd.) 45s. net.

Vertebrate Zoology. By Prof. H. H. Newman. Pp. xiii+432. (New York: The Macmillan Co.; London: Macmillan and Co., Ltd.) 16s. net.

A Second Book of School Celebrations. By Dr. F. H. Hayward. Pp. 133. (London: P. S. King and Sons, Ltd.) 5s. net.

Stories for the Nature Hour. Compiled by A. M. Skinner and E. L. Skinner. Pp. 253. (London: G. G. Harrap and Co., Ltd.) 5s. net.

Surveying. By W. N. Thomas. Pp. viii+536 (with Answers). (London: E. Arnold.) 31s. 6d. net.

### Diary of Societies.

- THURSDAY, JUNE 24.**  
**ROYAL SOCIETY OF MEDICINE** (Laryngology Section), Annual Summer Congress, at 2.30.—Papers on Cancer of the Throat, with Discussion.  
**ROYAL SOCIETY**, at 4.30.—Sir Ray Lankester: Some Rostro-carinate Flint Implements and Allied Forms.—Lord Rayleigh: A Re-examination of the Light scattered by Gases in respect of Polarisation. I. Experiments on the Common Gases.—A. Mallock: Note on the Influence of Temperature on the Rigidity of Metals.—Mrs. E. F. Armstrong and T. P. Hilditch: A Study of Catalytic Actions at Solid Surfaces. V. The Rate of Change conditioned by a Nickel Catalyst and its Bearing on the Law of Mass Action.—Dr. H. Jeffreys: Tidal Friction in Shallow Seas.—Other Papers.  
**LINNEAN SOCIETY OF LONDON**, at 5.—Dr. C. J. F. Skottsberg: Recent Researches on the Antarctic Flora.—Dr. R. J. Tillyard: The Cawthorn Institute, New Zealand, and its Biological Function.  
**OIL AND COLOUR CHEMISTS' ASSOCIATION** (at Food Reform Club, 2, Furnival Street), at 7.30.—A. E. Bawtree: (1) A Hydrometer for Accurate Determinations of Pastes and Viscous Materials; (2) A Viscometer which Combines Increased Efficiency with the Power of Measuring "Stickiness" Independently of Viscosity.  
**SOCIETY OF ANTIQUARIES**, at 8.30.
- FRIDAY, JUNE 25.**  
**ROYAL SOCIETY OF MEDICINE** (Laryngology Section), Annual Summer Congress, at 10 a.m.—Papers on Cancer of the Throat, with Discussion.  
**PHYSICAL SOCIETY OF LONDON**, at 5.—Dr. J. H. Vincent: The Origin of the Elements.—W. H. Wilson and Miss T. D. Epps: The Construction of Thermo-couples by Electro-deposition.—J. Guild: The Use of Vacuum Arcs for Interferometry.—S. Butterworth: The Maintenance of a Vibrating System by Means of a Triode Valve.  
**WEST LONDON MEDICO-CHIRURGICAL SOCIETY** (at Kensington Town Hall), at 8.15.—Prof. C. S. Sherrington: Posture (Cavendish Lecture).
- TUESDAY, JUNE 29.**  
**ROYAL HORTICULTURAL SOCIETY**, at 3.—H. R. Darlington; Garden Roses.  
**ROYAL ANTHROPOLOGICAL INSTITUTE**, at 3.7.—Sir C. Hercules Read, T. Alloway, V. B. Crowther-Benyon, S. Fenton, G. W. Willis, and others: Exhibition of Bronze Age Implements.
- WEDNESDAY, JUNE 30.**  
**ROYAL SOCIETY OF ARTS**, at 4.—Annual General Meeting.  
**INSTITUTION OF ELECTRICAL ENGINEERS** (at Institution of Mechanical Engineers), at 6.—Sir Philip Dawson: Electric Railway Contact Systems.

### CONTENTS.

	PAGE
University and Higher Technical Education	509
Mathematics of Elasticity. By L. N. G. F.	511
Behaviourism. By Prof. H. Wildon Carr	512
The World's Supply of Animal Foodstuffs	513
Life and Lore of Birds	514
Our Bookshelf	515
Letters to the Editor:—	
The Separation of the Isotopes of Chlorine.—Prof. Frederick Soddy, F.R.S.	516
A Possible Cause for the Diamagnetism of Bohr's Paramagnetic Hydrogen Atom.—J. R. Ashworth	516
A Stalked Parapineal Vesicle in the Ostrich. ( <i>Illustrated</i> ).—Prof. J. E. Duerden	516
The Alligator Pear.—Dr. Michael Grabham	517
Eye-Colour in Bees.—Prof. T. D. A. Cockerell	518
British and Foreign Scientific Apparatus.—F. W. Watson Baker	518
Applied Science and Industrial Research.—J. W. Williamson	518
Wireless Telephony. ( <i>With Diagrams</i> ). By Prof. W. H. Eccles	519
The Meteorology of the Temperature Zone and the General Atmospheric Circulation. ( <i>Illustrated</i> ). By Prof. V. Bjerknes	522
The Cardiff Meeting of the British Association	524
Obituary:—	
Prof. J. R. Rydberg, For. Mem. R.S.	525
Notes	526
Our Astronomical Column:—	
Mercury an Evening Star	529
The Zeeman Effect in Furnace Spectra	529
The Lunar Parallax and Related Constants	529
The Centenary of Sir Joseph Banks, Bart.	530
South-Eastern Union of Scientific Societies	530
Genetic Segregation. By W. Bateson, F.R.S.	531
Colour Index of the British Isles	531
Army Hygiene and its Lessons. By Lt.-Gen. Sir Thomas Goodwin, K.C.B.	532
University and Educational Intelligence	537
Societies and Academies	537
Books Received	540
Diary of Societies	540



THURSDAY, JULY 1, 1920.

*Editorial and Publishing Offices:*MACMILLAN & CO., LTD.,  
ST. MARTIN'S STREET, LONDON, W.C.2.Advertisements and business letters should be  
addressed to the Publishers.

Editorial communications to the Editor.

Telegraphic Address: PHUSIS, LONDON.

Telephone Number: GERRARD 8830.

**Medical Research and the Practitioner.**

**I**N the interim report<sup>1</sup> issued recently by the Consultative Council on Medical and Allied Services, under the chairmanship of Lord Dawson of Penn, the proportion given to research is disappointingly small. Perhaps this was inevitable. The medical organisation suggested includes effective laboratory equipment at every stage from the domiciliary work of the practitioner to the conducting of prolonged researches by the Medical Research Council; but the portions dealing with research proper are very generalised. A document like this should be a new charter for medicine, and the scientific mind naturally expects to see the scientific groundwork fully developed. For increased and accelerated research is essential to the continued expansion of scientific medicine. In the report it is hoped

“that the scheme of services which we suggest would facilitate enquiry into the causes of disease and the possible remedies. The facts which indicated the need for such enquiry might, we think, often be brought together in the first instance by the medical practitioners in a given locality.”

It is difficult to justify the hesitating note of these sentences. Medical practice bristles with unsolved problems; but usually the practitioner is inadequately trained to discover them. Sir James Mackenzie shows what a general practitioner can do when he has the interest and the capacity to train himself. The war has unveiled many gaps in scientific medicine. Even the war reports of the Medical Research Council, not to refer to the many others, prove that the science of medicine will not advance merely by a re-shuffling of the medical army, but by greater intensity of research and discovery.

Medicine has to face the fact that, for practical

<sup>1</sup> Ministry of Health Consultative Council on Medical and Allied Services. Interim Report on the Future Provision of Medical and Allied Services. Pp. 28. (London: H.M. Stationery Office, 1920.) Cmd. 693. Price 1s. net.

purposes, it knows nothing about the cause of measles, scarlet fever, mumps, influenza, rheumatic fever, cancer, or other forms of malignancy; nor is the knowledge of the causes of dead and premature births more than elementary. These are only a few illustrations taken from the Medical Research Committee's fifth annual report. It is reasonable to expect that, in a scheme that brings the medical profession into a unity, the clogged masses of problems facing the general practitioner and scientific worker alike would be sketched with precision and force. The report does add that

“there are great and important opportunities for research in preventive medicine, which at present are scarcely dealt with by any organisation, and mostly are not attempted by individuals. Encouragement of research in the prevention of disease should, we think, be developed, for the materials are everywhere, and the results would undoubtedly be valuable.”

From this the lay public would not readily gather that the future value of the general practitioner to the State depends on the development of research in at least the following sciences: biology, physiology, bio-chemistry, pathology, and experimental therapeutics. To the raw materials of such researches the various classes of medical practitioners can contribute; but they have little stimulus to do so unless they keep more closely in the currents of the scientific work of the schools.

The report indicates that, for the purposes of research into fundamental problems, “the profession would no doubt look to the Universities and the Medical Research Council for guidance and assistance.” When we reflect that the medical profession has to deal with sanatoria for tuberculosis, recuperative centres, hospitals for curable or incurable mental disease, institutions for the feeble-minded, epileptic colonies, orthopaedic centres, hospitals for infectious diseases, not to mention general hospitals and the innumerable fresh points emerging in every man's practice, there is abundant occasion to look both for “guidance and assistance.”

What we miss here is a compact and well-loaded presentment of the case for research from the general practitioner's point of view. At present neither general practitioners nor consultants have an adequate conviction that more and more as time goes on the value of their work will depend on the capacity to understand and to prevent the beginnings of disease, and that, without effective training in research at some stage of their career, they can make little headway in pre-

ventive medicine as now understood. The general practitioner's part in "field" and "team" research might well form the subject of a special reference to the Consultative Council on Medical and Allied Services. If the world of general practice does not realise that research is of vital importance to every branch of medicine, such is certainly not the case with the world of science.

### Theory of Dioptric Instruments.

Ferraris' "*Dioptric Instruments*": Being an Elementary Exposition of Gauss' Theory and its Applications. Translated by Dr. Oscar Faber from Prof. F. Lippich's German translation of Prof. Galileo Ferraris' Italian work entitled "The Fundamental Properties of Dioptric Instruments." Pp. xxxi+214. (London: H.M.S.O., 1919.) Price 4s. net.

THE original of this translation was published by Prof. Galileo Ferraris, of Turin, in 1876. As a copy of this original could apparently not be procured, the English translation was made from a German one by Lippich, which appeared in 1879. At the time of its appearance the book unquestionably marked a great advance in the treatment of its subject, and well deserved the extremely favourable review with which Abbe honoured the German translation in the first volume of the *Zeitschrift für Instrumentenkunde*.

Abbe himself, however, has to be credited with far greater advances in the theory of image-formation by optical instruments with which the book before us deals, for his purely geometrical treatment of the problem leads to the same results without being limited to the infinitely constricted "threadlike space around the optical axis" which still plays so large a part in textbooks, although, with light of finite wave-length, nothing of any optical interest can possibly happen within it. On the other hand, Abbe was the first to deal systematically with the actual course of light through instruments in accordance with the limitations imposed by restricted apertures and by deliberately placed diaphragms, and inasmuch as the great majority of actual instruments are used only at fixed or nearly fixed conjugate distances, the actual course of the rays so determined is of far greater importance and value, both in the designing of instruments and in the discussion of the effects produced by them, than the rays referred to the Gaussian principle and focal planes and points which form a convenient *pons asinorum* in the general theory of lens systems.

Ferraris' treatment of the Gaussian theory is,

however, less open to the objections just alluded to than that adopted in most books, and in dealing with the Galilean telescope he comes remarkably close to the correct treatment of the problem of its field of view, which is so easily obtained now by Abbe's theory of the entrance- and exit-pupil of instruments. Beginners and users of optical instruments desiring to acquire a general knowledge of their elementary theory will also welcome the numerous and frequently elegant graphical solutions of the various problems which are given throughout as alternatives to numerical calculations by algebraical formulæ. The chief and decidedly regrettable omission is that the simple problem of achromatism is not dealt with at all. It is, of course, not a part of the Gaussian theory, and the omission is therefore justifiable; but it is so closely bound up with the proper explanation of the effects produced by compound object-glasses and eyepieces that the book would certainly have gained in value if the subject had been included.

The book is not so free from misprints as one would wish, and there is a really bad muddle on pp. 87-94, where the properties of thick lenses are discussed. This is not a case of a simple misprint or transposition of diagrams, but of actual errors by either the original author or one of the translators. Thus on p. 87 a thick biconvex lens is stated to be convergent if its thickness is less than one-third of the sum of the radii (both taken as positive, with  $\mu=1.5$ ). This should be three times instead of one-third. Then, on p. 93 a meniscus with the shorter radius on its concave face is stated to be always convergent; and on p. 94 the meniscus with the shallower curve on the concave face is credited with being divergent, telescopic, or convergent according to thickness. The actual facts are, of course, the other way about. Immediately after this the properties of a concentric lens are correctly stated.

On p. 144 the strange conclusion is reached that of two eyepieces of the same equivalent focal length that one is to be preferred which has the *closer* eye-point. This is directly contrary to the experience of every observer.

In the calculations of the properties of the human eye, or rather of its "simplified model," the author sets a very bad example by starting with data given with three significant figures and undoubtedly uncertain even then in the third figure, and calculating all the deduced figures with six, and even seven, significant figures (pp. 71-75). The idea of beginners that the percentage-accuracy of observed data can be indefinitely increased by putting them through the mathe-

matical mill with an imposing number of figures is sufficiently difficult to eradicate without such examples by teachers!

Apart from a few blemishes of the kind alluded to, the book may still, forty-four years after its first appearance, be recommended as worthy of careful study. A. E. C.

### The International Research Council.

*International Research Council: Constitutive Assembly held at Brussels, July 18 to July 28, 1919. Reports of Proceedings.* Edited by Sir Arthur Schuster. Pp. iii+286. (London: Harrison and Sons, 1920.) Price 10s. 6d.

THE Constitutive Assembly of the International Research Council, which met at Brussels on July 18, 1919, established for certain subjects new international organisations to replace those existing before the war, and in this volume we have the official text of the statutes there adopted or proposed, as well as the *procès-verbaux* of the different meetings which were held.

It will be remembered that in October, 1918, a conference of the scientific academies of the Allied nations was held in London at the invitation of the Royal Society to consider the action which should be taken in regard to international associations; for some had lapsed during the war, and others were unlikely to meet in their old form for some years to come. The resolutions then agreed to were carried further at a second conference which was held at Paris in November of the same year, when the International Research Council was formed, and an executive committee appointed to prepare proposals to be submitted to the Constitutive Assembly at Brussels. The meeting at Brussels formed the third stage in the formation of the new international organisation which had been decided upon in London, and at it the statutes of the International Research Council and of the Unions for Astronomy, for Geodesy and Geophysics, and for Pure and Applied Chemistry were approved.

The legal domicile of the International Research Council is at Brussels, where the general assembly will meet from time to time; but this in no way restricts the Unions, the members of which determine the places of their bureaux and of their periodical meetings as they please. The countries participating in the foundation of the International Research Council are Belgium, Brazil, the United States, France, the United Kingdom, Australia, Canada, New Zealand, South Africa, Greece, Italy, Japan, Poland, Portugal, Rumania, and Serbia, in addition to which the following neutral countries were invited to join the Council: China,

Siam, the Argentine Republic, Chile, Denmark, Spain, Mexico, the Principality of Monaco, Norway, Holland, Sweden, Switzerland, and also Czecho-Slovakia.

Besides the three Unions which were definitely established at the Brussels meeting, proposals were made that several others—mathematics, physics, radiotelegraphy, geology, biology, geography, and bibliography—should be formed, and draft statutes for these were presented in order that the executive committee might communicate them to the National Research Councils of the different countries for the desirability of forming such international unions to be considered. The machinery therefore exists for constituting an international organisation in any branch of science where it will be of service. Several countries have already formally signified their adherence to the International Research Council, and some also to the Unions which have already been formed.

It has been proposed that the draft statutes of the Mathematical Union should be discussed at an international meeting at Strasbourg this autumn, and doubtless representatives of other branches of science will hold similar meetings in due course to consider the desirability of forming unions of their own.

For all such meetings this volume of the proceedings and reports of the Brussels meeting will be of great value, for the general organisation differs from that of earlier associations, and may at first sight seem to be somewhat cumbrous; but a perusal of the documents now published will show that each union can provide itself with the constitution best suited to its own requirements, while conforming at the same time to the essential features of the International Research Council.

### Problems of Population.

- (1) *Problems of Population and Parenthood.* (Being the Second Report of, and the Chief Evidence taken by, the National Birth-rate Commission, 1918-20.) Pp. clxvi+423. (London: Chapman and Hall, Ltd., 1920.) Price 25s. net.
- (2) *The Social Diseases: Tuberculosis, Syphilis, Alcoholism, Sterility.* By Dr. J. Héricourt. Translated, and with a final chapter, by Bernard Miall. Pp. x+246. (London: George Routledge and Sons, Ltd.; New York: E. P. Dutton and Co., 1920.) Price 7s. 6d. net.
- (3) *The Venereal Problem.* By E. T. Burke. Pp. 208. (London: Henry Kimpton, 1919.) Price 7s. 6d. net.

(1) M<sup>R</sup>. JOSEPH CHAMBERLAIN set a precedent when he gave the name of "Tariff Commission" to a body created by him-

self alone. Previously the word "Commission" had been generally applied only to bodies created by Royal or Parliamentary authority, and having power to call witnesses before them, to whom each member of the Commission could put questions. Where bodies had been created for the purpose of hearing evidence tendered by voluntary witnesses, as had been done with advantage by the Charity Organisation Society, they were usually called "special committees." They are now often called "Commissions" in imitation of Mr. Chamberlain's action, and if it is clearly understood that they have no compulsory powers, there seems no harm in applying that term to them as denoting their method of action rather than the authority under which they act. In one respect they are not unlike many Royal Commissions. They consist largely of people who are known to have formed strong opinions on one side or the other, and accordingly their conclusions, if any sort of unanimity can be arrived at, are often in the nature of a feeble compromise, or, on the other hand, if both parties stand to their guns, are split into majority and minority reports. Even so, such reports may be useful as collections of facts and as presenting to the public materials for forming its own judgment.

The test, therefore, is: Are the results obtained of value? We think the report of the "National Birth-rate Commission," which has been published under the title of "Problems of Population and Parenthood," very fairly answers this test. It shows a continuous reduction in the birth-rate in England and Wales from 24 per thousand of the population in 1913 to 18 per thousand in 1918. For the further elucidation of the problems arising out of this fact, the Commission unanimously passed resolutions in favour of the establishment of a permanent Anthropometric Department under the Ministry of Health, and of a General Register. The practice of restricting the family has begun with educated and professional persons, and is gradually spreading through the whole community. That it should be so seems to be regarded by the majority of the Commissioners as inevitable, but they acknowledge the value of the unrestricted family as a training in self-sacrifice, mutual help, and efficiency, conducing to a better prospect of happiness than the restricted family in general can afford. When the practice of restriction of families is adopted, the tendency is to limit the number to that which will not restore the deficit caused by the loss of the generation that is passing. We thus get a diminishing population, leading to what has been called "race-suicide."

The conditions in which an increase of

the population is not desirable do not exist in the British Empire. So far as they exist in Great Britain, emigration (as Sir Rider Haggard suggests) seems to be the right means of meeting them. The Commission reports that there is no moral issue raised in respect of the limitation of the family when there are good reasons for such a course, but that the moral difficulty arises as to the means which may be used for that purpose. Ecclesiastical authorities allow of a limitation of intercourse, which does not afford a complete security, but not of any other method. If, however, the rightfulness of the limitation be admitted, the method by which it is to be effected would seem to be a question of physiology and perhaps of æsthetics rather than one of ethics. Some of the methods suggested are repulsive, and it is to be hoped none of them will become popular.

(2) Dr. Héricourt approaches the subject from a different point of view in dealing with sterility as one of the social diseases of France, where the birth-rate has been steadily falling and depopulation in progress for many years. He attributes this to voluntary restriction, and shows that the richer inhabitants are the less fruitful, and the poorer the more fruitful. He proposes a variety of remedies, ranging from the moral encouragement of large families to the taxation of celibates and of small families. He rejects the expedient of a direct bounty from the State to the parent. He would use all legal means to suppress publications in which the limitation of families is recommended, and to prevent the sale of articles designed to effect that object.

(3) The venereal problem is a subject common to all the three volumes under review, and it is curious to note that it is only recently that it has been possible to discuss it with the freedom that all alike use. This is in some degree due to the war. Since the days when Alva brigaded his "quatre cents courtisanes à cheval, belles et braves comme princesses, et huit cents à pied, bien à point aussi," and long before, indiscriminate sexual indulgence has been one of the incidents of a time of warfare. The risk attaching to it may be mitigated by suitable measures of military discipline, but the effectual application of similar measures to the civil population would be difficult, if possible. The urgency of the problem lies in the possibility of communicating the infection to innocent persons and to unborn children, and in the loss to the community arising from the destruction of life and efficiency caused by the disease. In the face of these evils it is not necessary to discuss the old view that syphilis was a disease the risk of which was voluntarily incurred in the

performance of an immoral act. If prostitution could be abolished, venereal disease would probably in time become extinct, but no means have yet been discovered by which, mankind being what it is, prostitution can be abolished.

All the authors alike urge propaganda. The National Birth-rate Commission thinks that the Ministry of Health should direct the attention of the public to the urgent duties of citizens in the matter. Dr. Héricourt says that we must act upon the will of the individual by persuasion through fear and through interest, and mentions a work by Prof. Fournier that has been circulated by the French Society for Sanitary and Moral Prophylaxis as well calculated to effect the desired persuasion. Mr. Miall, who adds a chapter of his own to his translation of Dr. Héricourt's work, urges that proper instruction should be given in the dangers of venereal disease. Mr. Burke, who has been an acting lieutenant-colonel in the Royal Army Medical Corps, argues forcibly that the public must be made more acquainted with sexual matters, increase its knowledge of the prevalence and dangers of venereal disease, and be induced to appreciate and to assist actively in the means to be provided for treating and finally stamping out of existence those disorders. The education, he says, must begin with the child. The adult must be impressed with the importance, the reality, and the dangers of venereal disease. The medical profession must set its teeth with determination to fight the menace out of existence. Mr. Burke's treatise, which is illustrated by six diagrams, is likely to be of value in effecting the common purpose of enlightening the public on these important matters. E. B.

### The Elements of Hardy Fruit Culture.

*Practical Hardy Fruit Culture.* By Richard Staward. Pp. 216. (London: The Swarthmore Press, Ltd., 1920.) Price 6s. net.

ALTHOUGH in many respects this small treatise on hardy fruit culture may be commended to beginners as a clear, concise, and elementary guide on the subject as applied to garden conditions, describing methods followed with success by the author at Panshanger Gardens, Hertford, it cannot be considered as having achieved the main purpose for which it was written. The author has set himself to provide a useful book for those, forming a numerous class at the present time, who are adopting hardy fruit culture as a business and know little or nothing of such work. The methods recom-

mended, however, are essentially those for the private gardener, as distinct from the commercial fruit-grower. Taking the case of distances for planting trees as an example, it is advised that bush or pyramid apples on free stocks should be planted 12 ft. apart, and those on the Paradise stock from 6 ft. to 9 ft. apart. For standard apple-trees 12 ft. is mentioned as the distance, if space is limited. For commercial work these distances should be at least doubled for varieties of vigorous growth, where the trees are to be treated as permanent and not as fillers. A general criticism may also be made of the lists of varieties recommended, which are almost invariably too long, and contain sorts which are of at least doubtful commercial value.

The sections devoted to the diseases and pests of the respective fruits make mention for the most part of the more serious troubles, and of some which are relatively trivial; but there are important omissions, such as silver-leaf of plums, bitter-pit of apples, and reversion of black-currants. The remedies proposed are typical garden methods and are often inappropriate for commercial plantation use. In some cases they would appear to miss the mark entirely, as when, for instance, the spraying of black-currants with lime-sulphur, or, as the author describes it, "bisulphide of calcium," against big-bud-mite attack is advised after the fruit has been gathered. By that time the mites are safely within the cover of the newly formed buds. It may also be questioned whether the author has made the best use of the space at his disposal by dealing with such fruits as outdoor grapes, mulberries, medlars, and apricots, by description of methods of propagation which are not adopted in general practice, and by detailed accounts of the training of special forms of trees which are never considered except for particular purposes in private gardens.

The illustrations are original, and some are of interest.

### Our Bookshelf.

*Experiments in the Breeding of Cerions.* By Paul Bartsch. (Department of Marine Biology of the Carnegie Institution of Washington. Vol. xiv.) (Publication No. 282.) Pp. 55 + 59 plates. (Washington: The Carnegie Institution of Washington, 1920.) Price 3 dollars.

CERIONS are land snails, well represented in the Bahamas by five species. They occur on the ground, under the edges of stones, among dead leaves, on grass, and on bushes. On an exposed place they attach themselves to the support by a thin epiphragm which also serves to prevent

desiccation. They can aestivate for a considerable time. In habit they are largely nocturnal, and are most active on misty nights. They feed mainly on fungi. They mate on the ground, and, though hermaphrodite, one functions as a male and the other as a female. The eggs are laid singly at the base of tufts of grass and beneath the surface. It takes between two and three years for an individual to reach full maturity.

For experimental purposes a number of Bahama forms were introduced into the Florida Keys, which present a considerable range in climatic factors and vegetation. There is on many of the Keys an indigenous species of Cerion, *C. incanum*, Binney, but it is not nearly related to any of the forms introduced; and one of the interesting results obtained by Dr. Bartsch was that the cross-breeding of the native species with the introduced *C. viaregis* brought about a state of flux. Had the resulted colony been discovered by one who did not know the history, a description would have been given of a very variable species. The inference is that similar complexes of unknown origin are likewise the product of cross-breeding. The case is peculiarly interesting because *C. incanum* and *C. viaregis* are very remotely related. "The fact is, that it is very surprising that organisms presenting such great differences in organisation should be able to cross at all, and it is still more remarkable that they should have produced fertile crosses." The author is inclined to believe that the crossing has an "energising effect" on the new product, but recent work on "hybrid vigour" leads one to think rather that what occurs is a happy pooling of hereditary items which corroborate one another. The general picture the author's results leave in the mind is that species separated for ages might be brought together by changes of level, so that crossing resulted. There followed an efflorescence of new forms which were later subjected to isolation on islands and promontories where inbreeding gradually eliminated diverse characters, eventually resulting in the more or less homogeneous expression which now marks in the Bahamas a multitude of insulated colonies.

*Space and Time in Contemporary Physics: An Introduction to the Theory of Relativity and Gravitation.* By Prof. Moritz Schlick. Rendered into English by Henry L. Brose. With an introduction by Prof. F. A. Lindemann. Pp. xi+89. (Oxford: At the Clarendon Press, 1920.) Price 6s. 6d. net.

HERE is a readable book, excellently translated, for which we have again to thank Mr. H. L. Brose. Though it is called an introduction to the theory of relativity and gravitation, it is more strictly an essay on "The Inseparability of Geometry and Physics in Experience," to quote the title of its fifth chapter. The main problem in presenting the work of Einstein to the physicist is to enable him to see how obstinately metaphysical he is.

"Time and space can be dissociated from

physical things, and events only in abstraction. The combination or oneness of space, time, and things is alone reality; each by itself is an abstraction." Many will say such statements are metaphysical in nature. In a sense, indeed, any statement is metaphysical which is concerned with logic. The real merit of Einstein's theory is that it does not trouble to ask what space and time are, or how far they may be logically separated from things. It does not attempt the separation. It goes straight ahead, keeping them all together until a result is arrived at which may be tested without any doubt or dispute as to its logical meaning, by the only method of exact observation, the perception of complete coincidence. It renders Newton's highly metaphysical definitions of space and time unnecessary; but while philosophers pause to see how they have to re-model their definitions, the physicist may congratulate himself that history has again proved that the real advances are made by those who, with open mind, continue in their endeavour to order the direct facts of experience in the most comprehensive manner.

*History of the Great War, based on Official Documents.* By Direction of the Historical Section of the Committee of Imperial Defence: *Naval Operations.* Vol. i. By Sir J. S. Corbett. Pp. xiv+470+case of 18 maps. (London: Longmans, Green, and Co., 1920.) Price 17s. 6d. net.

THIS important volume, the first of a series which is expected to run to four or five volumes, is described on its cover as the "official history of the war." This description is modified within by the explanation that, though it is based on official documents inaccessible to the general public, its views and opinions are those of its author alone, for which the Admiralty accepts no responsibility. This explanation unquestionably diminishes the official nature of the publication; but, on the other hand, it immensely increases its historic interest and its scientific value. For Sir Julian Corbett is a master of naval lore; he is deeply versed in the strategy and the tactics of the great captains of the old days. Consequently he has come to the study and interpretation of the masses of information concerning the late war laid before him by the Government with a splendid reserve of knowledge and with a perfected apparatus of criticism, and it is eminently satisfactory to be assured that he has had a perfectly free hand in dealing with his material and in drawing his conclusions.

The volume deals in a most illuminating manner and with a wealth of new information with the situation at the outbreak of the war, with the problems which the Navy had to face and solve during the critical months of 1914, and finally with the thrilling battle of the Falkland Islands. We await with eager anticipation the remaining volumes of the series. The maps, it may be added, are of the highest value and importance.

## Letters to the Editor.

*[The Editor does not hold himself responsible for opinions expressed by his correspondents. Neither can he undertake to return, or to correspond with the writers of, rejected manuscripts intended for this or any other part of NATURE. No notice is taken of anonymous communications.]*

### The Constitution of the Elements.

IN continuation of my letter in NATURE of March 4, further experiments on mass-spectra have been made, the results of which may be briefly announced as follows:

Boron (atomic weight 10.9) is a complex element. Its isotopes are 10 and 11, satisfactorily confirmed by second-order lines at 5 and 5.5. Fluorine (atomic weight 19.00) is apparently simple, as its chemical atomic weight would lead one to expect.

The results obtained with silicon (atomic weight 28.3) are somewhat difficult to interpret, and lead to the conclusion that this element has isotopes 28 and 29, with possibly another 30.

Bromine (atomic weight 79.92) is particularly interesting, for, although its chemical atomic weight is so nearly 80, it is actually composed of approximately equal parts of isotopes 79 and 81.

Sulphur (atomic weight 32.06) has a predominant constituent 32. Owing to possible hydrogen compounds the data are as yet insufficient to give a decision as to the presence of small quantities of isotopes of higher mass suggested by the atomic weight.

Phosphorus (atomic weight 31.04) and arsenic (atomic weight 74.96) are also apparently simple elements of masses 31 and 75 respectively.

No line given by the above elements shows any measurable divergence from the whole number rule.

F. W. ASTON.

Cavendish Laboratory, June 20.

### Applied Science and Industrial Research.

IN my reply to Mr. Williamson, published in NATURE of June 3, I stated that research workers and their assistants, aided by the Department of Scientific and Industrial Research, during the year 1918-19 received on the average 53s. weekly.

Sir Frank Heath has directed my attention to the unwarranted inference I have drawn. I assumed that the grants made were all annual grants, but I am informed by the Department that this is not the case; less than half the grants to research workers and students were grants for twelve calendar months' work; the sum of 14,170l. expended included nine grants for apparatus and grants for casual labour. Actually, eighty-five research workers and students received rather less than 13,000l. I am informed also that professors' recommendations are followed in making these grants, both with regard to recipients and to the amounts allotted.

Without expressing any further opinion as to the adequacy of grants to individuals, detailed information not having been supplied, I should be glad if you would afford me the opportunity of expressing my regret that in criticising the grants I unwittingly misconstrued the figures given on pp. 9 and 72 of the Report of the Committee of the Privy Council for Scientific and Industrial Research for the year 1918-19.

A. G. CHURCH.

National Union of Scientific Workers,  
10 Tothill Street, Westminster,  
London, S.W.1, June 21.

NO. 2644, VOL. 105]

### Science and Scholasticism.

DR. SINGER'S review of my book "Medieval Medicine" in NATURE of April 1 has only just come under my notice. The mails separate us from England more than before the war; may that be my excuse for a belated word? I have nothing to say for the book, it is thoroughly documented and must speak for itself; but may I say a word for poor Aristotle and Hugo da Lucca, whom I have brought under the reviewer's strictures?

Dr. Singer suggests that Aristotle has come into appreciation again because we have found that he made observations on animal life. Is not the reason rather that now that we ourselves have come to think through our observations to the principles beneath, we have found that Aristotle was usually before us? As Prof. Wundt said, after spending a lifetime at experimental psychology: "It is only the animism of Aristotle which, by joining psychology to biology, provides a plausible metaphysical explanation for the data furnished by experimental psychology." In nearly everything else where this generation has thought deeply enough they have found Aristotle before them whenever he had considered the subject. That is why we have come to appreciate better the medieval regard for him.

Hugo da Lucca must be allowed to rest on his own work just like Aristotle. Any man who operated on the skull, the thorax, and the abdomen seven hundred years ago, using a metal tube to secure the patulousness of the intestines while he was making an intestinal anastomosis, who got union by first intention and boasted of it, and whose cicatrices were "pretty and linear, so that they could scarcely be seen," may be trusted to posterity in our time. How he could have done such things without an anæsthetic is impossible to understand, so therefore the hints that we have of anæsthesia at that time must be taken as historic. We do not need to go to manuscripts for this; there are dozens of text-books of professors of surgery in the thirteenth century that were printed in the Renaissance time. The Renaissance printers had marvellously good judgment, and the authors they printed in their magnificent editions were worthy of the time and labour they devoted to them. We have no word from Hugo himself, but his son wrote a whole volume with regard to him which surely Dr. Singer must know, though it is very hard to understand the position that he takes if he does know of it.

It is always amusing to note how the saying of anything good about the Middle Ages arouses opposition. John Fiske's declaration, "there is a sense in which the most brilliant achievements of pagan antiquity are dwarfed in comparison with these (of the Middle Ages)," must wait for acceptance. When I ventured to say in a volume on "The Thirteenth the Greatest of Centuries," that they had fine technical schools and developed engineering, most people shied; and yet we have their stained glass, illuminated books, wonderful ironwork, carving, and all the rest that we are founding technical schools to secure, and the engineering of their bridges and cathedrals is a marvel.

The modern man of science balks at this. Here in the United States the authors of "A Short History of Science" (New York, 1918), professors at the Massachusetts Institute of Technology, treated the science of the Middle Ages in a couple of paragraphs, the most important part of which is: "In the thirteenth century it becomes plain that a new spirit is arising in Europe. . . . Thomas Aquinas writes his famous 'Imitatio Christi.'" JAS. J. WALSH.

110 West 74th Street, New York, May 26.

THE dialectical methods of the Middle Ages, admirably adapted to the sharpening of wits and the entertainment of audiences, have long been regarded by men of science as an inferior means of arriving at truth. I have no wish to enter into controversy with my friend Prof. Walsh as to the general merits of Aristotle. Yet I will venture to sum up in a sentence what I believe to be the conclusions of the overwhelming majority of modern Aristotelian scholars and of scientific men who have investigated the works of the master: *Aristotle's physical science is almost worthless from the modern point of view; it has scarcely any serious basis of observation and none of experiment; his biological works, on the other hand, show him to have been an admirable and careful observer of animal life.* He was thus an excellent naturalist but a very poor physicist. I will further endeavour to epitomise the verdict of most scientific students of the Middle Ages on his position in medieval science. *It was chiefly Aristotle's physical works that earned for him his scientific reputation in the Middle Ages; his biological works exerted little influence until the sixteenth century.* Those who assent to these propositions will not agree that "we have come to appreciate better medieval regard for him."

As regards Hugh of Lucca, I am aware of the existence of the "Chirurgia" of Theodoric, and that he was perhaps the son of Hugh, though, to my mind, Prof. Walsh has greatly exaggerated the scientific value of his work. But Theodoric's treatise, though certainly very interesting to us, was not greatly prized by the Middle Ages. Hence copies of it are very rare, and among the fifteen thousand or so medical MSS. that have survived in this country only one (Ashmole 1427, fourteenth century) contains it. A treatise possibly founded on it has survived in one English codex of somewhat later date (Magd. Coll. Cambridge, Peyps, 1661). Theodoric's treatise was not printed until 1498. I see nothing in it, or in what Prof. Walsh now says of it, to justify a modification of my criticism. The English reader who cares to learn more of Theodoric will find a sympathetic account of him in Sir Clifford Allbutt's "Historical Relations of Medicine and Surgery," and a very full analysis of his "Chirurgia" in E. Gurlt's "Geschichte der Chirurgie."

The judgment of the Renaissance printers in their selection of medical works is a matter of opinion. The sixteenth century had run a quarter of its course ere they made Hippocrates accessible (earliest Latin edition, Rome, 1525; earliest Greek edition, Venice, 1526). By that time the ponderous "Kanun" of Avicenna had already passed through at least twenty-two editions (Editio princeps, Strassburg, 1472). Those who rate Hippocrates higher than Avicenna—or than Theodoric—will rate the judgment of the Renaissance printers—and readers—accordingly.

Against Prof. Walsh's suggestion that I am opposed to any good being said of the Middle Ages I am sufficiently protected by my published works. However these be estimated, they will yet, I hope, guard me against the accusation of having neglected that period. Under such protection as they may afford I would add my regret to that of many of Prof. Walsh's other admirers that he does not use his great learning and literary gifts to portray medieval life as it was instead of as that of a *Civitas Dei*, which it was not. Whatever the scientific aspirations of the age, the scientific achievement was very small. The explanations of this failure are various, but in denying the fact Prof. Walsh belongs to an exceedingly small band of scholars whose conclusions seem also, to some of us, to be shaped by certain preconceived

ideas. But we shall not, on that account, value the less any contribution to knowledge that he may make. Oxford, June 12. CHARLES SINGER.

#### Commercial Parasitism in the Cotton Industry.

THE opinion of Sir George Watt in NATURE of February 23, that the report to the Board of Trade of the Empire Cotton Growing Committee is "ingeniously elaborated," but leaves a "confused impression," may justify a brief consideration of an allied phase of the subject. Why "the whole history of cotton improvement is most disheartening" may be explained if an essential feature has been omitted. The argument for research is ably presented in the pamphlet issued at Manchester by the Provisional Committee on Research and Education for the Cotton Industry, but with no reflection of the actual state of production.

Not only should planters have industrial information, as recognised in Sir George Watt's proposal of a central research institution at Manchester, but on the part of manufacturers, financiers, economists, and commercial leaders there is acute need of agricultural information. Industrial interest in cotton improvement must be made effective through the commercial channels that lead back to the farmer. Problems of agricultural application must be solved, in addition to developing superior varieties, devising better cultural methods, and controlling diseases or insect parasites. The elaboration of the cotton research programme may be entirely logical, but without an effective tie-back to the farmer there can be no prospect of a general application of the results of technical investigation, either industrial or biological, to purposes of production.

The central cotton institution at Manchester should be equipped for any elaboration of research that may be necessary to determine and demonstrate to manufacturers the relation of the system of buying to the improvement of production. The parasitic tendencies of the present commercial system are not limited to the speculative features that are being restricted by law or to the taking of undue profits, but lead to enormous agricultural and industrial waste through the production and manufacture of inferior fibre, passed on to the consumer in weaker and more perishable fabrics.

To expect manufacturers to be interested in the cotton plant or in the details of farm operations in the growing of cotton might be unreasonable, but at least the financial aspects of cotton production would receive attention if manufacturers knew how their interests are prejudiced by the present commercial system. Instead of serving as a conductor of interest in improved production from the spinner to the farmer, the commercial system has the manufacturers and the growers fenced apart and misinformed regarding the general needs of the industry.

Manufacturers are accustomed to pay more for good cotton, and naturally suppose that the farmers who raise better fibre receive higher prices for their crops, but investigation will show that most of the profit is absorbed by the buyers. The commercial idea of improving cotton is by "classing" the present miscellaneous crop into the so-called "even-running lots." Buyers like to get long-staple bales at short-staple prices, but do not forgo present profits in order to encourage the improvement of future crops that somebody else may buy. The commercial system provides no incentive for improved production.

The farmer is at liberty, of course, to raise better cotton if he chooses, but extra care and expense must be given, with no assurance of being able to sell at a higher price. Instead of gaining an advantage or of being encouraged to continue the planting of a better



variety, the progressive farmer at the end of the season may find himself making a forced contribution to an unjust system. Naturally, he loses interest in raising cotton of better quality, and goes back to ordinary "gin-run" seed or to the shortest and most inferior variety that promises a large yield.

There is no agricultural reason why any part of the American cotton belt should produce less than inch staple, nor is it an advantage to any interest that the production of inferior, short, and irregular staple should continue, but the inertia of the system must be overcome. If longer and more uniform staples are to be grown, they must sell at least as readily and as profitably as short staples. Since the farmer makes no use of cotton at home, but raises it only to sell, the quality of the fibre is of interest to him only as the price is affected. Better prices for better cotton are the only inducements that the farmer should be expected to consider. Preaching from any other text is sure to fall on deaf ears.

The present scarcity of superior fibre could be met most promptly and effectively by having more good cotton grown instead of wasting the resources of production by planting inferior cotton. The real obstacle is a defective commercial system, which undoubtedly could be changed without any great difficulty if the manufacturers had sufficient understanding of the conditions and needs. The problem, no doubt, is much the same in other countries as in the United States: to render production more efficient by improving the quality of the crop.

After two decades of investigation of cotton-breeding problems in the United States it is being recognised that the production of the best and most uniform fibre can be maintained only in communities that limit their production to a single variety of cotton, so that there shall be no mixing of different kinds of seed at the public gins or crossing of different kinds in the field. One-variety communities have been maintained for several years in the Salt River Valley of Arizona, where the practical advantages of the plan have been demonstrated and the commercial obstacles more clearly revealed.

Community production of better cotton in other regions might go forward rapidly if farmers were assured of better markets for good cotton than for short, mixed fibre. High prices may be expected to affect the quantity of cotton to be grown, but the quality will not be improved unless there is a distinct advantage in raising better cotton. So long as manufacturers are willing to take the present commercial system entirely for granted, and overlook its effect upon production, no prompt or general improvement is to be expected.

Lack of discrimination in buying from the growers is the weak point of the present system, not to be made good by paying all growers more for their cotton, but by paying more for good cotton and less for poor cotton. Discrimination in prices must be applied in the primary markets instead of the present careless and incompetent buying of "hog-round" lots at "flat" prices, which leads the farmer to produce the worst fibre instead of the best, because varieties with inferior lint often yield well or turn out high percentages of lint at the gin, and do not need such careful handling as the longer staples.

Not only the condition or "grade" of the cotton, but also the quality or "staple" need to be recognised while the cotton is still in the hands of the farmer. Outside of cotton markets it is seldom understood that the grades used in buying cotton from farmers have no relation to the essential textile qualities of length, strength, and uniformity of fibre, but only to incidental differences that result mostly from careless

picking or from exposure to the weather. The system buys grades from the farmer, but sells staples to the manufacturer, getting discounts from the farmer and premiums from the manufacturer.

Discrimination could be applied honestly and to the best advantage on the farm before the cotton is picked. Uniformity of the fibre, which is an essential factor of quality and value for textile purposes, can be determined much more readily and definitely while the cotton is still in the field than after it is brought to the gin or passed into the bale. Field inspection of the plants shows readily and easily whether the stock represents a select, uniform variety or is mixed with plants that yield only short, inferior fibre, as most of the "off" plants do when a good variety is allowed to deteriorate through admixture or neglect of selection.

If the cotton is mixed and irregular in the field there is no chance that the farmer will have high-quality fibre to sell, although the average buyer could not determine the admixture from the bale samples. The careless farmer usually sells his cotton at the same price as his more careful neighbours, to say nothing of the dishonest farmer who deliberately grows a mixed field with 20 per cent., or even 50 per cent., of short cotton, but gets the long-staple price for his crop.

The quality of the fibre is affected also by cultural conditions of soil, season, and methods of handling the crop. Even on the same farm or in the same field inequalities of soil or treatment may result in cotton of very different textile qualities, which would be marketed in separate bales if adequate discrimination in buying made such precautions worth while to the grower. The careful discrimination of quality that should be applied in the field can be made good only in part by the elaborate mill-tests by which the manufacturers try to protect themselves against too much waste and breakage in working the cotton. Such losses, as well as costs of cleaning and combing processes, undoubtedly could be reduced to a great extent through more careful buying and the more careful growing and handling of the crop which discriminating treatment of farming communities would secure.<sup>1</sup>

Field-inspection buying may be considered as a new application of botanical knowledge, but the underlying facts have been established, and there is no reason to doubt that the talent applied in commercial sampling from bales could be used more effectively for determination of the quality of fibre before the cotton is harvested. Such a reform would give the commercial system a positive, constructive relation to the industry instead of the present negative, parasitic relation. Farming communities would turn at once to the production of fibre of better quality, to the general advantage of the cotton industry and the consuming public. No doubt the relation of prices to production has been overlooked because it is so simple and obvious, but a new approach is open to manufacturers through the organisation of one-variety communities. A strong department of commercial relations in the new Cotton Research Institute at Manchester would be a practical recognition of the principle approved by Sir George Watt: "The cultivator's interests are paramount." O. F. Cook.

Bureau of Plant Industry, Washington,

May 24

<sup>1</sup> See United States Department of Agriculture Bulletins, "The Relation of Cotton Buying to Cotton Growing," "Cotton Improvement on a Community Basis," "Cotton Selection on the Farm by the Characters of the Stalks, Leaves, and Bolls," "Extension of Cotton Production in California," "Production of American Egyptian Cotton," and "Maintaining the Supply of Cotton."

## Fuel Research.

By PROF. JOHN W. COBB.

THE rising cost of coal will help to focus attention upon all such potential relief work as that of the Fuel Research Board, which has now issued its 1918-19 report over the signature of its director, Sir George Beilby. The report is of a comprehensive character, and gives evidence both of care in preparation and of a desire and competence to grapple in a scientific and effective manner with some of the more important problems with which the country is faced. The Board is not only undertaking experimental work at a station established for the purpose at East Greenwich, and conveniently placed near a works of the South Metropolitan Gas Co., but is also concerning itself with inquiries conducted elsewhere into the thermal efficiency of open fires and cooking ranges, the economic position of pulverised coal, the cutting, winning, and utilisation of peat, and the sources of raw material for the production of power alcohol. The report also includes a reasoned account of the proceedings of the Board in the matter of the new gas standards which had been wisely referred to it by the Board of Trade and on which it has made recommendations. A survey of the national coal resources from the physical and chemical points of view is promised, this work having been taken over from the Coal Conservation Committee, which recognised the importance of such a survey, but, being without a staff, did not feel able to carry it out.

The equipment and lay-out of the experimental station at East Greenwich are described at some length. Stress is laid upon measures taken to allow of striking a correct thermal balance for each piece of plant employed, although it is no doubt recognised that the smallness of each unit would have to be taken into account in translating results into terms of large-scale practice. It is interesting to note that the position of water-gas as a heating agent for such purposes as the firing of the gas-retort installations is now so far established that the Board has felt justified in making blue-water-gas its standard fuel. Recent experience has demonstrated that the traditional restriction in the use of water-gas to operations requiring intense local heat was unnecessary.

Apparently the first purpose to which the experimental plant is to be put is the complete investigation of low-temperature carbonisation, concerning which so many conflicting statements have been put forward. This is a very legitimate inquiry, and the report justifies it (if any justification is needed), by insisting upon the wisdom of probing all possible sources of supply for the fuel oil on which the Navy and mercantile marine are becoming increasingly dependent. It is plain that Sir George Beilby approaches this process with some predisposition in its favour. He has himself made preliminary experiments upon it, and in an appendix to the report there is reprinted a contribution which he made to the discussion of the subject at

the British Association meeting in 1913. The report displays a somewhat unfortunate tendency to rule out the carbonisation processes of the gas industry as being unlikely to produce larger quantities of fuel oil, because "present movement is all in the direction of obtaining the highest possible proportion of the total thermal units of the coal in the form of gas with a smaller consumption of coal per million thermal units distributed." Such ruling out is not justified, as a later qualifying clause admits. The further technical success of the gas industry would be expected to result in a large replacement of coal as a domestic and industrial fuel by gas, and although the thermal units carried by the gas from a ton of coal would increase, the margin for replacement is so considerable that the total amount of coal *gasified* would increase also. Moreover, it is unwise to assume that such developing processes as the distillation in vertical retorts of a descending stream of coal in an ascending stream of steam or other gas cannot be made a most effective and economical means of securing the maximum yield of volatile products, including tar oils if they are wanted. Most of the favourable "non-destructive" conditions claimed for low-temperature carbonisation may quite probably be secured in this way without the attendant disadvantages of that process as it has so far been described and worked. The whole matter is still *sub judice*.

The net commercial result of any carbonisation process is to a great extent dependent upon the relative market values of products, which change from time to time. From a thermal point of view, however, the movement towards obtaining a large proportion of the thermal units of the coal in gas is justified by the high thermal efficiency of gas in use, combined with the low thermal cost of production which can be made to attach to it. From the point of view of by-products, fuel oil has, no doubt, its importance, but it would be a mistake if sulphate of ammonia were to be deposited from its pride of place without due consideration, and it seems clearly to be established that low-temperature conditions are very unfavourable for the production of ammonia. It may be that national safety will be held to demand the working of a commercially unremunerative process, but, if so, the decision should be made with open eyes.

The results which Sir George Beilby, Prof. Thomas Gray (chief of the laboratories), and their staff are setting out to obtain in connection with the low-temperature carbonisation process will be of great interest to many who have been waiting for trustworthy data concerning it. The commercial success of low-temperature carbonisation on an extended scale is bound up with the creation of a demand for the soft coke or semi-coke which would be one of its main products. As compared with raw coal, this material, like any other coke,

would have the outstanding advantage of smokeless combustion, but its ash content would, of necessity, be higher. It would have the great disadvantage of crushing more easily than ordinary coke in all the processes of transference from the retort to the consumer, but would be correspondingly easier to ignite. Like both raw coal and ordinary coke, it would deliver potential heat units at a cheaper rate than they are supplied in gas. The question of efficiency in use remains, and the report deals benevolently with the efficiency obtainable from coal and coke in the most widely used domestic appliance—the open fire. It is set out that with an open fire, which has apparently a chance of regaining a lost reputation if it will only consent to provide a market for large quantities of soft coke, “probably 30 to 40 per cent. of the heat escapes completely, 60 to 70 per cent. being used in warming the room itself and the general fabric of the building.”

On this point careful statement is advisable. In view of the comparative unavailability of any heat from the coal fire which is not given up to the room, it would be quite wrong to take 60 to 70 per cent. as being the thermal efficiency of the open fire, just as it would be wrong in the other direction to take the radiant efficiency of such a fire (about 25 per cent.) as the total efficiency. Comparative tests are probably best made on radiant efficiency, and it is not surprising to find that the tests made by Dr. Fishenden and quoted in the report are made on this basis. Dr. Fishenden's tests on coal and coke fires have been carried out at Manchester by the method worked out at the University of Leeds for testing the radiant efficiency of gas fires, with such modifications as were found necessary. The work has undoubtedly been carried out with care and skill, but it should be borne in mind that, on account of the varying condition of a coal fire during the course of a determination, the quantity and distribution of radiation from it cannot be measured with anything like the same degree of precision as with a gas fire. Dr. Fishenden does seem to be satisfied, however, that the radiant efficiency of the coke fire is higher than that of the coal fire, and, according to the report, “the radiant efficiency of coal fires of different types varies from 19½ to 25 per cent., while, with fires of low-temperature coke in the same grate and burning under the same conditions, this amounts to 31 to 34 per cent.” It may be noted that the radiant efficiency of a modern gas-fire is approximately 45 to 50 per cent., but the report does not fail to point out that the real thermal advantage of the gas fire is much greater than would be indicated by any such comparison, because it can be used almost immediately at full efficiency for any period of time, great or small, this, of course, apart from any question of labour-saving and cleanliness. Cooking ranges were brought under test by Mr. A. H. Barker, and his reports are summarised in an appendix. “Mr. Barker lays stress on the extravagance in fuel involved by the necessity of heating the whole apparatus in the use of only

one or possibly two of its appliances,” and points out the further difficulty of obtaining high economy under ordinary working conditions because of the large excess of air employed.

It is plain that, whether coke or gas is used as a means of replacing raw coal for domestic uses, the smoke nuisance would be abated, and a section of the report given under the head “Air Pollution” shows this aspect of the fuel problem to be receiving attention from the Board. The pioneer work of Prof. J. B. Cohen (which should not be overlooked) was of great service in directing attention to the considerable quantity and evil effects of smoke in our atmosphere, and observations have since been multiplied by the Atmospheric Pollution Committee of the Meteorological Office, Dr. J. S. Owens, Mr. William Thomson, and others whose work is referred to in this report. The appointment of properly trained inspectors whose help and advice would be welcomed by industrial consumers of fuel is advocated, in addition to the establishment in every large works of an organised fuel control as the “only solid foundation on which to build more revolutionary or further-reaching methods of fuel economy.”

It is pointed out usefully that soot from the burning of raw coal, ash and dust from the burning of coal or coke, and acid impurities derived from the sulphur contained in coal, coke, and unpurified gas, are all to be taken into account in a consideration of atmospheric pollution resulting from the use of fuel, and it may be emphasised that the liability to pour out large quantities of fine ash into the atmosphere is not to be overlooked in considering the advantages and disadvantages of pulverised fuel. The use of pulverised coal has not been developed in this country to the same extent as in America, and, therefore, although the Board is putting down a small plant in order to make experiments at East Greenwich, it has thought it advisable to secure full information upon the subject through a report made by Mr. Leonard Harvey after a special inquiry conducted in America. Mr. Harvey visited important installations and collected there the experiences and views of the leading consumers of pulverised coal. His report has already been issued separately. “The advantages of the method as an almost perfect means of burning coal must be weighed against the cost of producing and handling coal-dust and the difficulties which may have to be overcome in dealing with its ash.”

Another special inquiry has been directed to the subject of peat. This work has been carried out mainly in Ireland, and has undergone vicissitudes, but a beginning seems to have been made, and reference is made to a paper, read before the Royal Dublin Society in March last, in which Prof. Purcell gave an admirable summary of the peat situation, not only in Ireland, but also in other countries. It is interesting to note, as indicating elasticity of method, that this paper will be printed as one of the special reports of the Fuel Research Board, and also that the help of the Department

of Scientific and Industrial Research has apparently been accorded for the production of an English translation by Prof. Ryan of Hausding's "Handbook on the Winning and Utilisation of Peat."

As regards fuel alcohol, the position is summarised thus: "It is obvious that until an estimate has been made of the possible resources for the production of alcohol within the Empire, and until their probable amount and the cost of using them have been ascertained, it would be useless to embark upon research on any extended scale into methods of production or utilisation."

The report, under the head "Gas Standards," gives a summary of the steps taken by Sir George Beilby and the Board from the time they were asked to advise on the subject by the Board of Trade, which recognised the complete inapplicability to modern conditions of gas standards as they had existed before the war. Conferences were held with those interested in the matter in different ways, and at a final conference resolutions were put and adopted which were forwarded to the Board of Trade, and constitute a new and much more rational method of regulating gas supply by statute. The central principle is that the consumer shall be charged with the potential thermal units supplied to him in the gas. The permissible percentage of inert constituents is limited by another resolution, although, of course, the temptation to pull "inerts" into the gas is removed now that they have to be distributed at the same cost as combustibles, but have not to be paid for. The gas undertaking can decide on the calorific value of the gas it intends to deliver, a power which should open the way for extensive technical development of the industry, and allow of the realisation of economies which have hitherto

been rendered impossible by useless and out-of-date restrictions. The refusal of Sir George Beilby and the Fuel Research Board to accept any restrictions in this regard, however pertinaciously and dogmatically they were put forward, unless they could be justified by some adequate reason, has exemplified in a striking way the advantage of referring a matter of this kind to a competent technical authority. The choice of a new standard is a new degree of freedom, but, the choice being made, the gas undertaking is required to adhere very closely to it. Recognition is here given to the valid principle that unsatisfactory performance of a gas-using appliance is far more likely to be due to variations from the standard than to any lowness (or highness) in the standard itself. It is recognised that if the standard is materially altered the burners in consumers' appliances may need alteration, and the gas undertaking has to make the adjustment. "The calorific value of the gas is to be continuously measured and recorded by a recording calorimeter of a standard type to be passed by the London Gas Referees," and by this means it is hoped that the control of gas quality can be made much more effective than it has been hitherto.

Sir George Beilby has had under observation for some time the Simmance recording gas calorimeter with apparently satisfactory results, but the strain will come when legal penalties are dependent upon the accuracy (or inaccuracy) of this or any other form of recording gas calorimeter. Presumably, however, the possibilities of error will receive full investigation, and the successful working of so promising a scheme for the regulation of public gas supply will not be endangered by the imposition of any rigid system of testing which is not one of fully proved trustworthiness.

### Use of Sumner Lines in Navigation.<sup>1</sup>

By CAPT. T. H. TIZARD, C.B., F.R.S.

THE Sumner line as a means of aiding in the navigation of ships has been in use for certainly seventy years, and is one of the best methods of obtaining the position of a ship at sea, for by its means both latitude and longitude can be obtained simultaneously without difficulty, and it has certain other advantages. In obtaining both latitude and longitude simultaneously, observations of more than one heavenly body are required, and the Greenwich time must be known accurately, as well as the approximate latitude. The altitudes of two or more heavenly bodies can be observed at twilight, both morning and evening, when the weather is clear, the horizon distinctly visible, and the stars are yet to be seen before the sky is lit up by the sun. It is possible, too, even without using the Sumner line, to observe in daylight meridian altitudes of Venus

or Jupiter if they cross the meridian at least two and a half hours before or after noon, and occasionally both sun and moon are available during the day. In northern latitudes the pole star is always available in clear weather, at twilight, for observations for latitude, and one or two other stars for longitude, but if neither the pole star nor a heavenly object near, or on, the meridian is available for obtaining the latitude, Sumner's method affords a means of doing so.

Sumner's method briefly is as follows: If a straight line be drawn from the centre of the earth to any heavenly body, at the spot where this line cuts the circumference of the earth, the altitude of that heavenly body will be 90°, which spot is named by Mr. Comstock the sub-polar point; a more appropriate name would be the zenith point—that is, the point on the earth's surface where the heavenly object observed would be in the zenith; and if circles be drawn on the earth's surface round this spot, with it

<sup>1</sup> "The Sumner Line or Line of Position as an Aid to Navigation." By G. C. Comstock. Pp. vi+70. (New York: J. Wiley and Sons, Inc.; London: Chapman and Hall, Ltd., 1919.) Price 6s. net.

as a centre, those circles are really circles of altitude of the heavenly body; so that when an observer takes an altitude of a heavenly body he is on a circle of altitude, and his position

be taken, and the resulting Sumner line should coincide in cutting the other two lines in, or close to, the spot already determined.

The second method of obtaining the Sumner

*Mercator's Projection.*

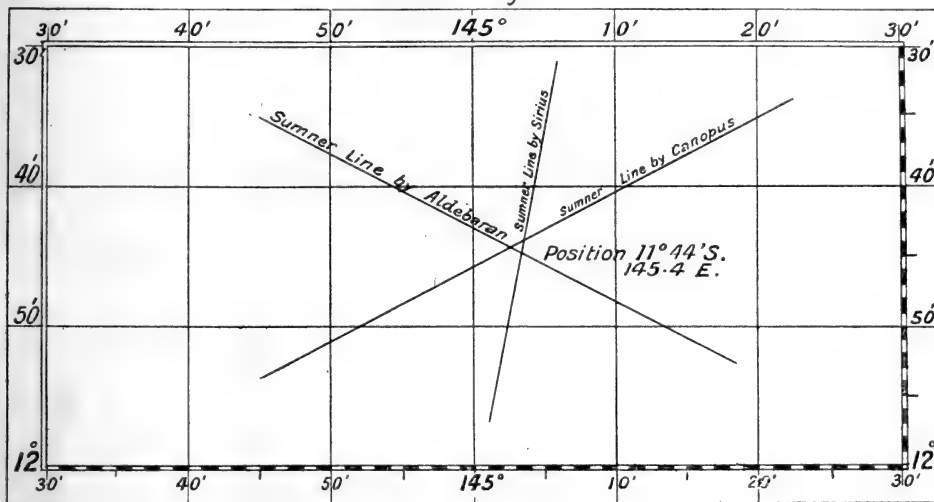

FIG. 1.

on that circle can be obtained by taking simultaneous altitudes of two heavenly bodies, or, in other words, of obtaining two circles of altitude which cut each other at a suitable angle, and the spot where they cut each other is the required position of the observer. The circles of altitude are of such a great radius that for short distances they are practically straight lines. There are two methods of obtaining the position of sections of these circles of altitude, or Sumner lines. In both it is necessary to know the exact Greenwich time, the approximate latitude, and the exact declination of the heavenly object. These are always available in a ship provided with a chronometer and a Nautical Almanac.

The first method is to assume two latitudes, one, say, 10 miles north, and the other 10 miles south, of the approximate position, and with each latitude, combined with the altitude and polar distance, to calculate the longitude, a process familiar to all navigators; then plot the two positions thus obtained and draw a line on the chart joining them, and the observer must be on that line. With observations of another heavenly body, and using the same latitudes, go through the same process, and the observer's position will be on the spot where the two lines cross each other. If it is very important to avoid error—as when sailing towards narrow channels through coral reefs, such, for instance, as the Raine Island passage through the Great Barrier Reef in Australia—observations of a third star can

line is to use only one latitude, and to calculate the longitude and the azimuth, or true bearing, of the heavenly body; then, as the circle of altitude, or Sumner line, is at right angles to the true bearing, already calculated, by plotting the

*Mercator's Projection.*

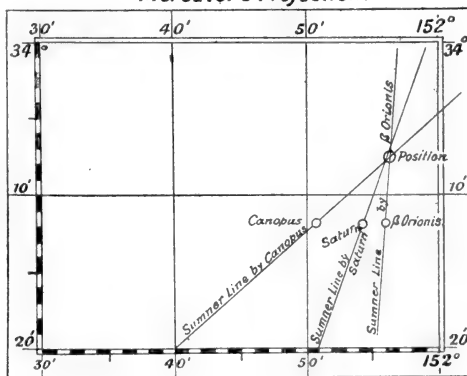

FIG. 2.

latitude and longitude and drawing lines at right angles to the true bearing, the position of the observer is where those lines cut each other.

The following examples illustrate the methods: (1) On August 30, 1874, when H.M.S. Chal-

lenger was making for the Raine Island passage, observations were taken at 5 a.m. of Aldebaran, Sirius, and Canopus, and the latitude was assumed to be  $11^{\circ} 40' S.$  or  $11^{\circ} 50' S.$  Using these latitudes, the position of the Sumner lines was found to be as shown in Fig. 1, and the position of the vessel to be  $11^{\circ} 44' S., 145^{\circ} 4' E.$

(2) On June 13, 1874, observations were taken at 6 a.m. (to fix the position of a deep-sea sounding) of  $\beta$  Orionis, Canopus, and Saturn, the latitude being assumed as  $34^{\circ} 12' S.,$  the resulting longitude by  $\beta$  Orionis being  $151^{\circ} 56' E.,$  and its azimuth S.  $86^{\circ} 26' E.,$  the Sumner line therefore running N.  $3^{\circ} 34' E.$  and S.  $3^{\circ} 34' W.$  The longitude by Canopus was  $151^{\circ} 50' 45'' E.,$  and its azimuth S.  $39^{\circ} 18' E.,$  its Sumner line running N.  $50^{\circ} 42' E.,$  S.  $50^{\circ} 42' W.;$  the longitude by Saturn was  $151^{\circ} 54' 15'' E.,$  and its azimuth N.  $73^{\circ} W.,$  and the Sumner line by it running N.  $17^{\circ} E.,$  S.  $17^{\circ} W.$  These lines are shown in

Fig. 2, and the position of the sounding was lat.  $34^{\circ} 8' S.,$  long.  $151^{\circ} 56' E.$

But the Sumner line has another advantage. When only one heavenly body is visible, and, therefore, the exact position of the observer cannot be obtained, if with an assumed latitude the longitude and azimuth be calculated, and the resulting Sumner line be plotted on the chart, if this line runs in the direction of the port, or point of land, towards which the ship is sailing, by steering along the Sumner line the vessel will reach her destination. For instance, if when sailing towards the English Channel an observation of the sun be obtained in the forenoon, when its azimuth, or true bearing, is somewhere between south and east, the Sumner line will be between east and north; and if this line runs towards the Lizard or some other known point, by steering along this Sumner line a good landfall may be obtained.

## Obituary.

DR. F. A. TARLETON.

FRANCIS ALEXANDER TARLETON, who died on June 20, was born in Co. Monaghan in 1841. He was the youngest son of the late Rev. J. R. Tarleton, of the Established Church in Ireland, and received his earlier education from his father. At the age of sixteen he entered Trinity College, Dublin. He was in the same year as the late Sir Robert Ball, whom he defeated at the moderatorship examination in mathematics in 1861, taking also a junior moderatorship in logic and ethics. Elected to fellowship in 1866, and called to the Bar in 1868, he was for a time assistant to the professor of applied chemistry, and professor of natural philosophy from 1890 to 1901, when he was co-opted a senior fellow. From that time until a few days before his death he sat as an efficient member of the board of Trinity College. Dr. Tarleton held several college offices, including those of senior bursar, senior lecturer, and senior dean, the last being a sinecure—for its statutory duties have long since lapsed. As senior bursar he showed his qualities as a first-class financier. He was at one time president of the Royal Irish Academy, and a member of the Board of Irish Intermediate Education.

As professor of natural philosophy, Dr. Tarleton followed the traditions of his distinguished predecessors, Williamson, Townsend, and Jellett, in treating the subject from a strictly mathematical point of view. Although he had a considerable practical acquaintance with experimental science, he flatly ignored the judicial aphorisms of Francis Bacon, and, instead of treating mathematics as the handmaid of physics, he rather inverted the order, and almost succeeded in reducing hydrodynamics, elasticity, magnetism, and electricity to branches of pure mathematics.

The writer attended Dr. Tarleton's moderator-

ship and fellowship lectures about twenty years ago in hydrodynamics, elasticity, and the electromagnetic theory of light, and was struck with wonder at his extraordinary memory and accuracy. For two and a half hours he would write down long and intricate calculations without the aid of any notes. Sometimes a student at the end of an hour would ask to be allowed to leave in order to attend a lecture in experimental science or history or other subject, and Dr. Tarleton would say with a snarl and a grimace (covering a heart full of humour and humanism): "Waal, if you prefer that *abominable* subject to mathematics, you are welcome to leave, and we're glad to get rid of you."

The last time the writer spoke to him, Dr. Tarleton expressed his intense dislike of Einstein's theory of relativity. He held that the Newtonian and Kantian conceptions of space and time are good enough to explain all possible phenomena, if sufficient mathematical ingenuity is shown, and he placed relativism in the same category as Bolshevism.

Dr. Tarleton wrote the following papers:—"On the Solid of Revolution having a Given Volume which experiences the Least Resistance in Passing Through a Medium," "Chemical Equilibrium," "Deductions from MacCullagh's Lectures on Rotation," "The Foundations of the Science of Number," "Notes on Crystallography," "Geometrical Proofs of Some Properties of Conics," "The Harmonic Determinant," "Laplace's Coefficients," and "A Problem in Vortex Motion." His two books "Dynamics" (written in conjunction with Williamson) and "An Introduction to the Mathematical Theory of Attractions" are first-class text-books of their kind. The latter contains a chapter on Maxwell's electro-magnetic theory of light.

R. A. P. ROGERS.

GEOLOGISTS will regret to learn that Dr. WHELTON HIND died on June 21. Dr. Hind was born at Roxeth, near Harrow, in 1860, and graduated in medicine and surgery in the University of London, also gaining the fellowship of the Royal College of Surgeons. He began practice at Stoke-on-Trent more than thirty years ago, and soon occupied a prominent place among the surgeons of North Staffordshire. His recreation from the first was field-geology, which suited both his athletic activity and his eagerness for purely scientific work. His early studies coincided with the movement initiated by Lapworth and others for the more exact correlation of stratified rocks by a very detailed study of their contained fossils; and Dr. Hind proceeded to apply this new method of "zoning," as it was termed, to the Carboniferous rocks of the neighbourhood in which he resided. His success in discovering the regular order in which the different assemblages of fossils occurred in Staffordshire and Derbyshire gradually led him further afield. He co-operated with members of the Geological Survey, and after extended researches in Lancashire and Yorkshire he joined Mr. J. Allen Howe in 1901 in contributing to the Geological Society of London a fundamentally important memoir on the classification of the Lower Carboniferous rocks of north-central England. Dr. Hind also recognised that, for the purposes of the stratigraphical geologist, the species of Carboniferous Mollusca needed more exact definition than had previously been attempted, and he devoted much labour to adding two finely illustrated monographs on the subject to the series published by the Palaeontographical Society. Some of the molluscs proved to be of value for recognising the various seams of coal in the Staffordshire coalfield, and in 1903 Dr. Hind and Mr. J. T. Stobbs prepared an illustrated wall-chart of them for the use of the practical miner. On the outbreak of war in 1914 Dr. Hind joined the Army as a gunner, and took part in some engagements in France; but he was afterwards employed as surgeon, and attained the rank of lieutenant-colonel. He received the Lyell medal from the Geological Society of London in 1917.

THE death, at the age of seventy-eight, of Mr. JAMES KENNEDY is a serious loss to Oriental studies. The son of an Indian missionary, Mr. Kennedy was employed in the Civil Service of India from 1863 to 1900. After his retirement he was a leading figure in the Royal Asiatic Society, serving as treasurer until illness compelled his resignation, and winning the respect of his colleagues by his learning, business capacity, and kindliness of nature. He was one of those patient workers who are always collecting materials, hoping for new light on difficult problems, and thus he failed to accomplish his projected task, a history of the relations of Indian culture with those of Nearer Asia. He contributed to the Proceedings of the Royal Asiatic Society several valuable monographs, the most important being devoted to the

early trade intercourse of Babylonia with India, the cults of Krishna, and the Aryans, the last published only a few months before his death. Though some of his ingenious speculations failed to meet with general acceptance, it is much to be regretted that he failed to accomplish the work to which his life was devoted.

LAST week there died in Paris, in his eighty-second year, M. ADOLPHE CARNOT, a member of the Academy of Sciences and of the Legion of Honour. M. Carnot was the grandson of M. Lazare Carnot and the son of M. Hippolyte Carnot, the Minister of Public Instruction in the Provisional Government of 1848. President Sadi Carnot was his elder brother. For many years M. A. Carnot held a professorship at the *École Supérieure des Mines*, and was afterwards its honorary director. He was also Inspector-General of Mines in France.

M. Carnot's scientific reputation rests chiefly on his contributions to analytical methods, and his treatise on the analysis of mineral substances is the standard French work on this subject. It comprises a detailed account of the occurrence, properties, reactions, methods of separation, and analysis of all the metals, including the rare metals, which are very fully described. The information given with reference to the rare metals is based largely on his own original work. He was a frequent contributor to the *Annales des Mines*, and published papers on methods of determining phosphorus, silicon, potassium, iodine, chlorine, bromine, vanadium, molybdenum, chromium, etc. In 1900 there appeared his important joint paper with Goutal on the verification of compounds existing in iron and steel by using reagents with which to dissolve out certain of the constituents. This paper is one of the best that have appeared on this subject.

WE regret to have to record the death of Mr. HAMMERSLEY HEENAN, which took place on June 17. Mr. Heenan was born in 1847, and had been a member of the Institution of Mechanical Engineers since 1875, and of the Institution of Civil Engineers since 1876. An account of his career appears in *Engineering* for June 25. At seventeen years of age he went to India and spent about fifteen years in the Public Works Department. Mr. Heenan returned to England in 1880 and founded the firm of Heenan and Froude, Ltd., of which he was chairman and managing director until his retirement two years ago. The firm is principally engaged on bridges and structural work generally. Among its undertakings is the Blackpool Tower. During the war Mr. Heenan rendered great service both in his personal capacity and in applying the resources of his works to the manufacture of munitions.

THE death is announced of DR. J. H. HYSLOP, the founder of the American Society of Psychological Research.

### Notes.

THE report of the Advisory Committee on Civil Aviation (Cmd. 770, price 2d.), dealing with the question of Government assistance for the development of civil aviation, will be read with interest by those who are concerned in the commercial future of the aeroplane. The report considers at length the present position of civil aviation and the results which have been achieved, and reaches the conclusion that as regards both the progress of commercial flying and the maintenance of a healthy aeronautical industry the indirect assistance given in the past is insufficient. Definite proposals for direct assistance are made. It is suggested that such assistance should be limited to a sum of 250,000*l.* within the two financial years 1920-22, and calculated on a basis of 25 per cent. of the total revenue of the aviation companies concerned, without differentiation as to the nature of the load carried by the machines. "Approved" routes are suggested: (a) London to Paris, with extensions; (b) London to Brussels, with extensions; and (c) a route such as England to Scandinavia, giving opportunities for the development of seaplane and "amphibious" machines. Air-Marshal Sir Hugh M. Trenchard criticises this policy in a minority report. He considers that the Committee is not justified in its assertion that commercial aviation has hitherto been a failure, and expresses the view that there has not yet been sufficient time for the advantages of aerial transport to be appreciated widely and so to create the necessary demand. He further considers the policy of subsidies to be fundamentally unsound, and thinks the money would be better spent in encouraging the design of experimental machines and in helping forward general research on aeronautical questions—a view for which there is much to be said. Assuming the subsidy to be granted, however, Sir Hugh agrees with the mode of application suggested by the majority report.

THERE has just appeared the second interim report of the Water Power Resources Committee, which gives effect to the extended terms of reference it received in October last, viz. to take into consideration the steps necessary to ensure that the water resources of the country are properly conserved and fully and systematically used for all purposes. The Committee recommends that there should be established, by Act of Parliament, a controlling Water Commission, having jurisdiction over England and Wales, upon which should be conferred certain statutory powers and duties relative, *inter alia*, to the compilation of proper records of the water resources and water requirements of the country, the allocation of these resources, the adjustment of existing anomalies and hardships, and the reconciliation of conflicting interests. Such a body would assist Government Departments concerned in the uses and control of water, would advise Parliamentary Committees before which Water or Water Power Bills may be heard, and generally would act as consultants and technical specialists to the Government in regard to questions within their purview. They would also

promote and initiate legislation for securing the development of rivers as a whole from source to mouth. The Committee recommends that further powers should be conferred on the Ministry of Health and other Government Departments to make orders authorising uncontested schemes of improvement. As regards its primary investigation, the Committee reports that there are several parts of Great Britain in which exist large sources of water power capable of development, but that it will deal more fully with this section of its inquiry in its final report, as well as with amendments required in the law in regard to pollution, underground water, and kindred subjects.

THE Department of Overseas Trade, in promoting the Empire Timber Exhibition at the Holland Park Skating Rink (July 5 to 17), has aimed at bringing under the notice of the British timber trade the various kinds of timber grown within the Empire. The exhibition will be fully representative of the timber-growing countries of the Empire, and should be of much interest and value.

THE annual meeting of the Somersetshire Archaeological and Natural History Society will take place on July 20-22, and an interesting programme has been arranged. On the opening day, at Bridgwater, the new president, Mr. A. H. Thompson, will deliver an address on "Medieval Building Documents, and What We Learn from Them." In the evening of the same day Mr. A. F. Major will read a paper entitled "The Geography of the Lower Parrett in Early Times and the Position of Cruca." On July 21 a lecture will be given by Mr. H. Corder on "Rambles round Bridgwater." In addition, there will be many excursions to places of interest. Further particulars of the meeting can be obtained from Mr. H. St. George Gray, Taunton Castle, Taunton.

THE DUKE OF CONNAUGHT on Thursday last paid a visit to the Royal College of Surgeons of England and received the diploma of an honorary fellow of the college.

THE RIGHT HON. H. A. L. FISHER and Sir James G. Frazer have been elected fellows of the Royal Society, under the statute governing special elections, on the grounds of their having "rendered conspicuous service to the cause of science."

AT the meeting of the Royal Society of Edinburgh on Monday, June 21, the following were elected foreign honorary fellows:—William Wallace Campbell, director of the Lick Observatory; Yves Delage, professor of zoology, Faculty of Sciences, Paris; Hendrik Anton Lorentz, professor of physics, Leyden University; Alfred Gabriel Nathorst, Stockholm; Ch. Emile Picard, perpetual secretary, Academy of Sciences, Paris; Charles Richet, professor of physiology, Faculty of Medicine, Paris; and Georg Ossian Sars, formerly professor of zoology, Christiania, and Director of Norwegian Fisheries.

MEDALS have been awarded to the following by the Council of the Royal Society of Arts for papers read before the society during the past session:—J. W.



Pearson, "The Seed Crushing Industry"; S. Preston, "English Canals and Inland Waterways"; Sir J. Currie, "Industrial Training"; Air-Commodore E. Maitland, "The Commercial Future of Airships"; Sir W. S. Meyer, "The Indian Currency System and its Developments"; A. Howard, "The Improvement of Crop Production in India"; Sir F. Watts, "Tropical Departments of Agriculture, with Special Reference to the West Indies"; and Sir J. Cadman, "The Oil Resources of the British Empire."

THE Ribéri prize of the Academy of Medicine of Turin has been awarded to Dr. G. Vanghetti for his researches on amputations and kinematic prostheses.

MAJOR KENELM EDGCUMBE has been elected chairman of the National Illumination Committee of Great Britain in succession to Mr. A. P. Trotter. A meeting of the International Illumination Committee is to be held in Paris next year to discuss technical subjects.

A MONUMENT to Wilbur Wright is to be dedicated on July 18 at Le Mans, France, near which town he carried out many of his aeronautical experiments.

THE annual meeting of the Research Defence Society was held on June 23, when an admirable address was given by Col. McCarrison on "Vitamines in their Relation to Health." Col. McCarrison spoke with authority; he made clear the facts already proved, and the intricacies of the study of vitamins. It is strange now to recall the old teaching about the "constituents" of our food; the proteins and the fats and the starches; the old South Kensington exhibits of an apple or a mutton-chop analysed down to half a dozen phials of chemicals, of water, and of "ash"; but not a word said of these potent and subtle vitamins which "animate the whole" and safeguard us against rickets and scurvy and beri-beri and epidemic dropsy. After the meeting Dr. and Mrs. Mellanby showed specimens of the results which they have obtained in this field of research, especially in the relation of vitamins to the growth of the bones and to the development of the teeth. The society's annual report speaks of increased activity in good educational work. The Jenner Society has become affiliated to the Research Defence Society, and this is a move in the right direction. The Research Defence Society has lately published an address by Sir Walter Fletcher on the work of the Medical Research Council, and is about to publish an essay by Sir David Bruce on tetanus and the use of tetanus antitoxin.

SIR CHARLES TOMES has presented to the museum of the Royal College of Surgeons of England the entire collection of microscopical preparations made by himself and also by his father, the late Sir John Tomes, during their investigations into the structure and comparative anatomy of the teeth. In this important donation are included the preparations—many of great beauty as well as of scientific worth—on which memoirs published in the *Philosophical Transactions* and *Transactions of the Odontological Society* were based. The gift thus made is to be known as the Tomes Collection, and will be accessible to all who are making a study of the comparative anatomy and microscopical structure of the teeth of vertebrate animals.

AMONG the worked flints collected from the ploughed fields of Norfolk and Suffolk Miss Nina F. Layard has lately observed several with well-defined finger-grips, which she describes in the latest part of the *Proceedings of the Suffolk Institute of Archaeology* (vol. xvii., part i.). The implements are beautifully illustrated by photographs, showing how they are adapted by chipping for holding in the hand. They include both scrapers and borers, and one seems to be suitable for cutting hides. The age of the implements is undetermined, and Miss Layard compares them with certain scrapers obtained by the late Dr. Sturge from Luxor, Egypt. She also points out that the North Alaskan Eskimos at the present day carve finger-grips in the wooden or bone handles in which they fix their stone scrapers.

THE problem how to make philology interesting has been solved by Sir George Grierson in two papers on the Indo-Aryan vernaculars reprinted from the *Bulletin of the School of Oriental Studies*. The Aryan languages cover, roughly speaking, the whole of the northern plain of India, penetrating in the case of the Pahāri dialects into the lower ranges of the Himalayas, while closely related to them is another group of tongues in the mountainous country lying south of the Hindu-Kush, which are here styled the Dardic or modern Pisācha languages. The most important result of the *Philological Survey* is that the Indo-Aryan vernaculars fall into three groups: the midland, occupying the centre of the great northern plain; the outer in a band on the west, south, and east; while between these lies the intermediate group representing the former shading into the latter. These groups of tongues are obviously the result of successive invasions or the peaceful introduction of foreign cultures. The pressing problem at present is how to combine the philological with the ethnological evidence, and Sir G. Grierson's papers are a valuable contribution to the solution of it.

MR. W. E. HEITLAND published in the *Journal of Roman Studies* (vol. viii., part i.) an elaborate, fully-documented article on the conditions of agriculture in Italy in Imperial times. He specially deals with the question whether Italy furnished a large number of farmer emigrants to raise and maintain provincial agriculture. He finds that the evidence does not favour such an emigration. One of the most pressing anxieties of the Emperors was to maintain a corn supply from Egypt and other African regions. But for the development of this industry native African farmers would be best qualified. Therefore, while we are entitled to assume that the Emperors were anxious to protect their *coloni* from the oppression of dealers with the connivance of corrupt officials, we ought not to base far-reaching theories of State-assisted emigration on the occurrence of a few Italian names in provincial inscriptions, the authors of which may not have been themselves *coloni*.

INFLUENZA was persistent this year in London for seventeen weeks from February 7 to May 29, the deaths from the disease, according to the returns of the Registrar-General, numbering 20 or more each week. For the previous fifteen weeks, from

October 15, 1919, to January 31, the deaths in London had ranged irregularly from 12 to 24. The return for the week ending June 12 gives only 13 deaths in London due to the disease, and in the preceding week the deaths were only 19. For the seventeen weeks ending May 29 the average deaths per week numbered 59, and in ten previous epidemics out of a total of twenty-eight since 1890 this number was exceeded, the highest weekly average being 500 in the epidemic of 1918-19, which lasted thirty-one weeks; the next highest was 171 in the epidemic of 1891, and 162 in 1892. The maximum number of deaths in a single week in the recent epidemic was 131, whilst in that of 1918-19 the number was 2458, the next highest maximum being 506 in 1892 and 473 in 1895. Of the twenty-eight epidemics since 1890 only two have embraced the summer months, those occurring in 1891 and 1918. The age incidence of the last three epidemics has differed widely from all others inasmuch as the active and able-bodied, aged between twenty and forty-five, have suffered most severely, although the attack, which has apparently now abated, was less marked in this respect than the two epidemics of 1918 and 1918-19.

*Medical Science: Abstracts and Reviews* for June (vol. ii., No. 3) contains among its articles a review of the subject of tuberculosis, particularly in connection with the war. Tuberculosis only slightly increased in France and England during the war, and mainly among young women in industry, whereas, in Belgium, Germany, and Austria, all classes of the community suffered and to a rapidly increasing extent. The principal causative factor for this difference appeared to be that of food.

In recent years the development of genetics has been marked by the establishing in various countries of a number of new scientific journals dealing with this rapidly growing subject. The latest addition to this list is *Hereditas*, the first number of which we have just received. It is issued by the Mendelian Society of Lund, Sweden, the president of which, Prof. H. Nilsson-Ehle, is well known for his breeding experiments with wheat. The journal will appear three times annually so far as possible, making a volume containing about 350 pages. The contributions are to be published in English, German, or French, and the subscription is 25 Swedish crowns per volume. The first number includes a study of the resistance of wheat to the nematode *Heterodera* and its inheritance, by Nilsson-Ehle; the hereditary transmission of deaf-mutism, by Lundborg, and of hereditary tremor, by E. Bergman; the rate of pollen-tube growth in *Oenothera* and its possible effect on inheritance-ratios, by Heribert-Nilsson, as well as studies of colour inheritance in peas and poppies, chlorophyll factors in the onion, and bud-sports in wheat. The new journal, which thus includes in its range the study of human as well as plant and animal material, will be a welcome channel of publication for the growing Scandinavian school of geneticists, and will take its place among the standard journals on this subject.

In the Reports of the South African Museum for 1918 and 1919 Dr. L. Péringuey records some new

facts relating to the Strand-loopers. In a cave-shelter a slab-painting was found above the kitchen-midden material and beneath a stalactitic column. Skulls in the midden were filled with gypsum. The geological conditions indicate that these formations must have taken a long time to produce—a longer lapse than is usually accepted. "If we take into consideration the conclusions of Shrubbsall, that Strand-looper skulls differ materially from the Hottentot or so-called Bush races, I am justified, I think," says Dr. Péringuey, "in claiming for the Strand-looper branch of the 'San' that occupied at one time the southern littoral of the former Cape Colony, not only a mode of culture more primitive than that retained by any living human race, but also a greater antiquity than for any other living African race." From the South-West Protectorate was obtained, and is figured in the Report, a rock-graving on which hoofs of animals and reduced representations of human feet had been produced by picking. Such gravings may, perhaps, denote places where the Bush people had found game. These are only a few of many interesting discoveries mentioned in these Reports.

THE Smithsonian Institution has a custom, which we commend to the British Museum, of publishing each year an illustrated account of its explorations and field-work. The report for 1919, just to hand, contains narratives and illustrations that might well stir the enthusiasm of the American public and lead to donations for similar purposes. Where so much is of interest to astronomer, anthropologist, ethnographer, geologist, and zoologist, we should be hard put to it to make a selection did we not find some notes by Mr. C. M. Hoy on the extermination of the Australian native fauna, to which the attention of British naturalists should be directed. "The greatest agent working towards the extermination of the native animals is the fox; next come the cattle and sheep men, who distribute poison by the cartload in the effort to reduce the rabbits. This has also caused or helped to cause the extermination of some of the ground-inhabiting birds. Another great agent is the bush-fires which sweep over the country. These are often lit intentionally in order to clear out the undergrowth and thus increase the grass. . . . The country at Bulliac is a good example of what the cattleman will do in a few years' time in killing off and burning the timber, and the consequent destruction of animal life. . . . The extermination of the native mammals has apparently gone much farther than is generally thought. Many species that were plentiful only a few years ago are now almost, if not altogether, extinct. Diseases have also played a great part in the extermination. The native bear died in thousands from a disease which produced a great bony growth on their heads. A mysterious disease also spread through the ranks of the native cat, *Dasyurus viverrinus*; the domestic cat also played a great part in their extermination. Even adult specimens of *Dasyurus* were often dragged in by the family cat. . . . There are very few game laws in Australia, and no one gives any attention to the ones that are in order."

THE greater part of a skeleton of the giant extinct marsupial *Nototherium* has lately been found in Mowbray Swamp, Tasmania. The skull and the limb-bones of the left side are described as well preserved, and are especially important for comparison with the numerous scattered remains of the same animal discovered in the Pleistocene deposits of Australia. The skeleton of *Nototherium* is less satisfactorily known than that of the allied *Diprotodon*, of which many specimens were found in Lake Callabonna, South Australia, about twenty-five years ago.

WE have received a copy of vol. v. (1918-19) of the *Journal and Proceedings of the Royal Society of Western Australia*, from which we learn that this society makes steady progress in membership and in the value and importance of its publications. The papers deal mainly with Western Australian problems. Prof. W. G. Woolnough writes on the physiographic elements of the Swan coastal plain, adding several details that have been overlooked in more general accounts. An important historical paper is one by Mr. J. S. Battye on the early colonisation of Western Australia. Mr. W. A. Saw contributes a paper on town-planning in Australia. His paper is noticeable for a number of well-chosen illustrations showing good and bad planning in various Australian towns.

M. EMILE BELOT, whose artificial volcanoes were recently mentioned in *NATURE*, vol. civ., p. 575, has published a work on "L'Origine des formes de la Terre et des Planètes" (Paris: Gauthier-Villars, price 14.40 francs). While holding that the earth and the moon developed from a state of luminous vapour of nebular origin, the heat of this vapour not being due to mere contraction, he points out, on the analogy of novæ, that the intensely heated stage may have lasted only a few months, while other successive changes, such as those when rains of chlorides fell upon a warm surface, may have occurred during the first few years of terrestrial evolution. We cannot here quote the figures by which M. Belot argues that the first waters would condense in the primitive atmosphere, owing to its high pressure, at the temperature of 364°; it is sufficient to mention that, on similar numerical reasoning, he shortens the interval between the first rainfall (Antarctic) and the middle of the Carboniferous period to less than ten million years. The tectonics of the crust are discussed with the aid of simple but suggestive diagrams, and the frequent reversal of views now popular will certainly encourage thought.

AMONG the handsome series of Professional Papers issued by the U.S. Geological Survey in these years of turmoil we may note one by Mr. E. de K. Leffingwell (No. 109) on "The Canning River Region, Northern Alaska." Its description and illustrations of soil and vegetation above permanently frozen ground, or above a subsoil consisting almost entirely of ice, are of wide interest in lands in which such conditions once prevailed. The author uses the term "ground ice" for bodies of ice in frozen ground, which involves confusion with what has always been known as ground ice ("anchor ice" is preferred by NO. 2644, VOL. 105]

Mr. Leffingwell) in rivers or in shallow seas. In most of the areas in which underground ice has been recorded, the downward limit of seasonal thawing is less than 7 ft., 3 ft. being the rule. The author shows, however, that this ice is a product of surface-thawing, water penetrating downwards and adding to the frozen masses at the present day. Underground ice will form wherever the mean annual temperature is some 4°-6° C. below freezing point. The author makes a strong case for his view that very large continuous ice-masses, with occasional inclusions of earth, like those of the New Siberian Islands, may arise from the growth year after year of ice-wedges originating from surface-cracks.

ON May 27 Mr. B. S. Gossling read an interesting paper on "The Development of Thermionic Valves for Naval Uses" to the Institution of Electrical Engineers. He gives first a history of the introduction of the thermionic valve into naval radio-telegraphy, laying stress on the use of Langmuir's formulæ for the value of the electron current as a guide to the numerical design of valves. To old-fashioned electricians the formulæ, which are numerous, are very uninviting. The physical dimensions on both sides of the equations appear to be quite different, and the continual introduction of the voltage to the power 1.5 is very puzzling. We think that the time has now come when the definitions of the fundamental quantities should be made more rigorous, and symbols should be used for the various quantities which show their physical dimensions. In the paper the successive stages of the approximations which were adopted in the calculation of the characteristics of valves are recorded. The final result shows that the observed behaviour of a high vacuum valve can to a first rough approximation be accounted for in terms of known physical laws. Many ingenious tests are described. The method adopted, for instance, for estimating the vacuum in a valve while still on the pump is to have a special vacuum tube attached to the apparatus and measure the width of the "cathode dark space." The paper gives a good idea of the immense amount of work done on the valve by physicists and engineers during the war. The variations of the thermionic properties of the valves which were so puzzling and annoying a few years ago have now been brought within bounds, and a rough standard specification for their production is given. Unfortunately, sufficient information to enable rigid life test clauses to be made is not yet available. It is a great step forward, however, that even a rough specification can be given.

BULLETIN No. 2 for 1920 of the *Classe des Sciences* of the Royal Academy of Belgium contains a communication from Messrs. J. E. Verschaffelt and R. Crombez on the anomalous dispersion of methyl-violet, fuchsine, and paranitrosodimethylaniline. The authors use the method of Soret, which Wood also adopted, which depends on the division of a glass trough with parallel surfaces into two parts by a glass partition extending from one corner to the opposite one. One of the prismatic troughs thus formed is filled with a solution of the material the dispersion of which is to be inves-

tigated, and the other with the solvent alone. Owing to the opposing action of the two prisms the dispersion of the solvent is thus eliminated, and the anomalous dispersion of the solute observed directly. By this means the authors have determined the indices of refraction of the materials as follows:—Methyl-violet for wave-length 6712, 2.52; 6497, 2.43; 4455, 1.23; and 4227, 1.45. For fuchsine 6712, 2.21; 6497, 2.41; 6170, 2.63; 5857, 2.78; and 4227, 1.19. For par-nitrosodimethylaniline 6497, 1.74; 6170, 1.78; 5857, 1.81; 5603, 1.85; and 5270, 1.93.

In the course of an article in *Engineering* for June 18 on the Birkenhead Shipyard and works of Messrs. Cammell Laird and Co., Ltd., reference is made to the original generating stations which supplied the whole of the power for the works. The original station was equipped entirely with gas engines supplied from a Mond plant, which also supplied gas to the furnaces in the platers' and other shops. The ten gas engines were of varying sizes, and had a total capacity of 2500 kw. This gas station has done good service, but the large number of comparatively small gas-driven units has resulted in a considerable maintenance charge. There has also been difficulty at times during the war in obtaining suitable fuel for the producers. These conditions, combined with a growing demand for power, have resulted in a decision to shut the gas station down altogether, and to transfer all power generation to the new turbine station. The matter is of some interest in view of the controversy on fuel economy, and illustrates the fact that there are points other than mere economy of fuel to be taken into consideration by large power-users.

We are asked to state that the Research Association of British Rubber and Tyre Manufacturers has secured laboratory accommodation in the Chemistry Department of University College, Gower Street, W.C.1.

We regret to learn from an inset announcement in the current issue of the *Scottish Naturalist* that, notwithstanding that all editorial work in connection with the journal is rendered gratuitously, there was a loss on the year's working, which, however, has been generously met, and that in consequence of the continued increasing cost of production there is a possibility of the magazine ceasing to exist. We trust that this contingency will be averted, for our contemporary has performed valuable services to Scottish natural history for the lengthy period of fifty years. A largely increased subscription list would probably save the situation, and the publishers, Messrs. Oliver and Boyd, Edinburgh, will be glad to have the names of all who will help in the way suggested to keep in circulation this useful scientific periodical.

THE latest catalogue (No. 188) of Messrs. W. Hefter and Sons, Ltd., Cambridge, gives particulars of upwards of 1900 second-hand books ranging over a number of subjects. There are sections devoted to science and mathematics; folk-lore and mythology; archæology; India; Ceylon; China, Japan, and the Far East; Turkey, etc. The catalogue, which will be sent free upon request, is worthy of perusal.

## Our Astronomical Column.

TEMPEL'S SECOND PERIODIC COMET.—The only additional information that has come to hand about this comet is that it was of magnitude 11 at the end of May. It should be of magnitude 9 or 10 in July, and therefore visible in moderate instruments. Accurate observations of position are badly needed, as very few were obtained at the last apparition in 1915. The period of this comet ( $5\frac{1}{2}$  years) is the shortest known except that of Encke. Observations were secured in 1873, 1878, 1894, 1899, 1904, 1915, and 1920. The following approximate ephemeris is for Greenwich midnight:

	R.A.			S. Decl.	Log $r$	Log $\Delta$
	h.	m.	s.			
July 6 ...	23	14	51	7 17	0.1216	9.6662
14 ...	23	39	41	8 59	0.1216	9.6791
22 ...	0	2	40	11 5	0.1236	9.6685
30 ...	0	22	24	13 27	0.1274	9.6636
Aug. 7 ...	0	38	50	16 1	0.1330	9.6650

DENNING'S COMET OF 1881 AND A METEORIC SHOWER.—The Rev. M. Davidson has recently made some interesting computations of the dates and radiant points of certain comets if they originate meteor showers. Among these, Denning's comet of 1881 indicates a radiant on August 4 at  $303^{\circ}-10^{\circ}$  about  $3^{\circ}$  N. of  $\alpha$  Capricorni. For many years a prominent shower of slow, bright meteors has been visible from this point at the end of July and the early part of August, and it is quite possibly connected with the comet named. It was well seen in 1900 and 1902, as well as in 1908 and 1916. The comet probably returned in 1890, 1907, and 1916, though it escaped observation, and the next return should occur in 1925 if the computed period of about  $8\frac{1}{2}$  years is correct. There are, however, meteors every year from this shower in Capricornus, and it should be specially looked for during the period from July 25 to August 8.

CAPTURE ORBITS.—Text-books on astronomy frequently contain a good deal of speculation on the possibility of capture of comets and satellites; we may quote as instances the Leonid meteors, supposed to have been diverted by Uranus from a quasi-parabolic orbit into an ellipse of short period, and the numerous comets of the Jovian family, on which Jupiter is presumed to have exerted a similar influence. In these cases the perturbing planet made the capture, not for itself, but for the sun. Capture of the former sort, in which the planet retains the captured body as a satellite, can apparently take place only with the aid of a resisting medium, in which case we must date the event in remote ages.

Little research of an accurate numerical character has hitherto been carried out on the subject. Prof. L. Becker contributes two papers to *M.N.* (vol. lxxx., No. 6), in which he shows that a star approaching a binary system may in certain cases suffer capture, while one of the original pair may be expelled from the system. He then points out that approaches would be more frequent in the direction of relative motion of the two star-streams, and by analysis of the distribution of the major axes of the orbits of binaries obtains a result in fair conformity with the theory. The research is made more difficult by the fact that there are two possible positions of the plane of a binary orbit. In a few cases (notably in the systems of Sirius and  $\alpha$  Centauri) the spectroscope has decided which of these positions is the correct one. There are probably several other systems in which the spectroscope is capable of giving a decision. Observations of this kind are very desirable wherever they are possible.

## Education in the New Era.

IN addresses given in Leeds last February Mr. F. W. Sanderson, headmaster of Oundle School, very boldly faces the root of the evil in existing educational systems as it is felt in the school, and advocates radical reconstruction upon new lines. His view is that schools should be altruistic in their aims and methods and be based on service and co-operation rather than on competition. They exist solely to aid and enrich the life of the people. Traditional methods based upon public-school models accentuate the anti-social spirit of competition and damp down co-operation, whereas the schools of the country ought to be the source from which the transfiguring and transforming spirit of the age is breathed through the thoughts of men. A school is a microcosm, and its subject-matter is to be found, not in books, but in the world around it, of which it itself should be an idealised model upon a small scale. It should concern itself with the tragedies of undeveloped talent, the slow decay of the faculties of masses of men caused by their employment in industry, and the sullen mental stupor that, after the violent revolutionary period of youth, brings peace on an animal level. For the schools are concerned with similar problems. The elevation of the submerged, the bringing back into the stream of school-life of the weak, and the raising of the general average are even more important than the provision of the fullest opportunity for talent and ability. So is it in the national life. We are presented with a vision of spacious halls and galleries, workshops, laboratories, gardens and fields, art-rooms, libraries, and museums for children to learn in instead of in stuffy class-rooms, by doing, making, inquiring, and co-operating rather than by the preparation for interminable examinations, which suit better those of the possessive and dominating order, of whom the world is growing so tired.

The policy of leaving dull, bread-winning drudgery unredeemed in the state it is, and concentrating upon the cultivation of the artistic and literary faculties of the workers in enlarged periods of leisure, can only have the effect of making the real work even more impossible. In spite of the cold douche of authority, we are told; in spite of the attitude of labour-leaders, once bit twice shy; and in spite of the enthusiasm ever seeking a new rallying ground for lost causes, workers, when they are left to themselves to plan their own scheme of salvation, choose for their education vocational and technical work. The average man glories in his daily work and trade so long as his heart is kept in it by his being treated as a human being rather than as a machine. In the spirit of craftsmanship, better than in medieval and drawing-room studies, is to be found the remedy for the evils of industrialism.

Science, the gift of the age, notwithstanding its repercussion upon the foundations of society, has not yet penetrated appreciably into our institutions of governance and education. It is the bed-rock upon which all future educational ideals must be based, and the new creative spirit it has reincarnated in the world—its spirit of inquiry for the love of truth for its own sake and its spirit of co-operation with others engaged in the same work—is that by which the age must outgrow the nightmare which the old spirit has made of it and the world. Scientific thought and research must be applied to creating new wine-skins rather than more new wine until this is put right. It has demolished the cobwebs of traditional economics and finance and substituted for them fundamental conceptions of the laws by which men live and move and have their being. It meets no

opposition, and scarcely even discussion, now from the professional exponents of the merits of the existing régime. Were it not for private interests and the ignorance of its ruling classes science would not have any difficulty in restarting the world on saner lines.

What is especially remarkable about this is that it is no vision of a dreamer, "sicklied o'er with the pale cast of thought," but rather that of a practical public-school headmaster, who has burst open the prison-doors of the pedagogic strongholds of the past and reclaimed for the schools the right and duty of serving and studying their own age. If there were ten such men, haply they might yet be in time.

This picture from a schoolmaster of what could be done in the school opens out broader visions of what universities might accomplish. They are in the most extraordinary case. They can claim that they have given in the research ideal of science—the finding out of the fundamentally new, *not* the mere rediscovery of the old that has been lost—the creative agency by which alone the modern world is great or even distinguished. But it has been done in the teeth of official apathy and discouragement. On the other side of the balance sheet is the traditional education they continue to give to the ruling classes, training them to be impervious to new knowledge and able only to find in the old and dead past ideals for imitation and reverence. These ideals and maxims have set the producers of wealth of the modern world at one another's throats for the benefit of its wasters. The code of laws remains as in olden time, though its obvious result has been to turn to debt the increase in the wealth of the community which the labours of scientific investigators have made possible. The world despises such results and wants something more from its old universities than that they should be beggars for their existence for crumbs from the tables that its own schools of science have loaded with gifts. It looks to them for a clear enunciation of the first right of the community to the produce of its own labours, which the law allows by taxation, for the upbringing of its own youth and for the cultivation of its creative institutions where knowledge is made and disseminated. The claim of the user upon that produce is secondary both by law and by common sense. And, lest again the stability of the world be endangered by its rulers being educated on myth and verbal subtleties to the total exclusion of the laws that appertain equally to Nature and to life, let them in the spirit of Plato inscribe over their reformed portals:—

"Let no one enter who is destitute of science."

FREDERICK SODDY.

## British Aeronautics.<sup>1</sup>

THE Report of the Advisory Committee for Aeronautics for the year 1918-19 is an interesting record of work achieved, which acquires additional interest by including a general review of progress made since the beginning of the war. More than ever, after reading it, one is impressed by the range and extent of the demands which this new industry has made upon existing knowledge; of the structural engineer it requires that its stress calculations and the testing of its materials shall be conducted with an accuracy never contemplated before; of the mechanical engineer, that its engines shall be economical both of material and of fuel to a degree which until very recently would have seemed almost

<sup>1</sup> "Aeronautics." Report of the Advisory Committee for Aeronautics for the Year 1918-19. Pp. 77. (London: H. M. Stationery Office, 1920.) Cmd. 488. Price 4d. net.

fantastic; and, above all, of its pilots, that with the skill and technique peculiar to their craft they shall combine a practical working knowledge of structure and of machinery, of instruments and "wireless," of meteorology and of navigation, which in other professions would be the province of different specialists. And this universality, as might be expected, is no less characteristic of the appeal which aeronautics has made to the man of science, who provides it with fresh data; so that it is not surprising to find that the single committee of pre-war days has been compelled to adopt a policy of devolution, and that special sub-committees have been formed to deal with problems of such different scope as "scale effect," the investigation of accidents, internal-combustion engines, light alloys, meteorology, atmospheric electricity, and new inventions.

The report abounds with indications of fields in which further research is needed, and there seems every reason to believe that this research will be prosecuted with equal success under the auspices of the newly constituted Aeronautical Research Committee. We learn with satisfaction that the demand for the earlier technical reports has been vigorous enough to justify the printing of a complete second edition, since an opportunity is thus given for inserting much more complete cross-references than were possible when they first appeared. It is, perhaps, a matter for some little regret that a more definite lead has not been given in this direction by the present report. We imagine that any reader whose interest in the subject extends to the detailed reports of the several sub-committees would wish to have such references to individual papers and their authors as will enable him to find additional information on any special point; moreover, an account so detailed, and yet empty of names and references, may fail to impress what we believe is the secret of British supremacy in aeronautics: that our official Committee has interpreted its functions as being advisory rather than executive, and has endeavoured to assist, co-ordinate, and encourage research rather than to originate and control it.

No useful end would be served, and perspective would be lost, by abstracting from these excellent and thoroughly condensed reports. Their range is very wide, extending from complete investigations, on both the practical and theoretical sides, of such complex evolutions as "spinning" to researches on the properties of light alloys, the transmission of heat from rough and smooth surfaces to passing currents of air, the conditions leading to discharge of atmospheric electricity from kite-balloons and cables, and the best shape for parachutes. Few, we believe, will read these pages without discovering some points of contact between aeronautical science and their own particular field of investigation.

Mention should be made of the very interesting table of comparative performances of British aircraft which is included as an appendix.

### Climatic Cycles and Tree-growth.

PUBLICATION No. 289 of the Carnegie Institution of Washington is devoted to Prof. Douglass's study of the annual rings of trees in relation to climate and solar activity. When the late Prof. Lowell was seeking an ideal climate for his observatory, with the view of studying the planet Mars, he chose the dry region of Flagstaff, Arizona, on account of its low rainfall and high proportion of clear skies. While Prof. Douglass was at the Lowell Observatory it occurred to him that variations in solar activity might have a measurable effect on tree-

growth, since the latter was probably dependent on rainfall, and rainfall might very likely be affected by solar activity. He began by studying the yellow pines of those arid regions, arguing that a very dry climate should be the best for such an investigation. He soon found that the intimacy of the connection between the width of the annual tree-rings and the rainfall, when the latter was known, was far closer than he had dared to hope, and he pushed further afield, examining tree specimens and fossils in European collections as well as in other districts of America.

Considerable labour was involved in the interpretation of the various appearances of the rings, the red tissue that denotes the close of a period of growth. The year starts in the autumn. With normal winter snow and spring and summer rainfall growth continues throughout until the autumn, and a ring of normal width is produced. If winter snow is deficient and spring rain also scanty, a narrow ring is produced, closing prematurely without waiting for summer rain. An intermediate condition is shown when winter snow is deficient and the spring drought is not so severe; red tissue begins to form, but growth starts again, and the result is a double ring for the year.

The author considers that five trees in a group give a trustworthy result in general, though in a very dry district like Arizona two might suffice. The only district where five trees failed to give a satisfactory cross-identification was a rugged region near Christiania, in Norway.

The Flagstaff record is complete from A.D. 1385, but among the sequoias of California stumps are in existence dating back more than three thousand years. Some of these sequoias grew on hillside slopes, and others in basins where plenty of moisture is found at all times. The latter are unsuitable for investigation, and the author calls them "complacent," as they show practically no variation in the annual growth. The others he calls "sensitive," as they have to depend upon snow melting down the slope and upon rain as it comes, not being provided with any storage such as that found in the basins. Some specimens, including the oldest of all, showed signs of a change in environment, "complacent" in later growth but "sensitive" earlier. Prof. Huntington had previously investigated these sequoias in his search for evidence of climatic change, but his purpose was served with much less detailed measurements, ten-year periods being short enough for his unit of time. His dates agree fairly well with those of the present work. The analysis of the data for periodicities required considerable accuracy in the method employed, and ultimately led to the adoption of the "automatic optical photodigraph," of the construction and application of which full details are given.

Practically all the groups of trees investigated show the sun-spot cycle or its multiples; the solar cycle becomes more certain and accurate as the area of homogeneous region increases or the time of a tree record extends farther back; this suggests the possibility of determining the climatic and vegetational reaction to the solar cycle in different parts of the world. A most suggestive correlation exists in the dates of maxima and minima found in tree-growth, rainfall, temperature, and solar phenomena, pointing to a physical connection between solar activity and terrestrial weather. There is a very important point discussed under the title of "Meteorological Districts." It is essential to restrict any such district for this purpose to one in which homogeneous weather conditions are found. Clearly, if one set of conditions makes one district wet and a neighbouring district

dry, these cannot be lumped together for correlation purposes, as the whole effect will be masked. We are reminded of the sun-spot maximum of 1893, which was associated with great heat in England and France, but was exceptionally cold in America and other parts of the world. This limitation of districts may not, as the author recognises, be the same for short periods as for long ones, but he finds the major characteristics in mountain regions very much alike over distances of fifty or sixty miles, and relies upon the evidence of the trees themselves for the demarcation of the districts.

One other small difficulty Prof. Douglass has met in an ingenious manner. It is often noticed that such an element as rainfall, when expressed as departure from the mean, as it must be in correlation problems, is arithmetically lacking in symmetry, since the defect can only be too per cent. at most, while excess can be very much larger. Geometrically, this can be avoided by using a logarithmic scale, but this flattens the variation very much. Prof. Douglass's device is to leave the deficient amounts unaltered, but in the case of excessive falls to invert the fraction and measure upwards from the normal. Thus a rainfall of twice the normal is indicated by a point just so far above the normal line as the point indicating a rainfall of half the normal is below it. The symmetry is not perfect, as, of course, no possible witness can give a point corresponding to zero rainfall, but the method is convenient in places where zero rainfall in the unit period is unknown. W. W. B.

### The Interferometer in Physical Measurements.<sup>1</sup>

A FOURTH volume describing the researches of Prof. Carl Barus with interferometers has recently been issued. The classical work of Fizeau, who applied interference methods to the determination of expansion coefficients, directed attention many years ago to the possibility of the kind of work which has been so well developed by Michelson and others, and in the present series of papers Prof. Barus seeks to develop the methods of application of the interferometer to a somewhat wide range of physical measurements. These include spherometer measurements, elastic deformation of small bodies, elongations due to magnetisation, pressure variation of specific heat of liquids, and even electro-dynamometry. The remainder of the volume deals with various modifications of the interferometer methods and with certain gravitational experiments.

Doubtless such an investigation of methods will be useful to workers in any of the foregoing fields, but so far as a first impression is to be trusted it would appear that the main interest has lain in the *method* rather than in any results which have been attained.

In order to study the motion of a contact lever, it may be made to carry two small mirrors reflecting normally two beams which are afterwards caused to interfere. Any rotation of the lever obviously causes a difference of path, which appears in the shifting of the easily recognisable and distinctive central "achromatic" interferometer fringes, such motion being measured by a plate micrometer or "graticule" in the observing telescope.

The two mirrors form the limbs of a "T" piece, which is pivoted about a hinge at the end of the foot. One limb ends in a contact pin which abuts against the surface, the motion of which is to be measured.

In such circumstances Prof. Barus estimates the

<sup>1</sup> "Displacement Interferometry by the Aid of the Achromatic Fringes." Part iv. By Prof. Carl Barus. (Carnegie Institution of Washington, 1919.)

limiting sensitiveness to be  $33 \times 10^{-6}$  cm., or perhaps even a third of this amount, but it should not be forgotten that the very simple interferometer system of an optical test-plate has a sensitiveness of about a quarter wave-length, say  $12 \times 10^{-6}$  cm., and this without a doubtful hinge and another contact. The contact lever can, of course, deal with non-specular surfaces, but to use it as a spherometer for a glass lens seems quite needless. Naturally, an apparatus of this nature is excellently adapted to such a problem as that of investigating the changes of length of a magnetised rod, and, although no very novel results are obtained, the investigation has been comparatively easy, and the method is well adapted for demonstration.

Suitable self-adjusting interferometers, such as are described in chap. vii., ought to find an increasingly useful place in the physical laboratory, and students should be taught the practical use of such instruments and their modifications. There is too great a tendency to treat an interferometer as a piece of apparatus sacred to one or two highly specialised purposes, but with little more than a few pieces of good plane parallel glass a set of instruments can be made up which should be of the greatest use in teaching and research.

One could wish, perhaps, that some one problem had been attacked and solved thoroughly. The curiously unfinished nature of the work is disappointing, but we must conclude that the method is the chief object. As regards the text, the descriptions are clear and praiseworthy, but the diagrams are both inadequate and unsatisfactory. L. C. M.

### Canvas-destroying Fungi.

WHEN men again began to take to their tents at the outbreak of war, many noticed that dark brown and black spots, frequently of a diamond shape, were not uncommon on the canvas. Small, surreptitiously acquired bits began to be scattered around for information as to the identity of the moulds causing the rot. Now it is very surprising that so little work has been done on canvas-destroying fungi. That canvas is liable to suffer from moulding seems generally to be known, judging from the fact that any material likely to get wetted is usually "cutched." Shortly before the war aircraft workers began to interest themselves in the fungi concerned in the damage, but it was not until war broke out that one realised the extent of the destruction of sails, tents, etc., by these organisms.

Major W. Broughton-Alcock, in the *Journal of the Royal Army Medical Corps* for December last, gives a short account of investigations carried out by him in Malta, Italy, and (in conjunction with Miss A. Lorrain Smith) at the Natural History Museum. In Malta attention was soon attracted to the rapid spotting and destruction of tentage—awnings last there only about a year. The investigators found that the principal agents of destruction of cotton- and flax-made canvas are *Macrosporium* and *Stemphylium*. The latter is the more prevalent in Malta, and could be isolated by exposing culture plates to the air. The colours of the spots on canvas correspond to the colours seen in cultures, being first brown and then black. The variation in the colour of the spots, especially noticed in flax-made and more resistant canvas, was found to be due to other fungi in association with the above genera—*Septoria*, *Alternaria*, *Helminthosporium*, *Chaetomium*, *Exosporium*, *Penicillium*, *Oospora*, *Torula*, *Saccharomyces*, and yellow pigment-forming and other air-borne bacteria. Though

these fungi may assist in the destruction, no proof was obtained that this took place without the presence of *Macrosporium* and *Stemphylium*. The fungi grew well on Sabouraud's medium and on ordinary agar.

According to the author, the first signs of fungoid growth appear on the inner side of the roof portions of tents and marquees. Often within three months pressure on the spots made by the fungi leads to perforation, or a strong wind causes tearing.

Cotton and linen duck-canvases ready for tent-making were examined, but, though the flax fibres were in good condition, brown mycelium was found more or less in abundance. It is suggested that the fungi reach and begin growth during the retting of the flax, though they may be present on the growing plant. Mycelium was not found on new cotton-made canvas, and "this is not surprising when its method of preparation is studied." It is not, however, probable that the infection of linen canvas is restricted to the period of retting. Guéguen (*NATURE*, vol. xcix., 1917, p. 206) was of the opinion that fungi from the dead stems of the textile plant were introduced amongst the fibres. This might account for their absence from new cotton-made canvas, but there is little doubt that both linen and cotton canvas often become infected after having been made up.

Experiments showed that the Willesden (cuprammonium) method and cutch treatment prevented the growth of the fungi. A method suggested by Prof. Pinoy (soft soap 1 in 500 solution, followed by a mixture of 1 per cent. of alum and  $\text{CuSO}_4$ ) greatly inhibited the growth, and its extended employment in Malta gave very satisfactory results. Mango-treated canvas was in no way inhibitive.

No mention is made as to whether the "cutch" was the ordinary commercial cutch (product of *Acacia*, etc.) or whether it was sodium chromate, which was used in certain areas. In Salonika this was found the best preventive for "diamond spot" on comparison with Guéguen's and Pinoy's treatments, and was at the same time a satisfactory camouflage.

J. RAMSBOTTOM.

### The Economic Pursuits of the Trobriand Islanders.

AT a meeting of the Royal Anthropological Institute held on Tuesday, June 1, Mr. S. H. Ray, vice-president, in the chair, Dr. B. Malinowski read a paper on "The Economic Pursuits of the Trobriand Islanders." In his opening remarks Dr. Malinowski criticised the methods usually followed by observers in dealing with the economics of primitive peoples. Whereas it was usually held that such peoples were preoccupied solely with obtaining an adequate individual food supply, he had found that, at any rate among the peoples which had come under his observation, there was a highly complex economic organisation. In support of his view he described the economic system of the natives of Kiriwina or the Trobriand Islands, lying to the north of easternmost New Guinea. These natives are very efficient and industrious tillers of the soil. Agricultural production is highly organised, being based upon two social forces: the power of the chief and the influence of magic. The chief is overlord of the garden-land, and initiates in each season the allotment of garden-plots to individuals and settles any disputes about garden-land; he finances any communal work to which the natives resort when clearing the bush, planting the yams, and bringing to the gardens the big, heavy poles used in connection with magical rites. On the other hand, the traditional garden magician controls the detailed proceedings of the work and performs magical rites at each stage.

There are several customary forms of communal work. An interesting institution of ceremonial enterprise, called *Kayasa*, is applied to gardening, fishing, oversea expeditions, and industrial activities, as well as to tribal sports, games, and dancing. Such a period of communal work is announced by the chief, who gives a big feast, which is followed during the continuation of the work by periodical distributions of food. Fishing, the building of houses and canoes, and other economic activities are based upon organisations similar to that of gardening. All are dependent upon the social power of the chief and the influence of the respective magician.

The distribution of the products is as highly organised as the production. The producer receives a certain portion, but a considerable part is used for the financing of big tribal enterprises through the chief, and another part is transformed into permanent wealth. By various tributes, dues, and offerings the chief collects about 30-50 per cent. of the tribal wealth, and he is the only member of the community who is allowed on a large scale to transform it into permanent wealth. This he does by keeping a number of industrial workers dependent on himself, who, for payment in food, produce polished "ceremonial" axe-blades, neck-strings of red shell discs, and arm-shells made of the conus shell, which are of very high value in the eyes of the natives, form the foundation of certain kinds of native trade, and are an indispensable feature of the social organisation of the natives. Every important transaction, whether ceremony or magical rite, birth, death, or marriage, has to be accompanied by gift and counter-gift. These are arranged, as a rule, so that while one party gives a substantial present of food, the other offers one of the tokens of native wealth, such as a ceremonial axe-blade, an arm-shell, or a string of shell discs. The powers of the chief are largely exercised through economic means. In inter-tribal affairs the chief backs up with gifts his summons to arms of his vassals, and the conclusion of peace after hostilities; and the same method of remuneration was followed when, in his narrower jurisdiction, direct punishment was meted out by ordering a special henchman to kill the offender or by calling upon a sorcerer to cast an evil spell on the victim. In both cases payment for the service was made in native tokens of wealth. These tokens of wealth have sometimes been designated by the term "money," but rather they represent stored-up wealth. Although a basketful of yams, a set of four coconuts, or a bundle of taro is, to a great extent, the common measure of value, there is no article among these peoples which, properly speaking, fulfils the function of a medium of exchange.

Two of these tokens of wealth, the arm-shells and the necklaces of shell beads, are used for a remarkable form of trade, called by the natives *Kula*, which embraces a ring of islands and archipelagoes lying to the east and north-east of British New Guinea, in which these two articles circulate in opposite directions. They are constantly being exchanged, scarcely ever being put to any use, but returning after a few years to the same district whence they were originally sent out, and then being traded again. The exchange is of a highly formal and ceremonial character, based on mythological tradition, and carried on according to very complex and rigid rules. Extensive and daring oversea expeditions in big sea-going canoes are made year after year, mainly in order to carry on this exchange. It involves a singular form of ownership, by which a token of wealth never remains in the hands of one man for any length of time. Instead of owning one article permanently, he owns a great number of articles temporarily. As a result of this



investigation it would appear that chieftainship, kinship, and social organisation in general are intimately bound up with the economic organisation.

In the discussion which followed the reading of the paper all the speakers emphasised the value and originality of the view of primitive culture which Dr. Malinowski had formulated in his interesting communication. Prof. Seligman asked how far the elaborate organisation of garden cultivation depended upon the existence of the chieftainship. Among the Southern Massim of New Guinea, for instance, there were no chiefs, and the native social organisation was based upon the hamlet. Had the elaborate garden organisation been observed among such peoples?

Sir James Frazer agreed that the economic aspect of primitive culture had not been adequately studied. It was interesting to note how the tribal economies were saturated with magic, and how the fallacy of magic still persisted among people who had developed a high system of agriculture. The mention of torches used by the magician in the ceremonies led him to compare the torches to which reference was made in the Greek legends of Demeter's search for Persephone. Was it possible that these torches represented a survival of a use of torches in early Greek agricultural ceremonies similar to that to which they were put in the Trobriands?

Mrs. Routledge suggested that an analogous complexity of economic organisation might be found among the people of East Africa with whom Mr. Routledge and herself had come into contact, where ivory played an important part.

Mr. Ray said that Dr. Malinowski had submitted a new view of ethnological investigation to the institute. Some of the ceremonies described by him suggested ceremonies from the other end of Melanesia, namely, Loyalty Island and New Caledonia, where the agricultural operations were directed by the chief, who prescribed what ground should be put under cultivation, the kind of crop, and the like, and received the first and best of the produce. Was it possible that these complex economic systems existed wherever there were chiefs whose position, power, and prerogatives depended upon the fact that they were of extraneous origin?

The lecturer in his reply stated that although garden magic was carried out by the Southern Massim at Dobu, cultivation was not accompanied by such a complex organisation for distribution.

### The Organisation of Scientific Work in India.

THE Indian Industrial Commission during its tour through India found that all was not well with the scientific worker, especially in connection with the application of his work to industrial development. While stating specifically in its report that "we do not propose to deal with the general problems of pure scientific research," it adds: "We were impressed by the value of the work which had already been done in the organised laboratories, and by the absolutely unanimous opinion which was expressed by all scientific officers as to the inadequacy of the staffs in point of numbers. Everywhere we were brought face to face with unsolved problems, requiring scientific investigation on an extended scale. On the one side, we saw the results accomplished by enthusiastic scientists, which, regarded from the purely economic aspect of the question, have added enormously to the productive capacity of India; on the other side, we were told by forest officers, agriculturists and indigo planters, engineers, and manufacturers, of the limita-

tions placed upon the development of their work and the frequency with which they were brought to a standstill by a lack of knowledge regarding matters which could only be ascertained by systematic research work." It is clear from these and other passages that the Industrial Commission desired to direct attention to the necessity for the elaboration of some scheme by which an organised attack might be made on the large number of problems awaiting solution in connection with the development of industry, and the conclusion reached is that "the maintenance of a staff of suitable technologists and scientific experts is essential to industrial development."

The Commission then gives its reasons for considering that it is the duty of the State to provide the necessary facilities, and concludes: "We have thus no hesitation in recommending a very substantial increase in the scientific and technical services as essential to industrial development." A general discussion follows as to the relative merits of a system in which the science is the bond, and one in which the bond is formed by the application of the sciences dealt with. In the first case the Geological Survey is given as an example, and the Agricultural and Forest Departments are quoted as examples of the second. But it is clear that the Commission was fully alive to the difference between a service and a department, and realised that the differentiation given above was the same as that between a service and a department, because it says: "The constitution of a certain number of scientific services based on the assumption that the science itself is a chief link between all members does not prevent the formation of departments, either Imperial or provincial, where the application of various sciences is the chief bond of union." The essential difference between the two types of organisation is clearly indicated in subjoined extracts from a despatch of the Government of India.

The Commission states that its proposals in the case of chemistry will have to be submitted to a special committee, and that it "hesitates to offer suggestions in greater detail regarding the organisation of the Imperial scientific services for bacteriology, botany, and zoology, as we consider that the best plan will be the appointment of special small committees for the purpose of formulating proposals." The first of these, that for chemistry, has now reported, and the report is open for discussion. As regards other sciences, it would be best to await the reports of the other committees before offering any remarks upon them.

The following extracts from the Government of India's despatch dated June 4, 1910, place in a very clear light the intentions which underlie the recommendations of the Commission:—

#### The Scientific Services.

One of the main proposals refers to the constitution of scientific services and of an industrial service. The Commission direct attention to the extreme importance of research under modern industrial conditions, and to the especial needs of India, in view of her vast unexploited resources in raw material and of the paucity of her scientific workers. They criticise the complete lack of organisation among men of science employed by the Government, and describe the difficulties, both administrative and technical, to which this gives rise. The Commission recommend as a remedy the creation of a similar mechanism to that through which the Central and Local Governments have hitherto carried out almost all their most important activities, especially those requiring technical knowledge, viz. all-India services; and they discuss the basis on which these services should be con-

stituted. The Commission propose the creation, not of scientific departments, but of scientific services—an essential distinction which has been clearly brought out in the replies of Local Governments, though it has not been so clearly apprehended by critics of the proposal. The Commission contemplate the recruitment of officers into separate scientific services, such as a Chemical, Botanical, or Zoological Service, for employment under Imperial and provincial departments, such as Forests and Agriculture, which deal with the application of a number of separate sciences. They propose that scientific officers in the employ of the Government, instead of being recruited in small numbers or single units into the different services which happen to require them, should be recruited as experts in their several sciences into scientific services, each with its appropriate conditions of qualification, pay, pension, and promotion. Although the services will be distinct entities for the above purposes, yet the only members of those services that will not be actually employed under the various departments that require their services will consist of a central staff, engaged under such officers, for instance, as Deputy Chief Chemists, at research centres, in scientific work. This central agency will also serve as a reservoir to meet the demands that may be put forward by other departments or by Local Governments for men to undertake temporary special investigations, to fill new posts or leave vacancies, or for the replacement of existing officers.

The head of each scientific service would thus exercise an influence over the members of his service in matters scientific, by the check of scientific results, and by the provision of advice and criticism on scientific work, whether for Local Governments or for research workers. It is not, we understand, proposed by the Commission, nor do we ourselves contemplate, that he should actually control research work in the sense of ordering definite problems to be taken up by officers serving under Local Governments, or should turn his department into a gang of hack researchers. We rely on constant correspondence between scientific officers of the same caste and periodical conferences as sufficient to correlate research programmes.

Local Governments and heads of Departments find the greatest difficulty in forming an opinion of the work done by men of science employed under them, or of the probable value of lines of research proposed by their officers. Should the administrative authority consider the results obtained by a man of science unsatisfactory, it is almost impossible to obtain an authoritative opinion on his work or qualifications; or to say whether he might not do better in another post; or to find such a post for him. The difficulties arising from the existence of isolated specialists in a department are, in fact, notorious.

The impossibility of applying any common measure in determining the respective claims to promotion of a botanist, a chemist, an engineer, and a political economist has been recognised in the existing services by the creation of separate posts on a time-scale. But this does not get over the difficulties already indicated, or supply the proper incentive to the research worker, or afford scope or prospects for men of more than average ability. The absence of such prospects is bound to militate against our chances of obtaining good recruits, to render our staff discontented, and to prevent our securing the best work from the best men.

Moreover, so long as students of a particular science are recruited sporadically on behalf of different departments as vacancies occur, the Government will have to accept the men that happen to be left over, whatever their qualifications, after other and more

regular demands have been supplied. The prospect of regular annual recruitment will enable the Government of India to fill its future demands for men of science, as it has hitherto done for engineers, forest officers, and medical men.

The present system, under which the only chemists employed by the State are scattered through numerous departments without any organisation that can marshal the chemical forces of the country to attack problems of national importance, can give no help towards an active industrial policy.

We might quote as illustrating the inspiring value of a central co-ordinating authority, the work undertaken by the Munitions Board through its chemical adviser. The report of the conference of chemists at Lahore shows that even our isolated and scattered chemists can be moulded into one team for the purpose of suggesting new lines of research and means for turning the results to practical account without overlapping and consequent waste of effort.

This experience, in the light of the magnificent results obtained in England by the Research Committee of the Privy Council, shows clearly how much may be expected from a system which provides a permanent organic connection between all chemists in Government employ.

The importance of a common system of recruitment and of a common service has recently been recognised by the council of the Institute of Chemistry in the United Kingdom (*vide* Proceedings of the Institute of Chemistry, 1918, part iv., p. 14) in a representation submitted by them to all Government Departments in which chemists are employed. They state their opinion that "the time is opportune for taking steps to secure for the provision of chemistry a position corresponding to that occupied by the learned professions, and they feel that much would be accomplished towards the attainment of that end if, in the first place, adequate and uniform conditions of appointment were accorded to chemists directly engaged in the service of the State. The necessity for a definitely organised chemical service (both in peace and war) for all purposes of the State on which the science of chemistry has a bearing has long been recognised in the chemical profession."

Conditions in India render the services of chemists employed under Government of even greater relative importance than in England. India is far more deficient than England in the knowledge of its raw materials and of the appropriate industrial processes; consulting chemists and chemists in private employ are almost entirely absent here, and this deficiency is not likely soon to be remedied. Research institutes with special reference to a particular industry in England, it would seem, will usually be financed and controlled by the industry itself, with a Government grant-in-aid, whereas in India the position will be precisely the opposite, and the industry will rely primarily on State chemists. We therefore agree with the Commission that the advancement of industries in India must depend for scientific assistance almost entirely on State-employed men, and these men will be far more concerned with the initiation of important new lines of development and research and far less with merely routine work than is the case in England. The need of organisation is the greater in that the functions of Indian State chemists are more important to the country; while their greater isolation and the consequent absence of a scientific atmosphere furnish an additional argument. The case for a State chemical service is thus even stronger in India than in England.

We are much influenced by the prospects which the proposed system affords of increasing the number of

Indians in the scientific services. An Indian appointed to an isolated post, or as an assistant to an isolated professor in a country where the scientific atmosphere is non-existent, or at the best exceedingly attenuated, lacks guidance and the stimulus of his fellows in the pursuit of scientific knowledge. His ambitions tend to become limited to the improvement of his pay and prospects rather than of his professional attainments. His membership of an all-India service, based on the pursuit of a common science, will increase the prestige of that science in his eyes and in those of the Indian public; the existence of the proposed Imperial nucleus of scientific workers under a distinguished chief will provide him with an incitement to excel with assistance in his studies and with opportunity for training if he desires it.

The Commission propose that, if the principle of scientific services is approved, committees should be appointed to formulate proposals for the permanent organisation and the terms of employment of each such service, and for the location and equipment of research laboratories. We support this recommendation, subject to the condition that the terms of reference to each committee should include a direction to report as to the advisability of constituting all-India services for each well-defined science.

Without anticipating the conclusions of the proposed committees, we think it desirable, in view of criticisms which have been expressed, to indicate certain principles in the general administration of these services which should govern the relations between the members of the scientific services and the heads of departments and provincial Governments, under whom many of them will be employed.

We do not think that members of scientific services should be seconded by the method which the Commission propose, viz. by deputation for periods of five years at a time; but we consider that (as in the case of other services) an officer, when once placed permanently under the orders of a local Government, should remain with the Government for the rest of his service, unless the Government under which he is serving itself desires his transfer, or unless his services are required in a higher post or in a post requiring special qualifications outside the province, in which case the local Government will recognise that the Imperial Government has a claim on them. This is the system which exists at present in respect of all similar services.

Local Governments would have complete liberty to appoint, after consulting the head of the service, to any post in their industrial or scientific cadre, any available member of the respective services; they would also be at liberty, in the special circumstances arising during the initial stages, to appoint to such posts men outside the service; but the subsequent admission to the all-India service of men so appointed would be entirely controlled by the Secretary of State. The local Governments universally support the proposed scheme of scientific services, and though the Governments of the Punjab, the United Provinces, and Bombay, and the officers and public bodies consulted by them, put forward certain criticisms of the scheme, especially with reference to the position of men of science in the Education Department, these criticisms are, we think, fully met by the foregoing explanation of the lines on which we think the proposed services should be administered.

We desire, however, to add a few remarks with special reference to the case of science teachers. We fully recognise that much is required of a scientific professor in a college, outside his scientific work. He must look on himself as a member of the body responsible for the tone of the college and for its

general success. It will, therefore, we agree, be most undesirable that such a man should continuously have in mind the possibility of promotion outside his own department. We think, however, that this difficulty will be obviated by the general principle laid down by us above, viz. that members of scientific services serving under the Department of Education should not be removed from that Department, unless at the request of the educational authorities, or for posts requiring high administrative capacity, or special scientific qualifications.

The advantage to the Education Department of a system of scientific services will still be very considerable. In the first place, we consider that, though university and college science workers should be by no means entirely divorced from technical research, their main sphere of activity should lie among problems of pure science. The proposed central scientific organisation should afford a means whereby such problems arising in the course of technical research can be referred to university and college laboratories.

Such co-ordination, both in respect of pure science problems and technical problems, can be most readily effected in cases where the educational researchers are themselves members of a scientific service. This policy will doubtless stimulate the interest in research work taken by students and professors. Officers who have entered the educational service as teachers may be in some cases expected to develop as research workers. The existence of all-India scientific services will afford a ready means for accommodating men whose aims in life have thus been diverted from one form of work to another. In the next place, the present system of recruitment of men of science into the Educational Service is capable of improvement, and far better results could be obtained with the aid and advice of watchful central agencies in India. The absence of a scientific atmosphere, again, has been particularly injurious to scientific officers in the Educational Service, and has led to great stagnation in respect of research work. This atmosphere will in future reach individual officers by the numerous channels of communication which will be created between them and the central agency on technical subjects, whether by way of correspondence, conferences, and scientific publications, by the central staff's tours of inspection, or by officers spending some portion of their vacations at research institutes. The case of men of science at present employed under the Department of Education will obviously require careful treatment; such men should not be allowed to join the scientific services as a matter of course, but each case will have to be considered on its merits, and there may still be classes of appointments for which men will have to be recruited independently. Further, the whole question, so far as it affects the employment of officers with scientific qualifications in colleges and universities, will have to be reviewed in connection with the proposals of the Calcutta University Commission regarding recruitment.

In addition to the opinions expressed in the letters received from local Governments, two important conferences of chemists have recently put forward their views on the Commission's proposals. A record of their discussions is appended. A full meeting of the Sectional Conference of Agricultural Chemists at Pusa in February passed the following resolution:—

"That this Conference considers that, in view of the intense local knowledge required for effective work for agricultural improvement by chemical methods, it is not desirable that the chemists in the Agricultural Departments should be formed into a service apart from the ordinary agricultural service,

in which the bond of union would be the science rather than its application. On the other hand, in addition to agricultural chemists attached to the Provincial Departments, this Conference is definitely of opinion that a strong central body of chemists should be maintained by the Imperial Department of Agriculture from whom Provincial Departments could draw for the investigation of special problems."

The main objection taken was, it will be observed, based on the idea that men would usually be transferred after five-year periods. We have explained already that such idea forms no part of the system which we contemplate. It is also significant that the same resolution declared the necessity of a strong central body of chemists for the Department of Agriculture; and, it may be added, the same meeting pointed out the desirability of equipping the agricultural research organisation to deal with certain industrial problems arising out of agricultural research. The sum of these conclusions seems to point to the desirability of supplying some agency which can correlate chemical research with agricultural and industrial problems, and of avoiding the needless expense of creating separate research nuclei for dealing with each separate class of chemical problems.

A conference of chemists was convened in Lahore in January, 1918, by the Indian Munitions Board. It included not only Government officers, but also chemists attached to missionary colleges and employed under private firms. The conference passed no formal resolution, but strongly supported the proposed system of scientific services.

### University and Educational Intelligence.

CAMBRIDGE.—As stated in our issue of June 2 (p. 537), a donation of 1000*l.* has been received for the provision of lectures on tropical agriculture for five years. Dr. C. A. Barber has been appointed as lecturer in tropical agriculture.

Dr. F. W. Aston has been elected to a fellowship in Trinity College.

In presenting Sir Joseph Thomson and Sir Joseph Larmor for honorary degrees at Cambridge recently, the Public Orator spoke as follows: "Democritus, philosophus ille antiquus, ut mundum explicaret, atomos finxit, solida rerum primordia, non partium conventu conciliata,

'sed magis æterna pollentia simplicitate.'

Sed, ut discipulus illius ait, difficile est credere in rebus esse quiddam solido corpore, quod demonstravit Professor noster. Atomum enim ipsum ingressus, partes discrevit, ordinavit, legibus subiecit. Immo ut Græcus ex atomo κόσμον eduxit, Anglus in atomum κόσμον introduxit. Et multa quidem ejusmodi investigavit, quæ dicere non concedit Latini sermonis egestas; hoc saltem concedit exponere, quanta universorum lætitia collegio suo Magistrum a Rege impositum nuper viderimus." And: "Adest alter e burgensibus nostris, idem rei physicæ Professor, Isaaci Newton et Georgii Gabriëlis Stokes non indignus successor, Societatis Regiæ olim a secretis, qui scientias innumeras provinciam sibi deposcit et illustravit. Ut carmen quoddam cenaticum discipulorum commemoremus

'æthera materiemque electraque cogitat ille  
somnia quæ possint mentes confringere nostras.'

Sed quem mundus ut virum solertem ingeniosum sapientem miratur, illum collegium suum amicum diligit, providum modestum fidelem. Quem si amplissimis honoribus hodie extollit Academia nostra, hoc multæ et apud nos et apud externos facere occupaverunt."

EDINBURGH.—Her Majesty the Queen has consented to accept the honorary degree of LL.D. on the occasion of the impending laying of the foundation-stone of the new chemistry department.

GLASGOW.—The degree of D.Sc. was conferred on June 23 on the following:—P. A. Hillhouse, for his thesis "Ship Stability and Trim," with other papers and D. B. Meek, for his thesis "Cyclonic Storms in the Bay of Bengal for a period of thirty years, from 1886 to 1915 inclusive, with special reference to their Location and Direction of Motion," with other papers.

On the same occasion the following special class prizes were awarded:—Mathematics (Advanced Honours Class): The Cunningham gold medal to J. M'Kinnell. Natural Philosophy (Ordinary Class): The Cleland gold medal to D. H. Findlay. Political Economy: The Alexander Smart memorial prize to Stewart Mechie. Moral Philosophy (Honours Class): The Edward Caird medal to I. W. Phillips.

On June 24 the degree of LL.D. was conferred on Dr. J. MacIntyre and Sir Robert W. Philip.

LONDON.—At a meeting of the Senate on June 23 Dr. S. Russell Wells was re-elected Vice-Chancellor for the year 1920-21.

Communications were received from the University College Committee and from the Dean of the University College Hospital Medical School, setting forth respectively the terms of the recently published offers made by the Rockefeller Foundation to present (a) to the University, on behalf of University College, the sum of 370,000*l.*, and (b) to University College Hospital Medical School the sum of 835,000*l.*, for the advancement of medical education and research. Resolutions were adopted expressing the Senate's grateful appreciation of the magnificent generosity shown by the Trustees of the Foundation to the University and to the Medical School of University College Hospital, and accepting the offer made for the benefit of University College.

Mr. A. E. Jolliffe, tutor in mathematics at Corpus Christi College, Oxford, was appointed to the University chair of mathematics tenable at the Royal Holloway College; Dr. B. J. Collingwood (professor of physiology at University College, Dublin) to the University chair of physiology tenable at St. Mary's Hospital Medical School; Prof. L. R. Dicksee to the Sir Ernest Cassel chair of accountancy and business methods tenable at the London School of Economics and Political Science; Mr. H. C. Gutteridge to the Sir Ernest Cassel chair of commercial and industrial law tenable at the London School of Economics and Political Science; Mr. T. E. G. Gregory to the Sir Ernest Cassel readership in commerce, with special reference to foreign trade, tenable at the London School of Economics and Political Science; Mr. D. Knoop to the Sir Ernest Cassel readership in commerce, with special reference to the organisation of industry and trade in the United Kingdom, tenable at the London School of Economics and Political Science; Mr. H. Dalton to the Sir Ernest Cassel readership in commerce, with special reference to tariffs and taxation, tenable at the London School of Economics and Political Science; Mr. L. Rodwell Jones to the University lectureship in commerce, with special reference to commercial geography, tenable at the London School of Economics and Political Science; Mr. J. D. Smith to the University lectureship in commerce, with special reference to business organisation, tenable at the London School of Economics and Political Science; and Mr. T. A. Joynt to the University lectureship in commerce, with special reference to transport and shipping, tenable at the London School of Economics and Political Science.

Grants from the Dixon Fund for 1920-21 were

made to Mr. A. S. E. Ackermann, for researches into the physical properties of clay; Mr. J. T. Carter, for researches on the minute structure of the teeth of fossil mammalia; Mr. L. T. Hogben, for researches on the influence of ductless glands; Miss M. A. Murray, for the study of anthropology in Egypt; Dr. F. J. North, for preparing illustrations for work in palæontology; Mr. A. K. Wells, for the conduct of a geological survey of part of Merionethshire; and Dr. C. West, for researches on the effect of environmental factors on the growth of *Helianthus*.

The degree of Bachelor of Science in household and social science for internal students is to be instituted.

Mr. P. J. HARTOG, Academic Registrar of the University of London, has been appointed Vice-Chancellor of the University of Dacca, Bengal.

Dr. R. E. M. WHEELER has been appointed keeper of the department of archæology in the National Museum of Wales, and lecturer in archæology in the University College of South Wales and Monmouthshire.

WITH reference to the recent offer by the Government of a site for the University of London (see NATURE, May 27, p. 404), a largely attended meeting of the council of the University of London Graduates' Association was of the opinion that the "offer of land on the Duke of Bedford's estate, accompanied by an undefined maintenance grant now made by the Government, is in no sense an equivalent for the accommodation as at present guaranteed by the Government, and does not comply with the stipulations laid down by the Senate."

THE following bequests, among others, of the late Dr. Rudolf Messel have recently been published:—5000*l.* to the Royal Institution of Great Britain; 1000*l.* to the Chemical Society; 2000*l.* and his platinum still, "in which I carried out with W. S. Squire my experiments in connection with the decomposition of sulphuric acid," to Mr. Squire, requesting him on his death to leave it to the Society of Chemical Industry; his platinum crucible to the Society of Chemical Industry; and his electric telephone by Reis to the Institution of Electrical Engineers. The residue of the property is to be divided into five parts, four of which are to go to the Royal Society and one to the Society of Chemical Industry, the wish being expressed that the fund shall be kept separate from the funds of the society, the capital to be kept intact, and the whole of the income expended in the furtherance of scientific research and other scientific objects, and that no part thereof shall be applied for charitable objects, as the granting of pensions and the like.

THE first annual conference of the International Federation of University Women will be held at Bedford College, London, on July 12-14. The federation has been formed to promote understanding and fellowship between educated women of different nations, and to unite them into a league to further their common interests and to strengthen the foundations of international sympathy which must form the basis of the League of Nations. The practical means by which the federation seeks to realise its aims are: (1) Organisation of a system of exchange of lecturers and scholars of different universities. (2) Provision of international scholarships and travelling fellowships, particularly the endowment of post-graduate and research scholarships. (3) Establishment of club-rooms and hostels for international hospitality in the various centres of university life. (4) Useful co-operation with the National Bureaux of Education in the various countries. Further information may be obtained from the acting secretary, Miss T. Bosanquet, Universities Bureau of the British Empire, 50 Russell Square, London, W.C.1.

## Societies and Academies.

LONDON.

**Aristotelian Society**, June 7.—Prof. Wildon Carr, vice-president, in the chair.—Rev. A. E. Davies: Anselm's problem of truth and existence. The famous proof of the existence of God is not purely ontological, but rather the verification of a specific mode of experience termed "faith." In Anselm's words, it is "faith seeking understanding," and by "faith" is meant a mode of immediate apprehension, awareness of God. Two stages are distinguishable in the reasoning. The first seeks to prove that we must think of ultimate reality in terms of existence. Here the appeal is to logical thought. In the second stage Anselm proves that this ultimate reality is his personal God. Here the appeal is to experience. The argument implies that truth and existence are two ultimate forms of reality: existence is the reality of things, truth the validity of thought-contents. Hence truth must be sought in terms of validity. This is the logical character of the "proof." We can "only know as perfectly as possible." We know existent reality only as our thinking is valid, and we cannot think validly that God is non-existent. Between these two ultimate forms of reality is presupposed a fundamental agreement, such that the relations of thought validly represent the real relations of things. For Anselm such agreement has its ground in God. A second implication is that when thinking is valid it starts from existence, in the same sense that its contents are occasioned by existent reality. So that without experience we cannot know. The ethical character of the basic conception of God proves it to be no mere thought-product—that is, knowledge presupposes a mode of reality dissimilar from itself.

**Zoological Society**, June 15.—Prof. E. W. MacBride, vice-president, in the chair.—Dr. P. Chalmers Mitchell: Report on the additions to the society's menagerie during the month of May, 1920.—Prof. J. E. Duerden: Exhibition of and remarks upon a series of ostrich eggs.—Miss Joan B. Proctor: (1) A collection of tail-less batrachians from East Africa made by Mr. A. Loveridge in the years 1914-19. (2) The type-specimen of *Rana Holsti*, Boulenger.—R. I. Pocock: The external and cranial characters of the European badger (*Meles*) and the American badger (*Taxidea*).—Dr. R. J. Tillyard: Life-history of the dragon-fly, with special reference to Australasian forms.

**Mineralogical Society**, June 15.—Dr. A. E. H. Tutton, past president, in the chair.—F. P. Mennell: Rare zinc-copper minerals from the Rhodesian Broken Hill Mine, Northern Rhodesia. Copper minerals, including malachite, chersylite, copper-glance, and undetermined phosphates, are of rare occurrence in the lead-zinc ore of this locality. Still rarer are the copper-zinc minerals aurichalcite and veselyite; the latter forms minute sky-blue monoclinic crystals ( $a:b:c=0.71:1:0.95$ ), and differs from the original mineral from Hungary in its colour and in containing little or no arsenic.—Prof. R. Ohashi: Note on the plumbiferous barytes from Shibukuro, Prefecture of Akita, Japan. This mineral, which is deposited as a white to brownish-yellow crystalline crust in the fissures and near the orifices of hot springs, is similar to the mineral recently called "hokutolite" from Taiwan (=Formosa); it contains 4.69 to 17.78 per cent. of PbO, and is radio-active.—W. A. Richardson: The fibrous gypsum of Nottinghamshire. The relation to the nodular types of gypsum of the fibrous veins of the mineral, which are associated with every other type of gypsum deposit in the district and occur at levels

where there is no other development of the mineral, was considered. Most of these veins are regarded as having been formed shortly after the nodular deposits. The fibres grew upwards and downwards from a plane in the marl, and were probably deposited by descending solutions, being precipitated at planes of tension in a contracting medium. The veins of fibrous calcium carbonate of "beef" described by Dr. Lang show similar structure and field relations, and doubtless originated under similar conditions.—**W. A. Richardson**: A new model rotating-stage petrological microscope. This instrument is intended as a substitute for the larger pre-war models, which at the present time could be manufactured only at very high prices. It is provided with a mechanical stage interchangeable with a plane stage and a conventional sub-stage, and provision is made for rapid change from parallel to convergent polarised light. Owing to the reduction in size, a rotation of  $270^\circ$  only can be provided for the rotating stage.—**W. Barlow**: Models illustrating the atomic arrangement in potassium chloride, ammonium chloride, and tartaric acid. In the case of the chlorides the suggested structure reconciles the X-ray phenomena with the crystalline symmetry. The arrangement proposed for tartaric acid agrees with the graphical formula of the chemists, and the molecular groups have the symmetry and relative dimensions of the crystals.

**Royal Meteorological Society**, June 16.—**Mr. R. H. Hooker**, president, in the chair.—**W. H. Dines**: The ether differential radiometer. This instrument has been designed to measure the radiation from the sky after sunset. It consists of two glass test-tubes containing air and a few drops of ether connected by a glass U-shaped tube containing ether to serve as a pressure-gauge. Each test-tube is provided with a movable shield, which protects it from draughts and allows radiation from one direction only to fall upon it. It is used by first directing radiation from the sky upon one of the test-tubes, and then radiation from a "black" body at a known temperature. The known temperature is adjusted until the change has no effect upon the pressure-gauge, and when this is the case it may be assumed that the radiant energy absorbed by the test-tube from the sky is the same as that from the black body, whence the radiation from the sky is found by a table. The equivalent radiation temperature of the sky is often below  $0^\circ$  F., and a method is shown by which in this case the sky radiation can be found without the use of freezing mixtures. This is done by compensating the small radiation from the sky by the excess of radiation from a hot body, so that neutral effect is obtained. The method of calculation and of making up the results is given.—**Prof. S. Chapman** and **E. A. Milne**: The composition, ionisation, and viscosity of the atmosphere at great heights. In the stratosphere, owing to the absence of large-scale mixing, the different constituents of the atmosphere must tend to separate out by diffusion, so that the composition varies with the height; in particular, well-known calculations have shown that, on the usual assumption of the presence of free hydrogen, the atmosphere above 120 km. must consist almost entirely of hydrogen. The authors criticise this assumption; an examination of the evidence renders uncertain the actual existence of this hydrogen atmosphere, and the authors accordingly recalculate the variation of composition with height on the assumption that hydrogen is absent. In this case helium, the next lightest element, is the predominating constituent above 100 km. The results are then used to make an estimate of the depth to which  $\alpha$ -,  $\beta$ -, or  $\gamma$ -radiation arriving from an extra-terrestrial source would

penetrate the atmosphere. It appears that the range of  $\alpha$ -particles would extend down to about 80 km., some 20 km. below the auroral zone. In the case of  $\beta$ - and  $\gamma$ -radiation it is found that the maximum absorption, and consequently the maximum ionisation, should occur at heights of about 50 km. and 25 km. respectively. In each case the region of appreciable ionisation would be confined to a layer of 35 km. thickness, and the unexpected result emerges that the layers would be comparatively sharply defined at their under-surfaces, which practically coincide with the positions of the maxima. These estimates have an interesting bearing on recent theories of the existence of ionised layers in the atmosphere. Lastly, attention is directed to the fact that at great heights, though the coefficient of viscosity is little altered, the density is so small that the effective viscosity is very high, so that any large-scale motion must die down immediately.

**Royal Microscopical Society**, June 16.—**Mr. A. N. Disney**, vice-president, in the chair.—**L. T. Hogben**: The problem of synapsis. The data of Mendelian experiment furnish the only critical basis for correlating genetic phenomena and cell-structure, and recent work on the cytoplasmic inclusions (Duesberg, Gatenby, and others) indicates that these elements fulfil none of the conditions which would provide a satisfactory material foundation for alternating, and in many cases biparental, inheritance of any sort. The theory of synapsis postulates the conjugation in the meiotic phase of homologous chromosomes derived from alternate parents preparatory to their segregation in the reduction division, and thus affords an interpretation of gametic purity and allelomorphism. The theory itself rests upon the assumption of the persistent individuality of chromosomes and the definitive organisation of the nuclear reticulum. The study of the meiotic phase raises three questions: ( $\alpha$ ) Is there an actual conjugation of chromosomes in the prophase? ( $\beta$ ) If so, in what manner is it effected? ( $\gamma$ ) Do the chromosomes which pair in synapsis separate in the reducing divisions? As regards the first, it is pointed out that the parasynaptic and telosynaptic interpretations for animals are mutually exclusive; the early meiotic phenomena in plants and animals are probably very different. With respect to the second, the question of discovering a mechanism for the interpretation of partial linkage arises. To the last question it is impossible to provide a definite answer from the available data, hence the most valuable evidence on synapsis is inferred from the different sizes and shapes of chromosome pairs in premeiotic mitoses. It is submitted, therefore, that while the cytological phenomena of hybridisation and mutation may yield significant facts, a clear recognition of the relation of the mitotic chromosomes to the organisation of the interkinetic reticulum and a fuller knowledge of the synaptic processes are the most pressing needs for further development of the chromosome hypothesis.—**Sir Horace Darwin** and **W. G. Collins**: A universal microtome. This instrument, which is designed on similar general principles to the Cambridge rocking microtome, cuts sections from objects embedded in paraffin or celloidin or from frozen preparations. It has the advantage over the rocking microtome of cutting flat sections. The plane of the sections is horizontal, which facilitates examination, and the orientating object-holder is of a novel form and easy of adjustment. The rigidity of the frame and object-holder, and the fact that the knife is rigidly clamped at both ends, secures uniformity in the sections. The microtome has no large working surfaces which must be covered with oil, hence irregularities due to varying thickness of the oil-film are eliminated.

The regularity of cutting is unaffected by wear. The rigid connection between hand and object and the smallness of the friction and inertia of the moving parts make for convenience of manipulation. The knife-holder is easily adjusted to give a slicing cut, and can also be moved so that sections can be cut with new parts of the knife as it becomes blunt or damaged. A simple accessory also enables the clearance angle of the knife to be adjusted.

## PARIS.

**Academy of Sciences, June 14.**—M. Henri Deslandres in the chair.—The president announced the death of Prof. Auguste Righi, and gave a short account of his life-work.—A. **Rateau**: Maps of the network of electricity distribution in France. Work of the Technical Committee of the Hyrotechnical Society of France. An account of the work of the society since its establishment in 1912. Its object is the study of all questions relating to the regulation and utilisation of waterfalls. The map, on the scale of 1/200,000, will consist of eighty-four sheets, seventy-eight of which are now submitted to the Academy.—C. **Guichard**: Determination of the congruences C and the congruences 20 which belong to a linear complex.—Ch. Ed. **Guillaume**: The action of metallurgical additions on the anomaly of expansion of the nickel-steels. Certain applications of nickel-steels render necessary the addition of other elements—manganese, carbon, chromium, tungsten, and vanadium. A detailed study of the action of additions of manganese, chromium, and carbon has been made, and the results obtained have been summarised in two diagrams.—J. **Tilho**: The frequency of fogs in the Eastern Sahara. Detailed observations of these dry dust fogs are necessary, especially in the interest of aerial navigation. The results of three years' observations are given, classified as thick, medium, and light, according to the month. The fogs are relatively rare in the months between August and November.—M. Ch. Riquier was elected a correspondant for the section of geometry in succession to the late M. Zeuthen, and M. Pierre Weiss correspondant for the section of general physics in succession to Sir J. J. Thomson, elected foreign associate.—E. **Cartan**: The projective deformation of surfaces.—J. **Andrade**: The special right lines of contact of general helices.—S. **Procopiu**: The double refraction and dichroism of the fumes of ammonium chloride in the electric field. The double refraction and dichroism of ammonium chloride fumes vary with the time and differently. The double refraction varies very nearly inversely as the square of the wave-length, and the dichroism inversely as the third power. If the phenomenon predicted by Voigt exists, it is masked.—MM. **La Rosa** and **A. Sellerio**: A galvanomagnetic effect parallel to the lines of force and normal to the current.—G. **Le Bon**: Certain antagonistic properties of various regions of the spectrum. A screen of zinc sulphide placed behind a trough containing a solution of sulphate of quinine remains unaffected; if a trough of ammoniacal copper sulphate solution is superimposed, the zinc sulphide screen phosphoresces. Similar phenomena were utilised for signalling at night during the war.—J. **Meunier**: The catalytic action of aluminium in the preparation of the chlorobenzenes. Aluminium is superior to the usual catalyst, iodine, in this preparation. A weight of aluminium equal to one-thousandth of the benzene gives the best results. A detailed example of the method is given.—P. **Landrieu**: Researches on the polyacid salts of the monobasic acids: sodium tribenzoate.—R. **Blanchard**: The Durance glacier at Sisteron.—L. **Cayeux**: The iron minerals of the Longwy-Briey basin.—G. **Mangenot**: The

chondriome of the Vaucheria. Further experimental evidence, both on the living plant and on fixed stained sections, in support of the views put forward in an earlier communication and adversely criticised by M. Dangeard.—E. **Saillard**: The sugar-beet during the war. The general conclusion is drawn that by using little manure, and especially little nitrogenous manures, the roots are richer in sugar and easier to work. The total production of sugar per hectare is alone affected by this abnormal culture. Similar results have been obtained in Germany.—Ch. **Porcher**: Want of food and the chemical composition of milk. A criticism of the experiments of Lami, together with additional work on the same subject. While accepting the figures of Lami, the author gives them another interpretation, and considers that the variations of chemical composition observed are due to the retention of milk and not to starvation.—P. **Mathias**: The structure of the lips of fishes of the genus *Chondrostoma* (family Cyprinidae).—M. **Piettre** and A. **Vila**: The separation of the proteins of the serum. The technique proposed differs considerably from the classical methods studied by Hofmeister, Starke, Michailoff, and J. Kauder, as large quantities of mineral salts are not used. The serum is exactly neutralised, precipitated by acetone, and the albuminoids extracted with water, the last washings being saturated with carbon dioxide. The insoluble proteins free from albumin are left as a greyish-white precipitate.—G. **Bertrand** and Mme. **Rosenblatt**: The action of chloropicrin upon some bacterial fermentations. Details of experiments on the action of chloropicrin at different concentrations on the lactic ferment, the ammoniacal ferment, and the sorbose bacterium. Chloropicrin was found to exert a strongly toxic action upon all living cells, and is comparable, in some cases, with the most powerful known disinfectants.—A. **Frouin**: Variations in the fatty matters of the tubercle bacillus cultivated on definite media in the presence of earths of the cerium group.—F. **Ladret**: Tropic superactivity: giant cell and cancer.—MM. **Fauré-Fremiet**, **Guieysse**, **Magne**, and A. **Mayer**: Cutaneous lesions determined by certain vesicant compounds.

## Books Received.

Chemical Theory and Calculations. By Prof. F. J. Wilson and Prof. I. M. Heilbron. Second edition. Pp. vii+144. (London: Constable and Co., Ltd.) 4s. 6d. net.

The Elements of Electro-Technics. By A. P. Young. Pp. viii+348. (London: Sir Isaac Pitman and Sons, Ltd.) 7s. 6d. net.

Historical Geography of Britain and the British Empire. In two books. Book i.: The Making of England: The Making of Empire: The Establishment of Empire, B.C. 55 to A.D. 1815. By T. Franklin. Pp. viii+216. (Edinburgh: W. and A. K. Johnston, Ltd.; London: Macmillan and Co., Ltd.) 2s. net.

Space, Time, and Deity. By Prof. S. Alexander. 2 vols. Vol. i., pp. xvi+347; vol. ii., pp. xiii+437. (London: Macmillan and Co., Ltd.) 36s. net.

Education for Self-Realisation and Social Service. By F. Watts. Pp. xii+275. (London: University of London Press, Ltd.) 7s. 6d. net.

The Child Welfare Movement. By Dr. Janet E. Lane-Clayton. Pp. xi+341. (London: G. Bell and Sons, Ltd.) 7s. net.

A Summer Tour (1010) through the Textile Districts of Canada and the United States. By Prof. A. F. Barker. Pp. xi+197. (Leeds: Printed by Jowett and Sowry, Ltd.)

The Cambridge British Flora. By Prof. C. E. Moss. Assisted by specialists in certain genera. Vol. iii. Pp. xvi+200; plates, pp. vi+191. (Cambridge: At the University Press.) Two parts. 6l. 15s. net; 2 parts in 1 vol., 7l. net.

Memoirs of the Geological Survey. The Geology of Anglesey. Vol. i. Pp. xl+388+xxvi plates. Vol. ii. Pp. 389-980+plates xxvi B-lx+folding plates. By E. Greenly. (Southampton: Ordnance Survey Office; London: E. Stanford, Ltd.) 2 vols., 3l. 3s. net.

The Arithmetic of the Decimal System. By Dr. J. Cusack. Pp. xvi+492. With Answers. (London: Macmillan and Co., Ltd.) 6s.

Medical Research Council and Department of Scientific and Industrial Research. Reports of the Industrial Fatigue Research Board. No. 7: Individual Differences in Output in the Cotton Industry. (Textile Series, No. 1.) Pp. iii+13. (London: H.M. Stationery Office.) 6d. net.

Les Révélations du Dessin et de la Photographie à la Guerre: Principes de Métrographie. By Lt.-Col. Andrieu. Pp. xxii+112. (Paris: Gauthier-Villars et Cie.) 8 francs.

Elements of Radio-telegraphy. By Lieut. E. W. Stone. Pp. vii+267+xxxiii plates. (London: Crosby Lockwood and Son.) 16s. 6d. net.

Grasses and Rushes, and How to Identify Them. By J. H. Crabtree. Pp. 64. (London: The Epworth Press.) 1s. 9d. net.

Space, Time, and Gravitation: An Outline of the General Relativity Theory. By Prof. A. S. Eddington. Pp. vii+218. (Cambridge: At the University Press.) 15s. net.

Pasteur: The History of a Mind. By Prof. E. Duclaux. Translated by E. F. Smith and F. Hedges. Pp. xxxii+363. (Philadelphia and London: W. B. Saunders Co.) 21s. net.

The Journal of the Institute of Metals. Edited by G. Shaw Scott. Vol. xxiii. No. 1, 1920. Pp. xii+644+xxx plates. (London: Institute of Metals.) 31s. 6d. net.

A History of English Philosophy. By Prof. W. R. Sorley. Pp. xvi+380. (Cambridge: At the University Press.) 20s. net.

The Mystery of Life as Interpreted by Science. By R. D. Taylor. Pp. 176. (London and Felling-on-Tyne: Walter Scott Publishing Co., Ltd.) 3s. 6d. net.

Applied Eugenics. By P. Popenoe and Prof. R. H. Johnson. (Social Science Text-Books.) Pp. xii+400. (New York: The Macmillan Co.; London: Macmillan and Co., Ltd.) 14s. net.

Air Ministry. Meteorological Office, London. Professional Notes, No. 8. Temperatures and Humidities in the Upper Air: Conditions Favourable for Thunderstorm Development, and Temperatures over Land and Sea. By Capt. C. K. M. Douglas. Pp. 110-139. (London: Meteorological Office, Air Ministry.) 2s. net.

Air Ministry. Meteorological Office. Geophysical Memoirs, No. 16. Aids to Forecasting: Types of Pressure Distribution. With notes and tables for the fourteen years 1905-18. By E. Gold. Pp. 147-74. (London: Meteorological Office, Air Ministry.) 2s. 6d. net.

Notes on Chemical Research: An Account of Certain Conditions which Apply to Original Investigation. By W. P. Dreaper. (Text-Books of Chemical Research and Engineering.) Second edition. Pp. xv+195. (London: J. and A. Churchill.) 7s. 6d. net.

The Concept of Nature. By Prof. A. N. Whitehead. (Tarnet Lectures delivered in Trinity College, November, 1919.) Pp. ix+202. (Cambridge: At the University Press.) 14s. net.

William Smith: His Maps and Memoirs. By T. Sheppard. Pp. iii+75-253+plates. (Hull: A. Brown and Sons, Ltd.)

Imperial Institute. Indian Trade Inquiry. Reports on Oil-Seeds. Pp. ix+149. (London: J. Murray.) 6s. net.

Conifers and their Characteristics. By C. Coltman-Rogers. Pp. xiii+333. (London: J. Murray.) 21s. net.

The Small Farm and its Management. By Prof. J. Long. Second edition. Pp. 328. (London: J. Murray.) 7s. 6d. net.

Anniversaries and other Poems. By L. Huxley. Pp. x+82. (London: J. Murray.) 5s. net.

## Diary of Societies.

MONDAY, JULY 5.

ROYAL INSTITUTION OF GREAT BRITAIN, at 5.—General Meeting.  
ARISTOTELIAN SOCIETY (at 74 Grosvenor Street), at 8.—Rev. Dr. W. F. Geikie Cobb: Mysticism, True and False.

WEDNESDAY, JULY 7.

INSTITUTE OF PETROLEUM TECHNOLOGISTS (in Canada Building, Great Palace), at 6.—E. H. Cunningham Craig: Wild Catting (Free Illustrated Lecture).

SATURDAY, JULY 10.

PHYSIOLOGICAL SOCIETY (at Physiological Laboratory, University, Oxford), at 4.—J. R. Leathes and H. C. Broadhurst: Excretion of Phosphate.—J. Barcroft and F. J. Roughton: Diffusion Co-efficient of Lung.—S. P. L. Sprensen and E. J. Cohn: Solubility of Globulin.—A. Krogh: Reaction of Blood Vessels to Local Stimuli.

## CONTENTS.

PAGE

Medical Research and the Practitioner . . . . .	541
Theory of Dioptric Instruments. By A. E. C. . . . .	542
The International Research Council . . . . .	543
Problems of Population. By E. B. . . . .	543
The Elements of Hardy Fruit Culture . . . . .	545
Our Bookshelf . . . . .	545
Letters to the Editor:—	
The Constitution of the Elements.—Dr. F. W. Aston . . . . .	547
Applied Science and Industrial Research.—Major A. G. Church . . . . .	547
Science and Scholasticism.—Prof. Jas. J. Walsh; Dr. Charles Singer . . . . .	547
Commercial Parasitism in the Cotton Industry.—O. F. Cook . . . . .	548
Fuel Research. By Prof. John W. Cobb . . . . .	550
Use of Sumner Lines in Navigation. (With Diagrams.) By Capt. T. H. Tizard, C.B., F.R.S. . . . .	552
Obituary:—	
Dr. F. A. Tarleton.—R. A. P. Rogers . . . . .	554
Notes . . . . .	556
Our Astronomical Column:—	
Tempel's Second Periodic Comet . . . . .	560
Denning's Comet of 1881 and a Meteoric Shower . . . . .	560
Capture Orbits . . . . .	560
Education in the New Era. By Prof. Frederick Soddy, F.R.S. . . . .	561
British Aeronautics . . . . .	561
Climatic Cycles and Tree-growth. By W. W. B. . . . .	562
The Interferometer in Physical Measurements. By L. C. M. . . . .	563
Canvas-destroying Fungi. By J. Ramsbottom . . . . .	563
The Economic Pursuits of the Trobriand Islanders . . . . .	564
The Organisation of Scientific Work in India . . . . .	565
University and Educational Intelligence . . . . .	568
Societies and Academies . . . . .	569
Books Received . . . . .	571
Diary of Societies . . . . .	572



THURSDAY, JULY 8, 1920.

*Editorial and Publishing Offices:*

MACMILLAN &amp; CO., LTD.,

ST. MARTIN'S STREET, LONDON, W.C.2.

Advertisements and business letters should be  
addressed to the Publishers.

Editorial communications to the Editor.

Telegraphic Address: PHUSIS, LONDON.

Telephone Number: GERRARD 8830.

### Medical Education.

**D**URING the last thirty years the feeling has become increasingly insistent, both in this country and in America, that certain radical reforms were needed in the methods of education in medicine. But our American colleagues have been fortunate in having the opportunity and the means for building new schools of medicine to meet the new circumstances and for making drastic changes in their methods of teaching which a variety of circumstances has hitherto prevented us from attempting in Britain. Now that the Rockefeller Foundation, by its magnificent generosity, has made it possible for us to embark upon the difficult sea of reform, it is particularly interesting and instructive to study the policy adopted in the more advanced schools of America during the twenty-seven years since the Johns Hopkins Medical School gave the study of medicine in America a new aim and a higher ideal. Though we are a quarter of a century behind our American colleagues in making a start, our delay has given us the advantage that we can profit by the experiments made on the other side of the Atlantic.

It is not generally recognised here how thoroughly the leaders of medical education in America explored every possible method of education throughout the world, and how much devotion and thought they have expended on experiments to discover, by truly scientific methods, how best to employ the few years that the medical student can devote to the training for his profession. Those who want to understand something of the spirit and the high ideals that have inspired the American leaders in this great reform movement should read the account of their work and aims in the volume "Medical Research and Education," issued by the Science Press in New York in 1913. Briefly expressed, the matters upon

which chief insistence is placed are as follows: The absolute necessity of (a) an adequate preliminary education and a serious University training in the basal sciences, physics, chemistry, and biology, without which foundation it is impossible for the student really to profit from his training in medical science; and (b) a method of practical teaching in all branches of professional work, whereby the student can, so far as possible, investigate for himself the facts and theories of each subject under the direction of men who are themselves engaged in research work, and not rely mainly upon lectures and demonstrations to give him merely the *results* of other people's work. In other words, the aim of the reform is to train the student in scientific methods rather than to "cram" him with traditional lore.

So impressed were certain American teachers with the evils of the lecture system of instruction that the attempt was made to eliminate lectures altogether. On this side of the Atlantic (and in most American schools also) it is recognised that some lectures are essential to give the student guidance and a right perspective in his work, and that demonstrations are an invaluable means of instruction, provided the student can really see the objects and appreciate the significance of the experiments. No impartial observer will, however, refuse to admit that in most British schools an altogether undue amount of the medical student's and his teacher's time is wasted in the attendance upon lectures and demonstrations of a useless or distracting kind. Several circumstances make it difficult to break with this vicious system. The financial arrangements in most of our schools are based upon payments for certain courses of lectures or demonstrations: the requirements of most institutions and examining boards are for attendance at so many lectures; and the method of awarding the Board of Education grants for some time helped still further to stereotype this system. In the American schools the student pays for his instruction, and the teacher is free to decide how best the required instruction is provided; in other words, the method of administration of the department is so arranged that the perpetuation of obsolete and vicious methods is not made compulsory for a teacher who has his own ideas as to how to educate his students to the best advantage.

The other great reform in American medical educational practice has been to bring the methods of teaching and research in the clinical subjects into line with those of the intermediate subjects.

The teachers of medicine, surgery, gynaecology, etc., used to be men practising their profession who gave up a certain amount of time to teaching medical students. Such men could bring to their teaching the ripe experience gained not only in the hospital wards, but also in contact with private patients; and, in addition to teaching the science and practice of medicine, were supposed to be able to convey to the student something of the subtle art popularly known as the "bedside manner," which is sometimes reputed to be more useful to the practitioner than either knowledge or skill. But it has long been felt that such teachers, in the course of their individual careers, would become more and more strongly tempted to neglect teaching and research as the demands of their practices became more insistent, and that it was only the exceptional man who would be sufficiently interested in investigation and teaching to make the financial and social sacrifice which the cultivation of his scientific interests would inevitably entail.

British medicine, both now and in the past, has been extraordinarily fortunate in such "exceptional" physicians and surgeons, who have deliberately set aside part of their time for scientific research and teaching. But for their zeal, this country could not have acquired or maintained its deservedly high reputation for clinical research. Nevertheless, the fact has to be faced that in some of the hospitals attached to our schools of medicine no real research of any kind is being carried on, and the clinical teaching is of the most perfunctory order. The obvious remedy for this disastrous tendency is to appoint selected men to investigate the problems of medicine and surgery and to direct the education of students, who will devote the whole of their time to this work, as the professors of anatomy, physiology, pathology, and pharmacology do at present. Such a development has, in fact, become inevitable, for now that a real science of medicine is beginning to emerge the investigation of its difficult problems and the direction of the students' training demand the whole time and energy of specially selected men with the necessary technical training and self-denying devotion to science to cope with such tasks.

This system has been tried in America with most encouraging results. Acting on the advice of Sir George Newman, the Board of Education last autumn agreed to provide financial help to enable certain medical schools to introduce the system of full-time teachers of medicine and surgery in England. Of the institutions that availed themselves of this offer, the University College Hospital

Medical School was the only one which adopted a really whole-time system; and it was this consideration that focussed the interest of the Rockefeller Foundation upon the Gower Street School, for in America the Rockefeller Foundation has played a large part in encouraging the adoption of the whole-time professorships of medicine and surgery. Another factor that played some part in determining its selection was the fact that University College had made provision in its Institutes of Physiology and Pharmacology for the adequate training of students in those subjects, so as to equip them to make the best use of the new facilities for clinical study in the medical school; and further that Prof. Starling had agreed to hand over to the department of anatomy the sub-department of histology, which is vitally important for the full development of teaching and research in anatomy.

The great development in the science of anatomy during the last thirty years has been due mainly to the use of the microscope for the investigation of the structure of the body and for the study of embryology. British anatomy has been hampered by the lack of the facilities for teaching these vital parts of the subject, and has suffered enormously from the lack of stimulating daily contact with them. In other countries, and especially in America, the cultivation of histology and embryology has not only made anatomy one of the most active branches of medical study and research, but also brought the work of the department into close touch with physiology, biochemistry, and pathology, to the mutual benefit of all these subjects, and especially to the student who has to integrate the information acquired in the different departments. It was the radical reforms effected in the teaching of anatomy by the late Prof. Franklin Mall at the Johns Hopkins Medical School in 1893 that played the chief part in starting the great revolution in medical education in America. The stimulating influence of the abolition of the methods of medieval scholasticism in anatomy and the return to the study of Nature and to the use of experiment brought about a closer co-operation with other departments and a general quickening of the students' interest in the real science of medicine.

The effects of these developments spread to other American schools, and the Rockefeller Foundation came to their help and contributed part of the cost of the vital reforms. In 1914 it helped the Washington University at St. Louis to build a new medical school and hospital, with full-time

professors of the clinical subjects, for the endowment of which it gave 250,000*l.*, a quarter of the cost. In 1917 it gave the Chicago University 500,000*l.*, and in ninety days the University collected a further 900,000*l.* to complete the endowment of full-time clinical chairs. In 1918 Yale University raised 650,000*l.* for the same purpose, of which the Rockefeller Foundation contributed one-quarter. In 1919 the Johns Hopkins Hospital established a full-time teaching staff in obstetrics and gynaecology, with an endowment of 250,000*l.*, of which the Rockefeller Foundation gave 100,000*l.* It is rumoured that the same Foundation, which has also given such vast endowments for medical education in Canada and China, is about to excel all its former efforts by a new scheme for further helping medical education in the United States. With such examples of the scale on which these things have to be done, surely England can do more for medical education than she is doing!

The task of the reformer of medical education is vastly more difficult in this country than in America, because on every side there is the hampering influence of cast-iron conventions; but now that the Rockefeller Foundation has helped us to begin the urgent reform there can be no doubt as to the ultimate result.

### The Theory and Facts of Colour Vision.

(1) *The Physiology of Vision, with Special Reference to Colour Blindness.* By Dr. F. W. Edridge-Green. Pp. xii+280. (London: G. Bell and Sons, Ltd., 1920.) Price 12*s.* net.

(2) *Card Test for Colour Blindness.* By Dr. F. W. Edridge-Green. 24 cards. (London: G. Bell and Sons, Ltd., n.d.) Price 25*s.* net.

(1) **T**HE great importance of the subject-matter of the volume under notice and of the card-test which supplements it is beyond all question. Interest in it is enhanced by the fact that the subject is admittedly full of difficulties. In every discussion of human sensations and of the organs which serve as the receivers of stimuli, one is impressed by the uncertainty of much which has been put forward as assured truth. It is not long ago that the mechanism of audition was being discussed anew, and even now, in spite of the renewed examination, the functions of various parts of the ear are much in debate. Yet in audition we have to deal with purely mechanical stimuli which we might have expected to have yielded up

the secrets of their operation long ago. In the case of light the problem is clearly of a more recondite order, and it is not so surprising that little is actually known with certainty about the functions of various parts of the eye, and that we have therefore to fall back upon surmise.

The theory of vision most espoused by physicists is the three-colour theory of Young and Helmholtz, based upon the facts of colour mixture. It is possible to reproduce any tint whatever by mixing together three selected tints in a suitable proportion. This is accepted now by every school, and it must be taken as the basis of any theory of colour vision. The Young-Helmholtz theory explains the fact by *assuming* that there are three units in the sensitive apparatus of the eye (either three sorts of nerves or rods or cones), each of which responds in a maximum degree to one of the three primary tints, but also to a less degree to all (or most) other tints. Red, green, and blue of selected wave-lengths are taken (for reasons which cannot be given here) as the primary tints. A spectral yellow stimulates both red and green sensations, so does a mixture of red and green lights; hence a certain such mixture will produce the same sensation as does a spectral yellow. In this way the phenomena of colour mixture are explained.

Unfortunately, there are difficulties in accepting this theory. In the first place, there is no historical evidence of the existence of these three units. This objection, taken alone, is not fatal. It is conceivable that anatomical differences exist which are beyond detection with the microscope. But, in addition, there is a vast number of phenomena to be explained besides those of colour mixture, and many of these seem to be directly in opposition to the theory. Dr. Edridge-Green is well known as one who, after prolonged study of the question, was compelled to give up the trichromatic theory. The volume under review summarises the conclusions to which he has come. We can cite only a few of the experimental facts.

In certain cases of defective colour perception the yellow sensation is diminished, and in others lost altogether, although the percipient experiences three definite colour sensations (red, green, and violet). Why do not the red and green make yellow in such cases? If the eye be fatigued with pure spectral yellow light, and be then turned aside to view a spectrum, this will appear to have lost its yellow; and though yellowish-red or yellowish-green will appear less yellow, the terminal red of the spectrum will not be affected. According to the trichromatic theory,

it should be reduced in intensity. Again, the eye may be fatigued with red or green without altering the hue of spectral yellow.

If the image of a white object be suddenly formed on a portion of the retina which was previously occupied by the image of a black object, this image is surrounded by a red border. If, instead of white, a spectral greenish-yellow illumination is used, the border is colourless; if the same greenish-yellow be made up of red and green, it appears red (Bidwell).

Many dichromics have a luminosity curve similar to the normal, although their colour sensations are limited to red and blue at the ends of the spectrum, with a neutral colour in between. This would not be the case if their blindness were due to the absence of one of the sensory units (green).

The theory which Dr. Edridge-Green has developed may be outlined as follows:—

A ray of light impinging on the retina liberates the visual purple from the rods, and a "photograph" is formed.

The ends of the cones are stimulated through the photochemical decomposition of the visual purple by light, and a visual impulse is set up which is conveyed by the optic nerve to the brain.

Instead of analysing this impulse into three components, Dr. Edridge-Green regards it as an integral unit the shape of which depends upon the nature of the light exciting it.

The physicist may be reminded that he himself has already recognised that if the motions in the æther corresponding to white light could be seen, he would not be tempted to speak of them as periodic, though they are capable of being resolved by Fourier's theorem into monochromatic components. The gist of Dr. Edridge-Green's theory is that he deals with the visual impulse as a unit, but asserts (in effect) that if for convenience it is resolved into components, the number of necessary components is usually large. We do not mean that he says this in so many words; but this is, in physical language, what his statements appear to us to imply. His theory is therefore of greater generality than the restricted Young-Helmholtz theory which it supplants.

(2) The card test, which is supplementary to the text-book, consists of twenty-four cards, each containing a large number of irregular, coloured patches or spots. The shapes of these are precisely the same on all the cards, so that the examinee cannot be coached to discriminate by the form alone. These patches are differently coloured on all the cards. Each card contains a number of patches of a selected hue, different from the other patches, arranged in the form of

a letter. The examinee is required to declare the letter on each card in turn. The colours are so chosen as to enable the examiner to discriminate between the different kinds of colour blindness.

We have tested them on numerous individuals. Card 8 is particularly useful in the quick detection of weakness in the green. It contains a green C and a brown S. To a normal individual the C is very prominent, while the S is a difficult letter to detect. One examinee who was quite unconscious that he was in any way defective detected the S instantly, while he could not detect the C even when his attention was directed to it.

We have not space to discuss either the book or the card test fully. We congratulate Dr. Edridge-Green on having brought together a wealth of important and interesting material on the physiology of vision.

### Hydrographical Surveying.

*Hydrographical Surveying: A Description of Means and Methods Employed in Constructing Marine Charts.* By the late Rear-Admiral Sir William J. L. Wharton. Fourth edition, revised and enlarged by Admiral Sir Mostyn Field. Pp. xii+570. (London: John Murray, 1920.) Price 30s. net.

THE fourth edition of this work on hydrographical surveying differs but slightly from its predecessor, the main text being practically untouched, and the only important changes being the addition of several articles on newer surveying methods and experimental devices which had been introduced in the years immediately preceding the war.

Of these the description of a form of "vacuum tide-gauge," devised by Rear-Admiral H. E. Purey-Cust, a former Hydrographer of the Navy, is perhaps the most interesting, and it will certainly appeal to every nautical surveyor who has had to fight against the difficulties of observing the vertical movements of the tide in situations where direct readings are almost impossible. The addition of a trustworthy self-recorder to the instrument is obviously merely a question of time and experiment, and when it has been perfected this form of tide-gauge will undoubtedly prove an immense boon to nautical surveyors for use in those parts of the world where the ordinary methods of tide reading are impracticable.

It is to be regretted that no mention has been made of the extremely useful and convenient form of current meter known as the "Ekman." This instrument has been used with conspicuous success

by the Admiralty and by the Ministry of Agriculture and Fisheries, and is the standard form of current meter now used by both Departments.

In the new chap. xx. the "Douglas-Schäfer" sounding traveller is described on pp. 434-36, but as this is the official method of obtaining soundings in H.M. surveying vessels, it would have been more suitably placed at the commencement of this chapter than among the miscellaneous collection of methods which are largely experimental.

Several new methods connected with sweeping are now described in the new material of the book, and all have something to be said in their favour; but it is much to be hoped that the results of mine-sweeping, which developed into such a gigantic and well-organised piece of war machinery, will eventually assist in the devising of some form of thoroughly effective sweep for surveying purposes.

This last remark applies similarly to the improvement of surveying devices and methods generally. During the war such enormous progress was made in so many directions affecting scientific developments that many surveying methods must of necessity be entirely, or at least very drastically, altered to bring them up to date. The remarks under the heading "Recent Developments" on p. 470, which deal with this aspect, are, however, distinctly on the conservative side, as it is considered that the scrapping of old systems must be adopted in a very wholesale manner rather than that attempts should be made at their modification to conform to the most modern methods. It is perhaps somewhat difficult to appreciate what an enormous saving of time, and, therefore, of expense and labour, will eventually result from the introduction of many of these methods into hydrographical surveying, but a good example will be found in connection with the use of hydrophones, by the aid of which accurate positions afloat can be obtained in as many hours instead of days or even weeks, which would have formerly been required under the procedure described under the heading "Triangulation by means of Floating Moored Beacons" in the new chap. xxi.

The war, in fact, has shown the necessity in this, as in so many other directions, of revising the text-books which deal with technical subjects, and this is the condition of affairs as regards hydrographical surveying. The work under notice is undoubtedly the standard publication on the subject, and has a well-deserved and world-wide reputation; but it is considered that all such standard works on technical matters, such as that now under discussion, should be prepared and

published by the Government Department which is directly concerned, and, therefore, in a position to obtain the fullest information in every possible direction; and lastly, but not least in importance, which is also in a position to keep such an official work always up to date by the periodical publication of supplements.

### Forestry, Tree Diseases, and Timber,

- (1) *Our National Forests: A Short Popular Account of the Work of the United States Forest Service on the National Forests.* By Dr. Richard H. Douai Boerker. Pp. lxi + 238. (New York: The Macmillan Co.; London: Macmillan and Co., Ltd., 1918.) Price 12s. 6d. net.
- (2) *Commercial Forestry in Britain: Its Decline and Revival.* By E. P. Stebbing. Pp. vi + 186. (London: John Murray, 1919.) Price 6s. net.
- (3) *National Afforestation.* By A. D. Webster. Pp. 160. (London: T. Fisher Unwin, Ltd., 1919.) Price 6s. net.
- (4) *Manual of Tree Diseases.* By Dr. W. Howard Rankin. (The Rural Manuals.) Pp. xx + 398. (New York: The Macmillan Co.; London: Macmillan and Co., Ltd., 1918.) Price 12s. 6d. net.
- (5)-(8) *A Map of the World (on Mercator's Projection), Having Special Reference to Forest Regions and the Geographical Distribution of Timber Trees: Timber Map, No. 1. North America: Timber Map, No. 2. South America: Timber Map, No. 3. Europe and Africa: Timber Map, No. 4.* All prepared by J. Hudson Davies. Each on rollers, size 40 in. by 30 in. (Edinburgh: W. and A. K. Johnston, Ltd.; London: Macmillan and Co., Ltd., n.d.) Price 8s. net each.

DR. BOERKER'S book is a popular account of the administration and protection of the national forests of the United States, which now constitute about a third of the timber lands in that country. The original forest area was enormous, being estimated at 850,000,000 acres. Nearly half of this has been cleared away, as the land was needed for farms by settlers; but forest fires, felling for timber, and grazing have shared largely in the destruction. To-day the land under timber trees is about 500,000,000 acres. Private ownership entailed disappearance of the forests, as no steps were ever taken to provide for the growth of a second crop of trees upon the ground. State intervention became necessary, and nothing in the political history of the United States is more creditable than the legislation of late years enforcing measures to preserve from fire and to manage

on scientific principles as much of the primeval woodlands as could be rescued from private ownership. Dr. Boerker sketches the history of this great movement.

The first effective step in conservation was the passing of an Act in 1891, which empowered the President to create forest reserves by proclamation. The first to be proclaimed was the Yellowstone Park, and others were added until they amounted to 100,000,000 acres in 1905. In that year the Forest Service was constituted as it now exists, with enlarged powers and increased appropriations from public funds. In 1907 the "forest reserves" were re-named "national forests," to do away with the impression that the timber was not to be used until some future time.

Dr. Boerker gives a list of the national forests, arranged by States, and showing the acreage of each and the headquarters of the Forest Supervisor. The national forests are nearly all in the west, comprising the higher parts of the Rocky Mountains, the Cascades, the Pacific Coast ranges, a part of the coast of Alaska, some of the hills in the Dakotas, eastern Montana, Oklahoma and Arkansas, and small areas in Minnesota, Michigan, and Florida. In March, 1915, there were 162 national forests in all, with a total area of 163,000,000 acres.

Besides the national forests, set aside out of the public lands of the west, there are mountain forests in the east, in the White Mountains and southern Appalachians, which have been gradually acquired by purchase under the Weeks law of 1911. These totalled nearly 2,000,000 acres in 1919. Under the same law the Federal Government co-operates with the States in the protection of forested watersheds, and much has been done to stop the ravages caused by fire.

In 1910 the Forests Products Laboratory was established at Madison (Wisconsin), and this great research institute has since then made signal advances in almost every phase of wood utilisation, to the great gain of the nation in times of peace and during the war. Researches have been made in wood distillation, the testing and seasoning of timber, the pulp and paper industries, tapping pines for turpentine, using wood waste, the production of artificial silk from sawdust, etc. Investigations in the industrial uses of woods have also been carried out. The attention paid to scientific research has been a significant feature of the U.S. Forest Service, as is well shown by the abundant literature on forestry subjects which has been published at Washington during the past ten years.

Dr. Boerker's book is well illustrated, and

contains interesting notes on the field work in the national forests, including harvesting seed, modes of planting, diseases and insect attacks, fire protection, the building of roads, trails, and telephone lines, and the supervision of felling operations and grazing. The richness of details makes the book valuable to foresters as well as to general readers.

(2) The two small books by Mr. E. P. Stebbing and Mr. A. D. Webster narrate in a popular manner the achievements and hopes of British forestry, and are in strong contrast to the American treatise just noticed. Both authors fail notably in their historical chapters. Mr. Stebbing tries to compress into a few pages the history of the woodlands and forest policy of Great Britain from the earliest times until 1885. He bases this abstract on Nisbet's disquisition on the subject in his manual "The Forester." The fact is that the history of forestry in Britain cannot be written until it is taken up seriously, and the public records and other documents are studied and made use of.

Mr. Stebbing devotes a chapter to the various Committees and Royal Commissions appointed in the period 1885-1914 to inquire into and deal with forestry in this country. His favourable opinion of the activities of the Development Commissioners will meet with some criticism. This body did useful work from 1909 to 1914 in encouraging forestry education, but made no progress in Great Britain in the "purchase and planting of land found after inquiry suitable for afforestation," one of the main objects for which the Commissioners were appointed. The next chapter treats of the difficulties in timber supplies during the war period. In the remaining chapters Mr. Stebbing is concerned with the future of British forestry, and discusses various matters, such as the requirements of timber by Britain, what afforestation will do for the people, the connection of forestry and agriculture, the acquisition of land for planting by the State, the protection of afforested areas, etc. He is not content with the recommendations of the Reconstruction Committee for the planting of 1,770,000 acres during the next eighty years. However, we must be satisfied, in the present state of public finance, with the immense progress that has been made in the appointment last year of the Forestry Commission with a definite income and an assured programme for the next ten years. At the end of this period the problem can be reconsidered in the light of the experience gained in the meantime.

(3) Mr. Webster's small book begins with a short chapter on the history of British woodlands, which contains too little information to be of any

value. His remaining chapters deal briefly with schemes of afforestation, financial returns, trees for planting, the use of the unemployed in forestry work, the transport of timber, etc. There is nothing novel, and a good deal that is debatable, in his treatment of these subjects.

(4) Dr. Rankin's "Manual of Tree Diseases" is the first American text-book on the subject. Injuries caused by insects or other animals are not included. The first four chapters treat of general diseases, such as many species are liable to, and those affecting seedlings, leaves, stem and branches, and roots are successively dealt with. The main part of the book describes the diseases which attack various groups of trees, beginning with alders and ending with willows. Chapters on tree surgery and on spraying conclude the volume, which is fairly well illustrated. Exact and copious references to the literature of the subject are a useful feature. This manual will be of considerable use in Great Britain, although the diseases occurring here and in America are often different. The account (p. 90) of *Keithia thujina*, a dangerous fungus which has recently appeared in England and Ireland on the valuable forest tree, *Thuja gigantea*, is of considerable interest. In America it is essentially a disease of seedlings, often killing large numbers of those less than four years old. Preliminary experiments indicate that soap-Bordeaux mixture applied every ten days in autumn will greatly reduce the infection.

(5)-(8) These four maps are attractive in appearance, and will prove useful to merchants and teachers, as they show approximately the districts which yield the more important commercial timbers. Their scientific value is impaired by the fact that in a considerable number of species the areas of distribution are incorrect, and the names erroneous or confusing. For example, the small map of Old World larch is incorrect. European larch does not occur, as depicted, in the Pyrenees, Apennines, Serbia, Bulgaria, etc. The Siberian larch is wrongly styled *Larix dahurica*, whereas it is *L. sibirica* which occupies northern Russia and Siberia west of Lake Baikal. *L. leptolepis*, which is restricted to Hondo, in Japan, is represented as existing on Hokkaido, where there is no larch, and in Manchuria and Korea, where the finest *L. dahurica* grows. The small maps might readily convey more information. On the one showing Sequoia and Taxodium it would be easy to add the distribution of important timber trees like Lawson cypress, *Thuja gigantea*, and Western larch.

The author has not tried to explain by notes

in the margin the peculiarities of popular nomenclature, such as the use of the term "boxwood" for the Venezuelan *Casearia praecox* (see *Kew Bulletin*, 1914, p. 214); and the application of the word "cedar" to trees so different as Cedrus, Cedrela, and Juniperus. One must acknowledge that the construction of correct maps of distribution is very difficult, as accurate information on some of the tropical woods is difficult to obtain.

### Our Bookshelf.

*The Natural Wealth of Britain: Its Origin and Exploitation.* By S. J. Duly. (The New Teaching Series.) Pp. x+319. (London: Hodder and Stoughton, 1919.) Price 6s. net.

THE general scheme of this little book is decidedly good; it is intended to teach young people how the industries and commerce of Great Britain are conditioned by the geology of our island, both because the geological structure determines the sources from which we derive the materials upon which our national existence depends, and because it has produced the surface contours and configuration that have decided the lines along which our streams of commerce flow to-day. The first portion of the book gives an outline of the main principles of structural geology; then follows a section on the fundamental industries based on geological structure; and the third part deals with the geographical and geological relations of some of our most important industrial districts.

In view of the evident educational value of the plan of the book, it is all the more to be regretted that its execution is so defective. The first requisite in a text-book for young people is accuracy, and in this respect the author fails lamentably. A few random examples will illustrate the slipshod nature of the work. Thus the author, in describing granite, states that it consists of three constituents—quartz, felspar, and "the third constituent of granite comprises all the various metallic compounds." Again, a few pages further on, he tells his readers that "sapphire, ruby, aquamarine, and topaz are crystalline forms of clay."

The chapters devoted to mining are by far the worst, and it is not too much to say that there is scarcely a page that is not disfigured by some inaccuracy of more or less importance. It is impossible to imagine anyone with any real knowledge of mining writing that "the foot-wall beneath the coal seam is cut away . . . by pick-axe" (the italics are the reviewer's), or that pillars of coal "are sometimes left to support the roof." Were it not for the numerous inaccuracies of the kind indicated, this would be a most useful text-book for the general reader, but, as it is, it is greatly to be feared that he is as likely to pick up totally false impressions as to obtain useful information from its pages.

H. L.

*Animal Heroes: Being the Histories of a Cat, a Dog, a Pigeon, a Lynx, two Wolves, and a Reindeer.* By Ernest Thompson Seton. Fourth impression. Pp. 363. (London: Constable and Co., Ltd., 1920.) Price 8s. 6d. net.

THIS lively and generously illustrated book begins with the story of four of the lives of a "Royal Analostan" cat—we were a little afraid that there were to be nine—which, in virtue of considerable worldly wisdom, got on well against heavy odds. "But in spite of her prosperity, her social position, her royal name and fake pedigree, the greatest pleasure in her life is to slip out and go a-slumming in the gloaming, for now, as in her previous lives, she is at heart, and likely to be, nothing but a dirty little Slum Cat." The second story tells of the ability of a homing pigeon and of its successful education. "The hardest of all work is over the sea, for there is no chance of aid from landmarks; and the hardest of all times at sea is in fog, for then even the sun is blotted out and there is nothing whatever for guidance. With memory, sight, and hearing unavailable, the Homer has one thing left, and herein is his great strength, the inborn sense of direction. There is only one thing that can destroy this, and that is fear, hence the necessity of a stout little heart between these noble wings." This is a fair sample of the more reflective passages in the book, and it is too easy-going. There is a stronger note in the two descriptive studies of wolves, for Mr. Thompson Seton excels in proportion to the wildness of the scenery and of the *dramatis personae*. The other subjects are "The Boy and the Lynx," "The History of a Jack-Rabbit," "The Story of a Bull-Terrier," and "The White Reindeer." The author is an artist in reading the man into the beast—a great art, but a dangerous one; and we are afraid that some of the book is in the danger zone. But those who recoil from "apsychic" biology will probably agree that Mr. Thompson Seton's anthropomorphic faults lean to virtue's side.

*The Year-book of the Scientific and Learned Societies of Great Britain and Ireland. Thirty-sixth Annual Issue.* Pp. viii+336. (London: C. Griffin and Co., Ltd., 1919.) Price 12s. 6d. net.

AS is well known, this invaluable year-book gives official particulars and records of work not only of scientific societies in the British Isles, but also of such institutions as the Imperial Institute, Meteorological Office, National Physical Laboratory, Rothamsted Experimental Station, etc. Titles are given of papers read during the session 1918-19, and twenty-six new societies have been added to the comprehensive list of those surveyed in this volume. The work is one which we continually consult, and it is an essential volume for the reference library of every newspaper, institution, college, or club which desires to provide its staff or members with accurate particulars of the officers and activities of scientific organisations throughout the kingdom.

## Letters to the Editor.

[The Editor does not hold himself responsible for opinions expressed by his correspondents. Neither can he undertake to return, or to correspond with the writers of, rejected manuscripts intended for this or any other part of NATURE. No notice is taken of anonymous communications.]

### Weather Forecasts and Meteorology.

THE experience gained during the last few years in aerial navigation has shown, among other things, that weather forecasts, in these latitudes at any rate, are trustworthy only for a few hours in advance, and not always that.

If all weather forecasting were at all accurate for a day or two ahead, it would be possible to make a correct weather-chart for to-morrow from the information received to-day. This has never yet been done, and it seems unlikely that it ever can be done, for the simple reason that in latitudes higher than 30° or thereabouts the conditions of the flow of the air are those of the permanent instability which characterises a stream exposed to the influence of surface friction at a velocity greater than that compatible with lamellar flow.

The unstable motion referred to consists of eddy motion superposed on a general drift, the eddies themselves being of all sizes and in all stages of growth and decay—some showing actual rotation, others being merely distinguishable by differences of velocity and direction. Eddies, when formed, have a certain individual life, generally of not many hours' duration, though in some cases there may be maintaining causes which will prolong their existence for days. The deviations of their courses (*i.e.* the path of their centres) from the average direction of the stream depend chiefly on the state and intensity of the other eddies in the neighbourhood, and, within wide limits, must be treated as a matter of pure chance.

Let anyone watch the motes of dust in the air illuminated by a beam of sunlight passing through a slit. They may all, on the whole, be drifting in some one direction, but combined with the general drift there will be irregular eddying motions, some quick, some slow, but deviating largely from the average for the whole. Much the same sort of thing on a large scale takes place in the atmosphere, and a weather forecast professes to determine from the motion over a certain area and at a certain time, together with the then existing variations, what the future motions will be.

For a time so short that the eddying motions preserve their respective characters this can be done, but not for longer periods, the causes which alter existing eddies and develop new ones being incalculable.

If the weather prophet makes no observations whatever, but is content to say that "to-morrow will be like to-day," he will be right rather more than sixty times out of a hundred. With all the information which can be obtained, by telegraph or otherwise, he may add 10 or 15 per cent. to his correct predictions for twenty-four hours ahead.

The Meteorological Office, I believe, claims rather a better average than this, but its forecasts are often so vague (*e.g.* "Wind moderate, strong to a gale at times in places. Fair, but with some cloud and rain. Temperature moderate") that almost any sort of weather might be said to fulfil the prediction.

The proper test of the value of forecasts for a day in advance would be to prepare a chart for that day and to publish it side by side with one formed from



the actual data when they come to hand. A comparison of the two would soon show that weather prediction for more than a few hours ahead was impossible in present conditions.

While, however, long forecasts are, for the most part, mere untrustworthy guesswork, there are many meteorological subjects now neglected which might be investigated with success, but concerning which at present practically nothing is known. Such are the origin of the variation of electric potential in the air, the origin of thunderstorms and lightning, the coalescence or non-coalescence of cloud particles, the origin of hail and the causes which determine the shape and size of snow crystals or the volume of raindrops, the forms of clouds, and many others. Also there are more general questions still to be answered concerning trade winds and the circulation in equatorial regions. All investigations on these subjects should include the proper scales of comparison and attempts to produce corresponding phenomena on a small scale. A. MALLOCK.

New University Club, June 28.

**The Rate of Ascent of Pilot-Balloons.**

IN NATURE for June 17 Dr. van Bemmelen directs attention to the excess rate of rising which pilot-balloons often show in the first few minutes of their ascent, and refers to two explanations of this phenomenon which have been put forward. These are that the rapid rising may be due (1) to turbulence in the lower layers of air or (2) to the tendency of balloons to be drawn into rising columns of air and thus to partake of their upward motion. The curves reproduced by Dr. van Bemmelen, which indicate the relation between rising velocity and height under different conditions, are of great interest, and show that the effect is not found when working on a small island in the Java Sea.

As double-theodolite observations over a sea exposure are not numerous, it may be of interest to refer to

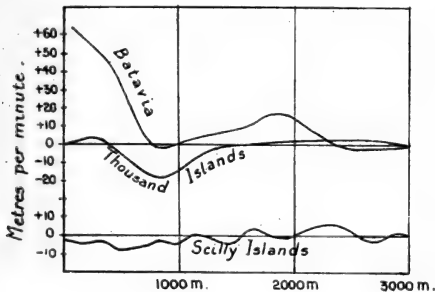

FIG. 1.

the results obtained by Capt. C. J. P. Cave and the present writer in some ascents made from the Scilly Islands during two winter months, November and December, some years ago. Particulars have recently been published by the Meteorological Office in Geophysical Memoir No. 14. The mean rate of ascent of the balloons used was found to be 160 metres per minute. Mean departures from this value for each minute of the ascent measured from the start are shown in Fig. 1. Dr. van Bemmelen's diagrams for the Thousand Islands and Batavia

(0-3 p.m.) are also reproduced for comparison. It will be seen at once that the rate of ascent at Scilly, like that at the Thousand Islands, shows no excess above the normal in the first kilometre of height; if anything, the effect is slightly the other way.

Ascents in the Scilly Islands are of particular interest in this connection. The area of the islands is so small that no convection effects due to solar heating would be expected, at any rate in the winter. On the other hand, the group contains a great number of small islands of a rocky and hilly nature, and these are spread over an area of some ten miles by five. They might naturally be expected to produce some turbulence in the air passing over them, and such turbulence is, in fact, shown by the records of the pressure-tube anemometer on St. Mary's, the largest of the islands. If the excess rate of rising so frequently noticed in the first kilometre over land is due to turbulence, as suggested by Wenger, we should expect to find it in the Scilly ascents; if it is due to convection currents caused by solar heating, we should not expect to find it. The evidence afforded by this example seems clear. J. S. DIXES.

66 Sydney Street, S.W.3, June 22.

**Diamagnetism and the Structure of the Hydrogen Molecule.**

IN a letter to NATURE of June 24 (p. 516) Dr. J. R. Ashworth has pointed out a possible origin of the diamagnetism of hydrogen by assuming oscillations or rotations of Bohr's paramagnetic hydrogen atom or molecule. Granted that such motions tend towards a diamagnetic effect, it is important to examine the plausibility of such a view in the light of recent experimental data. We know that:

(1) The specific susceptibility ( $\chi_n$ ) of gaseous hydrogen at 16° C. is  $-19.8(2) \times 10^{-7} \pm 0.15 \times 10^{-7}$ , with a mean error of 0.76 per cent. (Také Soné, Science Reports, Tôhoku, vol. viii., p. 115, 1919). No variation of this, within the limits of experiment, could be detected over a pressure range of 1 to 68 atmospheres.

(2) The value of  $\chi_n$  for liquid hydrogen at a temperature less than  $-253^\circ$  C. is  $-27 \times 10^{-7}$  (Onnes and Perrier, Proc. Amsterdam Acad., vol. xiv., p. 121, 1911).

(3) The value of  $\chi_n$  for atomic hydrogen in various types of chemical combination, as deduced from the additive law of atomic diamagnetism for the hydrocarbons, is  $-30.5 \times 10^{-7}$  (Pascal, Ann. de Chim. et de Phys., vol. xix., p. 5, 1910).

(4) There is no definite evidence that the diamagnetic susceptibility varies simply with temperature over a range  $-180^\circ$  C. to  $20^\circ$  C. Such small variations as do occur never change the sign of  $\chi$  (except in the case of tin), and are attributable to changes of molecular grouping, e.g. crystallisation or aggregation (Ishiwara, Science Reports, Tôhoku, vol. iii., p. 303, 1914; A. E. Oxley, Phil. Trans. Roy. Soc., vol. ccxiv., A, p. 109, 1914).

(5) The theory of molecular rotation developed by Honda and Okubo (Science Reports, Tôhoku, vol. vii., p. 141, 1918), which is similar to that proposed by Dr. Ashworth, accounts for the diamagnetism of hydrogen and helium only if we suppose molecular rotations of angular velocity  $6.54 \times 10^{14} \text{ sec}^{-1}$  and  $3.80 \times 10^{15} \text{ sec}^{-1}$  respectively. In the case of the paramagnetic oxygen molecule it is necessary to suppose that there is no rotation whatsoever in order to obtain

the hyperbolic susceptibility-temperature relationship for gaseous oxygen (Také Soné, *loc. cit.*).

(6) If the diamagnetism of hydrogen is attributed to thermal oscillations or rotations, we might expect that  $\chi_H$  for the gas at 16° C. would be greater than  $\chi_H$  for liquid hydrogen at -253° C. Precisely the reverse holds, according to the above data, and there is certainly no indication that at low temperature  $\chi_H$  is tending to change sign.

A variation of  $\chi_H$  from  $-19.8 \times 10^{-7}$  to  $-27 \times 10^{-7}$  for a temperature interval of 16° C. to  $-253^\circ$  C., together with the fact that  $\chi_H$  in different types of organic compounds is constant and equal to  $-30.5 \times 10^{-7}$ , points to the conclusion that thermal oscillations and rotations have little to do with the origin of diamagnetism in molecular hydrogen, and that the Bohr hydrogen molecule will not account for it.

The present writer's view is that the free hydrogen atom is probably paramagnetic, but the structure of the hydrogen molecule must be such that by compensation it is, as a whole, diamagnetic. A model of the hydrogen molecule which satisfies these conditions was suggested in NATURE of May 13, 1920. In this model the individuality of the hydrogen atom is preserved, and this may have some bearing on the origin of the primary and secondary hydrogen spectra.

A. E. OXLEY.

The British Cotton Industry Research Association, 108 Deansgate, Manchester, June 28.

#### University Stipends and Pensions.

ALL university teachers will thank you for the leading article in NATURE of June 17 pointing out the injustice done to them and to university education by the exclusion of such teachers from the provisions of the School Teachers (Superannuation) Act, 1918. On one point, however, the article is misleading. It is stated that "what complicates matters is the fact that there exists a contributory pension scheme in the universities—the federated superannuation scheme—which is thought by some to be superior to the Teachers Act in certain respects." It should be made quite clear, however, that the governing bodies of university colleges are at liberty to adopt the federated scheme or not, and that the governing bodies of some colleges have refused to adopt it, with the result that the staffs of these colleges have no prospect of any pensions whatever. The position in the University of London is, therefore, even more anomalous than was suggested, since some schools come within the provisions of the Act, some have contributory pension schemes, and some have none. The Northampton Polytechnic Institute and the Imperial College of Science and Technology have each an engineering department the courses in which enable their students to take the B.Sc. degree of London University as internal students of the University. The lecturers of each sit side by side on the Faculty of Engineering and on the various Boards of Studies of the University. The first-named institution is included in the Teachers Act, but the last-named is excluded. Lecturers at the former retire at the age of sixty with a non-contributory Government pension, whilst their *confrères* at the Imperial College may work as long as they are able with no prospect of any pension whatever.

G. W. O. H.

THERE is nothing in "G. W. O. H.'s" letter to support his statement that the article is misleading.

It is true that no university or university college is compelled to join the federated scheme, but it is equally true that such a scheme exists, and that most universities and university colleges have adopted it. The additional particulars which "G. W. O. H." gives were known to us, but obviously in a short article every variety of illustration could not be included.—ED. NATURE.

#### The Separation of the Isotopes of Chlorine.

IN agreement with Prof. Soddy, I find myself unable to understand how it is possible to separate isotopes by the method suggested by Mr. D. L. Chapman in NATURE of June 17. Nevertheless, a certain paradox has been brought to light in connection with Nernst's theorem the solution of which is not without interest.

The paradox of which I refer is this: Consider the equilibrium in the gaseous reaction  $Cl_1 + Cl'_1 = 2ClCl'$ . If the gases behave as perfect gases, and if  $Cl$  and  $Cl'$  are identical or differ only very slightly, then it is easy to show by probability considerations that the equilibrium must be given by

$$\frac{[ClCl']^2}{[Cl_1][Cl'_1]} = K = 4.$$

From this it follows that to convert a gram-molecule of  $Cl_2$  plus a gram-molecule of  $Cl'_2$  into two gram-molecules of  $ClCl'$  at the same temperature and pressure,  $\alpha'$  will require an amount of available energy equal to  $-RT \log 4$ .

Now if the chemical and physical properties of the isotopes are truly identical, then from this and the necessary equality of the vapour pressures it is readily shown that to convert a gram-molecule of solid  $Cl_1$  plus a gram-molecule of solid  $Cl'_1$  into two gram-molecules of solid  $ClCl'$  also requires  $-RT \log 4$  of available energy. Therefore the difference in the entropies of the two sets of solids is  $R \log 4$ , which, being independent of the temperature, must exist at the absolute zero.

It is, however, unjustifiable to say that this contradicts Nernst's theorem, and to deduce from this theorem that  $K$  for the gaseous reaction must be 1 in order to make the change in the entropy zero. For if there is a true identity, then this implies that there are no forces to guide the atoms into any particular configuration, so that even down to the zero of temperature no true reaction is possible, and what occurs is really of the nature of mixing. That a difference of entropy occurs on mixing, even at the zero, is necessary, and in no way contradicts Nernst's theorem; in fact, the case of mixtures is explicitly excluded by Nernst.

If, on the other hand, there is a real, but small, difference in the two isotopes, then, as before,  $K$  will vary nearly equal 4. Now, in order to obtain the difference in the entropies between the solids near the zero of temperature, let us carry out the cycle described by Mr. Chapman, but in the neighbourhood of the zero. Then, in spite of the fact that the isotopes differ very little, it is impossible to say that the vapour pressures remain equal. Thus it is impossible, so long as there is any difference at all between the isotopes, to argue that because  $K=4$  for the gaseous reaction there must be a finite change in entropy at the absolute zero.

ANGUS F. CORE.

The University, Manchester, July 4.

The Island of Stone Statues.<sup>1</sup>

By SIR EVERARD IM THURN, K.C.M.G., K.B.E.

MRS. ROUTLEDGE'S account deals with her most adventurous yachting cruise, with her husband, to Easter Island, the easternmost—i.e. the nearest to the American coast—of that great archipelago of innumerable islands which begins off the Australian coast and ends at this islet of stone images. A considerable number of the pages of the book are occupied by a vivid and rather unusually interesting travellers' story of places visited on the outward and homeward voyages, Patagonia and the islands of Juan Fernandez and Pitcairn among others; but it is to the much fuller account of Easter Island itself, occupying one hundred and seventy-six pages of the middle of the book, that we turn most eagerly.

The mystery which surrounds the history of Easter Island, with its great statues and its unique, and perhaps for ever indecipherable, script, unparalleled elsewhere, has from time to time long attracted the attention, though very rarely the visits, of ethnologists; but in the absence of exact data the mystery has hitherto never been even approximately solved.

Mr. and Mrs. Routledge, in search of new adventure, sailed in their own small yacht, the *Mana*, to the island, spent some fifteen months there (Mr. Routledge was away from the island during a considerable part of the time), and have now given us a somewhat full

account of their experiences there. The story, if far from completely satisfying, at least supplies a very great deal of material for home-staying ethnologists to study. Moreover, Mrs. Routledge



FIG. 1.—Exterior of Rano Raraku. Eastern portion of southern aspect. Diagrammatic sketch showing position of statues. From "The Mystery of Easter Island."

holds out hopes of "another volume in prospect, with descriptions and dimensions of some two hundred and sixty burial places in the island, and thousands of measurements of statues, and other really absorbing matter." It is greatly to be hoped that this further instalment of exact data

<sup>1</sup> "The Mystery of Easter Island: The Story of an Expedition." By Mrs. Scoresby Routledge. Pp. xxi+404. (London: Sifton, Praed, and Co., Ltd., n.d.) Price 31s. 6d. net.

will be published before the great interest which has been aroused by the present foretaste has evaporated.

The most interesting points brought out in the present book are those which serve to throw partial light on the great stone statues which are so abundant in the island, and, in connection with these, on the origin of the Easter Island folk. It has hitherto generally been assumed that these folk were of Polynesian race. But recent research, by Prof. Keith and others, seems

between Easter Island arts and customs and those found in certain of the Solomon Islands serve to illustrate this.

Without throwing any doubt on this suggestion, tentatively put forward by Mr. and Mrs. Routledge, with the strong support of Mr. Balfour and others, I again venture to put forward the view that, while Easter Island culture is doubtless of very mixed origin, Polynesian and Melanesian elements being most strongly represented, there were probably also other elements—e.g. some influence, possibly slight, and only very occasional, from the not far distant American shore lying to the eastward. For instance, the script (on wooden plaques), the rock-carvings, the featherwork, and the very peculiar form of tapa (bark cloth) which was used in Easter Island, all seem to me to suggest an Eastern, rather than a Western, origin.

One other suggestion may here be put forward as a contribution to the consideration of the Easter Island mystery. Mrs. Routledge writes of the well-known "top-pieces" which are, or were, superimposed on the statues as "hats"; and Mr. Balfour suggests that these were very probably meant to represent not hats, but hair, and in the number of *Folklore* above quoted he works this out in very ingenious detail. I venture to suggest a slight amendment to Mr.

Balfour's proposition—i.e. that the stone cap-pieces in question were meant to represent not actual growing human hair, but wigs, such as those which were, and still to some extent are, commonly used by Fijians—though whether by those of Polynesian or Melanesian origin I cannot now say. It would be interesting to know how far such wigs were used in other parts of the Pacific.

It is satisfactory to know that a second edition of Mrs. Routledge's book is already in course of preparation, and all ethnologists must hope that the full scientific data will also soon be published.



FIG. 2.—A finished Hat at Ahu Hanga O Ornu; others in the distance. From "The Mystery of Easter Island."

to show that, in Easter Island, as in so many of the South Sea Islands, several races with other than Polynesian culture have from time to time invaded this remote and isolated islet. Mr. Henry Balfour (in *Folklore* for December, 1917) has suggested (modestly he disclaims to have done more) some of the main results to which Mr. and Mrs. Routledge's experiences seem to point, and chiefly to the probability that at some long-distant time a strong wave of Melanesian influence reached Easter Island. Certain points of curiously strong resemblance

## The Blue Sky and the Optical Properties of Air.<sup>1</sup>

By the RIGHT HON. LORD RAYLEIGH, F.R.S.

Scattering by Small Particles. Polarisation.

THE subject chosen for this evening is one which specially interested my father throughout his career. I shall try to put before you some of his conclusions, and then pass on to more recent developments, in which I have myself had a share.

Let us begin with one of his experiments which illustrates the accepted theory of the blue sky.

We have here a glass tank containing a dilute solution of sodium thiosulphate. A condensed beam from the electric arc traverses it and then falls on a white screen, where it shows the usual white colour. I now add a small quantity of acid, which decomposes the solution with slow precipitation of very finely divided particles of sulphur. As soon as this precipitation begins you see that light is scattered—that is to say, it is diverted to every side out of the original direction of propagation. Moreover, you will observe that the

<sup>1</sup> Discourse delivered at the Royal Institution on Friday, May 7, 1925.

scattered light is blue. The transmitted beam is robbed of its bluer constituents, and tends to become yellower, as you may see on the screen.

The light scattered laterally is to be compared to the blue sky; the yellow transmitted light to the direct light of the setting sun when it has traversed a great thickness of air.

As the precipitation goes on, the transmitted light becomes orange, and even red. But the particles of sulphur eventually get bigger, and then give a less pure blue in the lateral direction. We shall have more than enough to occupy us if we confine our attention to the earlier stages, when the particles are small compared with the waves of light.

A very important property of the scattered light is its polarisation. The vibrations of the scattered light as you have seen it, viewed laterally in the horizontal plane, are almost wholly up and down. No light is emitted which vibrates in the horizontal plane. It is easy for individual observers to verify this with a Nicol's prism held to the eye, but this direct method unfortunately does not lend itself to public demonstration.

We may, however, use polarised light to begin with, and you can then observe that if the polarising Nicol is set so as to transmit up and down vibrations, these are abundantly scattered towards you by the small particles. As I turn the polarising Nicol through a right angle, you will see that the light scattered towards you is extinguished.

The polarisation of light scattered by the sulphur particles is one of the most conclusive reasons for considering it to be an analogue of the blue light of the sky, for the latter shows a polarisation of exactly the same kind when examined at right angles to the sun.

A cloud of small particles of any kind is capable of producing these effects, the essential condition being that the individual particles should be of small dimensions compared with the wave-length of light, so that at a given moment the vibration at a given particle may be regarded as having a definite phase. In this case it was shown by my father that the shorter (blue) waves are of necessity more scattered than the longer ones (red); thus the scattered light is bluer than the original. This conclusion can be justified in detail whether we adopt the elastic solid theory, or the electromagnetic theory of the nature of light, but it is also deducible from the general theory of dimensions, without entering upon any details of the nature of light beyond its characterisation by the wave-length.

An alternative theory which still sometimes shows its head attributes the colour of the sky to a blueness of the air, regarded as an absorptive medium. Such blueness is referred to the presence of ozone, and appeal is made to the undoubted fact that a sufficiently thick layer of ozone shows a blue colour by absorption. This theory gives no account of why the sky light is polarised, or indeed of why there is any light in the clear sky at all. Further, its fundamental postulate that the

air is blue by transmission is contrary to observation. The setting sun is seen through a greater thickness of air than the midday sun. According to the theory under discussion, the setting sun ought to be the bluer of the two, which everyone knows it is not. No doubt the presence of ozone tends to make the air blue by transmission. But this effect is more than compensated by the lateral leakage (scattering) of blue light from the beam, which makes the transmitted light yellow.

#### *Dusty Air and Pure Air.*

If it be conceded that the blue sky is due to scattering by small particles, we are confronted with the question: Of what nature are these particles? At the time of my father's early investigations (1871) this was left open, though they were regarded as extraneous to the air itself. In 1899 he returned to the subject, and considered the matter from the point of view of what was lost by the original beam by lateral leakage (scattering), which simulates the effect of absorption. He then found that the air itself, regarded as an assemblage of small particles (molecules of oxygen and nitrogen), would have an apparent absorbing power not much less than that actually deduced by observations of the sun at different altitudes. The inference was that the air itself was capable of accounting for much, if not all, of the scattering which is observed in the blue sky; in fact, that the molecules of air are the small particles in question.

When a beam of sunlight enters a room through a small aperture in the shutter, its course is readily traced by the brightly illuminated motes in the air. Prof. Tyndall, working in this institution, devoted much attention to the nature of these motes, and the methods by which they may be got rid of. His results may be consulted in his fascinating essay on "Floating Matter." One way of getting rid of the motes is to filter the air through cotton-wool. We have here one of Tyndall's own experimental tubes. The electric beam passes axially along it, and is concentrated to a focus about the middle of its length. Its track is conspicuous. If now we displace the air originally in the tube by filtered air, you see that the cone of light fades into invisibility.

Another of Tyndall's experiments was merely to place a spirit lamp or Bunsen burner under the beam. Since most of the dust particles are combustible, the gases rising from the flame are free from them. As you now see, dark rifts appear in the beam where the uprising stream of dust-free gases traverses it.

Tyndall, on the strength of these experiments, stated without qualification that dust-free air does not scatter light, but my father's views and theory lead clearly to the conclusion that it does. But when I asked him what he thought about the feasibility of detecting it by a laboratory experiment, he was not very sanguine of success. It seemed worth while, however, to make the attempt, and I came to the conclusion that the difficulty was not

so much in the faintness of the effect to be looked for as in the avoidance of stray light which came into competition with it. The essential thing is to get a perfectly black background against which the beam (viewed transversely) can be observed. We cannot get this with a vessel like Tyndall's tube just used. It is necessary to have what may be called a black cave, and to view the beam as it crosses in front of the mouth of the cave, the latter forming the background. If the cave is deep enough, there is no limit to the blackness attainable. The great sensitiveness of the well-attained eye, or the photographic plate, can then be brought to bear, and the track of the beam can be well seen, however carefully the dust is removed.

Some persons have been inclined to question whether the dust is removed completely in these experiments. As a matter of fact, this is not where the difficulty lies at all. Dust so fine as to be very difficult of filtration is an arm-chair conception, not encountered in practical experimenting. An enormous multiplication of the length and tightness of the cotton-wool filter makes no difference at all, a filter of modest dimensions doing all there is to do.

The dust particles which are originally present in the air, near the ground or in a room, are large, being in some cases individually visible to the naked eye; thus they do not fulfil the condition for scattering a preponderance of blue light. The molecules of air are, of course, amply small enough, and the band of light seen stretching across the mouth of the dark cave is, to my eyes at least, of a full blue colour. In exhibiting the effect to individual friends (and unfortunately it is not bright enough to be shown to an audience), I have been surprised and somewhat disconcerted to find that they do not all see it blue as I do, but some, for example, describe it as lavender. This is undoubtedly due to a peculiarity of colour-vision where faint lights are concerned. The ultimate test is the spectroscope. Photographs of the scattered light taken with this instrument clearly show that the maximum of intensity is shifted towards the blue, as compared with the original exciting light.

#### *Polarisation of Light Scattered by Pure Air.*

A very important point to examine in connection with the scattered light is its state of polarisation. Visual examination with a Nicol's prism soon showed that the polarisation was very nearly complete. For closer examination I had recourse to photography. It may perhaps be thought an easier and more effective plan to look at a phenomenon than to photograph it, and no doubt it is so in many cases: not, however, where the light is very faint, but admits of long exposure. It has long been recognised that photographs of the nebulae will show much more than can be detected visually by the keenest and most discriminating eye. In this work on the scattering of light, I have found it positively less trouble to take a photograph than to make a visual observation,

even when the latter was feasible. The time required to rest the eye in darkness and the effort of attention required in observing a faint effect cost the experimenter more than the exposure and development of a plate.

When the scattered beam in pure air is photographed, with a double image prism of Iceland spar mounted over the photographic lens, it is found that the polarisation is nearly complete, but not absolutely so. However carefully the instrumental adjustments are made and the air filtered, I have found that there is a slight residual polarisation indicating vibrations parallel to the direction of the original beam. The intensity of this residual polarisation, in what may be called for convenience the wrong direction, is about 4 per cent. of the whole. Now, as the theory shows, there are two causes to which failure of complete polarisation may be attributed. One, which we may dismiss in this case, is that the particles are not small enough. Another is that they are not spherical—that is to say, it is not a matter of indifference which way they are presented to the primary beam. The latter alternative may be illustrated by considering an extreme case—namely, what we may call a needle-like molecule, capable of vibrating only in one direction fixed within it. Evidently such a molecule when obliquely situated will have a component vibration parallel to the direction of the incident light.

From the experimental fact that there is such a component we may infer that the molecules of air are not in the optical sense spherical. Experiments on various gases have shown a characteristic departure from complete polarisation, different for each gas. Much effort has been spent on determining the exact amount for each, and it is hoped that the numbers obtained will form valuable material in the future for investigating the structure of atoms and molecules.

#### *Polarisation of the Night Sky.*

We have seen that the polarisation of the daylight sky is one of the most conclusive proofs that its light is due to scattering by small particles. What of the sky at night? Some of you will perhaps be inclined to reply that the sky at night is dark, and that the question whether its light is polarised does not arise. It is, however, by no means the case that the sky on a clear night is absolutely dark, as anyone may readily prove by holding his hand with outstretched fingers against the sky. The fingers will appear dark against the sky as a luminous background.

The light is no doubt very faint, but I thought it would be practicable to test whether it was appreciably polarised or not. For this purpose what is called a Savart polariscope was used. Time will not allow us to consider the rather complex theory of this apparatus; it must suffice to say that if the light which falls upon it contains even a small part which is polarised, bands alternately bright and dark are produced, which further show colour due to the composite nature

of white light. These bands are clearest when the incident light is completely polarised, as you now see them projected on the screen. But they can still be seen when the polarisation is but slight. I will illustrate this by removing the polarising Nicol which I have been using, and substituting a single-glass plate, through which the incident light passes. If I incline this plate so as to polarise a small fraction of the light, you see the bands, faint but sufficiently distinct. In examining the light of the night sky, a photographic plate is substituted for the paper screen I have been using to-night, and the apparatus is designed for the utmost economy of light. With two hours' exposure a definite image of the sky was obtained, with the stars superposed upon it. The Savart bands could be seen, but they were very faint compared with what would have been observed with an equally good image of the daylight sky. The part of the sky examined was near the pole, and therefore nearly at right angles to the sun. If, as seemed possible, the night sky derived its light from an attenuated atmosphere so high as to be outside the earth's shadow, we should expect it to show the same polarisation as the day sky. Since it does not do so, we must attribute the light at night to some different origin.

I was fortunate in being able to interest Prof. Hale in this matter while he was on a visit to England, and as a result Mr. Babcock repeated the observations in a modified form at the Mount Wilson Observatory in California. The traces of polarisation which he obtained in that clear atmosphere were even less than what I got in England.

#### *Ozone, and the Limit of the Solar Spectrum.*

Although, as we have seen, the idea that the blue colour of the sky is due to any action of ozone cannot be admitted, yet there are points of great optical interest connected with the presence of this gas in the atmosphere. We may now turn to the consideration of some of these.

It is of course well known that when the solar spectrum is formed by a prism of quartz or by a grating, the spectrum can be observed to extend beyond its visible limit in the violet into the region called ultra-violet. When, however, we examine the spectrum of an electric arc (and for this purpose an iron arc is particularly suitable), the extension is observed to be very much greater than in the solar spectrum. This is not because the sun does not emit any rays of the kind in question, but because the earth's atmosphere will not allow them to pass through so as to reach us at the earth's surface. There are many reasons for feeling sure that this is the true explanation, but one of the simplest will here suffice. When the sun is near the horizon, so that the rays pass obliquely through the earth's atmosphere, and consequently have to traverse a thicker absorbing layer, the extent of the ultra-violet spectrum is found to be even less than when the sun is high and less air is traversed by the rays. This sufficiently proves the point.

It has long been suspected that ozone in the

atmosphere is the effective cause of this absorption of the ultra-violet rays. The most important constituents of air, oxygen, and nitrogen do not appreciably absorb at the point where the solar spectrum ends, nor do the constituents of secondary importance, carbonic acid, water-vapour, and argon. We must therefore look to some rare constituent of air which is very opaque to this region of the spectrum. Ozone possesses this opacity, as I shall now show you. So far as I know it has not been attempted to show this before to an audience, but I think you will be able to see it without difficulty. As a source of light an iron arc is used, and the lenses and prism employed in forming the spectrum are of quartz. I allow the spectrum to fall on a piece of paper, and you see the usual succession of colours, red, yellow, green, blue, and violet, forming a comparatively narrow rainbow-like band. Beyond the violet all appears dark, the eye being insensitive to the ultra-violet rays. If now I substitute for the paper a screen of barium platinocyanide<sup>2</sup> (of the kind used in X-ray work), we see an immense extension of the spectrum beyond the violet. The screen has the property of transforming the ultra-violet rays, which the eye cannot detect, into green rays which are readily visible. Thus beyond the violet region we see green, which is, of course, in no way to be confused with the original green which was present in the source, and appears in its normal position in the spectrum, on the other side of the blue-violet. I interpose a thin sheet of ordinary glass, and the greater part of this extension of the spectrum which we get on the fluorescent screen disappears. What I want specially to show you, however, is that a thin layer of ozone, much too thin to have any perceptible colour, will have the same effect. There is a glass tube, about 6 in. long and  $\frac{3}{4}$  in. in diameter, situated between the quartz lantern condenser and the slit, when the beam is parallel, and the walls of the tube are projected as two thin transverse lines on the slit, dividing the spectrum into thin horizontal strips, one over the other. The light constituting the middle strip has traversed the tube, but the light constituting the upper and lower strip has traversed the open air above and below the tube. A stream of oxygen passes through a Siemens ozone generator and enters the middle of the observation tube, streaming out at the two ends. While the ozone generator is not excited, the middle strip of the spectrum is similar to the comparison strips above and below. If the induction coil is turned on so that ozone passes into the tube, you see that in a few seconds the greater part of the ultra-violet spectrum fades out from the middle strip, which contrasts sharply with the upper and lower ones. When the coil is turned off, the ozone is rapidly blown out by unozonised oxygen, and the original state of things restored.

It must be remembered that the ozone used in this experiment is extremely dilute, probably only a fraction of 1 per cent. of the oxygen in the tube.

<sup>2</sup> Kindly lent by Messrs. Watson.

Yet it interposes an impassable obstacle to the ultra-violet rays, at least to those of shorter wavelength than about 2900 angstroms. It cuts off the iron spectrum at about the same point where the solar spectrum ends. Speaking roughly and generally, it may be said that glass is somewhat more opaque than ozone—i.e. that with diminishing wave-length the limit of transmission is reached somewhat sooner. To make a statement of this kind quite definite the thickness must of course be specified.

Sir William Huggins devoted a great deal of attention to the spectra of the sun and stars in the extreme ultra-violet region, using for the purpose a reflecting telescope, and prisms and lenses made of quartz or Iceland spar. In this way the absorption of a glass objective was avoided. He noticed in 1890 that the spectrum of Sirius showed a number of bands near the extreme limit of atmospheric transmission, the bands tailing off into complete absorption.

These bands were observed and discussed by other authors, but no definite conclusion was reached as to their origin until 1917, when the matter was taken up by my colleague, Prof. Fowler, and myself. Our interest was stimulated by an excellent photograph of the bands, taken at Edinburgh Observatory under Prof. Sampson's direction, which I show on the screen. We found that the same bands were present in the solar spectrum. It may seem strange that this had not been observed long ago, considering how closely the solar spectrum has been scrutinised for more than a generation. As a matter of fact this is one of the cases where a powerful instrument is a positive disadvantage. The bands are diffuse, and under high dispersion they are unrecognisable. In any case, they are less conspicuous than in the spectrum of Sirius, because in the sun numerous metallic lines are superposed upon them and distract the eye.

Now the position and general aspect of these bands suggested that they were connected with the absorption which terminates the spectrum. This led us to suspect that they were due to ozone, and the suspicion was readily confirmed by experiment. Burning magnesium ribbon gives a convenient source of continuous spectrum in the ultra-violet region. Interposing a long tube containing ozone between the burning magnesium and the slit, a series of bands was photographed which

exactly corresponded to those photographed in the solar spectrum with the same instrument, as you will see in the slide shown.

#### *Absence of Ozone near the Ground.*

We are then driven to the conclusion that the absence of short waves from the spectra of the sun and stars is due to absorption by terrestrial ozone. But it was not thought desirable to let the matter rest there. It is true that many attempts had been made to determine the (no doubt very small) quantity of ozone in air by chemical means, but with very conflicting results, because other constituents of air, such as oxides of nitrogen, are liable to produce reactions not unlike those of ozone. It seemed more satisfactory to test the absorbing power of air near the ground for ultra-violet rays, to which ozone is so opaque. I used for this purpose a mercury vapour lamp in a quartz vessel, which is a powerful source of ultra-violet rays, and observed its spectrum four miles away, so that the mass of air intervening was as great as that between the midday summer sun and the top of the Peak of Teneriffe, from which observations of the extent of the solar spectrum have been made. The result was to show that the mercury lamp spectrum was by no means stopped when the solar spectrum stops, but that it extended to the region where ozone is most opaque. There is a strong mercury line (wave-length 2536) at about this point which was distinctly photographed. Its intensity was of course a good deal reduced relative to the visible spectrum by atmospheric scattering. But there was no evidence whatever of ozone absorption.

What conclusion can we draw? Evidently that the absorbent layer of ozone in the air is high up, and that there is little or none near the ground. It may seem at first sight that this thin and inaccessible layer of ozone, which we have learned of by a chain of reasoning not less conclusive than direct observation, is a matter of little importance to man and his welfare. There could be no greater mistake. It acts as a screen to protect us from the ultra-violet rays of the sun, which without such a protection would probably be fatal to our eyesight: at least if one may judge from the painful results of even a short exposure to such rays, which those who have experienced it are not likely to forget.

## The Future of the Iron and Steel Industry in Lorraine.

By PROF. H. C. H. CARPENTER, F.R.S.

DURING the spring of last year two Commissions were appointed by the Minister of Munitions to visit and report upon certain steel-producing areas in Western Europe. One of them visited the steel works in Lorraine and certain parts of the Saar Valley, the other journeying to the occupied areas of Germany, Luxemburg, and certain parts of France and Belgium. The

former was under the charge of Sir William Jones, and included Messrs. Percy Cooper, Rowland Harding, and Cosmo Johns, while the latter was entrusted to Dr. F. H. Hatch, who had with him Messrs. L. Ennis, James Henderson, and Richard Mather. The Commissions were absent about three weeks. The terms of reference to them were the same and were to ascertain:—



(a) The character and extent of the technical and other developments which had taken place during the war, with special reference to the steps taken for the development of munitions output.

(b) The present condition of plant and machinery.

(c) The prospects of these areas either as competitors with or markets for British industries.

(d) The developments in fuel economy in the steel trades of these areas.

The reports furnished by the Commissions were printed in the first instance as confidential documents by the Ministry of Munitions, but have now been made public. That of the Commission which visited Lorraine and the Saar Valley is the more complete and interesting in that it throws light on the possibilities of development of the iron- and steel-producing area, which, as a result of the war and the Peace Treaty, has passed from German to French ownership.

The view of the Commission is that the acquisition by the French of these areas should be of advantage to British industries on the whole, and that while France may become a competitor with Britain in so far as her surplus steel production is concerned, taking the place of Germany to some extent, it will not be until the destroyed works have been reconstructed and full production has been reached in a period which it estimates at from three to five years. As a result of the war, France has replaced Germany as the possessor of the largest iron-ore supplies in Europe, her reserves having been increased by more than 2,000,000,000 tons, making them now about four times those of Germany. Before the war they were approximately the same.

Whereas France's production of pig iron in 1913 was about 5,000,000 tons, with her new possessions in Lorraine and the Saar Valley she is in a position to produce 11,000,000 tons annually. Prior to the war German steel makers frequently complained of the difficulty of obtaining adequate supplies of foreign ores, and this is regarded by many as one of the chief causes of the war, since they hoped thereby to obtain possession of France's ore reserves. The Commission states that whereas in 1913 Germany produced 27,000,000, and France 21,000,000, tons of iron ore, it estimates future production to be in the ratio of Germany 7,000,000 to France 42,000,000 tons. It would appear that outside France Germany can expect to obtain ore only from Sweden or Spain, but as both these countries are actively developing their steel industries they will probably not have very much to spare.

With regard to coal, however, France's position is by no means so satisfactory. Her pre-war production was about 40,000,000 tons, and her consumption 60,000,000 tons, the balance being obtained from Great Britain, Belgium, and Germany.

The control by France of the coal of the Saar Valley area is estimated to enable her to produce twice the tonnage obtained from the Valenciennes district. This would mean an addition of 17,000,000 tons to the annual output, which nearly

meets the deficit. The Commission states, however, that the ideal of the French iron and steel makers in the Lorraine area at the present time is that means should be devised whereby a reciprocal business may be done with Great Britain by their supplying basic pig iron in exchange for furnace coke or coking coal. If the anticipated output of oven coke in this country is realised there should be some to spare, but the difficulties of transport, transshipment, etc., and the resultant breakage are serious factors to be considered. Possibly the solution of the present problem may be found in the erection of coke ovens in Lorraine close to the furnaces, and in the production of coke on the spot from a mixture of Saar coal and Durham coking coal. The supply of the latter cannot take place until better and cheaper means of transport are available.

The Commission states that France dreads the present position of dependence upon Germany for coke supplies, since, although the Peace Treaty gives her control of the Saar Valley coal-field for, at any rate, fifteen years, the fact remains that under existing conditions the works must have coal or coke from Westphalia for their blast furnaces. The coke obtained from Saar coal is apparently unsatisfactory, so that so long as this position continues French industry will remain to a great extent at the mercy of the Germans, a position the French are, naturally, most anxious to avoid. It is true that Germany will want iron ore from Lorraine, but she will not be so entirely dependent upon this one source of supply as the Lorraine works will be upon Germany for coke, unless some means are provided to enable them to obtain coke from elsewhere or to produce what they need from Saar coal and imported coking coal.

Various schemes for improved transport are under contemplation by France. The construction of a canal to Dunkirk from the Brier district known as the "Canal du Nord et de l'Est" has been under consideration for a long time. This would take at least five years to complete, and is not generally favoured by the French steel makers in Lorraine owing to the enormous cost of construction and the great difficulties to be overcome in cutting it through the densely populated industrial areas of Northern France. The scheme most favoured is that known as the canalisation of the Moselle from Coblenz to Thionville and thence to Metz, coupled with free navigation of the Rhine to Rotterdam or by canal from the Rhine to Antwerp *via* Maastricht. Either of these schemes, it is considered, would be much cheaper and more quickly operative than the canal to Dunkirk. The estimate of the cost of the Moselle Canal scheme would be between 15,000,000*l.* and 20,000,000*l.*, and it is calculated that the construction could be completed in three years. Plans for this scheme are in the hands of the French authorities. The strong feeling in favour of this scheme to enable reciprocal business to be done with Great Britain is accentuated by the treatment

accorded to the Lorraine steel works by Germany in the matter of coke supplies, since the Germans have failed to carry out their obligations under the terms of the Peace Treaty, and have delivered only about one-third of the tonnage promised, notwithstanding the fact that there are large stores of furnace coke in Westphalia. Since Great Britain has been short of basic pig iron for a long time, and there is every prospect of the shortage continuing, some such reciprocal arrangement as that put forward might be of advantage to both countries.

The Commission states that there is no doubt that economy in fuel consumption is very fully effected, owing to the absence of cheap and suitable fuel and the dependence of the works upon Westphalian coke. All the waste heat is utilised at every works. The blast-furnace gas is suitably cleaned and fully absorbed. The works at Homécourt may be cited as an instance. Before the war they were producing 9000 tons of pig iron and 7000 tons of steel weekly, and they used only 280 tons of coal, all the remaining power being produced from blast-furnace gas. This is quite typical. The molten metal is taken from the blast furnaces to the mixers in the adjacent steel works and the sensible heat thus utilised.

A study of the report leaves the impression that the development of the iron- and steel-producing areas in Lorraine which have passed from German to French management presents problems which will call for patient consideration, dispassionate counsel, and scientific treatment, if they are to be surmounted successfully. The formidable position which Germany had built up between 1871 and 1914 has been lost to her by the war. It remains to be seen what France will make of the heritage which has passed into her hands.

### Obituary.

WE regret to note that the death of MR. JOHN W. W. DRYSDALE is recorded in the *Engineer* for June 25 as having occurred on June 21. Mr. Drysdale was in his seventy-second year, and was one of the founders of the well-known Glasgow firm of Drysdale and Co., Ltd. He finished his education at Glasgow University under Prof. Macquorn Rankine, and thereafter started a small works in conjunction with a fellow-student, Mr. Lewis J. Pirrie, son of Principal Pirrie of Aberdeen. Centrifugal pumps formed their outstanding speciality from the first, and the firm has acquired a wide reputation for its products. Mr. Drysdale was a member of the Institution of Engineers and Shipbuilders in Scotland.

WE announce with great regret the death, at the Queen Alexandra Military Hospital, Millbank, of SURGEON-GENERAL W. C. GORGAS, of the U.S. Army, so well known for his work in combating yellow fever and malaria.

### Notes.

THE Lord President of the Council, as president of the Committee of Council for Scientific and Industrial Research, has appointed Dr. J. S. Flett, at present Assistant to the Director in Scotland, to be Director of the Geological Survey and Museum. Dr. Flett succeeds Sir Aubrey Strahan, who retires this month. Mr. G. W. Lamplugh, Assistant to the Director in England, also retires.

SIR JOHN CADMAN, MR. W. B. HARDY, and Prof. S. Young have been appointed by an Order in Council members of the Advisory Council to the Committee of the Privy Council for Scientific and Industrial Research.

It is announced that Sir T. Clifford Allbutt is to be sworn a member of the Privy Council.

THE secretaryship of the Royal Irish Academy, vacant through the death of Prof. J. A. McClelland, has been filled by the election of Prof. G. H. Carpenter.

THE Barnard medal of Columbia University has been awarded to Prof. Einstein "in recognition of his highly original and fruitful development of the fundamental concepts of physics through the application of mathematics."

DR. E. SOLVAY has been elected an honorary member of the American Chemical Society.

THE Medical Research Council has recently established at the Lister Institute of Preventive Medicine a national collection of type cultures from which biologists in general, and bacteriologists in particular, may obtain authentic strains of recognised bacteria and protozoa for use in scientific work. The scheme is under the general direction of Dr. J. C. G. Ledingham, while Dr. R. St. John Brooks has been appointed to the post of curator of the collection and Miss Mabel Rhodes to that of assistant curator. It is proposed to collect and maintain bacterial strains from all departments of bacteriology, human, veterinary, and economic, and already considerable work has been done towards the formation of a representative collection on these lines. The efforts of the staff are, however, at present particularly directed towards the securing of fully authenticated strains responsible for or associated with disease in man and animals. The bureau proposes to supply cultures on demand to all workers at home and abroad, and, as a rule, a nominal charge per culture will be made to defray postage and media. Strains sent for identification and maintenance should be accompanied by particulars as to source, date of isolation, etc. In due course a catalogue will be prepared for publication.

IN NATURE of January 1 last an account was given of the Cawthron Institute of New Zealand, founded for the furtherance of scientific research in relation to agriculture and other industries. The scope of the institute has since been extended by the establishment of a biological department, of which Dr. R. J. Tillyard, the eminent Australian entomologist, hitherto

research fellow of Sydney University, has been appointed chief. He will be assisted by Miss K. M. Curtis as mycologist and Mr. A. Philpott as assistant entomologist. We understand that members of the scientific staff of the institute will have full freedom as to research and publication.

A COMMITTEE, composed of the following members, has been appointed by the Ministry of Health to consider and report on the legislative and administrative measures necessary to secure adequate protection for the health of the people in connection with the slaughter of animals and the distribution of meat for human consumption in England and Wales:—Sir H. C. Monro (chairman), Mr. W. G. R. Boys, Mr. R. B. Cross, Mr. J. Edwards, Dr. W. J. Howarth, Dr. A. W. J. MacFadden, Mr. T. Masheter, Mr. A. W. Monro, Mr. T. Parker, Mr. R. J. Robinson, and Mr. P. Taylor. Mr. H. F. O. Jerram is the secretary of the Committee, and communications should be addressed to him at the Ministry of Health, Whitehall, S.W.1.

It was stated by Mr. Bonar Law in the House of Commons on Monday last, with reference to the question of scientific war inventions, that the Lord President of the Council is about to appoint an inter-Departmental Committee with the following terms of reference:—(1) To consider the methods of dealing with inventions made by workers aided or maintained from public funds, whether such workers be engaged (a) as research workers or (b) in some other technical capacity, so as to give a fair reward to the inventor and thus encourage further effort, to secure the utilisation in industry of suitable inventions, and to protect the national interest; and (2) to outline a course of procedure in respect of inventions arising out of State-aided or supported work, which shall further these aims and be suitable for adoption by all Government Departments concerned.

A SPECIAL meeting of the Röntgen Society is to be held at University College, Gower Street, at 9 o'clock on Thursday evening, July 15, when an address will be delivered by Dr. W. D. Coolidge, of the Research Laboratories of the General Electric Co., Schenectady, New York. An invitation to the meeting is given to the members of other scientific and medical societies.

A FREE public lecture on "Oil Storage, Transport, and Distribution" is to be delivered by Mr. H. Barringer at 6 o'clock on July 14 in the Canada Building, Crystal Palace, under the auspices of the Institution of Petroleum Technologists. The institution has also arranged for the delivery of four lectures, as follow, in September, the actual dates for which will be announced later: "Oil Prospecting," Mr. G. Howell; "Petroleum Refining," Dr. A. E. Dunstan; "Utilisation of Volatile Oils," Dr. W. R. Ormanby, and "Utilisation of Heavy Oils," Prof. J. S. S. Brame.

THE annual Oxford Ophthalmological Congress will take place in the Department of Human Anatomy in the University Museum, Oxford, on July 15 and 16. Among the promised communications are the following: The Doyne memorial lecture, by F. R. Cross,

on "The Nerve Paths and Centres concerned with Sight": A. S. Percival, "Light Sense"; Dr. Van der Hoeve, "Eye Symptoms in Tuberoso Sclerosis of the Brain"; Dr. L. C. Peter and others, "Perimetric Methods"; M. Barton, "Examination of the Eyes of Pit Ponies, particularly with reference to Miners' Nystagmus"; A. H. Thompson, "Physiological and Glaucoma Cups"; R. D. Batten, "Premonitory Symptoms of Glaucoma"; and Dr. L. Sambon, "Ancient Eye Instruments."

THE Research Association for the Silk Industry has been approved by the Department of Scientific and Industrial Research as complying with the conditions laid down in the Government scheme for the encouragement of industrial research. The secretary of the committee engaged in the establishment of this association is Mr. A. B. Ball, the Silk Association of Great Britain and Ireland, Kingsway House, Kingsway, W.C.2.

THE jubilee of the American Fisheries Society will be celebrated at Ottawa on September 20-22 next. In connection with the meeting prizes will be offered for papers on the following subjects: Advance in practical fish cultural work; biological work connected with fish problems in general; and the solution of problems affecting commercial fisheries work. The competitive essays should be received by, at latest, August 20. Further information can be obtained from the executive secretary, Prof. R. C. Osburn, Ohio State University, Columbus, Ohio.

A PROPOSAL is on foot by the Swedish Linnean Society to restore the old botanic garden at Upsala, together with the house in it, the former residence of Carl von Linné, and subscriptions towards this object are solicited. Particulars of the suggested memorial can be obtained from the General Secretary of the Linnean Society of London, Burlington House, W.1, and donations sent to him or direct to the Swedish Linnean Society at Upsala.

ARCHITECTS, timber merchants, firms engaged in the building and furniture trades, railway companies, and, in fact, all users and consumers of wood, paper, and other forest products, should visit the British Empire Timber Exhibition, which is open to the public at the Holland Park Skating Rink, London, until July 17. The exhibition has been organised to display the forest wealth of the British Empire. Before the war the greater part of the immense importations of timber into the United Kingdom, some 10,000,000 tons annually, came from foreign countries, and many of these were closed during the war. This necessitated a considerable development of the sources of supply within the Empire and a greater demand on our home forests. The main object of the exhibition is a patriotic one, namely, to show that our timber requirements can be met in great measure from our Dominions and Colonies, thus extending Imperial trade. The specimens of timber include very many beautiful, valuable, and useful woods, of which only a few may be mentioned as examples, such as rose-wood, satinwood, mahogany and its various substitutes, teak, greenheart, jarrah, ironwood, and the

numerous cedar woods. There is also a complete set of exhibits demonstrating the various uses to which timbers are put, as floors, panelling, veneers, plywood, furniture, and articles of everyday use. Many decorative exhibits are of great interest. The preparation of paper-pulp from bamboos is also shown. An exhaustive catalogue of the exhibits has been prepared. This gives both the botanical and trade names, the countries of origin, and names of shippers and importers. Each wood is fully described as regards its general characteristics, tension strength, and other useful data. The information in the catalogue has been compiled by the various Forest Departments of the Empire, and has a scientific as well as a commercial value.

THE half-yearly report of the Department of Civil Aviation on the progress of civil aviation from October, 1919, to March, 1920, contains many features of general interest. A very detailed survey of the results which have been achieved is given with regard to activities both in the British Empire and in foreign countries. Tabulated figures concerning the operation of air services between England and the Continent show that a slow but definite progress has been made. The importance of the International Air Convention is emphasised, and it is satisfactory to note that this Convention has now been signed by all the Allied Powers. The record of activities in foreign countries shows that many attempts are being made to develop commercial flying for both inland and international trade. France and Italy show the most promising results, and both are making efforts to exploit the possibilities of commercial aviation in Asia and South America. In late enemy countries many aviation companies have been formed to develop commercial flying, but no actual results have yet been achieved owing to the economic conditions prevailing. The first paragraph of the conclusion of the report is worthy of quotation as an apt summary of the present position. The Controller-General says:—"The discovery of a new method of increasing the speed of inter-communication has in the past generally indicated a fresh step in the march of civilisation. In aviation a means of transport has been obtained twice as fast as any other previously existing. The majority of countries which are imbued with the spirit of progress appear to realise that the future of aviation cannot be neglected, and by various methods, such as the creation of aviation departments, research, subsidies, and the conduct of experimental services, are striving to adapt aviation to commerce." Progress may be somewhat slow under the unsettled conditions which now prevail throughout the world, but there is little doubt that as the general economic situation improves, so will the advance of civil aviation become more rapid.

In 1910 Dr. W. Max Müller was enabled, through the liberality of the Carnegie Institution of Washington, to visit the doomed island of Philæ, and to glean the epigraphic material left by the Berlin expedition. His immediate purpose was the decipherment of the famous bilingual inscriptions engraved on the walls of the large court between the first and the second

pylons. This was exceedingly difficult, as the small, shallow-engraved signs become distinctly visible only during the short time of the day when they receive strong light. The Carnegie Institution has now published in a suitable style the result of Dr. Max Müller's labours. He gives complete facsimiles, transliterations, and translations of the inscriptions, and a learned introduction adequately reviews the historical information thus collected. The work is in every way creditable to the learned explorer and the Carnegie Institution.

IN the University of California Publications in American Archaeology and Ethnology (vol. xvi., No. 6) Miss Lucile Hooper gives a valuable account of Shamanism among the Cahuilla Indians, one of the largest surviving tribes in Southern California. At one of their *fiestas* or annual rites the Shaman first took a dark substance from his breast; then "he reached into the fire with his foot and kicked out a few coals. One of these he picked up; it was about the size of a dollar. He immediately put it into his mouth. I was only a few feet away, and one of the sparks from his mouth, as he blew, fell on my hand, so I can testify that they were hot. The glow from the coal could be seen on the roof of his mouth. He swallowed it in about a minute. He swallowed three coals in this way." The dancing and singing are part of the rite. One man intended to eat the coals, "but his song had not gone right; he had forgotten part of it, no doubt due to some disturbing influence among those watching, or perhaps because of some spirit preventing his success. Since his song did not go right, he could do nothing." Other marvels of a similar kind are reported. "Another man saw a dove walking around; he raised his hands and clapped them together. The dove dropped as though dead, and blood flowed from its mouth. He then picked it up, threw it into the air, and it flew off as though nothing had happened." The report includes a full account of the religious and domestic rites practised by the tribe. Their pottery, which was of an interesting type, has now disappeared with the use of manufactured articles.

An interesting report, by Mr. R. S. White, on an outbreak of pellagra amongst Armenian refugees at Port Said during 1916-17 has been published (Reports and Notes of the Public Health Laboratories, Cairo, No. 2, 1919). Much controversy has occurred with regard to the nature of this disease. In the outbreak in question the weight of evidence points entirely to a faulty diet as the causal factor, and the disease was eradicated from the camp by correcting this, all other conditions remaining the same. The diet at the time had an energy-value of about 2000 Calories only, which is very low, the protein amounting to but 46-48 grams, of which some 90 per cent. was derived from vegetable sources and was of low biological value. Maize had no direct causal relation to the disease. No protozoan or bacterial cause was discovered, nor could any connection with biting insects be found. The results of the inquiry are in accordance with the findings of Goldberger in the United States.

MR. FRANCIS HARPER, the assistant biologist of the United States Biological Survey, contributes to *Natural History*, the journal of the American Museum of Natural History, vol. xx., No. 1, an article of remarkable interest on the Okefinokee Swamp, which covers nearly seven hundred square miles of the south-eastern part of the State of Georgia. "It has no counterpart anywhere in the world." Drainage and the "lumber-man" threaten its existence, and unless the hand of the destroyer can be stayed it is certain that a considerable number of vanishing birds and beasts will be swept out of existence, this swamp being their last stronghold. In 1918 a society was formed for the purpose of securing the swamp as an educational and scientific reservation, and it is devoutly to be hoped that this aim will be secured; for such areas are of immense value, not only to the people of America, but also to the world of science at large.

WE have received from the American Museum of Natural History a brief preliminary report on the zoological collections made under its direction in the Belgian Congo territory during the years 1909-15. Of mammals, birds, and fishes respectively there are about 6000 specimens, of reptiles and batrachians nearly 5000, and of invertebrates more than 100,000. Material has been obtained for mounted groups of the okapi and square-lipped rhinoceros in their natural surroundings. There are also 3800 specimens illustrating anthropology. It is anticipated that the scientific papers on the collection will occupy twelve volumes of the Museum Bulletin, and a monograph of the okapi is being prepared for the Memoirs. There will also be a Narrative in two volumes and an Ethnological Album in three volumes. In consideration of the generous co-operation of the Belgian Government, a selection of duplicate specimens will be sent to the Congo Museum at Tervueren.

THE Crocker Land Expedition to North-West Greenland and Grinnell Land covered a district but little visited previously by naturalists. The mollusca obtained on the expedition by Dr. M. C. Tanquary and Mr. W. E. Ekblaw have now been described by Mr. F. C. Baker (*Bull. Amer. Mus. Nat. Hist.*, vol. xli., 1919, pp. 479-517, pls. 25-27). No new species are claimed, but the number determined exceeds by four those obtained on the Nares Expedition of 1875-76, when thirty-four were enumerated by the late Mr. E. A. Smith. The more important species of *Astarte* and *Buccinum* have been figured, with the detailed sculpturing of the shells of the latter, but the chief interest in the collection is the number of species found in high latitudes and the extension of the northward range of several of the species. The same author (*tom. cit.*, pp. 527-39, figs.) also describes a number of fresh-water mollusca obtained by Prof. Frank Smith from various lakes in Colorado and Alberta. Fifteen species in all are dealt with, of which three are believed to be new.

A PRELIMINARY account of the Tasmanian skeleton of *Nototherium*, to which we referred in last week's issue (p. 559), was read before the Royal Society of Tasmania on May 10 by Messrs. H. H. Scott and

C. Lord. The authors assign the specimen to *N. Mitchelli*, and consider that it was originally provided with a horn on the nose. They regard the *Nototheria* as the marsupial analogues of the rhinoceroses, some of them horned, others hornless.

THE atmosphere that surrounds the *Revue des questions scientifiques*, which is published at Louvain for the Société scientifique de Bruxelles, permits of the most liberal agnosticism in regard to scientific dogmas. Prof. Pierre Termier, in his address on "Les grands énigmes de la Géologie," delivered in the welcome epoch of recovery at Louvain in 1919 (*Revue*, vol. xxvii., p. 53, 1920), responds with his accustomed vigour to the invitation of his northern colleagues. His splendid oratory rings through these pages, in which he brings us face to face with the sphinxes that rise in the domain of geological inquiry and raise in the soul of the traveller "des pensées vertigineuses et des rêves sans fin." In his desire to show how much remains truly enigmatic, he makes no mention of tentative or even probable explanations, and his hesitating spirit before the evidences of organic evolution seems the pose of the courteous guest rather than the free expression of the prophet. For Prof. Termier, in his mere use of language, is a prophet and a power, and he hopes yet to see some secrets wrested from the earth as part of the general movement of humanity towards light and truth. On p. 149 of the same number of the *Revue* M. P. Teilhard de Chardin, who was present with the late Mr. Dawson at Pittdown, gives an excellent account of the human remains that have excited so much controversy, and he assures his readers that when palæontologists come to an agreement it is because they believe loyally and invincibly that their judgment has been based on truth. It is evident that these things still need saying, even in *sociétés scientifiques*, though we may have advanced some way from the scene so bitterly depicted by Barabino in his "Colombo deriso" at the Council of Salamanca.

THE New York Academy of Sciences has published two more parts of the results of its scientific survey of Porto Rico and the Virgin Islands (vol. i., part 2, and vol. iii., part 1). Porto Rico is largely and essentially a heap of volcanic *débris*, and Mr. Edwin T. Hodge attempts to unravel its geological history after making a detailed study and map of the Coamo-Guayama district. He also adds some useful notes on its mineral resources and hot springs. The limestones inter-stratified with the volcanic tuffs contain numerous fossil shells, which are, unfortunately, preserved only as impressions, but clearly represent several horizons between the Eocene and Miocene Tertiary. The shells are described in detail, with beautiful illustrations, by Miss Carlotta J. Maury, who makes some interesting remarks on their relation to the molluscs of existing seas. She points out that most of them are represented by living species which are evidently their descendants in the Antillean seas, but that several of the Tertiary genera have now completely disappeared from the Caribbean region, and exist only in the Pacific Ocean. The latter must have spread before the Isthmus of Panama arose, and it is

difficult to understand why they survived only on the western side of this barrier of land.

THE *Meteorological Magazine* for June deals with the recent disastrous flood at Louth as completely as possible at the time of going to press, and adds somewhat to the account in NATURE of June 10 (p. 468). The characteristic features are given of the hot weather experienced over England during the last week of May, which occasioned the development of numerous thunderstorms. A disturbance, centred over the Bristol Channel on the morning of May 29, traversed the Midlands during the day. Little or no rain fell on May 29 south of a line passing through Plymouth, Reading, and Lowestoft, and none was observed over the centre and west of Scotland. There was more than an inch of rain over the greater part of Lancashire, the West Riding of Yorkshire, Lincolnshire, and the east of Nottinghamshire. In Lincolnshire the rainfall was very severe. At Louth the fall was only 1.42 in., but at Elkington Hall, three miles to the west, the fall was 4.69 in., and of this 4.59 in. fell in three hours. At Hallington, about two miles south, 4.10 in. fell in two hours, when the gauge overflowed and the exact total fall was lost. Ten miles further south, at Horncastle, 3.95 in. fell in three hours. The magazine states that, according to the Borough Surveyor, the Lud stream, normally 3 ft. wide and 1 ft. deep, was swollen to a width of 52 yards and a depth of 50 ft. It appears that the stream was temporarily blocked with debris, and the flood was the result of the sudden breaking down of this obstacle. The periodical has a very suggestive and useful article on the ventilation of instrument shelters by the Director of Armagh Observatory. The general rainfall for May in England and Wales was 117 per cent. of the average, in Scotland 164 per cent., and in Ireland 145 per cent.

THE report of the Imperial Wireless Telegraph Committee (Cmd. 777, price 6d. net) contains an interesting review of the capabilities of different systems of wireless transmission for long-distance working, and forms a striking vindication of the powers of the thermionic valve, which it is proposed to employ as the sole means of generating the waves required for the chain of stations 2000 miles apart which are recommended. We admire the courage of the Committee in putting forward a system which, in its own words, "departs widely from the general direction of contemporary practice." It admits that "the objects desired might perhaps be secured by other and more conventional methods, but by none, in our opinion, not involving an immediate capital expenditure and a heavy annual loss which the scientific progress of a few years might well prove to have been unnecessary." Discussing the alternative systems, the Committee dismisses even the latest developments of the spark system as obsolete. The high-frequency alternator system it characterises as "costly, difficult to repair, and as yet insufficiently tested in prolonged operation." The arc system is described as "pre-eminent at the present moment among methods of long-range wireless transmission." Arcs of greater power than 250 k.w., however, present elements of uncertainty, and apparently do not deliver

to the aerial a greater effective current than those rated at lower powers. Although the valve system cannot show the same degree of accomplished results as any of the preceding, the Committee has evidence of such rapid advances now being made that it recommends its adoption without hesitation. It has already been found that a group of three glass valves delivering 2½ kw. into the aerial can effect communication over two thousand miles. Silica valves are now designed by means of which, with suitable grouping, 120 kw. will, it is hoped, be delivered into the aerial. Owing to the greater purity of wave-form of valve-generated over arc-generated waves, this arrangement should be considerably more effective than a 250-kw. arc, which does not really deliver more than 120 kw. into the aerial. There are several other advantages for valve working claimed in the report which we have not the space to mention here.

THE deposition of iron by electrolysis is a method which has lately been employed to a considerable extent for the purpose of "building up" worn and under-gauge parts of both aeroplanes and guns. The work, however, has not been done under proper scientific control, and not infrequently defects have manifested themselves in use in the iron thus deposited. A paper dealing with some of these was presented by Mr. W. E. Hughes at the recent meeting of the Iron and Steel Institute. In his capacity as chief research chemist to the Electrometallurgical Committee of the Ministry of Munitions, Mr. Hughes had opportunities of making extended observations upon the structure of the electro-deposited metal. He found that it was liable to contain pinholes, lumps, inclusions of foreign matter, cracks, and "quasi-cracks," and that a given specimen might present very marked differences of structure. He concludes that these defects may render the iron dangerous and unsuitable for engineering purposes, but that they arise from causes which can be largely eliminated by efficient control of the deposition process. It is generally assumed that electrolytic iron is a very pure product, but, as he shows, this is by no means necessarily the case. Further, it is usually assumed to be hard, and may indeed be so, though not always. Whether the hardness, when it occurs, is due to included hydrogen is a question which has not yet been settled. Mr. Hughes's investigation has proceeded sufficiently far for him to entertain decided doubts about this explanation.

MESSRS. DULAU AND CO., LTD., 34 Margaret Street, W.1, have just issued an important catalogue (No. 83) of secondhand books of science in the departments of ornithology, entomology, general zoology, geology and palaeontology, geography, travel, and topography, botany and horticulture. Of the 1256 works listed many are out of print and not easily obtainable. The catalogue can be had free upon request.

ANOTHER of the useful catalogues (No. 403) of Mr. F. Edwards, 83 High Street, Marylebone, W.1, has reached us. It consists of descriptions of some seven hundred works relating to Central and South America, and should be of interest to many readers of NATURE.

**Our Astronomical Column.**

**COMMENCEMENT OF THE GREAT PERSEID SHOWER OF METEORS.**—The first Perseids probably appear at the end of June. They have certainly been observed in the first week of July. The earliest meteor of this shower, which has been doubly observed and the real path of which has been computed, was seen on July 8, 1918, by Mrs. Fiammetta Wilson and Miss A. Grace Cook. This year the moon left the evening sky about July 6, and the sky should be watched for traces of oncoming Perseids. At this time of the year meteors generally increase in numbers, and especially after the middle of July. The Perseids gradually become more abundant, and among the minor displays the chief ones are:

♄ Aquarids ... 338-11	♁ Draconids ... 291+60
♌ Capricornids ... 303-11	♋ Andromedids ... 350+51
♍ Cygnids ... 292+52	♌ Pegasids ... 332+10
♎ Perseids ... 48+44	♍ Cepheids ... 333+71
♏ Cygnids ... 315+48	♎ Lacertids ... 334+51

The radiant point of the Perseids moves N.N.E. as follows:—

July 8 ... 9+46	Aug. 1 ... 33+55
16 ... 16+49	9 ... 43+57½
24 ... 24+52	17 ... 54+59

**THE EXPANDING DISC OF NOVA AQUILÆ.**—Dr. Lunt contributed a paper on this nova to the June meeting of the Royal Astronomical Society which contains some interesting calculations on the rate of expansion. It was written before the recent Lick measures, which indicate a mean annual rate of increase of diameter of 1.9", but he notes that Barnard's measures gave an increase of 2" in the first six months, so that the rate may be diminishing.

Assuming the displacements of the edges of the bands in the spectrum to be a measure of the rate of expansion of the nova into a planetary nebula, Dr. Lunt found a radial velocity of 1500 km./sec., which would give a diameter of 1/100 light-year in a year, and would imply a distance of the nova of 1000 light-years.

According to Van Maanen's parallax of the ring nebula in Lyra (the largest nebula on his list), its diameter is 0.16 light-year. The expanding nova would attain this size in sixteen years if the rate were maintained.

Dr. Lunt notes that in the nova spectrum there are fine dark lines close to the normal positions of the H and K lines of calcium, which indicate a motion of approach to the sun of 17 km./sec., exactly the amount due to the sun's own motion. A similar feature has been noted in several other stars, and the suggestion made that these lines arise from clouds of very tenuous calcium vapour at rest in space. On this view these lines exist in the spectra of most stars, but are hidden by the star's own lines unless the latter are shifted by a large radial motion.

**THE NEW MINOR PLANET GM.**—It will be remembered that last January Señor Comas Sola, of Barcelona, discovered a new minor planet which was much brighter than most of those discovered in recent years, and was taken for a comet by some observers. The object was very well observed for several months, so that an accurate determination of the orbit is possible, and there is not much fear of its being lost again, as has happened to many of these little planets. The discoverer has now given it the name "Alphonsina," in double homage, as he says, to Alphonso X. of Spain, who was known as "the Savant," and to the present king, Alphonso XIII.

**Annual Visitation of the National Physical Laboratory.**

ON the occasion of the visitation of the National Physical Laboratory by the General Board on June 22, a large number of distinguished visitors availed themselves of the opportunity of inspecting the laboratory. The visitors were received by the chairman of the board (Sir Joseph J. Thomson) in the 7-ft. wind channel of the new aeronautics building, and afterwards visited the various departments of the laboratory, where exhibits illustrative of recent work were on view.

The exhibit in the engineering department was noticeable for the large number of machines for testing resistance to shock and to fatigue. The day is past when a simple test in tension is considered to yield sufficient data for structural material, and many other forms of test are now in use. One machine, designed by Dr. B. Haigh, subjects the specimen, by means of an alternating magnetic flux, to a maximum load of ±0.75 ton reversed two thousand times every minute. Another instrument, designed and constructed in the department, tests the endurance of stranded cables passing over pulleys. Among the impact testing machines, many of which were designed and made in the department, mention may be made of one in which both hammer and anvil are swung; by this means it is possible to obtain a striking velocity as high as 43 ft. per second. Machines for measuring the elastic limits of materials at high temperatures and for determining the efficiency of chains, gears, etc., were also among the exhibits.

In the aeronautics department various wind channels were operating, measurements of the performance of air-screws, the effects of aeroplane bodies on screws, and stability tests on bodies being carried out. Apparatus for measuring the skin-friction of air passing over thin plates was also exhibited.

Amongst the exhibits in the metallurgy department were a number of examples of failures of steel and alloy articles which had been sent in for investigation. Photomicrographs illustrating sections from these, as well as various sections under the microscope, were shown.

The representation of the constitution of a series of ternary alloys has never been an easy matter. Three models were exhibited which are designed to overcome this difficulty. They represent parts of the "diagram" for copper-aluminium-zinc alloys and a part of the aluminium-magnesium-silicon "diagram."

Considerable improvement has recently been introduced into the manufacture of thin-walled refractory tubing for thermo-couple protection and insulation; the apparatus with which it is made was shown in operation.

Demonstrations of the rolling of manganin, cast at the laboratory, into rods prior to wire-drawing were given in the rolling mill. Much valuable work has been done, in conjunction with the electricity department, on this metal, and it is now possible to produce manganin wire equal to the best pre-war material which was imported from Germany.

A modified form of the Shakespeare katharometer, used for measuring the permeability of balloon fabric, was in operation in the aeronautical chemistry division.

The exhibits in the Froude national tank can be divided into three heads. The first dealt with tests on the trim, the longitudinal stability, and the resistance of hulls of flying-boats. The second was work which was being carried out for Lloyd's Register in

connection with the design of oil-tankers to determine the stresses in the bulkheads of the oil compartments when the ship is pitching. The effect of varying the frequency of the pitch was studied. Thirdly, an apparatus was shown for testing the effects of a screw propeller working behind a ship. If we know the thrust which the screw must develop, and the velocity of the water behind the ship where the screw is working, relative to the velocity of the ship, then the ordinary data can be used to find the dimensions of screw required for a particular service. The object of the experiments is to find out these two factors.

The heat division of the physics department exhibited, amongst other things, a method of measuring humidity based on the property, shown by dry cotton, of absorbing moisture at a very high rate. Two similar coils of cotton-covered wire, one of which is coated with cellulose, are wound on to a single bobbin and connected up to the two sides of a Wheatstone bridge. They are dried by being inserted into a tube containing  $P_2O_5$ , a current being passed through them at the same time to ensure complete drying. The coils are then drawn out of the drying tube into the atmosphere the humidity of which is to be measured; the cotton on the uncoated wire absorbs moisture with extreme rapidity, which causes a rise in temperature of the wire, thus upsetting the balance of the bridge and deflecting the galvanometer.

Another exhibit consisted of a pointilote lamp for calibrating optical pyrometers. The special feature of this instrument is that the tungsten disc had a tungsten-molybdenum couple fused into it, by means of which it was possible to measure the temperature of the disc.

In the optics division of the physics department an apparatus was shown for measuring the coefficient of expansion of short specimens. It has been used lately for determining the coefficient of expansion of various glasses, and has given very interesting results. Interferometer tests and methods of measuring refractive indices were also shown.

One of the most interesting exhibits in the metrology department was a machine which was constructed to measure accurately to one-millionth of an inch. Slip-gauges are now made accurate to  $1/100,000$  in., and to test them it is advisable to have a machine which can read to one-tenth of this. The machine is used as a comparator, *i.e.* it measures the difference between the standard gauge and the one under test. The chief feature of the instrument is the complete absence of a micrometer head. The magnification is obtained partly mechanically, but mainly by a tilting mirror, which moves the image of a cross wire over a paper scale, giving a magnification such that a movement of  $\frac{1}{4}$  in. over the scale corresponds to a difference in length of  $1/100,000$  in.

Another machine, for comparing end standards with line standards, can be used for lengths up to a metre. An important point about this instrument is that the two standards under comparison are in the same straight line.

A new type of micrometer for measuring the diameter of small balls, rollers, etc., was also shown, in which the readings are made on two parallel circles, one of which drives the other through epicyclic gearing; tenths and hundredths of an inch are read on one circle, and thousandths, ten-thousandths, and, by estimation, hundred-thousandths on the other. Both sets of readings are in line with each other, making the instrument very rapid to read. The position of contact is found by means of a small mirror moved by the tail-stock of the instrument.

The list of exhibits in the electricity department was

large and interesting, but there is only space for reference to a very few of them. A considerable number dealt with photometry. Others were concerned with the temperature coefficient of manganin, with the measurement of frequency, efficiency, amplifying power, and characteristics of electric valves, and with a selenium-cell current regulator.

### The Carnegie Foundation and Teachers' Pensions.<sup>1</sup>

TEACHERS' pension controversies are not confined to England. All our recent discussions of this subject have their counterparts in the United States, but there they are immensely complicated by the lack of co-ordination between the different States of the Union. Great diversity exists between the school pension systems which have been adopted or are under consideration, and no attempt seems to be made to bring them into relation one with another.

The universities and colleges (or such of them as are admitted into association), are the special province of the Carnegie Foundation for the Advancement of Teaching, and the fourteenth report of this body contains evidence of work of great value. Beginning in 1905 with an initial benefaction of ten million dollars, the endowment administered by the trustees has been increased by later gifts and accumulated interest to more than twenty millions. The object of the founder was to provide retiring pensions for teachers in universities, colleges, and technical schools in the United States, Canada, and Newfoundland "without regard to race, sex, creed, or colour"; but the granting of pensions does not by any means represent the whole of the activities of the trustees. To enable them to discharge effectively the duty laid upon them, they have felt compelled to conduct many inquiries and, when necessary, to offer fearless criticisms, and by these means they have undoubtedly exercised a powerful influence on the quality of higher education in America.

During the year 1918-19 the trustees disbursed in retiring and widows' allowances a sum of more than eight hundred thousand dollars. But in that year the old plan of granting such allowances was definitely abandoned in favour of a scheme under which the teacher himself is called upon to contribute towards the provision for his own retirement. It is of special interest to observe that, at the time when we in this country were adopting for school-teachers a national pension system on a non-contributory basis, which many university teachers wish to be extended to themselves, the Carnegie Foundation had come to the conclusion, as a result of thirteen years' experience, that a "free pension" could not be a solution of the problem in a democratic country, but that the system must be contractual and rest upon the co-operation of the teacher and his college. This method, in the opinion of the trustees, is the only one that is "just, feasible, and permanent." To this end they organised a Teachers' Insurance and Annuity Association, in the control of which the teachers themselves will have real representation, and invited the universities and colleges to adopt pension schemes based on joint contributions by the teacher and his institution and worked by means of policies issued by the new association. The trustees continue the system of free pensions for those who were in the service of associated institutions before a certain date, but for others will content themselves with the pro-

<sup>1</sup> Carnegie Foundation for the Advancement of Teaching, Fourteenth Annual Report of the Chairman and of the Treasurer. (New York, 1919.)



vision of disablement allowances and the guarantee of a certain rate of interest on policies issued by the association.

We see, therefore, that, through the administration of a great private benefaction, there has been evolved in America a pension system which in general form is not dissimilar from the Federated Superannuation System for Universities and University Colleges in this country. There are, however, important differences. Whereas our federated system is in all essentials applied uniformly throughout the institutions concerned, the new system in America is subject to a variety of conditions as to the rate of contribution, the grades of staff admitted, and other qualifications as to length of service and amount of salary. Also, while some institutions make entrance to the scheme compulsory on all members of certain grades of staff, others leave it entirely to the option of the individuals. So long as this lack of uniformity continues, the simplicity of transfer from one institution to another, so valuable a feature of the English system, can scarcely be secured. It is further to be observed that the rate of contribution of the American college is never more than 5 per cent., as compared with the 10 per cent. now generally given by the English university; but against this must be put the fact that the policies issued by the American Teachers' Association are a little more generous in their terms than those of the insurance companies in our federated system.

A particularly useful section of the fourteenth report of the Foundation is that which deals with current pension problems both in America and in this country. It is here that we are most impressed with the almost chaotic condition of the pension arrangements in America as a result of the diversity of the State systems; but we are bound, on the other hand, to confess that our own Fisher scheme, while admitted to be generous, comes in for severe criticism, especially on account of its non-contributory basis and of the alleged weakness of the arguments used to support the adoption of a scheme of that character. Indeed, throughout the report the virtues of the contributory plan are urged repeatedly and with great insistence, and we cannot dismiss lightly the opinions of an authority occupying the unique position of the Carnegie Foundation. Though perhaps not within the sphere of immediate practical politics, it is legitimate to conjecture whether greater advantage would not result from a contributory system of pensions applied to the whole of our teaching profession than from a non-contributory system granted to a part of it. By the former plan we should recognise the essential unity of a great profession; by the latter we tend to separate it into parts and hamper the free interchange of teachers between one institution and another.

Those who are concerned in unravelling the knots in our own pension systems will find much suggestive material in this and previous reports of the Carnegie Foundation. But it is gratifying to feel that without the colossal munificence of a Carnegie we have yet reached a position which, with all its weaknesses, is still in many ways far in advance of that occupied by our Transatlantic cousins. Though we may regret lost opportunities, we realise that in a comparative sense we are not so badly off as we thought, and we are led to ask ourselves whether, after all, the scheme inspired by Sir William McCormick's Committee and designed by our universities in co-operation does not represent the best thing so far done in the matter of teachers' pensions.

In addition to its achievements in the pensions field, a valuable series of educational reports stands to the credit of the Carnegie Foundation. Under this

head the papers contained in the fourteenth report on current tendencies in education, on legal education, and on the training of teachers are worthy of notice, though perhaps not so much for their discovery of new ideas as for their clear exposition of accepted principles and their straightforward description of the good and the bad in existing practice.

## National Food Consumption in the United States.

PROF. RAYMOND PEARL has contributed to the Proceedings of the American Philosophical Society (vol. lviii., 1919, p. 182) an instructive article upon the consumption of foodstuffs in America from 1911 to 1918. He distinguishes between (1) primary foods, such as plant materials directly consumable by man, or animals not nourished upon primary foodstuffs, and (2) secondary foods, which cover the edible products of animals nourished upon primary foodstuffs. The necessary deductions were made for loss in storage, transit, etc., and for inedible refuse. The statistics are expressed in terms of metric tons of proteins, carbohydrates, and fats, and also in terms of Calories.

Broadly speaking, the salient feature of the analysis is the uniformity of consumption from year to year. The greatest relative advance (relative, that is, to the increase of population) was in the consumption of fat, the least in the consumption of protein, but the deviations from the line of increasing population are small.

Turning to the sources, it appears that 47 per cent. of the protein is derived from primary, and 53 per cent. from secondary, foods. Of fats, 82 per cent. are derived from secondary sources, while 95 per cent. of the carbohydrates come from primary sources. In terms of Calories, 61 per cent. of the intake is from primary foodstuffs.

These figures are not greatly different from the British returns analysed by the Food (War) Committee of the Royal Society. We derived 42 per cent. of our protein, 92 per cent. of our fat, and 35 per cent. of our energy from secondary sources. Put otherwise, we get fewer Calories and less protein, but more fat, from animal sources (exclusive of fish, which comes under primary sources in Prof. Pearl's classification) than the Americans. We should, perhaps, use the past tense in this comparison, since the British data do not refer to existing conditions.

Thirty-six per cent. of the American intake of protein is in the form of grain, 26 per cent. in meats, and 20 per cent. in dairy products. Of fat, 51 per cent. is furnished by meats, 27 per cent. by dairy products, and 12 per cent. by vegetable oils and nuts. Of carbohydrates, 56 per cent. is furnished by grains and 26 per cent. by sugars. Of total energy, 35 per cent. comes from grains, 22 per cent. from meats, 15 per cent. from dairy products, and 13 per cent. from sugars. These four groups contribute 85 per cent. of the total energy value.

The effects of the food economy campaign and the food administration in 1917-18 are of interest. The total consumption of food increased, but not in proportion to the population; the consumption of meat practically did not increase at all, and the consumption of grain only 1 per cent. The great increases were in the consumption of vegetables, of oils and nuts, and of oleomargarine, amounting respectively to 30 per cent., 29 per cent., and 116 per cent. over the averages of the preceding six years. The increase in the two former groups may have been due to the activity of

the Food Administration in urging the consumption of these commodities to relieve the pressure upon wheat and animal products. The increased consumption of oleomargarine was no doubt due to a favourable price in comparison with that of butter and lard.

Prof. Pearl provides a summary of daily consumption per "man," which again brings out the uniformity from year to year. The largest figure is 4361 Calories in 1913-14, and the smallest 4211 in 1916-17. The average figures are: 121 grams of protein, 169 grams of fat, and 542 grams of carbohydrate, yielding 4290 Calories. Assuming that 5 per cent. of protein, 20 per cent. of carbohydrate, and 25 per cent. of fat are lost in the wastage of edible substances, the *per capita* average of ingested food becomes:—Protein, 114 grams; fat, 127 grams; and carbohydrate, 433 grams, yielding 3424 Calories. These final figures are in good accord with the results of dietetic studies both in America and in England. Prof. Pearl justly remarks that "discussions of the minimum protein, fat, and carbohydrate requirements of a nation are in a considerable degree academic if they base themselves upon net consumption rather than gross consumption. A considerable excess over any agreed-upon minimum physiological requirements must always be allowed, because there will inevitably be, in fact, a margin between actual gross consumption and net physiological ingestion or utilisation."

The report is a useful contribution to knowledge. It is to be feared that since the armistice little attention has been devoted to the study of national dietetics in this country. During the war British physiologists made valuable experimental and statistical contributions to the subject; on the statistical side the work of the late Sir William Thompson, and on the experimental side that of Prof. Cathcart and his collaborators, deserve special mention. It is to be regretted that there is little prospect of the foundations then laid being built upon; it will be long indeed before the task of feeding the nation ceases to cause anxiety and to merit scientific elucidation.

M. G.

### Engineering Research in the U.S.A.

THE problem of co-ordinating the interests and activities of the various engineering institutions and societies has been subject to much discussion in this country. In America this problem was largely solved by the establishment in 1904 of the United Engineering Society, which combined the interests of four founders' societies, namely, the American Society of Civil Engineers and the American Institutes of Mining and Metallurgical Engineers, Mechanical Engineers, and Electrical Engineers. The United Engineering Society now numbers some forty thousand members, and its administration comprises three principal departments, namely, the library board, the engineering council, and the engineering foundation. The last-named department is of particular interest, and is directed to the furtherance of research in science and engineering.

The engineering foundation was established as a result of a gift of 200,000 dollars by Mr. Ambrose Swasey, this sum being used as the nucleus of a fund the income of which was to be devoted to research or for the advancement in any other manner of the profession of engineering and the good of mankind. This first gift was made in 1914, and in September, 1918, Mr. Swasey added a further sum of 100,000 dollars to the endowment.

The donor is an engineer and manufacturer, and president of the Warner-Swasey Co., of Cleveland, Ohio, a firm manufacturing fine tools and astro-

nomical and other instruments of precision. Mr. Swasey is a member of most of the American engineering societies, and of several English scientific societies, including the Royal Astronomical Society. He is the author of a number of papers read before American engineering societies.

For all practical purposes the engineering foundation is a professional trust organised along the lines of the Carnegie, Rockefeller, and Sage foundations. The facilities it provides have heretofore been devoted principally to engineering research, and its most notable work has been conducted through co-operation with the National Research Council, which is an organisation of men of science, engineers, and educators brought into being by the National Academy of Science at the request of President Wilson in 1916, and employed largely in the conduct of scientific investigations relating to anti-submarine and other war problems.

When the National Research Council was formed the administrators of the engineering foundation made themselves responsible for its financial support for a period of one year, and this brought into successful co-operation a body of engineering and scientific men in a comprehensive and practical manner.

Since July, 1919, the research work undertaken by the foundation has been of a very comprehensive nature. It has included, for example, preliminary researches on such subjects as a new hardness testing machine, the elimination of casting defects from steel, the uses of cadmium, the uses of alloy steels, Neumann bands in iron and steel, the heat treatment of carbon steel, electrical insulation, and substitute deoxidisers. A sum of 15,000 dollars a year for a period of two years has been voted for the conduct of research in the fatigue phenomena of metals in the laboratories of the engineering experiment station of the University of Illinois. From approximately fifty suggested subjects, the engineering foundation has also selected for investigation: (1) The wear of gears, (2) spray camouflage for ships, (3) the directive control of wireless communication, (4) weirs for the measurement of water, (5) the establishment of a testing station for large water-wheels and other large hydraulic equipment, and (6) the mental hygiene of industry.

These investigations are now all in progress or have been completed. Particular attention has been given to research relating to mental hygiene in industry, the objects of the research being to develop or discover methods for adapting psychopathic individuals to usefulness in industry.

Realising, further, that mental hygiene dealt with only one of the many elements of the industrial *personnel* problem, the foundation board, in association with the National Research Council, arranged for the appointment of a committee representative of anthropology, psychology, educational relations, industrial relations, engineering, and medicine to consider means for furthering the study of the problems of industrial employment.

Quite apart from such efforts, the engineering foundation has interested itself in an attempt to co-ordinate the activities of many of the very numerous societies and associations, some local, some national, having a bearing on engineering, and to harmonise their relations and aims. Up to the present, however, no active investigational work along these lines has been undertaken. While the foundation maintains the closest relationship with the divisions of engineering of the United Engineering Society and the National Research Council, it reserves the right to conduct under its own immediate direction such researches as may commend themselves to its membership.

The administration of the engineering foundation is conducted by sixteen members elected by the United Engineering Society, thirteen of whom must be members of the founder societies. Although finally organised only in the early part of 1915, the foundation has become thoroughly established, and is carrying on a most admirable work.

A. P. M. FLEMING.

### African Softwoods for Pulp Production.

By A. H. UNWIN,

Late Senior Conservator of Forests, Nigeria.

ABOUT the year 1907, at the instigation of the late Sir Alfred Jones, an inquiry was addressed to the West African Colonies with regard to the softwoods suitable for paper or pulp production. As a result a list was compiled for the Benin country, which included some twenty species of whitewood. Since that date little or nothing has been done towards the solution of this problem. Nevertheless, much greater knowledge has been obtained of the softwoods of the West African Colonies—the Gambia, Sierra Leone, Gold Coast, Nigeria—and of West Africa generally.

Although baobab (*Andansonia digitata*) has been suggested as suitable, it is usually found rather remote from navigable waterways, and in such scattered quantities that it is doubtful if its exploitation will pay. On the other hand, the wood of the cotton-tree, *Eriodendron afrocarpum* and *E. orientale*, has been adversely reported upon, but it does not appear that very exhaustive experiments were made with either of these species. The ease of its production, the rapidity of its growth, and the softness of its wood would seem to commend the cotton-tree for pulp production. The wood of *Bombax buonopozense* may also be of use.

Perhaps a more suitable wood will be obtained from the African maple, *Triplochiton johnsonii* and *T. nigericum*. The wood of both these species is of about the same hardness as that of spruce. It is of a similar colour, and the fibres are long. The tree is very prevalent, its reproduction easy in the proper localities, and its growth rapid. On average soil the trees reach pulp-wood size within ten years, and there are many specimens even in seven years.

In certain localities the occurrence of *Sterculia Barteri* is such as to redden the hill-sides with its flowers in March. The growth of the tree is very rapid, and the wood is fibrous and porous. The tree will attain pulp-wood size in five years. In suitable localities the natural reproduction from mature trees is rapidly filling the whole forest.

Other *Sterculia*, such as *tomentosa*, *rhinopetala*, and *tracacantha*, might be used. Of these the last-named appears to be the most suitable. It is also very prevalent, and grows rapidly. The wood of *Sterculia rhinopetala* may prove to be a little hard, but with modern means of pulping it may be possible to use all these species at the same time.

The quantity of bamboo on the West Coast of Africa is negligible, though the area of its distribution is gradually widening.

The Albizzias usually produce in their younger stages a whitish-yellow softwood. Most species grow very fast, and would yield pulp-wood within ten years. The wood shows long fibres. Owing to the prevalence of the tree in the forests, there would be no difficulty as to the quantity. The wood of *Terminalia superba* should prove of value, though its brownish tinge may have to be removed in order to make the best-coloured pulp. It is prevalent and its growth is rapid.

Another very common tree is *Alstonia congensis*,

which is often found in the swamps as well as in the moist forests. Its growth is very rapid, and it would yield pulp-wood in seven years. Owing to its prevalence, this softwood with its longish fibre, should prove of value.

The wood of *Ricinodendron Heudelottii* appears to be suitable, though the colour is dull grey-brown. The tree is very prevalent, and its natural regeneration prolific. It reaches pulp-wood size within a period of seven to ten years. *Pycnanthus kombo* is another tree which appears to yield a suitable species of timber. It is very prevalent, the wood is soft and fibrous, and natural reproduction is great. Even the much-despised *Musanga Smithii* might on occasion be used to supplement inadequate supplies of other pulp-wood timbers. Near the rivers in some districts there is a common tree named Otu, which is planted by the natives. It yields a soft whitewood which has a longish fibre.

With the great shortage of paper-pulp it appears that the utilisation of these West African species of trees should be undertaken as soon as possible. Naturally, it will mean a good deal of experimental work, but with the experience already gained in Canada and Norway and Sweden it should be possible to produce pulp below existing cost. Although African labour is expensive as compared with Indian or Burman, it has proved itself thoroughly adaptable to training in the use of complicated machinery such as that employed in shipbuilding and in oil- and saw-mills.

With a population of about sixteen millions of people in Nigeria alone, it has been found possible gradually to obtain sufficient men for a new industry.

### Effect of Topography on Precipitation in Japan.

CONSIDERABLE attention has been directed recently to the subject of the orographical distribution of rainfall, and results obtained in different places are liable to lead to general deductions, not only independent, if not quite contradictory, but also, on the face of them, improbable. We may instance an alleged connection between Indian monsoon intensity and the extent of local water surfaces, and also M. Mathias' cartographical demonstration that the increase of precipitation with altitude is directly dependent on the latitude, at any rate in France. Mr. Carle Salter's lecture to the Institution of Water Engineers on the relation of rainfall to configuration gave little ground for suspecting either of these possibilities.

At first sight, Prof. Terada's contribution in the Journal of the College of Science, Tokyo Imperial University (vol. xli., art. 5), appears to be only a supplement to previous work of Profs. Nakamura and Fujiwhara, but one or two comparatively fresh notes are struck. Prof. Omori had previously found a correlation between earthquake frequency in some districts and precipitation in others. This is now described by Prof. Terada as a case more of parallelism than of cause and effect, for he prefers to attribute both phenomena to barometric changes rather than to associate the instability of the soil with percolation. His main purpose, however, is to study the effect of the discontinuity of wind velocity on land and sea, and for this purpose he divides Japan into six districts, three facing the ocean and three the Japan Sea, and in each district chooses two or three stations near the coast.

The three "ocean" divisions show a marked increase in rainfall with decreasing latitude, but on the con-

tinental side the middle section is the wettest. Moreover, taking the divisions in pairs, there is a marked difference in the comparison. In the northern and central pairs the "continental" section is the drier, while in the remaining pair the difference is greater and also reversed in sign. Prof. Terada connects this anomaly with a possible "centre of action" controlled by the position of the Korean promontory, but it seems to be quite possible that he has overlooked the probable effect of the contour of the land itself. A glance at the map will show that his southernmost "ocean" division is practically outside the main island, which includes the northern and central divisions and the greater part of the continental southern division, so that we should naturally expect some sort of anomaly in that region, apart from the fact that the vertebral line of division, which is not far from a meridian in the north, tends to become more nearly a parallel in the south.

The author has adopted a good plan in using percentages instead of totals to prevent undue emphasis being placed on the wettest periods and places.

W. W. B.

### Economic Entomology in the Philippines.<sup>1</sup>

A CONSIDERABLE portion of the Bulletin before us is the outcome of work undertaken with the definitely economic object of procuring and transporting to the battlefield natural enemies of the beetle *Anomala orientalis*, which, by reason of the havoc wrought in the larval stage on the roots of the sugarcane, is a serious pest in the plantations, and was causing heavy losses in the Island of Oahu, Hawaii. It is gratifying to learn that the quest of the entomologists was entirely successful, and that through their labours the foe appears to have been vanquished, and thereby all mankind benefited in the saving of large quantities of one of our most valuable articles of food. The ally which the entomological staff summoned to the aid of the sugar-planters was the "wasp" *Scolia manilae*. It is perhaps prudent here to indicate that the term "wasp studies" must not be understood to apply solely to the true Dipterous wasps, the Vespidae; it is used in this publication as a convenient term including many families of aculeate Hymenoptera other than the bees.

*Scolia manilae* is a small black and yellow wasp that occurs abundantly in the Philippines. The females possess the power of detecting the presence of certain subterranean beetle grubs, and, having located their victim, dig down to it and deposit on its ventral surface an egg from which there soon emerges a larva that devours the beetle grub. The plan of campaign was simple. At Los Baños quantities of females of *Scolia manilae* were captured and placed in suitable vessels in which had been placed beetle grubs of appropriate age, and a sprig of foliage moistened with water and honey for the personal benefit of the wasps. Most of the grubs duly received an egg; those so favoured were placed in clay cells which were packed in soil in a tightly closed can, and then shipped to Oahu. Here the *Scolia* of the next generation emerged and were liberated. They established themselves with such success and increased so rapidly that they are now more abundant near Honolulu than at their native place, Los Baños, while the pest

*Anomala orientalis* is vanishing so satisfactorily as to cause wonder how the wasp maintains itself.

The authors describe and figure twenty-six new species belonging to several different families of "wasps"; and the bionomics of these and others are narrated with great detail by Dr. Williams. His observations show that many species of these "wasps" are of economic importance in keeping in check the numbers of harmful insects, and suggest that an important line of research is here open to the field-naturalist. From the purely scientific point of view, perhaps the most interesting feature of the Bulletin is the frequency with which instincts and behaviour that are characteristic of the most highly developed social wasps manifest themselves sporadically and in an incipient fashion among these solitary species. So much is this the case that it becomes almost possible to construct a gradually ascending series from the simplest to the most highly specialised. Commencing with species that differ but little in habits from the Ichneumonidae, stinging and only temporarily paralysing their victim in order the better to attach their egg, but constructing no nest or burrow of any description, we may pass on to those that dig burrows or build nests either unaided or in company with a few other individuals, and reach the climax in the elaborate domestic arrangements and architecture of our familiar social wasps and hornets. O. H. L.

### Climate of the Netherlands.

THE Royal Netherlands Meteorological Institute has recently issued, as publication No. 102, "The Climate of the Netherlands with Respect to Air Temperature," by Dr. Ch. M. A. Hartman. Many years have elapsed since any previous discussion of air temperature in the Netherlands was undertaken. The stations yielding observations only for recent years have been compared with the stations available for longer periods, by which, together with the aid of stations affording hourly observations, special corrections have been found for each month and for each station required to secure the true temperature from observations at the hours of 8, 2, and 7. At Zwanenburg, situated midway between Amsterdam and Haarlem, there is a series of observations from 1743 to 1860, and at De Bilt observations are available from 1849 to 1917. The annual variation is given for twenty-four years from 1894 to 1917 inclusive at twelve stations; the range of temperature varies with latitude and with an increased distance from the sea. Diurnal variation is much affected by the influence of the sea, which suggests the difficulty of obtaining a true mean temperature from a combination of, say, three hours, 8, 2, and 7, and of maintaining the same hours in winter and in summer, but a change of hours is recognised as not practicable. The highest temperatures observed are 90° F. and 97° F. at Maestricht respectively on August 4, 1857, and July 28, 1911, and 97° F. at Oudenbosch on June 8, 1915. The lowest readings are -8° F. at Winterswijk on February 7, 1895, and at Katwijk-on-Rhine on February 14, 1895. Frequency of different temperatures is given for several stations and for all months, and the occurrences of diurnal variations of temperature for each degree Centigrade are tabulated, also the diurnal range for each of the twenty-four hours. One of the many tables shows the temperatures which occur each month, with the different directions of the wind.

<sup>1</sup> "Philippine Wasp Studies." Part I., Description of New Species. By S. A. Rohwer. Part II., Descriptions of New Species and Life-history Studies. By F. X. Williams. Report of Work of the Experiment Station of the Hawaiian Sugar Planters' Association. Entomological Series. Bulletin No. 14. Pp. 186+106 figs. (Honolulu, December, 1919.)

## The Present Condition of the Aborigines of Central Australia.

INFORMATION lately received in this country discloses an appalling condition of affairs among the aborigines of the interior of Australia. The whole population is thoroughly polluted with disease, both tubercular and venereal, and the north-eastern tribes are doomed. It is anticipated that another ten years will see the last of such interesting tribes as the Dieri, Yanntowanta, Ngameni, and Nauroworka. This is largely due to contact with the lower elements of European and immigrant Asiatic civilisation. Misdirected kindness, however, is also, to some extent, responsible. A liberal supply of Government blankets has been distributed among the tribes; they wear the blankets when working in the sun, and then, when thoroughly overheated, sleep on the ground; pneumonia follows as a natural consequence. Another cause of their disappearance is due to the difficulties attendant on food-supply. The game on which they subsist is killed off or driven away by the encroachment of civilisation. Distress from this cause has recently been aggravated by severe drought. The extent of the ravages arising from these various causes may be gauged by the fact that half a century ago it was estimated that there were 12,000 aborigines within 180 miles north and 200 miles east of Adelaide, and now there are not more than about 120 in that area. In the early eighties of last century Gason stated that if steps were not taken, multiplication of the aborigines would result in the disappearance of the European population, yet in this same area of which he wrote it is now estimated that at the outside there are not more than 2000.

The deplorable condition of the aboriginal population was discovered owing to the fact that during the war a number of expeditions were sent out to Central and Northern Australia in connection with the search for minerals for use in munition work. Dr. Herbert Basedow, a Protector of Aborigines in the service of the South Australian Government, who was a member of several of these expeditions, was then brought into close contact with the tribes. On his return to Adelaide at the end of the war he endeavoured to arouse the public conscience by a meeting in the Town Hall, at which he gave an undisguised account of what he had seen. As a result 500*l.* has been subscribed, and an equal amount promised by the Government, for the provision of medical relief. This sum has enabled Dr. Basedow to get together a small relief party. His first expedition on this work followed the course of the Strzelecki to Innamincka, thence along the Cooper, across the boundary into Queensland. Recrossing the border, the party visited Cordillo, Cadelga, Ringamurra, and Birdsville, thence following the Diamantina to Hergott Springs. One of the severest droughts on record was raging at the time; the heat was terrific—the average temperature was 116°–118° F.—and sand-storms blew for forty-eight hours at a time. No fewer than seven horses were abandoned exhausted along the route from Diamantina to Hergott Springs. The condition of the aborigines along the route is described by Dr. Basedow as "shocking." Dr. Basedow has recently started on another expedition, on which he proposes to proceed along the head of the Australian Bight as far as Eucla, along the Nullarbi Plains to Port Augusta, thence northwards to Oodnadatta, and across the boundary to the McDonnell Ranges.

Valuable as is such provision of medical relief as is possible by these expeditions, it is obviously only a temporary palliative. One of the most effective of the measures adopted for the assistance of the aborigines,

whether directly under State protection or not, in the neighbouring State of Western Australia has been the establishment by the Government of a regular medical service. Further, while undesirable Europeans and Asiatics are permitted to mingle without control with the natives, it is inevitable that diseases will continue their ravages unchecked. A movement, which is receiving influential support, has been set on foot to induce the Government of South Australia to proclaim the north-west corner of the State, including the Musgrave, Mann, and Tomkinson Ranges, as an absolute reservation. It is hoped that it may also be possible to secure from the Commonwealth and the Western Australian Governments the proclamation of the adjoining ranges of the Northern Territory and Western Australia as strict reservations. This will probably be the last chance of preserving the Central Australian tribes from complete extinction.

E. N. FALLAZ.

## University and Educational Intelligence.

CAMBRIDGE.—Dr. Shillington Scales has been appointed University lecturer in medical radiology and electrology, and Mr. F. Lavington, Emmanuel College, Girdlers' lecturer in economics. Mr. J. Chadwick, Gonville and Caius College, has been elected to the Clerk Maxwell scholarship in experimental physics; Mr. H. F. Holden, St. John's College, to the Benn W. Levy research studentship in biochemistry; and Mr. A. J. Beamish, of Corpus Christi College, to the Wrenbury scholarship in economics.

The Marshall herbarium, comprising 23,000 sheets of British plants contained in dustproof oak cases, has been bequeathed to the University by the late Rev. E. S. Marshall, a keen and able field botanist, "unsurpassed as a collection of the critical flowering plants both in point of the number of interesting things he found and the care and industry he showed in selecting and pressing specimens of them."

EDINBURGH.—The foundation-stone of the new University buildings was laid by the King on Tuesday last, and the Queen accepted the honorary degree of LL.D.

LIVERPOOL.—The King, on the recommendation of the Chancellor and Council of the Duchy of Lancaster, has contributed 100 guineas to the appeal fund.

SHEFFIELD.—Dr. W. E. S. Turner has been appointed professor of glass technology, Mr. J. Husband professor of civil engineering, Dr. Mellanby professor of pharmacology, and Mr. R. E. Pleasance demonstrator in pathology.

By an inadvertence these appointments were given in NATURE of June 24 under the heading "Leeds."

PROF. F. FRANCIS has been appointed Pro-Vice-Chancellor of the University of Bristol in succession to Prof. Lloyd Morgan, who is about to resign the office.

DR. O. C. BRADLEY, principal of the Royal (Dick) Veterinary College, Edinburgh, has been elected president of the Royal College of Veterinary Surgeons in succession to Mr. J. McKinna.

A SCHOOL of medicine, surgery, and dentistry in connection with the University of Rochester, New York, has received an endowment of 1,800,000*l.* from the U.S. General Education Board and Mr. G. Eastman, of the Eastman Kodak Co. The contribution of the Board is 1,000,000*l.*, and that of Mr. Eastman 800,000*l.*

THE Eugenics Education Society has arranged for the holding of a summer school of eugenics and civics at Herne Bay College on July 31-August 14. The inaugural address will be delivered by Prof. A. Dendy on "Evolution in Human Progress," and there will be lectures and discussions on heredity, biology, eugenics, and sociology. The address of the society is 11 Lincoln's Inn Fields, W.C.2.

A SUMMER school of civics is to be held, under the auspices of the Civic Education League, at the Technical Institute, High Wycombe, Bucks, on July 31 to August 14. There are to be lectures on maternity and child welfare work, analytical psychology, and reconstruction problems; and courses on civics, sex education, local and central government, and anthropology have been arranged for. Further particulars can be obtained from the Secretary, Summer School of Civics, Leplay House, 65 Belgrave Road, S.W.1.

AN important American academic change is announced in the simultaneous resignations of Dr. G. Stanley Hall as president of Clark University and of Dr. Edmund C. Sanford as president of Clark College, and the appointment of Dr. Wallace W. Atwood as single head of both the University and the college. Dr. Atwood has been professor of physiography at Harvard since 1913, and is at present in the West in charge of a field expedition for the U.S. Geological Survey. In addition to his executive position, he will occupy the chair of regional and physical geography at Clark University. Dr. Stanley Hall is retiring in order that he may devote his whole time to the completion of several books on psychology which he has had in hand for a considerable period. Dr. Sanford will take the chair of psychology at Clark University, which Dr. Stanley Hall is vacating together with the presidency.

We learn from *Science* that the following appropriations have recently been made by the U.S. General Education Board:—To the Washington University Medical School, St. Louis: For endowment, 250,000.; for additional laboratory facilities and equipment, 14,000. To Yale Medical School: For endowment (towards a total of 600,000.), 200,000. To Harvard Medical School: For improved facilities in obstetrics, 60,000.; for the development of teaching in psychiatry, 70,000. To Johns Hopkins Medical School: For development of a new department of pathology (towards a total of 120,000.), 8000. From the same source we learn that the Rockefeller Foundation has made appropriations as follow:—To Dalhousie University Medical School, Halifax: For buildings and equipment, 80,000.; for endowments, 20,000. To the Medical Research Foundation of Elisabeth, Queen of the Belgians, Brussels: For general purposes of medical research, 1,000,000 francs.

THE frontier between school and university has recently been the subject of much discussion. The Prime Minister's Committee on Science recommended that eighteen should be the normal age of entry from secondary schools to the universities, and in making that recommendation it was supported by all the witnesses who gave evidence on the subject. The Board of Education, by its efforts to standardise the Second School Examinations, and by watching the advanced courses given in schools, has done much to direct the studies of those who really are in the post-matriculation stage while at school; and the universities are faced, more than ever before, by the problem of how to arrange for students who enter with wide differences of attainment. There is but one solution: elasticity of organisation, both in the matter of examinations and in that of prescribed courses.

During the past year a consultative council, on which were representatives of seven universities and four associations of school teachers, has been formed by the Association of Science Teachers in order to discuss the overlapping of school and university training. As a result, a resolution was sent to the various universities urging them "to recognise the value of the post-matriculation work in efficient schools by accepting the passing in subjects in one of the approved Second School Examinations as exempting from the corresponding subjects in the Intermediate Examination and the first Medical Examination of the University." The Association of Science Teachers is to be congratulated on organising the discussions which have led to this expression of opinion by a body well constituted to view the situation from opposite sides.

## Societies and Academies.

LONDON.

**Faraday Society, June 14.**—Prof. A. W. Porter, vice-president, in the chair.—Dr. A. Fleck and T. Wallace: Conduction of electricity through fused sodium hydrate. The resistance to the passage of current through fused caustic soda and its rate of change with temperature have been examined by a direct-current method. In view of the difficulties of containing the soda in a non-conducting non-porous vessel, the experiments have been carried out in the centre of a large mass of soda. The decomposition voltage has been studied and found to be a variable quantity, decreasing at the rate of  $2.25 \times 10^{-3}$  volts per degree Centigrade rise in temperature. This figure differs from the previously published figure of  $2.95 \times 10^{-3}$ . It has been found that when a current is passed through fused sodium hydrate between two sodium electrodes the current is always proportional to the applied E.M.F.—Dr. H. F. Haworth: The measurement of electrolytic resistances using alternating currents. An electrolytic cell acts like a capacity in series with a resistance. If this capacity and resistance be measured at various frequencies, they will be found to vary with the frequency. If the impedance of the cell is plotted vectorially with respect to the resistance for various frequencies, the locus is a straight line which cuts the resistance axis at infinite frequency. This gives the true resistance of the electrolyte.—J. L. Haughton: The measurement of electrical conductivity in metals and alloys at high temperatures. The study of the electrical conductivity of alloys has generally been carried out by measuring the conductivity of the alloys at room-temperature and plotting a curve connecting conductivity with composition, but much valuable information can be obtained by plotting the curve connecting the composition and temperature and using a series of such curves in the same way as the ordinary thermal curves. The paper describes a method which can be employed for this.—N. V. S. Knibbs and H. Palfreeman: The theory of electro-chemical chlorate and perchlorate formation. This paper is the outcome of a study of the electrolytic formation of chlorate and perchlorate based on recent large-scale operations. It aims at a presentation of the theory of the mechanism of chlorate and perchlorate formation and its application to their technical production. A series of investigations was undertaken in order to elucidate a number of doubtful points and to obtain data which were of importance in the technical control of the process.—J. B. Firth: Sorption of iodine by carbon. The sorption of iodine by carbon was studied over a period of five years; the forms of carbon used were lamp-black, blood carbon, sugar carbon, animal carbon,

coconut carbon from shell, and coconut carbon from fruit. The solvents used were chloroform and benzene. The activity of the carbon was shown to depend on its previous treatment. In all cases a rapid condensation takes place in the first few minutes, followed by a much slower sorption, which may continue for several years. The influence of the size of the carbon particles was also studied.—**F. H. Jeffery**: Electrolysis of solutions of sodium nitrite using a copper anode.—**Dr. A. M. Williams**: The pressure variation of equilibrium constant in dilute solution. The apparent discrepancy between the expressions of Planck and Rice rests on a misinterpretation of the latter's symbols. Another deduction is given.—**Miss Nina Hosali**: Models illustrating crystalline form and symmetry.

**Linnean Society, June 17.**—**Dr. A. Smith Woodward**, president, in the chair.—(The centenary of the death of Sir Joseph Banks.)—**Dr. B. Daydon Jackson**: Banks as a traveller.—**Dr. A. B. Rendle**: Banks as a patron of science.—**J. Britten**: Banks as a botanist.—**Dr. A. Smith Woodward**: Banks as a trustee of the British Museum of paramount power.

June 24.—**Dr. A. Smith Woodward**, president, in the chair.—**Dr. C. J. F. Skottsberg**: Botanical features of the Juan Fernandez group of islands.—**Dr. R. J. Tillyard**: The Cawthron Institute. This institute is to be situated in the city of Nelson, N.Z. An account was given of the early life and adventures of the founder, showing how he rose from a low estate to become a very wealthy man. In his later years he busied himself with philanthropic enterprises, and on his death it was found that he had left the greater portion of his fortune for the purpose of founding an institute of scientific research. After all claims had been paid, the Cawthron Trust was left with a capital of about 200,000*l.*, which, wisely invested, would yield an income of about 11,000*l.* a year. **Prof. T. H. Easterfield**, of Wellington, N.Z., has been appointed director and chief of the chemical department, with **Mr. T. H. Rigg**, late of Rothamsted, working under him as agricultural chemist. In the biological department **Miss K. M. Curtis** has been appointed mycologist, and **Mr. A. Philpott** assistant entomologist. The library and museum are under the care of the curator, **Mr. W. C. Davies**. The activities of the institute will be directed towards scientific research, both pure and applied, with the view of benefiting the primary industries of New Zealand as a whole and of the Nelson Province in particular.

**Aristotelian Society, June 21.**—**Mr. A. F. Shand** in the chair.—**Miss Edgell**: Memory and conation. The views of three writers approaching the subject from the different viewpoints of philosophical psychology, biology, and psychiatry, viz. **Prof. Ward**, **Dr. Semon**, and **Dr. Freud**, were examined with reference to the question: Does memory require the recognition in mental life of a specific function, conation? Analysis shows that for **Prof. Ward** the activity of the subject of experience is essential both for the development of memory and for many of its manifestations. If the activity of the subject be understood as implying conation, then the author's theory of memory does involve conation. **Dr. Semon**, following **Hering** and **Butler**, regards memory as a function of all organic matter and its laws as laws of organic life. Nevertheless, in dealing with human memory **Semon** recognises "vividness" in imagery as essential for memory and association. Vividness is distinguished from intensity and made to depend on attention. The relation of attention to the laws of organic life is still obscure, and attention is treated as if it were an original force. The rôle of conation in the psychology of **Dr. Freud**

is all-important. It is the conation of unconscious wish which is regarded as explanatory, if not of the fact of memory itself, at least of many of the phenomena of remembering and forgetting in everyday life.

## PARIS.

**Academy of Sciences, June 21.**—**M. Henri Deslandres** in the chair.—The President announced the death of **Adolphe Carnot**, free member.—**L. Torres Quevedo** was elected correspondent for the section of mechanics in succession to the late **M. Bouilvin**.—**P. Humbert**: Functions of the hyperparaboloïd of revolution and hyperspherical functions.—**J. Villey**: The choice of the density of filling in the conception of aviation explosion motors.—**R. Jarry-Desloges**: Different phenomena observed on the planet Mars in the present opposition. Nix Olimpica was discovered by **Schiaparelli** in 1879, but no measurements have been taken since that date. Searches without result were made in 1881 by **Schiaparelli**, and in other observations between 1907 and 1916. The concordance between the measurements made at Milan in 1879 and those taken at Sétif in 1920 leave no room for doubt that Nix Olimpica has reappeared.—**Mme. Paule Collet**: Two modes of rectification of currents by galena.—**E. Berger**: Some reactions started by a primer. The use of a primer to start a chemical reaction instead of an external application of heat was first used by **Goldschmidt**, a mixture of barium peroxide and magnesium powder being employed to start the reaction between ferric oxide and powdered aluminium. The new primer proposed by the author consists of 60 per cent. potassium nitrate (or sodium nitrate) and 40 per cent. commercial calcium silicide. This burns with a very high temperature, and can be lit with a match. A description is given of the applications of this method to the production of phosphorus and arsenic, the reduction of the sulphates of the alkaline earths by phosphorus, and the preparation of the fluorides of silicon and boron.—**A. Recoura**: The constitution of the grey lilac chromium sulphate.—**P. Jolibois** and **P. Bouvier**: The precipitation of mercuric salts by sulphuretted hydrogen. The authors have applied the apparatus described in an earlier communication to the study of the reaction between mercuric chloride and hydrogen sulphide, the reaction being carried out with the two reagents in varying proportions. With excess of sulphuretted hydrogen the precipitate has the composition  $HgS$ ; with the mercuric chloride in excess the precipitate (white) has the composition  $2HgS.HgCl_2$ , and there was no indication of the existence of any other intermediate compound.—**P. Chevenard**: The thermal change of the elastic properties of nickel-steels. The results of experiments on twenty-eight alloys of iron and nickel are given graphically in two diagrams.—**A. de G. Rocasolano**: The catalytic decomposition of solutions of hydrogen peroxide by colloidal platinum. **Bredig** and his pupils concluded from their experimental studies of this reaction that it was monomolecular. The author has used electrosols of platinum as catalyst, and comes to the conclusion that the reaction in this case is not monomolecular or of the first order. During the reaction the catalyst is changed. If some of this altered catalyst is added to a fresh quantity of hydrogen peroxide, the ensuing reaction is now monomolecular.—**E. Hildt**: The hydrolysis of the polysaccharides. Details of further experiments on the use of a mixture of sulphuric acid and sodium benzenesulphonate as a catalyst for the hydrolysis of the sugars. Glucose and galactose retain their rotatory and reducing powers unchanged under the action of this catalyst; non-lævulose sugars, such as lactose and maltose, are

not hydrolysed at the ordinary temperature; whilst with saccharose and raffinose the lævulose is completely split off after sufficient time at the ordinary temperature or after one hour at 98° C.—L. **Caveux**: The secondary quartz and the rhombohedral quartz in the iron minerals of the Longwy-Briey basin.—R. **Abrard**: The existence of the Aalenian stage in the massif of Zerhoun and at Djebel Tselfat (Western Morocco).—P. **Russo**: The alluvial terraces of Oum er Rbia (Western Morocco).—L. **Daniel**: Antagonistic reactions and the rôle of the pad in grafted plants.—A. **Guilliermond**: The structure of the plant-cell. Reply to a recent communication of M. Dangeard.—M. **Dangeard**: Reply to the preceding note.—E. **Licet**: The use of mixtures of formal and chromium compounds as fixing agents. Three formulæ are given for fixing reagents containing formal, chromic acid, and acetic acid in different proportions. Although the use in the same liquid of a powerful oxidising agent and a reducing substance would appear to be irrational, long experience has shown that such mixtures give excellent results.—E. **Roubaud**: The use of trioxymethylene in powder for the destruction of the larvæ of mosquitoes. Trioxymethylene exerts a specific toxic action on these larvæ, and has advantages over petroleum and other reagents in use. Detailed instructions for the best application of the trioxymethylene are given.—J. **Nagotte**: The toxicity of certain dead heterogeneous grafts.—A. **Goris**: The chemical composition of the tubercle bacillus. A new substance has been obtained from tubercle bacilli by extraction with chloroform and subsequent purification by precipitation from chloroform solution with ether, the fats remaining in solution in the ether and the new substance, named hyalinol, being precipitated. Seven grams were obtained from 1500 grams of the bacilli. An analysis and some reactions of the hyalinol are given.—R. **Ducoux**: The formation of asporogenic races of *Bacillus anthracis*. The attenuation of its virulence.—MM. A. **Trillat** and **Mallein**: Experiments on the transmission of an infectious disease in animals by the intermediary of air. Influence of the temperature.—MM. A. **Mayer**, **Guieysse**, **Plantefol**, and **Fauré-Fremiet**: Pulmonary lesions determined by blistering compounds. Studies on the pulmonary lesions caused by the inhalation of vaporised- or pulverised dichloroethyl sulphide on the dog, rabbit, and guinea-pig.

### Books Received.

Techno-Chemical Receipt Book. Compiled and edited by W. T. Brannan and Dr. W. H. Wahl. Pp. xxxiii+516. (London: Hodder and Stoughton, Ltd.) 15s. net.

Psychoneuroses of War and Peace. By Dr. M. Culpin. Pp. vii+127. (Cambridge: At the University Press.) 10s. net.

Reports of the Department of Conservation and Development, State of New Jersey. Annual Report for the Year ending June 30, 1919. Pp. 115. (Trenton, N.J.)

The Science Reports of the Tôhoku Imperial University. 1st Series. (Mathematics, Physics, Chemistry.) Vol. ix., No. 2, April. (Tokyo: Maruzen Co., Ltd.)

Meddelanden från Lunds Astronomiska Observatorium. Serie ii., Nr. 22: A Study of the Stars of Spectral Type A. By H. G. Malmquist. Pp. 69. (Lund.)

The Journal of the Royal Agricultural Society of England. Vol. lxxx. Practice with Science. Pp. viii+438+cli. (London: J. Murray.) 10s.

NO. 2645, VOL. 105]

### Diary of Societies.

THURSDAY, JULY 8.

ROYAL SOCIETY OF MEDICINE (Obstetrics and Gynecology Section), at 8.—G. Ley: The Pathology of Accidental Hemorrhage.

FRIDAY, JULY 9.

WEST LONDON MEDICO-CHIRURGICAL SOCIETY (at the West London Hospital), at 5.—Annual General Meeting.

SATURDAY, JULY 10.

PHYSIOLOGICAL SOCIETY (at Physiological Laboratory, University, Oxford), at 4.—J. B. Leathes and H. C. Broadbent: Excretion of Phosphate.—J. Barcroft and F. J. Roughton: Diffusion Co-efficient of Lung.—S. P. L. Sørensen and E. J. Cohn: Solubility of Globulin.—A. Krogh: Reaction of Blood Vessels to Local Stimuli.

TUESDAY, JULY 13.

SOCIETY FOR THE STUDY OF INEBRIETY (at the Medical Society of London), at 4.—A. Evans and Others: Discussion on Alcohol and Alcoholism in relation to Venereal Disease.

WEDNESDAY, JULY 14.

INSTITUTION OF PETROLEUM TECHNOLOGISTS (in Canada Building, Crystal Palace), at 6.—H. Barringer: Oil Storage, Transport, and Distribution (Free Public Lecture).

THURSDAY, JULY 15.

ROYAL SOCIETY OF MEDICINE (Dermatology Section), at 5. RÖNTGEN SOCIETY (at University College), at 9.—Dr. W. D. Coolidge: Address (Special Open Meeting).

### CONTENTS.

	PAGE
Medical Education	573
The Theory and Facts of Colour Vision	575
Hydrographical Surveying	576
Forestry, Tree Diseases, and Timber	577
Our Bookshelf	579
Letters to the Editor:—	
Weather Forecasts and Meteorology.—A. Mallock, F.R.S.	580
The Rate of Ascent of Pilot-Balloons. (With Diagram).—J. S. Dines	581
Diamagnetism and the Structure of the Hydrogen Molecule.—Dr. A. E. Oxley	581
University Stipends and Pensions.—G. W. O. H.	582
The Separation of the Isotopes of Chlorine.—Angus F. Core	582
The Island of Stone Statues. (Illustrated). By Sir Everard Im Thurn, K.C.M.G., K.B.E.	583
The Blue Sky and the Optical Properties of Air. By The Right Hon. Lord Rayleigh, F.R.S.	584
The Future of the Iron and Steel Industry in Lorraine. By Prof. H. C. H. Carpenter, F.R.S.	588
Obituary	590
Notes	590
Our Astronomical Column:—	
Commencement of the Great Perseid Shower of Meteors	595
The Expanding Disc of Nova Aquile	595
The New Minor Planet GM	595
Annual Visitation of the National Physical Laboratory	595
The Carnegie Foundation and Teachers' Pensions	596
National Food Consumption in the United States. By M. G.	597
Engineering Research in the U.S.A. By A. P. M. Fleming, C.B.E.	598
African Softwoods for Pulp Production. By A. H. Unwin	599
Effect of Topography on Precipitation in Japan. By W. W. B.	599
Economic Entomology in the Philippines. By O. H. L.	600
Climate of the Netherlands	600
The Present Condition of the Aborigines of Central Australia. By E. N. Fallaise	601
University and Educational Intelligence	601
Societies and Academies	602
Books Received	604
Diary of Societies	604



THURSDAY, JULY 15, 1920.

*Editorial and Publishing Offices:*

MACMILLAN &amp; CO., LTD.,

ST. MARTIN'S STREET, LONDON, W.C.2.

Advertisements and business letters should be  
addressed to the Publishers.

Editorial communications to the Editor.

Telegraphic Address: PHUSIS, LONDON.

Telephone Number: GERRARD 8830.

### Medical Research.

**A** TEACHING hospital will not be content solely with making the best possible provision for the treatment of injury and disease and for imparting knowledge; it will recognise as one of its most important functions also the increase of knowledge.

"The problems of disease presented by living patients are the most difficult and complex in the whole range of the physical and natural sciences. Much light can be shed on them by investigations conducted in physiological, chemical, pathological, pharmacological, and bacteriological laboratories, especially by experimentation on animals; but it is increasingly clear that the scientific study of many of these problems can be undertaken with the greatest advantage in well-equipped, special laboratories connected with the hospital clinics and in charge of investigators trained in chemical, physical, and biological methods, with convenient access to the material for study and in close touch with the clinicians.

"The familiar analytical and statistical study of cases of disease, based on simple clinical observations, and first extensively and fruitfully applied by the great French clinicians of the early part of the last century, has been of immense service to medicine, and will continue to be of service. A good clinical observation has precisely the same scientific value as a fact demonstrated in the laboratory, and, even if more difficult of interpretation, is often the safer guide for the action of the physician.

"It is, however, from the special clinical laboratories that we may reasonably hope for a more penetrating insight into the causes and nature of many diseases, an insight which perhaps may arm physicians with a saving power of prevention and treatment of some of the organic diseases of advancing life comparable to the inestimable gifts of bacteriological laboratories to the prevention and treatment of infectious diseases. We must welcome the establishment of such laboratories and the new directions which they are giving to medical research. When the purposes of such laboratories are made clear, their foundation and

support should make an especially strong appeal to public and private philanthropy."

I have quoted these remarks made some thirteen years ago by the distinguished leader of American medicine, Prof. William H. Welch, of the Johns Hopkins University, because they express so precisely the motive and the object of the reforms to be effected at the University College Hospital Medical School with the help of the Rockefeller gift. Dr. Welch spoke not only with deep insight and eloquence, but also with the experience he had gained as the Father of the Johns Hopkins Hospital and its famous Medical School.

The aim of the reforms of medical education that were introduced at the Johns Hopkins University in 1893 was primarily to educate the medical student rather than merely to prepare him for examinations. In other words, every encouragement was given him to learn by personal observation and experiment and to rely upon his own judgment; and he was provided with every facility in the way of properly equipped laboratories and ample material to carry out this scheme of work. Above all, he was given the time, undisturbed by multitudes of didactic classes, in which to cultivate his powers of observation and acquire knowledge by his own efforts. In other words, the ideal was to make every student and member of the staff devote himself to original research and the advancement of knowledge. How fruitful such a method can become we know from the history of our schools of physiology. The influence of the great reforms introduced at University College by Prof. Sharpey eighty years ago was carried to Cambridge by Sir Michael Foster, to Oxford by Sir J. Burdon Sanderson, and to the Johns Hopkins University by Prof. Newell Martin; and the result of these practical methods of studying physiology has been to convert almost every department of that subject into an institute of research and a perennial source of new knowledge.

The contrast presented by departments of anatomy in the English-speaking world, before 1893 in America, but even now in this country, is profound. The remarkable activity of physiology has been one of the contributory causes; and the very circumstance that Sharpey, the reformer of physiological education, was primarily a professor of anatomy was one of the factors in sterilising the spirit of adventure in his own subject. This paradoxical result was due to the fact that as a professor of anatomy and physiology Sharpey was

at liberty to take from the former subject the more vital and interesting parts with which to render attractive his own particular hobby, practical physiology. When his disciples carried the new physiological gospel to Cambridge and Oxford (thence to English-speaking schools the world over), histology and embryology were regarded as part of the work of the department of physiology. This could not have happened if anatomy during the last half-century had had any men like Sharpey, Foster, Burdon Sanderson, or Gaskell to claim their rights and obtain the necessary laboratories and equipment for real research in anatomy. Instead of this, while most of the schools of anatomy fell into a condition of inertia, the gospel taught in the one active and dominant school was the complete repression of the scientific imagination and the crushing of all research that was not a mere record of facts. Franklin Mall was able to do what he did in America because he was not subject to this paralyzing influence which was crippling British anatomy.

It is necessary clearly to appreciate these historical circumstances in order to understand the present contrast between the attitude towards research in anatomy in American and British schools. In many of our departments no attempt whatever is made to add to knowledge; in fact, in certain of them there is not merely apathy, but even active opposition to original investigation. But, for the historical reasons I have mentioned, there is no adequate provision in any anatomical department in this country of the means for carrying on research, even when the staff and students are anxious to do so. Those anatomists who, in spite of these obstacles, have been keen enough not to be altogether discouraged by them have in many cases done excellent research, but only to find, in not a few instances, that their zeal was regarded as an obstacle to their professional advancement.

Now that this unfortunate and not very creditable chapter in British anatomy is coming to a close, it is important to get a clear idea of the aims of such an Institute of Anatomy as the Rockefeller Foundation's gift will enable us to build up in London.

The chief purpose of the new building will be to provide ample room and equipment to permit the staff, graduate students, and even undergraduates, to investigate any aspect of the problems of man's structure and development. There will be dissecting-rooms and museums for the

study of macroscopic structure, and laboratories and museums for the investigation of the manifold problems of anthropology and man's evolution; but there will also be laboratories for the practical study of embryology, histology, and neurology, both human and comparative, and every necessary kind of equipment for work in any of these subjects. Proper provision is to be made for research in radiography, with special reference to the light it throws upon the structure and functions of the living body and its development. In other words, the new institute is intended to provide accommodation and equipment for research in every aspect of anatomy and anthropology; and the close association which is to be established with the departments of physiology and vertebrate anatomy and with the hospital will help to widen the outlook of investigators in anatomy and give them a clearer vision. Special importance is attached to this integrating aspect of our scheme of work, because it is proposed to create in the institute a department for the experimental study of the factors that influence growth and development and the causation of anomalies of structure and pathological monstrosities. Research in experimental embryology has been one of the most fruitful and significant fields of work in American anatomy departments within recent years. It is difficult to exaggerate the importance of the work carried on at the Carnegie Institute of Embryology by such men as Drs. Streeter and Lewis and their collaborators, by Dr. Ross Harrison at Yale, and by Dr. Stockard at Cornell Medical School, to mention only a few out of many.

In addition to these fields of investigation, many of the schools of anatomy in America carry on experiments in genetics, not so much for the purpose of studying Mendelism as for correlating the results of breeding experiments with other branches of work in anatomy and experimental embryology.

To carry out a programme of this sort it is our aim to have a staff numerous enough to give every member at least half his time free from teaching to devote to research; for a teacher who is not actually engaged in investigation is merely a retailer of second-hand goods.

At a time when this serious attempt is being made to provide proper facilities for carrying on research in anatomy, it is particularly gratifying to know that the University of Cambridge has appointed to its chair of anatomy the most learned British exponent of the technique of

anatomy and embryology. By his extensive and exact knowledge of anatomy and his technical skill, no less than by his personality and sound judgment, Prof. J. T. Wilson will exert a great influence in the encouragement of anatomical research in this country. His appointment to Cambridge inspires the confidence that the dark days of British anatomy are numbered.

G. ELLIOT SMITH.

### Intellectual Stock-taking.

- (1) *Science and Theology: Their Common Aims and Methods.* By F. W. Westaway. Pp. xiii+346. (London: Blackie and Son, Ltd., 1920.) Price 15s. net.
- (2) *Recent Developments in European Thought.* Essays arranged and edited by F. S. Marvin. (The Unity Series.) Pp. 306. (London: Humphrey Milford; Oxford University Press, 1920.) Price 12s. 6d. net.

THERE seems to be a general disposition at the present time to take stock of the achievements of the human race in the generation which lived before the great cataclysm of the world-war. We feel, as mankind felt a hundred years ago after the great upheaval of the French Revolution and the succeeding Napoleonic struggle, that we are at the beginning of a new age. If we are to be effective in reconstructing and directing the new life of humanity, we must know the nature and extent of the forces in hand so far as they are under our control. The two books before us attempt this task in a very different manner. The first is the effort of a single worker to gather up and present, in a compact form and without bias, the definite results of recent scientific, religious, and philosophical research, and where they are conflicting or antithetical to state the case for each. The second book is the joint production of several workers, under the leadership of the author of "A Century of Hope," to express the characteristic features of the philosophy, religion, science, art, and history of the last half century, or more precisely of the period which begins with the Franco-German War of 1870 and ends with the outbreak of the great war in 1914.

(1) Mr. Westaway's work is primarily addressed to students of theology, and intended to aid them in finding a philosophic basis for their science. Before they can have this philosophic basis, however, they must, he thinks, master the main principles of mathematics, of science, and of scientific method. If, the student is told, he resorts to metaphysical arguments concerning

the infinite before he has made himself acquainted with the nature of infinity in mathematics, he is violating the first principles of common sense. The same is true of physics, biology, and psychology. The student, we are afraid, will think it a hard saying, but then here is Mr. Westaway's epitome of the bases of all knowledge offered to him in tabloid form, compact and neat as in a medicine chest. Every theory that is held by anyone of authority in the sciences and philosophies, or which can be held, is set forth in abstract terms, and each summary of results is supported by a formidable list of books of reference. The theological student is left without excuse.

(2) A very different tone pervades the book edited by Mr. Marvin, for in this the personality of each of the twelve writers is given full expression. It makes the diversity more interesting than the unity. Perhaps the most telling contrast is between the positivistic tone of the general survey with which Mr. Marvin introduces the course, and the idealistic exuberance with which Miss Melian Stawell closes it. But surely the oddest contribution to the volume is Prof. Taylor's estimate of the philosophy of the last half century. It begins with a mystifying line of asterisks, and ends with a "note." The note is appended as an "apology" for omitting Bergson, or, rather, for refusing to regard that philosopher as other than a transient and spent force. The reason given is that his earliest work in its opening chapter contains "a couple of elementary blunders," and on these the whole of his philosophy is based. The note is certainly necessary, because the other essays in the volume might easily lead the reader to imagine that the period had been dominated by the philosophy of Bergson.

The meed of honour in philosophy is awarded by Prof. Taylor to Mr. Bertrand Russell, mainly on account of his joint work with Prof. Whitehead in "Mathematica Principia." He thus agrees with Mr. Westaway in holding the mathematical theory of infinity to be the basis on which philosophy must build. There can be no doubt that if the award is to be decided in the manner of the Greeks after the battle of Salamis, Mr. Russell must be acclaimed *facile princeps*, for there is no living philosopher in regard to whom such striking unanimity prevails. No one agrees with him, but everyone is anxious to set forth his reasons for disagreeing. Prof. Taylor is no exception. He looks in vain for any recognition by Mr. Russell of what he regards as the one vital and absolute necessity of philosophy, the attainment of knowledge about the soul and God. For this he refers us to the two eminent Italian

professors, Varisco and Aliotta, and omits any reference to their more celebrated contemporaries, Croce and Gentile. His prayer is "for a Neo-Thomist who is also a really qualified mathematician."

All the essays in the volume are interesting. Principal Jevons writes of religion from the point of view of folk-lore study; Mr. Gooch has given an admirable review of the history of historical research, the science which Croce names "storio-grafia"; while Prof. Bragg treats of "atomic theories," but is only able to indicate in a note the new interest aroused by the work of Einstein. Of this it is too early to take stock. H. W. C.

### Petroleum Geology.

*Geology of the Mid-Continent Oilfields. Kansas, Oklahoma, and North Texas.* By Dr. T. O. Bosworth. Pp. xv+314. (New York: The Macmillan Co.; London: Macmillan and Co., Ltd., 1920.) Price 3 dollars.

IN this the latest contribution to the geology of the great Mid-Continent oilfields, Dr. Bosworth has contented himself with summarising the results of most of the recent work published by American geologists in the *Bulletins of the United States Geological Survey*, and in those of the Oklahoma and Texas Surveys in particular. His aim throughout has been to present the facts, leaving deductions to the intelligence of the reader, since, although he sets out with the intention of reviewing those facts, he does not succeed in attaining this end, for his final chapter, devoted to general conclusions, mainly deductive, occupies only a little more than five pages out of a total of 282 of text, and cannot be regarded as more than a somewhat hurried and non-committal postscript to the preceding sections of the book.

To any keen student of petroleum geology the announcement of a new publication dealing with one of the world's greatest oilfields is to be regarded with a certain degree of anticipation, partly with reference to possible new theories of oil accumulation and development, and partly (in this case) from a curious desire to see how far the teachings of the British geological school may be affirmed or modified by association in their own country with American oil technologists. This dual anticipation, however, is doomed to disappointment, because there is certainly nothing strikingly new in Dr. Bosworth's book, and one further perceives in the work a strong undercurrent of bias to prevalent American opinion.

It was to be hoped, for example, that new light

would be thrown on the structure of the North and Central Texas fields, which are of such recent development and importance; but, beyond a brief description of the local "closed dome," "nose," and "terrace" structures originally described by Dorsey Hagar in his paper before the American Institute of Mining Engineers (1917), little information is forthcoming.

Another point on which more information is desirable is the possibility of the future development of the fields to the west. The general westward dip of the Palæozoic rocks tends to shift the oil horizons of the Pennsylvanian beds deeper and deeper in that direction, and further prospecting must inevitably lead to deeper drilling, assuming the structure to remain uniform. But it is by no means certain that such is the case, and on this point the author is unable to enlighten us. He suggests certain possibilities in regard to locating oil in the underlying Mississippian and in the overlying Permian "Red" beds; but in the former case the great depth to which borings must necessarily penetrate will tend to limit operations, whilst in the latter the oil occurrences are probably extremely localised, the conditions obtaining in the Healdton (Permian) field, which he quotes at some length, being the exception rather than the rule. It is only fair to add, however, that the short-sighted policy of many of the oil companies in prohibiting the publication of the results of detailed surveys prevents many workers from doing full justice to their research, and science, in consequence, must suffer accordingly.

It is interesting to note that in his conclusions the author regards the "vegetable" hypothesis as accounting for the origin of the hydrocarbons, and he further recognises White's laws of progressive devolatilisation as applicable to the Mid-Continent fields, an opinion which is in accordance with American views.

For the rest, the book certainly contains some useful features, the stratigraphy of the oilfields and the relations of oil accumulation to structure in most of the important fields being treated very concisely. The chemical side is by no means neglected, and the general characteristics of the Mid-Continent oil and natural gas, and the production of gasoline from that gas, are dealt with in some detail. Maps, plans, and photographs of the fields are included, together with a bibliography of the more important works relative to the area. The volume will probably make its strongest appeal to those who wish to gain a broad idea of the geology of the oilfields without having recourse to survey and other technical publications.

H. B. MILNER.

### Fuel Problems.

*Fuel Production and Utilization.* By Dr. H. S. Taylor. (Industrial Chemistry Series.) Pp. xiv + 297. (London: Baillière, Tindall, and Cox, 1920.) Price 10s. 6d. net.

THIS volume is intended more especially as a post-graduate book which shall "supplement academic training with the broad facts of fuel production and utilisation." The main sources from which the author has drawn his material are the valuable bulletins issued by the United States Geological Survey and the Bureau of Mines, supplemented by other American and Canadian sources of information. Everyone familiar with fuel problems realises the great value of these publications, and although many of the author's quotations from these and his other sources are lengthy, his judicious selection of material has enabled him to compile a volume which cannot fail to be of value to a much wider circle than post-graduate students.

A great change in the fuel problem has followed from the enormous rise in the price of coal, and it is difficult to see what the far-reaching ultimate effect will be. Certain it is that man will be driven to consider the utilisation of such material which has hitherto received but little attention, and to give closer attention to using the last heat unit possible in every ton of coal. While coal was cheap economists preached to deaf ears; economic necessity will produce effects which years of preaching failed to accomplish. Dr. Taylor's book should go a long way to help those who are prepared to take the serious view which the situation demands of these problems, and it is of value not only as recording what has been done in the near past, but also as indicating possibilities in fuel utilisation in many directions.

One of the features of the book is the broad outlook of the author on many of the problems which, whilst at present of very minor importance, bear evidence of becoming of considerable practical importance with the great alteration in conditions in the fuel situation. The utilisation of the minor fuels—peat wood, coke for industrial purposes, and pulverised coal—together with the many problems associated with the low-temperature distillation schemes, are more adequately dealt with by Dr. Taylor than by most writers of general books on fuel, the considerable space devoted to these problems being amply justified by their potential importance.

From the scientific point of view the "synthetic" fuels are of considerable interest. In the future some may become of great importance. The merits of alcohol as a fuel are now very widely

recognised, and the author gives an excellent account of this question. Closely connected—indeed, part of the problem—is acetylene as fuel, either directly, for small motor vehicles have been driven by this gas, or more specifically as a possible source of alcohol. Several processes for the conversion are referred to, the steps usually involving the formation of aldehyde by absorption in acids, generally in the presence of mercury salts, and the conversion of the aldehyde into alcohol by reduction by Sabatier's method with hydrogen in the presence of nickel as a catalyst.

Of a similar character is the production of hexahydrobenzene (hexamethylene) by the hydrogenation of benzene. The author points out the advantages of such a fuel of constant composition and properties, but he does not refer to the one great disadvantage of this compound, namely, its high freezing point ( $6.4^{\circ}$  C.). He refers to it as suitable for aeroplanes, but this high freezing point obviously entails serious difficulties. In admixture the claim for homogeneous composition is gone, and even alone it is difficult to see what advantages it possesses over benzene, which has approximately the same freezing point, or even over commercial "benzol," which freezes below  $0^{\circ}$  C. and has no greatly varying degree of volatility.

J. S. S. B.

### Hurter and Driffield.

*A Memorial Volume containing an Account of the Photographic Researches of Ferdinand Hurter and Vero C. Driffield: Being a Reprint of their Published Papers, together with a History of their Early Work and a Bibliography of Later Work on the Same Subject.* Edited by W. B. Ferguson. Pp. xii + 374. (London: The Royal Photographic Society of Great Britain, n.d.) Price 25s.

DR. HURTER died twenty-two years ago, and Mr. Driffield afterwards did little or nothing more in connection with their joint labours than complete and publish the work that was almost finished. It is possible now, therefore, to regard their work as a whole, and to see something of the relationship that it bears to the general progress of photography from the scientific point of view.

Hurter and Driffield did two very considerable things. They devised the method of drawing what they called, and what is now universally known as, the "characteristic curve" of a developable sensitive surface. This may at first appear a very easy thing to do, but it is often the things that are easy to do which are the most difficult to get at and of

the greatest fundamental importance. With the curve are, of course, included the units that it involves and the facts that it represents. As to its advantages, it is enough to say that it was at once adopted wherever photography was regarded as a science, and no better method of expression has since been suggested.

Their second notable achievement was that they promulgated certain conclusions to which they had come with an energy and assurance that stand unique in connection with this, if not with all scientific subjects. Their statements in their communication of 1890 with regard to some of the opinions and experiences of others as interested in the subject as they were, were put in such vigorous language that they amounted to challenges. Of course, this led to discussion and to further work; and discussion breeds discussion, and work breeds work. Dr. Hurter and Mr. Driffield either separately or jointly were always ready to take any pains, by reading papers, often travelling long distances to do so, by writing articles, or by personal correspondence, to make clear and to uphold their views. They thus administered a powerful stimulant to scientific photography.

It is of very secondary interest what these views were, because the whole subject has received since then more attention than any two persons could possibly devote to it; and, indeed, Hurter and Driffield themselves, in their last important communication on "The Latent Image and its Development," demonstrate by further experiments the necessity of largely, if not radically, modifying the statements to which so much exception had been taken.

It must not be supposed that Hurter and Driffield set out with the intention of doing the two things that we have endeavoured to describe. To quote their own words: "Our object was to discover a method of speed determination, and it was not, as the [photographic] public seemed to infer, to deal finally and exhaustively with the subject of development. This subject was purely incidental. . . ." As everyone knows, they did devise a method for the estimation of sensitiveness, and, as might be expected from such capable men, a method wholly different from any other, but, like all methods, it has its advantages and its disadvantages. The sensitiveness of a plate is not definite except under definite conditions, and in practical work the conditions are not uniform.

It is but a short step from the courteous and ever kindly Hurter and Driffield to the memorial volume before us, because Mr. Ferguson has done his work well and with full sympathy. The volume begins with Mr. Ferguson's recent lecture

on their early work, which is followed by a review of Dr. Hurter's mathematical work by Dr. H. Stanley Allen, and by the patent specifications of the early actinometer and the actinograph. Then come reprints of all their important communications to societies and journals. Mr. Ferguson has certainly not erred in the direction of making too exclusive a selection, though he tells us that there are many other publications of theirs, chiefly polemical letters to the photographic Press, which, if reproduced, would have filled two more volumes. After this there are a bibliography of 717 items, extending from 1881 (Hurter's actinometer patent) and 1888 (the actinograph patent) to 1918, and name and subject indexes. If there should exist anyone interested in scientific photography who is so saturated with the work of Hurter and Driffield that the reprints do not appeal to him, even he cannot fail to find the bibliography and indexes of considerable use.

C. J.

### Our Bookshelf.

*Bygone Beliefs: Being a Series of Excursions in the Byways of Thought.* By H. Stanley Redgrove. Pp. xvi+205+32 plates. (London: William Rider and Son, Ltd., 1920.) Price 10s. 6d. net.

THIS series of fragmentary discussions extends over a vast area: Pythagoras and his philosophy, medicine and magic, bird superstitions, powder of sympathy, talismans, ceremonial magic, architectural symbolism, the Philosopher's Stone, the phallic element in alchemical doctrine, Roger Bacon, and the Cambridge Platonists. It is inevitable that a discussion of such varied subjects in a limited space is not likely to be fruitful, nor will the author's interpretations command universal acceptance. Thus we are told that "the alchemists regarded the Philosopher's Stone and the transmutation of the base metals into gold as the consummation of the proof of the doctrines of mystical theology as applied to chemical phenomena," though some were influenced by more material objects. The premises from which they started were "the truth of mystical philosophy, which asserts that the objects of Nature are symbols of spiritual verities. There is, I think, abundant evidence to show that alchemy was a more or less deliberate attempt to apply, according to the principles of analogy, the doctrines of religious mysticism to chemical and physical phenomena." Of course, it is generally admitted that the idea of transmutation had a philosophical basis such as it was, and that alchemy to some extent unified and focussed chemical effort, but it was, to use Liebig's words, "never at any time anything different from chemistry."

While it is difficult to accept the author's transcendental interpretations of these and kindred phenomena, he has collected much curious learning, for which he supplies adequate references,

and he gives us a number of curious illustrations, one of which, however, may judiciously have been omitted in a book which claims to be popular.

*The Propagation of Electric Currents in Telephone and Telegraph Conductors.* By Prof. J. A. Fleming. Third edition, revised and extended. Pp. xiv+370. (London: Constable and Co., Ltd., 1919.) Price 21s. net.

In preparing a new edition of his well-known study of the propagation of telegraph and telephone currents, Prof. Fleming has taken the opportunity of bringing it in line with both the latest theoretical and the latest practical work in this field. The subject presents a very fine example of mathematical investigation leading to results of far-reaching practical utility, and the author conducts his reader along a logically continuous path from the point where he introduces him in the first chapter to hyperbolic functions of complex angles, to the page near the end where he pauses to show him a picture of a telephone cable with loading coils being laid across the Channel. Telegraph and telephone engineers owe a great debt of gratitude to Prof. Fleming for the way he has, at first in his lectures and then in the volume now before us, brought together so much valuable work in this complicated subject, to which he himself has been no mean contributor. Perhaps the most valuable feature of the treatment is the way in which he has simplified, so far as possible, the mathematical results of the original investigators, while at the same time facilitating the building of the bridge from the other end by providing the material to extend the student's mathematical resources in the required direction.

*Half-past Twelve: Dinner Hour Studies for the Odd Half-Hours.* By George W. Gough. Pp. vi+77. (London: Sells, Ltd., n.d.) Price 1s.

THERE is abundant evidence that much of the present-day industrial unrest arises from the ready acceptance of fallacious economic ideas by many of those engaged in industry. The need for sound teaching in the first principles of economics of a character within the ready understanding of working men and women, and of all who help to form public opinion, is acute, and Mr. Gough has rendered a valuable service in helping to satisfy this need.

This interesting little book is an attempt to correct wrong economic ideas and a limited perspective by providing a series of talks on familiar economic topics such as production, capital, profits, wages, the mechanism of exchange, and the principles of taxation. The author deals with these in a brief but extremely lucid manner, and his conclusions, while significantly orthodox, are arrived at without bias or prejudice. His illustrations are most apt, and will effectively secure the interest of his readers. It is to be hoped that this publication will be widely read not only by industrial workers and students, but also by the public generally.

A. P. M. F.

### Letters to the Editor.

[The Editor does not hold himself responsible for opinions expressed by his correspondents. Neither can he undertake to return, or to correspond with the writers of, rejected manuscripts intended for this or any other part of NATURE. No notice is taken of anonymous communications.]

#### The Separation of the Isotopes of Chlorine.

PROF. SODDY (June 24) and Mr. CORE (July 8) have in their comments on my letter in NATURE of June 17 raised several points of interest. The former asks that all the assumptions from which the equation

$$[Cl'_2][Cl_2] = [ClCl']^2$$

was deduced may be given. The assumptions are: (1) The differences between the vapour pressures of the three varieties of chlorine are negligibly small.

(2) The vapours are almost perfect gases.

(3) The three varieties of gaseous chlorine are separable by semi-permeable membranes or other means, or the equivalent assumption that the thermodynamic potential of a mixture of the three varieties is the sum of the thermodynamic potentials of the constituents.

(4) The work required to convert reversibly 1 mol. of solid  $Cl'_2$  and 1 mol. of solid  $Cl_2$  into 2 mols. of solid  $ClCl'$  is negligible.

The three last assumptions lead us to the formula

$$o = \log_e K + \log_e \frac{\{ClCl'\}^2}{\{Cl'_2\}\{Cl_2\}}$$

where the bracket { } indicates concentration of saturated vapour. Whence with the aid of assumption (1) we deduce that  $K=1$ .

Assumption (4) follows from Nernst's heat theorem if it be postulated that the energy of the change considered is almost zero. It would appear, therefore, that if isotopes are inseparable by processes similar to that described in my first letter, one of the assumptions made is not valid.

Prof. Soddy asks whether there is any step in my argument to prevent its being applied to prove the possibility of the separation of arbitrarily selected atoms from a group of completely identical molecules by chemical means; for, if there is not, then it follows, as a *reductio ad absurdum*, that the equilibrium equation

$$[Cl'_2][Cl_2] = [ClCl']^2$$

is wrong, and it is unnecessary to test its validity by experiment. Concerning this query I am in doubt whether it would be generally admitted that assumption (3) could be made in such a case as that contemplated by Prof. Soddy, and therefore I think it is desirable that the question of the validity of the equation should be submitted to the test of experiment—so far as it is possible to do this.

Mr. Core assumes that the isotopes of chlorine are inseparable by chemical means, but does not agree with my conclusion that if such is the case Nernst's heat theorem will be difficult to defend. He admits that at finite temperatures the difference in entropies of the solid reactants and resultants is  $R \log_e 4$ , but he argues that it may become zero at zero temperature owing to the effects of the differences in properties of the three solids being more pronounced at exceedingly low temperatures. But even if it be admitted that in the case of chlorine the difference between the entropies of the reactants and resultants can be nothing at zero temperature and  $R \log_e 4$  at finite temperatures, it has still to be explained how the same rise in the difference of entropies from zero to the constant value  $R \log_e 4$  could occur for a change of the same type in the case

of another element which exists in the form of two isotopes differing much less in their atomic weights than those of chlorine. Furthermore, if we put  $A=f(t)$ , and if  $f(t)$  can be expanded in the analytical series,

$$f(t) + t \cdot f'(0) + \frac{t^2}{2} \cdot f''(0) + \text{etc.},$$

and  $f'(0)$  is zero as Nernst assumes, then it must be explained how the series

$$f(t) + \frac{t^2}{2} f''(0) + \text{etc.},$$

can become almost equal to  $t.R \log_e 4$  between wide limits of temperature.

In fact, if the isotopes are inseparable by chemical means, I think that the most natural conclusion to draw is that the difference in the entropies of the reactants and resultants of a chemical change taking place at zero temperature is a finite quantity which depends on the type of the change, and also, of course, on the number of molecules transformed.

Jesus College, Oxford. D. L. CHAPMAN.

### Anti-Gas Fans.

OWING to my absence from home I did not see Prof. Allmand's letter in NATURE of June 10 on my indictment of the War Office until too late to reply to it last week, but I hope you will now allow me to put before your readers a few of the points he has missed.

First, may I repeat that I had no personal interest in the number of fans sent out, since I neither asked for nor would accept payment or reward of any kind or description for their use during the war. I attributed the suffering and loss of life, which I deplore and Prof. Allmand denies, even more to the lack of training, and consequent ignorance of what the fans could do, than to their scarcity.

From this letter I gather that his own knowledge concerning them is of the slightest. He seems never to have heard of the clearing of trenches with them, the purpose to which they were principally put; but he allows that they were "found useful" for clearing shelters and dug-outs that would otherwise have remained dangerous for "hours, or even days," after a gas attack. We have only to picture our men, after hours of hard fighting, perhaps wounded or already gassed, compelled to remain in the open, whatever the weather, with the remains of gas still there, to realise the vital importance of clearing every space, dug-out, and shelter the moment it was possible. Yet for a whole year (May, 1915, to May, 1916) the use of the fans with which it could always have been done in a few minutes was held up by the wilful obstruction of War Office officials. It must be remembered, too, that at the beginning of that year the respirators were still quite crude and untrustworthy, and that even by the end of it they were very far from perfect. Is it too much to say, then, that "much suffering and loss of life could have been avoided" had the fans been accepted, and the troops properly trained to use them, nine months earlier, as they could so well have been? On this point Prof. Allmand is silent.

He says that, later, fires were found to be as efficacious as, and less fatiguing than, fans. They were not as efficacious, but they were certainly less fatiguing, as I have said, when the materials were ready to hand; and it was perfectly right to use them when practicable. But each time a space was cleared by fire, fresh dry wood and paper were required. Now it is common knowledge that there were wide areas which, over long periods, were so wet that dry wood for even one clearing would have been hard to find,

let alone many. Is it an exaggeration to say that "much suffering and loss of life could have been avoided" if those responsible had remembered this, and had provided not only plenty of fans for every area, but also men trained to use them? On this point also Prof. Allmand is silent.

"Working an Ayrton fan, even in the most approved fashion"—my italics—he says, ". . . is a tiring task." Prof. Allmand will, I am sure, be surprised to learn that there are at least three approved fashions, and that the efficiency of the fans depends almost more on the ability of the officer in charge to choose the right method for the particular space, and to place and move his men properly, than on the skill of the welders; moreover, the approved methods are not less fatiguing than the wrong ones, only infinitely more efficient. This ignorance on the part of an authority on anti-gas methods is not unique; it is typical. Let me show how it arises.

As soon as the fans were accepted I warned the War Office that, if they were to be of any value, officers and men alike *must* have two or three days' practical training in their use; and, at the request of the Commander-in-Chief, my assistant went to France to show how the training should be carried out. At first, after he left, it may have been fairly well done; but in time those who had seen for themselves what the fans could do died or became scattered; and after that the training degenerated at best into an hour or two of exercise in the stroke for trench-clearing, and at worst into the mere exhibition and naming of a fan, while numbers of men never even saw one at all. Major Gillespie, D.S.O., who practically saved his battery by means of the fans, when a howitzer battery within a hundred yards of it was wiped out, wrote to the *Times* of May 4: "Even after the introduction of the fans in limited quantities, I never met an officer or man who had been properly instructed in their use." This ignorance, for which the War Office is responsible, extended from the highest to the lowest officials in the Anti-Gas Service. The only men who did not share it were those officers who were clever enough and interested enough to make out for themselves what could be done with the fans. Small wonder, then, that most officers regarded them simply as nuisances, and that some of the men treated them as fuel.

This same ignorance and want of imagination led to the idea that the fans were useless for dealing with mustard gas. In describing the saving of his battery Major Gillespie wrote: "The gas hung about for days afterwards, but by judicious flapping at frequent intervals we kept our quarters fairly free from it." This is the evidence of a "fighting soldier." It is odd that those other fighting soldiers quoted by Prof. Allmand should not have thought of this very simple way of ridding themselves of a vapour that came off slowly and took some time to reach a dangerous concentration.

Finally, is not Prof. Allmand in his last sentence confusing scientific methods with the methods of some scientific men? In directing attention to the dire effects of the unscientific methods of the War Office in connection with anti-gas fans, I was adding my quota to the efforts of those who are trying to "ensure the application of scientific methods to military problems." The fact that it was scientific men who were responsible for those unscientific methods is surely no reason for condoning them, but rather for censuring them the more severely.

HERTHA AYRTON.

41 Norfolk Square, W.2, June 22.

At the risk of the accusation of shirking inquiry, I repeat that I have no intention of entering into a



controversy with Mrs. Ayrton. It will suffice to say that she is writing of things of which her knowledge is, naturally, second-hand, besides being clearly very inadequate. This is apparent in at least eight separate points in her letter, of which I will only refer to her mention of the successful use of the fans in what must obviously have been a very exceptional type of "mustard-gas" bombardment. I assure Mrs. Ayrton that she is mistaken if she imagines that she has in this matter any considerable body of support amongst those who knew the facts, from whatever point of view. I hope, in conclusion, that nothing I wrote has led Mrs. Ayrton to suppose that I regard her advocacy of her fans to be influenced by questions of "payment or reward." Nothing was further from my mind.

A. J. ALLMAND.

King's College, W.C.2, June 30.

PROF. ALLMAND, having read neither the specific charges I have made against the War Office nor the evidence, principally from official documents, with which I have sustained them, attempts to counter them with statements unsupported by evidence of any kind. He finds me ignorant, for instance, on eight points, of which the only one he names is obviously no matter either of my knowledge or ignorance, since it refers simply to a quotation from the letter of a very able and gallant "fighting soldier." Had he read the article he criticises he would have seen the whole quotation.

I am ready to sustain those charges, and to produce the evidence before any proper tribunal. I repeat them.

I accuse the War Office of having caused great loss of life and much avoidable suffering by:

- (1) Having refused for a whole year to make use of anti-gas fans, which they were yet compelled finally to adopt owing to their proved efficacy.
- (2) Never having set up an efficient organisation for training officers and men in their use, although I had warned them that this was indispensable.
- (3) Having thus deprived the troops of the knowledge requisite for understanding what could be done with the fans, and having thereby induced the idea that they were useless.
- (4) Having trusted entirely to fires for clearing dug-outs of gas, regardless of the fact that in many places dry wood and paper were often unobtainable.
- (5) Ranking sandbags and ground-sheets as of equal efficacy with fans for clearing gas.
- (6) Sending out an inadequate supply.

The scientific men implicated in these grave charges have not even made the plain statement with regard to them that the Editor of NATURE considered so desirable, much less produced any evidence in refutation of them.

HERTHA AYRTON.

July 11.

THE continuance of this correspondence in our columns would not, we think, serve any useful purpose. In a note in NATURE of May 13 it was pointed out that Mrs. Ayrton's indictment of the War Office was "not against the military element, but rather against the experts who were associated with the Gas Service." It is easy to understand the reluctance of these officers to express their views upon anti-gas fans, even if they were free to do so; and though Mrs. Ayrton is anxious to have all the facts judged by a tribunal appointed for that purpose, we must confess that the likelihood of a scientific body constituting such a tribunal is very remote. The inquiry is one that the Conjoint Board of Scientific Societies could take up appropriately, but no satisfactory conclusion could be reached without examining a number of witnesses, and the resources and powers of the

Board are scarcely sufficient for such action. The only practicable course, therefore, would seem to be for the War Office to appoint a Committee to investigate Mrs. Ayrton's charges, and in the interests of scientific truth and efficiency we hope this will be done.—ED. NATURE.

### The Stretching of Rubber in Free Balloons.

IN NATURE of June 10, p. 454, in connection with the attainment of high levels of the atmosphere by sounding- or pilot-balloons, Mr. W. H. Dines considers that such balloons would burst before reaching great heights, as the rubber of which these balloons are made would be stretched eightfold linearly, and he remarks that he does not think that any rubber will stand this treatment.

Properly vulcanised soft rubber will, however, stretch to more than ten times its original length if in the form of a ring-shaped test-piece. Moreover, the load increases more rapidly than the elongation at the later stages. The remarkable tensile properties of soft rubber are not always sufficiently recognised. The breaking strain of a properly vulcanised sample should be not less than 1500 grams per sq. mm. cross-sectional area of the original test-piece. Allowing for the stretching, which would reduce the cross-sectional area to one-tenth, the breaking strain would be 15,000 grams per sq. mm. cross-sectional area of the sample when fully elongated, or nearly 10 tons per sq. in. It would not, however, be safe to rely on these figures, as the rubber of the balloon would tear at the neck where it is tied together before the bursting pressure was reached. Mr. Dines has also failed to take into consideration the fact that part of the hydrogen would be lost by diffusion during the ascent of the balloon, which would reduce the pressure of the contained gas.

HENRY P. STEVENS.

15 Borough High Street, London  
Bridge, S.E.1, June 29.

WITH reference to Mr. Stevens's interesting statements about the stretching of rubber, I think he has overlooked the fact that in a balloon the rubber is stretched simultaneously in both directions, whereas he refers apparently to one direction only.

I have cut a strip half an inch wide from a balloon used at Benson; it stretched sevenfold before breaking, but when extended sixfold its width was reduced from 0.50 in. to 0.22 in., instead of being extended to 3.00 in., as would be the case in actual use. Its unstretched thickness was 0.013 in., its thickness at breaking greater than 0.004 in., but when extended sixfold each way its thickness would only be 0.00036 in.

The loss of hydrogen by diffusion or leakage is equivalent to not giving the balloon so large a free lift at starting, and would alone increase the height, but in practice it sometimes leads to the bursting height not being reached at all because the free lift has vanished before that point is reached. It has been found that within fairly wide limits the maximum height is only slightly dependent on the free lift at starting. But diffusion of the hydrogen outwards is accompanied by diffusion of air inwards, and this increases the specific gravity of the gas and lessens the height.

I did not mention the effect of the tension of the rubber on the pressure, and therefore on the specific gravity, of the enclosed gas. Taking Mr. Stevens's figure of a breaking strain of 15,000 grams per sq. mm. of unstretched section, this will raise the internal pressure by quite an appreciable amount, and thereby reduce the height at which the balloon bursts, Benson.

W. H. DINES.

### Note on the Habits of the Tachinid Fly, *Sphexapata (Miltogramma) conica*.

FABRE has given a graphic account of the patient watch of this parasitic cuckoo-fly at the mouth of the burrow of a species of *Bembex*, and of its cunning in seizing the moment when the "wasp" is halt within the burrow to deposit its tiny egg, pregnant with disaster to the *Bembex* offspring, upon the body of the insect victim intended for the larder-nursery wherein the mother *Bembex*'s hopes are laid. He does not, however, appear to have witnessed in the tragedy a phase that recently came under my notice, and that is possibly restricted to, or perhaps only easily observed, in cases where the foster-host carries its prey along the surface of the ground, or at best flies only just clear of the ground.

On the afternoon of June 22, when on one of the heaths in this neighbourhood, I caught sight of a black Fossor, *Tachytes unicolor*, carrying a paralysed grasshopper. I followed, hoping to secure a photograph of its operations at the burrow. Soon I discovered that I was not the only follower, for at a distance of about four inches there followed a small Tachinid fly, which Mr. J. E. Collin has kindly identified as *Sphexapata conica*. The fly followed the "wasp" with the utmost accuracy, maintaining its distance with a precision that suggested a rigid connection between the two insects; if the "wasp" flew, the fly flew; if the "wasp" crawled, or indeed took but a single step, the fly did exactly the same; and always keeping distance accurately. For more than fourteen yards—and there may have been many more before I came upon the scene—did the fly thus follow in the wake of the "wasp," until at length the burrow was reached. The "wasp" at once entered, leaving the grasshopper lying, belly upwards, at the burrow's mouth; but before the owner was out of sight the fly darted upon the grasshopper, without a moment's delay deposited an egg on its thorax, and flew off—into my net.

Fabre says nothing as to the distance at which the fly stations itself when keeping watch at the mouth of the burrow, nor of the interval between each individual when several "in a geometrical line" are awaiting the critical moment; but the constancy with which the fly kept station in the journey across the heath, and the precision with which every movement of the "wasp" was copied, suggested that at that particular distance a clearer visual image was secured than at any other. Be this as it may, the fact is worth consideration in discussing insect vision.

To this note I may appropriately add an observation made last year while watching an *Ammophila sabulosa* filling in its completely stocked burrow. On a stone close by there sat a small fly absolutely motionless, and apparently intently watching the proceedings. As soon as *Ammophila* had finished its work and flown off, the fly leapt from its perch, and at once began to scratch away the sand and small stones in an endeavour to get at the larvæ in the subterranean larder. Fortunately, *Ammophila* had packed its burrow too well, and the fly flew off defeated. This fly closely resembled *Sphexapata conica*, but may have been an allied species.

Sharp ("Camb. Nat. Hist.," vol. vii., p. 509) mentions the fact that *Miltogramma* follows *Hymenoptera* carrying prey.

OSWALD H. LATTER.

Charterhouse, Godalming, July 4.

### Temperature Variations at 10,000 ft.

A SERIES of 500 aeroplane observations in North-East France in 1918-19 throws some light on the problem of temperature variations in the upper air. The correlation coefficient between pressure and tem-

perature at 10,000 ft., taking all the observations together, is 0.73. If the seasonal variations are allowed for by taking the deviations from Mr. W. H. Dines's smoothed monthly means, the coefficient is 0.69. The former value is higher, as the annual variations of temperature and pressure in the upper air are in the same phase. Both figures are rather lower than the value 0.77 for 3 km, obtained by Mr. Dines from balloon soundings, the observations being grouped in three-monthly periods. The value 0.69 implies that a proportion  $\sqrt{1-0.69^2}$ , or 72 per cent., of the standard deviation is still unaccounted for. The partial correlation coefficient between the temperature and the southerly component of the wind velocity at 10,000 ft. (allowing for the pressure) is 0.44, so that the southerly component accounts for 10 per cent. of the temperature variations which are independent of the pressure, or 7 per cent. of the total variations. The effect of the west component of the wind velocity is practically negligible at all seasons.

There are strong grounds for believing that a large proportion of the temperature variations depends upon whether the air supply was drawn originally from the polar basin or the equatorial belt. This view is supported by the humidity observations which were made at the same time as those for temperature. For reasons set out in a paper which I hope to publish, the original source of the air supply is not very closely related to the wind velocity at the place of observation, both polar and equatorial currents frequently following curved paths. This factor of air supply operates in a very irregular manner, with the result that the correlation coefficients vary greatly from month to month. The coefficient connecting pressure and temperature at 10,000 ft. for the period January-February, 1919, based on fifty observations, is as low as 0.09. In the winter especially there are large fluctuations of the upper-air temperature, the changes occasionally exceeding 30° F. within forty-eight hours both at 10,000 ft. and 44,000 ft.

Mr. Dines gives a value 0.86 to the pressure-temperature correlation coefficient from 5 km. to 8 km., but this accounts for only half the temperature variations.

C. K. M. DOUGLAS.

Meteorological Office, Air Ministry, W.C.2,

July 8.

### The Brent Valley Bird Sanctuary.

SUNDAY next, July 18, is the two hundredth anniversary of the birth of Gilbert White of Selborne, who did more than any other of our countrymen to create an interest in birds. The moment is therefore ripe for an appeal upon their behalf, and for suggesting how a fitting memorial to him may be established.

The work which the Selborne Society has done in the Brent Valley Bird Sanctuary, in the way of preserving birds and testing nesting-boxes for use elsewhere, is well known and has some considerable value. The owners of the freehold wish now to develop their estate, and if the money necessary to buy the property is not forthcoming the sanctuary will go.

Matters have been made as easy as possible for us, and we have been asked only 4500l. for twenty-two acres of building land which comes into the London postal district.

May I, as chairman of the Bird Sanctuary Committee, invite the help particularly of those who are fond of birds and of open spaces to save the wood? Those who have been immediately interested in the work have subscribed 300 guineas to start the fund.

WILFRED MARK WEBB.

The Hermitage, Hanwell, W.7, July 10.

## Researches on Growth of Plants.

By SIR JAGADIS CHUNDER BOSE, F.R.S.

## I.—The High Magnification Crescograph.

INVESTIGATION on growth is a matter of much practical importance, since the world's food supply is intimately dependent upon vegetative growth. The movements of stems, leaves, and roots under the action of various forces, such as light, warmth, and gravity, are often due to minute variations in the rate of growth. The discovery of laws relating to the movement of growing organs thus depends on the accurate measurement of normal growth and its changes. The great difficulty of the investigation arises from the extraordinary slowness of growth, the average value of which per second may be taken as  $\frac{1}{100000}$  in., or half the wave-length of sodium light. The "auxanometers" usually employed produce a magnification of about twenty times. Even here several hours must elapse before growth becomes perceptible, but during this long period the external conditions such as warmth and light would necessarily change, thus vitiating the results; moreover, autonomous variation of growth appears during lengthy periods. The elements of uncertainty can be removed only by reducing the period of experiment to a few minutes; but that would necessitate devising a method of very high magnification and the automatic record of the magnified rate of growth. I have been successful in this by my device of the High Magnification Crescograph, consisting of a system of two levers; the first magnifies a hundred times, and the second enlarges the first a hundredfold, the total magnification being 10,000 times. The various difficulties connected with the weight and friction at the bearing have been fully overcome.<sup>1</sup> The further difficulty in obtaining an accurate record of growth movement arising from friction of continuous contact of the writing point was removed by an oscillating device by which the smoked glass plate moves to and fro at regular intervals of time, say one second (Fig. 1). The record consists of a series of dots, the distance between successive dots representing magnified growth during a second (Fig. 2a).

The records may be taken on a stationary plate, first under normal, and then under changed, external conditions. The increase or diminution of space between successive dots in the two series demonstrates the stimulating or depressing nature of the changed condition (Fig. 2d); or the record may be taken on a plate moving at a uniform rate. In the curve thus obtained the ordinate represents growth-elongation, the abscissa the

time. If a stimulating agent enhances the rate of growth, this fact is exhibited by a flexure in the curve upwards; a depressing agent, on the other hand, lessens the slope of the curve (Fig. 2b).

*Precautions against Physical Disturbance.*—The effect of vibration may be neutralised by placing india-rubber sponges under the legs of a heavy table supporting the apparatus. It is preferable to screw the supporting bracket on a wall. I have, indeed, been able to secure a magnification of ten million times with my Magnetic Crescograph in public demonstrations in busy London,

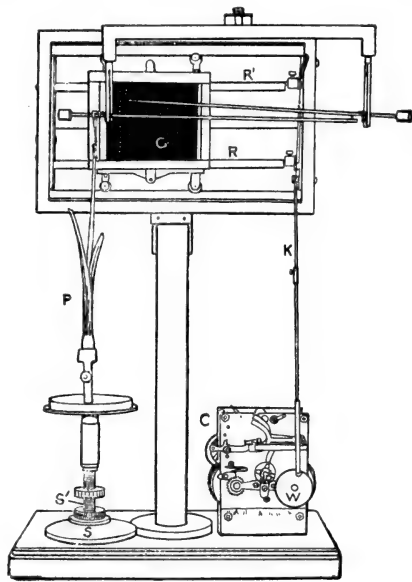

FIG. 1.—The High Magnification Crescograph. P, plant; S, S', micrometer screw for raising or lowering the plant; C, clockwork for periodic oscillation of plate; K, crank; W, rotating wheel.

the indication of the instrument being quite unaffected by the street traffic. In Fig. 2c is given the record on a moving plate taken with the High Magnification Crescograph. A dead twig had been substituted for the growing plant, and a perfectly horizontal record demonstrated the absence not only of growth, but also of all disturbance. There is an element of physical change in experiments on variation of the rate of growth under artificially raised temperature. In order to determine its character and extent, a record was taken with the dead twig of the effect of raising the temperature of the plant-chamber through  $10^{\circ}$  C. The record shows that there was an expansion during rise of temperature, which, however,

<sup>1</sup> For a fuller account see the author's "Researches on Growth and Movement in Plants by means of the High Magnification Crescograph," *Proc. Roy. Soc., B*, vol. cx., 1919. (The diagrams are reproduced with the kind permission of the Royal Society.) Also the following works published by Messrs. Longmans, Green, and Co.:—"Response in the Living and Non-living" (1902); "Plant Response" (1906); "Comparative Electrophysiology" (1907); "Irritability of Plants" (1913); "Life-movements in Plants," vols. i. and ii. (1918-19).

reached a limit, the record becoming once more horizontal. The obvious precaution to be taken in the study of variation of growth under change of temperature is to wait for several minutes for the attainment of steady temperature. The elongation caused by physical change abates in a short time, whereas the physiological variation in the rate of growth is persistent.

In Fig. 2a is given a record of growth of *Scirpus kysoor*; the growth per second magnified ten thousand times is 9.5 mm. The absolute rate of growth per second is therefore 0.00095 mm., or 0.95 $\mu$ , where  $\mu$  or micron is 0.001 mm.

**Effect of Stimulus on Growth.**—A generalisation was obtained that all forms of stimuli, mechanical, electrical, or radiational, induce a retardation of the rate of growth; under increasing intensity or duration of stimulus this retardation may culminate in an arrest of growth or even in actual contraction of the organ. As regards radiation, all rays of the vast æthereal spectrum (with

rendered possible. We have been using a few stimulating agents, whereas there are thousands of the action of which we have no conception. The rule-of-thumb methods often employed in the application of a few chemical agents and of electricity have not been uniformly successful. The cause of the anomaly is found in the discovery of an important factor—namely, the dose of application—which had not hitherto been taken sufficiently into account.

**The Balanced Crescograph.**—The high sensitiveness already secured has been very greatly enhanced by the employment of the Null Method or the Method of Balance, where the rate of up-movement of growing tip is exactly compensated by the down-movement of the plant. A train of revolving clock-wheels, actuated by the fall of a weight, lowers the plant at the required rate. The exact adjustment is obtained by the right- or left-handed turning of a screw which regulates the governor. In this way the rate of growth becomes

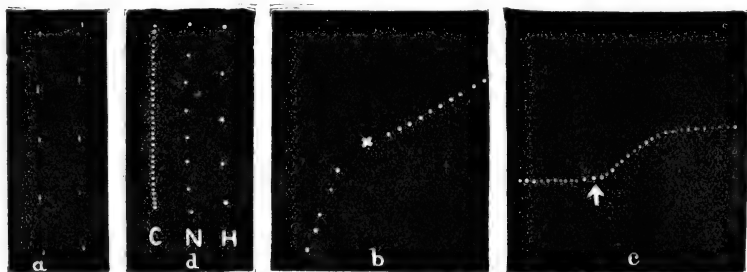

Fig. 2.—Crescographic records. *a*, Successive records of growth at intervals of 1 second;  $\times 10,000$ , with a stationary plate. Effect of temperature: *d*, *N*, normal rate of growth; *C*, retarded rate under cold; *H*, enhanced rate under warmth; *b*, record on moving plate where diminished slope of curve denotes retarded rate under cold; *c*, horizontal record showing absence of growth in dead branch; physical expansion on application of warmth at arrow followed by horizontal record on attainment of steady temperature.

the exception of red and yellow rays which cause photo-synthesis) are found to cause response by modifying the rate of growth of the plant. I have thus been able to obtain records of response of plants to long æther waves employed in signalling through space. (NATURE, October 30, 1919.)

**Effect of Sub-minimal Stimulus.**—A very unexpected result was obtained under the action of sub-minimal stimulus, which induced an acceleration of growth instead of retardation under moderate intensity. This I find to be true of stimulation as diverse as that caused by electric shock, by light, and by chemical agents. A strikingly practical result was obtained with certain poisons which in normal doses killed the plant, but which in quantities sufficiently minute acted as an extraordinarily efficient agent for stimulating growth, the treated plants growing far more vigorously and flowering much earlier. It is only by the discovery of laws of growth that any marked advance in scientific agriculture will be

exactly compensated, and the recorder now dots a horizontal line instead of the former curve of ascent. The turning of the adjusting screw also moves an index against a circular scale so graduated that its reading at once gives the rate at which the plant is growing at the moment. When balanced, the recording apparatus is extremely sensitive, the effect of

any change in the environment, however slight, being at once indicated by the upset of balance with the up or down movement of the indicator. I have in this way been able to detect induced variation in the rate of growth so exceedingly minute as  $\frac{1}{100000}$  in. per second. An illustration of the delicacy of the method will be found in the record given in Fig. 3, on the effect of carbonic acid gas on growth; there is an immediate acceleration of growth (up-record), which continues for two and a half minutes; this is followed by retardation, as shown by the down curve. With diluted carbonic acid the acceleration may persist for a considerable time. As another instance of the delicacy of the method of balance, I obtained a decided response of the plant to the light so fleeting as that of a single electric spark the duration of which is of the order of  $\frac{1}{100000}$  second.

**The Magnetic Crescograph.**—There is a limit to the magnification obtained by a compound

system of levers; an additional lever increases the weight and friction. For special research and for public demonstration a still higher magnification is necessary, and this I secured by the invention of the Magnetic Crescograph, where a fine magnetised lever causes by its movement a rotation

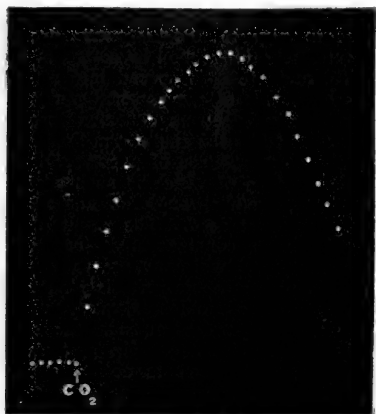

FIG. 3.—Record showing the effect of carbonic acid gas. Horizontal line at the beginning indicates balanced growth. Application of carbonic acid gas induces enhancement of growth, shown by up-curve, followed by depression, exhibited by down-curve. Successive dots at intervals of ten seconds.

of a suspended system of astatic needle with its attached mirror. By graduated approach of the suspended needle to the lever the magnification may be continuously increased from a million to ten million times. A concrete idea of the stupendous magnification will be obtained if we imagine

the slow pace of the proverbial snail magnified ten million times. The 15-in. gun of the *Queen Elizabeth* throws out a shell with a muzzle-velocity of 2360 ft. per sec., but the crescographic snail would move twenty-four times faster than the cannon shot. The magnification of ten million times was obtained with a single lever, but a double lever will enlarge it a hundredfold—that is to say, it will give a total magnification of a thousand million times. The importance of this device for research in other branches of science is sufficiently obvious. For general purposes a magnification of a million times is sufficient; with ordinary precaution the apparatus may be rendered free from mechanical disturbance, and the zero-keeping quality of the indicating spot of light is quite perfect.

The following account of an experiment in demonstration of physiological response in a growing plant will be found interesting. The normal growth of the plant was indicated by the excursion of the spot of light through 6 metres in 10 secs. On introduction of chloroform vapour to the plant-chamber there was an immediate enhancement of the rate of growth, the spot of light moving three times faster. Continued action of the vapour of chloroform caused, however, a depression and arrest of growth; finally, there was a sudden contraction, which proved to be the spasm of death. Similar effects were produced by various poisons like the solution of potassium cyanide.

After this brief account of the very sensitive methods for the detection and record of the effect of stimulus on growth, I propose in another article to describe results which will offer an explanation of the tropic movements in plants induced by various stimuli of the environment.

## Isotopes and Atomic Weights.

By DR. F. W. ASTON.

IN the atomic theory put forward by John Dalton in 1801 the second postulate was: "Atoms of the same element are similar to one another and equal in weight." For more than a century this was regarded by chemists and physicists alike as an article of scientific faith. The only item among the immense quantities of knowledge acquired during that productive period which offered the faintest suggestion against its validity was the inexplicable mixture of order and disorder among the elementary atomic weights. The general state of opinion at the end of last century may be gathered from the two following quotations from Sir William Ramsay's address to the British Association at Toronto in 1897:—

There have been almost innumerable attempts to reduce the differences between atomic weights to regularity by contriving some formula which will express the numbers which represent the atomic weights with all their irregularities. Needless to say, such attempts have in no case been successful. Ap-

parent success is always attained at the expense of accuracy, and the numbers reproduced are not those accepted as the true atomic weights. Such attempts, in my opinion, are futile. Still, the human mind does not rest contented in merely chronicling such an irregularity; it strives to understand why such an irregularity should exist. . . . The idea . . . has been advanced by Prof. Schutzenburger, and later by Mr. Crookes, that what we term the atomic weight of an element is a mean; that when we say the atomic weight of oxygen is 16, we merely state that the average atomic weight is 16; and it is not inconceivable that a certain number of molecules have a weight somewhat higher than 32, while a certain number have a lower weight.

This idea was placed on an altogether different footing some ten years later by the work of Sir Ernest Rutherford and his colleagues on radioactive transformations. The results of these led inevitably to the conclusion that there must exist elements which have chemical properties identical for all practical purposes, but the atoms of

which have different weights. This conclusion has been recently confirmed in a most convincing manner by the production in quantity of specimens of lead from radio-active and other sources, which, though perfectly pure and chemically indistinguishable, give atomic weights differing by amounts quite outside the possible experimental error. Elements differing in mass but chemically identical and therefore occupying the same position in the periodic table have been called "isotopes" by Prof. Soddy.

At about the same period as the theory of isotopes was being developed by the radio chemists at the heavy end of the periodic table an extremely interesting discovery was made by Sir J. J. Thomson, which carried the attack into the region of the lighter and non-radio-active elements. This was that, when positive rays from gases containing the element neon were analysed by electric and magnetic fields, results were obtained which indicated atomic weights roughly 20

radio-active elements were concerned, and a good deal of theoretical speculation had been made as to its applicability to the elements generally. As separation by diffusion is at the best extremely slow and laborious, attention was again turned to positive rays in the hope of increasing the accuracy of measurements to the required degree. This was done by means of the arrangement illustrated in Fig. 1. Positive rays are sorted into an extremely thin ribbon by means of parallel slits  $S_1$ ,  $S_2$ , and are then spread into an electric spectrum by means of the charged plates  $P_1$ ,  $P_2$ . A portion of this spectrum deflected through an angle  $\theta$  is selected by the diaphragm D and passed between the circular poles of a powerful electromagnet O the field of which is such as to bend the rays back again through an angle  $\phi$  more than twice as great as  $\theta$ . The result of this is that rays having a constant mass (or more correctly constant  $m/e$ ) will converge to a focus F, and that if a photographic plate is placed at GF

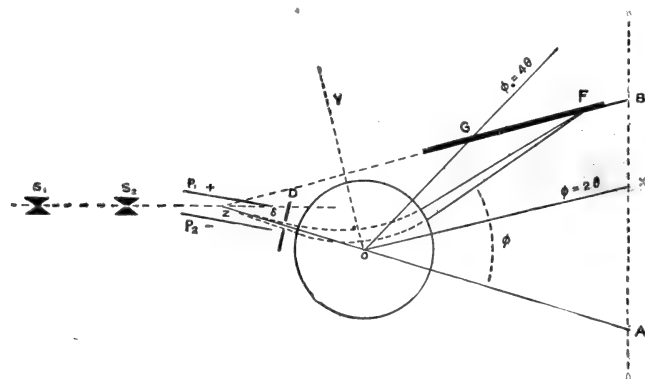

FIG. 1.—Diagram of positive-ray spectrograph.

and 22 respectively, the accepted atomic weight being 20.2. This naturally led to the expectation that neon might be a mixture of isotopes, but the weight 22 might possibly be due to other causes, and the method of analysis did not give sufficient accuracy to distinguish between 20.0 and 20.2 with certainty. Attempts were made to effect partial separation first by fractionation over charcoal cooled in liquid air, the results of which were absolutely negative, and then by diffusion, which in 1913 gave positive results, an apparent change in density of 0.7 per cent. between the lightest and heaviest fractions being attained after many thousands of operations. When the war interrupted the research, it might be said that several independent lines of reasoning pointed to the idea that neon was a mixture of isotopes, but that none of them could be said to carry the conviction necessary in such an important development.

By the time work was started again the isotope theory had been generally accepted so far as the

as indicated, a spectrum dependent on mass alone will be obtained. On account of its analogy to optical apparatus, the instrument has been called a positive-ray spectrograph and the spectrum produced a mass-spectrum.

Fig. 2 shows a number of typical mass-spectra obtained by this means. The number above the lines indicates the masses they correspond to on the scale  $O=16$ . It will be noticed that the displacement to the right with increasing mass is roughly linear. The measurements of mass made are not absolute, but relative to lines the mass of which is known. Such lines, due to

hydrogen, carbon, oxygen, and their compounds, are generally present as impurities or purposely added, for pure gases are not suitable for the smooth working of the discharge tube. The two principal groups of these reference lines are the  $C_1$  group due to C (12), CH (13),  $CH_2$  (14),  $CH_3$  (15),  $CH_4$  or O (16), and the  $C_2$  group 24-30 containing the very strong line 28  $C_2H_4$  or CO. In spectrum i. the presence of neon is indicated by the lines 20 and 22 situated between these groups. Comparative measurements show that these lines are 20.00, 22.00, with an accuracy of one-tenth per cent., which removes the last doubt as to the isotopic nature of neon.

The next element investigated was chlorine; this is characterised by four strong lines 35, 36, 37, 38, and fainter ones at 39, 40; there is no trace of a line at 35.46, the accepted atomic weight. From reasoning which cannot be given here in detail it seems certain that chlorine is a complex element, and consists of isotopes of atomic weights 35 and

37, with possibly another at 39. The lines at 36, 38 are due to the corresponding HCl's.

Particles with two, three, or more electronic charges will appear as though having half, a third, etc., their real mass. The corresponding lines are called lines of the second, third, or higher order. In spectrum ii. the lines of doubly charged chlorine atoms appear at 17.5 and 18.5. Analyses of argon indicate that this element consists almost entirely of atoms of weight 40, but a faint component 36 is also visible. Spectra v. and vi. are taken with this gas present; the former shows the interesting third order line at 133. Krypton and xenon give surprisingly complex

method (see *Phil. Mag.*, May, 1920, p. 621), some results of which are given in spectrum vii., hydrogen is found to be 1.008, which agrees with the value accepted by chemists. This exception from the whole number rule is not unexpected, as on the Rutherford "nucleus" theory the hydrogen atom is the only one not containing any negative electricity in its nucleus.

The results which have so far been obtained with eighteen elements make it highly probable that the higher the atomic weight of an element, the more complex it is likely to be, and that there are more complex elements than simple. It must be noticed that, though the whole number rule

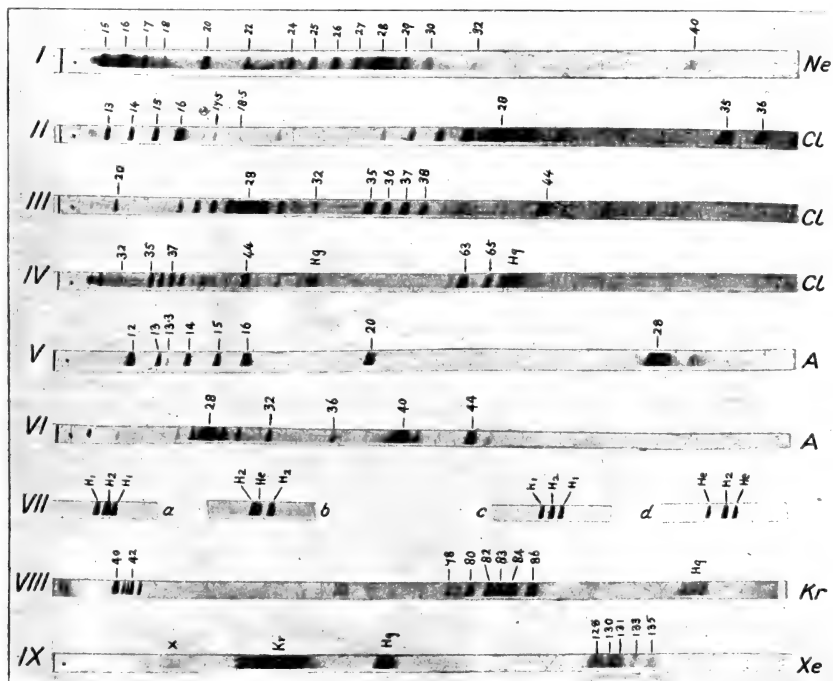

FIG. 2.—Typical mass-spectra.

results; the former is found to consist of no fewer than six isotopes, the latter of five (spectra viii. and ix.). Mercury is certainly a complex element probably composed of five or six isotopes, two of which have weights 202 and 204; its multiply charged atoms give the imperfectly resolved groups, which are indicated in several of the spectra reproduced in Fig. 2.

By far the most important result obtained from this work is the generalisation that, with the exception of hydrogen, all the atomic weights of all elements so far measured are exactly whole numbers on the scale O=16 to the accuracy of experiment (1 in 1000). By means of a special

asserts that a pure element must have a whole number atomic weight, there is no reason to suppose that all elements having atomic weights closely approximating to integers are therefore pure.

The very large number of different molecules possible when mixed elements unite to form compounds would appear to make their theoretical chemistry almost hopelessly complicated, but if, as seems likely, the separation of isotopes on any reasonable scale is to all intents impossible, their practical chemistry will not be affected, while the whole number rule introduces a very desirable simplification into the theoretical aspects of mass.

## Obituary.

MAJOR-GEN. WILLIAM CRAWFORD GORGAS,  
K. C. M. G.

IN St. Paul's Cathedral on July 9 a very remarkable tribute was paid to one who may fittingly be termed a Napoleon of Hygiene. On that day a military funeral was accorded to the remains of Major-Gen. William Crawford Gorgas, Surgeon-General of the United States Army and president of the American Medical Association. The impressive service was attended by a large concourse, including the Director-General of the Army Medical Department, who represented the King, the Director-General of the Medical Department of the Navy, the Presidents of the Royal Colleges of Physicians and Surgeons, the Presidents of the Royal Society of Medicine and the Royal Society of Tropical Medicine and Hygiene, and representatives of other learned societies and scientific institutions. Had the late Gen. Gorgas been a British subject such a tribute to his life and work would have been sufficiently noteworthy, but that a citizen and soldier of the United States should be honoured by these funeral rites is a unique testimony, not only to the man who fought and conquered yellow fever, but also to preventive medicine generally.

It is right that it should be so, and to no one could such an honour be more fittingly paid than to the man who devoted himself heart and soul to making the tropics healthy and habitable and, above all others, translated the pioneer scientific work of Laveran, Manson, Ross, Grassi, Finlay, and others into action.

Gorgas's life, one of ceaseless activity in the cause of science and humanity, began on October 3, 1854, when he was born at Mobile, Alabama, and terminated in the Queen Alexandra Military Hospital, London, on July 3. Death overtook him on his way to a new field of work, for he was taken seriously ill in England when en route to the West Coast of Africa with the view of studying the yellow fever problem there, a problem by no means solved and differing in some respects from that which presented itself in the New World.

Gorgas was a son of the South, his father being Gen. Josiah Gorgas, of the Confederate States Army, and his mother a member of a Southern family. He received his medical training at the Southern University, Tennessee, where he graduated A.B., and in 1879 he qualified M.D. at the Bellevue Hospital Medical College of New York University, thereafter holding a house appointment in the hospital.

In 1880 Gorgas joined the United States Army as a surgeon and served in various parts of the country, first coming into contact with yellow fever in Western Texas and himself suffering from an

attack of the disease. His promotion in the service was rapid, and, his bent being towards the preventive side of medicine, the year 1898 saw him appointed Chief Sanitary Officer of Havana. At that time Havana was a hot-bed of yellow fever, and Surgeon-Major Gorgas found plenty of scope for his energies. While his colleagues Reed, Carroll, Agramonte, and Lazear established the rôle of *Stegomyia fasciata* as the vector of the then unknown parasite of yellow fever, Gorgas, as soon as he was certain of the facts, embarked wholeheartedly on an anti-mosquito campaign which in a remarkably short space of time freed Havana from the scourge of "Yellow Jack." It was then that he first displayed to the full those qualities of drive, tact, tenacity, firmness, and resolution which eventually gained for him the proud titles of "a Master-Administrator of tropical hygiene" and of "a Hercules of modern hygiene."

Gorgas had a wonderful way of getting at the heart of things. He was essentially practical, and this practicality, combined with enthusiasm and a devotion almost religious in character, found a still greater field in Panama. He was rewarded for his labours at Havana by being promoted Colonel and Assistant Surgeon-General in the United States Army, and it was in 1904 that he was sent to the famous isthmus to report upon the sanitary condition of the Canal Zone and to become ere long Chief Health Officer of an area which for centuries had been notorious for its unhealthiness, a region devastated by malaria and yellow fever and a veritable forcing-house for tropical pathology.

At first Gorgas had many difficulties. He was up against the Canal Commissioners; he was at loggerheads with the engineers; he found himself hampered by red-tape and restrictions of all kinds. Fortunately, the reins of power were at that time held in the United States by a man of very similar calibre to himself, and Theodore Roosevelt, realising all that depended on Gorgas's work, and having every sympathy with him and none for hide-bound traditions, swept away the obstacles from his path, and gave him a free hand and full responsibility. This was all Gorgas wanted. He knew, thanks to the work of Manson, Ross, and Finlay in the first place, and to the labours and sacrifices of his colleagues at Havana in the second, that he was on sure ground, and, backed loyally by the governor of the Canal Zone, Judge Magoon, he embarked with a worthy band of helpers and abundant sinews of war upon a campaign which speedily routed the forces of disease and death, rendered the Canal Zone not only habitable, but also healthy, and which will stand for all time as a monument to what can be done when science and administrative hygiene are given ample powers.



The results achieved induced Gorgas to put forward the theory, advanced also by Sambon and others, that if insanitary conditions are removed the white man can not only live and labour in the tropics, but also propagate his race there, and that his descendants will be healthy and virile. It is too early yet to say that this is wholly the case, but it is interesting to note what Gorgas said about this important question. Speaking of his work, he wrote:—

The real scope of tropical sanitation, which has been almost entirely developed within the last fifteen or twenty years, I believe, will extend far beyond our work at Panama. Everywhere in the tropics to which the United States has gone in the past fifteen years it has been shown that the white man can live and exist in good health. This has occurred in the Philippines, in Cuba, and in Panama, but the demonstration has been most prominent and spectacular at Panama, and therefore has attracted there the greatest world-wide attention. Here among our large force of labourers we had for ten years some ten thousand Americans—men, women, and children. Most of these American men did hard manual labour, exposed to the sun, rain, and weather conditions day in and day out, yet during that time their health remained perfectly good, just as good as if they were working at home. The same remark as to health would apply to the four thousand women and children who lived at Panama with their husbands and fathers. Both the women and children remained in as good condition as they would have been had they lived in the United States. This condition at Panama, I think, will be generally received as a demonstration that the white man can live and thrive in the tropics. The amount of wealth which can be produced in the tropics for a given amount of labour is so much larger than that which can be produced in the temperate zone by the same amount of labour that the attraction for the white man to emigrate to the tropics will be very great when it is appreciated that he can be made safe as to his health conditions at a small expense. When the great valleys of the Amazon and of the Congo are occupied by a white population more food will be produced in these regions than is now produced in all the rest of the inhabited world.

Panama made Gorgas famous; the Royal Society awarded him its Buchanan medal; the University of Oxford made him an honorary D.Sc.; the Liverpool School of Tropical Medicine presented him with its Mary Kingsley medal; and he was not forgotten in America. He did not, however, rest upon his oars. In 1913 the Chamber of Mines at Johannesburg sought his advice as regards the prevention of pneumonia among native miners on the Rand, and he proceeded to South Africa and carried out an investigation which led to useful results. He then turned his attention to South America, for the dream of his life—and no vain dream—was to stamp yellow fever out of the world. He made a survey of the endemic foci in South America, and then started to obliterate the worst of them at Guayaquil, in Ecuador. Here, again, his efforts and those of his assistants were crowned with success, and it is a tribute to his tact and discretion that so much could be accomplished in one of the

lands of *mañana*, as some of the Spanish South American republics may be not inaptly called.

As director of the International Health Board of the Rockefeller Institute, a post to which he was appointed on the completion of the Panama Canal, Gorgas had excellent facilities for travel and investigation, and he became an apostle, as well as a priest, of the goddess Hygeia. As Surgeon-General of the United States Army, he had to organise the medical service for the Great War, and during the war he visited both France and Serbia, retiring, however, from the United States Army in 1918 under the age-rule.

Scarcely had hostilities ceased when his attention turned again to yellow fever, and along with Surgeon-Gen. Noble and Dr. Guiteras, of Havana, he was, as stated, on his way to the African West Coast, when he was stricken down by what proved to be a fatal illness. On his sick bed he was visited by the King, who conferred a K.C.M.G. upon him, and just before he took ill, when he was in Brussels at the Congress of the Royal Institute of Public Health, he was presented with the Harben gold medal, while at the recent annual meeting of the British Medical Association the University of Cambridge conferred upon him its honorary LL.D.

Gorgas died full of honours, if not of years. His work received its rightful recognition, and if he died comparatively early it must be remembered that his life was a very strenuous one, spent to a large extent in hot climates, and that he came very near to realising his lifelong ambition.

He was a man of resource and courage, but he was also a man with a kindly heart and a gratifying sense of humour. He knew how to handle those serving under him, and how to get the best out of them, while he gave credit where credit was due.

It has been said of him, sometimes bluntly, sometimes even rudely, that, in the strict sense of the term, he was not a scientific worker, but the fact remains that Gorgas worked ever on strictly scientific lines, and that the moment a scientific truth had been enunciated he was up and doing in order to apply it for the welfare of mankind. Without men of his stamp the labour of the microscopists would to a large extent be futile. His art was the natural corollary of the laboratory, and no more efficient exponent of it can be imagined.

As his coffin, shrouded by "Old Glory," borne by stalwart British Guardsmen, flanked by British medical officers of high rank, and followed by his widow and a distinguished company, passed up the aisle of St. Paul's, it was in keeping with his life's work that, amongst the wreaths waiting to be placed upon it, was one sent as a token of remembrance and esteem by his friend Sir Patrick Manson.

## Notes.

THE exhibits of the Research Department, Woolwich, at the Imperial War Museum, Crystal Palace, illustrate some of the work vital to the war which was done there, and incidentally our unpreparedness, as much of it might have been done before. Amongst the specimens shown are the six isomers of T.N.T., isolated whilst devising new processes for the manufacture of the symmetrical variety, and for cheaply eliminating the undesirable isomers—a problem not yet fully solved. There are also specimens of amatol, which has largely replaced T.N.T. as a shell-filling; tetranitromethyl aniline, which is of increasing use as an initiator of detonation in others; trinitrobenzene, which should have a future, and many others. The exhibits of fragments of shells detonated by picric acid, T.N.T., and amatol respectively show by the relative numbers of the fragments that picric acid still remains our most shattering shell explosive, and, by the minuteness of most, how limited the killing range of such shells really is. The specimen of R.D.B. cordite illustrates how, when through lack of foresight our supply of acetone failed, our chemists and distilleries saved the situation by providing soluble nitrocellulose and alcohol-ether to gelatinise it. The sections of gains show how the problem of detonating insensitive shell-fillings was solved during the war by employing a series of explosives in the detonator, and accomplishing in several steps what could not be done with certainty in one. The specimens which display the eroding effect of hot gases on gun-tubes present a problem to chemists which will probably be solved by the invention of a new alloy. An excellent series of X-ray photographs shows that great progress has been made in the penetration of metals. Internal flaws in parts are revealed, and also the internal structure of ammunition—an important matter when captured ammunition has to be examined and dissected. There are many other exhibits of interest.

THE appeal which the chairman of the Brent Valley Bird Sanctuary makes in our correspondence columns for funds with which to buy and endow the reserve which the Selborne Society has maintained for eighteen years will commend itself to most naturalists. It is as important to rear two useful birds as it is to make two ears of corn grow where there was but one before, and the sanctuary has done more than this. Not only has it enabled birds to build undisturbed near London, but its example has been followed elsewhere, and in thousands of gardens have birds been brought up where there were no fledglings previously. This is through the nesting-boxes which the committee has sent out. Such work should go on. A permanent sanctuary within the London area would be an excellent memorial to Gilbert White and crown the efforts of the Selborne Society. Although the gift of the purchase money or some substantial contributions would bring the endeavour to an earlier completion, we imagine that the more subscribers there are the better pleased would the committee be, and small amounts would therefore be welcomed.

THE fifty-seventh annual general meeting of the British Pharmaceutical Conference will be held at  
NO. 2646, VOL. 105]

Liverpool on July 19–23 under the presidency of Mr. C. A. Hill, managing director of The British Drug Houses, Ltd., who will deliver his presidential address at the Royal Institution, Liverpool, on Tuesday, July 20. The British Pharmaceutical Conference is an organisation established in 1863, and during the fifty-six years of its existence it has made at its annual meetings a total addition of more than a thousand original researches to the common stock of chemical and pharmaceutical knowledge. Among the subjects of the scientific papers to be read at the forthcoming meeting are: A New Method for the Estimation of Cineole in Eucalyptus Oils; The Determination of Hydrocyanic Acid, of Nitrate in Bismuth Carbonate, and of Free Acetic Acid in Acetylsalicylic Acid; Aconite Alkaloids: An Improved Method for their Estimation; and The Detection of Inorganic Phosphate in Glycerophosphates.

WITH the view of obtaining further evidence as to the relationship of the Early Mousterian palæolithic flint implements to the Glacial Chalky Boulder Clay, excavations will be carried out shortly at High Lodge, Mildenhall, Suffolk, by Prof. J. E. Marr, Mr. J. Reid Moir, Mr. Reginald Smith, Mr. Henry Bury, and Mr. M. C. Burkitt. The owner of the High Lodge property, Sir Henry Bunbury, Bart., having given permission for the diggings to be conducted, it is hoped that it may be possible to ascertain with certainty whether the well-known brick-earth of Mousterian age occurring at this spot is younger or older than the Boulder Clay with which it is intimately associated. A full account of the excavations and the conclusions arising therefrom will be published in due course.

THE following elections in connection with the Royal College of Surgeons of England are announced:—*President*: Sir Anthony A. Bowly. *Hunterian Professors*: Mr. C. W. G. Bryan, Mr. A. G. T. Fisher, Mr. W. S. Handley, Mr. W. G. Howarth, Prof. A. Keith, and Mr. H. Platt. *Arris and Gale Lecturers*: Mr. J. F. Dobson, Dr. F. W. Edridge-Green, and Mr. J. H. Evans. *Erasmus Wilson Lecturer*: Prof. S. G. Shattock. *Arnott Demonstrator*: Prof. A. Keith. *Pathological Curator*: Prof. S. G. Shattock. *Physiological Curator*: Mr. R. H. Burne. *Honorary Curator of the Odontological Collection*: Sir Frank Colyer. Sir D'Arcy Power is to deliver the next Thomas Vicary lecture.

THE VERY REV. DR. W. R. INGE, Dean of St. Paul's, is president for the new session of the Aristotelian Society which will open in November next.

THE Sir Alfred Jones Laboratories of the Liverpool School of Tropical Medicine will be officially opened by Lord Leverhulme on Saturday, July 24, at 2.30. The presentation of Mary Kingsley memorial medals will also be made.

SIR ROBERT JONES has been awarded the Cameron prize of the University of Edinburgh in recognition of his work in orthopaedics. Earlier recipients of the prize, which is of the value of about 150*l.*, were Pasteur, Lord Lister, and Sir Lauder Brunton.

DR. SEYMOUR HADWEN has resigned his position as Chief Pathologist in charge of the Biological Laboratory, Health of Animals Branch, Canadian Department of Agriculture, Ottawa, Canada, and become Chief Pathologist in the Reindeer Investigations of the Bureau of Biological Survey, U.S. Department of Agriculture.

WE are informed by the Department of Scientific and Industrial Research that the Research Association for the cutlery industry has been approved by the Department as complying with the conditions laid down in the Government scheme for the encouragement of industrial research. The secretary of the Committee engaged in the establishment of this association is Mr. W. H. Bolton, P.O. Box 49, Sheffield.

THE Royal Statistical Society has opened a register of the names of persons eligible for statistical posts. It has from time to time been asked to recommend qualified statisticians, and has taken this means of bringing those who have appointments to offer into touch with suitable applicants. A list of names and qualifications is now available, and the secretary (9 Adelphi Terrace, W.C.2) will be glad to furnish information accordingly.

WE learn from *Science* that Prof. L. H. Bailey is reorganising the American Pomological Society, of which he is president, and establishing junior branches in a number of agricultural colleges in the United States and Canada. It is proposed under the new scheme that the society shall give consideration to such national affairs as touch the growing of fruits, e.g. legislation, quarantine, export, transportation, and standardising methods.

CAPT. W. J. RUTHERFORD has reprinted from "The History of the Berwickshire Naturalists' Club" (vol. xxiv.) a paper on "A Border Myth: The Standing Stones at Duddo." The local folklore accounts for their origin by supposing that the stones are the petrified bodies of a gang of field-workers who profaned the Sabbath by going into a field singing and thinning a crop of turnips, while the leader was thrown on his back and lies prostrate to this day. Capt. Rutherford compares the legend with that attached to the "Maidens" or "Merry Maidens" and the "Hurlers" in Cornwall. The story is not uncommon, and it would not be difficult to quote other parallels.

THE report of the Felsted School Scientific Society for 1918 and 1919 is welcome evidence of the place given to scientific pursuits in an up-to-date school. The natural history notes, which predominate, reach a high standard and contain many interesting observations on the local appearance and movements of migratory birds, while the photographs which have been selected for reproduction say much for the skill and patience of the young naturalists. The report shows how greatly the progress of a school society depends upon the guidance of an enthusiastic master. It is gratifying to see from the balance-sheet that the governors, by a generous contribution to the funds of the society, give evidence of their belief in the value of Nature-study, and their faith is well

founded, for the recording of detailed observations, whether of rainfall or temperature or migration, is a sowing of the seeds of the scientific habit and the love of truth.

UNDER the title "The Birds of Eastern Canada," the Canadian Department of Mines has issued a memoir—No. 3 of its Biological Series—by P. A. Taverner. This has been written "to awaken and, where it already exists, to stimulate an interest, both æsthetic and practical, in the study of Canadian birds and to suggest the sentimental, scientific, and economic value of that study; to assist in the identification of native species; and to furnish the economist with a ready means of determining bird friend from bird foe . . . ; to present in a readily accessible form reliable data upon which measures of protective legislation may be based; to point out some of the pitfalls that have caught the inexperienced in the past; and to suggest methods for their future avoidance." To accomplish these desirable ends, the memoir treats of all the species with which the ordinary observer is likely to meet "between the Atlantic coast and the Prairies north of the International Boundary." It is prefaced by some general remarks on classification, geographical distribution, migration, and protection, and by an illustrated key to the characters of the groups to which the various species belong. The main portion of the work deals with 766 selected birds, and shortly describes their plumage, haunts, nesting, economic status, and distribution in Eastern Canada: many of them are depicted in the series of coloured plates which forms the concluding portion of this useful memoir.

IN the interests of commerce itself it is becoming increasingly plain that where the exploitation of wild animals is concerned men of science, and not the captains of industry, must determine the levy which any given species can stand without endangering its safety. The urgent need for the speedy recognition of this fact is very emphatically shown in a series of able essays published in the form of a bulletin by the Scripps Institution for Biological Research of the University of California (No. 9). Where all are of such surpassing excellence it is difficult to select any one of these essays for special mention. But since a choice must be made, it shall fall upon that of Dr. Evermann, who surveys the present position of the Northern fur-seal. He throws a lurid light on the attitude of the non-scientific legislator. Even Departments of State, he shows, for the sake of present revenue, will adopt covertly hostile methods to suppress the findings of scientific men appointed for the express purpose of investigating the conditions of the sealing industry, if such findings seem to threaten the earnings of that industry. The fact that, unless wise methods of conservation are adopted, the industry will presently extinguish itself seems entirely to be lost sight of in the desire to secure immediate revenue. "Take the cash in hand and waive the rest" seems to be the motto pursued. Those interested in the salmon fisheries contend that the seals eat vast quantities of these fish, and are therefore injurious to the fishing interests. Yet no attempt has so far been made to discover what fish really constitutes

the staple diet of the fur-seal. This aspect of the problem adds to its complexity, since it affects conflicting interests. At the same time it emphasises the need for immediate action, not for academic discussion.

THE many friends of the veteran geologist, Mr. Henry Keeping, who was born near Milton, on the Hampshire coast, in 1827, will welcome his simple and unaffected "Reminiscences," published as a pamphlet by F. W. Talbot, Sussex Street, Cambridge (price 1s. 6d. post free). A characteristic portrait appears on the cover. Anecdotes of Sedgwick and of the early days of collecting in Devonshire and the Isle of Wight form pleasant reading. The story of the plump farmer in the Fenland who checked a disaster by sitting in the gap of a broken dyke is told with humorous appreciation.

PROF. PIERRE TERMIER, in a paper on "Les Océans à travers les âges" (*Revue Scientifique*, May 8, 1920), emphasises the differences in structure of the Atlantic and Pacific Oceans, and regards the deep-water ring around the central area of the latter as a persistent feature of the crust, liable to disturbances, but not to elevation as dry land. The Indian Ocean, on the other hand, is post-Jurassic and the Atlantic is post-Miocene. The narrowing of the continents southwards is not a primary feature of a tetrahedral earth, but results from the widening of these comparatively modern areas of subsidence as they approach the south.

THE *Geographical Review* (New York) for March, 1920, contains two articles of especial interest to British readers. The first is by Lieut. Leo Walmsley on "The Recent Trans-African Flight," with several photographic illustrations. The writer's wide knowledge of Eastern Africa and his success as a scientific observer even when fighting from his aeroplane fully justify his remark that "Africa, as seen from the air, is one of the most wonderful of all countries. . . . A civilised country seen from the air is simply a gigantic mosaic . . . the aircscape of Central Africa is as untamed and irregular as that of the moon." The second article is by Mr. C. R. Dryer on "Mackinder's 'World Island' and its American 'Satellite.'" The author cleverly shows, on Mollweide's projection, the American continents as a "world ring" round about the "world island," and pictures the people of that world ring, which has no barbarous heartland, as ready to come to the aid of the coastal races that stand for civilisation in the world island.

STONYHURST College Observatory has recently issued the results of meteorological and magnetical observations for 1919 with a report and notes by the director, the Rev. A. L. Cortie, S.J. The results with the report occupy 55 pages, and details of the observations are given with great precision for the several months and for the year. The observatory has long since been associated with the Meteorological Office, and the Monthly Weather Report publishes many of the results. The monthly mean temperature is

obtained in two ways, from the mean of the highest and lowest daily readings and from the mean of the readings at 9 a.m. and 9 p.m., both means being corrected by Glaisher's tables. The thermometers are mounted 7 ft. above the ground in a Stevenson screen; why in this case should not the height above ground be 4 ft., the normal height for uniformity? Taken as a whole, 1919 was drier and colder than the normal, and every individual month was cold with the exception of May and December. Bright sunshine for the year was 25 hours less than the normal. Rainfall was nearly 6 in. deficient, although the rainy days were only two fewer than usual. October was relatively the driest month, rainfall being only about 50 per cent. of the average. Magnetic observations and disturbances are popularly explained, and afford considerable information for obtaining uniformity of results. Sun-spot activity, which had steadily declined since August, 1917, and throughout 1918, revived in 1919. The seismograph, which for a time had been thrown out of action, is said to be now working satisfactorily.

MR. J. I. GRAHAM, research chemist at the Bentley Collieries, Doncaster, has devised a very convenient and portable apparatus for the estimation of small quantities of carbon monoxide in the air of mines. It consists of a vessel containing a known volume of the sample, which can be introduced by running water out of the vessel. By operating a three-way tap and blowing water into the vessel the sample may be passed into iodine pentoxide contained in a U-tube heated to 90°-150° C. In examining air in the mine the temperature is maintained by hot oil contained in a thermos flask which keeps the U-tube within these limits for several hours. The iodine liberated from the pentoxide is thus sublimed and driven into a tube containing a solution of potassium iodide in which the free iodine can be titrated and estimated in the usual way. The inventor claims that an analysis can be completed in about five minutes with an accuracy of 0.005 per cent. using 100 c.c. of air, or of 0.0005 per cent. with 1 litre. It is of special value for estimating small quantities of carbon monoxide in mine-air, since 0.2 per cent. is highly dangerous, and even 0.02 per cent. produces after a time unpleasant effects. As the quality of compressed oxygen supplied in cylinders is important in life-saving operations in mines, Mr. Graham has introduced a simple piece of apparatus for determining the amount of oxygen by absorbing a known volume in alkaline pyrogallol. Both pieces of apparatus can be purchased from Messrs. Reynolds and Branson, Ltd., Leeds.

IN order to obviate the use of the high voltages required in wireless telegraphy when a triode tube is operated from a direct-current supply by means of a mechanical "chopper" which periodically breaks the supply circuit, Mr. L. M. Hull, of the Bureau of Standards at Washington, has used with great success an alternating supply from a 2-kw. machine giving 500 cycles per second at 150 volts, and a short account of his method and results is given in the *Journal of the Washington Academy of Sciences* for June 4. The sending key is in the alternator circuit, and the

filament current and plate potential are both provided by means of transformers. The author finds that, operated in this way, the triode tube gives results which compare favourably with those obtained with the usual direct-current method, and that it has the advantage of not requiring a high-voltage generator or battery, while over a limited distance signals may be received with a non-oscillating detector. A more complete account of this work is to appear as a Scientific Paper of the Bureau.

MR. S. J. PEACHEY, lecturer in chemistry at the College of Technology, Manchester, claims to have discovered a process for the cold vulcanisation of rubber. This is applicable not only to rubber in its solid forms, but also to solutions. The final product may be obtained containing no free sulphur. Leather waste, wood-meal, and starch cellulose may be mixed with rubber so as to yield cheap, fully vulcanised products with new properties and great durability. Leather waste and rubber may be converted into a product resembling leather, and at the same time waterproof. No details of the process are given beyond the fact that it employs "two gases which are by-products of several chemical manufacturing processes, and are available at a very low cost." If these claims can be substantiated, it appears that the process should be one of very great technical interest and importance.

FACILITY of manipulation and precision in adjustment are two prime features in X-ray tube stands. They appear to have been carefully considered in the models Mark III. and Mark IV. which we find in Bulletin 255 of Messrs. Watson and Sons, Ltd. In the screen attachment to the latter model there is an arrangement whereby the X-ray tube and the screen move together during vertical examinations. We would suggest that a valuable addition to the illustrations of these models would be the protective devices to be employed with them. It is especially necessary during screening examinations to avoid stray radiation reaching the operator, and the adoption of rigorous protective measures would no doubt become more general if publicity were given to this requirement.

IN the course of an article on Pelton-wheel construction by Mr. Percy Pitman, in *Engineering* for June 25, the author describes the method adopted for improving the jets, which were unsatisfactory in the existing turbine. Experimental nozzles were made in fluid-pressed bronze, and four rustless steel blades, 5 mm. thick, were dovetailed into them so as to lie in axial planes. These blades were ground and highly polished up to a thin knife-edge. A great improvement resulted; the jets were of extraordinary solidity and transparency, the water for about 2 ft. issuing almost like a glass rod. Those interested in the design of Pelton-wheel buckets will find a good deal of useful information in this article; there is but little of practical value in text-books, and the author gives the complete lay-out of the new buckets, and includes copies of the working drawings.

NO. 2646, VOL. 105]

### Our Astronomical Column.

AN EASY METHOD OF FINDING LATITUDE.—The *Observatory* for June contains an article by N. Liapin on a method of finding latitude which is interesting and a useful exercise for astronomical students, and requires no other instrument than a watch. The method consists simply in observing the number of seconds between first and last contacts of the sun with the horizon at sunrise or sunset. The formula for solution given by the author is  $\cos^2 \text{latitude} = \sin^2 (\text{sun's decl.}) + 4 (\text{sun's radius})^2 / (\text{time interval})^2$ , where the radius and time interval must be expressed in the same units. This formula does not take account of the change of sun's decl. in the interval; a correction for this may readily be made.

Five actual determinations by this method are given, the resulting latitude being 10' from the truth. While a sea horizon is preferable, any straight and level horizon will serve.

INCREASING THE PHOTOGRAPHIC POWER OF TELESCOPES.—In the Proceedings of the U.S. National Academy of Sciences for March Dr. Shapley describes a method of increasing the photographic power of large reflectors for the purpose of photographing extremely faint objects. The faintest stars at present reached by the 60-in. reflector are of magnitudes 20 to 21, and it is believed that the great Hooker telescope will gain about one magnitude over this. Dr. Shapley is of the opinion that this is bordering on the limiting magnitudes in globular clusters, and if one or two fainter magnitudes were available for study, some most important information might be obtained with regard to several questions of stellar and galactic evolution. The method employed is quite simple, consisting essentially in shortening the effective focal length of the telescope by means of a short focus lens placed between the mirror and the plate. The brightness of the image is thus increased, though, of course, a reduction of scale is inevitable. This, however, is immaterial in many sidereal problems. A trial series of exposures with different intensifiers seems to have yielded satisfactory results, and questions relating to globular clusters, the limits of the galactic system, and similar problems appear to be more hopeful of solution.

A NEW SPECTROPYRHELIOMETER AND SOLAR MEASUREMENTS MADE WITH IT.—In No. 378 of the Scientific Papers of the U.S. Bureau of Standards, recently issued, Messrs. W. W. Coblentz and H. Kahler give an account of a new spectropyrheliometer and measurements of the component radiations from the sun and from a quartz-mercury vapour lamp. The spectropyrheliometer consists of a quartz spectrograph and cylindrical condensing lens placed upon an equatorial mounting, thus eliminating the ultra-violet absorption produced in heliostat mirrors. The paper sums up the data given on the relative components of infra-red, visible, and ultra-violet radiation from the sun and from a quartz-mercury arc lamp, also on the gas-filled tungsten lamp, the iron arc, and the carbort arc. In the first appendix methods are given for excluding ultra-violet light from buildings, one of these being the use of a kind of Venetian blind or louvre of wide slats, painted buff to reflect the light into the building, the buff or red paint absorbing the ultra-violet, thus protecting the contents of the building (balloon hangars, etc.) from photochemical action. The second appendix suggests methods for protecting projection lantern films from the heat of the lamp, and a simple method put forward is to provide the water-cell with windows of Corning "heat-absorbing" glass, which is very opaque to infra-red radiation.

### British Association.

SUBJECTS FOR DISCUSSION AT THE CARDIFF MEETING.

THE sectional programmes for the British Association meeting at Cardiff, August 24-28, are now taking shape, and some of the principal scientific subjects which will be discussed may be indicated. The Mathematical and Physical Section, under the presidency of Prof. A. S. Eddington, will be concerned with the Einstein theory, and will receive a paper on the shift of the Fraunhofer lines with reference to that theory. The Section will also discuss the examination of materials by X-rays, the origin of spectra, terrestrial magnetism, auroræ, solar disturbance, and various phenomena of the upper atmosphere. The Geological Section will, as usual, pay attention to local geology, and will also, in joint session with the Sections of Zoology and Botany, discuss Mendelism and palæontology with reference to the Mendelian interpretation of gradual changes, especially when new characters appear late in the individual life-cycle. The Zoological Section will also consider the need for the scientific investigation of the ocean and of fisheries—a subject in which not only the president of the Section (Prof. J. Stanley Gardiner), but also Dr. W. A. Herdman, president of the Association and professor of oceanography at Liverpool University, are leading authorities.

The president of the Geographical Section, Mr. J. McFarlane, will deal in his address with geography and nationality as factors in the formation of the new Europe; the Section will also discuss the distribution of population in South Wales, the new Ordnance Survey maps, the place of geography in a reformed classical course, and various problems connected with Abyssinia, Algeria, Tunisia, Asia Minor, Finland, and other lands. The Engineering Section is expecting papers from Sir Arthur Duckham on the use of coal and from Mr. S. F. Edge on farm tractors, and will also deal with a number of metallurgical and mechanical topics. The Anthropological Section will consider several subjects of Welsh interest, including Welsh ethnology, the Roman sites at Caerwent and Abergelge, "hill-top" camps, especially in North Cardiganshire, and Welsh folk-music; in this Section also, among other speakers, Prof. Flinders Petrie is expected to give an account of recent work in Egypt. The Physiological Section, jointly with its sub-section of Psychology, will deal with the subject of psychological medicine in the United States, while the Section will also consider the place of physiology in education, and will receive from Prof. A. D. Waller a demonstration of the "emotive response" of the human subject. The erection of psychology into the subject of a separate section will be brought forward.

The Sections of Physiology and Botany jointly will discuss biochemistry and systematic relationship. The Botanical Section, in addition to other joint meetings, will join that of Agriculture in dealing with soil and plant survey work. In the Educational Section the report of a committee will be received upon training in citizenship, in connection with which Bishop Welldon, Sir R. Baden-Powell, and Lady Shaw are expected to speak. The Section, among other subjects, will discuss the relation of schools to life, post-graduate international education, and the relation of universities, public schools, training colleges, and higher technical schools to a national system. In connection with the last discussion it is hoped to receive a communication on universities from the Right Hon. H. A. L. Fisher. A number of papers of psychological and educational interest will be received in joint session with the sub-section of Psychology. The Agricultural Section will have

before it a number of practical subjects concerned with crops and livestock.

In addition to general excursions, several Sections, including those of Geology, Geography, Engineering, Anthropology, Botany, and Education, will visit sites, works, or institutions in Cardiff and the neighbourhood appropriate to their various interests.

The subjects of the evening discourses given at general meetings will be "A Grain of Wheat from the Field to the Table," by Sir Daniel Hall, of the Board of Agriculture, and "Some Requirements of Modern Aircraft," by Sir Richard Glazebrook, lately Director of the National Physical Laboratory.

### Museums Association Annual Conference.

THE thirty-first annual conference of the Museums Association was held in Winchester on July 6-8, under the presidency of Sir Martin Conway, Director-General of the Imperial War Museum. There were present about a hundred delegates from the various museums and art galleries of Great Britain and Ireland, while Colonial and foreign institutions were represented by Mr. Fitzroy Carrington, from the Boston Museum of Fine Arts; Mr. E. C. Chubb, from Durban Museum; and Dr. G. Johansson Karlin, from the Kulturhistoriska Museet, Lund.

The meeting marked an epoch in the history of the association, since it partook of the nature of a joint conference with the Museums Association of France, which was represented by Prof. Louis Roule, of the Paris Museum, and Dr. Loir, secretary of the French Museums Association.

In his presidential address Sir Martin Conway gave an account of the formation of the Imperial War Museum temporarily housed in the Crystal Palace. He explained how the difficulties of the collection and transport of specimens are being met, and dealt with some of the problems of their storage, especially in the case of war cinematograph films the preservation of which at present is both difficult and expensive. Owing to the vast mass of material collected and the large size of many of the exhibits, the president pointed out that their permanent home must of necessity be spacious. He suggested that no more fitting war memorial could be raised than a stately museum on the Surrey bank of the Thames near the proposed site of the new Charing Cross bridge. Here the thousands of specimens connected with and illustrating the war period could be housed, and with them a complete Roll of Honour, with biographical notes, of every man and woman of the Empire who had fallen in the great struggle.

Mr. E. N. Fallaize read a paper of great interest and utility to museum curators on "Suggestions for the Classification of the Subject-matter of Anthropology." In consideration of the vast field covered by this subject, he pointed out the necessity for the formation of a definite plan for its study, suggesting a broad classification of the subject into two heads, one dealing with man as an organism and the other treating him as a rational being reacting to his environment. For the first, a study of man's structure and the functions of his organs is needed, including a study of the abnormal, both physical and mental. Having thus established a type, the second heading falls naturally into two groups: ethnology, a study of man in space, and what may be termed pale-anthropology, a study of man in time. In addition, man's nature as shown in the development and employment of specifically human faculties should be studied, not chronologically, but in a logical sequence

leading from primitive gratification of the senses to man's relation to the unseen.

One of the outstanding problems which a museum curator has to face is that of the lighting of his building, and a paper given by Mr. Hurst Seeger on "The Lighting of Museums and Art Galleries" was particularly instructive on this point. He dealt especially with the question of reflection in the glass of pictures and museum-cases, and pointed out those principles of construction whereby such reflections could be avoided.

Mr. Lowe explained the Public Libraries Act of 1919, stating that, in his opinion, it gave their charter to the museums and art galleries of this country.

A discussion as to the desirability of a diploma for museum curators was opened by Dr. Hoyle, who was of opinion that without some recognised diploma the status of curators could not be assured. In the course of the discussion Mr. Bailey outlined a scheme suggested by Sir Cecil Harcourt-Smith for the training of museum curators at the Victoria and Albert Museum.

A paper on the museum and art gallery of Baroda, dealing particularly with the difficulty of preserving pictures in hot climates, was read by Mr. Dibden.

Mr. M. J. Rendall, Headmaster of Winchester College, gave a paper, illustrated by lantern-slides, on the teaching of art in local museums, emphasising the part played in such teaching by good lantern-slides. He demonstrated the vast difference made by the quality of the slides used, and explained how and where the best slides could be obtained.

Dr. A. Loir gave an account of the formation of an Association of Curators of French Museums, and suggested a joint committee of English and French curators for international co-operation. Papers were read on "The Winchester City and Westgate Museum," by Mr. Hooley; "The Winchester College Museum," by the Rev. S. A. McDowall; "Selection of Pictures for Municipal Art Galleries," by Mr. Howarth; "Biography of the Comte de Lacépède," by Prof. Louis Roule; "The Child and the Mummy," by Mr. T. Peart; and "Suggestions for a Bureau of Exchange through the Medium of the *Museums Journal*," by Mr. Allchin.

A full account of all papers and discussions will be published in the September issue of the *Museums Journal*.

## The University of Edinburgh.

### NEW SCIENCE BUILDINGS.

THE foundation-stone of the new chemical laboratories of the University of Edinburgh, the first of what will be known in future as the "King's Buildings" of the University, was laid on July 6 by the King, who was accompanied by the Queen and Princess Mary. These buildings are to be erected as separate blocks on a site of 115 acres acquired by the University in November, 1919, mainly for the use of the scientific departments. They are situated on the southern outskirts of the city, near the Royal Observatory on Blackford Hill, and are about two miles distant from the Old College. Thousands of spectators assembled, notwithstanding the drenching rain which fell before and throughout the ceremony.

The general lay-out of the chemical laboratories was planned by Prof. James Walker, who has worked in collaboration with Mr. A. F. Balfour Paul, the architect of the building. The building is rectangular in plan, having a frontage of 220 ft. and a depth of 320 ft. Three corridors, one central and one on each side, run backwards through the whole length, and

are connected by a cross-corridor in the front portion. This arrangement permits of indefinite extension by increasing the depth of the building. Between the central corridor and the side corridors are situated the main laboratories with their stores- and service-rooms, as well as the lecture department. Each main laboratory (of which there are five) measures 70 ft. by 45 ft., and receives north light from a saw-tooth roof. Smaller rooms used in conjunction with the main laboratories are situated across the outer corridors, and are lit from the side. The whole building is of one story, except the frontage block and the front part of the east and west wings, which are two stories in height. In these will be housed administration, library, special laboratories, and research-rooms. When complete the department will provide places for about four hundred students working simultaneously. It is estimated that the total cost of the chemical laboratories with fittings and equipment will be approximately 250,000.

His Majesty, in replying to the address of the Vice-Chancellor, Sir Alfred Ewing, expressed the hope that generous donors would be found able and willing to complete the plan of extension which had been sketched with so bold a hand. At the conclusion of the ceremony of laying the foundation-stone the degree of LL.D. was conferred on the Queen.

## Lessons from the Smithsonian.

THE report of the secretary of the Smithsonian Institution for the year ending June 30, 1919, is, as always, full of interest, and it differs from similar reports issued in this country in that the points of interest are clearly brought out and not left to be deduced by the reader from masses of undigested detail. The institution controls the work of the National Museum, the Bureau of American Ethnology, the International Exchange Service, the National Zoological Park, the Astrophysical Observatory, and the United States contributions to the International Catalogue of Scientific Literature. The Astrophysical Observatory seems a little out of the picture, but the association of the other bodies tends to co-operation and the prevention of overlap.

The National Museum itself embraces every form of museum activity and combines subjects which in London are distributed among the two sections of the British Museum, the Victoria and Albert Museum, the Science Museum, the Museum of Practical Geology, the National Galleries of Art, and several other collections. The Washington people are as well satisfied with their system as we (to judge from perennial complaint) are dissatisfied with ours. The single administration, it is claimed, "not only ensures greater economy in management, but permits of a more logical classification and arrangement, the elimination of duplication, and a consequent reduction in the relative amount of space required."

Those in this country who are advocating the co-ordination of our museums and allied establishments under a single board would be well advised to study the conditions in Washington. The most obvious danger of such a system is too great rigidity and unnecessary red-tape. It is, however, clear that such an objection does not apply to the Smithsonian Institution. The constitution of the various bodies permits of far more flexibility and enterprise than we are accustomed to in some, at any rate, of the similar bodies in this country. This, it seems to us, is because the Smithsonian is not a Department of State run by politicians or clerks without experience of the varied

activities which they have to direct, but is, from Secretary Walcott downwards, managed by men who have received their training in the field or the laboratory or the museum; men who are familiar with the needs and difficulties of their assistants; men who combine high ideals with a clear appreciation of what is practicable, and so carry out a consistent policy.

A feature of the National Museum, as of other American museums, is the large amount of exploration undertaken. An expedition, including collectors and kinematographers, is now at work in Africa. Mrs. Purdy Bacon has bequeathed fifty thousand dollars to establish a travelling scholarship for the study of faunas outside the United States. Many other expeditions are here reported on. But we would chiefly emphasise the policy of sending out the officers of the museum to study and collect. The whole of the geological staff was thus employed during the field-season of 1918, filling gaps in the collections, obtaining specimens needed for public exhibition, and taking photographs to illustrate the explanatory labels. Many of the other departments also had members in the field.

Among other signs of life and growth, the report records the inauguration of popular scientific lectures, and the introduction of a Bill to provide a museum of history and of the arts as a memorial to Theodore Roosevelt. The building would afford much-needed space for the rapidly extending National Gallery of Art.

### The Religion and Origin of the Hawaiian People.

THE sixth volume of the Memoirs of the Bishop Museum at Honolulu<sup>1</sup> continues the publication of Judge Fornander's literary collections. The first portion contains two important papers by native writers on the religion of the Hawaiians. One, by Kamakau, contributed to the collection by Dr. W. D. Alexander, describes certain ancient ceremonies of which the principal are those connected with the pre-natal development of the royal child, the direction of services to the gods, the catching of the fish *opelu*, and the feasts of the year. There are shorter notes on heathen prayers and the ceremonial erection of the *heiau* or god's house. A much longer paper by the Hawaiian author, S. N. Haleole, deals with the functions of the *Kahuna*, "the priesthood called the Order of Sorcery." The word in varying forms (*tahuna*, *tahunga*, *tauna*) is used throughout the Eastern Pacific to denote persons possessed of varying degrees of wisdom from priesthood to sorcery, but in the west, in Tonga and Samoa, has become entirely secularised, and there (in the form *tufunga*) means nothing more than a carpenter or skilled workman.

The *Kahuna* in Hawaii was properly trained for his office, and gave evidence of his powers by divination from pebbles, clouds, shadows, and dreams, and by his magical effects with the *maunai* or cast-away portions of nail, hair, tooth, or clothing. His services were in request in times of war and threatened evils, for house-building or loss of lands, in courtship and medicine. The omens of agriculture, canoe-making, and fishing, with descriptions of the occupations themselves, are fully described.

The second part of this volume contains Fornander's speculations on the "Source and Migrations of the Polynesian Race." This appears somewhat out of date in the present stage of linguistic study.

<sup>1</sup> Memoirs of the Bernice Pauahi Bishop Museum of Polynesian Ethnology and Natural History. Vol. vi., Nos. 1 and 2. "Fornander Collection of Hawaiian Antiquities and Folk-Lore." Third Series. Parts 1, 2. Pp. 358. Honolulu: H. I. Bishop Museum Press, 1919.

The author regards India as the original home of the Polynesian people, and supposes that the Polynesian and Aryan language families separated before the latter had developed their inflected form, and that traces of Polynesians are found in the Malay Archipelago. A majority of the immigrants are thought to have passed through Torres Straits to the Loyalty Islands, and thence to Fiji, Samoa, and Tonga. Fornander's so-called evidence is very unsatisfactory. It is based mainly on the casual resemblances of certain Indian words to Polynesian, the Polynesian meanings being read into the Indian word or *vice versa*.

The theory of an Indian origin of Polynesian may be seen to underlie the theories of Macmillan Brown, Percy Smith, Christian, and Churchill, but certainly lacks the support of sound linguistic evidence. According to this view, everything east of India which agrees with modern Polynesian is borrowed from an ancient form of Polynesian speech, though the languages themselves prove that Polynesia has received many of its words from primitive Indonesia, and that not by one migration, from one place at one time, but in several colonisations from various parts of the archipelago at different times.

The final portion of part 2 contains other papers by Fornander on Hawaiian tradition, history, and genealogy.

As all the native writings in the first part are in the original Hawaiian with translations, they form a considerable body of text which will be useful to the student of the language, quite apart from their value in the exposition of Hawaiian religion. The whole work is very clearly and tastefully printed and a credit to the Museum Press. SIDNEY H. RAY.

### Soil Temperatures.<sup>1</sup>

THE paper by Messrs. West, Edlefsen, and Ewing referred to below is an attempt to predict the probable temperature of any hour of any day. If the mean monthly temperatures of any place are known from previous records, it is possible to represent them by a Fourier series of the form

$$T = a + b \cos(\theta - c) + d \cos 2(\theta - e) + f \cos 3(\theta - g) + \dots$$

where  $T$  = temperature at time  $\theta$ ,  $a$  = mean annual temperature,  $b$ ,  $c$ , etc. = constants. It is also found for normal days that the temperature at any given hour is a certain percentage of the mean daily temperature, and that this percentage is practically constant irrespective of season. The Fourier series is used to predict the mean daily temperature, which is then multiplied by the appropriate percentage factor to obtain the temperature at the given hour. An arithmetical method, avoiding the use of the Fourier series, is also described. The results are fairly trustworthy for arid regions, but not for humid areas where storms, etc., are frequent.

In Capt. Franklin's third paper on soil temperatures (see "Forecasting Frosts," NATURE, January 1, 1920, p. 450) the variations in the ratio of temperature ranges at the 4-in. depth and the surface,  $\left(\frac{R_4}{R_0}\right)$ , are

studied under a variety of weather conditions. The values vary widely, from 0.19 in a very dry soil to 0.85 during heavy rains. The most common value is about 0.40. The influence of the soil-water on tem-

<sup>1</sup> "Determination of Normal Temperatures by Means of the Equation of the Seasonal Temperature Variations, and a Modified Thermograph Record." By F. L. West, N. E. Edlefsen, and S. Ewing. *Journ. Agric. Res.*, vol. xviii. (1920), p. 499.

<sup>2</sup> "The Effect of Weather Changes on Soil Temperatures." By T. R. Franklin. *Proc. Roy. Soc. Edinburgh*, vol. xl. (1920), p. 56.



perature is very marked. The downward percolation of warm or cold rain from the surface to the 4-in. depth causes rapid changes in temperature, especially in sandy soils, when percolation is rapid. After drainage has ceased a rise in temperature may enable it to begin again, owing to the diminishing viscosity of water with increasing temperature. The formation of a dry surface-mulch reduces the value of  $\left(\frac{R_4}{R_0}\right)$

owing to the low conductivity of dry soil. But the actual temperature at the 4-in. depth is not greatly reduced by the poor conductivity of the dry soil. This is attributed to the dry surface layers reaching a higher temperature owing to their lessened specific heat, and this counteracts the effect of decreased conductivity. It is shown that a strong dry wind causes the temperature of the surface soil to fall considerably below that of the air. The effect of frost is examined and a formula given for depth of soil frozen in terms of mean surface temperature and duration of frost. A very close relation holds between the date of flowering of coltsfoot and the number of frosts for the two months previous to the date of flowering on open soil not covered with deep snow. It is shown also that strong warm west winds—associated with cyclonic depressions—rapidly raise the temperature of the underground layers of soil in spring. B. A. K.

### Control of Insect Pests.

ENGLISH tomato-growers in the Lea Valley are threatened with an annual loss of from 5l.-10l. per acre unless special remedial measures are adopted against the glasshouse tomato moth, *Polia (Hadena) oleracea*. L. Lloyd (Monthly Circular of the Lea Valley and District Nurserymen's and Growers' Association, Ltd.) finds that spraying with lead arsenate for the destruction of the pest must be supplemented by trapping the caterpillars and moths and by destruction of the pupæ. The caterpillars can be trapped in old sacks, and ultimately killed by boiling water, while the moths are attracted to wide-mouthed jars containing brown treacle and ale mixed with 1 per cent. of sodium fluoride. Emphasis is laid on the necessity for ascertaining that each control measure is effective.

Several papers have recently been published dealing with the control of various "borers" that infest crop trees. Attempts have been made to control the peach-borer by means of toxic gases derived from poisonous substances distributed on the soil round the base of the trees, E. B. Blakeslee (Bull. 796, U.S.A. Depart. Agric.) finds that the more usual toxic agents, viz. carbon bisulphide, carbon tetrachloride, sodium cyanide, and naphthalene, are all unsuitable for various reasons, but that para-dichlorobenzene offers distinct possibilities for the purpose. The surface crust about the collar of the tree is broken, the required dose of poison (about 1 oz. per tree from 6-15 years old) distributed evenly about the trunk in a band 1-2 in. wide, and a covering of earth applied and moulded up. It is claimed that by this method 94 per cent. of the larvæ can be destroyed.

Much damage is wrought in the United States by the apple-tree borer, which usually takes two or three years to pass through its life-cycle. It is difficult to attack the larvæ by means of poisonous sprays, and mechanical devices are necessarily resorted to. F. S. Brooks (Farmers' Bull. 675, U.S.A. Depart. Agric.) maintains that the most effective method of control is the old-fashioned practice of "worming" with a knife and a piece of wire, but recommends the use of carbon bisulphide when the burrows are obstructed

and the larvæ cannot be reached by the wire. Egg-laying can be prevented by a thick coat of paint applied to the bark of the tree, or by means of wrappings of cloth or newspapers applied close enough to exclude the adult female from the bark. The beetle can be killed by spraying the trees with arsenate of lead, as by this means their food is poisoned, but it is doubtful if this is profitable as a general rule.

A most comprehensive account of the toon shoot and fruit borer (*Hypsipyla robusta*, Moore) is given by C. F. C. Beeson in the *Indian Forest Records* (vol. vii., part vii.). The stages of the insect, its life-history and habits, and studies of its seasonal history are fully described, and from the information thus gained the best methods of control are elucidated. The toon borer passes through five generations in the year; the first is spent in the flower, the second in the developing fruits, and the last three in the young shoots of the current season. The effect of this habit is that the first and second broods cause great injury to the seed crop, and in bad years may hinder seed-formation entirely, whilst the three later broods may completely nullify the season's growth in young trees, and, in any case, they cause great delay in the development of the saplings. It is often of little use to make young plantations in the neighbourhood of old toon trees which are infested with the borer. The young trees are subject to attack from their second or third year onward, but may be somewhat protected by banding the trees breast-high with sacking, and removing and destroying at intervals all the larvæ and cocoons found inside the sack-bands. After the fruits are ripe it is advisable to cut out and burn all shoots that are attacked, and in bad cases a second pruning should be made during the cold weather.

### Scientific and Systematic Pomology.<sup>1</sup>

IT may be taken as a sign of the development of research in fruit culture in this country, and of the interest which has been aroused in connection therewith among growers of fruit and progressive horticulturists generally, that the well-known firm of nurserymen, Messrs. George Bunyard and Co., Ltd., of Maidstone, has considered the time ripe for the issue of a new quarterly journal devoted exclusively to pomology. The editor, Mr. E. A. Bunyard, a member of the firm named, is recognised both as a practical grower of wide experience and as one of the foremost authorities on systematic pomology and pomological literature. Under his guidance the *Journal of Pomology* should without difficulty establish itself as a publication of scientific value, meeting the needs of a branch of horticulture which has advanced with rapid strides in its importance for the country economically and physiologically since the day when the late Mr. W. E. Gladstone advised farmers to grow fruit for jam production as a remedy for agricultural depression, and is at present none too well catered for in this respect.

The contents of the first two numbers may appear to suggest that there is scarcely occasion yet for a periodical intended primarily to serve for scientific and systematic pomology in this country, some of the more important articles being reprints or abridgments of papers previously published in other journals. Such articles, however, as those by Miss Sutton on self-sterility in plums, cherries, and apples, and by Brooks and Bailey on silver-leaf disease, are of a

<sup>1</sup> *The Journal of Pomology*. Edited by Edward A. Bunyard. Vol. i. Nos. 1 and 2. (Maidstone: Geo. Bunyard and Co., Ltd.) Published Quarterly. Single Nos. 3s. 6d.; Annual Subscription 10s.

degree of interest to pomologists which justifies reproduction in a journal more likely to come under their notice than those in which they originally appeared. It is improbable, moreover, that with research bearing on fruit culture in active progress at such centres as Woburn, Long Ashton, and East Malling, as well as at Cambridge and the John Innes Institution at Merton, there will be any dearth of material on the scientific side for future numbers.

In addition to the articles mentioned, others of particular interest which have already appeared in the journal are those on "Black Currant Varieties," by R. G. Hatton; "Seedling Apples," by the editor and Edward Laxton; "Insect Visitors to Fruit Blossom," by C. H. Hooper; and "The Recognition of Fruits," by H. E. Durham.

Provided that the policy already adopted of the inclusion of reviews and short summaries of recent pomological research as well as of original papers is maintained, those whose interests are mainly centred on fruit culture should find this journal of much service in keeping them in touch with the advance of knowledge in the subject—a matter which has not been easy hitherto owing to the diversity of the publications in which such work has appeared.

### University and Educational Intelligence.

**BIRMINGHAM.**—At a Degree Congregation held on July 10 the Vice-Chancellor (Sir Gilbert Barling, Bart.) conferred the following degrees:—*Doctor of Science*: Frederick Challenger, Arthur Hubert Cox, Harold Ashley Daynes, and John Leslie Houghton. *Doctor of Medicine*: Gladys Mary Cooksey. *Philosophiae Doctor* (a degree new to this University): William Hulse, Frederick Joseph Meggitt, and Leonard Johnston Wills. *M.Sc. (Official)*: William Cramp, Arthur Robert Ling, Gilbert Thomas Morgan, Samuel Walter Johnson Smith, and Richard Henry Yapp. *M.Sc. (Ordinary)*: F. H. Clews, H. J. Collins, H. G. Evans, A. E. Goddard, F. B. Jenkins, L. J. Lambourn, E. W. Mason, K. N. Moss, A. H. Naylor, N. A. Nicholls, D. S. Newey, A. J. Nicholson, G. N. Scott, H. J. Thompson, E. Tyler, and W. R. A. Weatherhead. *Master of Surgery*: B. T. Rose.

In addition to these, 107 candidates were admitted to the degree of B.Sc. and 16 to the degree of M.B.

The honorary degree of Master of Music was conferred on Sir Thomas Beecham and Francis Donald Tovey.

**BRISTOL.**—The resignation of Prof. F. Francis as dean of the faculty of science is announced. Prof. A. M. Tyndall is to succeed him in the office, with Mr. P. Fraser as deputy dean.

Prof. C. Lloyd Morgan, on relinquishing his chair, has been appointed emeritus professor of psychology and ethics.

Dr. C. D. Broad has been appointed to the chair of philosophy.

**CAMBRIDGE.**—Dr. T. M. Lowry, C.B.E., has been elected professor of physical chemistry in the University. This is a first appointment to a newly created chair.

**LIVERPOOL.**—Dr. W. Mason has been appointed professor of engineering (strength of materials), Mr. C. O. Bannister professor of metallurgy, and Mr. W. H. Gilmour professor of dental surgery.

**LONDON.**—The King has been pleased to approve the appointment of Mr. Ernest Barker, fellow and

tutor of New College, Oxford, to the office of Principal of King's College in succession to the late Dr. R. M. Burrows.

Applications are invited for the William Julius Mickle fellowship, which is awarded annually to the man or woman who, being resident in London and a graduate of the University, has, in the opinion of the Senate, done most to advance medical art or science within the preceding five years and shown conspicuous merit. The fellowship is of the value of at least 200l. Applications must reach the Principal Officer of the University by, at latest, the first post on October 1 next.

**MANCHESTER.**—The King, on the recommendation of the Chancellor and Council of the Duchy of Lancaster, has contributed 100 guineas to the appeal fund.

The Manchester correspondent of the *Times* announces that Mr. Maxwell Garnett, Principal of the College of Technology, has resigned, and is asking to be relieved of his duties at the end of the summer vacation. He adds:—"There has for some time past been acute controversy between the Principal and the Education Committee regarding the former's policy of raising the educational status of the college, which constitutes the Department of Technology in Manchester University. The Education Committee recently decided to limit the number of degree students and to admit a certain number of senior technical-school boys as whole-time students. In communicating this decision to candidates for admission to the degree courses, Mr. Garnett suggested the possibility of its reversal by the City Council. The Education Committee published its censure of this letter, and both the policy of the committee, which was represented in the debate as an emergency policy for a single year, and the censure were endorsed by the City Council last week." Under Mr. Garnett's guidance the educational work of the college has developed greatly, the number of matriculated students being now more than six times greater than it was when he became Principal eight years ago. The demand for graduates from the college is far greater than the supply, and there has been a ready response to the appeal for funds for the purpose of extending its highest work.

Mr. W. M. CUMMING, hitherto of the British Dye-stuffs Corporation, Ltd., has been appointed senior lecturer in organic chemistry at the Royal Technical College, Glasgow.

Two Frecheville research fellowships, each of the yearly value of 300l., tenable for one year, and possibly for a second year, are being offered by the Imperial College of Science and Technology, South Kensington. The fellowships are intended to aid in carrying out any investigation or research connected with mining, mining geology, metallurgy, or the technology of oil considered by the selection committee to be of sufficient use or promise. Applications, in writing, giving particulars of the proposed investigations of candidates, should be made to the Secretary of the College by, at latest, August 31 next.

The following bequests, among others, were made by the late Mr. T. W. Backhouse, whose death was reported in NATURE of May 13 (p. 335):—50l. to the British Association; 700l. to his trustees upon trust, to apply the same as they in their absolute discretion may consider expedient towards the carrying on of the scientific calculations based upon observations and notes made by him in astronomy, meteorology, or other branches of science, and towards the publica-

tion of them, any sum remaining over being given to the British Association; and all his astronomical journals and drawings of Jupiter and Mars to the British Astronomical Association. His trustees are to complete and publish the star maps for tracing meteor paths now in process of completion under the care and charge of Sir William Peck, of The Observatory, Edinburgh.

A SUMMER meeting of the Association of Technical Institutions will be held at Cambridge on Friday and Saturday, July 23-24. The proceedings will commence on the Friday at 10 a.m., when the president, the Marquess of Crewe, will take the chair. Papers will be read on Friday morning by Principal J. C. Maxwell Garnett on a national system of education and by Principal C. Coles on the necessity for close co-operation between technical colleges and the universities. On Saturday morning Principal C. L. Eclair-Heath will read a paper on the relations which should exist between the day continuation schools and the central technical college, and Principal L. Small one on adult education in relation to the work of technical schools. Resolutions dealing with adult education will be submitted at the conclusion of the reading of Principal Small's paper.

WE are notified by the Board of Education that the removal of the main offices of the Board from the Victoria and Albert Museum, South Kensington, to King Charles Street, Whitehall, is in progress, and will, it is hoped, be completed by the end of the present month. On and after July 26 the official address of the Board will be Whitehall, S.W.1. It is requested that only urgent communications shall be sent until after July 24, and that these shall be marked "Urgent" on the outside wrapper. The Medical Branch of the Board is at Cleveland House, 19 St. James's Square, S.W.1. The Pensions Branch is at the Science Museum, Imperial Institute Road, South Kensington, S.W.7. The Examinations Section of the Board is housed at 49 Cromwell Road, South Kensington, S.W.7. The office of Special Inquiries and Reports and the Library will remain for the present at the Victoria and Albert Museum. Visitors whose business solely concerns these branches should call at the addresses given above.

THE activity of the scientific society of a school may be taken as a measure of the interest aroused in scientific subjects and a sign of progressive teaching. Clifton College occupies a high position, judged by this standard, and its scientific society, founded so long ago as 1869, continues to foster the inborn aptitude of many young people for observation and experiment. We have before us a list of exhibits at a conversazione given by the society on July 8, and we do not hesitate to say that the demonstrations, apparatus, specimens, and collections shown would do credit to any scientific society. The demonstrations included wireless telegraphy and telephony, the artificial formation of clouds, the fixation of nitrogen, the fractional distillation of petrol from crude petroleum, and other subjects, and the exhibits illustrated many interesting facts and phenomena of biological and physical science. The conversazione was held to show to parents and friends the work and resources of the scientific society, and we are sure that the company must have been impressed by what was displayed. Clifton College is renowned among the public schools for its attention to science, and the recent conversazione shows that it is able to maintain the high place gained for it by men like Wilson, Shenstone, Worthington, and Rintoul.

Societies and Academies.

LONDON.

Royal Society, June 24.—Sir J. J. Thomson, president, in the chair.—Sir Ray Lankester: Some rostracinate flint implements and allied forms. A series of rostro-carinate flint implements is described and figured in this paper from various localities, including one from the Lower Palaeolithic gravel of the valley of the Oise (France). It is shown that the form exhibited by the "Norwich test specimen," with ventral plane, dorsal plane or platform, anterior rostrum, with dorsal carina or keel, is modified in some of the specimens here figured by the "flaking away" of the ventral plane and by the hook-like curvature of the rostrum. A large Sub-Crag example is described, in which only one of the characteristic features of the type, namely, the great ventral plane, is retained, the implement serving as a very efficient "jack-plane." The evidence of the manufacture of these implements by a series of humanly directed blows is indicated by the illustrative drawings.—Lord Rayleigh: A re-examination of the light scattered by gases in respect of polarisation. I.: Experiments on the common gases. Re-determinations are given of the relative intensity of the two polarisations in the light scattered at right angles by pure gases. The paper is chiefly concerned with developing accurate experimental methods. The values obtained are as follows:

Gas	H <sub>2</sub>	N <sub>2</sub>	Air	O <sub>2</sub>	CO <sub>2</sub>	N <sub>2</sub> O
Intensity of weak component polarisation ...	4.51	4.74	5.68	10.1	12.4	16.1
(Strong component = 100.)						

—A. Mallock: Note on the influence of temperature on the rigidity of metals. The experiments here described were carried out at the Davy Faraday Laboratory as a continuation of a somewhat similar set on the temperature-variations of Young's modulus (see Proc. R.S., A, vol. xcv.). The method adopted in the present series depended on the determination of the periods of a torsion balance the restitutive couple of which was given by the rigidity of a specimen of the metal tested at various temperatures. The coefficients of temperature-variation found for rigidity agreed with those for Young's modulus in so far that in both cases the variation diminished as the melting point of the metal increased. The chief value, however, of the present experiments was in showing that the natural plasticity or internal friction of metals (which leads to what has sometimes been called hysteresis) was even more affected by temperature than were the coefficients of elasticity, and that the value of "rigidity" obtained from the observed periods was very appreciably affected by the variation of plasticity. For this reason the numerical results are not given in the paper, but the method of experiment is described and the nature of the errors introduced by the change of plasticity stated.—E. F. Armstrong and T. P. Hilditch: A study of catalytic actions at solid surfaces. V.: The rate of change conditioned by a nickel catalyst and its bearing on the law of mass-action. The hydrogenation of selected simple organic compounds containing one ethylenic linkage has been studied with reference to the indications of a linear relation between the amount of hydrogenation and time which were observed in the case of mixtures of unsaturated glycerides (part I. of this series). It is now found that this relation, in the case of methyl and ethyl cinnamates, safrol, or anethol (when hydrogenated in the liquid state in presence of nickel at 140° or 180° C.), takes a linear

form for at least 60 per cent., and in most cases 80 to 90 per cent., of the whole action. The interpretation of the mechanism of the action which the authors deduced from the work on unsaturated glycerides thus receives experimental confirmation.—H. **Jeffreys**: Tidal friction in shallow seas. In a recent paper G. I. Taylor has shown that the friction of the tidal currents in the Irish Sea over the bottom causes enough dissipation of energy to account for about one-fiftieth of the known empirical secular acceleration of the moon. This suggests that other and larger shallow areas within strong tidal currents will contribute a still greater amount to the dissipation of energy, and in the present paper the chief shallow seas of the earth are treated separately. The greatest dissipation is found to take place in the Bering Sea, the Yellow Sea, and the Strait of Malacca. Altogether, enough is found to account for about 80 per cent. of the secular acceleration, leaving a balance to be explained by currents in fjords and along the open coast.—Prof. J. C. **McLennan**, J. F. T. **Young**, and H. J. C. **Iretton**: Arc spectra *in vacuo* and spark spectra in helium of various elements. (1) The vacuum arc spectra of antimony, bismuth, calcium, magnesium, silver, and copper, and the spark spectra in helium of antimony, bismuth, aluminium, cadmium, lead, magnesium, thallium, and tin, have been investigated in the region below  $\lambda=1850$  Å.U. (2) The measurements of the arc spectra of antimony, bismuth, calcium, and selenium, and the spark spectra of antimony and lead, appear to be the first recorded for these elements in this region. (3) The work with the vacuum grating spectrograph has resulted in the extension of the vacuum arc spectrum of copper to about  $\lambda=1216$  Å.U.—Prof. J. C. **McLennan** and A. C. **Lewis**: Spark spectra of various elements in helium in the extreme ultra-violet. In this investigation the spark spectra in helium of the elements silicon, tellurium, molybdenum, and zirconium have been determined for the spectral region between  $\lambda=1900$  Å.U. and  $\lambda=1600$  Å.U.—K. H. **Kingdon**: Low-voltage ionisation phenomena in mercury vapour. (1) By the use of a magnetic field experimental proof has been given that when mercury-vapour atoms are bombarded with electrons possessing volt-velocities greater than 4.9, the atoms may be ionised by these collisions. (2) An attempt has been made to explain the experimental results of Davis and Goucher on the basis of the results obtained. (3) Arguments are presented for showing that the production of ions in mercury vapour at this voltage is not so definitely at variance with the Bohr theory as might at first be thought. (4) The experiments go to show that the low-voltage ionisation is not due to ionisation by successive impacts, but that perhaps, in order that a 4.9-volt collision should produce ionisation, the velocity of the impinging electron must bear some definite orientation with regard to the orbit of the electron which is to be ejected from the atom.—Sir George **Greenhill**: Electrification of an insulated lens and allied problems treated by the stream function.—C. **Chree**: Simultaneous values of magnetic declination at different British stations. A comparison is made of corresponding diurnal variations of magnetic declination at Eskdalemuir and Kew observatories. Mean monthly, daily, and hourly values of declination at Eskdalemuir, Stonyhurst, Falmouth, and Kew are compared. The results are also given of the measurements of a large number of irregular declination changes at the several stations. It is found that the differences between different stations increase with the amount of magnetic disturbance, and that if accurate information is desired as to magnetic declination anywhere in the field,

observations taken on disturbed days should not be relied on. It is thus important that observatory records should be consulted before the results of field observations are accepted. A number of results are obtained as to the relative amplitudes of irregular declination changes at the several observatories.—J. **Mercer**: Symmetrisable functions and their expansion in terms of biorthogonal functions. The purpose of this communication is to announce certain results relative to the expansion of a symmetrisable function  $\kappa(s, t)$  in terms of a complete system of fundamental functions corresponding to  $\kappa(s, t)$ , regarded as the kernel of a linear integral equation. An expansion of the function of positive type by which  $\kappa(s, t)$  is symmetrisable is obtained and applied in two important cases.—W. F. **Sheppard**: Reduction of error by linear compounding. The paper deals with the general problem of improving an observed quantity which contains an unknown error by adding to it a linear compound (linear function) of other observed quantities, called auxiliaries, the coefficients in the added portion being chosen so as to make the mean square of error of the whole a minimum. This is a generalisation of the special problem of finding the improved value when the auxiliaries are the differences of sufficiently high order of a set of quantities. The treatment of the problem is simplified by a brief statement of general theorems, and by a theory of conjugate sets of quantities. The object is to arrive at formulæ suitable for numerical calculation.—G. B. **Jeffery**: Plane stress and plane strain in bipolar co-ordinates. The solution is given for a flat, elastic plate bounded by two circles when under stresses applied over its boundaries. Curvilinear co-ordinates are employed, for which the co-ordinate curves form a double set of orthogonal coaxial circles. Important particular cases are: (1) A circular plate with an eccentric circular hole; (2) a semi-infinite plate bounded by a straight edge with a circular hole; and (3) an infinite plate containing two circular holes. The differential equation of the stress function is solved for these co-ordinates, the stress function is obtained for given arbitrary stresses applied over the boundaries, and expressions are deduced for the stresses and displacements produced at any point of the plate.—R. O. **Street**: The tidal motion in the Irish Sea: Its currents and its energy. Certain general relations are obtained from the Laplacian dynamical theory connecting the form of the tidal wave and the magnitude of the surface current on a sea of limited extent rotating with the earth. In continuation of a former paper, these are applied to the recorded data for the Irish Sea, and the agreement is found to be fairly satisfactory. A second approximation to the hydrodynamical problem for a rotating tidal basin is then effected, and by means of the relations thus obtained the mean rates of transfer of water and of energy across certain vertical sections placed transverse to the direction of the flood-stream in the Irish Sea are computed from the existing hydrographical data. The results show that there is a residual flow of water northwards through this region of such magnitude that the Irish Sea would empty itself through the North Channel about three times a year, while the tidal flow of energy from all causes which takes place into this area is at the mean rate of about  $6 \times 10^{17}$  ergs per second. The result of this estimate of the flow of energy into the area is in general agreement with an independent one made recently by Mr. G. I. Taylor (Phil. Trans., A, vol. cccx., 1919, pp. 1-33). If we could assume that this energy is all dissipated, the result would be about 250 times the viscous dissipation calculated directly by the writer in a previous paper (Roy. Soc. Proc., A,

vol. xciii., 1917, pp. 348-59), on the assumption of smooth laminar tidal motion throughout the region.

—W. G. Palmer: The catalytic activity of copper.

**Part I.** Simple apparatus is described for the measurements by chronograph records of the reaction velocities at different temperatures of a typical catalytic action—that of the dehydrogenation of alcohol by copper. Details are given of the methods used in preparing a reproducible contact material. After oxidation and reduction a second time the copper showed an activity of unchanged value. It is shown that copper prepared electrolytically is quite inactive as a catalyst, in spite of great variation in the conditions of its deposition. Copper reduced from its oxide was active at temperatures above 200° C., but this activity depended on the temperature at which the metal was reduced from its oxide.—S.

**Barratt:** The origin of the "cyanogen" bands. (1) Observations have been made of the spectra of the flames of a number of gases containing carbon, hydrogen, nitrogen, and oxygen. (2) The cyanogen bands are strongly developed in the coal-gas-nitrous oxide flame. (3) Evidence has been obtained that they are entirely absent from the hydrogen-nitrous oxide flame if all traces of carbon are excluded, and it appears to follow that the presence of carbon is essential to their production. (4) The appearance of the cyanogen bands is, under appropriate conditions, a more delicate test for carbon than that of any of the other bands associated with that element. On the other hand, this spectrum is not necessarily developed when both carbon and nitrogen are present.

(5) The conclusion of Grotrian and Runge that the cyanogen spectrum is to be attributed to nitrogen is shown to rest on assumptions which are not confirmed in the present investigation. (6) The cyanogen spectrum provides a very delicate test for the presence of compounds of nitrogen when admitted in the form of a gas to hydrocarbon flames burning in air, since elementary nitrogen does not appear in ordinary circumstances to be effective in producing the cyanogen bands in such flames. (7) The intensity of the cyanogen bands when carbon compounds are admitted to the hydrogen-nitrous oxide flame bears no simple relation to the amount of carbon thus added.—F. Horton and Ann C. Davies: The effects of electron collisions with atmospheric neon. The critical velocities for electrons in neon were investigated by methods similar to those employed with helium and argon. It was found that neon differed from these gases in showing more than one critical velocity both for radiation and for ionisation, these critical velocities being detected under conditions such as to preclude the possibility of any of them being due to the displacement or removal of a second electron from the atom.—A. G. Bennett: The occurrence of diatoms on the skin of whales. With an appendix by E. W. Nelson. The author states that the skin of certain fin whales and blue whales captured in sub-Antarctic waters is discoloured by a superficial film of a buff colour, resembling in tint the coloured bands often observed on floating ice. Whales thus affected are nearly always fat. Microscopic examination showed that this film consists of immense numbers of diatoms. The fat individuals are probably those which have spent some time in the far South, where the supply of whale-food is very abundant during the summer. There is reason to believe that the thin individuals are recent arrivals from warmer water. The skin of these thin specimens appears to be free from any noticeable film of diatoms; their light parts are thus white instead of having the yellow tint which has given rise to the name "sulphur-bottom" applied by the whalers to whales in which the light parts are yellowish. The cutaneous film

of Antarctic "sulphur-bottoms" may be composed of the same diatoms as those which form the coloured bands on ice.—R. W. Wood: An extension of the Balmer series of hydrogen and spectroscopic phenomena of very long vacuum tubes.—F. W. Aston and T. Kikuchi: Moving striations in neon and helium. When an induction-coil spark is passed through a spectrum tube containing neon, and the discharge observed with a rotating mirror, it is seen to consist of bright striations moving from the anode towards the cathode. When first observed the velocity was found to be roughly that of sound in the gas. Further investigations now show that this is only a limiting case of a very complex phenomenon. The velocity is found to decrease with increase of pressure, and also to depend on the bore of the tube. The effect of change of temperature has been investigated, and curves are given showing that at constant volume the effect is much greater than the expansion coefficient. At constant pressure the temperature effect comes in only at high temperatures, when it is probably due to impurities liberated from the tube. Helium is found to give much the same sort of results as neon. Experiments with mercury vapour and other gases are also described. No satisfactory theoretical conclusions have yet been arrived at, and further experiments are in progress.

**Geological Society, June 23.**—Mr. R. D. Oldham, president, in the chair.—O. Holtedahl: The Scandinavian mountain problem. A brief account is given of the history of research regarding the Scandinavian mountain problem, which deals with the superposition of highly metamorphosed, often gneissose, rocks upon slightly altered fossiliferous Cambro-Silurian sediments. From a consideration of the phenomena in the mountain-belt of deformation it is inferred that the age of the displaced materials depends upon the angle of inclination of the thrust-planes and their depth. Though the thrusts have extended downwards for a considerable distance, they have not generally, in the author's opinion, reached below the level of the pre-Cambrian plane of denudation, and no true Archæan rocks could, as a rule, have been tapped. In support of these conclusions some of the tectonic features of two districts are indicated: (1) Finmarken, in Northern Norway, and (2) the southern part of the Sparagmite area near Randsfjord, in South-Central Scandinavia. Brief descriptions are given of the rock-groups in Finmarken and their structural relations. Special attention is directed to the structure of the Alten district, where the main tectonic feature is a highly undulating thrust which does not intersect the pre-Cambrian floor. Regarding the Randsfjord district, the original order of succession of the strata is indicated from the Holmia shale to the close of the overlying Cambro-Silurian sediments. Pressure from the north in Late Silurian time developed imbricate structure in these sediments, but such displacements are not supposed to have affected the pre-Cambrian floor. As investigation proceeds it seems to become increasingly evident (1) that the highly metamorphic sedimentary rocks of the middle and northern parts of the eastern mountain-belt are mainly of earlier Ordovician age, while those west of the Sparagmite region in the south-western mountain district are chiefly of Silurian age, and (2) that the igneous materials associated with these highly metamorphosed sediments are younger intrusive rocks.

**Aristotelian Society, July 5.**—Prof. Wildon Carr in the chair.—Dr. W. F. Geikie-Cobb: Mysticism, true and false. The application of the term "mystic" to current psychic phenomena was unwarranted. True mysticism was an immediate apprehension of the one

as the good rather than the true; it possessed a positive, personal, unquestioning quality which is a necessary feature of all moral valuation, and belonged to the world of the "excessive," and therefore was, *per se*, beyond logic. All attempts to communicate the mystic experience were limited to the use of symbols, and, therefore, by their very nature doomed to partial failure. Those symbols, however, were not selected arbitrarily by the conscious mind, but drawn from the storehouse of the unconscious. Mysticism differs from "extroversion" in that its supreme interest is in the one who is at once another and the ground of the mystic's being. The truth of mysticism is implied in the truth of the self as transcendental, a truth without which the empirical self loses most of its value. But mysticism is not adequately defined as a form of feeling, and what has led to its being so defined is the fact that not thought, but love, is the distinguishing function of all true mystic experience. If an air of unreality surrounds the utterances of mystics, it is only for those who are strangers to love. He who loves eternal beauty holds its transitory appearances as of lesser worth. Dante, for example, at the height of his vision saw love enthroned, and declared that it was love which moved the sun and the other stars. Before this supreme experience of love it would seem that all discursive thought was foredoomed to silence as a worshipper in the outer court of reality.

## DUBLIN.

**Royal Dublin Society, June 22.**—Dr. F. E. Hackett in the chair.—Prof. W. Brown and P. O'Callaghan: The change in the rigidity of nickel wire with magnetic fields. Transverse magnetic fields, both direct and alternating, have the reverse effect on the rigidity of nickel that direct or alternating longitudinal magnetic fields have; that is, for the former there is an increase, and for the latter a decrease.—Prof. G. H. Carpenter: Injurious insects observed in Ireland during the years 1916-17-18. The paper contains records of injury to apple fruitlets by capsid bugs, as recently noticed in England, and also by beech weevils (*Orchestes fagi*), as observed by Theobald in Devonshire in 1912. There are also accounts of the feeding of *Pinus tectus* in stores of casein and in carpets.—A. G. G. Leonard and Agnes Browne: Some derivatives of nitrotoluidine (4-nitro-2-amido-1-methylbenzene). The following compounds obtained by the diazotisation of nitrotoluidine [ $\text{NH}_2 : \text{Me} : \text{NO}_2 = 1 : 2 : 5$ ] and suitable couplings have been described: Nitromethylphenylazo- $\beta$ -naphthol, bright red needles, m. p. 204° C.; nitromethylbenzenediazoamino-*o*-toluene, yellow needles, m. p. 133° C.; nitromethylbenzenediazoamino- $\beta$ -toluene, yellow hexagonal plates, m. p. 131° C.; nitromethylaminobenzene-*p*-sulphonic acid, yellow amorphous substance, m. p. 129° C.; methyl-nitrodiazoamino- $\beta$ -nitrobenzene, yellow amorphous powder, m. p. 118° C.; and 2-methyl-5-nitro-2':4'-dihydroxyazobenzene, yellow amorphous powder, m. p. 234° C.—The late Prof. McClelland and the Rev. H. V. Gill: An investigation into the causes of the self-ignition of ether-air mixtures. When a mixture of ether and air is allowed to expand suddenly into an evacuated tube 3 ft. long and of about 3 in. diameter, it is found to ignite. This ignition is often followed by an explosion which may shatter the tube. The authors describe experiments made to determine the temperatures at different parts of the tube when pure air is used instead of the mixture. A thermo-couple was employed. The increase of temperature following on the inrush of air was found to be a maximum near the closed end of the tube, and to decrease in positions further from the end. The length of the tube has an important effect on the rise of tempera-

ture. In the case of a tube 3 ft. long the temperature reached was 193° C. From results arrived at by other methods it appears that this temperature is sufficient to cause the ignition of ether-air mixtures. Theoretical considerations were dwelt on. It is proposed to investigate further certain points of interest connected with this effect.

## PARIS.

**Academy of Sciences, June 28.**—M. Henri Deslandres in the chair.—L. De Launay: The course of the Coal Measures in the Central Massif and at its edges. An attempt to deduce some general considerations upon which experimental borings can be placed in the Paris basin.—L. Maquenne and E. Demoussy: A case favourable to the action of copper on vegetation. A study of the influence of traces of copper salts on the water-culture of lettuce, peas, and wheat.—Em. Bourquelot and H. Hérissay: The presence in the melilot and woodruff of glucosides furnishing coumarin under the hydrolysing action of emulsin. The fresh plants (*Melilotus officinalis*), extracted with boiling water, gave a solution containing traces only of free coumarin, but the same liquid after treatment with dilute sulphuric acid gave crystals of coumarin on distillation, proving that the coumarin was combined, probably as a glucoside. The plant was shown to contain an enzyme also capable of hydrolysing the glucoside. Similar results were obtained with *Asperula odorata*.—A. Righi: Relativity and a scheme for a decisive experiment.—Ch. Ed. Guillaume: Values of the expansions of standard nickel-steels. In the preparation of nickel-steels certain amounts of manganese and carbon are necessarily present. For the standard of reference a nickel-steel containing 0.4 per cent. manganese and 0.1 per cent. carbon has been chosen, and the effects of varying amounts of these elements upon the expansion have been based on this as a type. The results are condensed in two curves representing the values of the two coefficients,  $\alpha_{20}$  and  $\beta_{20}$ , of the equation of expansion.—G. J. Remondos: The modulus and zeroes of analytical functions.—J. Chazy: The course of the movement in the problem of three bodies when the time increases indefinitely.—E. Belot: The origin of solar and stellar heat.—A. Veronnet: The temperature of formation of a star in an indefinite homogeneous nebula.—M. Guineau: Verification of the thermo-electricity of liquid mercury. C. Benedicks has recently proved experimentally the existence of a new thermo-electric effect produced in a homogeneous metallic circuit by an asymmetrical distribution of temperatures. The results verify and complete those of M. Benedicks.—A. Sellaier: The analysis of three galvanomagnetic effects. Confirmation of a new effect.—M. Audant: Contribution to the study of the critical state of ethyl ether. Studies on the variations of the critical temperatures with the tube-filling and on the critical opalescence.—M. Pauthenier: The ratio of the absolute retardations in the Kerr phenomenon for different wave-lengths in the case of nitrobenzene. Application of the method of instantaneous charges to carbon bisulphide. The ratio of the absolute retardations in both carbon bisulphide and nitrobenzene is  $-2$  if the times of charge are sufficiently short.—E. Damour: The application value (*valeur d'usage*) of combustibles. This value is inversely proportional to the weights of two combustibles required to produce the same thermal effect in a given furnace. Since the efficiency depends on the nature of the fuel, the application value is not measured by the calorific value alone. The temperature of combustion is an important factor in determining the price of a fuel.—R. Dubrissay: The application of a new method of physico-chemical analysis to the study of double salts. The method is based on

the measurement of miscibility temperatures with phenol. The miscibility temperatures of certain pairs of salts follow very nearly an additive rule; other salts show marked deviations, and for these the existence of double salts in solution appears probable.—**MM. Lespiau and Bourguet**: The production of true acetylene hydrocarbons starting from epibromhydrin. Compounds of the type  $\text{CH}_2\text{CBr}\cdot\text{CH}_2\text{R}$  are readily obtained by the interaction of  $\alpha$ -epibromhydrin and a magnesium alkyl derivative, and from these by three simple reactions good yields of substituted acetylenes,  $\text{HC}\equiv\text{C}\cdot\text{CH}_2\text{R}$ , are produced. Full details of the preparation of normal pentine (*n*-propylacetylene) by this method are given.—**E. Chaput**: Remarks on the rôle of dislocations in the tectonic of the Côte d'Or.—**P. Bonnet**: The movements of the seas at the limit of the Permian and the Trias in the geosynclinals of Eurasia.—**G. M. Stanoievitch**: The aeroplane and hail. Suggestions for the prevention of hailstorms by aeroplanes.—**M. Nobécourt**: The anatomical structure of the tubercles of the Ophrydæ.—**G. Mangenot**: The evolution of the chromatophores and the chondriome in the Floridæ.—**P. Guérin and Ch. Lormand**: The plasmolytic action of a certain number of vapours.—**MM. Lapique and Brocq-Rousseu**: Marine algæ as food for the horse. An account of an experiment on two horses in full work. The oats in the ration were gradually replaced by seaweed (*Laminaria flexicaulis*), and the horses worked normally for twenty days on food from which oats were absent. Then the horses were put to extra heavy work for three days, still on hay and seaweed, and their condition was as good as that of horses doing the same work on the usual food, hay, straw, and oats.—**M. Gautiez**: The influence of the attitude of the body on respiration.—**A. d'Arsonval**: Remarks on the preceding communication.—**J. Amar**: Attitudes of the body and respiration. Walking on the front of the foot, head thrown back, allows large and deep respirations. Walking on the heels has a contrary effect, generally harmful to the health.—**R. Wurmser**: The action of chlorophyll on radiations of different wave-lengths.—**A. L. Herrera**: The imitation of cells, tissues, cell-division, and the structure of protoplasm with calcium fluosilicate. Confirmation of the researches of **MM. Gautier and Clausmann** on the biological importance of fluorine. Calcium fluosilicate produced by the double decomposition of an alkaline silicate and potassium bifluoride in the presence of calcium chloride and water, if the diffusion of the solutions is very slow, gives remarkable imitations of the structure of protoplasm, natural cells, and their division. These imitations can be studied, stained, and preserved by the usual histological processes.—**C. Pérez**: A new type of Eucarid, *Rhopalione uromyxon*, sub-abdominal parasite of *Ostracotheres spondyli*.—**J. Dragouï and M. Fauré-Fremiet**: Development of the aerial canals and the histogenesis of the pulmonary epithelium in the sheep.—**W. R. Thompson**: *Cyrrilia angustifrons*, parasite of a terrestrial Isopod, *Metaponorthus pruinosus*.—**P. Thomas and A. Chabas**: The estimation of tyrosin and the dibasic amino-acids in the proteids of yeast.—**A. Mayer, H. Magne, and L. Plantefol**: The toxic action of dichloroethyl sulphide.—**A. Besredka**: An attempt at the purification of therapeutic sera.—**F. Ladreit**: Histological polymorphism of certain epithelial neoplasms and the relations between these inflammatory neoformations to cancerous tumours.

SYDNEY.

Linnæan Society of New South Wales, April 28.—**Mr. J. J. Fletcher**, president, in the chair.—**G. H. Hardy**: Synonyms, notes, and descriptions of Australian flies of the family Asilidæ. As a result of work done since  
NO. 2646, VOL. 105]

the revision of Australian species of this family by **Miss Ricardo** in 1912-13, it has become possible to establish the identity of many of the species which were not identified at the time. The present paper deals almost entirely with the genus *Neotamus*. Of the forty-seven species usually placed in sub-genera of this genus, twenty are dealt with and placed under twelve species; two additional species are described as new.—**F. Muir**: A new genus of Australian Delphacidæ (Homoptera). Most, if not all, of the described Australian Delphacidæ are from eastern States. Of the fourteen genera recorded as Australian the author considers only one as entogenic. The genus described as new in this paper is from King George's Sound, South-West Australia, and is regarded as entogenic.—**Dr. C. P. Alexander**: An undescribed species of *Clyto-cosmus*, Skuse (*Tipulidæ*, Diptera). The genus *Clyto-cosmus* was proposed by Skuse in 1890, and has remained monotypic until now, the type species being *C. Helmsi* from Kosciusko. A second species is here described as new from Ulong, on the Dorrigo tableland.

## Books Received.

A Text-Book of Organic Chemistry. By E. de B. Barnett. Pp. xii+380. (London: J. and A. Churchill.) 15s. net.

Johnston's New Era School Atlas. Pp. 40. (Edinburgh: W. and A. K. Johnston, Ltd.; London: Macmillan and Co., Ltd.) 15s. net.

Orographical, Regional, Economic Atlas. Part i.: British Isles. Pp. 32. (Edinburgh: W. and A. K. Johnston, Ltd.; London: Macmillan and Co., Ltd.) 15s. 6d. net.

Notes on Dynamics: With Examples and Experimental Work. By T. Thomas. Pp. 123. (London: Crosby Lockwood and Son.) 6s. net.

The Nomenclature of Petrology. By Dr. A. Holmes. Pp. v+284. (London: T. Murby and Co.) 12s. 6d. net.

The Botany of Iceland. Edited by Dr. L. K. Rosenvinge and Dr. E. Warming. Vol. ii., part 1. Pp. 248+5 plates. (Copenhagen: J. Frimodt; London: J. Wheldon and Co.)

The Life and Work of Sir Jagadis C. Bose (an Indian Pioneer of Science). By Prof. P. Geddes. Pp. xii+259. (London: Longmans, Green, and Co.) 16s. net.

Meddelelser fra Kommissionen for Havundersøgelser. Serie Fiskeri. Bind 5, No. 9, 1919. Investigations as to the Effect of the Restriction on Fishing during the War on the Plaice of the Eastern North Sea. By Dr. A. C. Johansen and Dr. K. Smith. Pp. 53. Serie Fiskeri. Bind 6, No. 1, 1920. On the Occurrence of the Post-larval Stages of the Herring and the "Lodde" (*Clupea harengus*, L., and *Mallotus villosus*, O. F. M.) at Iceland and the Faeroes. By P. Jespersen. Pp. 24. (København: C. A. Reitzel.)

Fisheries. England and Wales. Ministry of Agriculture and Fisheries. Fishery Investigations. Series ii.: Sea Fisheries. Vol. iv., No. 3. Report on the Scales of some Teleostean Fish, with special reference to their Method of Growth. By G. W. Paget. Pp. 24+4 plates. 3s. 6d. net. Series iii.: Hydrography. Vol. i.: The English Channel. Part 3: The Section from the Isle of Wight to Havre. Review of the Physical and Chemical Properties of the Surface Waters, and the Variations of these Properties from August, 1904, to December, 1918, in Comparison with Corresponding Variations on the Sections discussed in parts 1 and 2 of this volume.

By Dr. E. C. Jee. Pp. 24. 3s. net. Series iii.: Hydrography. Vol. i.: The English Channel. Part 4: The Section from Newhaven to Caen. Review of the Physical and Chemical Properties of the Surface Waters, and the Variations of these Properties from November, 1903, to May, 1912, in the English Channel from Newhaven to the Bay of the Seine. By Dr. E. C. Jee. Pp. 26. 3s. net. Series iii.: Hydrography. Vol. iv.: The North Sea. Part 1: From the River Tyne towards the Naze of Norway. Review of the Variations of the Physical and Chemical Properties of the Waters of the North Sea, together with Observations on the Dogger Bank. By Dr. E. C. Jee. Pp. 101. 12s. net. (London: H.M. Stationery Office.)

On Gravitation and Relativity: Being the Halley Lecture delivered on June 12, 1920. By Dr. R. A. Sampson. Pp. 24. (Oxford: At the Clarendon Press.) 2s. net.

Caithness and Sutherland. By H. F. Campbell. Pp. ix+168. (Cambridge: At the University Press.) 4s. 6d. net.

Kirkcudbrightshire and Wigtownshire. By W. Learmonth. Pp. ix+149. (Cambridge: At the University Press.) 4s. 6d. net.

Creation: Viewed by the Light of Modern Science. A Lecture given by W. Hackney, 1875. Pp. vi+29. (London: N. G. Hackney.)

Heredity and Social Fitness: A Study of Differential Mating in a Pennsylvania Family. By Dr. W. E. Key. Pp. 102. (Washington: Carnegie Institution.)

The Inscriptions at Copan. By S. G. Morley. Pp. xii+643+33 plates. (Washington: Carnegie Institution.)

Department of Agriculture and Natural Resources, Weather Bureau. Annual Report of the Weather Bureau for the Year 1917. Part 3: Meteorological Observations made at the Secondary Stations during the Calendar Year 1917. Pp. 360. (Manila.)

Union of South Africa. Department of Mines and Industries. Geological Survey. Memoir No. 13: Mica in the Eastern Transvaal. By A. L. Hall. Pp. 95+xviii plates. (Johannesburg.) 7s. 6d.

Type Ammonites. By S. S. Buckman. Part xxii. Pp. 17-18+16 plates. (London: W. Wesley and Son.)

Unconscious Memory. By S. Butler. Third edition. Pp. xxxix+186. (London: A. C. Fifield.) 8s. 6d. net.

Luck, or Cunning, as the Main Means of Organic Modification? An Attempt to Throw Additional Light upon Darwin's Theory of Natural Selection. By S. Butler. Second edition. Pp. 282. (London: A. C. Fifield.) 8s. 6d. net.

The Assessment of Physical Fitness by Correlation of Vital Capacity and Certain Measurements of the Body. By Prof. G. Dreyer, in collaboration with G. F. Hanson. Pp. xi+115. (London: Cassell and Co., Ltd.) 10s. net.

A Geographical Bibliography of British Ornithology from the Earliest Times to the End of 1918. By W. H. Mullens, H. Kirke Swann, and Rev. F. C. R. Jourdain. Part v. Pp. 385-480. (London: Witherby and Co.) 6s. net.

Department of the Interior. Bureau of Education. Statistics of State School Systems, 1917-18. By H. R. Bonner. Pp. 155. (Bulletin No. 11, 1920.) (Washington: Government Printing Office.)

The Tides and Tidal Streams. By Dr. W. B. Dawson. Pp. 43+viii plates. (Ottawa: Department of the Naval Service.)

Cocoa and Chocolate: Their History from Plantation to Consumer. By A. W. Knapp. Pp. xii+210. (London: Chapman and Hall, Ltd.) 12s. 6d. net.

The Extra Pharmacopœia of Martindale and Westcott. Revised by Dr. W. H. Martindale and Dr.

W. W. Westcott. Seventeenth edition. In 2 vols. Vol. i. Pp. xxxix+r115. (London: H. K. Lewis and Co., Ltd.) 27s. net.

British Museum (Natural History). Economic Series, No. 1. The House-fly as a Danger to Health. By Major E. E. Austen. Pp. 20. 3d. Economic Series, No. 3. Fleas as a Menace to Man and Domestic Animals. By J. Waterston. Pp. 20. 4d. Economic Series, No. 4. Mosquitoes and their Relation to Disease. By F. W. Edwards. Second edition. Pp. 19. 4d. Economic Series, No. 6. Species of Arachnida and Myriopoda (Scorpions, Spiders, Mites, Ticks, and Centipedes) Injurious to Man. By S. Hirst. Second edition. Pp. 59+3 plates. 1s. Economic Series, No. 8. Rats and Mice as Enemies of Mankind. By M. A. C. Hinton. Second edition. Pp. x+67+2 plates. 1s. (London: British Museum (Natural History).)

## Diary of Societies.

THURSDAY, JULY 15.

ROYAL SOCIETY OF MEDICINE (Dermatology Section), at 5.  
CHADWICK PUBLIC LECTURE (in Surveyors' Institution), at 5.15.—Dr. N. White: Health Conditions in Eastern Europe—Typhus a Serious Menace.  
RÖNTGEN SOCIETY (at University College), at 9.—Dr. W. D. Coolidge: Address (Special Open Meeting).

## CONTENTS.

PAGE

Medical Research. By Prof. G. Elliot Smith, F.R.S.	605
Intellectual Stock-taking. By H. W. C.	607
Petroleum Geology. By H. B. Milner	608
Fuel Problems. By J. S. S. B.	609
Hurter and Driffield. By C. J.	609
Our Bookshelf	610
Letters to the Editor:—	
The Separation of the Isotopes of Chlorine.—D. L. Chapman, F.R.S.	611
Anti-Gas Fans.—Hertha Ayrton; Prof. A. Allmand	612
The Stretching of Rubber in Free Balloons.—Dr. Henry P. Stevens; W. H. Dines, F.R.S.	613
Notes on the Habits of the Tachinid Fly, <i>Sphexapata (Miltogramma) conica</i> .—Oswald H. Latter	614
Temperature Variations at 10,000 ft.—C. K. M. Douglas	614
The Brent Valley Bird Sanctuary.—Wilfred Mark Webb	614
Researches on Growth of Plants. I. (Illustrated.) By Sir Jagadis Chunder Bose, F.R.S.	615
Isotopes and Atomic Weights. (Illustrated.) By Dr. F. W. Aston	617
Obituary:—Major-Gen. William Crawford Gorgas, K.C.M.G.	620
Notes	622
Our Astronomical Column:—	
An Easy Method of Finding Latitude	625
Increasing the Photographic Power of Telescopes	625
A New Spectropyrheliometer and Solar Measurements made with it	625
British Association: Subjects for Discussion at the Cardiff Meeting	626
Museums Association Annual Conference	626
The University of Edinburgh: New Science Buildings	627
Lessons from the Smithsonian	627
The Religion and Origin of the Hawaiian People. By Sidney H. Ray	628
Soil Temperatures. By B. A. K.	628
Control of Insect Pests	629
Scientific and Systematic Pomology	629
University and Educational Intelligence	630
Societies and Academies	631
Books Received	635
Diary of Societies	636



THURSDAY, JULY 22, 1920.

*Editorial and Publishing Offices:*

MACMILLAN & CO., LTD.,

ST. MARTIN'S STREET, LONDON, W.C.2.

Advertisements and business letters should be  
addressed to the Publishers.

Editorial communications to the Editor.

Telegraphic Address: PHUSIS, LONDON.

Telephone Number: GERRARD 8830.

### Aerial Navigation and Meteorology.

METEOROLOGY has been international ever since it became a science. From the first congress of directors of meteorological institutes at Vienna in 1873, meteorologists have been engaged in standardising methods of observation and exposure of instruments, and in devising codes for the transmission of observations by telegraph in order to compress as much valuable information as possible in the small space available for transmission at moderate cost. So the introduction of upper-air data, though strongly recommended by those who wanted to substitute calculation for "rule of thumb," had to fight its way against other useful and more easily accessible information of the older kind. The last international code, fixed at Rome in 1913 after long correspondence and discussion, kept the morning message at four groups of five figures, and allotted only one figure to upper-air data—direction of high cloud—in addition to the customary figure for weather or state of the sky. For the benefit of aerial navigation, the results of pilot-balloon ascents were telegraphed by many European observatories to the central station at Lindenbergl. Funds for the telegraphic distribution of these data and of those of soundings of the atmosphere by means of kites or cable balloons were usually lacking.

The great war has changed all this; aerial navigation demanded quick and detailed information, especially about low cloud, visibility, and wind velocity in free air. Many reporting stations were erected and connected to central offices by telephone or wireless. Meteorologists sprang up from the ground, the observational hours were multiplied, and no one considered the cost.

The result lies before us in the form of

NO. 2647, VOL. 105]

Annexe G of the Convention for the Regulation of Aerial Navigation,<sup>1</sup> the object of which is to substitute legal regulation for free international co-operation. The prominent features are:—

(1) Regulation of the collection and dissemination of meteorological information—introduction of four observational hours instead of two or three; of short-period (three to four hours) and route forecasts (six hours) on one hand, and of long-period forecasts (two or three days) on the other, besides the normal forecasts (twenty to thirty hours).

(2) Extension of the number of groups in the reports from individual stations to a central office from four to six for all stations, and from four to any number between twelve and forty-four for stations observing upper-air wind, temperature, and humidity.

(3) Introduction of new codes for the new information and several of the customary data.

Annexe G has been discussed at a meeting in London of members of the pre-war International Meteorological Committee, and again at the Conference of Directors of Meteorological Institutes at Paris in October, 1919; but definite resolutions were postponed. We have reason to think, however, that the following remarks express the opinion of a large majority of Continental meteorologists and several of their British colleagues.

There is practically no difference of opinion about the necessity of reorganisation and centralisation of the collection and dissemination of meteorological information. Standard observational hours, quick transmission of the reports to the national centre, exchange of collective reports between centres with a maximum distance of 1500 km. within an hour and a half of the observation, followed by selections from these reports sent out over world-wide ranges by a few high-power wireless stations within three hours of the observation, is a good, but not altogether new, scheme. Its complete realisation will be hampered only by the unsatisfactory state of communication by telegraph or telephone in some countries. The proposed simultaneous transmission of several of the national collective reports may cause the receiving stations to miss part of them; successive transmission may take more time than the convention grants; but these are only technical details: the principle is all right. Differentiation of forecasts also is necessary, but it has to be adapted to local circumstances.

<sup>1</sup> "Air Ministry. Convention portant Réglementation de la Navigation Aérienne (12 Octobre, 1919). Convention for the Regulation of Aerial Navigation (October 13, 1919)." Pp. 48. (London: H.M. Stationery Office, 1920.) Cmd. 670. Price 1s. net.

Appendix III. mentions, in addition to the observations of physical quantities like wind, pressure, temperature, and humidity, no fewer than seven kinds of weather phenomena (fog, clouds, precipitation, visibility, etc.), and only as additional and facultative do we find wind, temperature, and humidity in the upper air, in spite of the fact that knowledge of the latter data is essential for a real prediction of weather phenomena, whereas the most minute description of present weather does not form a guarantee against sudden changes. Some years ago it might have been urged that sufficiently recent upper-air data were not available—we have shown, however, in Holland that the aeroplane is an excellent substitute for the kite or the cable balloon in almost any weather, and hence this excuse is no longer permissible. In this respect Appendix III. almost looks like a step backwards.

Certainly the multitude of codes introduced by European meteorological institutes since the war is a nuisance, but it may be taken as a symptom of the general dislike of the codes prescribed in Appendix IV. These include units, like the millibar, unfamiliar to the majority of Continental meteorologists (unless in purely scientific work), and change codes for the transmission of the usual elements without any real gain for practical purposes, and they do not use sufficient economy with the room available in the telegrams. A few specimens may illustrate this. Wind direction is given in two figures as usual, but in a scale of 1 to 72 instead of 1 to 32; this means that an accuracy of  $5^\circ$  is claimed. Every meteorologist knows that such accuracy is imaginary—the exposure of the anemometer, the turbulence of the winds, etc., cause larger variations with space and time. No fewer than four figures are allotted to past and present weather. The result is that the observer is puzzled as to the number he is to choose out of 50 or 100, five or six numbers applying equally well, or he gets into the habit of reporting some favourite phenomenon—the very slightest degree of haze, for instance. The multitude of phenomena reported makes one lose sight of the distribution of any particular class.

In our view, Appendix IV. is a mistake, and ought to be deleted as soon as possible; it may prevent some States from joining the convention, Article 34 of which allows a minority of one-fourth or even less to prevent any modification of the annexes. General rules ought to be given in the convention, details being left to a competent body like the "Comité Météorologique International," reconstituted at Paris in

October, 1919, which certainly is fully aware of the need for reforms, and will choose the best way to ensure general approval.

In the meantime, reforms are not being postponed; the majority of the Continental countries have already their wireless collective reports, and others will soon follow—special route reports for flying purposes are being exchanged, for example, between England, France, Belgium, and Holland. Meteorologists are thankful for the stimulus which aerial navigation has given to their weather services; they admire the desire for organisation and centralisation apparent in the convention; but they cannot overlook the fact that meteorology has other important applications. Theoretically it might be argued that these may look after themselves; practically it is impossible to maintain an independent system of information, say for agricultural purposes. In following up the historical line, the Comité International will try to serve all purposes equally well.

E. VAN EVERDINGEN.

### Child Physiology.

*The Principles of Ante-Natal and Post-Natal Child Physiology: Pure and Applied.* By W. M. Feldman. Pp. xxvii+694+6 plates. (London: Longmans, Green, and Co., 1920.) Price 30s. net.

DR. FELDMAN'S work is a notable addition to the books which deal with physiology. As in them, so in this volume, the reader is impressed by the great change which the past decade has wrought in the content of physiological science, and especially in the predominance of physics, of mathematics, and of chemistry which is so noticeable. Here and there one comes upon pages occupied almost entirely with mathematical formulæ. Dr. Feldman's book has all these characters; but it has also another feature, which is novel: it brings to the study of the physiology of the child (up to puberty) a consideration of the conditions of life which exist before birth, and an evaluation of the effect which the process of birth itself has upon these conditions. It has in this respect and for this reason what one might term a fructifying novelty. It sweeps into the scope of child physiology not only the vital processes of foetal life, which differ merely in details from those which prevail after birth, but also those of embryonic life, which are so manifestly unlike physiology that we commonly call them "embryology," as if they were something apart; and it travels still further back towards the origins of

things and brings in the physiology of the germ or heredity, which it requires an effort of the mind to associate with physiology at all. With so novel an outlook and so enlarged a sphere, it is impossible that everything should be exact and beyond argument; much must remain for a time uncertain, and theories will abound, and do abound, within the cover of this book. For example, the statement that the normal new-born infant is in a condition resembling acidosis is not by any means secure against attack, as a research by Sehom, made so recently as 1919, shows.

Dr. Feldman does not claim to carry over into pathology the ideas which this widened outlook of physiology suggests, and yet indirectly disease and the abnormal are recognised as lying just below the horizon in almost every part. Thus the peculiarities of the foetal circulation underlie every statement which one can make regarding congenital heart disease. And the converse is also true, for the fact that the foetal heart beats before and even at birth in a foetus possessing neither brain nor spinal cord throws light upon the physiology of cardiac action before birth, and suggests that its rhythm is myogenic, and not neurogenic, in origin. Interesting notions spring up on every page, and the reader can scarcely escape the stimulation to think out for himself their application to all sorts of phenomena. One is well accustomed to apply physiology to the clarification of the diseases of adult tissues and organs; but a certain degree of novelty attaches to the effort to look at the pathological occurrences in the new-born infant in the light supplied by the special conditions of ante-natal physiology. For example, the umbilicus is, so to say, the "one portal" by which all things (food supplies, oxygen for respiration, and the germs of disease and toxic substances) reach the unborn infant—it lives through its umbilicus, and it may die by its umbilicus—and after birth, whilst it is no longer nourished by the navel, it may yet for a time be infected through it, as in cases of septic mischief round the root of the cord stump. Most text-books speak with an uncertain sound regarding the diseases peculiar to the new-born infant—the neonatal maladies, as they are called; it will ere long be found that much which is inexplicable in their characters and causation is made plain by the study of ante-natal physiology as it is affected by the impact of birth-traumatism.

The book is abundantly illustrated and admirably arranged, and the author is particularly happy in his choice of the quotations with which he ushers in each chapter. For instance, what a range of thought along novel lines is brought

to the reader's mind by Samuel Butler's paradoxical truth with which the work begins: "Birth . . . is commonly considered as the point at which we begin to live. More truly it is the point at which we leave off knowing how to live." One is tempted to turn away from the thought as, in a sense, mental somersaulting; but if one resists this inclination and looks fairly and wholly at it, one sees that Nature's ante-natal provision for the well-being of the unborn child is as near perfection as can be imagined. The foetus, so to say, knows how to live. Birth comes as the jolt due to the changing of the gearing, and it is some time before the new-born infant, with all the aid that doctor, nurse, and mother can give him, can be said to be in harmony with his environment.

We should like to follow out other lines of thought suggested by this volume, such as His's dictum: "The ultimate aim of embryology is the mathematical derivation of the adult from the distribution of growth in the germ"; but enough has been said to send the interested reader to the book itself, where he will find fertile fields for the intellect to water and in due season to reap.

J. W. B.

### Forest Research.

*The Fungal Diseases of the Common Larch.* By W. E. Hiley. Pp. xi+204. (Oxford: At the Clarendon Press, 1919.) Price 12s. 6d. net.

THIS volume is the most important contribution to the scientific literature of forestry that has been made for some years. Mr. Hiley was well advised to select the larch as the subject of his first investigation as Research Officer in the School of Forestry in Oxford, for it is in many respects the most important species of tree that is cultivated in this country. Moreover, it is a tree the health of which has given much concern to foresters and others for many years past.

After an introductory chapter on the general relationships of host and parasite, and on the morphology of the larch, Mr. Hiley proceeds to deal with the larch disease, or larch canker in the specific sense of the term. This is due to the attack of a Discomycetous fungus, which is usually known in this country under the name of *Dasyscypha calycina*. The author does well to remind us that M. J. Berkeley was the first to recognise the fungal character of this disease, although the work of Willkomm and of Robert Hartig is more frequently cited. Hartig, followed by Massee, believed that infection could take place only through a wound, and it must be said that there is much observational and experimental evi-

dence in support of this contention. Probably the most interesting section of Mr. Hiley's volume is that in which he supports and elaborates the view that in the great majority of cases the stem of a larch is infected by the mycelium of *D. calycina* which is living saprophytically on the dead branches. This theory is not new, but it has never before been subjected to so critical an examination. It is a matter of common observation that a branch springs from the centre of a canker, and it had generally been assumed that death of the branch followed invasion of the stem. But Mr. Hiley now produces evidence which seems to prove beyond reasonable doubt that the branch has always died before the canker has originated, and, in fact, that the dead branch, serving as food for the fungus living saprophytically, has been the vehicle of infection. Such infection always takes place between the end of one growing season and the beginning of the next, consequently the last wood ring in the centre of a canker spot on a stem is always completely formed.

Another parasite of the larch which receives exhaustive treatment in the volume is *Fomes annosus*, the common cause of heart-rot. Unlike *D. calycina*, it is equally common on other conifers, and in the aggregate does a great deal of damage. The same may be said about *Armillaria mellea*, perhaps the most destructive single fungus species with which the forester has to contend.

The more important leaf and seedling parasites are also reviewed, the volume finishing with an interesting general summary and with a useful bibliography. More than seventy illustrations add greatly to the value of the treatise, which is indispensable alike to the mycologist and the forester.

### The Absorption of Light by Organic Compounds.

*Études de Photochimie.* By Dr. Victor Henri. Pp. vii + 218. (Paris: Gauthier-Villars et Cie, 1919.)

THIS monograph is the first instalment of a series in which are to be presented the results of several years of work of the author and his collaborators. From 1908 to the outbreak of war Dr. Henri devoted his attention to the experimental study of various chemical aspects of the interaction between radiation and matter, dealing chiefly with the absorption of light in the infra-red and ultra-violet regions, with dispersion in the ultra-violet, with chemical reactions brought about by light, and with certain technical and biological aspects of the subject. In

1915 he went to Russia to help in scientific work in connection with the war, and towards the end of 1917 began to work up the mass of data accumulated in preceding years. Very few of his results had been published separately—papers by Bielecki, Boll, and Wurmser will, however, be familiar to workers in this field.

The present volume essentially contains the results of the author's work on absorption and dispersion, and is of considerable interest. Employing a photographic method, carefully checked, and using a powerful source of ultra-violet light, worked out by himself and giving a continuous spectrum, he was able to measure quantitatively the exact form of the absorption curve in the ultra-violet for about 240 organic compounds. As he points out, this represents a very considerable advance, previous work being confined to the mere investigation of the positions of the bands. To these measurements are added a series of determinations of dispersion in the ultra-violet, employing a specially designed apparatus, and a number of absorption measurements in the infra-red. The application of formulæ developed by Helmholtz and Ketteler, Drude, Lorentz, etc., has enabled him to draw conclusions as to the nature of the oscillators responsible for the absorption of light of different wave-lengths, the damping (usually very great) to which such oscillators are subjected, etc.

The more important results are as follows: (a) The oscillators absorbing in the infra-red are of molecular size, are atoms or fractions of atoms in the mean ultra-violet, and electrons in the extreme ultra-violet. (b) These different oscillator systems are closely bound up with one another, and there exist simple numerical relations between the infra-red frequency due to a chromophore and the ultra-violet frequencies in molecules containing such a chromophore. This, of course, was previously discovered by Baly, to whose work adequate reference is not made by the author. (c) By the application of simple rules, the absorption spectrum of a compound can be calculated with considerable accuracy from its constitution and the characteristic infra-red frequencies of the chromophores, two simple constants for each infra-red absorption band being necessary. (d) The structure of a molecule is essentially mobile. The existence of ultra-violet absorption bands is an index of a labile and reactive state. This, again, is in agreement with Baly's views.

Other more speculative conclusions are perhaps less justified. The experimental work appears to be of a high order, and the other volumes promised will be looked for with interest.

## Our Bookshelf.

*Bibliography of Industrial Efficiency and Factory Management.* (Books, Magazine Articles, etc.)

With many Annotations and Indexes of Authors and of Subjects. By H. G. T. Cannons. (Efficiency Books.) Pp. viii+167. (London: George Routledge and Sons, Ltd.; New York: E. P. Dutton and Co., 1920.) Price 10s. 6d. net.

CAN this country pay the interest on the money borrowed during the war without reducing large sections of the community to poverty? The answer to this question appears to be that only by increasing the annual production by at least as much as corresponds to the necessary increase in taxation can we provide enough for everybody. Industrial efficiency is thus seen to be of vital importance. Employers and employed alike should therefore welcome any book which helps to improve methods of production. It will be generally agreed that our manufacturers have still much to learn in this direction.

Mr. Cannons is to be congratulated on having collected no fewer than 3500 references in this bibliography. It would appear that more attention has been given to the subject in the United States than in Great Britain. For example, in a list of thirty-two periodicals dealing more or less specifically with industrial efficiency and factory management, we notice that twenty-three are published in America.

The bibliography is divided into sixty-four subsections. The titles of a few of these will serve to indicate the scope of the book: "Academic study and teaching," "Principles of industrial efficiency," "Factory and workshop management," "Scientific management applied to special branches of industry," "Fatigue study," "Hours of labour," "Personal factor in scientific management," and "Safety methods."

We wish Mr. Cannons had done more to indicate which among the articles referred to are more likely to be worth careful study. Some help in this direction is, however, given in brief notes of the contents of many of the books and papers indexed.

*Aliments Sucrés. Sucres—Miels—Sirops—Confitures—Sucreries—Sucs et Réglisse.* Par Dr. E. Roux et Dr. C.-F. Muttelet. Pp. vi+474. Paris and Liège: Ch. Béranger, 1914. Price 12 francs.

THE manual of Drs. Roux and Muttelet on the analysis of foodstuffs of which sugar is an important constituent is naturally of somewhat restricted interest. The first part deals with the general optical and chemical methods of determining sugars and various other substances, such as dyes and antiseptics, used in confectionery. In the second part these methods are applied to the examination of commercial products such as honey, sugar, syrups, and preserves. The French laws and regulations dealing with the subject are given at some length together with extracts from those of other countries.

## Letters to the Editor.

[The Editor does not hold himself responsible for opinions expressed by his correspondents. Neither can he undertake to return, or to correspond with the writers of, rejected manuscripts intended for this or any other part of NATURE. No notice is taken of anonymous communications.]

## British and Foreign Scientific Apparatus.

It may, perhaps, be useful if I attempt to sum up the conclusions that seem to me to be justified from the somewhat divergent views that have been expressed by those who have written upon this question.

It is satisfactory to find that the makers are keenly desirous of meeting the requirements of the scientific worker. I think I am correct in saying that the majority of these prefer to obtain British rather than foreign goods, even at a somewhat higher price, provided that the quality is sufficiently good. It is here that the difficulty shows itself. It is significant that most of the makers who have written on the matter belong to the optical industry, and it is in this case that the state of affairs appears to be the least to be complained about, except, perhaps, in the smaller accessory apparatus, such as the object-marker referred to by Mr. Dunkerly (*NATURE*, June 3, p. 425). It is chiefly with regard to glass, porcelain, and chemicals that experience has been unfortunate. There has undoubtedly been improvement, but the impression given is that the makers as a whole have not altogether grasped the necessity of putting some of their best men to the work, and that there has been some carelessness in sending out goods of inferior quality. I have been told of flasks the necks of which drop off on the draining rack. It is natural that the users should be critical, especially when a large expense in time and money may be incurred by the breakage of a beaker in the final stage of a process.

The exhibitions arranged by the British Science Guild in 1918 and 1919 showed that excellent apparatus can be produced, and the difficulty is presumably in the main a matter of price. Glass and porcelain of quite satisfactory quality are being made in this country, and due credit should be given to the makers. The Worcester porcelain works, for example, supply excellent crucibles. At the same time, consumers meet with the experience that a large order cannot be relied upon to be of uniform quality. It is unfortunate, though perhaps unavoidable, that unsatisfactory apparatus was put on the market in the early stages of the supply of British glass, and it was to enable a greater perfection to be attained that I made the suggestion of a subvention (*NATURE*, May 6, p. 293). It is to be remembered that this is being done through the research associations of the Department of Scientific and Industrial Research, and it is in the direction of more scientific investigations that progress is to be looked for. In this connection, I may direct attention to the statement in the leading article of *NATURE* for June 24 that the profit of some three or four German dye-making firms in 1919 was more than 3,000,000*l.*, as compared with only 172,000*l.* by the British Dyestuffs Corporation.

The manufacturers want prohibition of import of foreign apparatus, at all events for a time, with the granting of special licences to import. I think it will be generally agreed that this would not meet the case, owing to the difficulty and delay that would necessarily be involved. They do not wish for a tariff, and the only alternative seems to be a grant in some form. When British goods have attained the neces-

sary quality and are then put on the market, it appears that there will not be any great risk of foreign competition in the matter of price. Indeed, according to several correspondents, there is little to be feared at the present time. But opinions are not in agreement.

There should be no objection to "manufacturers' associations," provided that their object is to obtain the advantage of more economical methods of manufacture, as by uniformity of standards and large-scale production, rather than the maintenance of high prices.

The cost of all research work, whether paid for by Government grants or otherwise, is greatly increased by inferior apparatus. At the present prices of materials, a single biochemical preparation may cost 4l. or 5l. or more. This may be lost by breakage at the final stage. The question naturally arises whether economy would not be effected by allowing free import, even at the cost of subventions to British makers.

With reference to Mr. Watson Baker's statement (*NATURE*, June 24, p. 518) that there are 12,000 German binoculars in London, I confess that I had chiefly in mind the use of apparatus in teaching and research. The sale for general use certainly raises a difficulty. As to losses incurred by work done for Government Departments during the war, so far as my information goes payment for these did not err on the side of economy. Liability for excess-profit duty surely implies that the profit has been made.

The statement by Mr. C. Baker (*NATURE*, May 20, p. 356) that capitalists will not put money into the business raises another question. It may well be that British makers do not find it profitable to undertake the supply of fine chemicals and special apparatus used only in small amount, even apart from foreign competition. If so, why not give up the trade to those who make a profit on the sale?

The desire of the British industry for prohibition of import appears to rest chiefly on the fear of competition by Germany. I am not one of those who imagine that because an instrument is of German origin it is necessarily superior to all others. Indeed, I have heard of instruments verified at Charlottenburg being found inaccurate. It would certainly be less obstructive than total prohibition if the restriction applied to German goods only. But there are other considerations to be remembered here, such as the importance of giving an opportunity to that country to restore its credit. However this may be, the large profits of their chemical industries referred to above raise some doubt as to the real cause of the present unsatisfactory conditions in Germany.

The point raised by Mr. Dunkerly that American microscopes and lenses are being sold here, although the rate of exchange is against us, suggests that the source of the trouble is not the low value of the German mark. This view is confirmed by other correspondents. If it is correct, there would be no real gain in a mere prohibition of import. Improvements in modes of manufacture are needed, and we come back again to the necessity for more scientific research.

I note that the British Optical Instrument Manufacturers' Association (*NATURE*, May 20, p. 355) considers that a tariff might have the result of removing the inducement to improve quality, but I foresee so many difficulties in the way of convincing a Government official that a particular piece of apparatus could not be obtained in England that I am unable to accept the suggestion of import by permit as a satisfactory alternative. If, however, it were possible for every scientific worker to obtain without difficulty a general permit for the import of

any apparatus at any time the situation would be different.

There seems to be much doubt as to whether it is really possible to obtain foreign apparatus at a price much lower than the British. Should this be the case, the payment of a subsidy might be considered where there is actual underselling. The test would then become one of quality.

The importance of the subject may, I think, serve as an excuse for this lengthy letter. Scientific workers have every desire to assist the development of the industry, but they feel that they are not justified in wasting time and money where it could be avoided. And if this correspondence has brought out the fact that satisfaction has not yet been given in the matter of quality, especially in the case of certain goods, it will have been of some value. It is possible that users have not sufficiently made known their difficulties to the makers, and have been sometimes content with the purchase of foreign material when further inquiry and discussion might have enabled British goods to be forthcoming. W. M. BAYLISS.

University College, London.

### The Separation of the Isotopes of Chlorine.

MR. D. L. CHAPMAN'S argument appears essentially to be similar to that already developed from a quite different point of view by Lindemann (*Phil. Mag.*, 1919, vol. xxxvii, p. 523; vol. xxxviii, p. 173), that because isotopes are (theoretically) separable by physical means, they must also be chemically separable according to thermo-dynamical reasoning. The fact that the particular mode of separation by semi-permeable membranes (assumption (3), *NATURE*, July 15, p. 611) is highly fanciful need not obscure the nature of the argument. Lindemann's conclusion that, though isotopes cannot be identical chemically, the difference may be reduced to an unmeasurable one of the second order of magnitude by suitable assumptions as to the "Nullpunktenergie," seems to indicate the more hopeful line of advance. The chemical non-separability of isotopes, of which there is an accumulated mass of experimental evidence, seems to call for consequent adjustments in thermo-dynamic theory rather than the reverse.

The following considerations may throw light on the matter. I have stated (*NATURE*, June 24, p. 516) that, on the assumption of the chemical identity of the isotopes, the distribution given by probability considerations of the two kinds of atoms among the three kinds of molecules is

$$Cl_2 : Cl_2' : Cl.Cl' :: n^2 : (1-n)^2 : 2n(1-n) \quad (i)$$

where  $n$  and  $(1-n)$  are the fractional proportions of the  $Cl$  and  $Cl'$  atoms respectively. This leads to the equilibrium condition

$$[Cl_2][Cl_2'] = \frac{1}{4}[Cl.Cl']^2 \quad (ii)$$

Now if one applies in the conventional manner this result to the reversible reaction

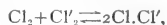

denoting by  $k_1$  and  $k_2$  the coefficients of velocity of the direct and the inverse reactions, one gets

$$k_1 n^2 (1-n)^2 = k_2 \{2n(1-n)\}^2$$

or

$$k_1 = 4k_2.$$

This, to say the least, is unexpected, because if coefficients of velocity of reaction have any physical significance at all, one would expect them to be the same for substances assumed to be chemically identical. The result is clearly due to a loose method of

choosing the concentrations, for if we re-write the reversible reaction



it transpires that we have chosen for the concentration of the resultants, because they are the same, the sum of their individual concentrations, although for the reactants, which also are chemically the same, the individual concentrations have been taken. It is clear that it is the individual concentrations in both cases that have to be taken, and therefore that one-half of the  $\text{Cl}_2\text{Cl}'$  concentration is involved. Then  $k_1 = k_2$ . So with any reaction of this type involving two molecules, apart from the question of isotopes altogether, the 4 that always appears in the conventional textbook examples is merely a consequence of a loose and physically unjustifiable mode of representing the concentrations. Writers of future text-books might ponder a little over this. If the same change in the choice of the concentrations is made in the thermodynamical argument, the difference of entropies,  $R \log_2 4$ , reduces apparently to  $R \log_2 1 = 0$ .

I have now made some progress in the application of probability considerations to the kinetics of the reaction. The distribution already given (i) has reference merely to the manner in which the two kinds of atoms will arrange themselves among the three kinds of molecules, assuming promiscuous combination between the two kinds, the two kinds being identical. But the particular distribution obtained does, I find, depend upon the kind of recombination assumed. As regards the dissociation of the molecules into atoms prior to their recombination, the matter appears straightforward, at least so far as I have got. Thus whether one supposes that in a certain time a certain fraction of collisions, the same on the average for each kind of molecular collision, is fruitful in dissociating the two molecules into four atoms, or one regards the dissociation as monomolecular, as presumably it would be if light were the dissociating agent, one arrives at the same result, that if  $x$ ,  $y$ , and  $z$  denote fractional proportions of  $\text{Cl}_2$ ,  $\text{Cl}'_2$  and  $\text{Cl}_2\text{Cl}'$  molecules respectively ( $x+y+z=1$ ), the relative rate of disappearance of each by dissociation is similarly denoted. By equating this rate of disappearance to the rate of formation for the three kinds of molecules, one gets the equilibrium distribution. The distribution given by (i) is got in this way, whether (1) all the atoms of the two kinds recombine promiscuously or (2) the four atoms formed in a single fruitful collision recombine again only among themselves. If a similar limitation be applied to a monomolecular dissociation, obviously the reaction cannot affect the distribution at all, which remains unchanged whatever the initial distribution. But I also found by inadvertently applying the law of promiscuous recombination separately to each of the nine cases that have to be taken into account on the collision view—since there are three types of molecules which may collide with any one of the three types—instead of to the sums of each of the two kinds of atoms produced, that a very extraordinary equilibrium distribution resulted, given by

$$\text{Cl}_2 : \text{Cl}'_2 : \text{Cl}_2\text{Cl}' :: \frac{1}{2}n(1+2n) : \frac{1}{2}(3-2n)(1-n) : \frac{1}{2}n(1-n),$$

which leads to the curious concentration equation

$$[\text{Cl}_2][\text{Cl}'_2] = \frac{1}{2} \{ [\text{Cl}_2\text{Cl}']^2 + [\text{Cl}_2\text{Cl}'] \}.$$

This in the case  $n=0.5$  happens to reduce to Mr. Chapman's relation (i) (NATURE, June 17, p. 487).

The case, of course, has no physical meaning, but it may serve to show that the equilibrium distribution is sensitive to the particular assumptions made as to

the type of reaction which occurs. I do not imagine I have exhausted the physical possibilities, but, so far as I can see, my distribution relation (i) covers the physically conceivable cases, and therefore the half, not the whole, concentration of the substance undergoing a bimolecular reaction with itself ought to enter into the equilibrium equation.

FREDERICK SODDY.

### Science in Medical Education.

THE discussion at the British Medical Association on July 1 on the place of preliminary science in the medical curriculum seemed to indicate practical unanimity on some points, such as the need for a higher minimum standard of general education, the raising of the minimum age for the registration of medical students to seventeen years, and the necessity for the maintenance of a high standard of instruction in physics, chemistry, and biology. There was no indication of the desire on the part of any one of the speakers to reduce the present standard of requirements in any one of these three fundamental sciences, and several suggestions were put forward for extending the courses of each of them into the later years of medical study.

Particularly welcome to many of the science teachers who were present were the remarks of Dr. Brackenbury, who insisted that a high standard of scientific education was just as necessary for the general practitioner as it is in the case of any specialist, and that consequently, in so far as the preliminary science courses are concerned, there should be no division of the courses into a higher and lower standard for different classes of medical students.

On the question of the relegation of the science courses to the school period of the student's education there were some minor points of difference of opinion, and there is need for further consideration of this matter and for the development of a common plan of action. If by raising the age of registration to seventeen years the school period is increased by an average of one year, there will be time for some school instruction in the fundamental sciences after the student has passed a matriculation examination without science, and there can be no doubt that if this time is profitably used, so that the student gains some knowledge of the elementary facts and principles of the sciences, the courses in the first year of study at the universities can be so modified in form as to bring home to the student much more forcibly than the courses do at present the relation of pure to applied science in medicine. The very prevalent idea that a great deal of time is wasted in the first year at the university in learning science that has no application to medicine arises entirely from the fact that the majority of the students come to the university so ignorant of elementary science and so untrained in scientific thought that the time of the university teachers is wasted in teaching the most elementary principles that could and should be taught at school. It seemed, however, to be the general opinion of those who were present at the meeting that the teaching of chemistry, physics, and biology should not cease at the end of the school period, but be extended into the first year of university study in a form which would be more general as regards principles, and more specialised as regards its application to the medical sciences. The suggestion made by Prof. Lorrain Smith and other speakers, that the teaching of science should be extended into the later years of the medical curriculum so that the links that bind the pure sciences to the medical sciences should be continuously presented to the medical student, does

not seem to me really practical unless the time required for a medical-qualification is increased.

The time-table of the later years of medical study is already so overcrowded, there is such urgent demand for more time for pathology, for instruction and practice in the wards, for the study of special medical subjects, and for some course of instruction in psychology, that it is difficult to see how any more lectures on pure science subjects can be squeezed in. It seems to me that the special need of medical education at the present time is a carefully thought out scheme of post-graduate studies, in which the teachers of chemistry, physics, and biology would take part, in all the large medical schools of the country.

Manchester.

SYDNEY J. HICKSON.

### The Mechanics of the Glacial Anticyclone Illustrated by Experiment.

In various publications issued during the past decade<sup>1</sup> the present writer has treated the peculiar air circulation which obtains above a continental glacier. A number of well-known writers, among them Sir John Murray and Buchan, had early pointed out that essentially anticyclonic conditions obtained over the Antarctic region as a region, but without reference to any connection with the continental glacier; while the late Admiral Peary was the first to note the dominance of centrifugal surface-currents over the Greenland continental glacier,<sup>2</sup> which important observation was the starting point of the writer's studies.

In all my writings upon the glacial anticyclone I have been at much pains to explain that the domed surface of the ice is essential to the development both of the anticyclone and of the alternating calms and blizzards which record its strophic action. In my "Characteristics of Existing Glaciers" it is stated (p. 149): "It is due to the peculiar shield-like form of this ice-mass that the heavier cooled bottom layer [of air] is able to slide off radially as would a film of oil from a model of similar form. The centrifugal nature of this motion tends to produce a vacuum above the central area of the ice-mass, and the air must be drawn down from the upper layers of the atmosphere in order to supply the void. It is here that is located the 'eye' of the anticyclone." Again (p. 266): "This anticyclonic circulation of the air is not determined in any sense by latitudes, but is the consequence of air refrigeration through contact with the elevated snow-ice dome, thus causing air to slide off in all directions along the steepest gradients."

In my monograph published in the Proceedings of the American Philosophical Society it is stated (p. 188): "It is because the inland-ice masses have a domed surface that they permit the air which is cooled by contact to flow outward centrifugally, and so develop at an ever-accelerating rate a vortex of exceptional strength."

It is, of course, fully realised that a domed surface is not the only one which theoretically might be conceived to produce such an anticyclone, but it is the only one of which we have examples in Nature bringing about such results. Any sort of pyramid would suffice; the essential thing is that the surface

<sup>1</sup> "The Ice Masses on and about the Antarctic Continent," *Zeitsch. f. Glaciologie*, vol. v., 1910, pp. 107-20. "Characteristics of the Inland-ice of the Arctic Regions," *Proc. Am. Philos. Soc.*, vol. xlix., 1910, pp. 95-109. "Characteristics of Existing Glaciers" (Macmillan, 1912), chaps. ix. and xvi. and Afterword. "The Pleistocene Glaciation of North America Viewed in the Light of our Knowledge of Existing Continental Glaciers," *Bull. Am. Geogr. Soc.*, vol. xliii., 1912, pp. 647-59. "Earth Features and their Meaning" (Macmillan, 1912), pp. 283-86. "The Ferrel Doctrine of Polar Calms and its Disproof in Recent Observations," *Proc. Second Pan-American Scientific Congress*, vol. ii., Sec. II., Washington, 1917, pp. 179-89.

<sup>2</sup> *Geographical Journal*, vol. xi., 1898, pp. 233-34.

should have its convexity upwards rather than downwards. Either over a concave surface or about a flat one the refrigerating engine cannot operate.

With the view of demonstrating the relation of the air circulation above a continental glacier to the ice-dome, I have prepared some simple devices for experimentation. In the first experiment water was used as the fluid medium to represent air in an apparatus (Fig. 1) which consists of a glass tank 12 in. by 6 in. by 6 in., containing at the bottom a copper vessel of semi-elliptical cross-section to represent a portion of the domed surface of the glacier. This copper vessel may be filled from below and quite independent of the tank itself. When used for the experiment the tank itself is filled with distilled water at room-temperature, rendered slightly alkaline by addition of sodium hydroxide. Phenolphthalein is then sprinkled over the surface of the water in the tank. It soon develops a dark-red cloudiness which remains near the surface. When ice-water is introduced into the copper dome the adjacent layer of water is cooled by contact and slides off to either side, thus drawing down the coloured water from the surface so as to simulate the vortex and the outflow of a glacial anticyclone. If Victoria green is used to

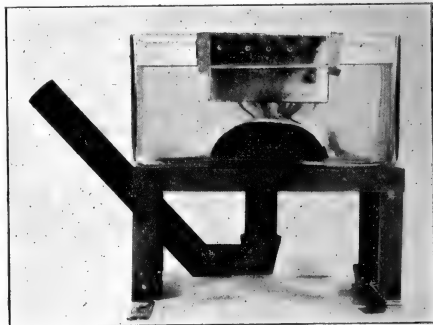

FIG. 1.—A glacial anticyclone simulated in water currents (with use of Victoria green as a colouring dye).

replace phenolphthalein as a dye, its crystals must be supported by a container having a bottom of fine-meshed screen, but in this case ordinary tap-water may be employed, since it is not necessary to render the water alkaline.

A similar experiment may be carried out using air as the circulating medium and smoke as the visible substance which betrays the currents. It is, however, less suited to photographic representation of the circulation, and the device only is therefore represented in Fig. 2. The device consists of a glass jar open at the top, such as is in common use for goldfish; within this jar is a metal dome to represent the domed surface of the glacier. This dome when filled with ice-water at once develops strong anticyclonic circulation of the air in the jar, and the circulation can be made visible if a burning cigarette is supported on a platform near the top of the jar and near its central axis. The jar is covered by a metal plate, the central portion of which is separate and attached to the funnel through which the ice-water is admitted to the dome and on the stem of which is the platform that supports the cigarette. The funnel may almost equally well be dispensed with, and the dome, already filled with ice-water, introduced into the jar with the hand.



We are here dealing with the constrained motions of falling bodies corresponding to those sliding on inclined planes all joined at their highest points. Such sliding motions are subject to the acceleration of gravity, and hence are slow in starting, but later attain high velocities. Since the falling body is air which is displacing warmer, and hence lighter, air-layers, in the case of the glacier its motions are further modified as a result of adiabatic changes, and, since large quantities of moisture are involved, by important transformations of sensible and latent heat. The source of this moisture is believed to be largely the ice-needles of the cirri.

The tendency to produce centrifugal surface-air circulation above the glacier (anticyclonic movement) is promoted by quiet conditions of the atmosphere, since the measure of contact cooling of the surface layer of air over the ice is a direct function of time. The halting of this circulation or the induction of any reverse centripetal movement of the surface air (cyclonic movement) is an inverse function of the time, since it is a direct function of the distance the air currents descend vertically during their outward



FIG. 2.—Device used to produce anticyclonic circulation in air above a cold dome.

movement. Each of these movements is, however, modified by the transformations of sensible and latent heats of fusion and evaporation of the water brought in in the form of the ice-needles of the cirri.

The beginning of the glacial blizzard, slow by reason of the flattish surface of the ice dome and the acceleration of gravity, is also retarded by the necessity of fusing and vaporising the ice-needles high up in the vortex of the forming anticyclone, which causes abstraction of heat and local displacements of air; whereas heat is evolved near the end of the blizzard, when fresh snow is precipitated near the glacier surface. Both these transformations of sensible and latent heat will operate so as to add their effect rather than to counteract that due to cooling or to adiabatic effect. They thus tend to cause blizzards to develop gradually and to end suddenly. The halt—the end of the stroke of the refrigerating glacial engine—comes about as soon as the rapid descent of the air carried out by the blizzard has, through its adiabatic effect, quite overcome the surface cooling due largely to the earlier calm. The length of the blizzard, if it

precipitates fresh snow, should therefore be adjusted in a measure to the expanse of the glacier surface over which the currents of air must slide before gaining the two miles of descent on the dome, in addition to that which takes place in the "eye" of the anticyclone.

WM. H. HOBBS.

Ann Arbor, Michigan, U.S.A., June 17.

### The Diamagnetism of Hydrogen.

THE fact quoted by Dr. Oxley in his letter to NATURE of July 8, that the diamagnetism of hydrogen becomes less as the temperature is raised, seems to be in favour of a kinetic hypothesis of the diamagnetism of that gas rather than against it.

If a magnet starting from rest is made to oscillate it remains paramagnetic until the oscillations on either side of the position of rest become  $130^\circ$ , after which it behaves as a diamagnetic body, the diamagnetism increasing until rotations begin. But once in rotation the diamagnetism diminishes as the rotational energy increases; and when this energy is very great the magnet is nearly indifferent to a magnetic field, and it appears to be non-magnetic. If it is allowable to treat temperature as a measure of this energy, then this result means that the diamagnetism should become less as the temperature is raised, and this is what has been observed.

Since the paramagnetism of a rotating magnet is found only for oscillations of less than  $130^\circ$ , the kinetic energy must be comparatively small, and in the case of hydrogen a change from diamagnetism to paramagnetism can be expected to take place only when the temperature is very near to the absolute zero.

Apart from the kinetic hypothesis, the fact that there is any change at all of the diamagnetism of hydrogen with temperature is opposed to the accepted view which regards true diamagnetism as independent of temperature.

J. R. ASHWORTH.

July 14.

### Occurrence of Ozone in the Atmosphere.

WITH reference to the lecture of Lord Rayleigh published in NATURE of July 8 on "The Blue Sky and the Optical Properties of Air," the conflicting results obtained by chemical methods in the estimation of atmospheric ozone are recalled. I beg to direct attention to my paper on "The Occurrence of Ozone in the Upper Atmosphere" (Proc. Roy. Soc., 1914, A, vol. xc., p. 204), in which it is shown that a reagent of potassium iodide solution can be made to provide a basis for the distinction of ozone and oxides of nitrogen at high dilutions and enable the approximate estimation of the former. By this method it is shown that, in accordance with the conclusions of Lord Rayleigh, ozone is present in the upper atmosphere, the amount present at an altitude of 10,000 ft. being of the order of  $5 \times 10^{-6}$  parts per unit volume. Measurements made with sounding-balloons up to altitudes of 20 km. also showed the presence of definite amounts of ozone, but no detectable increase between 4 km. and 20 km. The view was put forward that this amount of ozone must be taken into account in considering the optical properties of the sky.

An extension of these measurements was made with greater precision at the Mosso Laboratory on Monte Rosa at an altitude of 15,000 ft., where an average proportion of about  $1 \times 10^{-6}$  parts per volume of ozone was found.

J. N. PRING.

The Victoria University of Manchester,

July 14.

Crystal Structure.<sup>1</sup>

By PROF. W. L. BRAGG.

THE arrangement of the atoms in many of the simpler crystalline forms has now been determined by X-ray analysis. In 1912 Laue published his classical research on the diffraction of X-rays by crystals, and the investigations thus initiated have immensely increased our knowledge of the nature of X-rays, of crystal structure, and of the structure of the atom. Several methods of analysing crystal structure have been used. Laue passed a composite beam of X-rays, consisting of radiations of all wave-lengths over a continuous range, through a thin plate of crystal, and he recorded the diffracted beams by allowing them to fall on a photographic plate. The results he obtained were too complex to admit of ready interpretation, and a simpler method was realised in the X-ray spectrometer devised by W. H.

In potassium chloride each potassium atom is symmetrically surrounded by six chlorine atoms, each chlorine atom by six potassium atoms. The atoms cannot be displaced from their positions without destroying the symmetry of the crystal structure; they are therefore fixed by symmetry alone. Such a crystal is analysed very simply. We have only to choose between various alternative arrangements, each quite determinate, in seeking an explanation of the observed diffraction effects.

When the symmetry does not fix the exact positions of the atoms, the analysis is more difficult. In such cases atoms may occupy any position along some axis or in some plane of the crystal structure, and yet be in accord with the symmetry provided the other atoms of the same kind are

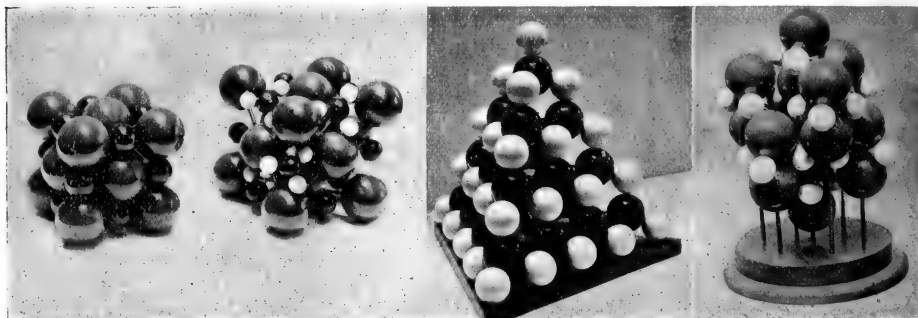

Potassium chloride, KCl.

Calcium carbonate, calcite, CaCO<sub>3</sub>.

Zinc sulphide, zincblende, ZnS.

Aluminium oxide, ruby, Al<sub>2</sub>O<sub>3</sub>.

FIG. 1.

Bragg, in which monochromatic X-rays are reflected from individual crystal faces. In the course of a series of experiments in which the author took part, the structures of a number of crystals such as rock-salt, the diamond, fluor, zincblende, pyrites, and calcite were determined. New fields were opened up by the method of analysis initiated by Debye and Scherrer, in which a beam of monochromatic X-rays is passed through a mass of finely powdered crystalline material, and the resulting "haloes" recorded photographically. Hull has extended this work to a number of substances unobtainable as large single crystals such as must be used in the X-ray spectrometer. By these methods a wide range of crystal forms has been surveyed.

Some crystalline structures possess symmetry of a high order, examples being potassium chloride and zincblende, models of which are shown in Fig. 1. In such cases as these every atom occupies a symmetrical position in the crystal struc-

ture. In the structure of the ruby, Al<sub>2</sub>O<sub>3</sub> (Fig. 1), the unit of which the structure is composed consists of a pair of aluminium atoms surrounded symmetrically by three oxygen atoms. The distance apart of the aluminium atoms along the axis joining their centres, and the distance of the oxygen atom from this axis, are both indeterminate in so far as the crystalline symmetry is concerned, and their exact values must be deduced by the X-ray analysis. It is these indeterminate parameters which make a crystalline structure complex.

The problem is simplified by regarding the atoms in a crystal as a set of spheres packed tightly together. This manner of regarding the structure was proposed in 1907 by Barlow and Pope, who assigned to the sphere representing an atom a volume proportional to its valency, and by packing these spheres together as closely as possible they obtained structures which accounted for crystal forms. We now know the structure of the crystals dealt with by Barlow and Pope,

<sup>1</sup> Discourse delivered at the Royal Institution on Friday, May 28.

and we know that it is in many cases not that predicted by the "valency volume" law. The law can be modified, however, so as to apply to the majority of crystals so far analysed. It may be shown that we can assign a definite diameter to the sphere representing the atom, a diameter characteristic of the element in question. Some atoms appear to occupy a small domain in a crystal structure, others a larger space. By finding the distances between the atomic centres in a number of crystals the diameters represented in Fig. 2 have been calculated. This figure summarises an empirical relation, which states that the distance between neighbouring atomic centres in a crystal structure is equal to the sum of two constants, characteristic of the atoms concerned. We can therefore picture the crystal structure as a set of spheres packed tightly together, just as Barlow and Pope did; but in this case the dimensions of the spheres are those in Fig. 2, not those given by the valency volume law.

arrangements, those of the inert gases, are those in which the outer shell has its full complement of electrons. Such forms are very stable; they are characterised by a weak external field. The chemical properties of the other elements represent their tendency to revert to a more stable electron system.

The crystal of potassium chloride, on this point of view, consists of alternate potassium and chlorine ions. The potassium atom is surrounded by nineteen electrons when electrically neutral. Eighteen of these electrons complete the three electron shells, represented, for instance, by the very stable arrangement of argon. The remaining electron has no place in the stable system, and there is therefore a tendency for the atom to part with it and become a positively charged potassium ion, the nucleus with nineteen elementary charges being surrounded by eighteen electrons. Chlorine similarly tends to gain an electron. The KCl structure may therefore be re-

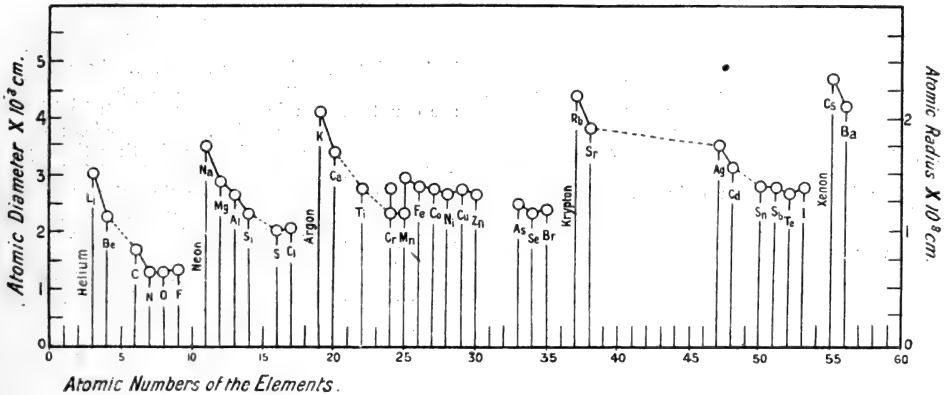

Fig. 2.

The atoms in a crystal are thus packed together as if they were inelastic spheres in contact. This is merely a way of visualising the structure, and must not be interpreted too literally. A ready explanation of the form of the graph in Fig. 2 is afforded by that conception of atomic structure which Stark, Born, Landé, Lewis, and others have helped to build up, and which has recently been so brilliantly summarised in a series of papers by Langmuir. Many independent lines of investigation have led to the conception of the atom as a positive nucleus surrounded by an electron system, in which the electrons are fixed at, or oscillate about, certain definite positions in the atomic structure. This is a view which forms a contrast to the Bohr atomic model, where the electron orbits enclose the atomic nucleus. In the "fixed electron" atom the electrons are arranged in a series of shells surrounding the nucleus, the numbers which complete the successive shells being 2, 8, 8, 18, 18, and 32. Certain

guarded as an assemblage of argon shells, with resultant positive and negative charges, which are held together by their charges, and kept apart by some force of repulsion which we must suppose to exist between the outer electron systems. The result is the structure in Fig. 1 where every ion is surrounded symmetrically by the greatest possible number—six—of ions of the opposite sign.

In the case of two electro-negative elements which are chemically combined, both atoms have a smaller number of electrons than corresponds to stability of the outer shell. Stability is attained by their holding pairs of electrons in common. In this way Langmuir has succeeded in the most striking manner in explaining the complicated valency of such elements as nitrogen and phosphorus.

The structure of calcite (Fig. 1) is an example of both types of chemical combination. The calcium atom, represented by the large sphere, is

an ion with a double positive charge, the  $\text{CO}_3$  group an ion with a double negative charge. These ions group themselves in the same way in the calcite and potassium chloride structures, as the models show, except that the form of the  $\text{CO}_3$  group distorts the cube into a rhombohedron. The electro-negative atoms of carbon and oxygen hold electrons in common, and form a closely knitted group, and from their distance apart we can form an estimate of the dimensions of the outer electron shell; it is the lower limit to which the diameters tend at the end of each period in Fig. 2.

In this an explanation is found of the large diameters assigned to the electro-positive elements, and the small diameters assigned to the electro-negative elements, in Fig. 2. The electro-positive atoms never share electrons with their neighbours; they are therefore isolated in the crystal structure, and appear to occupy a large domain. The electro-negative elements, bound together by common electrons, have to be represented by small spheres.

Comparing two crystals such as sodium fluoride and magnesium oxide, which have identical structures, we see that both may be represented by alternate electron groups of the Neon type. In the case of magnesium oxide the ions carry a charge twice as great as the sodium and fluorine ions, and the consequence is that the  $\text{MgO}$  structure, though identical in form with the  $\text{NaF}$  structure, has its dimensions reduced. The side of the elementary cube has a length of  $4.22 \times 10^{-8}$  cm. in the case of  $\text{MgO}$ , a length of  $4.78 \times 10^{-8}$  cm. in the case of  $\text{NaF}$ .

In diamond every carbon atom is surrounded symmetrically by four other carbon atoms arranged at the corners of a tetrahedron. The carbon atom has four electrons in its outer shell, and, in order to complete the number eight required for stability, it shares a pair of electrons with each neighbouring atom. The whole crystal is thus one continuous molecule, and the great hardness and density receive a simple explanation.

A crystal of an electro-positive element cannot be bound together by common electrons. Here we must suppose that the crystal consists of ions and electrons, the ions representing the stable electron systems, and the electrons being present in sufficient numbers to make the whole assemblage electrically neutral. From the fact that all crystals of electro-positive elements are conductors of electricity we deduce that the electrons have no fixed place in the system; they move under the influence of an electromotive force.

It has been possible only to indicate the manner in which crystal structure helps to elucidate the structure of the atom, and many generalisations have been made to which there are exceptions. It is hoped that this discussion will show the interest of the study of crystals. In a crystal there are countless atomic groupings oriented with perfect regularity. Individually their effect is too small to observe, but by illuminating the crystal with X-rays, the wave-length of which is much less than the distance separating the atoms, we can make use of their concerted effect on the rays to enable us to see into the intimate structure of matter.

## Researches on Growth of Plants.<sup>1</sup>

By SIR JAGADIS CHUNDER BOSE, F.R.S.

### II.

#### *The General Principle Determining Tropic Movements.*

THE movements in plants under the stimuli of the environment—the twining of tendrils, the effect of temperature variation, the action of light inducing movements sometimes towards and at other times away from the stimulus, the diametrically opposite responses of the shoot and the root to the same stimulus of gravity, the night and day positions of organs of plants—present such diversities that it must have appeared hopeless to endeavour to discover any fundamental reaction applicable in all cases. It has, therefore, been customary to assume different sensibilities especially evolved for the advantage of the plant. But teleological argument and the use of descriptive phrases, like positive and negative tropism, offer no real explanation of the phenomena. I propose to describe experimental results from which it will

be possible to discover an underlying law which determines the various tropic movements in plants.

*Direct Effect of Stimulus.*—In the motile pulvinus of *Mimosa* the excitation caused by stimulus causes a sudden diminution of turgor and contraction of the cells. With regard to this fall of turgor it is not definitely known whether excitation causes a sudden diminution in the osmotic strength of cell sap or increase in the permeability of the ectoplast. The state of excitation in a vegetable tissue may, however, be detected, as I have shown elsewhere, by the following indications: (1) diminution of turgor; (2) contraction and fall of leaf of *Mimosa*; (3) electromotive change of galvanometric negativity; (4) variation of electric resistance; and (5) retardation of the rate of growth.

#### *Continuity of Physiological Reaction in Growing and Non-growing Organs.*

In investigations on the effect of all modes of stimulation, mechanical, electrical, or radia-

<sup>1</sup> Continued from p. 617.

tional, I find that they check growth or bring about an "incipient" contraction; when the intensity of stimulus is increased, the effect culminates in an actual contraction—a result exactly parallel to the contraction of the pulvinus under direct stimulus. This would explain the similarity of tropic movements in pulvinate and growing organs.

**Indirect Effect of Stimulus.**—A novel result was discovered under indirect stimulation—that is to say, when the stimulus was applied at some distance from the responding area, i.e. the pulvinus or the growing region. This caused an increase of turgor, an expansion, an enhancement of the rate of growth, and an erectile movement of the leaf of *Mimosa*, and an electromotive variation of galvanometric positivity. This effect is specially exhibited in tissues which are semi-conductors of excitation.<sup>2</sup> The contrasted effects of direct and indirect stimulus are given in the following tabular statement:—

TABLE I.—*Direct and Indirect Effects of Stimulus.*

Direct	Indirect
Diminution of turgor, contraction.	Increase of turgor, expansion.
Fall of leaf of <i>Mimosa</i> .	Erection of the leaf.
Diminution of the rate of growth.	Enhancement of the rate of growth.
Galvanometric negativity.	Galvanometric positivity.

In Fig. 4 is given a record which shows in the same specimen (1) the acceleration of growth under indirect, and (2) a retardation of growth under direct, stimulation.



FIG. 4.—Effect of indirect and direct stimulation on growth: (†) shows application of indirect stimulus with consequent acceleration of growth; application of direct stimulus at (x) induces contraction and subsequent retardation of growth.

We thus arrive at the law of effects of direct and indirect stimulus:—

<sup>2</sup> "Plant Response," p. 524.

*Direct stimulus induces contraction; indirect stimulus causes the opposite effect of expansion.*

The same law applies when stimulus acts on

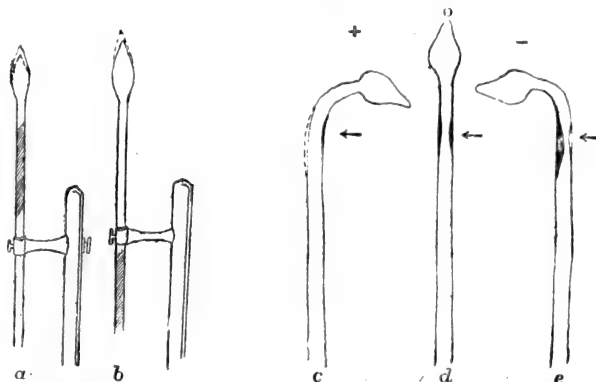

FIG. 5.—Effects of direct and indirect stimulus: a, Stimulus applied directly at the growing region inducing retardation of growth or contraction as represented by dotted line (stimulated area in this and in following represented as shaded); b, stimulus applied indirectly (at some distance from growing region) gives rise to acceleration of growth and expansion; c, stimulus applied at right side of organ causes contraction of that side and expansion of the opposite side, thus giving rise to positive curvature towards stimulus; d, excitation transmitted to the opposite side causes neutralisation; e, excitation caused by intense stimulation is transmitted across and thus reverses the normal curvature to negative, i.e. away from stimulus.

one side of the organ. When stimulus of any kind acts on the right side (Fig. 5c) the directly stimulated right side contracts, and the indirectly stimulated opposite, or left side, expands, the result being a *positive* tropic-curvature towards the stimulus. This explains the twining of tendrils and positive heliotropism.

**Negative Heliotropism.**—When the light is very strong and long continued, the over-excited plant-organs may begin to turn away. How is this effected? My experiments show that the strong excitation percolates into and traverses the organ and provokes contraction on the further side, thus neutralising their former bending (Fig. 5d). The organ now places itself at right angles to the light, and this particular reaction has been termed *dia-heliotropism*. In certain cases the transverse conductivity of the organ is considerable. The result of this is an enhanced excitation and contraction of the further side, while the contraction of the near side is reduced on account of fatigue caused by over-excitation. The organ thus bends away from light or exhibits so-called *negative heliotropism* (Fig. 5e). These effects are accentuated when one side of the organ is more excitable than the other. Thus under the continued action of light the response record shows first a movement towards light, then neutralisation, and finally a movement away from light. In this way a continuity of reaction is demonstrated proving that the assumption of specific positive and negative heliotropic sensibility is unjustified.

That the application of stimulus on the near

side of the organ induces at first an increase of turgor on the distal side and that this first effect may be neutralised and reversed by transverse conduction of excitation are seen strikingly exhibited in the accompanying record (Fig. 6), where a narrow beam of light was applied at a point of the stem diametrically opposite to the motile leaf which was to serve as the indicator of the induced variation of turgor under the unilateral action of light. That this indirect stimulation caused an enhancement of turgor of the opposite side was soon demonstrated by the erectile movement of the leaf. When the stimulus is moderate and of short duration, the response is only erectile or positive. But when the stimulation is continued the excitatory impulse is conducted to the distal side, giving rise to diminution of turgor, contraction, and the fall of the leaf.

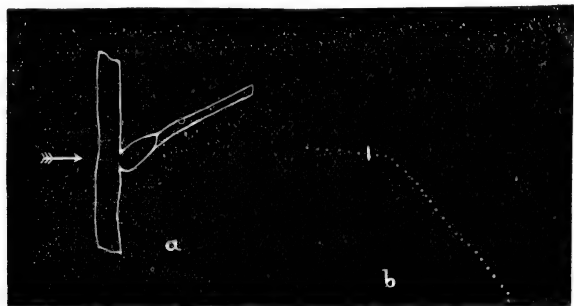

FIG. 6.—Increased turgor due to indirect stimulation inducing erection of Mimosa leaf: a, diagram of experiment; A, erectile response (shown by down-curve) followed by rapid fall (up-curve) due to transverse conduction of excitation.

TABLE II.—Showing Responsive Effects Common to Pulvini and Growing Organs under Unilateral Stimulation.

Effect of direct stimulation on proximal side	Effect of indirect stimulation on distal side
Diminution of turgor. Contraction and concavity.	Increase of turgor. Expansion and convexity.
Galvanometric negativity.	Galvanometric positivity.

When stimulus is strong or long-continued, the excitatory effect is conducted to the distal side, neutralising or reversing the first response.

Space does not allow my entering into the question of Nyctitropism, which will be found fully explained in the "Life Movements in Plants," vol. ii.

*Geotropism.*—No phenomenon of tropic response appears to be so inexplicable as the opposite effects of stimulus of gravity on the root and the shoot. As regards the mechanism of the up-curving of a horizontally laid shoot, it may be due

either to the expansion of the lower side or to an active contraction of the other. In order to decide the question I devised the method of geo-electric response whereby the state of excitation (which is attended by contraction) is independently detected by the induced electromotive change of galvanometric negativity. Displacement of the shoot from the vertical to the horizontal position is found to be immediately followed by the clearest electric indication that the upper is the excited side. The electrical response is found to increase as the sine of the angle of inclination. This excitation of the upper side involves its contraction and the resulting geotropic curvature upwards.

*Localisation of Geo-perceptive Layer by Means of the Electric Probe.*—The new investigation was carried out by means of my electric probe, which consists of an exceedingly fine platinum wire enclosed in a capillary glass tube, the probe being thus electrically insulated except at the extreme tip. When the probe, suitably connected with a galvanometer, is slowly thrust into the stem, so that it enters one side and comes out at the other, the galvanometer deflection shows by its indication the state of irritation of every layer of cells throughout the organ. When the stem is held in a vertical position the probe during its passage shows little or no electric sign of irritation. But when the stem is displaced from the vertical to the horizontal position, the geotropically sensitive layer now perceives the stimulus and becomes the focus of irritation, and the probe on reaching this point gives the maximum deflection of galvanometric negativity. This electric indication of irritation disappears as soon as the geotropic stimulus is removed by restoration of the stem to a vertical position. I was thus able to map out the contour lines of physiological excitation inside a living organ. The geo-perceptive layer was thus localised at the endodermis.

In geotropic response the only anomaly that remained was in regard to the response of the root being opposite to that of the shoot. Every cut portion of the growing region of the shoot responds to the stimulus of gravity by bending upwards. The growing region of the shoot is therefore both sensitive to stimulus and responsive to it. Hence geotropic stimulation of the shoot is direct. But this is not the case with the root; here it is the tip of the root which perceives the stimulus, the geotropic bending taking place at some distance from the tip. From the results of electric investigation I find that the root tip becomes directly stimulated, while the responding growing region some distance from it becomes indirectly stimulated. Hence geotropic stimulus acts indirectly in the responding region of the root. I have shown that the effects of direct and indirect stimulus on growth are antithetic; it

therefore follows that the responses of shoot and root to the direct and indirect stimulus must be of opposite signs.

The diverse movements of plants are thus explained from the establishment of the general law that direct stimulus induces a contraction and indirect stimulus an expansion.

I have shown, further, the extraordinary similarity of physiological reaction in the plant and animal (Friday evening discourse, Royal Institution, May 29, 1914). The responsive phenomena in plants must thus form an integral part of various problems relating to irritability of all living tissues, and without such study the investigation must in future remain incomplete.

### Popular Natural History.<sup>1</sup>

(1) **T**HE best popularisers, after all, are the masters—if they care to try; and Fabre's "Story Book of Science" is a fine illustration. It is very perfect—full of interesting material, vividly written, stimulating both observation and reflection. He tells of ants, aphides, long-lived plants and animals, procession caterpillars, bees, spiders, shells, cotton, paper, silk, clouds, thunder, rain, the sea, and more besides—all as if it were a pleasure to him to talk, and just the very easiest thing in the world. The book must have been fashioned long ago, but so wisely that there is little that requires changing; it was meant for the children of more than a generation ago, and it would be a joy of a reading-book in schools to-day; it was written in French, and it reads as if it had been composed in English. The translator, Mr. A. T. De Mattos, has done his work with great skill. We confess that we should not call Hemerobius a dragon-fly, and there must be something wrong in speaking of the "sharp bones" in the silk-moth's cornea, which Fabre described as a rasper for filing at the silk threads of the cocoon. But these are pin-pricks; the book is past praising, and its pages are very pleasant to read—pleasant both to the inner and the outer eye. We should be having a Fabre centenary soon.

(2) A translation of Fabre's "Story Book of Birds and Beasts" is very welcome. The subjects are for the most part familiar, but the handling of them is masterly in its simplicity, grip, and vividness. Fabre had a way of taking the reader into his confidence, and making a sort of partner of him in his observations. But it is a game that only a big man can play with success. We are introduced to the cock and the hen, the egg and the chicken, the duck and the goose and the pigeon, the cat and the dog, the sheep and the cow, the horse and the donkey, and we get inter-

ested in them as if they were novelties. It is high art. The stories should be used in schools.

The book is not without blemishes, of which we venture to give some samples. We do not know what to call the first part of a hen's stomach, but we are sure that it cannot be called "the succenturiate ventricle." The story of the making of the shell of the egg is misleading, and it is not true to say that the hen *must* have carbonate of lime in her food. We are rather staggered by some humming-birds "as small as our large wasps." The account given of "pigeon's milk" is erroneous. It should have been noted that the passenger pigeon, in regard to which Audubon's account is quoted, has now ceased to exist. For the translator's work we have great admiration; but it might have shown wisdom as well as piety to have got an editorial expert to look into points such as we have illustrated. There is no sense in perpetuating mistakes.

(3) Dr. Francis Ward's book is in great part an attempt to take the point of view of the animal under water.

Seen from below, the surface of the water would appear as an extensive mirror, with the river-bed reflected upon it. Immediately above the observer the reflecting surface is broken by a circular hole or "window." Through the surface of the water, in the area of this "window," the sky and objects immediately overhead have their usual appearance, but in addition surrounding objects above the water level are also seen through the "window" as dwarfed and distorted images, suspended, as it were, in the air above the circumference of the circular hole. A ring of iridescent colours separates the "window" from the surrounding reflecting surface.

Many of Dr. Ward's observations have a direct bearing on the concealment of aquatic animals, and deserve careful attention from naturalists. Let us illustrate. The size of the "window" varies with the depth of the under-water observer; when birds and fishes on the surface slip out of the "window" they cease to be conspicuous (to their enemies below) as silhouettes against the sky. Protection under water may be afforded, as in the case of brown trout, by reflection of the surrounding coloration. White animals, such as a white sea-anemone, take up a position where the revealing top light is cut off. Black-plumaged birds, like the water-hen, become mirrors under the water owing to reflection from the air-bubbles retained in their plumage.

After explaining the sub-aquatic conditions as

(1) "The Story Book of Science." By J. H. Fabre. Pp. 299. (London: Hodder and Stoughton, n.d.) Price 7s. 6d. net.

(2) "The Story Book of Birds and Beasts." By J. H. Fabre. Pp. 315. (London: Hodder and Stoughton, n.d.) Price 7s. 6d. net.

(3) "Animal Life under Water." By Dr. Francis Ward. Pp. x+178+plates. (London: Cassell and Co., Ltd., 1910.) Price 7s. 6d. net.

(4) "Birds in Town and Village." By W. H. Hudson. Pp. ix+274. Illustrated. (London and Toronto: J. M. Dent and Sons, Ltd.; New York: E. P. Dutton and Co., 1919.) Price 10s. 6d. net.

(5) "The Book of a Naturalist." By W. H. Hudson. Pp. viii+360. (London: Hodder and Stoughton, n.d.) Price 12s. net.

(6) "Wonders of Insect Life." Details of the Habits and Structure of Insects." Illustrated by the Camera and the Microscope. By J. H. Crabtree. Pp. viii+211+32 plates. (London: George Routledge and Sons, Ltd.; New York: E. P. Dutton and Co., n.d.) Price 6s. net.

(7) "Just Look! or, How the Children Studied Nature." By L. Beatrice Thompson. Pp. viii+204+38 plates. (London: Gay and Hancock, Ltd., n.d.) Price 5s. net.

regards illumination, the author discusses the life and behaviour of a number of types. In connection with diving birds, he suggests that the "flashes" of reflected light from the moving body may attract fishes. Under the water the back of the Great Northern Diver "simulates a shoal of small shining fish." The inordinate appetite of diving birds is emphasised; thus a small cormorant took from Dr. Ward at one time twenty-seven herrings of average size. It seems to us that the author does not sufficiently appreciate

We are not sure that a popular book, especially one with a definite and very interesting problem to discuss—animal life under water—is the place for weighing the beneficial and injurious effects of the activities of particular birds. That should be done in a severely scientific and critical way. Dr. Ward describes, for instance, the contents of the stomachs of thirty black-headed gulls, which show that these birds were "certainly not helping the farmer." But it is easy to get expert records of thirty cases which show the reverse.

The question is to which side the balance inclines in a particular area and through the year. This entertaining and breezy book is copiously illustrated with very interesting photographs. We appreciate these, but we may hint at the injudiciousness of putting even a diagrammatic penguin into a scene on a Highland loch.

(4) Mr. Hudson's "Birds in Town and Village" is based on "Birds in a Village" (1893), his first book about bird life, but much of it is new. It is a continual delight—a succession of fine pictures—and it is very gratifying that the beautiful text should be so successfully illustrated. Mr. E. J. Detmold's coloured drawings are altogether charming. The time is past for speaking of the author's style, his irresistible enthusiasm, his intimate knowledge of birds, and his passion for them. If more people read his books there would soon be no need for a Plumage (Prohibition) Bill.

"The robin is greatly distinguished in a sober-plumaged company by the vivid tint on his breast. He is like the autumn leaf that catches a ray of sunlight on its surface, and shines conspicuously among russet leaves." "The kingfisher, speeding like an arrow over a field of buttercups so close that they were touching, seemed, with the sunshine full on it, to be entirely of a shining, splendid green. . . . Flying so low above the flowery level that the swiftly vibrating wings must have touched the yellow petals, he was like a waif from

some far tropical land. The bird was tropical, but I doubt if there exists within the tropics anything to compare with a field of buttercups—such large and unbroken surfaces of the most brilliant colour in nature." But we might as well quote the whole book. The delightful "Birds of a Village," which forms about half the book, is echoed at the end in a story of the birds in a Cornish village, and between the two there are essays on exotic birds for Britain (we confess to regarding introductions with insular prejudice),

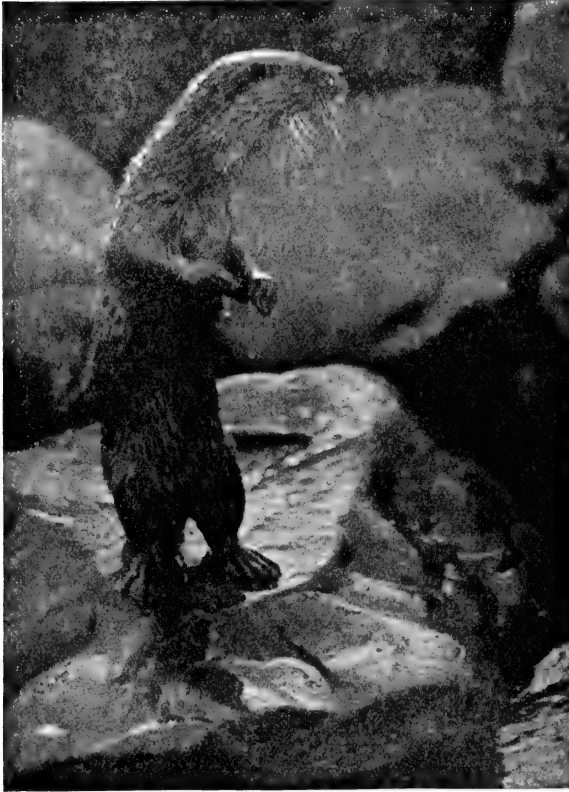

The otter alarmed. From "Animal Life under Water."

the good these birds do from the fisherman's point of view in destroying species which devour food-fishes. There are two sides to most indictments of birds.

In addition to the contributions to the theory of concealment of water animals from enemies or from booty, the book contains many very interesting natural history sketches—of the seal, the heron, the kingfisher, various kinds of gulls, and, best of all, the otter. Indeed, the story of the otter strikes us as the finest part of the book.



moorhens in Hyde Park, the eagle and the canary (concerning cages), chanticleer, and the birds of an old garden. If the birds knew what Mr. Hudson has done for them, they would sing all the year round.

(5) It is difficult to imagine anything more delightful than Mr. Hudson's "Book of a Naturalist," and we wish he had called it vol. i. Why should there not be many volumes, when it is so easy to make one so good? So easy! for all that is necessary is to have (1) an intimate personal experience and a deep understanding of the life and conversation of animals as they live in more or less wild Nature; (2) an artistic or poetic sense which gives Blake's "double vision"; and (3) an ear for words that makes the pages of the book sing. The same subjects are often treated of by many painters, and likewise by many naturalists. Ants and wasps, bats and foxes, moles and earthworms, snakes and toads, pigs and potatoes—these are fair samples of Mr. Hudson's stock in trade; but he is a magician-pedlar, and the familiar things among his wares turn out to have most unexpectedly profound and subtle excellences. Here science and art seem to meet in a deepening of our appreciation of common things, and perhaps this is the biggest service that a man who sees can do to his day and generation.

Mr. Hudson wished to call his book "Diversions of a Naturalist," but Sir Ray Lankester was ahead of him. We do not think he lost much, for what he has given us are really "Appreciations," as Sir Ray Lankester's "diversions" were also. The expert biologists get down to the depths of life in a way that is indispensable and fundamental, but the field-naturalists, among whom Mr. Hudson stands out as Saul among the prophets, get at the heights of life in a way that is indispensable and supreme. What is contributed in these fascinating essays is a wealth of first-hand observations, and to this, of course, there are added the reflections of a highly gifted intelligence. But we submit that there is more—that feeling has a rôle in the interpretation of Nature, and that sympathetic insight (through æsthetic emotion at one pole, and sheer sense of kinship at the other) opens up one of the rights-of-way to reality. This is too academic in its phrasing, and unfair to Mr. Hudson, through whose writings sunlight streams and breezes blow; but we mean that this is the book of an expert naturalist and of a man of feeling as well.

(6) The entomologist is always discovering new wonders, and very frequently he has enthusiasm enough to wish to share his pleasure with others. Mr. Crabtree has the entomological enthusiasm right enough, but we are not sure about all his wonders. In the first place he is too much of an anthropomorphist, for he says the study of insect-life "provides a host of examples and illustrations of such noble aims as 'living for a purpose,' 'striving for the best,' 'helping one another,' 'bearing each other's burdens,' and 'sympathy in sorrow.'" He has interesting observations to describe, and he tells his story

fairly well; but again there is the false note: he should not speak of his book selecting "representative members of the principal species," or of "the Pulex family." It is a pity that an author who seems to have seen a lot of things for himself should write like this: "The numerous family of Lice that is parasitic on certain animals is classed under the common term *Hæmotopinus*." Why do not publishers see to it, by utilising readily available advice, that this sort of thing is not printed? It is not good business, for it obscures the book's good qualities.

Many people see common insects like the lady-bird, the devil's coach-horse, the earwig, the frog-hopper, the green-fly, the may-fly, and the wasp, and would like to know more about them, especially if they can get the information not too learnedly expressed. Mr. Crabtree's book is well adapted to meet this reasonable demand. It deals pleasantly with about three dozen common insects, and there is a generous supply of photographic illustrations. But, again, Mr. Crabtree's reach too often exceeds his grasp; thus his story of cuckoo-spit is far from correct; we do not like to hear of female Aphides without ovaries, in which "multiplication occurs by the process of gemmation or budding on the individual Aphid." We are staggered by the crane-fly, the limbs of which are merely hooked together, so that a captured part has only to be hooked off; and we do not think that a wise approach to a very difficult problem is made by saying: "It may be said with sincerity that the development of *instinct* in ants is much akin to *reason* in higher mammals." But, forgiving a lapse in biological philosophy, we are pulled up by errors in grammar, for our eyes have fallen on more than one sentence like this: "To the thorax, or chest, is attached the fly's six limbs." Why should a scorpion be referred to as "the dangerous arachnid of the South American forests," and why should an author go out of his way to use an expression like "of that ilk" when he does not know what the words mean? We believe in popular natural history, but it should have a high standard of accuracy, and it should be written in English worthy of the subject. Mr. Crabtree's studies are interesting; they often describe observations; they are certainly instructive; but we are bound to say that there are too many flies in the ointment. And many of these flies are gratuitous.

(7) Miss Thompson tells in a pleasant way of corals and seeds, of the work of water and ice, of springs and seashore animals, and illustrates her talks with very clever drawings. To those who enjoy talks between a somewhat encyclopædic Miss Marshall and a number of children who ask extraordinarily appropriate and searching questions, the book will be welcome; our own impression, based on some experiments, is that neither children nor adults care for the "Sandford and Merton" mode of imparting instruction. The author has a very skilful pencil and a power of simple exposition; we wish she had chosen the direct method.

J. A. T.

## Notes.

MR. ALAN A. CAMPBELL SWINTON has been elected chairman of the council of the Royal Society of Arts for the ensuing year.

DR. EDRIDGE-GREEN, C.B.E., has been appointed a special examiner in colour vision and eyesight by the Board of Trade.

THE Civil List Pensions granted during the year ended March 31 are shown in a White Paper just issued, and include the following:—Mrs. Howell, in recognition of her late husband's eminent public service in the Geological Survey of Great Britain, 50*l.*; Miss Juliet Hepworth, in recognition of her late brother's services to meteorology and oceanography, 50*l.*; Mrs. K. Macdonald Goring, in recognition of her husband's services to biometrical science, 85*l.*; and Mrs. Leonard William King, in recognition of her husband's services to Assyrian and Babylonian study, 85*l.*

At a public meeting held at the Mansion House in October, 1912, the following proposals for commemorating the work of Lord Lister were adopted:—The placing of a memorial in Westminster Abbey, to take the form of a tablet with medallion and inscription; the erection of a monument in a public place in London; and the establishment of an International Lister Memorial Fund for the advancement of surgery, from which either grants in aid of researches bearing on surgery or awards in recognition of distinguished contributions to surgical science should be made, irrespective of nationality. A meeting of the general committee was held in the rooms of the Royal Society on Monday, July 19, to receive and adopt the report of the executive committee appointed in 1912. The chairman, Sir Archibald Geikie, stated that the sums received in respect of subscriptions from the British Empire and foreign countries amounted to 11,846*l.* 5*s.* 10*d.* A memorial tablet, executed by Sir Thomas Brock, was unveiled in Westminster Abbey on November 1, 1915, and steps are being taken for the erection of a monument in a public place in London. In order to carry out the scheme for the establishment of the International Lister Memorial Fund for the Advancement of Surgery, it was resolved that:—(a) Out of the general fund a sum of 500*l.*, together with a bronze medal, be awarded every three years, irrespective of nationality, in recognition of distinguished contributions to surgical science, the recipient being required to give an address in London under the auspices of the Royal College of Surgeons of England. (b) The award be made by a committee constituted of members nominated by the Royal Society, Royal College of Surgeons of England, Royal College of Surgeons in Ireland, University of Edinburgh, and University of Glasgow. (c) Any surplus income of the general fund, after providing for the erection of a monument and defraying administrative expenses, be either devoted to the furtherance of surgical science by means of grants or invested to increase the capital of the fund. The Royal College of Surgeons of England has consented

to become the trustees and administrators of the Lister Fund and to carry out its objects, subject to the above provisions of the scheme. The subscription list is still open, and the hon. treasurer of the fund is Sir Watson Cheyne, Bart., to whom donations may be addressed at the Royal Society, Burlington House, London, W.1.

A MARBLE statue to the memory of Wilbur Wright was unveiled on July 17 at Le Mans, where twelve years ago this aviator accomplished a flight of nearly a mile. We learn from the *Times* that the statue is the work of the sculptor Landowski, and typifies the struggle of man to conquer the air. The nude figure of a man is represented as having scaled a rugged mountain peak and as stretching out his arms to the hitherto unconquered element, air. The base of the monument is carved with bas-relief figures of Wilbur and Orville Wright and Léon Bollée, the Frenchman who collaborated in the early experiments.

THE thirty-ninth annual meeting of the Society of Chemical Industry was held at Newcastle-upon-Tyne on July 13–16. The gold medal of the society was presented to M. Paul Kestner, president of the Society of Chemical Industry of France, by Prof. Henry Louis, who read the presidential address of Mr. John Gray. Sir William J. Pope was elected president for the ensuing year. An invitation to hold the next annual general meeting at Montreal was accepted.

A CONGRESS of Philosophy, in which members of the Société Française de Philosophie are taking part, and to which the American Philosophical Association is sending delegates, is to take place at Oxford on September 24–27. Two of the subjects of discussion are likely to be of especial scientific interest: one a symposium on the principle of relativity, to be opened by Prof. Eddington, and the other a discussion to be opened by Dr. Head on disorders of symbolic thinking due to local lesions of the brain. The opening meeting of the congress will be presided over by Lord Haldane, and the inaugural address will be by Prof. Bergson. Arrangements are under the direction of Mr. A. H. Smith, New College, Oxford.

THE Faraday Society and the Physical Society of London are arranging to have a joint symposium and general discussion in October next upon the physics and chemistry of colloids and their bearing on industrial questions. The subject will be introduced by a brief survey of the present position of colloidal physics and chemistry, and there will then be discussion on the following subdivisions of the subject:—Emulsions and emulsification, physical properties of elastic gels, cataphoresis and electro-endosmose, precipitation in disperse systems, glass and pyrosols, and non-aqueous systems. In spite of the importance of colloidal physics and chemistry in many branches of manufacture, and of the interest which the subject has aroused in recent years, much light remains to be thrown on the nature of the manufacturing process in which colloids play a part. It is hoped that the discussion will focus attention on some of these problems, that its result will be to indicate lines of advance and suggest

further researches, and that it will be fruitful not only in helping to a fuller understanding of the laws of the colloidal state, but also in suggesting new applications for colloids in the laboratory and in the works. The exact date and place of meeting and further particulars will be announced later. In the meantime, anyone desirous of using the opportunity of the discussion to bring forward experimental matter or theoretical considerations bearing on the above-mentioned branches of the subject is asked to communicate as soon as possible with the secretary of the joint committee, Mr. F. S. Spiers, 10 Essex Street, London, W.C.2.

A SPECIAL meeting of the Röntgen Society was held on July 15 in the chemical theatre of University College, London, by kind permission of the authorities. The occasion was an address by Dr. W. D. Coolidge, director of the research laboratories of the General Electric Co., of Schenectady. An audience of more than 250 people gathered to hear from the inventor of the X-ray tube which bears his name a detailed account of the processes involved in the manufacture of the Coolidge tube—or rather we should say the Coolidge tubes, for a number of different types of tube, each suitable for different working conditions, are the outcome of the investigations carried out under Dr. Coolidge's direction over a number of years. Dr. Coolidge in his address laid considerable emphasis upon the amount of investigation entailed in the use of tungsten either as a hot filament or as the target of an X-ray tube. The welding of this highly brittle metal and its perfect annealing with copper are technical triumphs, and the details of these processes in their final stages were of very great interest. While the effort is at present being made by the General Electric Co. to standardise radiographic procedure by combining a high-tension outfit which automatically limits the quantity and quality of the X-rays from the tube, it is recognised that no such procedure is possible in radio-therapy at the present day. The limitations imposed upon the production of very short wave-length X-rays are largely technical ones, and we look with confidence to their production in the near future, for both in medical work and in the examination of metals and other materials they are likely to prove of great value. If the production of these more penetrating radiations involve new ideas in the construction of the X-ray tubes, those who heard Dr. Coolidge's address will feel that such considerations will not be allowed to delay what is becoming a seriously felt want.

In a paper read before the Royal Statistical Society in April (Journal, 1920, vol. lxxxiii., part 3, pp. 1-44), Dr. T. H. C. Stevenson presented the results of an inquiry into the fertility of the various social classes in England and Wales from the middle of the nineteenth century to 1911. Child mortality varies directly and very markedly with the number of children born and the rapidity with which they are born. It also varies with the age of the mother at birth. If allowance is made for the differences of marrying age in different classes, fertility is found to increase downwards throughout the social scale.

The difference in fertility between the classes is, broadly speaking, a new phenomenon, for it is small for marriages before 1861, and rapidly increases to a maximum for those of 1891-96. That the decline in the birth-rate is due to the artificial restraint of fertility is indicated by the following features: The gradual spread of the decline throughout society, from above downwards; the exceptionally low fertility of occupied mothers; and the increase in the defect for the higher social classes with increase of duration of marriage up to twenty-five years. The lowest fertility rates are returned for the most purely middle-class occupations—the professions. The comparatively low child mortality of the less fertile classes goes but a small way numerically to compensate for their low fertility. The classes which are least fertile when married are likewise those that marry latest in life. Ante-nuptial conception leads to great under-statement of the number of marriages of less than twelve months' duration. Such under-statement is the rule amongst all classes where the wife's marriage age is under twenty, and becomes less frequent as the wife's age increases. At ages above twenty its frequency varies with the social position, reaching its maximum amongst unskilled labourers.

PROF. E. W. MACBRIDE contributes to the latest number of *Scientia* (vol. xxviii., No. 99, 1920) a trenchant article on "The Method of Evolution." By the "force of heredity," he says, is meant the tendency of the offspring to resemble the parent. It is obvious that in some way this force must be modified as time progresses, otherwise evolution could not take place, and the manner and means of this modification are just what we mean by the phrase "method of evolution." The Darwinian view that large results may be reached by the selection of small individual variations is seriously weakened by "pure line" experiments. The mutationist view of the importance of "sport"-variations exhibiting Mendelian inheritance cannot be accepted as more than an accessory theory, for most mutations are of the nature of "cripples," and utterly unlike the differentiating characters which distinguish allied species. There remains a third alternative: the inheritance of the effects of use and disuse. This is the method of evolution, "the dominating influence which has moulded the animal world from simple beginnings into the great fabric of varied life which we see around us." If we ask for evidence of the transmission of somatic modifications, we are referred by Prof. MacBride to the researches of Kammerer. If we submit that opinion is divided as to the validity of these, we are told to repeat the experiments, which is, of course, a fair enough answer. In the meantime, we are invited to consider how bacteria, modified to perform feats in disruptive chemistry of which their ancestors were incapable, hand on their individually acquired new qualities to their abundant progeny. And if we suggest that this is not a test case, since bacteria have no soma and do not multiply by germ-cells, we are told that the distinction between somatoplasm and germplasm is a "Weismannian nightmare." All this points clearly to the need for fresh experiments.

PROF. STEPHENSON'S paper "On a Collection of Oligochaeta from the Lesser-known Parts of India and from Eastern Persia" (Memoirs Indian Museum, vol. vii.) is very informative. The known Oligochaeta, about 150 before 1883, were about 1000 species in 1911. To these Prof. Stephenson adds 24 species and 5 varieties, modestly remarking: "It can scarcely be said, however, that the results of the present investigation include anything of the first order of importance; it is now too late to expect it." One of the new species, *Nais gwaliorensis*, is about one-tenth of an inch long and one-hundredth of an inch broad, yet in an earlier paper the author shows this brevity far outdone by Annandale's *Chaetogaster spongillae*. Among very much larger forms the systematist may note that Prof. Stephenson here makes his *Eutyphoeus Kempi* a synonym of *Eutyphoeus chittagongianus*, Michaelsen, and that author's *bengalensis* a synonym of his species *Walloni* in the same genus. So lately as 1893 "absence of branchiae" was included in the definition of the Oligochaeta. Now, not only does *Branchiura Sowerbyi*, Beddard, have, as its generic name implies, gills on the tail end, but Prof. Stephenson also finds a species of *Branchiodrilus*, "a Naid worm with gills remarkably like those of *Branchiura*, but on the anterior part of the body."

THE twenty-eighth Report, for the year 1919, on the Lancashire Sea-Fisheries Laboratory contains a note by Mr. A. Scott upon a midwinter invasion of the Barrow Channel by an immense swarm of the phosphorescent flagellate *Noctiluca* and the Ctenophores *Pleurobrachia* and *Beroë*. On December 16, 1919, Mr. Scott made one of his routine visits to the sandy mud-flats between tide-marks, and found that the area—500 yards wide and 1000 yards long—between Roa Island and Foulney appeared as if it had been thickly sprinkled with glass marbles. These were the *Pleurobrachia*, many of them of large size (22 mm. high), and mingled with them were stranded *Beroë*. At the water's edge was a brick-red, oily-looking zone 6 in. to 12 in. wide, and the water in the creeks was covered by a similar oily layer, which on examination proved to be composed of *Noctiluca*. Twenty-four hours later the area was again examined, but only one *Pleurobrachia* was found, and there was no *Noctiluca* in the plankton. It is quite unusual to find an abundance of *Noctiluca* and Ctenophores in this area in midwinter. *Noctiluca* has been abundant on former occasions along the coasts of North Wales and Lancashire, but hitherto only in the period between the beginning of August and the end of September.

THE "Reports for the Year 1919 on the Science Museum and on the Geological Survey and the Museum of Practical Geology" (H.M. Stationery Office, 1920, price 3d.) are accompanied by a map showing the grouping of institutions devoted to education and research in the great quadrangle between Cromwell and Prince Consort Roads, South Kensington. The Science Museum has gone into temporary occupation of part of the eastern block of new buildings while this block is being completed, the galleries thus occupied being left in an unfinished state until a second move onward can be made. The arrange-

ment is a testimony to the energetic and necessary expansion of the collections, which now include an aeronautical division. The report on the Museum of Practical Geology refers to the congestion of its collections, which have been largely increased by the groups of materials of economic importance brought together in recent years. There is no reference, however, to any scheme of extended buildings. The publication of maps and memoirs has been maintained at a high level, and it is interesting to note how the public demand shows an enormous and intelligent preference for the "drift" series of colour-printed maps as against those showing the "solid" geology only.

THE Geological Survey of Scotland has issued the fourth of its series of memoirs dealing with the detailed economic geology of the central coalfield of Scotland, the present volume being devoted to Area VI., which forms a block near the centre of the field and includes the districts of Rutherglen, Hamilton, and Wishaw. This is naturally an area of very great economic importance, and comprises some of the most productive portions of the Scottish coalfield. A valuable feature of the publication is the series of sections obtained from borings and sinkings, which have been printed on separate sheets; it may perhaps be regretted that the scale selected is somewhat minute. It need scarcely be said that the geological relationships of the coal seams and of the various economic minerals met with in the field are described in full detail, and that the memoir, together with the revised maps which it is intended to accompany, will be of the greatest value to mining engineers whose professional work lies in that area of the Scottish coalfield.

A REPORT on the weather experienced at Falmouth Observatory has recently been issued by the Observatory Committee of the Royal Cornwall Polytechnic Society. The observatory is closely associated with the Meteorological Office, and many of the records for Falmouth appear in the several reports of the Office, which probably is sufficient reason for the small amount of work done actually at the observatory. Funds available at the spot are clearly limited, and the staff is, consequently, small. Pressure, temperature, and rainfall results in the report are compared with the means of the forty-five years 1871 to 1915, whilst in the Meteorological Office publications the records are compared with the new normals for thirty-five years, 1881 to 1915. Probably in course of time general uniformity in this respect will be adopted. The mean air temperature for November was a record for cold, and its minimum, 26° F., was the coldest for the year. The total rainfall for the first six months of the year was 5.89 in. greater than for the last six months, which is a reversal of the ordinary rule. October was a record for dryness, rainfall measuring 1.62 in. Bright sunshine had an average record for the year of 4.8 hours per day. October had 158.9 hours, which is a record for that month; the extreme range of the totals for October is 77.6 hours, not 69.2 hours, as stated in the report, for which result 1919 was overlooked. The table of sea temperatures from observations made in the harbour and the comparison with air temperatures is of considerable interest, but the differences from the air of the maxi-

imum and minimum sea values scarcely seem satisfactory, since the observations are not strictly for the same periods, the sea temperatures being for fewer days.

THE Seventh Report of the Industrial Fatigue Research Board (Textile Series, No. 1), dealing with "Individual Differences in Output in the Cotton Industry," has just been issued. It is the result of researches made by Mr. S. Wyatt, Investigator to the Board. The scope of the report represents an attempt to collect information on the question of the relative importance of the human and mechanical factors in various branches of the cotton industry. It is intended to be suggestive rather than conclusive in its nature, to lead on to a careful collection of facts and thence to more detailed and intensive investigations. There is great variety in the conditions obtaining in various types of cotton mills, some, for example, in which, as in the spinning of cotton, the output is almost entirely controlled by the machine, whereby individual differences in ability are reduced to a minimum; while in others, such as in the process of drawing-in by hand, there appears to be much more scope for the expression of individual differences of ability, and therefore of output, by the persons concerned. Thus it may be found possible, where there exist large individual differences of output—which implies that the mechanical factor is subsidiary—so to modify the human conditions of employment that increased efficiency, prosperity, and comfort may result. The inquiry has of necessity been of considerable difficulty, having regard to the variability of the conditions prevailing in the course of preparation and manufacture, yet valuable, if inconclusive, results have been reached, which at least show that the various processes in the cotton industry can be classified and graded according to the magnitude of the individual differences which they produce, wherein lies the relative importance of the human and mechanical forces. Scarcely any attempt has been made in the mills to determine efficiency in the various processes, yet the collection of statistical data would cause the employer and the manager to take a scientific interest in their work, stimulate inquiry and investigation, and lead to improved methods. We may reasonably ask why the workers should not be invited to participate in the research, since it is in their interests also that the best results should be secured.

THE International Institute of Agriculture at Rome has issued the following information with regard to the estimated yields of cereals throughout the world. In the United States the area under winter wheat is considerably smaller than that of last year. Moreover, the season has been somewhat unfavourable, so that the coming crop is estimated at 132 million tons, which is 66 per cent. of last year's yield and 86 per cent. of the five previous years' average. It is, however, probable that there are considerable stocks of old wheat still to be exported, and these, together with the reduced new crop, should make the exports for the coming season equal to those for the year ending June, 1920. Drought has considerably affected the crops in Algeria and in southern Italy, and the

outlook in Poland is unpromising, especially for rye. In the other countries of the northern hemisphere the condition of the winter cereal crops is normal, while the recent wheat crop in British India shows an increase of 30 per cent. over last year's yield. The maize crop in Argentina is estimated at 30,000,000 quarters, which is 32 per cent. higher than the five previous years' average. This increased yield will probably be an important factor among the cereal resources of the coming season.

THE Journal of the British Science Guild for June contains a special tribute to Lord Sydenham, the retiring president, contributed by Sir O'Moore Creagh. A series of six articles reviews the administrative activities of the Guild, of special interest being the account of the reception by Mr. A. J. Balfour of the deputation on State awards for scientific and medical discovery. The deputation had a sympathetic reception, the justice of the principle being generally conceded, but Mr. Balfour suggested as a difficulty the exact allocation of credit to the authors of scientific discoveries. This problem, it is pointed out by Sir Ronald Ross, has already been dealt with satisfactorily by the Royal Society, the Nobel Prize Committee, and other authorities. It is suggested that pensions and awards might be included in the Civil List. Lt.-Col. W. A. J. O'Meara writes with experience of the need for the utilisation of science in Government Departments. An element of consequence is the concentration of power in the hands of the higher division clerks and the permanent staff, which doubtless militates against the introduction of new ideas. Memoranda by the Health Committee on the milk question raise a number of important points in connection with the purity of supply and the possibility of the communication of diseases through milk. Sir Thomas H. J. C. Goodwin's Chadwick lectures on "Army Hygiene in the War and After" (see NATURE for June 24, p. 532) and Mr. J. J. Robinson's popular lecture on "Knowledge in National Reconstruction," delivered before 1100 members of the Portsmouth Brotherhood, are summarised. The issue is completed by a list of the officers, fellows, and members of the Guild.

THE Ministry of Transport has stated that it is seriously considering the organised electrification of the railways, and the importance of this subject at the present time can scarcely be over-estimated. Sir Philip Dawson's paper on "Electric Railway Contact Systems," which was read to the Institution of Electrical Engineers on June 30, is, therefore, of immediate interest. Before a standard system of electrification can be evolved the question of the relative merits of collecting the current from an overhead system or from a third rail must be discussed. From the data given in the paper a strong case can be made out for overhead collection. The flexible method of suspending the overhead collecting wire on the Brighton Railway has proved thoroughly satisfactory, and the "double insulation" used throughout has reduced breakdowns to a minimum. With third-rail systems it is necessary to pay higher wages to the workmen employed on the line owing to the increased danger. The data given bring out the interesting fact that

the wear of the trolley wire is proportional to the current collected. When no current is taken the wear is almost negligibly small. A curious anomaly in the treatment of railways with and without Parliamentary powers was pointed out. The former railways are not allowed to have more than a 7-volt drop on their rails, whilst the latter have sometimes more than a 100-volt drop for short periods. It seems to us that a careful search should be made in neighbouring pipes, etc., for electrolytic damage in the latter case. If the damage should prove to be inappreciable, then the limit of 7 volts might be raised for all railways, as this would appreciably lower the cost of electrification.

MESSRS. NEWTON AND WRIGHT, LTD., desire it to be known that their business will be carried on in future from their works address, 471-77 Hornsey Road, N.19, which is now the head office of the company. In furtherance of their policy of restricting themselves to a wholesale business, an arrangement has been concluded with Messrs. Allen and Hanburys, Ltd., by which this firm becomes selling agents in the London area for Messrs. Newton and Wright, and also in those parts of the United Kingdom where the latter is not specially represented. Messrs. Allen and Hanburys are taking over the electro-medical showroom at 72 Wigmore Street, W.1, until recently occupied by Messrs. Newton and Wright, who will, however, have free access to these showrooms, and one of their directors will always be glad to meet country and other customers by appointment who may not have time to visit the head office at Hornsey Road. The arrangements with Messrs. Allen and Hanburys are so framed as not to preclude Messrs. Newton and Wright doing business with other trade houses, and the firm will be pleased to continue supplying their specialities through whatever trade special a customer may select.

THE special catalogues of Messrs. J. Wheldon and Co., 38 Great Queen Street, W.C.2, are always of interest and value, and the latest (New Series, No. 90) is no exception. It is a well-edited, classified list of upwards of 1200 books and pamphlets on ornithology. The sections are British Islands, Europe, Asia, Africa, North America, Central and South America, Australasia, General Systems, etc., Economic Ornithology, Miscellaneous, and Morphology. Many scarce works are included. In addition, particulars are given of many complete sets or long runs of scientific journals. The catalogue should be of service to purchasers of books of science.

MESSRS. H. K. LEWIS AND CO., LTD., 136 Gower Street, W.C.1, have just circulated the quarterly catalogue of new books and new editions added to their Medical and Scientific Circulating Library during the months April-June. It is a useful classified list of the works in science published in the period named, and should be found useful even to non-subscribers to the library. Messrs. Lewis have also issued a list of second-hand and surplus library books on agriculture, botany, chemistry, engineering, geology, physics, zoology, etc. Many of the volumes are offered for sale at greatly reduced prices.

NO. 2647, VOL. 105]

### Our Astronomical Column.

A NEW COMET.—The second cometary discovery of the year was made at Nice by M. Schaumasse on July 18 at 13h. 37m. G.M.T., in R.A. 1h. 47m. 52s., south decl.  $19^{\circ} 14'$ , daily motion +2m. 24s., S. 5', 11th magnitude.

The following positions have been deduced on the assumption of uniform motion:

		R.A.		S. Decl.	
		h.	m. s.	°	'
July	23	1	59	1	39
	28	2	11	43	2 4

The comet is a morning star, rising at 1 a.m. summer time. It is not very far from Tempel's comet, discovered at Kyoto at the end of May, but of which no further observations have come to hand.

Later.—M. Schaumasse now finds that his new comet is identical with Tempel's second periodic comet, the previous announcement by Mr. Kudara, of Kyoto, being erroneous. The time of perihelion now becomes 1920 June 9.67, a month earlier than the time deduced from Mr. Kudara's announcement.

The following is an approximate ephemeris for Greenwich midnight:

		R.A.		S. Decl.		Log $r$		Log $\Delta$	
		h.	m. s.	°	'				
July	15	1	40	4	1 14	0.1402	9.9674		
	23	1	59	24	1 26	0.1488	9.9623		
	31	2	16	40	1 53	0.1585	9.9577		
Aug.	8	2	30	52	2 36	0.1693	9.9522		
	16	2	42	32	3 33	0.1805	9.9467		
	24	2	50	48	4 47	0.1920	9.9403		

PUBLICATIONS OF THE DOMINION ASTROPHYSICAL OBSERVATORY, VICTORIA, B.C., VOL. 1., NO. 1.—This volume contains a full account of the inception of the scheme of constructing the great 72-in. equatorial, and demonstrates the immense amount of careful thought and consultation of experts, both opticians and astronomers, that preceded the adoption of the designs.

Before the site was settled, Mr. W. E. Harper tested the quality of seeing at a number of stations in different parts of Canada, using a 4½-in. Cooke photographic telescope. Victoria was finally selected, owing to the excellent seeing at night, though there was less sunshine than at Ottawa; the small diurnal range of temperature also favoured it.

The glass discs were cast at St. Gobain, the optical work was entrusted to the J. A. Brashear Co., and the mechanical work and dome to the Warner and Swasey Co.

The ball-bearings, in dustproof cases, prove very efficient, so that it is stated that when the clock is disconnected a 3½-lb. weight on a 26-ft. arm suffices to set the telescope in motion; a 400-lb. weight is found sufficient for the driving clock, which is wound automatically by an electric motor. The volume contains details of the zonal tests applied to the mirror, the results being very satisfactory. Temperature insulation, consisting of cotton-felt, is used round the mirror, and with the small temperature changes that take place at Victoria the definition will never be appreciably affected by this cause.

The comfort and convenience of the observers are studied, all the movements being carried out electrically. Details are also given of the powerful spectrograph, which is surrounded by a temperature-case. It is possible to use the instrument visually without removing the spectrograph, the image being displaced laterally by reflecting prisms.

Numerous large-scale photographs of the various parts make it easy to follow the descriptions.

## Progress in Science and Pharmacy.<sup>1</sup>

By CHARLES ALEXANDER HILL.

**T**WENTY-FOUR years have passed since the British Pharmaceutical Conference met in this great city of Liverpool. On that occasion the late William Martindale in his presidential address dealt with the use in medicine of "active principles" in substitution of the natural, *i.e.* naturally occurring, drugs. At the same time he described the introduction of synthetic substances into medicine as a novelty.

To-day it is fitting to reflect upon the changes in pharmacy wrought by progress in science—progress in chemistry and biochemistry, in physics, in physiology, and in the science and practice of medicine; next, to examine the extent to which active principles and synthetics have replaced natural drugs; then tentatively to survey the lines upon which future development may be expected.

Of the changes that have occurred the increased use of synthetic drugs is the outstanding, though by no means the only, feature. It is noteworthy that important discoveries of new vegetable drugs are practically unknown. The animal kingdom, on the other hand, has furnished us with drugs of the first importance; of these the products of the pituitary body, the thyroid gland, and the suprarenal gland afford notable examples. The importance of these discoveries is in nowise diminished if the active principles have been synthesised and can be produced artificially.

The use of synthetic remedies in medicine is sometimes said to date from the introduction of antipyrin in 1884, but chloroform and chloral hydrate had long been known and used, and synthetic salicylic acid was freely used in 1877. Hypnone (acetophenone) followed in 1885 and antifebrin (acetanilide) in 1886. These were succeeded by phenacetin, sulphonal, and trional, and since then there has been a steady flow of new synthetic drugs.

To-day the world's annual consumption of phenazone or antipyrin may be roughly estimated at 100 tons, of phenacetin at 250 tons, and of medicinal salicylates (sodium salicylate, methyl salicylate, aspirin, and salol) at no less than 2500 tons, and these are a few only out of the multitude of pure chemical substances used in medicine.

Notwithstanding the remarkable extent to which synthetic drugs have come into use, and despite the increased employment of active principles according as our knowledge of these progresses, the use of the drugs themselves in the form of galenic preparations, whether "standardised" or not, continues to a remarkable, and perhaps significant, extent. Furthermore, as we shall see, signs are not wanting of a growing recognition of the truth that many a drug and many a food may contain valuable properties not readily determined by chemical methods. It may be only slowly that the full value of a drug discovered empirically can be stated in scientific terms. Paradoxical as it may seem, the tendency to-day, with advancing scientific knowledge, is to recognise the failure of the active principle to replace the parent drug.

When it happens, the replacement of a natural drug by a synthetic substance may be conceived as proceeding ideally in four stages. First, the drug is examined chemically, and from it is isolated a pure substance, frequently an alkaloid or a glucoside, which upon being subjected to physiological tests is found to have an effect similar to that of the parent drug;

<sup>1</sup> From the presidential address delivered at the Royal Institution, Liverpool, on July 20, at the fifty-seventh annual meeting of the British Pharmaceutical Conference.

such a substance is termed the "active principle" of the drug. The second stage is to determine the chemical constitution of the isolated active principle; this, in general, is a matter of extreme difficulty, taxing the resources of our most brilliant organic chemists, which, indeed, is equally true of the third stage, which consists in effecting the synthesis of the substance. Once the synthesis has been successfully accomplished we arrive at the fourth and last stage, which is the manufacture of the substance upon a commercial scale. The case of suprarenal gland and adrenalin affords an illustration.

It does not follow as a matter of course that if the synthesis of a substance be accomplished the artificial or synthetic article will replace the naturally occurring one. Supposing quinine were to be synthesised, it is by no means to be assumed that it would be cheaper to produce it on a large scale in the laboratory than to get Nature to conduct the synthesis, and then to extract the alkaloid from cinchona bark and afterwards purify it. It has been amply illustrated in the case of cinchona bark that it pays to subsidise Nature and to encourage her to increase her yield. Intensive culture may be a better business proposition than laboratory manufacture.

### Synthetic Drugs.

By far the larger number of chemical substances used in medicine are not the active principles of natural drugs. It would lead me beyond the confines of my address to attempt even a cursory survey of what has been accomplished in the limitless field of synthetic drugs, to the enormous consumption of which I have already made reference, or to make more than the barest mention of the fact that synthetic organic substances are employed as antiseptics, anaesthetics, narcotics, hypnotics, and antipyretics, and in the treatment of diseases, notably those of parasitic origin.

Nor need I remind you of the many attempts made by chemico-physiologists to correlate chemical constitution and physiological action. Much chemical and physiological work has been done in this fascinating field of research, and certain generalisations have resulted by deductive reasoning from very numerous data, yet it has to be admitted that really very little is known of this borderland subject. The physical condition of the substance, its solubility, especially its relative solubilities in different solvents ("partition coefficient"), its adsorptive power, osmotic properties, and other physical properties, have as much to do with its physiological action as has its constitutional formula.

It may indeed be that the purely chemical action of a drug is destined to play a subordinate rôle in therapy, and that, in the past, the physical action has not been sufficiently considered.

Chemotherapy shows us clearly that the physiological action of a substance is not due to one constituent only of that compound, but that it also depends largely upon the molecular orientation of the compound and the ratio of adsorption which exists between it and the protein colloidal particles through which this or that constituent is going to act. Consider arsenic, for example. In the treatment of disease plain liquor arsenicalis is not so effective as colloidal arsenic sulphide, nor is the latter so effective as arsenophenyglycine, nor the last so effective as diaminoarsenobenzene. They all contain arsenic, but the last, in virtue of its amino-groups, is able to be adsorbed in very large quantities by the protein colloidal particles; consequently, the greatest amount possible of the element gets taken up. So far as can be seen at present, the amino-groups are of great

importance in a chemotherapeutic compound, especially if they can be placed in the ortho-position to the element one wishes to incorporate.

Of greater importance than the group is the molecular orientation; one needs only to mention the effect of introducing an acetyl group to illustrate this point. Compare diorthaminothiobenzene with its acetyl derivative; the former is practically a specific for metallic poisoning, while the latter is as inert as plain colloidal or sublimed sulphur. Even diparaminothiobenzene cannot compare with the ortho-body. The addition of an acetyl group to salicylic acid results in a new analgesic property, while at the same time the undesirable after-effects of salicylates are in some measure eliminated. A similar addition to phenetidin gives us phenacetin with its valuable antipyretic properties. On the other hand, the addition of an acetyl group to parahydroxyphenylethylamine (an active principle of ergot) results in a loss of activity. The introduction of an acetyl group into the choline molecule converts this comparatively inert substance into a powerful heart poison. Highly interesting is the case of aconitine. This intensely poisonous alkaloid is the acetyl derivative of benzoconine, the latter substance being relatively non-toxic. Yet the introduction of further acetyl groups into the aconitine molecule does not increase, but diminishes, its toxicity.

#### *Recent Advances in Biochemistry.*

Theoretically, every ingredient of a drug or preparation must have some effect, though it may be so small as to be inappreciable by any known means; and some drugs and foods have constituents minute in quantity, and therefore long unknown, of the very highest degree of importance. Indeed, recent advances in biochemistry have proved the existence in drugs and foods of physiologically active substances which give a rational explanation of facts based upon experience and established empirically.

Fresh in the memories of all of us is the discovery of the cause and cure of beri-beri, constituting one of the romances of medical science. Beri-beri is a disease of a high mortality which ravaged tropical countries and caused much misery. It had long been connected in the minds of the investigators with the rice which formed the staple food of the populations affected by it, but it has only recently been discovered that the disease is caused by the refinements of rice-milling, brought about by the introduction of machinery. It was observed by Eijkmann, the medical officer to a prison in Java, that the poultry of their establishment suffered from symptoms remarkably like those of beri-beri, which was common in his gaol, where the inmates were fed on a rice diet. Investigations showed this observer that the fowls could be quickly cured by adding to their diet the pericarp and embryo of rice removed during the process of milling.

From this starting point there was established by research a complete correlation between the occurrence of beri-beri and the consumption of steam-milled rice. In districts where rice is polished by hand the disease does not frequently occur, because it rarely happens that the whole of the pericarp and embryo are removed by hand. Fowls fed on polished rice quickly suffered from polyneuritis, and birds almost at the point of death were quickly rescued, it was found, by the administration of a watery extract of rice polishings. Thus was beri-beri found to be caused by the absence from the diet of a substance soluble in water and present in rice polishings.

This water-soluble constituent belongs to a class of accessory food substances which have been somewhat unfortunately named "vitamines." Work on

these vitamins can scarcely be said to have a chemical basis, since all attempts to isolate them have failed. At least three have been recognised: (1) water-soluble B factor, which prevents beri-beri, occurs in the seeds of plants and the eggs of animals, in yeast and liver and grain cereals.

Scorbutus or scurvy is a disease which in former times caused high mortality. Sailors particularly were subject to attack, this being due to the fact that they were not obtaining another water-soluble vitamin, (2) the anti-scorbutic factor. The disease yields readily to a diet of potatoes, cabbages, and most fresh fruits.

Thirdly, there is a fat-soluble vitamin; this is present in cream and butter and beef-fat, and affords us a rational explanation of our natural preference for real butter over vegetable margarine. Cod-liver oil, which may be regarded as intermediate between foods and drugs, has long enjoyed a deservedly great reputation as possessing qualities superior to those of other oils. These qualities are due to the fact that good cod-liver oil has a high vitamin content, and is therefore important in the prevention and cure of rickets. On the other hand, vegetable oils, such as linseed, olive, cottonseed, coconut, and palm, contain only negligible amounts of this vitamin.

Biochemistry shows us the importance of other accessory substances besides vitamins. Enzyme action has been shown to be modified or stimulated by the presence of other substances termed co-enzymes. Parallel phenomena have been observed in the digestive processes of mammals in the remarkable activating nature of bodies termed hormones.

It would be beyond the limits of my address to go further than these somewhat brief indications that naturally occurring drugs and foods contain substances that long remained unsuspected and still longer unrevealed, but quite enough will have been said to show how unsafe it is to substitute one thing for another.

#### *Research.*

It is not easy to state concisely what is to be distinguished as pharmaceutical research. All will agree that it means something more than an improvement in processes for the exhibition of drugs in pharmaceutical preparations. Does it mean problems arising out of the cultivation of drugs not hitherto grown within the Empire, or the intensive cultivation of indigenous drugs with a view to increased activity, or the chemical investigation of drugs for their active constituents; or, again, does it mean research in organic chemistry for the production of new synthetic remedies, or does it mean pharmacological experiments, or all of these things? I would submit to you the following consideration: We have seen that pharmaceutical preparations of drugs continue to find employment even after the active principles of those drugs have been isolated, and are readily available in a pure state. We have seen that drugs and food-drugs are found to have valuable properties which cannot be stated in definite terms in the present state of our knowledge. Further than this, as our knowledge of such bodies as vitamins, enzymes, and hormones advances, so increases our respect for the natural source of such bodies—they may be glands or they may be seeds—whether as a food or as a remedial agent. Such may be the fate of many an "old-fashioned" remedy about which hard words have been used merely because it was not fully understood. Here then, it seems to me, is presented a most fitting subject for pharmaceutical research: to determine and control the conditions of collection and preparation of the parent drug, the process of treatment and manufacture and the conditions of storage, to dis-



cover characters and devise tests within the scope of the skilled, trained pharmaceutical chemist without involving experiments upon living animals, so that the pharmaceutical preparation exhibiting the drug shall be both active and uniform.

#### The Future.

The annual meeting of the British Pharmaceutical Conference affords a great opportunity for all pharmacists to meet each other on common ground and consider their common interests. Is not the present a period in pharmaceutical history at which it is fitting that all of us whose lot is cast in pharmacy should band together for our common welfare? The demands of the business side of pharmacy are to-day so imperious and so obvious that there is a danger of neglecting what, to my mind, is of primary importance if we are to persist. If I am asked what path should be pointed out for pharmacists to pursue in order that the present condition of affairs may be improved and the outlook for the future made more bright, then I say without doubt that the answer lies in cultivating assiduously the scientific side of pharmacy; in the promotion, encouragement, and assistance of pharmaceutical research; in the improvement of pharmaceutical products; and in keeping pharmacy abreast of advances in chemistry, physiology, bacteriology, vaccine-therapy, and other kindred subjects.

Only by giving first place to the professional side of pharmacy, keeping as distinct as possible the purely business side and declining to mix with pharmacy proper business in things so far removed from drugs as to be derogatory to the calling of pharmacy—only thus will it be possible to maintain and enhance the esteem in which pharmacists are held by their fellow-men, both medical men and laymen, as well as public bodies and Government Departments.

The British Pharmaceutical Conference exists for "the cultivation of pharmaceutical science" and "to maintain uncompromisingly the principle of purity in medicine." Let pharmacists see to it that the conference receive full and generous support, and that no effort be spared to enable it to carry out these worthy objects. Thus shall pharmacists prosper and pharmacy flourish.

### Medical Science and Education.

IN his wisely eloquent presidential address to the British Medical Association meeting at Cambridge Sir T. Clifford Allbutt struck many a nail on the head. He began with the claim that the universities, ancient and modern, from Alexandria to Edinburgh, have made the professions, and stated the university ambitions to be building up character, training in clear thinking, and imparting particular knowledge and experience. He confessed, however, that the new universities compare ill with the old in nourishing the imagination. There is need to learn how to teach; there is need for simplification by more blending of details into larger principles; and there is need to beware of letting our teaching stiffen into formulas. Another point, refreshingly illustrated, was the debt of other sciences to medicine, for what impulses have come from medical studies to cytology, to organic chemistry, to bacteriology, and so on, up to philosophy, as the address itself shows. In medical research, as elsewhere, natural observation is yielding more and more to artificial experiment as investigation penetrates from the more superficial to the deeper processes. "The progress of medicine must in large part be endogenous." "Mere observation—Nature's

march past—will not count for much now; and as to family histories—well, they vary with each historian." Once more Sir Clifford Allbutt made a plea for the study of the elements and phases of disease in animals and plants—a comparative pathology that would stir the imagination of young workers and save the world from a wastage as unnecessary as it is incalculable. "Yet no one stirs, save to gyrate each in his own little circle. There is no imagination, no organisation of research, no cross-light from school to school, no mutual enlightenment among investigators, no big outlook. . . . How blind we are!" After a very severe but timely criticism of psychotherapy—a criticism which is not marked, however, by any lack of appreciation of the fruitfulness of experimental psychology—Sir Clifford Allbutt closed with some discussion of the immediate problems of general practice and preventive medicine. There is inspiration in the whole address (see *British Medical Journal*, No. 3105, pp. 1-8), not least in its final glimpse of the possibilities before medicine as a social service and international bond.

At the same meeting of the British Medical Association there was an exceedingly important discussion on the place of "preliminary science" in the medical curriculum—a discussion which will lead, we hope, to some highly desirable changes. In his introductory address Sir George Newman indicated several reforms—a quantitative lightening of the curriculum at both ends, a fresh orientation of the preliminary sciences in relation to the training of medical students, but, above all, more biology and more real biology. "It is the biological outlook and spirit that is required, the capacity 'to see great truths that touch and handle little ones'; for biology, pure and applied, is the most educative, germinative, and dynamic subject in the whole curriculum." Prof. S. J. Hickson emphasised the value of biological studies in cultivating habits of verification and precision, in preparing the ground for subsequent anatomical and physiological studies, and in introducing the student to practically important sets of facts, either very concrete as in the case of parasites and their carriers, or more theoretical as in the case of heredity. He recommended a reduction in the number of "types" so as to make room for more important studies, better orientation of what is taught, and more emphasis on fundamental questions—admittedly difficult as it is to handle them well in teaching beginners. Prof. A. Keith urged that "anatomy could be made a living, practical part of medicine if only the teacher would ask himself: Could this fact help me in diagnosis and treatment?" Sir Ernest Rutherford, speaking of physics, insisted on the necessity for a sound training in the fundamental methods and principles of the science before the medical curriculum is begun, and for a subsequent professional course oriented in a judicious way to future studies in physiology and the like. Prof. Lorrain Smith laid emphasis on the fundamental value of the preliminary sciences as a training in method and criticism, but maintained that the general introduction at present supplied is wasteful in its discontinuity with what follows later. It misses part of its aim because its bearings on more professional studies are not made clear. Prof. A. Smithells, speaking of chemistry, indicated some ways in which more value could be got out of the present opportunities if there were more adjustment to the particular ends in view. In general, there seemed to be agreement (see *British Medical Journal*, No. 3105, pp. 8-21) on two points: (1) The need for making sure of a firmer grasp of principles, and (2) the need for a re-orientation of the class-teaching in relation to the particular needs of the medical student.

### First Conference of the International Federation of University Women.

THE International Federation of University Women held its first conference at Bedford College, London, on July 12-14, and it has been interesting to note how thoroughly the Federation deserves its name. If Great Britain and the United States were the most numerous represented, as they are the founder nations, there were plenty of other nationalities to meet them. France, Spain, Italy, Holland, Belgium, the Scandinavian countries, Czechoslovakia, India, and the Overseas Dominions of the British Empire had all sent their delegates to participate in the conference. The proceedings opened on the evening of July 12, when a large audience listened to speeches by Lord Grey of Fallodon, Prof. Caroline Spurgeon (Bedford College), Dean Virginia Gildersleeve (Barnard College, New York), and Prof. Winifred Cullis (the London School of Medicine for Women). Lord Grey emphasised the necessity for intercourse between the peoples of the world, and the women speakers outlined the means by which the International Federation intends to promote this necessary contact between the women of the universities of the world. Briefly, their aims are the establishment of travelling fellowships and international scholarships; the exchange of professors, lecturers, and students; the establishment of club-houses and other centres of international hospitality; and useful co-operation with the national bureaux of education in the various countries.

On the following days the foundations of the Federation were established. A constitution and by-laws were freely discussed and considerably amended before final adoption. The effect of these will be to establish a central office in London for general information, which will operate in connection with Committees on International Relations set up in each country which is a member of the Federation. Officers have been elected for the ensuing two years, the president being Prof. Spurgeon; the vice-president, Mrs. R. F. McWilliams, of Winnipeg; the treasurer, Mrs. Edgerton Parsons, of New York; and the secretary, Miss T. Bosanquet, assistant secretary to the Universities Bureau of the British Empire, 30 Russell Square, W.C.1.

Informal reports on the position of the higher education of women in the various countries represented were read, and steps will be taken to correlate the academic standards in the different universities.

The next meeting will be held in the summer of 1922. It is hoped that in the meantime each branch association of the Federation will work actively to further the aims of the Federation in its own country. The British Federation of University Women is losing no time in getting to work, and will initiate a campaign for the programme of the International Federation in the autumn.

### Insect Pests.

IN connection with tropical agriculture, attention has been directed to the question of the influence of the condition of the host-plant on infestation with sucking insects. It is believed that such pests as thrips on cacao and froghopper blight on sugar-cane can be held in check by increasing the resistance of the plant by improving agricultural conditions. In the *Agricultural News* (vol. xix., No. 464) it is claimed that the "mosquito blight" of tea (caused by a capsid bug of the genus *Helopeltis*) is affected in a similar

way, and that the condition of individual tea-bushes determines the susceptibility to attack. The distribution of mosquito blight appears to be connected with soil conditions, and analytical data indicate that soils on which the pest is prevalent show similarities in the potash-phosphoric acid ratio, the addition of potash having an appreciable, though irregular, action in reducing the blight. Water-logging tends to encourage infestation, probably because the vitality of bushes grown on such areas is lowered; draining is the remedy advised in such cases. Acidity and poverty of soil are other factors which vitiate the health of the tea-bushes, so rendering them more liable to attack.

The spread of prickly pear in Australia is so rapid that large areas of land will continue to be thrown out of cultivation year by year unless some effective measure of control can be devised. It is estimated that the pest claims for its own 1,000,000 acres of fresh land per annum. Various methods of eradication have been tried, but destruction by mechanical or chemical means has proved too expensive for use on a large scale. The pear cannot be fed off to stock, and the manufacture of potash and paper from it has not proved to be commercially successful. A fourth line of attack—destruction by natural enemies—is now being followed up (*Science and Industry*, vol. ii., No. 1). It is necessary to find some enemies of the prickly pear that will not attack other vegetation, as the introduction of "omnivorous vegetarians" would probably result in serious injury to other forms of plant-life. For this reason certain rodents, snails, and insects which are known to feed on prickly pear in America and Africa cannot be recommended for introduction into Australia. One insect, however, *Coccus indicus*, appears to feed exclusively on one form of pear, *Opuntia monacantha*, but unfortunately it will not feed upon the chief pest, *O. inermis*. It is recommended that experiments should be carried on to induce the insects to transfer their attention from one species to the other, if necessary by means of hybridising the pears. Other insects—bugs, flies, moths, and beetles—are known to feed upon one or other species of prickly pear, and it is possible that useful enemies might be introduced from Mexico and South America.

The loss caused by the jointworm flies of the genus *Harmolita* (*Isosoma*) in the United States runs into millions of dollars per annum, the wheat jointworm (*H. tritici*) being the greatest devastator. W. J. Phillips (Bull. 808, Professional Paper, U.S.A. Dept. Agric.) has gathered together the available information and classified the species into groups that attack grain crops, cultivated grasses, and wild grasses. The two first groups cause considerable loss by the injury they entail to the crops. The members of the last group, however, may possibly be beneficial in an economic sense, as they provide intermediate hosts for the parasitic insects which prey upon the genus, the more important parasites being common to the majority of species of *Harmolita*. The life-histories of several species are described, together with the way in which injury is caused to the plants attacked. *H. tritici* causes the most serious losses, reducing the yield of wheat by as much as 50 per cent., the grains being somewhat small and shrivelled. *H. grandis* is also confined to wheat, and produces two generations in the year, but as it is easily controlled its powers of destruction can be kept in check. Breeding experiments indicate that each species is probably confined to a single host, as it has proved impossible to induce the more important forms to attack other crops than that with which they are normally associated. The jointworms are much subject to parasitic attacks, and for this reason do not often get quite

out of hand and destroy an entire crop; but, even so, they exact a toll of from 1 to 5 bushels per acre unless control measures are adopted. Experiments seem to show that ploughing under the stubble is the most effective remedy, as wholesale destruction of the insects is thus brought about. It would be necessary to arrange the crop rotation so as to allow the wheat-stubble to be ploughed up, but if this could be done it is estimated that millions of dollars could be saved yearly.

Parasites such as lice and mites cause considerable loss in the poultry industry by reducing egg-production and injuring the quantity and quality of the flesh of the birds. A cheap but effective remedy is therefore much to be desired, and it is now claimed by F. C. Bishop and H. P. Wood (Farmers' Bulletin 801, U.S.A. Dept. Agric.) that sodium fluoride fulfils these conditions, and that, if properly used, one application will completely destroy all the lice present on any bird. The treatment can be carried out by dusting or by dipping. In the former case pinches of the fluoride are placed among the feathers close to the skin on the parts most frequently attacked; dusting with a shaker is less effective, and also causes more irritation to the nose and throat of the operator. In the latter case  $\frac{1}{2}$ -1 oz. of commercial sodium fluoride is dissolved in a gallon of tepid water, and the birds are then dipped for a few seconds. The lice die more rapidly in this case than when the dry powder is used. It is estimated that the cost of treatment works out to about one farthing per bird, 1 lb. of sodium fluoride sufficing for about a hundred hens.

### Investigations of the Upper Air.<sup>1</sup>

THE interesting publications referred to below deal with the investigation of the upper air, the first two being written in German. Dr. Everdingen, in Holland, has experienced the same difficulty that has occurred in England and elsewhere in carrying on the investigation owing to the scarcity and badness of the necessary materials, on account of which the mean height of the kite and captive-balloon ascents, when compared with that of previous years, was reduced considerably. The two years' reports contain full particulars of each ascent made; they are noteworthy as showing the increasing importance of aeroplanes compared with the old method of kites as a means of observation.

The third publication, Geophysical Memoirs, No. 14, gives an account of the pilot-balloon ascents made in November and December, 1911, by Capt. Cave and Mr. J. S. Dines in the Scilly Isles. Plenty of information about the relation of the wind to the surface-pressure gradient up to a few kilometres height over land is available, but similar information about the wind over the sea is very scarce. The expedition to the Scilly Isles was planned and carried out by Capt. Cave expressly to meet this want, and the results, which contain a large and useful amount of information, have at last been published.

The islands are noted for their fine formation of rock, and they are exposed to the full force of the Atlantic gales; in no part does the surface rise much above the sea-level, and the whole land area is small, thus the influence of the land on the air-currents must also be small. Moreover, except to the south-west, readings of the barometer are available, and hence the isobars on the daily weather charts can be

drawn in the neighbourhood of the islands with fair precision.

The balloons were mostly followed by two theodolites at the ends of a base line of 5260 metres, but on a few occasions, on account of the difficulty of reaching the distant station, only one was used. The period covered was from November 22 to December 8. The weather was mostly rough and stormy with a prevalence of clouds, so that the balloons could seldom be followed to any great height, but the conditions were very favourable for the purpose of the observations. The authors found, as they expected, that the effect of surface-friction is far less at St. Mary's than inland, and they give the loss of velocity at the anemometer head at Scilly as 20 per cent., against 35 to 50 per cent. at Ditcham Park.

The question of the rate of ascent of pilot balloons is considered. The same kind of balloon was used as at Ditcham Park and the same free lift given. The mean rate of ascent was 160.6 metres per minute. It has been found inland that balloons show a tendency to rise faster in the first half kilometre, but this was not the case at Scilly. The rate of ascent varied considerably from minute to minute, but no systematic difference was found, and hence the authors conclude that the general results obtained from single theodolites may be looked upon as quite trustworthy.

The last section deals with the type and height of the clouds prevalent during each ascent, and some evidence was found of the motion of the upper clouds away from the centre of the depression which dominated the weather at the time.

The whole memoir is very interesting and should be read by every student of meteorology.

### Bionomics of *Glossina palpalis*.

NO. XVII, of the Reports of the Sleeping Sickness Commission of the Royal Society (H.M. Stationery Office, price 4s. net), which has recently been issued, includes the third, fourth, and fifth reports on the bionomics of *Glossina palpalis* on Lake Victoria by Dr. G. D. Hale Carpenter, of the Uganda Medical Service.

Interesting descriptions are given of the natural features and of the fauna and flora of the thirty-six islands visited. These should be consulted in the original by those interested. From a study of the conditions prevailing in these islands it was deduced that the conditions for the prevalence of fly above the average are (1) suitable breeding-grounds, viz. dry sand or gravel ridges representing old lake-shore levels; (2) abundant shade combined with open spaces to permit of the movements of the fly; and (3) absence of large spiders (*Nephila*).

The characters of a suitable breeding-ground are the following: (1) Loose soil, (2) dry soil, (3) well-ventilated soil, (4) adequate shade, and (5) within 20-30 yards of water. Further research will probably enable us to define these conditions still more precisely and to decide whether they, as one would expect, are also the optimum for the development of pupæ.

The practical suggestion is made that fly may be controlled by constructing artificial shelters with the characters above defined which would be attractive to the fly as breeding-grounds, and where the pupæ would be regularly collected and destroyed. It might be possible to add some chemical to the soil in these shelters which would obviate the necessity of collection and destruction. The author has established the fact that flies pupate in these shelters.

<sup>1</sup> "Koninklijk Nederlandsch Meteorologisch Instituut," No. 106.  
"Ergebnisse Aerologischer Beobachtungen," parts v. (1916) and vi. (1917).  
Air Ministry, Meteorological Office, Geophysical Memoirs, No. 14:  
"Soundings with Pilot-balloons in the Isles of Scilly."

The report is an example of the value of the methodical collection of data. Whether the destruction or control of *Glossina*, which seemed at first sight an almost hopeless quest, can be achieved by this method we shall no doubt soon learn.

J. W. W. S.

### Dante and Trepidation.

IN a note entitled "La Trepidation in Dante?" (*Atti della R. Accad. di Torino*, vol. lii., p. 353) Signor O. Z. Bianco discusses the novel interpretation given by Duhem ("Le Système du monde," t. iv., chap. x.) of a well-known passage in the "Paradiso" (xxvii., 142-48):

But ere that January pass to spring  
Through that small hundredth men neglect below,  
These higher spheres, shall with loud bellowings ring;  
The tempest fierce, that seemed to move so slow,  
Shall whirl the poops where now the prows we see,  
So that the fleet shall on its right course go;  
And following on the flower, the true fruit be.  
(Plumpton's translation.)

The first two lines clearly allude to the difference between the Julian year and the true value of the tropical year, which Dante assumed equal to 1/100 day, the neglect of which was gradually making the spring equinox occur earlier, and would (if the error were not corrected) eventually make the spring begin in January. Duhem suggested that the second half of the passage alludes to the so-called trepidation of the equinoxes. According to the theory formulated by Tābit ben Korra in the ninth century, the equinoxes do not move uniformly from east to west, but alternately advance and recede in a period of more than four thousand years. This imaginary phenomenon is not alluded to by Al Fargani, from whose text-book Dante seems to have derived his astronomical knowledge. Signor Bianco rejects Duhem's suggestion, which is at variance with what Dante says elsewhere ("Convito," ii., 6; "Purgat.," xi., 108) about the slow motion of  $\tau^p$  in a hundred years. It is surely much more natural to suppose that the poet simply meant that long before the spring equinox after some thousands of years had moved back into January, great upheavals would take place in Italy.

### Japanese Botanical Work.

THE Journal of the College of Science of the Imperial University of Tokyo, vol. xliii., contains (article 1) an admirably illustrated monograph (in English) of the genus of brown seaweeds, *Alaria*, by Prof. K. Yendo. The author has studied the various species on the west coast of Vancouver Island, along the coast of the Kurile Islands and of Kamtschatka as well as in Japan, and also the material in some of the important European herbaria. The descriptive portion is preceded by a general account of the morphology, structure, and development. The vexed question of the cryptostomata in the brown seaweeds is discussed at some length, and the author concludes that these tufts of hairs, at any rate in the *Laminarias*, may be regarded as absorptive organs. A *résumé* is also given of the differing views held as to the life-history, especially as to evidence on the manner of renewal of the blades, of *Alaria*, which, the author considers, "may be either gradual or sudden, according to the conditions of the place where the plant grows." As regards the economic uses of *Alaria*, though *A. esculenta* was extensively used for food in earlier times in North-West Europe, and this and other species are still eaten in various sub-Arctic

areas, the author concludes that the genus has very little value as human food or for kelp-ash. For manure it may be used equally well with other brown seaweeds. The species inhabit the colder northern seas, the greatest number being found within a range from about 42° N. up to the Arctic Circle. Fifteen species are recognised. Of these full descriptions are given, variations in form and synonymy are discussed, and a list of localities is cited. The form and structure of the species are illustrated in nineteen excellent double-page plates.

The same volume contains a short paper (article 2) by T. Matsushima describing investigations on the transpiration of cut branches, and an ecological study (article 3) by Y. Yoshii of the Ota dunes—both in German.

In the "Icones Plantarum Formosanarum," vol. viii., Bunzo Hayata continues his descriptive work on the flora of the Island of Formosa, based on the study of the collections of the Botanical Survey of the Government of Formosa. The present volume contains descriptions of species and varieties of flowering plants in various families, and of ferns; 111 new species and 17 varieties are included. The total number of species of the flora is brought up to 3458, contained in 1174 genera representing 169 families. The genus *Citrus* (orange, lemon, etc.) is treated at some length, as also are the figs, *Ficus*, of which the author recognises 29 species in Formosa. In addition to eighty-eight text-figures, the species are illustrated by fifteen excellent full-page plates showing habit and floral dissections.

### Researches on Egyptian Cotton.

THE newly appointed Cotton Research Board for Egypt has issued a Preliminary Report, in which a sketch is given of the general significance of the Egyptian cotton crop and the formation and proposed operations of the new Board are described. Plans of the buildings under construction are shown, and a few illuminating figures serve to bring home to the reader the immense volume of detailed information required in the modern study of crops. An outline of the field of work to be undertaken by a staff of eleven non-Egyptian scientific workers and twenty Egyptians is given for the botanical, entomological, chemical, and physical sides, though the Board is rightly careful not to bind itself to a definite programme.

Those interested in cotton or in Egypt cannot fail to be very glad that this Board has at last come into existence, but the matter is of wider interest in that a move has here been made towards the separation of administration from research. Both functions have been hampered in the past history of many agricultural services by mutual confusion, and we anticipate that the step taken by Egypt in this matter will be generally adopted.

The only criticism we would offer on this report is upon the reason given for the establishment of the Board, to wit: "Past experience of . . . the disadvantages attaching to the investigation of cotton problems from the point of view of any one branch of science." We would rather have judged that Egyptian cotton had been singularly fortunate in the informal and voluntary co-operation of every branch of science, the schools of medicine and engineering, and the departments of survey and geology, as well as the agricultural organisations, having given invaluable help in all directions. We would suggest that past experience showed rather the need for a body (such as this Cotton Research Board) which would

cut across departmental boundaries, and give official status and help to the scientific co-operation already in existence. It is to be hoped that the Board may ultimately see its way so to extend its ranks as to effect *liaison* with bodies outside the official Egyptian Service.

W. LAWRENCE BALLS.

## University and Educational Intelligence.

**CAMBRIDGE.**—Applications are invited for the George Henry Lewes studentship in physiology, value 245*l*. Candidates must send their applications, with particulars of their qualifications and the subject of their proposed research, by July 31 to Prof. Langley at the Physiology School.

A further gift of 600*l*. has been received from Mr. and Mrs. P. A. Molteno to meet the increased cost of labour and material in the building of the Molteno Institute of Parasitology. This avoids the need to reduce the accommodation originally proposed.

Mr. R. H. Vernon, Gonville and Caius College, has been appointed assistant to the professor of chemistry.

Honorary degrees are being conferred on the Spanish Ambassador, the President of Harvard University, Prof. H. Cushing, and Prof. J. J. Abel.

**GLASGOW.**—The following were among the degrees conferred on July 19:—

- Doctor of Medicine (M.D.)*:  
(i) With Commendation: James Gordon Wilson—thesis, "A History of Influenza and its Variations."  
(ii) Ordinary Degrees: Albert Barnes Hughes—thesis, "Puerperal Eclampsia"; Donald MacKenzie MacRae—thesis, "The Bechuanaaland Protectorate: Its People and Prevalent Diseases, with a special consideration of the effects of tropical residence and food in relation to health and disease"; and John Young—thesis, "Bacillary Dysentery."

**LONDON.**—Mr. Fisher, President of the Board of Education, has stated, in reply to a question asked in the House of Commons relating to the offer of the Bloomsbury site to the University of London, that when the time comes for King's College to move from the Strand to Bloomsbury, the Government is prepared to seek authority to purchase, at a fair valuation, the buildings at present occupied by King's College in the Strand, and the price so paid will be available towards the cost of the new buildings to be erected for King's College on the new site.

**SHEFFIELD.**—Dr. R. B. Wheeler has been appointed to the recently established chair in fuel technology, and Mr. Douglas Knoop to that of economics.

SIR JESSE BOOT has made a gift of 50,000*l*. to University College, Nottingham, in aid of the development of the scheme for a University of Nottingham. 30,000*l*. is for the building fund and 20,000*l*. for the foundation of a chair of chemistry.

The council of University College, Swansea, has made the following appointments to headships of departments, viz.:—*Professor of Metallurgy*: Prof. C. A. Edwards. *Professor of Chemistry*: Dr. J. E. Coates. *Professor of Physics*: Dr. E. A. Evans. *Professor of Mathematics*: Lt.-Col. A. R. Richardson. *Lecturer in Geology*: Dr. A. E. Trueman. *Lecturer in History*: Mr. E. Ernest Hughes.

The Trustees of the Beit Fellowships for Scientific Research, which were founded and endowed in 1913 by Sir Otto Beit to promote the advancement of

science by means of research, have recently elected Mr. M. A. Hogan to a fellowship. Mr. Hogan was educated at the Catholic University School, Dublin, 1907-15, and has been a student at the University College, Dublin (National University of Ireland), from 1915 to date. Mr. Hogan will carry out his research at the Imperial College at South Kensington.

THE Industrial Fellowship System for the promotion of industrial research, originated by Prof. Robert Kennedy Duncan, has been in successful operation in the University of Pittsburgh since September, 1911. Full particulars of the system are given in a pamphlet by Mr. T. Ll. Humberstone published by the Board of Education. The seventh annual report of the Mellon Institute, founded in the University in 1913, states that the total funds contributed by industrial firms for the nine years ending March 1, 1920, was 1,213,425 dollars, and that in the year 1919-20 the number of fellowships was 47 and the number of fellows 83, the fellowships being 35 for individuals and 12 for groups of workers. A list of fellowships in operation at March 1, 1920, is published, which shows the great diversity of subjects of industrial research to which the scheme has been applied. The fact that the resources of the institute are fully used, and that applications exceed the available accommodation, is convincing evidence of the soundness of the principles on which the system is based. The institute is administered by the director, Dr. Raymond F. Bacon, assisted by an associate director and three assistant directors, who prepare schemes of research work, select the fellows, and supervise their investigations.

THE foundation-stone of the new buildings of the University College of Swansea was laid by his Majesty the King on Monday, July 19. A magnificent site of forty-five acres in Singleton Park, on the shores of Swansea Bay, has been presented to the college by the Corporation of Swansea, which has also granted the temporary use of Singleton Abbey for the housing of the faculty of arts and the administrative offices of the college. It should be a matter of encouragement to the council of the college that the main features of its policy received marked approval and support in the terms of the King's reply to the address of welcome on Saturday last. It is the natural ambition of Swansea to build up a strong School of Applied Science, including a department of metallurgy of the first rank. At the same time the educational ideals of the Welsh people demand for the great population of this industrial district the fullest provision for the study of the humanities and for the advancement of learning in the widest sense. The authorities of the college are fully alive to the magnitude of their opportunities and the greatness of their trust. Unmistakable proofs have already been given by representatives of all classes of deep interest in the work of the college and a determination to secure practical assistance. The wide publicity afforded by the Royal visit and the statesmanlike terms of the King's address cannot but serve to widen and strengthen both enthusiasm and practical support. The concluding terms of the King's reply to the address of welcome were as follows:—"Efficiency is much, but it is not all. We must never forget that education is a preparation for life, and that its true aim is the enlargement of the human spirit. It will be the task of your college to send out into the world men and women fully equipped for the material work which awaits them, and with minds attuned to high ideals, opened to the rich and varied interests of modern life, and steadfastly set towards the service of their fellows."

## Societies and Academies.

## EDINBURGH.

**Royal Society**, June 7.—Prof. F. O. Bower, president, in the chair.—D. **Balsillie**: The intrusive rocks of the Dundee district. These belong to two types, viz. diabases and felsites. The former are generally fine-grained dark masses that contain hypersthene and free quartz, which minerals, along with monoclinic pyroxene and abundant plagioclase feldspar (60 per cent. anorthite), occur in a highly felspathic ground mass. Hornblende, biotite, iron ores, and apatite occur as accessories, the first-mentioned, however, only rarely. Occasionally free quartz disappears, the place of hypersthene being then taken by olivine. As a type of olivine diabase may be cited the large intrusive mass near Newton, west from Auchterhouse station. The hypersthene diabases are characterised by the presence of acid segregation veins that often show beautiful graphic intergrowth of quartz and feldspar. Nearly all these basic rocks are much altered, the phenomenon of albitisation being of frequent occurrence, and typically displayed in the diabases of Castle Huntly, west from Dundee. The pink rocks would probably have been classed by the older writers as mica oligoclase porphyrites, which name still sufficiently describes them. Reference was also made to an outcrop of highly solidified ash occurring at Mill of Mains, north of Dundee, that probably marks the site of an old volcanic vent. In discussing the age of the intrusions, the opinion was put forward that these rocks of the Dundee district should be regarded as belonging to the volcanic cycle of Lower Old Red Sandstone times.—F. L. **Hitchcock**: An identical relation connecting seven vectors.

June 21.—Prof. F. O. Bower, president, in the chair.—J. **Goold**: The musical scale. The author described a new way of regarding the genesis of the musical scale. Beginning with the four notes, or with the three perfect fifth intervals determined by the four notes F, C, G, and D, the author showed that the group of four notes a major third above these, and the third group of four notes a major third below them, gave, when reduced to the range of one octave, all the notes of the recognised chromatic scale. Another point emphasised was that all the notes of the scale had relative frequencies which depended on powers and products of the numbers 3 and 5.—J. **Marshall**: A law of force giving stability to the Rutherford atom. It was shown that if the law of force between a positive nucleus and a negative electron were of the form

$$\frac{1}{r^2} \left( 1 - \frac{\beta n^2}{r^{n-2}} \right)$$

a value of  $n$  can be found which will preserve the stability of a group of electrons not exceeding seven in number. Since  $b$  is small compared to the radius of an atom, this law is indistinguishable from the inverse square law for distances large in comparison with the radius of the atom. If in the case of an atom built up of a series of rings of electrons the tentative assumption be made that the inner rings act on the individuals of the outer rings as if the inner set were replaced by an equivalent charge at the centre, the investigation may be generalised to include such cases also; and it is found that for displacements perpendicular to the plane of the orbit the configuration is unstable when the number of electrons in the outer ring exceeds seven. This would seem to indicate that the atom could be built up of a series of rings of seven electrons, and that we should expect a periodicity in the chemical properties

of the atoms corresponding to Mendeléeff's classification, which was stated by Newlands in 1864 in the form: "The eighth element starting from a given element is a kind of repetition of the first."—Prof. A. W. C. **Menzies**: The explanation of an outstanding anomaly in the results of measurement of dissociation pressures.—Prof. J. A. **Gunn** and Dr. D. G. **Marshall**: The harmala alkaloids in malaria.

## PARIS.

**Academy of Sciences**, July 5.—M. Henri Deslandres in the chair.—A. **Lacroix**: An eruption of the Karthala volcano at Grand Comore in August, 1918. This eruption commenced with a quiet flow of lava; a fortnight later explosions commenced, with emission of ashes reaching a great height. The explosive emission is considered as being probably due to the action of superficial water.—Em. **Bourquetel** and M. **Bridel**: The biochemical preparation of cane-sugar, starting with gentianose. Experiments made in 1910 indicated the probability of cane-sugar being one of the products of emulsin on gentianose, but the sugar could not be isolated. In 1920, using emulsin specially purified from traces of invertin, after separation of the glucose as  $\beta$ -methylglucoside, saccharose was obtained in a pure state.—A. A. **Michelson**: The application of interference methods to astronomical measurements. A development of a method described in the *Philosophical Magazine* in 1896. Measurements on Capella made with the 250-cm. reflector at Mount Wilson Observatory gave the parallax of this star as slightly under  $0.050''$ , with an accuracy of about  $1/1000$ th of a second of arc. Experiments at Mount Wilson on a larger scale are contemplated.—W. **Kilian** and P. **Falot**: The existence of the facies of various Jurassic layers in the province of Tarragon (Catalonia).—A. **Righi**: Observations concerning a recent note on Michelson's experiment. An adverse criticism of some calculations by M. **Villey**.—W. **Sierpinski**: The measurable B ensembles.—E. **Cartan**: The projective applicability of surfaces.—E. **Berger**: The production of chlorides with a primer.—M. **Godchot**: The oxidation of coal. The experiments described afford no support to the view recently put forward that the oxidation of coal results from the action of bacteria pre-existing in the coal.—E. E. **Blaise**: The action of substituted hydrazines upon acyclic 1:4-diketones. A study of the reaction between dipropionylethane and phenylhydrazine. Substituted hydrazines give pyrrol derivatives with 1:4-diketones.—M. **Delépine**: Ethylene sulphide,  $C_2H_4S$ . Previous attempts to prepare the sulphur analogue of ethylene oxide have been unsuccessful. It can be obtained by the action of sodium sulphide upon ethylene chlorothiocyanate,  $CH_2Cl \cdot CH_2 \cdot CNS$ , and subsequent distillation in a current of steam. Ethylene thiocyanate,  $CNS \cdot CH_2 \cdot CH_2 \cdot CNS$ , can replace the chlorothiocyanate in this preparation.—J. **Bougault** and P. **Robin**: The iodoamidines. Benzimidazole with iodine and dilute soda solution gives the compound  $C_4H_4N_2I$ , in which the iodine is attached to a nitrogen atom, since it is quantitatively removed by potassium iodide in acid solution. The reaction appears to be a general one for amidines.—M. **Guerbet**: A reaction for benzoic acid based on its diazotisation: its application to toxicological detection of atropine, cocaine, and stovaine. The reaction is based on the production of  $\beta$ -naphtholazobenzoic acid, and will detect readily 0.1 milligram of benzoic acid.—P. **Idrac**: Convection currents in the atmosphere in their relation to hovering flight and certain forms of clouds.—P. **Notin**: The absorptive power of earth for manganese. When manganese solutions are treated with soil, manganese is fixed and some lime

is found in solution. Calcite was proved not to react with manganese salts, but lime was dissolved from aragonite and manganese retained.—**M. Gallaud**: A race of wallflowers with multiple and hereditary anomalies.—**A. Marie** and **L. MacAuliffe**: Study of 344 gypsies.—An anthropometrical comparison with the French race.—**E. Roubaud**: The mode of action of powdered trioxymethylene on the larvae of *Anopheles*. Further details of the best method of using trioxymethylene for the destruction of mosquito larvae.—**J. Dufrenoy**: The excretion of vital colouring matters and degenerescence in Ascidians.—**E. Chatton**: A morphological and physiological xeno-parasitic complex: *Neresheimeria catenata* and *Fritillaria pelucida*.—**R. Combar**: The purification of sewage by activated sludge.—**A. Mayer**, **L. Plantefol**, and **A. Tournay**: The physiological action of symmetrical dichlorodimethyl ether.

## CAPE TOWN.

**Royal Society of South Africa**, May 19.—**Dr. A. Young** in the chair.—**J. Moir**: Colour and chemical constitution. Part xi.: A systematic study of the brominated phenolphthaleins regarding the relation between position and colour. The spectra of twenty-three bromine derivatives of phenolphthalein are described, these being selected from the 658 possible isomers so as to give clear evidence of the value of each of the twelve possible positions for bromine as regards change of colour. These values are tabulated, whereby any of the uninvestigated isomers should be calculable. Phenolphthalein differs from benzaurine in not having a negative paraposition; hence the author concludes that the current chemical formula for the former is incorrect, and suggests a new formulation.—**J. R. Sutton**: The relationship between cloud and sunshine. A brief discussion of the observations of sunshine and cloud made during the twenty years 1900-19 at Kimberley. In a general way much sunshine postulates little cloud; but the relation is not intimate, and a sunshine recorder cannot be regarded as an automatic device for determining the cloudiness of the sky. August gets the most sunshine and February the most cloud.—**Miss Ethel M. Doidge**: The haustoria of the genera *Meliola* and *Irene*. The fungi belonging to the genus *Meliola* are true parasites, sending haustoria into the cells of the host. The most common type is that which has a fine filament penetrating the cuticle and a small globular, thin-walled, uninucleate vesicle in the epidermal cell. Certain species penetrate through the epidermis, through sclerenchyma cells, if these are present, into the first chlorophyll-containing cells of the mesophyll. The haustoria cause a considerable disorganisation of the cells into which they penetrate, and the mycelium completely blocks many of the stomata.

## SYDNEY.

**Linnean Society of New South Wales**, May 26.—**Mr. J. J. Fletcher**, president, in the chair.—**Dr. R. J. Tillyard**: The Neuropteroid insects of the Hot Springs Region, New Zealand, in relation to the problem of trout-food. Examination of the contents of trout-stomachs showed that the most abundant foods were the green manuka-beetle, *Pyronota festiva*, the larvae of caddis-flies of the family Leptoceridae, and a small mollusc, *Potamopyrgus* sp. Less abundant were larvae of dragonflies, mayflies, stoneflies, other families of caddis-flies, etc. Since the introduction of the trout the insect fauna of the region has been very greatly reduced, the percentage reduction being estimated as follows: Mayflies, more than 50; stoneflies, 80; and caddis-flies, 90. In the vicinity of a few streams to which the trout have no access insects are

still comparatively very abundant. Suggestions for improving the position are made along two lines: (1) Improvement of the food-supply, and (2) reduction in the number of trout.—**Dr. R. J. Tillyard**: The Panorpid complex. Additions to part 3. Additional evidence is brought forward from the study of the pupal tracheation of *Morova (Siculodes) subsfasciata*, Walk., to support the conclusion that it is isolated that any existing Heteroneurous type represents even a close approximation to the original archetype of the Rhopalocera.

## WASHINGTON, D.C.

**National Academy of Sciences** (Proceedings, vol. vi., No. 1, January).—**C. Barus**: An example of torsional viscous retrogression. Observations interesting in their bearing on Maxwell's theory of viscosity.—**C. M. Myers** and **C. Voegtlin**: The chemical isolation of vitamins. The method eliminates purines, histidine, proteins, and albumoses, leaving a liquid that can be crystallised, and probably contains histamine or histamine-like substances. The physiological action of the active fractions resembles that of extracts from the mucosa of the small intestine when the intestinal and yeast extracts are purified in the same manner.—**C. G. Abbot**: A new method of determining the solar constant of radiation. A method using the pyranometer applicable on many more days than the old method, and having the advantage that several independent observations of the solar constant may be made on a single day.—**F. G. Benedict**: The basal metabolism of boys from one to thirteen years of age. A formula and a curve are given, and it is shown that, although age and stature as well as body-weight must be considered in predicting heat output for adults, it is not necessary to consider more than the body-weight in the case of boys—a fact probably due to the close correlation between the changes in age, weight, and stature for boys.—**R. A. Dutcher**: The nature and function of the antineuritic vitamin. A general review of the theory, with numerous references, is followed by a brief sketch of the author's work, suggesting that the hormone supply is dependent upon the vitamin-content of the food.—**H. F. Osborn** and **C. C. Mook**: Reconstruction of the skeleton of the Sauropod Dinosaur *Camarasaurus*, Cope (*Morosaurus*, Marsh); and **W. K. Gregory**: Restoration of *Camarasaurus* and life-model. A restoration both in the articulation and in the musculature, with a brief statement of the essential characteristics of each.—**W. D. Matthew**: Plato's Atlantis in paleogeography. It is suggested that the present conformation of the Atlantic bottom dates back, in part at least, to the Paleozoic era.—**A. A. Noyes** and **D. A. MacInnes**: The ionisation and activity of largely ionised substances. A general discussion, with considerable bibliography, leading to the conclusion that most of the largely ionised inorganic substances at moderate concentration may be considered as completely ionised, and the decrease in the conductance-ratio wholly attributed to the decrease of ion mobility, and the change in activity-coefficient entirely attributed to some unknown effect of a physical nature.—**A. C. Lunn**: The commutativity of one-parameter transformations in real variables. A proof previously given by Lie and Engel applicable to analytic functions is supplanted by a proof assuming the existence of continuous first partial derivatives only.—**D. L. Webster**: The intensities of X-rays of the L series. II.: The critical potentials of the platinum lines. After a discussion of the special apparatus employed, a discussion of the lines observed places six lines in  $L_{11}$ , six in  $L_{12}$ , three in  $L_{13}$ . The faint lines of Dershem and Overn are unassigned.

Critical points and intensity ratios are discussed.—**J. B. Murphy**: The effect of physical agents on the resistance of mice to cancer. The evidence points to the lymphoid tissue as an important agent in the immunity reaction of transplanting cancer of mice.—**H. C. Sherman**: The protein requirement of maintenance in man. For the maintenance of healthy men and women an intake of not more than 35-45 grams of protein per "man" of 70 kg. per day is sufficient even when the protein is not especially selected, and hence the "standard" allowance of 1 gram of protein per kg. of body-weight per day provides an ample margin of safety.—**R. P. Cowles**: The transplanting of sea-anemones by hermit crabs. A study of behaviour with the problems it presents in this particular case.—**J. A. Anderson**: Spectra of explosions. Discussion of a new method for obtaining intense spectra of short duration, the new source of light being of the order of one hundred times the brilliancy of the sun.—Report of the Autumn Meeting: The report contains items of business, including the award of medals, the distribution of research grants, and the list of papers read before the Academy.

### Books Received.

Gold: Its Place in the Economy of Mankind. By **B. White**. Pp. xi+130. (London: Sir I. Pitman and Sons, Ltd.) 3s. net.

British Museum (Natural History). Catalogue of the Lepidoptera Phalaenæ in the British Museum. Supplement, vol. ii. Catalogue of the Lithosiadæ (Arctianæ) and Phalaenoididæ in the Collection of the British Museum. By **Sir George F. Hampson**. Plates xlii-xxxi. (London: British Museum (Natural History).) 32s. 6d.

Splendours of the Sky. By **Isabel M. Lewis**. Pp. vii+343. (London: J. Murray.) 8s. net.

The United States Forest Policy. By **Prof. J. Ise**. Pp. 395. (New Haven: Yale University Press; London: Oxford University Press.) 21s. net.

Lectures on Modern Idealism. By **J. Royce**. Pp. xii+266. (New Haven: Yale University Press; London: Oxford University Press.) 12s. 6d. net.

The Mediæval Attitude towards Astrology, particularly in England. (Yale Studies in English, No. lx.) By **T. O. Wedel**. Pp. vii+168. (New Haven: Yale University Press; London: Oxford University Press.) 10s. 6d. net.

Some Famous Problems of the Theory of Numbers, and in particular Waring's Problem. An Inaugural Lecture delivered before the University of Oxford. By **Prof. G. H. Hardy**. Pp. 34. (Oxford: At the Clarendon Press.) 1s. 6d. net.

Anthropology and History. Being the twenty-second Robert Boyle Lecture delivered before the Oxford University Junior Scientific Club on June 9, 1920. By **W. McDougall**. Pp. 25. (London: Oxford University Press.) 2s. net.

Manuel de Topométrie. Opérations sur le Terrain et Calculs. By **J. Baillaud**. Pp. vii+222. (Paris: H. Dunod.) 13 francs.

Bureau of Education, India. Indian Education in 1918-19. Pp. ii+86+plates. (Calcutta: Government Printing Office.) 1.8 rupees.

Ministry of Agriculture, Egypt. Report on the Maintenance and Improvement of the Quality of Egyptian Cotton and the Increase of its Yield. By **H. Martin Leake**. Pp. iv+38. (Cairo: Government Press.) P.T. 5.

The National Physical Laboratory. Report for the Year 1919. Pp. 152. (London: H.M. Stationery Office.) 5s. net.

Dictionary of Explosives. By **A. Marshall**. Pp. xiv+159. (London: J. and A. Churchill.) 15s. net.

The North of Scotland College of Agriculture. Guide to Experiments at Craibstone, 1920. Pp. 44. (Aberdeen: Milne and Hutchison.)

Ministry of Public Works, Egypt. Report on Psychrometer Formulæ based on Observations in Egypt and the Sudan. (Physical Department Paper No. 2.) By **E. B. H. Wade**. Pp. ii+45-72+2 plates. (Cairo: Government Press.) P.T. 5.

The Journal of the Royal Anthropological Institute. Vol. xlix., July to December, 1919. Pp. 181-370+12. (London.) 15s. net.

An Ethno-Geographical Analysis of the Material Culture of Two Indian Tribes in the Gran Chaco. (Comparative Ethnographical Studies, i.) By **E. Nordenskiöld**. Pp. xi+295. The Changes in the Material Culture of Two Indian Tribes under the Influence of New Surroundings. (Comparative Ethnographical Studies, ii.) By **E. Nordenskiöld**. Pp. xvi+245. (London: Oxford University Press.) 20s. net, 2 vols.

Ministry of the Interior, Egypt. Department of Public Health. Reports and Notes of the Public Health Laboratories, Cairo. Egyptian Water Supplies. Pp. ii+105. (Cairo: Government Press.) P.T. 20.

### CONTENTS.

PAGE

Aerial Navigation and Meteorology. By <b>Prof. E. van Everdingen</b>	637
Child Physiology. By <b>J. W. B.</b>	638
Forest Research	639
The Absorption of Light by Organic Compounds	640
Our Bookshelf	641
Letters to the Editor:—	
British and Foreign Scientific Apparatus.— <b>Prof. W. M. Bayliss, F.R.S.</b>	641
The Separation of the Isotopes of Chlorine.— <b>Prof. Frederick Soddy, F.R.S.</b>	642
Science in Medical Education.— <b>Prof. Sydney J. Hickson, F.R.S.</b>	643
The Mechanics of the Glacial Anticyclone Illustrated by Experiment. (Illustrated.)— <b>Prof. Wm. H. Hobbs</b>	644
The Diamagnetism of Hydrogen.— <b>Dr. J. R. Ashworth</b>	645
Occurrence of Ozone in the Atmosphere.— <b>J. N. Pring</b>	645
Crystal Structure. (Illustrated.) By <b>Prof. W. L. Bragg</b>	646
Researches on Growth of Plants. II. (Illustrated.) By <b>Sir Jagadis Chunder Bose, F.R.S.</b>	648
Popular Natural History. (Illustrated.) By <b>J. A. T. Notes</b>	651
Our Astronomical Column:—	
A New Comet	658
Publications of the Dominion Astrophysical Observatory, Victoria, B.C., Vol. 1, No. 1	658
Progress in Science and Pharmacy. By <b>Charles Alexander Hill</b>	659
Medical Science and Education	661
First Conference of the International Federation of University Women	662
Insect Pests	662
Investigations of the Upper Air	663
Bionomics of <i>Glossina palpalis</i> . By <b>J. W. W. S.</b>	663
Dante and Trepidation	664
Japanese Botanical Work	664
Researches on Egyptian Cotton. By <b>Dr. W. Lawrence Balls</b>	664
University and Educational Intelligence	665
Societies and Academies	666
Books Received	668



THURSDAY, JULY 29, 1920.

*Editorial and Publishing Offices:*

MACMILLAN &amp; CO., LTD.,

ST. MARTIN'S STREET, LONDON, W.C.2.

Advertisements and business letters should be  
addressed to the Publishers.

Editorial communications to the Editor.

Telegraphic Address: PHUSIS, LONDON.

Telephone Number: GERRARD 8830.

**A Chemical Service for India.**

**T**HE constructive proposals put forward in the Report of the Indian Industrial Commission, 1916-18, presided over by Sir Thomas Holland, were dependent on the acceptance of two principles: (1) That in future Government must play an active part in the industrial development of the country, with the aim of making India more self-contained in respect of men and material; (2) that it is impossible for Government to undertake that part unless provided with adequate administrative equipment and fore-armed with trustworthy scientific and technical advice.

The Report under consideration<sup>1</sup> is the work of a Committee which sat in Simla, from February 16 until February 28 of this year, after the president with two members of the Committee had toured through the provinces. The Committee was appointed "to formulate proposals for the organisation of a Chemical Service for India and for the location and equipment of research laboratories."

Prof. J. F. Thorpe, professor of organic chemistry in the Imperial College of Science and Technology, London, was president of the Committee. His associates were Dr. K. S. Caldwell, principal of Patna College; Mr. R. W. Davies, district and sessions judge, North Arcot, Madras Presidency; Dr. W. Harrison, Imperial agricultural chemist, Research Institute, Pusa; Sir P. C. Ray, professor of chemistry, University College of Science, Calcutta; Dr. J. L. Simonsen, forest chemist, Forest Research Institute and College, Dehra Dun; Dr. J. J. Sudborough, professor of organic chemistry, Indian Institute of Science, Bangalore.

The terms of reference to the Committee were:

(1) To consider whether an all-India Chemical Service is the best and most suitable method of

<sup>1</sup> Report of the Chemical Services Committee, 1920. (Simla: Government Central Press.)

overcoming the difficulties and deficiencies pointed out by the Indian Industrial Commission.

(2) In the event of the Committee approving the principle of an all-India service, to devise terms of recruitment, employment and organisation; to indicate the extent to which chemists already in Government employ should be included in that service; and to suggest what should be the relations of the proposed organisation with the public and with Departments of the Government of India and of Local Governments.

(3) In particular to frame proposals for the location, scope and organisation of institutions for chemical research.

During his tour Prof. Thorpe became satisfied that the development of the chemical industries of India could be adequately realised only through the agency of an efficient Government Chemical Service. Nowhere did he find an effective organisation to co-ordinate the various efforts which were being made; not one of the provinces had even formulated a programme of its requirements or decided what educational methods were necessary to attain the desired ends. To achieve success the proposed Chemical Service must be recruited mainly from Indian sources: the question of an adequate training in Indian universities is therefore vital. This subject is specially dealt with by Prof. Thorpe in an able introductory note: the Committee expresses itself as in agreement with his views.

The evidence put before the Committee was so definitely in favour of a Chemical Service that it came to the conclusion that question No. 1 of its remit, quoted above, could be best answered by the formation of a service having as its primary objective the encouragement of industrial research and development.

The Committee makes thirty-five recommendations of which the first twelve are as follows:—

(1) That a Chemical Service should be constituted.

(2) That the service should be called the Indian Chemical Service.

(3) That the service should be controlled by a Director-General.

(4) That a Central Imperial Chemical Research Institute should be erected at Dehra Dun under the Director-General of the Chemical Service, as Director, assisted by a number of Deputy Directors.

(5) That each Deputy Director should be in charge of a separate Department and that, in the first instance, there should be four Departments, (a) Inorganic and Physical Chemistry, (b) Organic Chemistry, (c) Metallurgical Chemistry, (d) Analytical Chemistry.

(6) That a Provincial Research Institute under

the control of the Local Government should be erected in each province near the chief seat of industry in that province and that each Provincial Research Institute should be under a Director of Research.

(7) That the functions of the Central Imperial Institute should be as follows :—

- (i) to create new industries and to carry out the development of new processes up to the "semi-large" scale or further if necessary,
  - (ii) to investigate those problems of a fundamental character, arising from the work of the Provincial Institutes, which have been transferred to the Central Institute by the Local Director of Research in consultation with the Director-General. Such problems will be those which have no apparent immediate practical importance but which, in the opinion of the Director-General and the Director of Research, are likely to lead to discoveries of fundamental industrial importance affecting the industries of the country generally,
  - (iii) to assist in the co-ordination of the work in progress in the provinces : both by means of personal discussion between the officers of the Central and Provincial Institutes during the course of the tours made by the Director-General and the Deputy Directors and by means of periodical conferences of Provincial and Imperial officers,
  - (iv) to carry out such analytical work as may be required and to correlate the methods of analysis in general use throughout the country,
  - (v) to maintain a Bureau of Information and Record Office,
  - (vi) to issue such publications as are considered necessary.
- (8) That the functions of the Provincial Research Institutes should be as follows :—
- (i) to maintain close touch with the works chemists and with the works generally and to work out any problems which may be submitted to them,
  - (ii) to develop and place on an industrial scale new industries which have been previously worked out on the laboratory and "semi-large" scale by the Central Imperial Institute,
  - (iii) to carry out such other work as may be necessary to establish and foster new industries peculiar to the province,
  - (iv) to carry out such analytical work of a chemical character as may be required in the province,
  - (v) to erect and control sub-stations in such parts of the province as the development of industry may require.
- (9) That, under (8) (i) above, arrangements should be made by which a firm supplying a problem should have the use of the solution for an agreed period of time prior to its publication.
- (10) That members of the service should be

lent to private firms as occasion demanded and should during the period of their service be paid an agreed sum by the firms.

(11) That the Research Institutes should not undertake manufacture in competition with private enterprise but that chemical industries developed in accordance with (8) (ii) above should be handed over to private firms as soon as practicable.

(12) That, whenever necessary, experts should be employed to establish chemical industries based on known processes.

Among the other recommendations are that agricultural chemists should not at present be included in the service; that a Ministry of Science should be created as soon as practicable; that a Chemical Survey of India should be carried out at the earliest possible moment; and that the Government of India should give maintenance and equipment grants to students, to enable them to undergo the training in chemical research required for recruitment.

It is not a little remarkable that the only member of the Committee to take exception to the creation of an all-India Chemical Service is the one Indian member, Sir P. C. Rây. A separate note is appended to the Report in which he forcibly states his objections. Sir P. C. Rây's opinion must carry great weight, not only on account of his long experience and his distinction as a teacher and investigator but also because of his familiarity with industrial requirements and possibilities, he having long been concerned with the management of a chemical works which he was instrumental in establishing. The present writer had the opportunity of visiting this works when in Calcutta in November, 1914, and was much struck by the ingenuity displayed in the construction of the plant; various heavy chemicals were being made, including sulphuric acid, in substantial quantities.

Although Sir P. C. Rây considers that the days of Government services are over and that the development of industries by the agency of a Government service is not the most suitable way of dealing with the problem, yet he agrees that, if a Government service be constituted, the proposals of the Committee represent the best method of constituting and carrying on such a service. His view is that better results would be obtained by improving the teaching of chemistry in the Indian universities; by attracting brilliant young men by the offer of research scholarships; and by attaching technical institutes to each university.

The circumstances of India are so entirely

peculiar that it is impossible to judge the scheme from an ordinary point of view. A number of those who contributed to the recent correspondence in *NATURE* appear to fear that the liberty of the subject engaged in research work may be improperly interfered with and curtailed by the institution of a separate Chemical Service. This should not be the case. It is to be supposed that the studies undertaken will be strictly utilitarian in character—the primary objective being the encouragement of “industrial research” and to secure the co-operation of science and industry. The fact is, the term “research” were better put aside altogether in the present connection—it now has so many meanings, if any meaning in particular: it should be confined to strictly original inquiry and regarded as a word of sacred import. Organised scientific inquiry into industrial problems is what is aimed at by the promoters of the scheme: therefore Central Scientific Institute would be a better title than Central Research Institute, “Research” being a word unknown to the multitude and one for which it never can have any feeling.

India is a country of vast size and is broken up into an infinitude of small holdings: its problems are more than numerous: the nature and extent of its raw materials must be surveyed without loss of time: very little has been done to develop industries. The one crying need seems to be an organisation of effort. A service is required if only in protection of the workers.

Perhaps the chief objection to be taken to the scheme is its magnitude and therefore its costliness; it involves the simultaneous establishment of so many district institutes, to satisfy the desire of the several provinces to exercise administrative control in their own areas. The real difficulty will be to find men who are competent to act as directors—men who are not only technically competent but also sufficiently imaginative and broad in outlook, *able to hold their own socially* and to manage men. Such men have been in constant demand here of late and too rarely forthcoming. Indeed, the complaint is frequent that, though those entering technical careers may be chemists by training, they lack initiative and are unable to shoulder responsibility. Science does not at present attract the right type of intelligence to its ranks. Do not let us delude ourselves into thinking that we can repair our past errors and become a scientific nation at will—by admitting large numbers to the schools and creating numerous new posts: without acumen and

experience, nothing can be done. The success of the Indian scheme will depend largely on the man first chosen to fill the post of Director of the Central Institute: he must be gifted with a liberal spirit and with ideas; his time must not be unduly taken up in attending to administrative details; he must himself be a skilled scientific worker. Only such a man will be able to assist the work of the universities and be a generous and capable critic of the men they educate for the purposes of industry and the State service.

Sir P. C. Rây would in all cases start industries by means of technical experts imported from abroad and would not attempt to work them up locally with the aid of the Research Institutes, as proposed by the Committee. He is unquestionably right in so far as large industries, well established elsewhere, are concerned; and as a matter of fact the Committee advises that this course should be taken in all such cases. The proposals of the Committee apply specially to small-scale industries in which it is desirable to encourage native activity; the work done by Sir Alfred Chatterton in Madras in developing the use of aluminium may be quoted in illustration. The Indian is eminently conservative and is not easily persuaded to do new things—but he can often be led by ocular demonstrations; it will be the function of the provincial institutes to give these.

In its reference to the exploitation of forest products, the Committee mentions match-making as an industry which it understands the Forest Department has under contemplation and seems to give its approval. Here Sir P. C. Rây's criticism is to the point. Match-making is so thoroughly understood that it seems undesirable that academic workers should take it in hand: in such a case, it were better at once to call in the expert. The suitability of various fibres for paper-making is quite another question: it is clearly desirable that these should be first tested on the spot, so that the many variations to which the raw material would be subject could be taken into account.

The great value of the Report lies in the recommendation of an all-India scientific service—the directions in which the service can be made of most avail will be gradually discovered as the service comes into operation. That the industrial future of India can be secured only with the aid of the scientific inquirer and by placing industry on a scientific footing is beyond all question. Thanks are due to Prof. Thorpe and his col-

leagues for the able way in which they have dealt with their onerous task.

Mr. Howard, Imperial economic botanist to the Government of India, directed attention recently, at the Royal Society of Arts, to the future of economic botany in India and to the many complex problems awaiting solution: after asking what is the best method of getting such work done—whether we should rely on organisation or trust to the individual—he expressed the opinion that individual action is to be preferred. But surely the competent individual should be able to influence a receptive though unimaginative multitude. Increase in knowledge is of little value if it do not give us an increase of power to use our knowledge—we know that it does. During the war, much organised team work was accomplished by scientifically trained workers under the influence of a few guiding minds. The men who are doing research work in the various schools are for the most part unconscious members of a service acting under the inspiration of a few leaders: there is no reason why the system should not be carried from academic life into the public service. We are alive to the faults by which a public system is likely to be affected and should be able to guard against them.

HENRY E. ARMSTRONG.

### Tycho Brahe.

*Tycho's Brahe Dani Opera Omnia.* Edidit I. L. E. Dreyer. Tomus vi. Pp. v+375. (Haunia: Libraria Gyldendaliana, 1919.) Price 19 kr.

MR. HAGEMANN, who is bearing the expense, and Dr. Dreyer, who has undertaken the labour of editing the works of Tycho Brahe, are alike to be congratulated on the appearance of this elegant edition of the first book—the only one ever published—of the “*Epistolarum Astronomicarum*.” The frontispiece consists of a handsome portrait of Tycho Brahe, dated 1586, reproduced from the first edition, which appeared in 1596. Here the portrait is enclosed in an arch ornamented with sixteen coats-of-arms, either, we may conjecture, his sixteen quarterings, or at least the arms of his own and fifteen kindred families. The English reader will note with special interest the arms of Rosenkrans and Guldensternen, and we have not far to seek for bearers of those arms. In Dr. Dreyer’s “Tycho Brahe” (1890) Jörgen Rosenkrands is frequently mentioned as a patron of Tycho. He was Governor of Jutland, and in 1588 was made one of the Council of Regency for the young King Christian IV. of

Denmark. Axel Guldenstern appears in two letters in the present volume dated 1592, where he is described as a kinsman of Tycho and Governor of Norway.

The letters contained in the present volume range in date from 1585 to 1595. They comprise the correspondence of Tycho Brahe with Wilhelm, Landgrave of Hesse-Cassel, his son and successor Moritz, and his “mathematicus” Rothmann. The letters are partly in Latin and partly in German, but the German letters are always accompanied by a Latin translation. Their contents are well exploited in Dr. Dreyer’s “Tycho Brahe,” mentioned above, and in his “History of the Planetary Systems” (1906). Perhaps the most generally interesting part of the present collection is the description of Tycho’s observatory at Hveen and of his instruments, which occupies pp. 250–95 of this volume. Tycho’s attitude to astronomy and astronomers is well illustrated by the selection of eight, whose portraits adorned the crypt of his observatory—Timocharis, Hipparchus, Ptolemy, Albategnus, Alfonso, Copernicus, Tycho Brahe, and Tychonides, with the pithy distichs in which Tycho sums up the importance of each (pp. 274, 275).

The correspondence with Rothmann will remain famous for the clearness with which Rothmann grasped the implications of the Copernican system, and maintained them against Tycho’s futile objections, which, to men brought up to believe in a stationary earth, appeared so cogent. It is somewhat pathetic that this record of the ancient controversy should have appeared only a few weeks before the triumphant vindication of a new theory which renders the difference between Copernicus and Tycho meaningless.

Tycho was the first of modern astronomers to make more than occasional observations, and it was therefore natural that the work of the ancient observers, particularly Timocharis, Hipparchus, and Ptolemy, should possess a living interest for him and his correspondents instead of having, as to nearly all modern astronomers, a purely antiquarian importance. Rothmann (p. 115) made one unhappy suggestion about Ptolemy which can scarcely have been intended for publication. Certainly the author can never have dreamed of the way in which it was to be extended. The suggestion is that the places of the fixed stars in Ptolemy were not observed by him, but merely transcribed from Hipparchus. Rothmann shows, quite correctly, that the latitude which Ptolemy professes to have observed for Regulus is inconsistent with the longitude and declination which he also professes to have observed; his own observations, he says, are not inconsistent with

the accuracy of Ptolemy's latitude and longitude; therefore it must be the declination that was in error; this, he thinks, was extrapolated from the declinations observed by Timocharis and Hipparchus, and he concludes that Ptolemy observed no declinations at all, but merely deduced them from Timocharis and Hipparchus. This probably suggested to Tycho Brahe the more sweeping charge, adumbrated in his "Progymnasmata" ("Opera," ii., 151), and stated clearly in the introduction to his Catalogue ("Opera," iii., 335), that the whole of Ptolemy's Catalogue was merely a reproduction of the Catalogue of Hipparchus, reduced to Ptolemy's epoch by means of a constant correction to the star places. This charge has had a wide currency, but has been refuted by Laplace and Ideler, and finally by Dr. Dreyer in his paper, "On the Origin of Ptolemy's Catalogue of Stars," *Monthly Notices of the Royal Astronomical Society*, lxxviii. (1918), pp. 343-49. The absurdity of Rothmann's original charge may be shown by a computation of the position of Regulus for the epoch of Ptolemy's tables. Ptolemy's declination, as it happens, is correct, but his latitude is in error, and his longitude is greatly in error, doubtless because his tables gave a false longitude to the sun, with which Regulus was compared.

J. K. FOTHERINGHAM.

### Psychological Tests in Industry.

*Employment Psychology: The Application of Scientific Methods to the Selection, Training, and Grading of Employees.* By Dr. Henry C. Link. Pp. xii + 440. (New York: The Macmillan Co.; London: Macmillan and Co., Ltd., 1919.) Price 10s. 6d. net.

EXPERIMENTAL psychologists in this country have always been keenly interested in research into individual mental differences, but to America we must turn for the first attempts to apply psychological tests to vocational selection and guidance. As might have been expected, an alternative method has arisen which claims to judge special abilities, aptitudes, and characters by the methods of phrenology, the colour of the hair and eyes, the texture of the skin, the slope of the handwriting, the squareness or roundness of the face, the shape of the chin, etc. As Dr. Link points out, attempts have been made to transform this method into "a reliable and scientific method of character analysis. . . . This so-called science has received wide publicity and has been accepted [both in America and in this country] by many prominent and hard-headed business men. It attempts to place observation

on a scientific basis by assuming that certain observable physical characteristics are identified with certain definite mental qualities, and by asserting as a corollary that a visual observation and measurement of the physical characteristics enable the observer to gauge a person's mental, moral, and emotional qualities. The smattering of scientific phraseology in the presentation of this method is just sufficient to impress those who have only a superficial knowledge of the scientific facts involved. . . . The fundamental assumption on which the so-called science of observation rests is an assumption entirely unwarranted by the facts" (pp. 240, 241).

Contrast with this the methods of industrial psychology. The psychologist first "finds, by means of an experimental process, what the relevant activities in an occupation or an operation are." This he does by means of tests which are tried out on workers whose ability is known and with whose work success in the tests can be compared and correlated. In this process he also discovers the standard which ought to be reached in the significant tests by those who wish to succeed at the kind of work in question. He then standardises the manner in which these tests should be used, so that every applicant for a particular kind of work will be examined in exactly the same way, and his ability determined according to the same formula (p. 249).

As Prof. Thorndike indicates in his introduction, "Dr. Link's book is important because it gives an honest impartial account of the use of psychological tests under working conditions in a representative industry. He has the great merit of writing as a man of science assessing his own work, not as an enthusiast eager to make a market for psychology with business men. Indeed the story of his experiments is distinctly conservative. . . ." (p. x). They included the testing of girls and men, of clerks, stenographers, typists, and "comptometrists," of machine operators, apprentice tool-makers, etc. They show what a wealth of valuable information for vocational guidance they can afford, and how excellent a corrective they are to the vague, inaccurate knowledge too often possessed by the foreman of the relative abilities of those who work under him. The tests used are fully given in an appendix to the book. The volume clearly indicates the importance of employment psychology, alike to the employer who "wishes to obtain the best possible kind of human material," and to Labour if it "wishes to carry out collective bargaining, if it wishes to base its claims for individuals on the sound basis of ability and training" (p. 389).

### Cultivation of the Vine in America.

*Manual of American Grape-growing.* By U. P. Hedrick. (The Rural Manuals.) Pp. xiii+458+xxxii plates. (New York: The Macmillan Co.; London: Macmillan and Co., Ltd., 1919.) Price 15s. net.

THIS book is one of the series of rural manuals edited by Prof. L. H. Bailey, and it should prove of great use to both commercial and amateur grape-growers. The opening chapter, dealing with the "Domestication of the Grape," is especially interesting. There are about fifty named species of the grape, most of them found in temperate countries. Of the Old World grapes only one species, *Vitis vinifera*, is cultivated for fruit, but of all grapes this is of greatest economic importance. *Vitis vinifera* is the grape of ancient and modern agriculture, and is the chief agricultural crop of Southern Europe and of vast regions in other parts of the world. The written records of its cultivation go back five or six thousand years, while the ancient Egyptians are known to have grown the vine for wine-making; the methods and processes of domestication, however, are now unknown. The records of the New World yield information on the cultivation of wild species of grapes, and the author describes the domestication process of the four species now extensively cultivated.

The author states that "few other agricultural industries are more definitely determined by environment than the grape industry," and he describes the grape regions of America, discussing the factors which determine the suitability of a region for grape-growing. Climate is the chief of these factors, and is dealt with in detail. Other factors treated of are soil, insects and fungi, accessibility to markets, etc.

Full information is given on propagation, fertilisers, breeding, etc., as well as a chapter on the various operations involved in transferring the grapes from garden to market, together with advice on the carrying out of these operations. The important subject of grape pests and their control is dealt with, the life-histories of the several pests being given in so far as they bear on the control methods.

A particularly interesting chapter is that on "Stocks and Resistant Vines," where we are given an account of the root-lice Phylloxera. This pest made its appearance in France in 1861, and increased so rapidly that by 1874 the whole vine industry of Europe was threatened with ruin. The situation was saved by the realisation of the fact that American grapes did not suffer from

Phylloxera attacks, hence the European vines were saved by grafting them on the Phylloxera-resistant roots of American grapes.

The chapter on grape botany gives the general botany of the vine and also includes a detailed account of the American grape species, while in the chapter on varieties of grapes descriptions are given of a large number of different types with their respective characteristics and advantages, the varieties described being those which will appeal to the amateur as well as to the commercial grower. The book is well supplied with illustrations and figures.

V. G. JACKSON.

### Our Bookshelf.

*Ministry of Public Works, Egypt: Zoological Service. Hand-list of the Birds of Egypt.* By M. J. Nicoll. (Publication No. 29.) Pp. xii+119+31 plates. (Cairo: Government Press, 1919.) Price P.T.15 (3s. 6d.).

AN up-to-date treatise on the avifauna of Egypt has for some time past been a desideratum in ornithological literature. It is now forty-eight years since the late Capt. Shelley's well-known book, hitherto the foremost on the subject, appeared, and much has been added to the knowledge of the subject in the meantime. This want is well supplied in an epitomised form by Mr. Nicoll's book.

The author, a well-known ornithologist, has resided in the country for thirteen years, and during the whole of this period has specially devoted himself to the study of its avifauna. The result of his labours is highly to be commended to the bird-loving visitor to Egypt, and to all who are interested in Palearctic ornithology, to whom, indeed, it is indispensable. The ornithologist of the "Land of the Pharaohs" is not only rich in its numbers—Mr. Nicoll treats of as many as 436 forms—but also of great interest, since its native birds, though Palearctic in the main, comprise a number of Ethiopian representatives. Another notable feature is presented by the birds of passage, vast numbers of which bi-annually traverse the country, especially the Nile valley, *en route* to northern summer haunts in spring, and again in autumn on their return to their accustomed tropical, equatorial, and South African winter quarters.

Among the native birds the ostrich became extinct seventy years ago, and it is sad to learn that the characteristic and beautiful Egyptian plover has practically ceased to exist. On the other hand, several once declining species, among them the buff-backed heron, are increasing in numbers as the direct result of protection. In addition to giving the status of the species and sub-species known to occur in Egypt, and particulars on the dates of the coming and going of the migrating birds, the author has furnished a short and useful diagnosis of each bird.

The book is illustrated by a series of thirty-one plates, eight of them in colour and devoted to figures of the protected species, while the rest are black-and-white figures showing the differences between the various species of chats, and certain warblers and wagtails, occurring in the country.

*Investigations in the Theory of Hyperion.* By Dr. J. Woltjer, jun. Pp. iii+71. (Leyden: E. J. Brill, 1918.)

THE motion of Hyperion, the seventh satellite of Saturn, is of special interest from the commensurability of its period with that of Titan, the two being in the ratio of 4 to 3. The late Prof. Newcomb wrote an important paper, "On the Motion of Hyperion: a New Case in Celestial Mechanics." The present work carries the investigation some steps further. The differential equations are broken up into partial systems, giving the inequalities proportional to the successive powers of  $e'$  the eccentricity of Titan's orbit. Newcomb had regarded this development as impracticable, but the present work demonstrates the contrary. The development is at present carried only to the first power of  $e'$ , which suffices to give a close approximation to the observed inequalities. For example, the ratio of masses of Saturn and Titan is deduced as 3986, which is close to the values 4172, 4125 found by Eichelberger and Santer respectively. Incidentally, we may note that the mass of Titan is about twice that of the moon, and two-thirds that of Mercury. Also the coefficient of the large inequality that depends on Titan's eccentricity is found as  $12.96^\circ$ , not differing much from the value  $14.0^\circ$  found by H. Struve from observation.

The researches made by Dr. Woltjer form a useful step in the attainment of a complete theory of Hyperion's motion, and it is to be hoped that he will himself continue the work, carrying it far enough to include all sensible terms.

A. C. D. CROMMELIN.

*A Field and Laboratory Guide in Physical Nature-study.* By Prof. Elliott R. Downing. (The University of Chicago Nature-study Series.) Pp. 109. (Chicago, Illinois: The University of Chicago Press; London: The Cambridge University Press, 1920.) Price 1 dollar net.

AT first sight it is difficult to decide whether the book was written for children or for adults—in its assumption of previous knowledge it is hopelessly above the one; in its treatment it is far beneath the other. The preface explains that it is meant for pupil teachers. Directions are given for the making of model aeroplanes, the spinning of tops, etc. But if a youth has missed these delights in his childhood, it is of little use for him to try to find them later on. In training a student to teach children there is no need to treat him as a child himself. Nevertheless, the book is full of good ideas, and many who would find it almost intolerable to use as a laboratory manual would be well repaid for time spent in reading it through.

NO. 2648, VOL. 105]

## Letters to the Editor.

[The Editor does not hold himself responsible for opinions expressed by his correspondents. Neither can he undertake to return, or to correspond with the writers of, rejected manuscripts intended for this or any other part of NATURE. No notice is taken of anonymous communications.]

### Genera and Species.

WHEN Linné introduced the practice of giving a generic and specific name to each living organism he probably did not anticipate that the number of names required would run into millions, and with the multiplication of genera and species now encouraged by naturalists some other system of distinction seems desirable.

Of the five or six thousand stars visible to the naked eye only a few have been named, and the rest have to be content with identification by their constellations and by a letter or number.

Something of the same sort might be done for the organic world. The conspicuous and typical examples might retain their names, while both to these and to the remainder a letter or number might be allotted.

If the numbers followed the chronological order in which the species were discovered or first properly described, a catalogue formed on these lines would in itself convey valuable information.

Identification by number or symbol would act as a check to the coining of many barbarous words, and also to the annoying repetition of the same specific names in different genera. All true classification should be genealogical—that is, it should depend on the ancestry of the organism classified. Existing knowledge is insufficient to achieve such an ideal result, but any system not founded on pedigree is open to the objection of not being "natural."

There are often great doubts as to where varieties end and species begin, and where such doubt exists it would, in general, be safer to assume that differences are varietal until it has been found by trial that continued interbreeding tends to produce sterility.

I am informed by authorities well acquainted with the West Indies that this is what happens when half-breed is crossed with half-breed, but not when half-breed mates with white (or better, with black). So far as this evidence goes, it points to something approaching a specific difference between the white and the negro, and many species have been determined on a worse foundation.

Books on special branches of natural history, while giving some sort of description of the various genera and species, do not (there are a few honourable exceptions) indicate, or indicate very imperfectly, the grounds on which the generic or other distinctions rest, and it is not uncommon to find differences between admitted varieties of the same species exceeding those between species reputed to be separate.

To find the reasons for these apparent anomalies by consulting the original papers involves the expenditure of much time and trouble, but the information might be compressed into a small space if properly tabulated.

A. MALLOCK.

9 Baring Crescent, Exeter, July 17.

### The Cluster Pine.

*Pinus pinaster* was probably introduced into Madeira about thirty years before the beginning of the nineteenth century—a hundred years too late to save from wanton extinction the forests of mountain laurel, *Cerasus*, *Persea*, juniper, and many a species exclusively Madeiran.

There is a settled method of cultivation. The steep hillsides, ridge, and valley, after the yearly autumn

rares, are made ready to receive the seed which in November and December is scattered broadcast, mixed with wheat and lightly covered over after heavy rain. The green seedlings appear in a few weeks, but there is no tangible development until the wheat is taken away and the decaying stalks have become available as plant-food, and perhaps advantageously helped by a thin surface-dressing of sawdust.

A Pinaster plantation soon becomes productive, yielding in the first years substantial bedding for cattle and, mixed with dried gorse bushes, excellent material for the ovens in the village bakehouses. In four or five years the crop will yield abundantly supporting stakes, 6-8 ft. long, for the climbing beans on which the Madeira peasant so largely depends for his winter food, and, yearly afterwards, sturdy poles in ever-increasing dimensions for the construction of the fascinating trellises in the famous vineyards at a lower level. In twelve or fifteen years the trees have attained the stage of firewood, and, with the exception of a few selected pines left for timber, the ground is once more cleared for planting afresh. The tree-stumps are mostly grubbed up, but those left quickly decay in the ground, and the Pinaster throws up no fresh shoots after cutting. The young Pinaster has a distinct tap-root, but the roots of the mature tree spread in a superficial mat, twining fantastically along the surface among the protruding rocks. In digging the foundations of a lofty tower I met with no roots deeper than 4 ft.

No attempt has hitherto been made to deal with the abundant store of turpentine and resin with which in this region the Pinaster is endowed; and up to the present time the plantations have not suffered from the blights and diseases to which the species is subject elsewhere.

Much Pinaster seed is imported from Portugal, as less costly than collecting locally, but the full-bodied, delicately winged seed from a mature tree is in every way preferable, and to procure it a young, supple-limbed mountaineer will not hesitate over the perilous ascent of the huge trunk, bare of branches 70-80 ft. from the ground. A frail ladder made of ivy-stalk serves his purpose, pegged by segments into the crevices of the rough bark, and on reaching the first horizontal branch the intrepid fellow will pass down a string to a companion and draw up a long pine sapling, and with this, clambering out upon the branch, he will beat down the cone clusters with their prolific crop. Once in three or four years sufficient cones have developed to tempt the climber to this giddy and blood-curdling enterprise, and the seeds are beaten out in a few days when the sunshine has sufficiently opened the cones. The seeds then become the property of the pine steeplejack, the handsome, cinnamon-coloured cone, with the substantial residuum of unextracted seeds, remaining with the landowner.

Pinaster timber of mature growth is a handsome and useful wood, though more difficult to work than the imported deals from America and Norway. I possess some substantial floors which show no signs of decay after thirty years' service.

For general purposes Pinaster is far the most serviceable conifer yet seen in Madeira, and its quick growth, its prolific yield of cones and seeds, and its hardy nature and easy cultivation have given the species a popular pre-eminence which is well established.

Thirty years ago I introduced *Pinus insignis* and made important plantations. One or two of these trees, now twenty-seven years old, stand more than 100 ft. high, with a sturdy corresponding bulk, constituting, with their longer, softer, light green, three-sheathed needles, a handsomer and more attractive

form than seen in the Pinaster. But though of equally rapid growth, the cultivation requires more care than the Pinaster; neither is the tortuous-fibred wood regarded with favour by the working carpenter.

*P. pinaster*, *P. canariensis*, and *P. insignis* all hold their cones for indefinite periods, but the Himalayan *P. longifolia* sheds all its produce in September, leaving nothing but the embryonic promise of next year's crop, the substantial development of the large cones with their resinous, club-ended bracts occupying only seven months.

I cannot close this account without a reference to *Cupressus macrocarpa* and *C. goveniana* as recent accessions of great promise to the Madeira show of conifers; and some mention is also due to the Douglas fir, *Taxodium sempervirens*, etc., stately examples of which adorn our mountain-gardens.

Madeira, June 29.

MICHAEL GRABHAM.

### The Training of Practical Entomologists.

THE increasing demand for fully trained economic entomologists was, I think, evident to all who followed the proceedings of the recent Imperial Entomological Conference held in Burlington House. We are faced with the difficulty of ensuring an adequate supply of keen and experienced young men fitted for service in India, the Soudan, and other of the British dominions wherever the requirements may be greatest. The solution of economic problems in entomology is far more difficult than is commonly supposed, and only men of the broadest biological training, coupled with the gift of imagination, are likely to achieve results of lasting value to the community. Under present conditions they are frequently called upon to take up responsible positions after inadequate training and with only a modicum of practical experience. In the training of an economic entomologist two obvious pitfalls have to be avoided: one is a too exclusively academic or laboratory experience, while the other is a too specialised training in economic entomology at the expense of the necessary preliminary grounding in general biology.

The majority of practical entomologists become attached to an agricultural department, a smaller number enter a forestry department, and it is evident, therefore, that they need to acquire some knowledge of the principles and practice of either agriculture or forestry. The time at a student's disposal is an important factor, and the majority of men can usually only devote four years to training prior to turning out and earning their living. Let us take, for example, the course of a student at Cambridge. If he possesses good abilities, he should be able to take Part I. of the Tripos at the end of the second year and obtain his preliminary grounding in biology and chemistry, and I would suggest that the remaining two years should be devoted to entomology *plus* agriculture. The diploma course in agriculture might well be modified to suit such students, allowing them to devote as much time as possible to entomology, and confining the agricultural training, so far as may be feasible, to a knowledge of the soil and crop cultivation, omitting the greater part of the course dealing with stock and animal nutrition. In so far as entomology is concerned, I would advocate the first year (or the student's third year) being devoted entirely to what may be termed the scientific side of the subject. The second year (or the student's last year) should be given to as full a training as possible in economic entomology with the necessary field work. He should be given every opportunity for observing the common pests in the field and the methods of dealing with them. I strongly advocate every student also being given an independent piece of life-history work to



follow out, in order to acquire methods of accurate observation and technique. This work should be written up and modelled in the form of a scientific paper, and illustrated so far as may be desirable. By means of such an essay the student will become familiar with the elementary procedure in research work, he will acquire some power of independent observation, and learn how to deal with entomological literature, thus gaining some idea of the sources where he will find first-hand information.

Furthermore, I would also insist upon the student forming a small but thoroughly representative collection of insects, so proving that he has had some field practice in collecting, and is able to refer them to their families and genera. By means of such a course as I have outlined, it should be possible to train good, all-round entomologists, capable of tackling a problem unaided when out in the wilds of Africa or the plains of India.

If the student can spare a fifth year, it would be all to his advantage, and the time would be most profitably spent in prosecuting some line of independent entomological research.

A. D. IMMS.

Institute of Plant Pathology, Rothamsted  
Experimental Station, Harpenden.

**The Separation of the Isotopes of Chlorine.**

In order to prevent confusion of issues, instead of Cl and Cl' let us write A and B. Then when we say that A and B are identical, we mean that all the properties of A and B are the same except that of position occupied. Thus we are enabled to divide the atoms into two groups, the A group and the B group, in spite of their identity of properties. Then it is quite certain that if the atoms exist as molecules A<sub>2</sub>, B<sub>2</sub>, and AB, in equilibrium by the reversible reaction A<sub>2</sub>+B<sub>2</sub>⇌2AB, the equilibrium is given by  $\frac{[AB]^2}{[A_2][B_2]}=K=4$ .

The following considerations will, I think, meet any difficulties that have been raised in reconciling this reaction with Nernst's heat theorem. In the case of complete identity, if we convert the solids A<sub>2</sub> and B<sub>2</sub> into the solid AB by evaporation to the gases A<sub>2</sub>, B<sub>2</sub>, transformation into the gas AB, and condensation to the solid AB, we obtain an increase of entropy of R log 4. But this solid is really a solid solution or mixture, since, as we assumed that the vapour pressure over it is equal to the pressure over the solids A<sub>2</sub> or B<sub>2</sub>, we must assume that the molecules condense on its surface with "longitudinal indifference." The solid, then, is a solution of the molecules AB in BA.

Now the entropy of a body consists of two parts, one depending on the distribution of velocities, the other on the distribution of the co-ordinates of position. The first term cannot give rise to any change of entropy when the solids are transformed, irrespective of Nernst's theorem, but the second term is a constant, and accounts for the change of R log 4. It may, in fact, be calculated directly by statistical methods.

If we assume that the gas AB condenses to the solid AB (or BA) instead of into the solid solution, then we must take the pressure over this solid as double that over A<sub>2</sub> or B<sub>2</sub>, and not equal to them; because, consistently with the assumption of the formation of the pure solid AB, we must assume that the solid rejects half the molecules which strike its surface; that is to say, the molecules AB condense, but not the molecules BA.

This double vapour pressure will make the entropy of the two gram-molecules of AB (or BA) equal to the entropy of one gram-molecule of A<sub>2</sub> plus one gram-molecule of B<sub>2</sub>.

No essential difference in the argument is made when A<sub>2</sub> differs slightly from B<sub>2</sub>.

Prof. Soddy throws out a suggestion for the removal of the term R log 4 which surely must be erroneous. He seems to agree to the distribution of molecules given by  $\frac{[AB]^2}{[A_2][B_2]}=4$  (which must result whatever kinetic process be assumed), but he considers it wrong to write 4 as the equilibrium constant of the reaction A<sub>2</sub>+B<sub>2</sub>⇌2AB, as this gives for the coefficients of the reaction velocities  $k_1=4k_2$ . He therefore would write the reaction A<sub>2</sub>+B<sub>2</sub>=AB+AB, and then, taking half the concentration of AB, write  $\frac{1}{2}[AB][AB]/[A_2][B_2]=K=1$ . Therefore  $k_1=k_2$ .

To write this reaction in this form is unjustifiable. In the first place, that  $k_1=4k_2$  in no way contradicts the assumption of the identity of A and B. For the velocity coefficients do not depend only on the properties of the atoms or molecules involved, but contain a factor depending on the statistics of the reactions. In this respect the direct and reverse reactions may be different. This is better seen by comparing the two reversible reactions 2A=A<sub>2</sub> and B+C=BC, where A, B, and C are identical atoms. The two reverse coefficients are equal,  $k_2=k_2'$ , but the two direct coefficients are not equal, for  $k_1=\frac{1}{2}k_1'$ . This is because n atoms B, together with n atoms C, give twice as many B-C collisions as n atoms of A give A-A collisions. If we write the reaction A+A⇌A<sub>2</sub>, and take half the concentration of A, we still do not find  $k_1=k_1'$ , but  $k_1=2k_1'$ .

In the second place, to write the reaction A<sub>2</sub>+B<sub>2</sub>⇌AB+AB suggests that we can divide the molecules AB into two equal sets, and that a significant collision only occurs when an AB molecule from the first set collides with an AB molecule from the second set. Finally, the semi-permeable membrane that may be used in calculating the change of entropy due to the gaseous reaction must be assumed permeable to all or none of the molecules AB, thus giving an entropy change R log 4. So that by no considerations whatever are we justified in taking half the concentration of the AB molecules when calculating the change of entropy. ANGUS F. CORE.

The University, Manchester, July 24.

**Anticyclones.**

PROF. HOBBS in NATURE for July 22 gives some experimental reasons for contending that over large ice-covered areas, such as exist in Greenland and the Antarctic continent, the cooled lower layer of air moves outwards in all directions from the centre of the ice-covered area. Under the influence of the earth's rotation the air thus set in motion is regarded as circulating as in normal anticyclones, and Prof. Hobbs on that account speaks of such areas as being anticyclonic. He remarks: "The centrifugal nature of this motion tends to produce a vacuum above the central area of the ice mass, and the air must be drawn down from the upper layers of the atmosphere in order to supply the void. It is here that is located the 'eye' of the anticyclone." He thus postulates an anticyclone with a low-pressure centre.

With the physics of Prof. Hobbs's theory there need be little criticism. The point really seems to be: Are the conditions described by him as existing over an ice-cap anticyclonic? An anticyclone has a high-pressure centre, and a cyclone a low-pressure centre, the surface air moving outwards in the former and inwards in the latter, whereas the conditions described by Prof. Hobbs are an outward flow and a low-pressure centre. Would it not be well to designate such conditions by some other word?

R. M. DEELEY.

Tintagel, Kew Gardens Road, Surrey, July 23.

## Solar Variation and the Weather.

By DR. C. G. ABBOT, Director, Smithsonian Astrophysical Observatory.

NEARLY a century ago three pioneers, Sir John Herschel, Pouillet, and Forbes, laid the foundations of the measurement of solar radiation. Each devised an instrument for measuring the heating effect of the solar rays and used it diligently. Pouillet and Forbes availed themselves of the law of extinction of light, which had been independently discovered about 1760 by Bouguer and Lambert, to calculate the intensity of the solar rays, as they would be outside our atmosphere. Forbes's researches in the Alps proved that this law is not strictly applicable to the sun's rays as a whole, and he was led to believe that the value of the so-called solar constant of radiation was as high as 2.85 calories per sq. cm. per min. Pouillet's value, based on the assumed validity of the Bouguer-Lambert law, was 1.76 calories.

As pointed out by Radau, the problem of estimating the intensity of the solar heat outside our atmosphere requires the study of the various spectrum rays separately, because their transmission through the atmosphere is unequal. Langley invented the spectro-bolometer about 1880, and immediately applied it to the problem as analysed by Radau. In the famous Mount Whitney expedition of 1881 Langley carried on spectro-bolometric and pyrheliometric measurements simultaneously at an altitude of 12,000 ft. Misled by certain theoretical considerations, however, these experiments seemed to him to yield the value 3.07 calories per sq. cm. per min. as the most probable value of the solar constant of radiation. A correct reduction, which he also gave in his report, yielded 2.22 calories. Later experiments made on Mount Whitney and on Teneriffe indicate that while the spectro-bolometric work was good, Langley's pyrheliometric determinations were too high, so that the true result should have been 1.9 calories.

Up to that time no fully satisfactory instrument for measuring the intensity of solar heat at the earth's surface had been perfected. About 1893 Prof. Knut Ångström's highly ingenious electrical compensation pyrheliometer fixed the scale of solar radiation measurements surely within 5 per cent. In recent years the accuracy of the Ångström pyrheliometer has reached to 2 per cent. or better. In 1913 three independent series of determinations at the Smithsonian Institution fixed the standard scale of radiation measurements now generally adopted. The Ångström scale as corrected by A. K. Ångström lies 1.8 per cent. lower.

At Washington, under Langley's direction, the spectro-bolometer, which at the time of the Mount Whitney expedition was almost unmanageable, was perfected in the decade 1890-1900 into a tractable, trustworthy instrument, and made to trace photographically an autographic solar spectrum energy curve extending from wave-length 0.3 micron to 3.0 microns within 10 minutes.

In the autumn of 1907 experiments were begun

in Washington to fix a standard procedure for solar constant observations. Omitting minor details, the process which resulted is as follows: Beginning when the sun is near 15° above the horizon, about six solar spectrum energy curves, and simultaneously pyrheliometric measurements, are made, ending when the sun's altitude has reached about 60°. These curves are measured at about forty points corresponding to known wave-lengths from far in the ultra-violet to far in the infra-red. Taking each wave-length by itself, these intensities on the six separate curves follow the Bouguer-Lambert law of extinction. Hence plotting the logarithms of measured intensities as ordinates and corresponding values of the secants of the solar zenith distances as abscissæ, each group of six points determines a straight line. Producing this line to zero of abscissæ—that is, to the line corresponding to no atmosphere at all—we read there the logarithms of the intensity for the various wave-lengths, as the energy curve would be found outside our atmosphere—on the moon, for instance. The scale of energy in calories per square centimetre per minute comes by comparing the total area included under the spectro-bolometric curves with pyrheliometer readings taken simultaneously. Such, in brief, is the process.

Determinations were begun at Washington in October, 1902. In the springtime of 1903 a large drop amounting to nearly 10 per cent. was found in the values after the end of March. The changed values persisted so steadily that we were led to entertain the hypothesis that the solar radiation had actually diminished. A comparison was made between solar heat and terrestrial temperatures. It actually appeared that just after the apparent drop in solar radiation there occurred a general drop in terrestrial temperatures for all available stations of the north temperate zone. This led us to the long campaign of solar radiation observations which I shall now describe.

In 1905 we began sending yearly expeditions to observe solar radiation at Mount Wilson, California, also the seat of the famous Mount Wilson Solar Observatory of the Carnegie Institution. I am happy to acknowledge the great assistance and enthusiastic interest which Dr. Hale and his colleagues have at all times given our work there.

From the first the Mount Wilson values, though far more accurate than Washington values, owing to the clearer and more uniform sky conditions of California, showed on their face a variability over an extreme range of 10 per cent. in the emission of solar radiation. The sun appeared to be a variable star having a twofold type of variation: First, a fluctuation with the march of years attending changes in solar activity as indicated by sunspots, faculæ, prominences, etc.; secondly, a fluctuation running its courses in a few days, weeks,

or months. Both types of variation are highly irregular. The longer-period type appears to reach 4 per cent. for 100 Wolf sun-spot numbers. The shorter-period changes are larger, and often amount to 3 or even 5 per cent. in a week or a fortnight. Sometimes they reach 10 per cent.

In order to test the validity of these apparent solar changes, we secured nearly simultaneous observations at Washington (sea-level) and Mount Wilson (1730 metres). Also in 1909 and 1910 at Mount Wilson and Mount Whitney (4440 metres) close agreement of results was found. Then in 1911 and 1912 we observed nearly simultaneously for several months at both Mount Wilson and Bassour, Algeria (1160 metres). Both Mount Wilson and Bassour indicated a range of solar variation of nearly 10 per cent. The coefficient of correlation between their indications in 1912, according to Mr. Knox Shaw's determination, is  $+58 \pm 7.9$  per cent. Thus our view of the sun's short-period irregular variation was confirmed by the agreement of these results from two stations separated by one-third of the earth's circumference.

Since then we have confirmed the solar variability in many ways. Most convincing, perhaps, is the variation we have found in the distribution of radiation over the sun's disc attending changes in the solar radiation. As is well known, the sun's centre is brighter than its edges. We find that the contrast of centre to edge changes from day to day and from year to year. These twofold changes run in opposite senses with respect to increased solar radiation, and seem to indicate that the cause of the solar variation of long period is the hotter sun attending increased circulation at sun-spot maximum, while the short-interval changes are caused by changes of transparency of the sun's outer layers.

In 1918 the Smithsonian Institution established a station at Calama, Chile, supposed to be one of the earth's most cloudless regions. We have been disappointed in the degree of cloudlessness,

but our young men have observed the "solar constant" there on about 75 per cent. of all days since July 27, 1918. Comparisons with Mount Wilson in 1918 gave a "probable error" for one determination at a single station of 0.0111 calorie, or about 0.6 per cent. The Calama values have ranged from 1.884 to 2.028 calories, or 7 per cent.

Mr. H. H. Clayton, chief forecaster of the Argentine Meteorological Service, has compared all the Mount Wilson and Calama solar observations, 1905 to 1920 inclusive, with the temperatures and rainfall of Argentina. He finds a high degree of correlation between them. The subjoined table shows Clayton's comparison of the average marches of temperature in Buenos Aires for the years 1913, 1914, 1915, and 1918 (1916 and 1917 were not available to him), correspond-

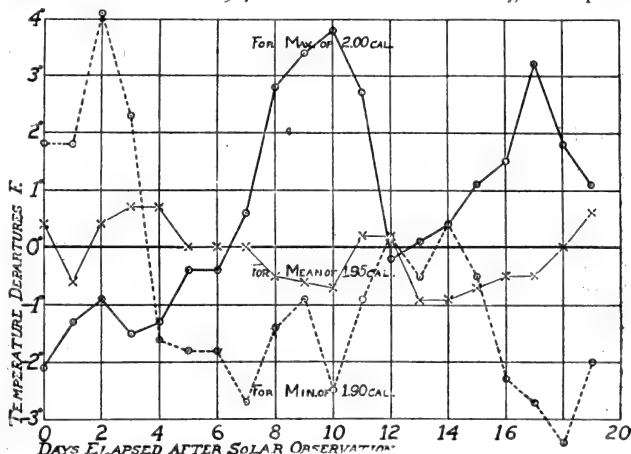

FIG. 1.—The prolonged influence of solar changes on terrestrial temperatures. The three curves show the average march of temperature departures at Buenos Aires, as published by Mr. H. H. Clayton, for nineteen days next following days of maximum, mean, and minimum solar radiation in the years 1913, 1914, 1915, and 1918 for the months May to November. The solar observations were made by the Smithsonian Astrophysical Observatory at Mount Wilson, California, more than six thousand miles from Buenos Aires. The curves marked "Max.," "Mean," and "Min." correspond respectively to mean values of the "solar constant" of 2.00, 1.95, and 1.90 calories per square centimetre per minute.

ing to all the occasions when the solar constant values observed at Mount Wilson fell between the stated limits. The deviations of temperature are expressed in tenths of degrees Centigrade, and range from  $+2.0^{\circ}$  to  $-1.5^{\circ}$  C. from the normal. The extreme and mean results are given also, translated into Fahrenheit, in Fig. 1.

*Derivations from Normal Temperature in Buenos Aires following Different Intensities of Solar Radiation (May to November).*

Solar radiation values in gram-calories per cm. <sup>2</sup> per min.	0	1	2	3	4	5	6	7	8	9	10	11	12	13	14	15	16	17	18	19
2.000 ± 0.010	-12	-7	-5	-8	-7	-2	-2	3	15	16	20	14	-1	1	2	6	8	17	10	6
1.980 ± 0.010	-1	-6	-2	-1	-8	0	6	9	9	5	5	4	-1	-4	-5	-1	-2	-3	-3	5
1.960 ± 0.010	2	9	4	0	-2	-2	-2	0	-2	-2	-4	-5	-1	-4	-5	-1	-2	-3	-3	2
1.940 ± 0.010	2	-2	1	7	9	2	2	0	-3	-4	-3	7	2	-5	-5	-6	-3	-3	3	2
1.920 ± 0.010	9	0	-4	-4	-6	-4	-9	-5	-2	0	3	3	5	6	3	-5	-3	-7	-5	1
1.900 ± 0.010	10	10	23	13	-9	-10	-10	-15	-8	-5	-14	-5	1	-3	2	-3	-13	-15	-19	-11

It is very striking that the solar changes produce such large and prolonged temperature effects. On the tenth and seventeenth days after the event the average temperature following solar constants of 2.00 calories differs by more than 6° F. from that following solar constants of 1.90 calories.

The temperatures following minimum "solar constant" values are generally lower than the normal from the third to the nineteenth day; they are above the normal before the third day; while those following high values are above the normal from the sixth to the nineteenth day, they are below the normal before the sixth day; and those corresponding to mean "solar constant" values differ by little from the normal through the whole interval.

The latter state of affairs is probably decidedly

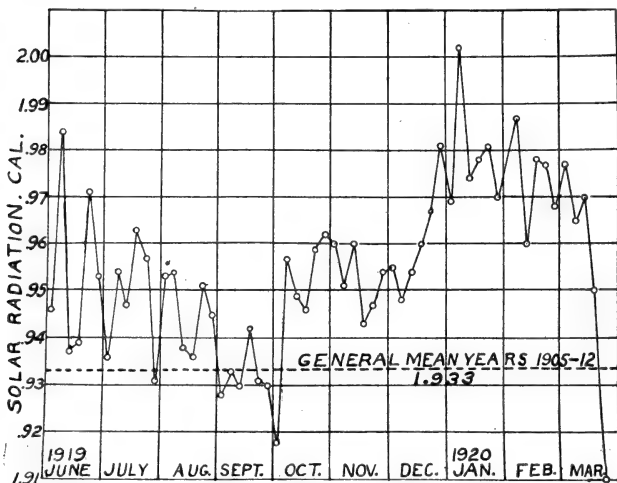

FIG. 2.—Five-day means observed at Calama, Chile, 1919-20.

modified at other times of the year, for Mr. Clayton finds the following correlation coefficients connecting the temperature departures at Buenos Aires eight to nine days after the event with the solar radiation variations observed at Calama from August, 1918, to May, 1919.

Jan.	Feb.	March	April	May	June
-0'49	-0'20	+0'18	+0'23	+0'33	—
July	Aug.	Sept.	Oct.	Nov.	Dec.
—	+0'20	+0'26	-0'23	-0'29	-0'33

Taking these figures with the figures given above, we are to conclude that while on the first three or four days after the event high solar radiation tends to produce high temperatures in Buenos Aires from October to February, the opposite tendency governs March to September.

These reversals of solar variation effects with the time of the year are paralleled by reversals with geographical position, according to Clayton, who was at first led to regard these geographical reversals as zonal. But it now seems more probable to him, I think, as well as to Nansen, that they are associated with the great atmospheric-action centres rather than with the earth's zones. As these action centres change place from time to time, it seems possible that the geographical and secular reversals merge as effects of one general cause. While it may seem extraordinary at first sight that the past winter has been exceptionally severe (at least in Eastern United States), though solar constant values have been steadily exceptionally high from early in October to February, this may be compared with the known fact that when there are many sun-spots high solar radiation and low temperatures also occur together. Unusual cloudiness or prevailing polar winds may well account for low temperatures associated with high radiation.

Clayton's studies have led him to a system of forecasting in which telegraphic reports of daily solar constant values as obtained by Smithsonian observers at Calama, Chile, take a prominent part. He claims decided and valuable success for both temperature and precipitation forecasts.

If these pioneer results should be confirmed it seems highly desirable to establish several other solar constant observatories in the most cloudless far-separated regions of the earth. By telegraphic communication all their results would be available for daily forecasts all over the world. The cost of such stations fully equipped

need not exceed 25,000 dollars for the most inaccessible. The yearly cost of maintenance need not exceed 10,000 dollars. It is now merely the complete lack of funds for the purpose which withholds the Smithsonian Institution from establishing them.

Fig. 2 shows the march of "solar constant" results from June 1, 1919, to March 24, 1920. In no other period since 1903 has there been observed three consecutive months of values so high as those of the winter of 1919-20. The following rapidly falling values accompanied the extraordinary solar and terrestrial phenomena of March 22, 1920:—

#### Solar Radiation Values of March, 1920.

Mean	Date 11	12	13	14	15	16	17	18
Value	1'968	1'954	1'940	1'931	1'941	1'927	1'866	1'905

The Earliest Known Land Flora.<sup>1</sup>

By PROF. F. O. BOWER, F.R.S.

THE vegetable kingdom is made up of plants of most varied size, character, and habitat. Comparing those various types, the view becomes ever more insistent that dependence on water is the master-factor determining their existence. As we range their diverse forms according to probable sequences of descent, those which we regard as the most primitive according to their structure and mode of reproduction are those which are habitually the most dependent upon constant water supply. It is the same with the animal kingdom. These broad results were summed up by Weismann some forty years ago in the statement that the birth-place of all animal and plant life lay in the sea. If this be true, it follows that all life on exposed land-surfaces has been secondary, and derivative.

Geologists tell us that from the remote past land-surfaces have stood exposed above the level of the ocean. The continents and islands may have differed from time to time in their outline and area from those of the present day. But we may believe that from a very early period land-surfaces have had a continuous existence, so that life upon land may itself have been continuous from the time when living organisms first emerged from their natal waters. Such beliefs throw back to the very remote past the possible origin of life upon dry land. But still the probability remains that aquatic life antedated that event. These considerations lead inevitably to the questions: When was dry land first invaded from the water? What were the first land-living plants and animals like? And how did they rank as compared with modern life?

Leaving zoologists to solve these questions for their own branch, we botanists are to-day in a better position than ever before to answer them with regard to plants. Though still far from being able to visualise the beginning of the story, recent discoveries have made it possible to see clearly and in detail the nature of the earliest known land flora, which is that of a period older than the Upper Devonian. During recent years fossil plants of early Devonian age have been found in Sweden and in Scotland in greater profusion than ever before, while the Scottish specimens are so well preserved that they are now almost as well known in structural detail as plants of the present day. Already in this room repeated lectures have been given on the Palæozoic flora. Many plants of the Carboniferous Period have been described here in microscopic detail, and they are mostly referable to affinity with such living types as ferns, club-mosses and horsetails. Some, such as the Sphenophylls and Pteridosperms, represent classes which have since died out. But, speaking generally, the flora of the coal is composed of plants comparable with

the lower vascular plants now living. They possessed stems, leaves, roots, and sporangia. Some even produced seeds like modern Gymnosperms.

Passing back from the Carboniferous period to the Upper Devonian, the flora, though more restricted, may still be described in terms applicable to the living vegetation. The plants include among others the gigantic fern-like *Archaeopteris hibernica*, from Kiltorkan, co. Kilkenny; the large Lycopod *Bothrodendron*, from the same source; and the large-leaved *Pseudobornia*, from Bear Island. Flat leaf-expansions are here seen, and the plants named have been referred in their general characters respectively to affinity with the ferns, club-mosses, and horsetails. But between the Upper Devonian and the strata that lie below geologists tell us that a vast period of time intervened. The evidence of the plant-remains supports this. The earlier Devonian fossils so far known are meagre in number of forms. In their characters they differ more markedly from the plants of the present day than any of their successors. They were rootless, and there appears to be a complete absence of large, flattened leaf-expansions. It is upon them that the new discoveries have shed so interesting a light. Conversely, that light is reflected back by comparison upon the more recent forms. In fact, a new chapter has been opened in plant-morphology, and a new class of vascular plants, the Psilophytales, has been established to receive these representatives of the oldest known land flora. The study of them is leading to new interpretations of the form shown by plants of later periods, and ultimately of the present day.

Until 1913 the plants of the early Devonian rocks were very imperfectly known. Their recognised characters were chiefly negative. There was no evidence of broad leaf-surfaces, nor was it clear whether or not they bore leaves as distinct from stems. The existence of true roots was also doubtful. The best known plants were constructed of approximately cylindrical stalks bearing lateral spines. These stalks arose from a branched and creeping base. Some of them showed crozier-like curves when young, and sporangium-like bodies were sometimes found upon them. The most distinctive of these plants were grouped by Dawson in his genus *Psilophyton*, and he published a reconstruction of the species *P. princeps*. It was, however, the subject of adverse criticism by his contemporaries, and the validity of the genus was questioned.

It was upon a field so open as this that light has now been shed. From fresh-water deposits of early Devonian age round Lake Rörågen, on the frontier between Norway and Sweden, Dr. Halle collected many specimens of fossil plants. But they were mostly impressions, and showed only imperfect preservation of their microscopic

<sup>1</sup> Discourse delivered at the Royal Institution on Friday, April 30.

structure. He distinguished several genera of plants with branched cylindrical stems bearing small thorn-like appendages, and some of them distal sporangia. Many of his specimens were referred to *Psilophyton princeps*, and bore out in the main the reconstruction of Dawson. Halle was able to confirm the existence of a central vascular strand in *Psilophyton*, consisting of tracheides, a fact which ranks it with certainty among vascular plants of the land. But the most distinctive novelty which Halle discovered in the Rörägen beds was a fossil which he called *Sporogonites*. It consisted of a simple stalk bearing a terminal capsule. From its form, and the character of its contents, he held it to be a sporogonium comparable with that of the Bryophytes; but a generalised type, not referable to any exist-

the new observations of early Devonian plants in Scotland was recorded. Dr. Mackie, of Elgin, found at Rhynie, in Aberdeenshire, certain isolated blocks of chert containing plant remains. A little later the source of these blocks was traced to a bed of chert, older than the Upper Devonian, found *in situ* by the Scottish Geological Survey. Its origin appears to have been this. An exposed land-surface existed there in Middle or Lower Devonian time, subject to intervals of inundation. It became periodically covered by vegetation. By decay of its stems and underground parts a bed of peat would be formed. The peat was then flooded, and loose sand deposited over it. Again the vegetation was repeated, and so successive bands were formed to some 8 ft. in thickness.

Then followed water with silica in solution, supplied from some fumarole or geyser. The peat-bed was thus sealed up, and the plants preserved with astonishing perfection.

From this bed of chert four distinct vascular plants have been recognised, and described in the minutest detail by Dr. Kidston and Prof. Lang. They are all essentially similar in type, though sufficiently different to be placed in three genera, named respectively *Rhynia* (two species), *Hornea*, and *Asteroxylon*. *Rhynia* and *Hornea* are leafless and rootless, while *Asteroxylon* is also rootless, but it bears leaves of a simple type. The plants thus clearly indicate



Photo]

[Dr. Kidston.

FIG. 1.—Vertical section through the protocorm of *Rhynia Lignieri* with rhizoids, embedded in peat ( $\times 14$ ).

ing group of them. An alternative suggestion was that *Sporogonites* may represent only the upper part of a more highly developed sporophyte, perhaps on the line of descent of the Pteridophytes. Thus the presence of *Sporogonites* does not actually prove the existence of Bryophytes as we now know them in the early Devonian rocks. But nevertheless it has a peculiar interest. Hitherto there has been no certain record of the existence of any moss-like type in the Palaeozoic period. The demonstration of so moss-like a sporangium as *Sporogonites* is certainly the most thrilling of the facts brought forward by Dr. Halle.

In 1913, three years before Dr. Halle's publication of these discoveries at Rörägen, the first of

a primitive state prevalent at that period. They conform in general features to the type of *Psilophyton* as described by Dawson, and as recognised in greater detail by Halle. But here in the Rhynie chert the structural details are so well preserved that these earliest of all known vascular plants can be examined and described almost as well as any modern living plants. Some have even been found standing erect as in life. Through untold ages, like the legendary Knights of the Round Table, they have thus awaited the revivifying touch of modern science.

Of the four plants so far described from the Rhynie chert, *Hornea Lignieri* is relatively simple. From a distended and lobed protocormous base rose the stems, which bifurcated. These bore

distal sporangia, which represent their transformed tips. Sometimes the sporangia were themselves forked. The protocorm was bedded in the peat, and parenchymatous, with many rhizoids (Fig. 1). The cylindrical stems stood upright from it, and were about 2 mm. in diameter. They were traversed by a simple stele with a solid core of tracheids, surrounded by phloem. The stele forked at the dichotomies of the stem, but stopped short at the base of the sterile columella, which ran upwards into the flat-topped, and apparently indehiscent, sporangium. The latter appears as a transformation of the end of the stalk, which is simply an ordinary branch of the plant. The spores are tetrahedral, as they are in all of these plants of the chert. The general aspect of *Hornea* is such as to provoke comparison with the Bryophytes, notwithstanding certain strongly divergent characters. This may have some real sig-

thing in the nature of appendages. The upright stems bifurcate as before, bearing distal sporangia similar to, but smaller than, those of *R. major*. But near to their base there are "hemispherical projections," apparently of superficial origin. Some of these gave origin to tufts of hair, but others produced adventitious branches, which, having narrow bases, were easily detached, and served as means of vegetative propagation. Though these organs are not easily ranked with those of living plants, they are something in advance of what is seen in *Hornea* and *R. major*. The sporangia are relatively small, and there is no clear evidence of their dehiscence.

The largest, as it is also the most complex, of these plants is *Asteroxylon Mackiei*. Its base

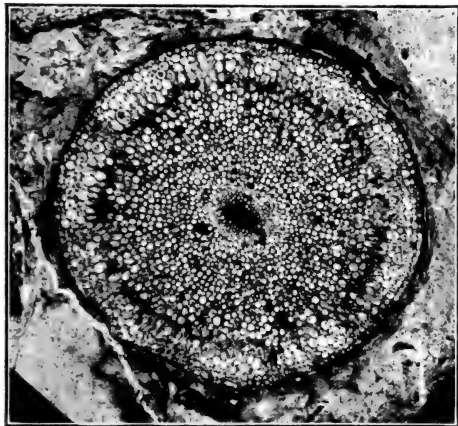

Photo] [Dr. Kidston.  
FIG. 2.—Aerial stem of *Rhynia major* seen in transverse section ( $\times 20$ ).

nificance in view of its small size, and relatively simple structure.

*Rhynia major* is larger and better preserved, but still it also is structurally simple. It had a less distended rhizome, from which the robust cylindrical stems arose. These consisted, as in *Hornea*, of a central stele with solid xylem-core and investing phloem, surrounded by a massive cortex, of which the inner region appears to have been photosynthetic. Outside was a well-marked epidermis with stomata. These and the vascular tissue prove the aerial habit of the plant (Fig. 2). The stems ended in solitary massive sporangia, as much as 12 mm. in length, without a columella, and filled with tetrahedral spores (Fig. 3).

Neither of the species described bore any appendages on its stems. But *Rhynia Gwynne-Vaughani*, though smaller than *R. major*, shows a feature of morphological advance towards some-



Photo] [Dr. Kidston.  
FIG. 3.—Sporangium of *Rhynia major* filled with spores ( $\times 34$ ).

consisted of branched rhizomes, which burrowed after the manner of Stigmarian rootlets, and each was traversed by a vascular strand with undifferentiated xylem; but curiously enough rhizoids are absent. These rhizomes passed over into upright aerial stems, which attained a diameter of as much as a centimetre, and had a complex structure. They forked, and bore externally small and simple leaves. The stele had a stellate xylem very like some Lycopods. From its rays issued strands passing to the bases of the leaves, but not entering them. As in *Lycopodium*, more than one vertical series of leaf-traces may issue from each

ray of the stellate xylem, a fact that confirms the Lycopod comparison (Fig. 4). Longitudinal

cortex of stem and rhizome often contain fungal hyphae. It is possible that in the rhizome these



Photo]

[Dr. Kidston.

FIG. 4.—Large stem of *Asteroxylon* cut transversely just below a dichotomy, and showing leaves attached externally ( $\times$  about 10).

sections show the relations of epidermis, cortex, phloem and xylem, and the way in which the inner

may have been concerned in mycoscliric nutrition. Higher powers demonstrate the tracheides as irregularly, or spirally, barred, but not scalariform. An endodermis has been seen delimiting the cylindrical stele, and mesarch protoxylem is found in the xylem-rays. The leaves are parenchymatous, the vascular strands stopping short at their bases. The epidermis has been found to bear very perfect stomata (Fig. 5). The essential points of structure of the plant are thus fully known.

In certain blocks sporangia have been found attached to profusely dichotomising stalks of simpler structure than the main stems of *Asteroxylon*, and not definitely attached to them. They are associated, however, with stems of *Asteroxylon*, while those of *Hornea* and *Rhynia*, from which they are structurally distinct, are absent from the blocks. The association makes it probable that these peculiarly forked branches and sporangia really belong to *Asteroxylon*. The sporangia are relatively small and pear-shaped, and they had a distal dehiscence. The whole plant of *Asteroxylon* was thus more advanced in various respects than any of the other three plants of the chert.

(To be continued.)



Photo]

[Dr. Kidston.

FIG. 5.—Stoma of *Asteroxylon Mackiei* in surface view ( $\times$  210).



## Obituary.

DR. ROBERT MUNRO.

WE regret to record the death, on July 18, of Dr. Robert Munro, the well-known Scottish archaeologist. Dr. Munro was born on July 21, 1835, and was thus within three days of completing his eighty-fifth year. By his death prehistoric archaeology loses one of its foremost exponents in this country; but his work will not readily be forgotten.

Munro was educated at Tain Royal Academy and at Edinburgh University. After practising medicine for some years at Kilmarnock, of which town his wife was a native, his increasing interest in archaeology led him to retire in 1886, in order to devote himself entirely to research in this branch of science. His name will always be associated in particular with the study of prehistoric lake and pile dwellings, a subject to which his attention was first directed in 1878, while on a visit to Zurich, when he took the opportunity of examining the prehistoric lake dwellings in the neighbourhood. Shortly after his return, the discovery of two canoes and wrought wood by workmen engaged in drainage work on the estate of the Duke of Portland at Locklee, Tarbolton, Ayrshire, suggested the possibility of fruitful results to be obtained from investigations on analogous sites in Scotland.

At the instigation of Mr. R. W. Cochran-Patrick, Munro undertook the exploration of this site, and in the two following years he investigated similar sites at Friar's Carse, Lochspouts, and Buston, all in the south-west of Scotland. Accounts of these investigations were published from time to time in the collections of the Ayrshire and Wigtownshire Archaeological Association, and a report on the excavation of the crannog at Friar's Carse appeared in the Proceedings of the Society of Antiquaries of Scotland, of which body Munro had been elected a fellow in 1879. The results were afterwards embodied in "Ancient Scottish Lake Dwellings," published in 1882, a book which, as the author said in his preface, sought "to place before the general reader a record of some remarkable discoveries recently made in the south-west of Scotland in a department of archaeology hitherto little known." In addition to giving the results of his own excavations, he summarised the somewhat scanty accounts of previous investigators in this field in Scotland, and the work of Boyd Dawkins and others in England.

After the appearance of this work, Munro's interest turned in an increasing degree to Continental prehistoric sites. Always a great lover of travel—he considered it his only form of recreation—he visited most of the important sites in Europe. Papers dealing with prehistoric remains in Holland, Denmark, Italy, Carinthia, and elsewhere appearing in the Proceedings of the Society of Antiquaries of Scotland and in other publications in the early 'eighties, and a book

describing a journey in Bosnia, Herzegovina, and Dalmatia published in 1895, bear witness to the extent of his travels and investigations. The publications of the earlier years were, however, merely a by-product while he was collecting the material for his most important work, "The Lake Dwellings of Europe," published in 1890, of which the substance had been given in his Rhind Lectures, delivered in 1888. In this book Munro made a complete survey of the subject, dealing in particular with the problems of the Swiss lake dwellings and the terramare settlements of Italy. In 1907, seventeen years after its publication, M. Salomon Reinach, in a preface to Modestov's "Introduction à l'histoire romaine," said of it: "Il n'y a qu'un livre récent sur les stations lacustres et les terramares de l'Italie; il a été écrit en anglais par un Écossais." A French edition appeared in 1908.

The results of subsequent discoveries, and in particular of discoveries on the terramare of Emilia, were embodied in the second part of "Palæolithic Man and Terramare Sites of Europe," published in 1912. This matter had formed the Dalrymple Lectures on Archaeology in the University of Glasgow in 1911; while the first part, which summarised our knowledge of palæolithic man at that date, had been delivered as the Munro Lectures in Anthropology in 1912, being the first course after the institution of the lectureship by the University of Edinburgh. In addition to the works already mentioned, Munro was the author of several other books, including "Prehistoric Problems" (1897), "Prehistoric Scotland and its Place in European Civilisation" (1899), "Archæology and False Antiquities" (1905), "Prehistoric Britain" (1914), a popular summary, and a number of papers which appeared at various dates in the Proceedings of learned societies and elsewhere.

In 1886 Munro's freedom from professional duties enabled him to undertake the secretaryship of the Society of Antiquaries of Scotland, an office which he held until 1899. In 1893 he was president of the Anthropological Section of the British Association for the Advancement of Science, and in 1903 he delivered one of the evening discourses at the meeting of the association at Southport. This discourse was published in 1904 under the title "Man as Artist and Sportsman in the Palæolithic Period." In 1894 he was appointed chairman of the research committee instituted in that year to conduct excavations on the site of the lake village at Glastonbury, other members of the committee being Sir John Evans, Gen. Pitt-Rivers, and Prof. W. Boyd Dawkins. More fortunate than two of his famous colleagues, Munro lived to see the completion of this important work in 1907, and continued to act as chairman when the committee's investigations were turned to the Meare lake village. He was part author of the monograph describing the

results of the investigations at Glastonbury, which was published in 1911-12.

The importance of Munro's researches was widely recognised. He was a fellow of the Royal Society of Edinburgh, and an honorary member of the Royal Irish Academy, of the Royal Society of Antiquaries of Ireland, and of the more important anthropological and archaeological societies of the Continent.

Munro's work as an archaeologist was marked by a cautious reserve and a great sanity in judgment. Yet, on occasion, none could be quicker than he in arriving at a conclusion, which further investigation usually proved to be well within the limits of accuracy. It was characteristic of him that he rarely accepted the results of others without personal investigation, and the great mass of information which he digested and summarised in his published works had been largely tested and checked by his own observations. His thorough mastery of his subject as a practical investigator was suggested even in such a trifle as the way in which he handled a stone implement.

E. N. FALLAIZE.

IRISH education has sustained a severe loss by the death of the RT. HON. W. J. M. STARKIE, Resident Commissioner of National Education. For the past twenty-two years Dr. Starkie guided the rather cranky ship of Irish primary education through the troubled sea of clerical management. After a brilliant school career, he obtained the highest classical distinctions at Cambridge University and Trinity College, Dublin, including the fellowship of the latter college. In 1897 he was appointed president of Queen's College, Galway, but after a brief period of office became Resident Commissioner and *ex-officio* chairman of the Board of National Education. As a member of the Viceregal Commission on manual and practical instruction, he played an important part in framing the scheme of reformation of the aims and methods of Irish education, which later he was called upon to administer. Upon his shoulders rested in large measure the responsibility of effecting the change from a mechanical system of payment by results to an inspection system with a broader view of the functions of a school. Knowing the magnitude of the forces opposed to change, he displayed conspicuous courage in carrying far-reaching reforms to a successful issue. His address on "Recent Reforms in Irish Education" at the Belfast meeting of the British Association in 1902 was a strenuous and courageous exposure of the weaknesses of Irish education; it aroused much bitter criticism from the clerical managers.

Dr. Starkie was also chairman of the Board of Intermediate Education, and thus occupied a unique position in Irish education, which probably owes more to him than to any one man during the last half-century. He was a brilliant essayist and one of the first Greek scholars of his time.

## Notes.

An important statement on the development of the synthetic dye industry was made by the chairman of the Colour Users' Association at Manchester on July 20. Mr. Vernon Clay referred to two very urgent reasons why the dye industry in England should be developed to the very utmost, one being the real necessity that existed from the commercial and industrial side, and the other the necessity from the point of view of national security. Only a country possessing a large dye-making plant which could alternatively be used for the production of the various organic chemical substances employed in war could hope to be in a proper position in any future struggle, for the next war would be essentially a chemists' war, and start on a very large scale. The Government has recognised that for national security it is essential that synthetic dye factories equal to those of any other possible hostile nation shall be in existence, and to further this object the President of the Board of Trade has stated that the pledge to the synthetic dye industry, that the importation of synthetic dyes shall be permitted only under licence, will be given effect to in legislation as quickly as possible. Although the British output of dyes already exceeds the pre-war importation from Germany, there are several important dyes which are not yet manufactured in this country, and a licensing scheme such as is promised appears to be the only proper means of fostering the industry and of encouraging manufacturers gradually to extend their range until the country is absolutely self-contained as regards its production of dyes and the necessary intermediate products.

The question of the universities and the excess profits duty was the subject of debate in the House of Lords on July 21. By the concession already proposed by the Chancellor of the Exchequer the position is roughly this:—While the excess profits duty will be charged at 60 per cent., the State, as a matter of fact, will bear 12 per cent. of any charitable contributions made by a business firm. Earl Grey, however, in the hope of inducing private benefactors to make larger subscriptions, wished the Government to show more liberality and to consider the *total* remission of the duty so far as it affected the universities. On behalf of the Government the Earl of Crawford could not grant the further concession, but, in the course of his reply, made an important announcement regarding university grants-in-aid. He stated that the Chancellor of the Exchequer was prepared to submit to Parliament an increase of the present vote of 1,000,000. to 1,500,000. in the Estimates for the year 1921-22, and, in addition, to consider the advisability of proposing to Parliament a further non-recurrent sum to assist the universities in meeting the grievance of those of their senior members who were precluded from profiting to the full by the benefits of the federated super-annuation scheme of the universities. No pledge was given in either case, and both proposals are subject to the overriding necessities of national finance.

Apparently the consideration of any supplementary grant within the present financial year is not contemplated. While it is reassuring to find that the Chancellor of the Exchequer recognises the clamant needs of the universities, there will be no little disappointment that provision more appropriate to the present needs, especially in the matter of superannuation, is not made.

ON July 21 the King received at Buckingham Palace the principal members of the British Empire Forestry Conference, which sat in London during the preceding fortnight. The members included delegates from Great Britain and Ireland, India, and the various Dominions and Colonies. Lord Lovat, president of the conference and chairman of the Forestry Commission of the United Kingdom, presented the delegates separately to his Majesty; and Mr. H. R. Mackay, Forest Commissioner, Victoria, and representative of the Commonwealth of Australia, read an address to the King, who in his reply congratulated the Home Forest Authority on its joining hands so soon with foresters in other parts of the Empire. He referred to the work of universities and colleges and to the experience gained in the Crown woods and private plantations as having laid a foundation on which it is incumbent to build. The King pointed out the peculiar difficulty of forestry work, which demands, perhaps, more imagination, more patience, and more foresight than any other industry, and considered it an immense advantage that the experience of all parts of the Empire should be brought into a common stock and made available for all. Forestry, directed as it is to checking reckless consumption of the world's supply of timber and to teaching and encouraging thrifty use and prudent replacement, represents a great work for the common good. The conference will result both in practical improvements in the operations of the Forestry Services at home and overseas, and in a truer and wider appreciation of their value to the Empire at large.

WITH the advice and assistance of the U.S. National Research Council, a co-operative body of scientific experts on injurious insects and plant diseases and of manufacturers of insecticides, fungicides, and general chemicals and apparatus used in fighting the enemies of field and orchard crops has just been organised under the name of the Plant Protection Institute. The purpose of the institute is to promote the general welfare by supporting and directing scientific research on the pests of crops, shade trees, and ornamental plants and on the methods of their control, and by furthering co-operation between the scientific investigators and the manufacturers of chemicals and appliances, especially for the sake of effecting standardisation and economy in the production and use of the means of fighting pests. Also it expects to aid in the dissemination of scientifically correct information regarding the control of injurious insects and plant diseases. Much excellent work along this line is now being done by Government and State organisations, but a further advance can be made by introducing a wider co-ordination and co-operation of the efforts of both the scientific men and the manu-

facturers of control devices. It is in this general direction of co-operative work that the Plant Protection Institute expects to be most active.

Two general excursions, both on Saturday, August 28, have been arranged in connection with the Cardiff meeting of the British Association. One party will drive through the Wye Valley to Tintern, where lunch will be taken; thence to Llanover, where they will be the guests of Lord Treowen for tea (price of ticket 19s.). The other party will cross the Bristol Channel to Weston-super-Mare, and drive to Cheddar, Wells, and Glastonbury, returning to Cardiff by boat in the evening (price of ticket 21s.). Owing to the difficulty of arranging transport, the local secretaries will be much obliged if members intending to join either of these excursions will kindly signify their intention of doing so as soon as possible. Both these are whole-day excursions, and it will be impossible for members to be brought back to Cardiff until rather late in the evening. Letters should be addressed to the Local Secretaries, British Association, City Hall, Cardiff.

THE eighteenth annual meeting of the general committee of the Imperial Cancer Research Fund, held on July 22, of which we publish an account in another column, shows that the Fund has returned to full activity after the interruptions of the war. We are glad to note that our premier organisation for cancer research mainly concerns itself with the purely scientific aspects of the problem. The detailed study of cell-metabolism now in progress, as foreshadowed in the Director's report, should, if energetically pursued, lead to advances in general biology of permanent value, apart from their application to the special problems of cancer. It is gratifying to find that the Fund is again playing its part as a central organisation of international collaboration in cancer research.

THE one hundred and first annual meeting of the Société Helvétique des Sciences Naturelles will be held at Neuchâtel on August 29-September 1. The following are among the papers to be presented:—"Les aciers au nickel dans l'horlogerie," C. E. Guillaume; "Die Vegetation des Diluviums in der Schweiz," Prof. H. Brockmann-Jerosch; "Ueber das Kropfproblem," Prof. Hedinger; "Les fouilles de la Grotte de Cotencer," Prof. A. Dubois; and "Die Gesteinsassoziationen und ihre Entstehung," Prof. P. Niggli. Particulars of the meeting may be obtained from Prof. O. Fuhrmann, Université, Neuchâtel, or Prof. E. Piguët, rue de la Serre 2, Neuchâtel.

THE Rayleigh Memorial Committee has decided that the memorial to the late Lord Rayleigh in Westminster Abbey shall take the form of a mural tablet to be erected near the memorials to Sir Humphry Davy and Dr. Thomas Young. The execution of the tablet will be entrusted to Mr. Derwent Wood. It is expected that after all expenses are met there will be a balance remaining, and this the committee proposes shall be used to establish a library fund at the Cavendish Laboratory, Cambridge, with which Lord Rayleigh was closely associated.

THE autumn meeting of the Iron and Steel Institute will be held at Cardiff on September 21-24, under the presidency of Dr. J. E. Stead. An influential reception committee, of which the Right Hon. the Earl of Plymouth has consented to act as chairman, Mr. E. Steer, vice-president of the South Wales Institute of Engineers, as deputy chairman, and Mr. D. E. Roberts as honorary secretary, has been formed to carry out the necessary arrangements.

SOON after the signing of the armistice in 1918 the United States Government sent a Commission to France to investigate the war developments in mining and metallurgy and to observe the methods taken to re-establish the collieries and steel works destroyed by the enemy. Mr. G. S. Rice, chief mining engineer of the Bureau of Mines, was a member of this Commission, and a valuable account of his observations was communicated to the Franklin Institute last December, and is published in the June issue of the *Journal of the institute*. The descriptions of the mines and the methods adopted in working them are confined mainly to the Pas-de-Calais district, and many views of the destroyed surface works are given. The author is of opinion that the most satisfactory way of reconstructing the mines is to cut up and remove the tangled ironwork at the top of the shafts, which are almost all badly cratered by explosives, and to reline the shafts themselves at those points where they pass through water-bearing strata and where they had in consequence been blasted by the enemy in order to drown the mines. He believes this method will be less costly than sinking new shafts. He has every confidence in the ability of the French engineers to deal successfully with the problem.

IN his report submitted to the joint session of the Oriental Societies at Paris Sir George Grierson describes the progress which has been made in the Linguistic Survey of India. What may be called the Cadastral Survey of these languages is now complete except for the Deccan and for Burma, of which a separate survey is in contemplation. The work so far done includes 179 languages and 544 dialects. The account of the so-called gipsy languages, many of which are secret dialects, is ready for the press. That dealing with the Eranian languages contains much interesting matter, particularly the account of Ormuri, a tongue with Dardic affinities, spoken by a small tribe settled in the heart of the Afghan country. At present Sir George Grierson is engaged upon a comparative vocabulary, representing 168 words—numerals, pronouns, common nouns, and declensional and conjugational forms—giving all the equivalents in all languages which have been studied in the course of the Survey, with a few words in some non-Indian languages, such as Japanese, Chinese, Manchu, Turki, Arabic, Avesta, and Persian. As a supplement to the Survey a number of gramophone records illustrating the pronunciation of various Indian languages is in course of preparation, and these are being distributed to institutions where they will be available for students. The progress made in this great work is thus most important.

AN interesting series of lectures was delivered recently at the London School of Economics and Political Science by Dr. B. Malinowsky, a young Polish anthropologist, who, as a member of the Robert Mond Ethnographic Expedition, spent a considerable time among the people of eastern New Guinea, in particular in the Trobriand Archipelago. Dr. Malinowsky's investigations throw fresh and welcome light on primitive economics. Trade is organised by the influence of the chief, associated with a magician in charge of each department of communal activity. "Primitive economics, as exemplified by the Trobrianders, present a picture different from, and more complex than, that usually assumed. National economy, as a system of free exchange based on untrammelled competition, where value is determined by the play of supply and demand, does not exist. But a system of production, exchange, and consumption does exist, socially organised and subject to definite customary rules. In addition to activities connected with the quest for food, there are many others, such as circular trading and ceremonial 'enterprise, in which the natives perform organised work, controlled by their conceptions of wealth and value, and therefore distinctly economic. In all these activities there is an interplay of chieftainship, kinship, and social organisation. Ceremonial life, magic, myth, and tribal law control and are controlled by economic elements." Anthropologists will await with interest a full account of this remarkable economic and social organisation. Part of the evidence is summarised in a paper by Dr. Malinowsky, "Kula: The Circulating Exchange of Valuables in the Archipelagoes of Eastern New Guinea," published in the July issue of *Man*.

WHILST the Crocker Land Expedition explored to the north-west of Greenland, the Canadian Arctic Expedition of 1913-18 investigated the district lying east and west of the Mackenzie River. The mollusca the Canadians brought back have now been studied and described by Dr. W. H. Dall (*Report Canad. Arctic Exped., 1913-18, vol. viii., part A, 1919, pp. 29, 3 plates*). This collection is of special interest, because, save for a partial exploration about 1863 by Mr. R. Macfarlane, of the Hudson Bay Co., the fauna to the eastward of the Mackenzie River delta has remained entirely unknown. It was thought that probably the great outpour of fresh water from the river might have proved a barrier to the passage of marine species from the western Arctic Ocean, and that the eastward fauna would show a considerable infusion of Greenlandic forms. The result of the study of the collection proved otherwise, for of the hundred Arctic species collected over the whole area in question—a collection, therefore, far richer in numbers than that of the Crockerford Expedition (see *NATURE* for July 8, p. 593)—only five were characteristically Eastern Arctic. Apparently the narrow, tortuous, ice-blocked passages which lead to the Greenland seas are accountable for the failure of the Eastern Arctic mollusca to colonise in the Bathurst region, while the open sea to the west readily gives access to the Western Arctic forms. Only six new marine species are established, and these are fully described and

figured. A few fresh-water forms were met with, including a new species of *Physa*, which is of interest as being the most northern species of the genus. Still, it should be noted that the closely allied *Aplexia hypnorum*, of circumpolar distribution, occurs with it. The *Limnæas* proved extremely puzzling, and Dr. Dall is inclined to consider that both the form known as *caperata*, Say, and the *vahl*i of Beck may be only boreal mutations of the well-known *Limnæa palustris*, Müller. Full lists of all the species collected at the several stations and from Pleistocene deposits are also included in this important paper.

MR. W. WYBERGH has brought forward evidence, including that of marine mollusca, to show that the coastal limestones of the Cape Province (Trans. Geol. Soc. S. Africa, vol. xxii., p. 46, 1920) are by no means entirely due to the cementation of recent dunes. The well-known dune limestone seems to have been formed over and against a more ordinary and shelly marine limestone, which constitutes the true Bredasdorp formation, and is of late Pliocene or Pleistocene age.

PAPERS on the Crown Colony of Sierra Leone are comparatively rare. Mr. F. Dixey (Trans. Geol. Soc. S. Africa, vol. xxii., p. 112, 1920) describes evidences of Pleistocene movements of elevation, with the formation of a coastal plain along nearly the whole coast of the peninsula or Colony proper, merging on the east into low ground that extends far into the Protectorate. Parallel raised beaches show that the uplift was intermittent. The highest beach is some 300 ft. above the sea. Four photographic views accompany the paper.

THE question of the persistence of genera is raised by Dr. C. D. Walcott in describing a remarkable series of floating cyanophyceous algae from the Middle Cambrian Burgess Shale of British Columbia (Smithsonian Miscell. Coll., vol. lxxvii., No. 5, 1919). *Morania*, one of his new genera, so closely anticipates the structure of the modern *Nostoc* that only a feeling that they cannot have been fully identical leads the author to propose a new generic name. The illustrations are presumably from photographs of specimens coloured by hand before reproduction; but they are, to say the least, surprising.

MR. LOUIS RENOUF, of the Bute Museum, Rothesay, writing in the *Museums Journal* for April-May on various technical methods, including the mounting of wet specimens under watch-glasses and petri dishes, remarks on the difficulty of obtaining such glasses with even edges, and nicely finished plates on which to mount them. The difficulty led to the discovery that there was "no glass-planing plant in the whole of Great Britain." If this be so, the discovery accounts for a good deal that scientific workers have had to contend with in obtaining glass apparatus (at whatever price) from British firms.

"THE Rainfall in the Island of Formosa" has recently been issued by the Government-General of Formosa, with a summary of meteorological observations at Taihoku and five other observatories. Since the

meteorological service was established in 1896 rainfall stations have been added as available from year to year. There were only 28 at the end of 1903, and there are now 135. Every 106 square miles of Formosa has, on the average, one station. Most of them are attached to various Government Departments. At 83 out of the 135 stations records are available for ten years or more. The average annual rainfall over the island is 2486 mm., the greatest fall, 7176 mm., being at Kashoryo, situated on a mountain slope at the head of a valley open to the north-east a few miles south of Kelung; this spot is said to be probably the most rainy in the Far East. The minimum annual rainfall for Formosa is 1050 mm. at Rochikuto, in Taichu, on the west coast. There are two rainy seasons, one during winter along the extreme north coast associated with the north-east monsoon, the other in summer on the mountain districts in South Formosa, largely due to typhoons and thunderstorms. Typhoons occasion a considerable variation in the rainfall according to their track and proximity, the track being usually from south-east to north-west. The heaviest rainfall in twenty-four hours in Formosa is given as 1034 mm. at Funkiko on August 31, 1911, which is the same day as that of the flood in Taihoku shown in the frontispiece of the publication under notice. The heaviest of the excessive rains in different parts of the world, quoted for comparison, are Charra Ponjee, India, 1036 mm., June 14, 1876, and Baguio, Philippines, 1168 mm., July 14, 1911. Comprehensive tables and maps are given showing the monthly and seasonal mean rainfall and the number of rainy days, also the five-day mean rainfall at six observatories from the results for twenty-two years, and the diurnal range, intensity, and duration of rain.

WE have received copies of the second biennial Hurter and Driffeld memorial lecture delivered by Prof. Alex. Findlay before the Royal Photographic Society on May 11, and the Hurter memorial lecture recently delivered by Mr. F. F. Renwick before the Liverpool Section of the Society of Chemical Industry. Prof. Findlay discoursed on the properties of colloids in general, and especially with reference to photographic processes and materials. He says: "In the production of the photographic plate, . . . from the moment of mixing the solutions to the final stage of ripening of the emulsion, we have a complex series of changes taking place in a delicately balanced and complex colloidal system, in which coagulation, peptisation, solution, and adsorption doubtless all take part. . . . In the production of the latent image . . . it seems probable that we are again dealing with phenomena of adsorption." Mr. Renwick deals with three characteristics of the latent image: "(1) The possibility of physically developing an image on a fixed and washed plate; (2) the possibility of transferring and subsequently developing (both physically and chemically) latent images from the silver salt in which they are formed to another, by changing the former chemically into a less soluble silver salt; and (3) the destructibility of the latent image by the further action of light itself under certain conditions." He gives the details of some

very interesting experiments of his own, and concludes that in the "most highly sensitive photographic plates we are dealing with crystalline silver bromide in which, besides gelatine, some highly unstable form of colloidal silver exists in solid solution, and that it is this dissolved silver which first undergoes change on exposure to light." He finds a reasonable explanation of solarisation "by assuming a peptising action on the part of the later-formed chemical products of light action (bromine, hydrobromic acid, etc.) with formation of a photohalide relatively rich in dissolved silver, but almost undevelopable."

A NEW radio call signal used by the Post Office is described by Major Shaughnessy in the *Electrical Review* for July 16. Until recently one of the drawbacks to radio reception was that it was always necessary for an operator to be listening, as there was no method of making the received signals operate a loud calling device. There are many outlying small radio stations in this country in islands and lightships the number of calls on which is so small that it would not justify the expense of having an operator always in attendance. The Post Office, by using a simple valve amplifier, a Turner thermionic relay, and a retardation device in series, has successfully employed the weak radio currents to ring a bell. In order to call the station a long "dash" of 15 seconds duration is sent. During this time a condenser at the receiving station is slowly charged through a 3-megohm resistance. After about twelve seconds the condenser is practically fully charged, so that when the signal ceases and the tongue of the relay moves back to the spacing stop the discharge of the condenser deflects a second relay, and this causes a bell to ring. This condenser device has been used by the Post Office for several years on land lines to call the operators, and is found to be very efficient. Trials of the set have proved that it is practically impossible for "jamming" or atmospheric disturbances to actuate the apparatus. It has been fitted on the P.O. cable ship *Monarch*, and even with heavy "jamming" has proved successful up to a hundred miles. This calling device can be applied for sending the distress signal at sea known as the S.O.S. signal. It will obviously extend the use of radio communication to much smaller ships than at present, as the saving of operators' wages considerably reduces the cost of maintenance.

Two recent articles in the *Engineer* (July 2 and 9) describe at some length the hydro-electric power works at the Great Lake, Tasmania, which is situated approximately at the geographical centre of the island at an altitude of 3350 ft. above sea-level. From the southern end of the lake the River Shannon finds an outlet some two miles west of the bed of the River Ouse, and the two streams flow in fairly parallel courses for some distance. But the fall of the River Ouse is much more rapid than that of the River Shannon, with the result that, while at a point opposite the middle of the lake the Ouse has an elevation of 120 ft. above it, a few miles south the

Ouse has fallen to considerably more than 1000 ft. below the Shannon. A short connection between the two rivers at this point enables a very high head of water to be obtained. For the initial installation only the water from the Great Lake catchment area has been utilised, but it is now in contemplation to divert the head-waters of the Ouse into the lake, and by this means a total capacity of 70,000 h.p. will be available at the turbine shafts. The dam across the southern end of the Great Lake, which at present impounds the water to a height of 11 ft. above the sill, will be raised to give an effective height of 40 ft. The existing power station at Waddamana contains two 5000-h.p. and two 8000-h.p. turbines, all of the Boving type; three more 8000-h.p. machines are under construction, and will shortly be installed. In order to develop the total fall a second station will be formed at a higher level, where a head of 250 ft. is available and a serviceable capacity of 12,000 h.p. is at present running to waste.

WE notice that, in consequence of the continued increased cost of production, the published price to non-fellows of the society of the *Journal of the Royal Society of Arts* has been raised to 1s.

MESSRS. R. AND J. BECK, LTD., 68 Cornhill, London, E.C.3, inform us that they have obtained a supply of mounted specimens of the scales of the Test Podura, *Lepidocyrtis curvicollis*, which is recognised as being one of the best tests of high-power microscope object-glasses. These scales have been for long unobtainable, and the new supply will be welcomed by many microscopists.

THE research on automobile steels carried out by the research committee of the Institution of Automobile Engineers has now been brought to a successful conclusion. It is hoped that the report, which was approved at a meeting held on July 21, will be ready for issue by about the end of August, when a further announcement in regard to price, etc., will be made.

THE "Rough List" (No. 359) of books on natural history just issued by Messrs. Bernard Quaritch, Ltd., 11 Grafton Street, W.1, will be of interest to collectors of first and rare editions, for among the thousand or so volumes offered for sale are many treasures. There is also a good sprinkling of ordinary editions listed at low prices. Practically the whole ground of natural history is covered by the catalogue; there are, besides, sections on mathematics, mineralogy, palæontology, and physics.

A BULLETIN issued by the Department of Industries, Madras, entitled "The Manufacture of Glue in the Tropics from Tannery Refuse," was noticed in *NATURE* of February 5 last, p. 611. The director of the Department now informs us that the pamphlet has been placed on the market so that the information contained in it may be widely known. The pamphlet is priced at 1 rupee, and copies can be purchased from the Superintendent, Government Press, Mount Road Branch, Madras.

### Our Astronomical Column.

THE DATE OF EASTER.—It seems a curious anachronism that our calendar in the twentieth century should still be largely influenced by the lunar chronology which passed out of direct use nearly two thousand years ago. That was the most obvious system to employ at the dawn of astronomy, the moon's rapid motion and the ease of locating its position in the heavens making it far superior to the sun as a time-measurer. But as time went on the inconvenience of having a variable number of months in the year, and of having events like the equinoxes and solstices occurring on variable dates, caused the system to be abandoned and a purely solar calendar substituted.

The Passover was, of course, on a fixed date of the lunar calendar, the fourteenth day of the first month, and, owing to the close association of this feast with the events commemorated at Easter, an attempt has been made to follow the ancient system of fixing its date. That this is mainly the result of sentiment is shown by the fact that Christmas and other feasts are kept on fixed days of the solar year; moreover, the coincidence with the ancient method is not perfect, since Easter is tied to one day of the week, which was not the case with the Passover. This fact alone may produce a deviation of six days, so that it is obvious that no serious principle could be involved in increasing the deviation to a fortnight or thereabouts, which is all that a fixed date demands. Many unofficial ecclesiastical pronouncements have shown that there is no strong hostility to such a change. Lord Desborough brought the matter forward in a letter to the *Times* on July 20, and in the House of Lords on the following day, pointing out the inconvenience felt by the schools, universities, law terms, etc., through the variable date. The Earl of Onslow did not give much hope of Government action, but this is clearly a matter for international, not merely national, arrangement. The Astronomical Union in its session at Brussels last July appointed a Committee on Calendar Reform, with Cardinal Mercier as chairman, and it is understood that the date of Easter was one of the subjects of reference. The present time, when so much is in the melting-pot, would seem to be a particularly hopeful one for promoting this and similar reforms.

ASTRONOMY IN TOWN PLANNING.—It is a sign of awakening public interest in astronomy that a paper should be read before the Ottawa centre of the R.A.S. of Canada on the importance of considering practical questions of incidence of sunlight in planning out new towns. The author, Mr. H. L. Seymour, refers to the action of sunlight on bacteria and to the importance of letting all rooms get their share of sunlight, which is best secured by making the corners of the houses point to the four cardinal points, which means that the streets should run from N.E. to S.W. and from N.W. to S.E. He quotes Mr. Horace Bushnell as having put forward the same idea in 1864; but, nevertheless, the tendency has been rather to make the streets run N.-S. and E.-W., with the result that northward walls get no sunshine at all for more than half the year. In the planning of garden cities, where the houses are not contiguous, it is also important to place them so that the shadow of one house may not fall on another, or at least to minimise such incidence. The heights of buildings should also be so regulated that those opposite them are not in perpetual shadow.

### The Empire Timber Exhibition.

By ALEXANDER L. HOWARD.

THE Overseas Trade Department of the Board of Trade some time ago conceived the idea of organising an exhibition which should be a representative collection of those timbers which form the forest wealth of the countries which constitute the British Empire. This excellent scheme, possibly the direct outcome of the experiences of the war, was cordially and unanimously supported by the representatives of the Governments overseas.

Among the many lessons learned as a result of the war none was of greater importance than the knowledge that was brought home to us of our great dependence upon the products of the forest for the making and building up of every possible kind of offensive and defensive engine of warfare as well as for the maintenance of the daily requirements of ordinary life. From the time when the proposals of the Board of Trade were first considered every effort was made by the representatives of the different States of the Empire and by the officials at home to see that not a stone was left unturned to show conclusively what it was possible to achieve in the matter of timber production from every source. By a happy chance the date for the exhibition was fixed to coincide with that of the British Empire Forestry Conference, which brought together representatives of the Forest Services throughout the Empire, and there can be no doubt that such an exhibition must form the best possible opportunity for the forest man to gauge the value of the work upon which he is engaged.

The countries of the world may be classed into three grades: one which possesses a competent scientific forest service with practical work in full operation; a second which also possesses such a forest system, but lacks the practical application of theory; and a third which possesses neither scientific nor practical forestry. It is regrettable that until a very recent date the United Kingdom must have been classed in the last category, and, although much has been done in the past few years to remedy the situation, it is doubtful whether the great national importance of the subject has yet been fully realised.

The Empire Timber Exhibition entailed an enormous amount of continuous hard work and persistent energy which eventually resulted in bringing together a collection of many hundreds of timbers from every part of the Empire, and certainly the majority of those of any commercial importance. A collection of this kind is not easy to gather together, and it is doubtful whether such an opportunity is likely to be again available for a very long time.

The following are a few of the more noteworthy of the exhibits of the various countries:

*British East Africa.*—The considerable forest resources of this country are practically unknown and their exploitation is yet in its infancy. The most important timber is pencil cedar (*Juniperus procera*), which is slightly harder and more brittle than the American variety (*J. virginiana*). So far it has not been much appreciated by British manufacturers, although its importance may be gauged from the fact that in 1910 31,000 logs of this timber were imported into Germany from what was then German East Africa. As the majority of the lead pencils used in this country before the war were of German manufacture, the importance of this supply is obvious.

*The Gold Coast.*—Supplies of the timbers of the Gold Coast have already been seen in this country, but this exhibit showed many which are unknown here, though, as with other countries, much confusion

arises from the varying vernacular names. The various species of Khaya, the African mahoganies, play the most important part, for this wood, which is generally of fine texture and good quality, has been in very large demand, and extraordinary prices have been realised for it. Another valuable wood is that labelled Odum (*Chlorophora excelsa*), which has also been imported as Iroko, sometimes falsely termed African teak. While it is in itself of great value, and likely to be more so in the future, it possesses none of the qualities of teak with the exception of a superficial resemblance in colour. The wood labelled Kaku, also called Karkoo (*Lophira procera*), is generally known in England as African oak; it possesses unique qualities of strength and durability, and it is to be regretted that supplies seem to be scarce.

**Nigeria.**—From Nigeria also *Lophira procera* is available, though here it is known as Eki; it is a strong wood, and is reported as being both termite- and teredo-proof. Other heavy constructional woods which resist the white ant and show good promise for the future are Sassawood (*Erythrophloeum guineense*), the gamboge-coloured Opepe (*Sarcocephalus esculentus*), Agboin (*Piptadenia africana*), and Apa (*Azelia africana*). A particularly fine ebony of large size and beautifully variegated colour is that known as Kawraw (*Diospyros mespiliformis*). First and foremost amongst the woods from this region, however, are the mahoganies, which form the bulk of the supplies. This exhibit was in charge of Mr. Lauchlan.

**Western Australia.**—The depletion of the forests in the past has reduced the volume of the timber available, but their re-afforestation is now in the charge of Mr. C. E. Lane-Poole, and supplies will probably be assured for the future. One of the chief factors in the great value of the timbers of Western Australia is their durability. Jarrah (*Eucalyptus diversicolor*) and karri (*E. marginata*) sleepers, for instance,  $4\frac{1}{2}$  in. by  $9\frac{1}{2}$  in., on the Great Western Railway remained sound in the ground for twenty years, and appear to be good for another twenty years, while the trenail has remained in position during the whole period. It should be remembered also that a jarrah or karri sleeper  $4\frac{1}{2}$  in. by  $9\frac{1}{2}$  in. is better than one 5 in. by 10 in. of any other wood. Jarrah is also shown in the form of flooring, and provides a smooth, hard-wearing surface equal to that of any other hardwood. Telegraph arms in karri were exhibited; these have been extensively used and much appreciated by the G.P.O. for many years. These hardwoods take premier place for such work as piling, wharf-planking, and bridge-building, and, though more costly in their initial outlay than many timbers, prove the most economical ultimately. As a furniture wood jarrah is also excellent; the chairs, tables, and panelling which were exhibited illustrate its value for this purpose.

**Canada.**—At the Canadian exhibit, which was in charge of Mr. Stokes, were shown two interesting models of wooden houses made of Douglas fir (*Pseudotsuga Douglasii*). Some sixty-nine timbers were shown, of which about twenty-five are of commercial interest, the remainder forming a valuable reserve for future use. Two of the outstanding timbers are the Sitka or silver spruce (*Picea sitchensis*), which might be called the aluminium of timbers, and veneer of basswood (*Tilia americana*), which is used in the making of safety matches. The by-products of the Canadian forests include turpentine, artificial silk and surgical cotton made from sulphide pulp, and the ground-wood pulp which is used in the manufacture of the paper on which the *Daily Mail* is printed.

**British Guiana.**—The timbers produced from this country, the exhibit of which was in charge of Mr. Herbert Stone, are of very great importance, and

provide a source of supply which has never yet been properly realised. With the exception of greenheart (*Nectandra Rodioei*), no import into the United Kingdom worth mentioning has occurred. This fact is evidence of the lack of enterprise which this country displays, because from Dutch Guiana (Surinam) similar woods have been known and appreciated for many years in Holland, France, and Germany. Amongst the practically unknown timbers which should be in demand are purpleheart (*Copaifera pubiflora*), the rich and brilliant colour of which stands out remarkably even amongst the many brilliantly coloured woods of South America; mora (*Dimorphandra Mora*), a wonderfully durable wood suitable for constructional work and for sleepers; wana (*Nectandra Wana*); brownheart (*Andira inermis*) (this wood, which is called Surinam teak by the Dutch, was named partridge wood by Laslett); locust (*Hymenoclea courbaril*); and crabwood (*Carapa guianensis*). All these are fine durable woods suitable for construction in buildings which are required to last for generations.

**Indian Empire.**—The remarkable exhibit of the timbers of the Indian Empire, both in the raw state and manufactured into furniture and so forth, was the more noteworthy when it is remembered that practically none of these timbers of India had ever before been seen in this country. Even those who were acquainted with the forest wealth of India have not hitherto realised the extent of its commercial value in Europe. Amongst the exhibits were two halls and staircases made respectively in Indian silver greywood and padauk (*Pterocarpus dalbergioides*), a dining-room panelled in gurjun (*Dipterocarpus turbinatus*) and furnished in laurel wood, a drawing-room in sissoo (*Dalbergia Sissoo*), a bedroom in Indian black walnut with panels of walnut burr (*Juglans regia*), and a billiard-room furnished entirely in padauk and panelled in laurel wood. The great possibilities of the Indian timbers were, perhaps, most strikingly shown in the railway coach built by the Great Eastern Railway Co. The constructional portion was entirely of Indian wood, the decoration of the first-class carriage being in Indian silver greywood and that of the third-class in padauk. These presented such an excellent appearance that their increasing use in this direction is certain.

In addition to these larger exhibits were shown chairs, mirrors, and numerous small articles which serve to illustrate the many and varied uses to which the woods may be put. No trouble has been spared to demonstrate the fact that for every purpose for which wood is required the products of the Indian forests can meet the demand. Some two hundred small specimens showed the wide range of colour and texture which is available. Amongst this large collection of timbers the following are particularly worthy of the most careful attention of those interested in timbers for decorative and constructional work. Gurjun (*Dipterocarpus turbinatus*), a pale brown-coloured wood with a delicate aromatic scent, is an attractive medium for panelling, and one of the best hardwoods for flooring which it is possible to obtain. It is available in large sizes of superlative quality, and at a price which brings it within the range of even the most economical kinds of uses. Padauk is a wood which is unique in its brilliant red to maroon colour. It is exceedingly firm and durable, stands well without shrinking or warping, and is one of the strongest woods it is possible to obtain. During the war immense quantities of padauk were used for saddle-trees and gun-carriages, for which purposes it is difficult to find its equal. It was also used for the feloes of some exceptionally large wheels for heavy guns for use in Russia. The produce of a



species of Canary, which has been termed Indian white mahogany, is likely to take an important place in the future. It is a smooth, even-grained wood which will be available at a very reasonable price. Haldu (*Adina cordifolia*) is a bright canary-coloured wood notable for the smooth and even regularity of the grain. It is possible to carve it in any direction without splitting—a striking quality which gives it a particular value. Perhaps the finest carving wood which it is possible to obtain, however, is Indian red pear (*Bursera serrata*), which possesses the above qualities in a unique degree. Other woods which are chiefly notable for their decorative qualities are Indian red zebra-wood (*Melanorrhoea usitata*), Indian primavera, yellowheart (*Pagraea fragrans*), and the handsome striped and mottled ebony known as Andaman marlewood (*Diospyros Kurzii*). It becomes abundantly clear that the only thing necessary for these timbers of India to take the important position which their merits deserve is that the representatives of the Government in India should continue to provide regular and certain supplies, and to this end extensive arrangements are now being made.

*The United Kingdom.*—About seventy varieties of timbers grown in the United Kingdom were shown, and these included such importations as the silver wattle of Australia and the black walnut (*Juglans nigra*) of America. Floorings in yew (*Taxus baccata*), cherry (*Prunus Avium*), and beech (*Fagus sylvatica*), amongst others, illustrated a little-known use for these woods. The decorative effect of English brown oak (*Quercus Robur*) was shown in various articles. Other exhibits, such as the gondola of an aeroplane made in English ash (*Fraxinus excelsior*), called to mind the large part played in the war by the native timbers.

Other countries showing interesting exhibits, of which space forbids mention, were British Honduras, Ceylon, Fiji, Newfoundland, New South Wales, New Zealand, Union of South Africa, Tasmania, and Trinidad.

## The Education Act, 1918.

### LONDON COUNTY COUNCIL DRAFT SCHEME.

THE Education Act of 1918, which among its provisions requires that draft schemes for giving effect to them shall be submitted by the local education authorities, has resulted in a remarkably interesting document just issued by the Education Committee of the London County Council, in which is set forth not only a scheme for the administration of the Act within the county, but also a most informing summary of the history of education in London during the nineteenth century and of the various legislative enactments passed from time to time, notably those of 1870 and 1902, to increase the facilities and improve the quality of education especially for the large population immediately within its area, now amounting to upwards of 4½ millions. The report further makes clear the present activities of the Committee with its 951 separate elementary schools, in which 695,197 pupils are enrolled, with an average attendance of 590,633, from which figures it would appear that more than 100,000 children are constantly absent. The schools are staffed by 20,000 teachers (less than one-third are men), of whom only 300 are uncertificated. In addition to the ordinary elementary schools there was organised in 1910 a system of central schools to the number of 51, distributed more or less evenly throughout the County of London, and filled with pupils selected partly by means of junior county scholarships at about eleven years of age with a view to an advanced course of training of four years.

NO. 2648, VOL. 105]

The Council, as the local education authority, is concerned not only with the mental well-being of the child, but also with its physical and social welfare. Having regard to the fact stated by Sir George Newman in a recent report, that there were more than one million children in attendance at public elementary schools in England and Wales who were unable by reason of physical or mental defects to take effective advantage of the instruction offered, no feature of the past and future work of the Council can be regarded as of greater importance than the effort to raise and maintain the standard of bodily health and intellectual vigour of the children of London. The statutory medical inspection in the schools is carried out by 57 assistant medical officers and a staff of 208 nurses under the Medical Officer of Health of the county. The county is divided into five areas, each under a divisional medical officer, a superintendent of nurses, a treatment organiser, and a children's work director. During 1919 169,200 cases of various kinds were treated, and for 1920-21 provision is to be made for 40,000 cases more. A fee of 1s. is required in each case where the parents can afford it, otherwise the treatment is free.

There is special provision for anæmic and sub-normal children, for those with speech defect, of whom there are about 1200 in the schools who need treatment, and for blind and deaf children, of whom there are 317 and 693 of the elementary-school class respectively, whilst there are also 659 partly blind and 117 partly deaf London children.

All these measures denote a seriously important and beneficial advance upon the almost entire neglect of child-life in the nineteenth century. The provision of higher education within the county includes 23 schools provided and maintained by the authority and attended by 8702 pupils, 31 schools with 11,808 pupils aided by the authority, 47 other public secondary schools with 16,462 pupils, 40 schools conducted by religious bodies with 5170 pupils, and, lastly, 421 private schools with 27,295 pupils. The last two groups are regarded as preparatory rather than as secondary. There is thus a total of 562 schools in the county area with 68,807 pupils under instruction, much of which, it is not unreasonable to say in respect of the great majority of the private schools, can scarcely be efficient either in subject or in quality. The Council maintains five training colleges for teachers, one of which is a school of the University of London, and makes maintenance grants to three recognised training colleges within its area for domestic-economy teachers.

The provision of technical education within the county since the passing of the Technical Instruction Acts of 1889 and 1891 comes under review, and is marked by three periods of development. The first covers the years 1889-1904, and embraces the work of the Technical Education Board established in 1893; the second from 1904 to 1909, which followed the traditions and policy of the Board; and the third from 1909 to the present time, which has aimed at a progressive delimitation of the functions of rival institutions and at a general endeavour to co-ordinate all forms of education.

In 1892 a general survey was made of the needs of London as a preliminary to the operations of the Technical Education Board, and, as a result, the Board made direct grants in aid of polytechnics and other institutions for their maintenance and equipment and for the extension of their work. There were 26 technical institutions so aided in 1903, some of which were under the direct control of the Council, and grants were also made to the extent of 33,000l. in aid of science and language teaching in the secondary schools. A system of scholarships was

established in aid of boys and girls of ability to obtain an education beyond the primary stages, and to assist adults in their studies in art, science, and technological subjects in day and evening institutions; and the Board, having regard to the importance of educating the future leaders of industry and commerce, not only aided in the establishment of the London School of Economics, but also made grants of 17,000*l.* a year in 1903-4 to institutions and schools of the University of London. This policy has been greatly developed since 1904, when the Council became the local authority for all forms of education. Some measure of the expansion of the work undertaken in the polytechnics may be seen on a comparison of the student-hours worked in the departments of engineering, mathematics, physics, and chemistry in 1900-1 and in 1919 (November), from which it appears that the hours in 1900-1 were 268,344 and in 1919 795,000.

The growth of expenditure in polytechnics, technical institutes, schools of art, science, art, and commercial centres, and in ordinary evening classes is indicated by the following figures:—In 1904 the expenditure was 369,400*l.*, and in 1919-20 (estimated) 822,514*l.* Twenty-five special institutions for art, technical, and domestic subjects are now wholly maintained by the Council, and twenty-nine others are aided by annual grants. Twelve polytechnics and colleges receive annual subsidies ranging from 400*l.* to 3500*l.*, amounting in the aggregate to 23,250*l.*, whilst the block grant made to ten polytechnics and colleges in 1911-12 of 86,381*l.* was increased in 1919-20 to 139,950*l.*, exclusive of 60,000*l.* in respect of war bonus and improved salary scales. In 1919-20 an equipment grant was also made to these institutions of 13,000*l.* The Council in 1918 introduced a new scale of salaries for principals and other teachers in technical institutions, whereby the minimum salary for principals in the lowest group was fixed at 440*l.* and the maximum in the highest group at 1250*l.* The salaries for heads of departments range from 440*l.* to 840*l.* (men) and from 340*l.* to 640*l.* (women), and whole-time lecturers' salaries are fixed from 225*l.* to 490*l.* (men) and from 180*l.* to 340*l.* (women). The Council works in close association with the University of London, to which it gives annual grants-in-aid, which at the present time amount to about 47,000*l.* This includes provision for nineteen professorial chairs in languages and literature, mathematics, science, education, and economics. The Council also maintains a school of the University, the London Day Training College, at an annual cost of 10,000*l.*, and is spending in 1919-20 about 13,000*l.* in aid of university students, mainly in London, Oxford, and Cambridge, which altogether brings up the annual expenditure in support of university education to about 70,000*l.* Capital grants have further been made at various times in aid of certain schools of the University for the erection and improvement of buildings. Thus grants were made to University College and to Bedford College each of 30,000*l.* Land of the value of 66,700*l.* was also assigned at a peppercorn rent for the new building of the London School of Economics. The grant to the Imperial College of Science and Technology has been increased from 5000*l.* in 1908-9 to 13,000*l.* in 1918-19.

Many of the reforms foreshadowed by the Education Act, 1918, have already been anticipated, such, for example, as the reduction in the size of classes, the establishment of central schools, the promotion of physical training, and the provision of maintenance allowances. The raising of the school age to fourteen *plus* and the reduction aforesaid will necessitate the provision of school-places for 120,000 children, 32,000

of which have been already provided, and will entail the appointment of 200 new teachers each year for ten years. Nineteen per cent., or some 14,000 children between eleven and twelve years of age, are fitted for some special type of school, and the Council has therefore decided to increase the number of central schools already provided from 60 to 100, and to lengthen the course in such schools to five years. Thus some 80 per cent. of the children remain to be dealt with until they reach the limits of the compulsory age, and measures are being taken to ensure the most enlightened treatment of such children in regard to both their physical and intellectual training such as prevails in the secondary schools. The attendance at the secondary schools in London ranges from 1.3 per 1000 in Shoreditch to 18.8 per 1000 in Lewisham. Additional accommodation is urgently needed, and the Council proposes therefore to build four entirely new schools and to rebuild or enlarge seventeen more.

It is anticipated that the new scholarship scheme of the Council and the better conditions of service will attract more candidates to the teaching profession. The report of the Board of Education for 1918 shows that in England only 150 men and 4000 women completed courses of training as teachers, whereas in 1914 the corresponding figures were about 2000 men and 3600 women. The annual requirements of London alone will in the near future be at least 1200, and with the view of meeting in part this demand the Council proposes to build three new training colleges for 750 students, which proposal will involve a capital expenditure of some 600,000*l.* The Council aims ultimately at securing a university course for all teachers. A much enlarged scheme of maintenance scholarships is submitted, the ultimate gross cost of which, including the cost of examinations, is estimated to reach about 1,178,000*l.* in 1931, made up of 730,000*l.* for education and 448,000*l.* for maintenance.

The day accommodation in the present polytechnics, in the various institutes, and in schools for special trades is about 2500, and it is proposed to increase it to 5600. A large amount of original research has been undertaken in the institutions both before and during the war in the domains of chemistry, physics, and engineering, and notably in the industries of photo-engraving, lithography, and tanning. This has led the Council to provide additional facilities to meet the requirements of research. Close consideration has been given to problems arising out of the powers and duties imposed by the Act in respect of adolescents engaged in employment. Provision is to be made next October for about 15,000 young persons, and an equal number will then be added to the total enrolment each succeeding three months for a period of two years. The number will then be 120,000, and in 1928, when those aged from sixteen to eighteen come under the Act, the number will be doubled. Meanwhile, it is proposed to establish as a first provision twenty-two day continuation schools at a cost on capital account of 131,000*l.* and of 116,500*l.* for maintenance. The scheme when fully matured is estimated to cost for the two age-groups 14-15 and 15-16 1,000,000*l.* annually, and when five years later the age-group 16-18 is dealt with the cost may be doubled. The movement of adult education by the W.E.A. has the full sympathy of the Council, which proposes to support it through the University of London.

Pending the re-organisation of the University of London, the system of annual grants, which amount to 46,813*l.* to the University and non-incorporated colleges, will remain as at present. By the Act of 1918 local education authorities may aid any investigation for the advancement of knowledge in or in connection with an educational institution. London, by reason of

the large scale of its operations, offers the most promising field in the world for research in the domain of education, which is the "key" to all original investigation, scientific or industrial, and in connection with the national movement for reconstruction. It includes the study of the mental development of the individuals to be educated and the study of the teaching methods most effective in securing that end. It is therefore proposed to encourage and aid extended educational research. The total estimated expenditure of the Education Committee of the Council for 1920-21 is estimated at 11,711,379*l.*, being for elementary education 9,351,294*l.* and for higher education 2,360,085*l.*, of which sum 5,514,266*l.* is raised from rates, or a rate of 2*s.* 5*d.* in the pound. A forecast is given of the additional expenditure in London arising out of the requirements of the Education Act, 1918, which will in 1920-21 amount to 116,000*l.*, and gradually increase until in 1930-31 it is estimated that it will be 3,037,500*l.*, of which sum taxation will bear half the cost, the other half being raised by an additional rate of 8*d.* in the pound on the present assessment. The report extends to 100 pages, and is abundantly illustrated by diagrams, maps, tables, and illustrations of buildings.

### The Society of Chemical Industry.

THE Society of Chemical Industry held its thirtieth annual general meeting at Newcastle-upon-Tyne on July 13-16, this being the fourth occasion upon which the society has selected Newcastle as its meeting place. Appropriately enough, a series of papers dealing with the manufacture of coke was read and discussed at the first business meeting, whilst the second was devoted to papers dealing mainly with miscellaneous metallurgical questions. Simultaneously the Chemical Engineering Group of the society held a conference devoted to problems connected with filtration and allied methods of separating liquids from solids.

Among the first day's papers two dealt with coke-oven construction. Mr. W. A. Ward discussed "Modern By-product Coke-oven Construction" from the point of view both of the best type to be adopted in different circumstances and of the details of design of the oven itself. Mr. Ward pointed out that the generally accepted view that the regenerative oven is more efficient than the non-regenerative oven is not strictly correct, and that in either case "the surplus energy is the same, because the amount of heat necessary to coke the coal is the same. . . . The difference lies simply in the manner in which the surplus heat is made use of." He showed that it is true that the former type can generally produce a larger amount of power available for use outside the coking plant, but that this is due to the fact that the former uses the more efficient form of power generation, namely, the gas engine as compared with the steam engine. Mr. Ward remarked also that there is no reason why any one of the various types of modern coke-oven should give better results than any other. He proceeded to give much useful information on details of construction; for example, he held strongly with the advantages to be gained in most cases by compressing the coal, but advocated the use of the modern electrically driven top-charging machine instead of the machine making a compressed cake of coal, which is then pushed into the oven, and he gave short descriptions of the modern methods for quenching, screening, and loading the coke.

Mr. W. J. Rees contributed a paper on "The Construction of Coke-oven Walls," which he attributed mainly to the sodic chloride and sodic sulphate in the

coal, and pointed out that hot, moist air carrying salt vapour has a highly corrosive action on fireclay bricks, much more, in fact, than on other refractory bricks. In the salt glazing of bricks the saline vapour is allowed to come in contact with the brick only at a temperature of about 1200° C., at which the chemical action is rapid; in the coke-oven, on the contrary, the walls of the oven never attain this temperature, with the result that the salt vapour penetrates into the interior of the brick and turns it into a weak, spongy mass, easily broken away. It would appear that the best brick for ovens carbonising salty coal is a good silica brick.

Mr. Harold E. Wright, in his paper "Coke-oven Gas for Town Supply," showed that illuminating gas can be produced more economically in the coke-oven than in the gas retort, and that, wherever circumstances permit of its adoption, the regenerative coke-oven producing metallurgical coke can supply better and cheaper gas to the town consumer than can the ordinary process of gas manufacture.

Dr. E. W. Smith, in "By-products from Coke-oven Gas," dealt with a similar subject from a somewhat different point of view, but came to the same conclusion, stating that it is only necessary to remove sulphuretted hydrogen from coke-oven gas in order to make it suitable for town supply, and that experience at Birmingham has shown that the yields of by-products from coke-ovens were just as good as from horizontal gas retorts.

Messrs. G. W. Henson and S. H. Fowles contributed a paper on "The More Economical Utilisation of the Coke-oven and Blast-furnace Gases for Heating and Power." They added numerous data and calculations to support the view which has been repeatedly put forward within recent years, that with regenerative coke-ovens built near the blast furnaces and steelworks, and with proper cleaning of the blast-furnace gases (for which they apparently prefer the Halberg-Beth method), better results are obtained in iron and steel manufacture and a large surplus of power can be generated by means of gas engines, which can supply all the power required by a modern iron and steel plant, whilst a considerable proportion of the coke-oven gas can be utilised in the melting furnace. They also suggest that a certain proportion of the electricity generated can be applied to the finishing of the steel manufacture in the electric furnace, which they consider has no competitor as an appliance for refining steel.

Amongst the metallurgical papers was one on "Some Properties of 60-40 Brass" by Prof. C. H. Desch. Such brass contains two constituents, the  $\alpha$  solid solution containing 70 per cent. of copper and  $\beta$  solid solution with 53.5 per cent. of copper; this latter constituent is plastic at high temperatures, and enables the metal to be hot-rolled, worked, or extruded. It was found in practice, however, that such brass varied greatly in the ease with which it could be machined, and the present paper deals with the reasons for such variation, which was traced to differences of structure. A fine fibrous structure was found to give the best results, and this can be obtained by using brass containing as nearly as possible 40 per cent. of zinc, extruded at a moderate temperature in very powerful presses.

Mr. D. W. Jones, in a paper on "Chemical Sheet-Lead," showed the importance of using the purest possible lead in connection with acid plant, but that in case of need copper will to some extent counteract the injurious effect of antimony and bismuth.

Mr. D. F. Campbell described "Recent Developments of the Electric Furnace in Great Britain," and showed the progress that had been made in this branch

of metallurgy: "In 1914 the quantity of energy used in electric furnaces in Britain, excluding those used for aluminium, was probably less than 0000 h.p., but on the day of the armistice the total capacity was in excess of 150,000 h.p." The author held that furnaces of more than 25 tons or above 3000-kw. capacity are not advantageous, and that the arc furnace has practically displaced the induction furnace. He pointed out the various existing applications of the electric furnace, and indicated the probable future development of this valuable appliance.

Dr. E. F. Armstrong read a paper on "Catalytic Chemical Reactions and the Law of Mass Action," in which he reviewed the present state of our knowledge of catalytic reactions, particularly as applied to the hydrogenation of certain oils. He held that the curve of catalytic action is linear and not logarithmic, and that the latter curve has been obtained by a number of observers owing to the fact that they had been working on substances in which some poison formed part of the substance to be hydrogenated, which destroyed the catalysts and thus gave the curve a logarithmic form. He further claimed that catalytic action is not a purely physical phenomenon, but is due to the formation of loose additive chemical compounds, of the existence of which he produced some evidence.

At the conference of the Chemical Engineering Group the theory of filtration was discussed in two papers, "The Principles of Technical Filtration," by Dr. E. Hatschek, and "The Design of Mechanical Filters," by Mr. Balfour Bramwell, whilst the filtration of gases was dealt with by Mr. J. M. Brown. Mr. E. A. Allott contributed a paper on "Recessed Plate and Plate-and-Frame Types of Filter Press: Their Construction and Use," in which he compared the two types and the details of their construction; he also discussed various methods of feeding, the selection of filter-cloths, and other important points in the use of filter presses, and gave data as to the results obtained in certain typical examples.

Three papers dealt with centrifugal machines, namely, "The Sturgeon Automatic Self-Discharging Centrifuge for Separating Solids from Liquids," by Mr. R. A. Sturgeon; "The Sharples Super-Centrifuge," by Mr. S. H. Menzies; and "A New Process for Centrifugal Filtration," by Mr. W. J. Gee. The last-named appliance differs from most centrifugal machines in that it makes use of a filtering screen, so that it does really perform a process of filtration. Dr. W. R. Ormandy in his paper, "The Filtration of Colloids," showed the effect of electro-osmotic action on colloids and suspensions, and illustrated these by a series of experiments with a suspension of clay.

### Imperial Cancer Research Fund.

THE eighteenth annual meeting of the Imperial Cancer Research Fund was held on July 22, the Duke of Bedford presiding. Sir William Church, in moving the adoption of the report, gave a summary of the investigations during the past year; in this he stated that the Director had continued the autologous grafting experiments, in which by transplanting an animal's own tumour to a part of its body away from the site of the primary growth an artificial secondary growth is established. The formation of secondary growths is the most certain evidence of the cancerous nature of a growth. It is to be hoped, therefore, that this method will be more widely applied as a control in the experiments on the production of cancer by chronic irritants which are being undertaken in so many laboratories throughout the world. In these experiments the most definite proof of malignancy is essential to progress.

NO. 2648, VOL. 105]

Dr. Cramer has examined the action of a number of inorganic substances on cancer cells. The first step in these investigations is to expose emulsions of a transplantable tumour to the reagent in the test-tube and find out by inoculating the treated emulsion into susceptible animals the amount of damage produced. Salts of cerium were found to be the most active of those tested. Manganese and uranium salts were less potent, and the other elements experimented with were without effect in strengths which could be tolerated by the experimental animals. None of these substances, however, had any influence on growing tumours—a failure probably due to the irregularity of the circulation in the tumours, which delays the access of the reagents to the cells, coupled with their rapid elimination by the kidneys and bowels. This is one of the difficulties constantly met with in direct therapeutic experiments on cancer. The cancer cell is so like the normal cells of the body that agencies which destroy it are also dangerous to life.

Before we can plan a rational method of treatment it will be necessary to know more of the vital processes in cancer cells and the nature of the very delicate differences between them and the normal. A beginning has been made with the study of cell-respiration. Respiration is essentially a combustion process, oxygen being taken in and carbon dioxide given off. These are only the first and last terms, however, of a series of chemical equations, so that there is room for great variety in the intermediate stages, even if the final result should be the same.

Dr. Drew has approached the problem by studying the rate of decolorisation of dilute methylene-blue solution by normal and cancer cells. With this method there is a wide difference between the two, decolorisation being much more rapid with normal cells. Dr. Russell and Dr. Gye have suspended the tissue emulsions in fully oxygenated defibrinated blood and measured the rate at which oxygen is abstracted on incubation at body-temperature. By this second method the differences are much less pronounced, and it is found that the more rapidly growing tumours, with significant exceptions, absorb more oxygen than those which grow slowly. The investigations are being continued, and give promise of interesting light on this fundamental feature of the life of cancer cells.

The Duke of Bedford, in moving a vote of thanks to the executive committee and to others who have assisted in the work of the Fund during the past year, referred to the wide range of investigation, covering such important researches as those relating to (1) experimental induction of cancer; (2) respiration in normal tissues, which is a fresh line of research in connection with cancer; and (3) experiments on the action of chemical substances on cancer cells in the test-tube and in the body; and to the very technical investigation of the Director on grafting; and noticed with satisfaction that the Fund is again in a position to assist investigators at home and abroad with tumour material for experimental purposes.

### Liverpool School of Tropical Medicine.

THE Sir Alfred Jones Laboratories of the Liverpool School of Tropical Medicine were formally opened by Lord Leverhulme on Saturday, July 24, Sir Francis Danson, chairman of the School, presiding. Prof. J. W. W. Stephens announced the award of the Mary Kingsley medal to the following distinguished scientific workers:

DR. A. G. BAGSHAWE, C.M.G., well known for his researches on sleeping sickness in Uganda. Since 1908 Dr. Bagshawe has been director of the Tropical Diseases Bureau and general editor of the Tropical Diseases Bulletin. This publication occupies a unique

position in the world; it is of the utmost value to all workers in tropical medicine, and its success is due to the tireless devotion of its editor.

DR. ANDREW BALFOUR, C.B., C.M.G., director-in-chief of the Wellcome Bureau of Scientific Research, London. Dr. Balfour was director of the Wellcome Tropical Research Laboratories, Khartum, from 1902-13. His knowledge of the theory and practice of tropical sanitation is unsurpassed. His intellectual activities also overflow into literary channels, and he is known as the author of novels and tales of adventure.

PROF. R. T. LEIPER, helminthologist to the London School of Tropical Medicine since 1905. Prof. Leiper has established a world-wide reputation for his knowledge of those parasitic worms that affect man, more especially in tropical lands. His recent elucidation of the part played by fresh-water snails in the transmission of the Bilharzia disease of Egypt is of the greatest scientific and economic importance.

MAJOR E. E. AUSTIN, D.S.O., assistant in the British Museum (Natural History). Author of numerous monographs on flies. Especially well known to students of tropical medicine for his monograph on the tsetse-flies.

DR. A. L. GUILLAUME BRODEN, director of the State School of Tropical Medicine, Brussels. Formerly director of the Bacteriological Laboratory at Leopoldville, Belgian Congo. Has published numerous works on trypanosome diseases of man and domestic stock.

MRS. ALBERT CHALMERS, in recognition of the work of the late DR. A. J. CHALMERS, who succeeded Dr. Balfour as director of the Wellcome Tropical Research Laboratories, Khartum. Dr. Chalmers was joint author with Dr. Castellani of a most comprehensive text-book of tropical medicine.

PROF. B. GRASSI, professor of comparative anatomy, University of Rome. Distinguished as a zoologist. Played a leading part in Italy in demonstrating the transmission of malaria by Anopheline mosquitoes.

DR. F. MESNIL, professor at the Institut Pasteur, Paris. Joint author with Prof. Laveran of the standard work on trypanosomiasis.

DR. EDMOND SERGENT, director of the Institut Pasteur, Algeria. Dr. Sergent is the elder of two brothers greatly distinguished for their researches in tropical medicine.

DR. C. W. STILES, professor of zoology, United States Public Health and Marine Hospital Service; scientific secretary of the Rockefeller Sanitary Commission for the Eradication of Hookworm Disease—a disease which was responsible for widespread mental and physical deterioration in the Southern States of America.

DR. T. ZAMMIT, who made a fundamental observation which led to the discovery that goat's milk was the source from which man contracted undulant fever. His archaeological researches on the megalithic remains of Malta are well known, and the University of Oxford has recently shown its appreciation of his work by conferring on him an honorary degree.

After the ceremony the laboratories were inspected by the large, distinguished gathering of scientific and influential people, and general admiration was expressed for the completeness of the building and its equipment. The well-furnished library and the museum, which already contains many interesting exhibits, attracted considerable notice, while the lighting and spaciousness of the main laboratory were also much commended.

The occasion was marked by the issue of an interesting illustrated "Historical Record," tracing the progress of the School from its foundation in 1898 to the present time.

At a banquet held in the evening Sir Francis Danson appealed for a sum of 100,000*l.* to meet the increased cost of maintenance of the Liverpool Laboratories and of the new Sir Alfred Jones Tropical Laboratory, now in course of erection at Sierra Leone. Sir Francis Danson himself contributed to the fund a sum of 100*l.*, in memory of his son who fell in the war.

### Central Headquarters for British Chemists.

AT a dinner held in honour of Lord Moulton on July 21, Sir William Pope announced that a public appeal was about to be made for funds for the erection of central headquarters for British chemistry. None of the chemical bodies has the accommodation for a meeting of more than two hundred persons, or adequate library space. The Chemical Society conducts its business at Burlington House, Piccadilly, in rooms provided by the Government nearly fifty years ago, when the membership was about one-fifth of what it is to-day. The Institute of Chemistry possesses a good building in Russell Square, completed during the first year of the war, but it is barely adequate for the present activities of the institute, which has to look to colleges for hospitality for any general meeting of unusual interest and for lectures. The Society of Chemical Industry and the Society of Public Analysts hold their meetings at the Chemical Society's rooms. Neither of these bodies nor any other which is concerned with chemistry, such as the British Association of Chemical Manufacturers, the Faraday Society, the Biochemical Society, and those devoted to the various branches of technology—brewing, dyes, glass, ceramics, iron and steel, non-ferrous metals, leather, concrete, petroleum, and so forth—possesses accommodation to compare with the spacious halls and headquarters of the Institutions of the Civil, the Mechanical, and the Electrical Engineers, and of the Royal Society of Medicine.

The appeal, which will be made by the Federal Council for Pure and Applied Chemistry, on which practically all the chemical interests of the country are represented, has the cordial support of Lord Moulton, who, as Director-General of Explosives Supplies, Ministry of Munitions, repeatedly acknowledged the services rendered during the war by these scientific, technical, and industrial bodies.

The scheme, which aims at providing under one roof, so far as is practicable, a common meeting-place, library, and editorial facilities for technical journals, is highly desirable, and indeed imperative, as a matter of supreme importance to the welfare of the whole country in relation to questions of defence and the maintenance and development of all branches of industry and commerce which depend on the applications of chemistry. The sum required for building is estimated at 250,000*l.*; a similar sum is required for establishing a chemical library and to provide for the compilation and production of works of reference in the English language.

### University and Educational Intelligence.

LEEDS.—Owing to the unavoidable growth of the expenditure necessary for the maintenance of the efficiency of its work, the council has come to the conclusion that an increase must be made in the scale of fees charged to students for tuition and examination. The increase has been kept as low as possible, in no case being more than about 17½ per cent.

The council has instituted an Appointments Board for the purpose of supplying students at the end of their University career with information about vacant appointments. Mr. W. R. Grist has been appointed the first secretary of the board.

Mr. G. C. Steward has been appointed assistant lecturer in applied mathematics.

LONDON.—Mr. V. H. Mottram has been appointed as from September 1, 1920, to the University chair of physiology tenable at King's College for Women Household and Social Science Department. He is at the present time head of the Animal Nutrition Laboratory at Messrs. Lever Bros.

Dr. W. S. Lazarus-Barlow has been appointed to the University chair of experimental pathology at Middlesex Hospital Medical School. Since 1903 he has been director of the Cancer Research Laboratories at Middlesex Hospital.

Dr. J. C. Drummond, lecturer in physiological chemistry at University College, has been appointed as from September 1, 1920, to the University readership in that subject.

The following doctorates have been conferred by the Senate:—*D.Sc. in Botany*: Miss Kate Barratt, an internal student of the Imperial College, Royal College of Science, for a thesis entitled "A Contribution to our Knowledge of the Vascular System of the Genus *Equisetum*." *D.Sc. in Chemistry*: Mr. E. E. Turner, an internal student of East London and Goldsmiths' Colleges, for work carried out for British Dyes, Ltd., and the Ministry of Munitions. *D.Sc. in Experimental Psychology*: Mr. G. E. Phillips, an internal student of University College, for a thesis entitled "Mental Fatigue." *D.Sc. in Mathematics*: Mr. G. B. Jeffery, an internal student of University College, for a portion of a thesis: Part ii., "The Motion of a Viscous Fluid," and part iii., "Whittaker's Solution of Laplace's Equation." *D.Sc. in Physics*: Mr. G. D. West, an internal student of East London College, for a thesis entitled "The Forces Exerted on Surfaces Exposed to Radiation." *D.Sc. in Zoology*: Mr. F. J. Wyeth, an internal student of King's College, for a thesis entitled "On the Development of the Auditory Apparatus in *Sphenodon punctatus*."

At the last meeting of the Senate of the University the question of the acceptance of the Government's offer to provide a site at Bloomsbury was again under discussion. A letter was considered from the President of the Board of Education stating that the Government was prepared to continue to be responsible for maintenance, rates, etc., in respect of the new University headquarters buildings, and also, when the time comes for King's College to vacate the existing premises in the Strand, to ask Parliament for authority to purchase the buildings at a fair valuation. The Senate was, however, unable to make a similar offer in respect of the building at present occupied by the University at South Kensington, which (unlike the King's College building) was not erected from funds raised by the University. Eventually the Senate resolved:—"That, while recognising and welcoming the desire of the Government to assist the University, the Senate, in view of the important issues involved and the uncertainty as to the nature of the offer in many respects, desire time for further consideration and consultation with the Government; and that the Government be requested to keep their offer open to allow time for such further consideration."

The following appointments have been made at King's College:—Dr. J. A. Hewitt, lecturer and demonstrator in physiology; Dr. O. Inchley, lecturer in pharmacology; Mr. J. E. Hadfield, lecturer in

psychology; Mr. C. S. Salmon, lecturer in physical chemistry; Mr. H. W. Cremer, lecturer in inorganic chemistry; Mr. W. Partridge, lecturer in chemistry (Public Health); Mr. H. T. Flint, lecturer in physics; Miss C. W. M. Sheriff, assistant lecturer in mathematics; and Mr. L. D. Stamp, demonstrator in geology.

Mr. J. HIGHAM, senior physics master at the Durham Johnston School, has been appointed lecturer in physics and electrical engineering in the University of Manchester.

Mr. E. RAWSON, head of the engineering department of the Portsmouth Municipal College, has been appointed principal of the Municipal Technical Institute, West Bromwich.

Mr. S. MANGHAM, lecturer in botany at Armstrong College, Newcastle-upon-Tyne, has been appointed to the chair of botany at the University College of Southampton.

IN Pamphlet No. 8 just issued by the Bureau of Education, India, Mr. L. T. Watkins deals with "Libraries in Indian High Schools." The pamphlet gives a useful list of selected books, and provides excellent suggestions as to the principles which should govern the choice and classification of volumes for school libraries. Its usefulness should not be limited to India; librarians of schools in the United Kingdom and in other parts of the Empire would find it well worth reading. The pamphlet is published by the Superintendent, Government Printing, Calcutta, and the price is four annas.

The address of Sir E. Sharpey Schafer, of Edinburgh University, on "The University Problem," delivered at Cardiff in January last, and now issued in pamphlet form, deals with a question of grave importance to the educational, and therefore to the social, productive, and political well-being of the nation. Sir Sharpey Schafer pleads for a wider outlook and a clearer vision of the needs of higher education of the university type. He deprecates the idea that universities must find their location in large cities, and pleads for the open air and the countryside as involving far less expense in both sites and buildings, which latter he would plan so as to be of not more than one or two stories in height. In support of his contention he cites the cases of London and Edinburgh, to which may be added those of other cities in the North of England. The ideal environment for a university, he claims, is an academia, a place for undisturbed work whence the sights and sounds of the city are excluded. He alludes to the campus surrounding many an American university, extending from a hundred acres to space to be reckoned in square miles, which often constitutes one of the most beautiful features of the city in which it is situate. Why should not London with its seven million residents have as many university centres as Scotland, Sweden, Ireland, or Yorkshire with far smaller populations? The universities ought to find their financial support in the State, since the education they give is essential to its welfare and an asset of first-rate value. There should be no restriction to the entrance of the genuine, well-qualified student, no matter whence he comes. Original research should be fostered, and only teachers capable of it appointed. The pursuit of new knowledge is essential. The arguments set forth in furtherance of the claims of university teachers and the statements adduced in their support are worthy of serious attention at the present critical time.

## Societies and Academies.

## PARIS.

**Academy of Sciences, July 12.**—M. Henri Deslandres in the chair.—L. Maquenne and E. Demoussy: The catalytic action of copper salts on the oxidation by air of ferrous compounds. Copper salts accelerate the oxidation of ferrous salts by air, even in dilutions so great as 0.2 mgr. of copper per 100 c.c. of solution. The amount of oxidation depends on the nature of the acid present, and is in direct relation with the degree of hydrolytic dissociation.—P. A. Dangeard: Vacuum, plastidome, and spherome in *Asparagus verticillatus*.—F. Vidal, P. Abrami, and M. N. Iancovescu: The possibility of promoting the hæmoclasic crisis by the intravenous injection of portal blood collected during the digestive period. The action of the liver on the proteids of incomplete disintegration arising from digestion and carried by the portal vein. An experimental proof that the gastrointestinal mucous membrane absorbs not only amino-acids, but also compounds in which the proteolysis is incomplete. These products are present in the portal vein for about two hours and a half after a meal, and their injurious action upon the general circulation is prevented by the liver.—H. de Chardonnet: The influence of the American rocking-chair upon the respiration.—J. A. L. Waddell: The economical use of special alloy steels in the construction of bridges. The higher elastic limit of a special steel compared with that of an ordinary carbon steel may more than compensate for the increased price. Some detailed examples are given.—C. E. Guillaume: The anomaly of elasticity of the nickel steels: The realisation of an elinvar and its application to chronometry. The limitations of nickel steel watch-springs are discussed, and a new ternary nickel-chromium steel alloy suggested, containing chromium with small quantities of manganese, tungsten, and carbon equivalent to 12 per cent. of chromium. The results with springs of this material used with a balance-wheel made of a single metal have proved extremely satisfactory. The change of temperature from 0° C. to 30° C. with a watch fitted with one of these springs was two seconds in twenty-four hours, and the rate was practically a linear function of the temperature.—G. Fubini: Projectively applicable surfaces.—L. E. J. Brouwer: Enumeration of the classes of representations of a surface on another surface.—M. Galbrun: The application of the equations of elasticity to the deformations of a helical spring.—P. Chevenard: Study of the elasticity of torsion of nickel steels with a high proportion of chromium. A study of three series of ferro-nickels containing approximately 5, 10, and 15 per cent. of chromium. The results are given graphically in three diagrams.—E. Jouguet: Remarks on the laws of resistance of fluids.—G. Sagnac: The two simultaneous mechanics and their real connections.—M. Panthénier: Study of the ratio of the absolute retardations in carbon bisulphide for increasing durations of charge. The appearance of electro-striction. When the duration of the charge of the Kerr condenser much exceeds a millionth of a second, the ratio of the retardations in carbon bisulphide is no longer equal to -2. The contraction of the liquid under the influence of the electric field, electro-striction, complicates the results; when the time of change is  $8.1 \times 10^{-6}$  seconds, the effect of electro-striction exactly compensates the double refraction for the vibrations perpendicular to the field.—C. Florisson: The galena-metal contact rectifier. Artificial increase of sensitiveness.—H. Weiss: The constituents formed by reciprocal penetration of zinc and copper at a temperature where one of the two metals and all

their alloys are in the solid state. The constant temperature required for these experiments was secured by the use of a sulphur vapour bath under a reduced pressure, the temperature thus obtained varying only at most 1° from 410° C. Micrographic methods were used for studying the resulting alloys, and two photographs illustrating the results are reproduced.—MM. Lespiau and Garreau: The phenylpropines. The reaction between benzyl chloride and the monosodium derivative of acetylene failed to give benzylacetylene, the isomer phenylmethylacetylene being the only product. The same substance was obtained by starting with epibromohydrin and phenylmagnesium bromide and treating the resulting compound,  $C_6H_5 \cdot CH_2 \cdot CBr \cdot CH_3$ , with alcoholic potash. A yield of 40 per cent. of the desired benzylacetylene was obtained by the interaction of phenylmagnesium bromide and propylene tribromide.—G. Mignonnac: The catalytic hydrogenation of nitriles: mechanism of the formation of secondary and tertiary amines. The best explanation of the secondary reduction products arising from the reduction of benzonitrile by hydrogen in presence of nickel and working in an anhydrous liquid is that the primary reduction product is benzaldimine,  $C_6H_5 \cdot CH \cdot NH$ . This can give benzylamine by direct reduction and benzalbenzylamine by condensation, and the latter compound has been isolated in quantity.—G. Zell: The proportional constant relating seismic frequency with rainfall.—R. Abrard: The geological constitution of Djebel Tsefat, Western Morocco.—G. Arnaud: A bacterial disease of ivy, *Hedera helix*.—C. Porcher: Milk and apthous fever. Comparisons of the quantity and quality of the milk from apthous teats of a cow when the milk is retained and drawn off.—A. Vandel: Reproduction of the Planaria and the meaning of impregnation in these animals.—M. de Laroquette: Analogies and differences of biological action of the various parts of the solar spectrum.—C. Pérez: A new Cryptoniscian, *Enthylacus trivinctus*, an intrapallear parasite of a Sacculina. A case of parasitism of the third degree.—J. Dragoiu and M. Fauré-Fremiet: Histogenesis and time of appearance of different pulmonary tissues in the sheep.—G. Bertrand and Mme. Rosenblatt: Does chloropicrin act upon soluble ferments? From experiments carried out with sucrose (from yeast and from *Aspergillus niger*), amygdalinase, urease, catalase, zymase, lactase, and tyrosinase, it was found that chloropicrin exerts only a feeble inhibiting action on soluble ferments, and some other explanation must be found for its highly toxic action upon living cells.

## CAPE TOWN.

**Royal Society of South Africa, July 16.**—Dr. A. Ogg, vice-president, in the chair.—L. Péringuey: Note on a recent discovery of stone implements of Palæolithic type throwing light on the method of manufacture in South Africa. The author described a collection of Palæolithic stone implements from the Montagu Caves, and showed that the completed implement is flattened, rounded at one end and tapering to a point at the other, and being chipped to a sharp edge all the way round. From this demonstration it is now possible to pronounce that many of the implements so far known which are blunt at one part or another are unfinished or damaged specimens. Further, it is shown that a large block was chipped down in order to form a relatively small delicately worked implement, and the very large chipped stones that have sometimes been found are seen to be initial stages in the manufacture.—W. A. Jolly: The reflex times in *Xenopus laevis*. The author described his method of measuring exactly the reflex times in the reflexes from the limbs of the South African clawed frog or toad,

and gave a note of the times ascertained in the decerebrate animal.—C. L. **Herman**: Notes on the Platana of the Cape Peninsula. The marked difference in the shoulder-girdle of the Platana of the Cape Peninsula from that described and figured by Boulenger as appertaining to *Xenopus laevis* was pointed out. The importance of the shoulder-girdle as a basis for systematic classification was referred to, and the probability of this Platana being a primitive form was suggested. The formation of the external nasals was described, and attention directed to the horny epidermal fold on the superior half of the nasals which gives it rigidity. The synchronous contractions of the nasals and the movement of the premaxilla and maxilla were described and their nature was discussed. It was suggested that this occurs in all the *Xenopus*, and the wish was expressed that this remarkable phenomenon, now described for the first time, should be looked for in the case of water-frogs generally.—J. R. **Sutton**: A possible lunar influence upon the velocity of the wind at Kimberley (second paper). In this paper the author continues the investigation described in a previous paper under the same title. A table and a diagram are given showing the deviations of wind-speed at the times of perigee from the monthly means, arranged in hours of the lunar day. The ranges of velocity deduced are somewhat greater than those previously found for the average of all lunar distances. The noon and mid-night perigee curves are remarkable, and suggest that the wind-speed deviations attributable to the moon are largely due to the superimposition of the lunar air-tide upon the diurnal variations of wind velocity. Thus no two different places could be expected to have quite the same velocity deviation curves.

### Books Received.

Observations et Expériences faites sur les Animaux des Infusions. Vol. 1., pp. viii+105. Vol. 2., pp. iii+122. By L. Spallanzani. (Paris: Gauthier-Villars et Cie.) 3 francs each.

Mémoires sur la Respiration et la Transpiration des Animaux. By A. L. Lavoisier. Pp. viii+67. (Paris: Gauthier-Villars et Cie.) 3 francs.

A Junior Inorganic Chemistry. By R. H. Spear. Pp. viii+386. (London: J. and A. Churchill.) 10s. 6d. net.

A Junior Inorganic Chemistry. By R. H. Spear. Part I. Pp. vi+148. (London: J. and A. Churchill.) 5s. net.

Ministry of Finance, Egypt. Survey Department. Contribution à l'Étude des Vertébrés Miocènes de l'Égypte. By R. Fourtau. Pp. xi+121+3 plates. (Cairo: Government Press.) P.T. 20.

University of Iowa Studies in Natural History. Vol. viii., No. 3. Barbados-Antigua Expedition. By C. C. Nutting. Pp. 274. (Iowa City: University of Iowa.)

Archimedes. By Sir T. Heath. (Pioneers of Progress Series.) Pp. ii+58. (London: S.P.C.K.; New York: The Macmillan Co.) 2s. net.

The Nature-Study of Plants in Theory and Practice for the Hobby-Botanist. By T. A. Dymes. Pp. xviii+173. (London: S.P.C.K.; New York: The Macmillan Co.) 6s. net.

Vergleichende Anatomie des Nervensystems. Erster Teil: Die Leitungsbahnen im Nervensystem der Wirbellosen Tiere. By Æ. B. Droggler Fortuyn. Pp. viii+370. (Haarlem: De Erven F. Bohn.) 12.50 guilders.

Euvres Complètes de Christiaan Huygens. Tome

Treizième. Dioptrique 1653; 1666; 1685-1692. Fascicule 1., 1653; 1666. Pp. clxvii+432. Fascicule ii., 1685-1692. Pp. 434-905. (La Haye: M. Nijhoff.)

An Introduction to Chemical Engineering. By A. F. Allen. Pp. xvi+272. (London: Sir I. Pitman and Sons, Ltd.) 10s. 6d. net.

Meddelanden från Statens Skogsförsöksanstalt, Häft 17, Nr. 3. Markstudier i Det Nordsvenska Barrskogsområdet. Bodenstudien in der Nord-schwedischen Nadelwaldregion. By Olof Tamm. Pp. 49-300+4 Tav. (Stockholm: Statens Skogsförsöksanstalt.)

The Institution of Civil Engineers. Abstracts of Papers in Scientific Transactions and Periodicals. New Series, No. 4, July. Pp. 238. (London.)

Conseil Permanent International pour l'Exploration de la Mer. Rapports et Procès-Verbaux des Réunions. Vol. xxvi., Procès-Verbaux (1918-19 and 1919-20). Pp. vi+92. (Copenhague: A. F. Høst et Fils.)

The Statesman's Year Book, 1920. (57th Annual Publication.) Edited by Sir J. Scott Keltie and Dr. M. Epstein. Pp. xliiv+1494. (London: Macmillan and Co., Ltd.) 20s. net.

Wasp Studies Afield. By Phil Rau and Nellie Rau. Pp. xv+372. (Princeton: University Press; London: Oxford University Press.) 8s. 6d. net.

Darkwater: Voices from Within the Veil. By W. E. Burghard Du Bois. Pp. ix+276. (London: Constable and Co., Ltd.) 10s. 6d. net.

The Essentials of Histology: Descriptive and Practical. By Sir E. Sharpey Schafer. 11th edition. Pp. xii+577. (London: Longmans, Green, and Co.) 14s. net.

White Lead: Its Use in Paint. By Dr. A. H. Sabin. Pp. ix+133. (New York: J. Wiley and Sons, Inc.; London: Chapman and Hall, Ltd.) 7s. 6d. net.

### CONTENTS.

	PAGE
<b>A Chemical Service for India.</b> By Prof. Henry E. Armstrong, F.R.S. . . . . .	669
<b>Tycho Brahe.</b> By Dr. J. K. Fotheringham . . . . .	672
<b>Psychological Tests in Industry</b> . . . . .	673
<b>Cultivation of the Vine in America.</b> By V. G. Jackson . . . . .	674
<b>Our Bookshelf</b> . . . . .	674
<b>Letters to the Editor:—</b>	
Genera and Species.—A. Mallock, F.R.S. . . . .	675
The Cluster Pine.—Dr. Michael Graham . . . . .	675
The Training of Practical Entomologists.—Dr. A. D. Imms . . . . .	676
The Separation of the Isotopes of Chlorine.—Angus F. Core . . . . .	677
Anticyclones.—R. M. Deeley . . . . .	677
<b>Solar Variation and the Weather.</b> (With Diagrams.) By Dr. C. G. Abbot . . . . .	678
<b>The Earliest Known Land Flora.</b> (Illustrated.) By Prof. F. O. Bower, F.R.S. . . . .	681
<b>Obituary:—</b>	
Dr. Robert Munro.—E. N. Fallaise . . . . .	685
<b>Notes</b> . . . . .	686
<b>Our Astronomical Column:—</b>	
The Date of Easter . . . . .	691
Astronomy in Town Planning . . . . .	691
<b>The Empire Timber Exhibition.</b> By Alexander L. Howard . . . . .	691
<b>The Education Act, 1918—London County Council Draft Scheme</b> . . . . .	693
<b>The Society of Chemical Industry</b> . . . . .	695
<b>Imperial Cancer Research Fund</b> . . . . .	696
<b>Liverpool School of Tropical Medicine</b> . . . . .	696
<b>Central Headquarters for British Chemists</b> . . . . .	697
<b>University and Educational Intelligence</b> . . . . .	697
<b>Societies and Academies</b> . . . . .	699
<b>Books Received</b> . . . . .	700



THURSDAY, AUGUST 5, 1920.

*Editorial and Publishing Offices:*

MACMILLAN &amp; CO., LTD.,

ST. MARTIN'S STREET, LONDON, W.C.2.

Advertisements and business letters should be  
addressed to the Publishers.

Editorial communications to the Editor.

Telegraphic Address: PHUSIS, LONDON.

Telephone Number: GERRARD 8830.

**University Grants.**

A FEW weeks ago (June 17, p. 477) reference was made in these columns to the financial position of the Universities and institutions of University rank, and a plea was put forward for more adequate Government financial support. We are not unmindful that the Government has already recognised that it has responsibilities in this respect, but we greatly doubt whether it has fully realised their extent. The majority of these institutions are of comparatively recent foundation, and from the first have led a precarious existence; restricted resources and even poverty have almost uniformly been their lot. Nevertheless, they have ministered to the needs of higher education in a truly remarkable way; they have helped this country to hold its own in the face of world competition, and materially contributed to its success in the Great War. This being so, one would think that the encouragement and development of higher education would be among the first and primary cares of the Government. While we believe that this really is the intention, yet, if we may judge from certain proposals recently made, the Government does not fully appreciate the present state of affairs in the Universities. Apart from the question of new and additional accommodation due to the great influx of students, and altogether apart from the necessities of internal development which are yearly becoming more and more insistent, there stand out the dominant facts that the great body of University teachers are quite inadequately remunerated, and that there are no really practicable sources which can be tapped to provide proper and adequate emoluments for them. It is within our knowledge that the present economic position is pressing most severely upon a large number of University teachers, and that the financial position of many Universities is precarious.

If there is one thing more than another which  
NO. 2649, VOL. 105]

has been insistently pressed upon the University Grants Committee on its visitations—and, we are glad to say, has uniformly received a sympathetic hearing—it is this question of inadequate remuneration. A University is essentially a corporation of men and women, and if the teaching side of this corporation is dissatisfied or labours under a sense of injustice, its work loses its spontaneity and efficiency, and the interests of higher education, and with them those of the nation, will suffer in consequence. Obviously this is a truism which need not be laboured. When men and women have to eke out inadequate stipends by extraneous work the effects, though almost imperceptible at first, are bound to be serious in the long run. But this is not all. Inadequate remuneration reacts unfavourably upon the supply of efficient teachers. Talented young students will look elsewhere for their life's work. Already, as we have indicated on a previous occasion, the financial inducements of industry have depleted the Universities of some of their ablest teachers, and there are no uncertain indications that this depletion is likely to become more serious still.

Now, the Chancellor of the Exchequer recognises that the Government must do more, and he proposes to ask Parliament to increase the Treasury grant-in-aid from 1,000,000*l.* to 1,500,000*l.* in the Estimates for 1921-22. He does not propose to ask for any supplementary grant this year. We respectfully submit that this proposal is totally inadequate. As a matter of fact, we would point out that Parliament is not to be asked for a larger sum than is given this year; what is proposed is simply to make the non-recurrent 500,000*l.* recurrent. We repeat that such a sum is totally inadequate for present needs. A recent statistical inquiry instituted by the Association of University Teachers has elicited the fact that the average salary at present paid to an assistant lecturer is 250*l.*; to a lecturer, 366*l.*; and to a professor, 800*l.*, from which, of course, must be deducted the superannuation premiums of 5 per cent. or so. When we consider the largely increased salaries paid to teachers in other branches of the profession, let alone the inducements offered in industry, it is obvious that such average salaries will not attract the right type of teacher to the University in the future. We repeat that the proposed grant-in-aid is absolutely inadequate under present economic conditions, and would respectfully urge upon the Chancellor of the Exchequer to reconsider the whole question.

If this is the case regarding the general financial

position, what must be said about the question of superannuation? A short time ago a deputation consisting of representatives of the governing bodies of the Universities and institutions of University rank in England and Wales, together with representatives of the Association of University Teachers, waited upon the Chancellor of the Exchequer to put before him certain proposals regarding the present unsatisfactory state of superannuation in the Universities. Briefly these proposals were to the effect that the Government should grant University teachers the same, or similar, superannuation benefits as already granted to other branches of the profession under the School Teachers (Superannuation) Act, 1918, plus certain other benefits which the University teachers were prepared to pay for themselves by an annual premium on their salaries. The deputation was a most representative one and absolutely unanimous in its proposals. We now understand that the Chancellor is "prepared to consider the advisability of proposing to Parliament a further non-recurrent sum to assist the Universities in meeting the grievance of those senior members who are precluded from profiting to the full by the Benefits of the University Superannuation Scheme." At the same time, it is announced that the Council of the Federated Superannuation System of the Universities has undertaken to obtain the information upon which the proposed non-recurrent grant will be made.

In all this there is not a word about giving University teachers the same, or similar, privileges that school teachers have in their non-contributory Government scheme. Not a word about facilitating the transference of teachers from the schools to the Universities or from the Universities to the schools, so that there would be no loss of superannuation benefits on the transference. Not a word about full retrospective benefits, irrespective of whether the service has been in schools or in Universities. Not a word about the consequent unity of the teaching profession. It would seem that the policy is to make such transference as difficult as possible. Now, obviously such a policy cannot be in the interests of education. It may be that we have placed too narrow an interpretation upon the words quoted above. We hope so. For, unless we are profoundly mistaken, the great bulk of the University teachers will be bitterly disappointed if the Government does not at least grant them benefits equivalent to those already granted to 95 per cent. of the teaching profession in the country.

NO. 2649, VOL. 105]

### Tanks and Scientific Warfare.

*Tanks in the Great War, 1914-1918.* By Brevet-Col. J. F. C. Fuller. Pp. xxiv+331+vii plates. (London: John Murray, 1920.) Price 21s. net.

THIS remarkable book is a clear and straightforward history of how the British Army learnt to use the most revolutionary weapon the great war produced. It is written by a confirmed believer in that weapon, whose belief probably became more and more complete as the Tank Corps gradually grasped a few of the principles involved in its use. It is somewhat of a pity that the author does not devote a chapter to the process by which the Tank Corps arrived at the tactics which eventually proved so successful. It took something like two years to overcome the prejudices raised against tanks in official quarters, and this in war-time, when progress is relatively rapid compared with that in peace. It is therefore to be hoped that the principles so ably set forth by Col. Fuller, and so well proved in the late war, will never again be overlooked.

It is only natural that it took many months for the Tank Corps to evolve anything like effective tank tactics. Many methods had to be tested in battle before being discarded, and it is not unusual, but rather a matter for congratulation, if the tactics evolved for the battle of Hamel were primarily suggested by the Australians, for it serves to show the close co-operation obtained, and the openmindedness of those in the Tank Corps to adopt the suggestions of others.

The history of tank tactics is an instance of how an effective weapon may be entirely wasted unless its use is understood. As to how much blame attaches to the Tank Corps for the use of tanks in the Ypres salient and similar misuses up to the first battle of Cambrai the author is silent, nor does it matter much, except that it serves to show how necessary it is for the expert on the new weapon to have some say in such matters. However, if, as Col. Fuller says on p. 58, the following lessons were learnt as the result of the first use of tanks on the Somme in 1916, especially No. 2, then the later tank actions need a lot of explanation.

The battle of Cambrai, although it demonstrated what tanks in numbers over good ground and without a preliminary bombardment could do, yet would have been a far greater success had the tank tactics as finally adopted at the battle of Hamel been in use. There is no question that the town of Cambrai itself would have been taken on the first day of the attack had proper co-operation with the infantry been maintained. The

hold-up of tanks at Flesquières (p. 149) would not have taken place had the infantry been following the tanks closely, and could also have been got over by the tank crews getting out of their machines and stalking the field-gunner as infantry. The infantry on this occasion were several hundred yards behind!

This book makes one hope that someone will write the history of tanks from the civilian point of view. Read in conjunction with this excellent work, some of the more obvious mistakes in the past might thus be avoided in the future. It is now common knowledge that neither the War Office nor G.H.Q. welcomed "tanks," although it might be inferred from this book that they did so. The tank was fathered by the Navy, and had reached success before it was handed over. Its history was briefly as follows, and it is illuminating how little the Army contributed.

In Mr. Winston Churchill's letter to the Prime Minister of January, 1915, he remarks: "It is extraordinary that the Army in the field and the War Office should have allowed nearly three months of warfare to progress without addressing their minds to its special problems." It was extraordinary, and more so when they turned down any proposals made to them for breaking down the "trench warfare" into which both armies had settled. Mr. Winston Churchill made direct reference in this letter to armoured caterpillars and the way in which they should be employed.

There were many schemes put forward for carrying out this suggestion, but the successful one was produced by Major W. G. Wilson, who was then a lieutenant, R.N.V.R., in the Royal Naval Armoured Cars. Working in conjunction with Mr. (now Sir) William Tritton at the works of Messrs. Foster, of Lincoln, the machine was constructed and afterwards demonstrated at Hatfield. The designers called for a statement from the Army as to the width of trench to be crossed, height of parapet to be climbed, etc., and this was drawn up by Col. Swinton, who stands out at this time as practically the only champion tanks had in the Army.

Although the Navy fathered the production of the first tank, it was equally fortunate that after its success had been demonstrated at Hatfield to representatives from the War Office and G.H.Q., France, the future of tanks was entrusted to Sir Albert Stern. It was he who, when the first order for tanks was cancelled by the War Office, refused to cancel the order, and said he would, if necessary, pay for them himself.

Again, fate was kind to them on their first venture at the battle of the Somme. On Sep-

tember 15, 1916, two companies, each consisting of twenty-eight tanks, went into action. The company commanded by Major Summers got twenty-two machines into action, but only two of the other company crossed into No-man's Land. It is more than likely that, but for the efforts of Summers and his technical officer, Knothe, tanks would have been voted a failure and never given another trial. It is worth noting that both these officers were, prior to the war, civilians.

Again, it seems never to have been pointed out how the Army authorities failed to grasp the full importance of other proposals of the tank tribe. In 1916 the need of the moment was such protection against the machine-gun, but the early pioneers of the tank movement saw far greater possibilities in the caterpillar track. It was evident that roads and railways were the serious limiting factors to our armies. All supplies had to go by rail and road, and as these could be destroyed by the enemy's long-range artillery, the obvious need was for an alternative—something that could do without road or rails, and cross ploughed fields, shelled areas, hedges, and small rivers. The caterpillar track as used on tanks had been proved to be capable of doing this. Rightly or wrongly, the first attempt was made to design a caterpillar gun-carriage that would take a 5-in. gun or a 6-in. howitzer, or alternatively could be used to carry a large number of rounds of ammunition for either of these guns. It was designed so that the gun could be trained and fired from this movable platform, and the whole be capable of crossing shell-holes and trenches like the tank. The machine was tested at Shoeburyness, the gun being fired and trained with ease. Its value was never realised, and the scheme was allowed to drop. True, fifty machines of the first type were built, but nothing was ever made of the generic idea, and a second improved type, in which the faults of the first had been overcome, was allowed to lapse.

In the autumn of 1918 the value of a cross-country tractor was realised to the extent that many thousands were ordered here and in the U.S.A., but again "realisation" came too late, and none materialised.

As already stated, the Tank Corps insisted in interfering with design, with the result that progress and output were adversely affected. In numerous cases its wishes were followed, such as the change over from the Hotchkiss to the Lewis gun, the lengthening of the Mk. V. by 6 ft., the turning down of the G.C. Mk. II., and the Mk. IX. machine built to its requirements, and the results were, to say the least, serious.

However, Col. Fuller makes no comment on these points, but doubtless he would agree that in the future the Tank Corps in the field should confine itself to the problem of fighting the machine most effectively, and to giving the fullest possible information to the Headquarters Staff on which it may base its tactical requirements for the future classes of machines, these requirements to be conveyed to the designing department. How far such requirements can be met is for the designing and production departments to decide.

Much has been said about the use of tanks in small numbers at the battle of the Somme, and Col. Fuller is evidently of opinion that, had we held them back until large numbers were available, the element of surprise would have been so great as to have led to an overwhelming victory. The same might be said of the German use of gas for the first time against the Canadians. Personally, the present writer does not hold this view. A new weapon that is going to produce an overwhelming effect requires not only its use on a large scale, but also close co-operation with all other arms. This requires time and elaborate training, and training without the experience of actual battle is apt to be very misleading.

Mk. IV. tanks successfully took part in the decisive battles of the summer and autumn of 1918. It was this mark of machine that in 1917 the Tank Corps refused to accept, considering it useless. A little training in the proper way to fight with the new weapon had made all the difference. It was the Mk. IV. tank which carried out the brilliant operations with the Canadians in crossing the Canal du Nord in September, 1918 (see pp. 268-69). The officer in command of the Canadians after the battle sent for the officer in charge of these tanks and complimented him on the handling of the "new" type of tank and on the way in which all objectives were reached; the officer was silent, for they were the old Mk. IV. machines. The Mk. V. machine was a very great advance on the Mk. IV., but the greatest improvement of all was the realisation of how to use the new weapon in co-operation with the infantry.

Col. Fuller's book naturally deals chiefly with the fighting tank, and he clearly sets forth the claims of armour propelled by petrol as a protection and means of transport for the infantry against the machine-gun; but, as the author also points out, the German offensive of March, 1918, came to an end not so much on account of our resistance as because of the impossibility of bringing up artillery and supplies fast enough by the limited roads. The army of the

future will be independent of roads and rails. Its artillery, supplies of shells, food, ambulances, etc., will be moved by petrol and caterpillar tracks.

The chapter on scientific warfare makes interesting reading. It might lead one to suppose that the wars of the future will be waged between small but highly trained armies, and that civilians will be carefully evacuated and safeguarded. The lesson of the late war seems to show that it will be impossible to protect civilians and increasingly difficult to discriminate between the trained warrior and women and children. The use of gas over large areas, of explosive dropped by aircraft, of huge tanks and tractors dashing over hill and dale, in their course passing over hamlets and villages, seems to make the lot of the non-combatant an unenviable one. Possibly this is all for the best, and certainly so if it acts as a deterrent to future wars.

In conclusion, one must say that the book is most excellent reading and remarkably free from controversy or axe-grinding. It has been said that the indication of the object of a war book can be got from the frontispiece. Many have a portrait of the writer, but this starts with a picture of the weapon which had such an effect on history, and the book is a valuable tribute to it (see p. 48).

### Physiology of Farm Animals.

*Physiology of Farm Animals.* By T. B. Wood and Dr. F. H. A. Marshall. Part i. *General.* By Dr. F. H. A. Marshall. Pp. xii + 204. (Cambridge: At the University Press, 1920.) Price 16s. net.

**S**UCCESS in the rearing and feeding of animals depends to a large extent upon the practical application of the principles of physiology. Yet, although the breeding of farm animals and the production of meat and milk are of such great economic importance, the study of the physiology of farm animals has received comparatively little attention. The appearance of this text-book is, therefore, welcome. The reputation of the writers is likely to secure a wide use of the book in agricultural teaching centres.

The first volume deals with the general principles of physiology. It is lucidly written, and the illustrations are well chosen. The parts of the subject most fully treated are those which are of special practical importance, viz. the digestive system, the organs of locomotion, and the organs of reproduction. A clear account is given of the digestive system. The chapter on the organs of locomotion contains a very useful

description of the feet and legs of the horse, and the nature and causes of certain common ailments are indicated. The last two chapters, dealing with reproduction, are the best in the book. In addition to giving in a small compass and in an easily understood form all that is known of practical importance, they contain many suggestions that should be of great value to the breeder. A chapter on heredity would have added to the value of the book.

The other parts of the subject are dealt with more briefly, yet in sufficient detail to give the student of agriculture a working knowledge of the subject for all practical purposes.

In a few instances too little attention has been given to recent literature. The use of the term "amides" as covering the non-protein nitrogenous substance of feeding-stuffs is unfortunate. Although the term was used in this sense by certain of the older writers, it is no longer appropriate, since it is now known that the greater part of the non-protein nitrogenous substances consist of amino-acids, which, instead of being "of little importance as constituents of food," are as valuable as protein. The views put forward with regard to the metabolism of creatine and creatinine, which are largely those advanced by Mellanby some years ago, take no account of the work that has been done during the past ten or fifteen years. There is now no doubt that muscle, and not liver, is the chief seat of metabolism of both creatine and creatinine, and there is no experimental evidence in support of the view that creatine is formed from creatinine. The statement that creatine is found in the urine only in pathological conditions is scarcely correct, at least for farm animals. Creatine is found in the urine of the fowl, where it replaces creatinine, and it is a normal constituent of the urine of ruminants.

These, however, are points of minor importance so far as the student of agriculture is concerned. They are likely to be treated more fully in the second volume dealing with nutrition.

### Chemical Text-books.

- (1) *Laboratory Manual of Elementary Colloid Chemistry*. By Emil Hatschek. Pp. 135. (London: J. and A. Churchill, 1920.) Price 6s. 6d.
- (2) *Chemistry for Public Health Students*. By E. Gabriel Jones. Pp. ix+244. (London: Methuen and Co., Ltd., 1920.) Price 6s. net.
- (3) *Elementary Practical Chemistry. For Medical and other Students*. By Dr. J. E. Myers and J. B. Firth. Second edition, revised. (Griffin's Scientific Text-books.) Pp. viii+194. (London: NO. 2649, VOL. 105]

Charles Griffin and Co., Ltd., 1920.) Price 4s. 6d.

- (4) *Qualitative Analysis in Theory and Practice*. By Prof. P. W. Robertson and D. H. Burleigh. Pp. 63. (London: Edward Arnold, 1920.) Price 4s. 6d. net.
- (5) *Practical Science for Girls: As Applied to Domestic Subjects*. By Evelyn E. Jardine. Pp. xiii+112. (London: Methuen and Co., Ltd., 1920.) Price 3s.
- (6) *Acids, Alkalis, and Salts*. By G. H. J. Adlam. (Pitman's Common Commodities and Industries.) Pp. ix+112. (London: Sir Isaac Pitman and Sons, Ltd., n.d.) Price 2s. 6d. net.
- (1) **G**RAHAM'S pioneer work on colloids is bearing rich fruit to-day, and colloid chemistry is becoming more and more important in theory and in practice. There are, of course, several text-books dealing with the subject generally, and giving descriptions of methods used in preparing colloidal substances. Mr. Hatschek himself is known as the author of one of these, and as the annotator of another, besides being the writer of a notable series of articles on colloids. There is, however, no laboratory manual similar to the present work. To expound the theory of the matter, lectures are good things, and books necessary; but the laboratory remains always the "forecourt of the temple" of colloid philosophy; it is only there that the student gains real familiarity with the characteristic properties of colloidal substances. And in the laboratory a well-devised series of practical exercises is invaluable for economising the worker's time, sparing his temper, and leading him to good results. The author's aim has therefore been to give "accurate and very detailed" directions for carrying out the fundamental operations. He is qualified to write a manual based upon personal experience of the special difficulties met with in the practice of this branch of chemistry, and he has done it very well. Both students and teachers have reason to be grateful to him.

(2) This, also, is essentially a laboratory guide. It is intended for students reading for the diploma in public health, and is therefore concerned generally with foodstuffs, water, alcoholic beverages, sewage effluents, air, and disinfectants. After two introductory chapters explaining the principles of gravimetric and volumetric analysis, the important foodstuffs milk, butter, and margarine are dealt with. Facts as to the chemical composition of these are given, and the legal enactments relating to the sale of them, together with the usual methods of analysis adopted. Then follow chapters on the other articles mentioned. Naturally in a book of only 240 pages some of the subjects

cannot be treated very fully. The information given, however, is accurate, and, whilst the book is readable, it is by no means superficial. Indeed, for a work of its scope it is substantial, and the reviewer has formed a very favourable opinion of it. One of the best sections is the chapter on air, but all are good. A number of examination questions are included.

(3) Dr. Myers and Mr. Firth's little book has become favourably known as a convenient introductory work on practical chemistry. The ground covered is elementary qualitative and quantitative analysis, including an outline of simple gas analysis, with methods for making "preparations" and for identifying the commoner organic compounds. It gives the requisite information concisely, and can be recommended as a suitable initiatory book for medical and pharmaceutical students.

(4) Messrs. Robertson and Burleigh's book is of a more advanced type than the foregoing. It treats of qualitative analysis only, but aims at giving the student a thorough grounding in this subject. The authors rightly hold that qualitative chemical analysis, intelligently taught, is of great value in laying a good foundation for a knowledge of the general chemistry of the metals and in illustrating the more important types of chemical reactions. Their method is to familiarise the student with these types (replacement, decomposition, oxidation, and reduction), and thus to enable him to see how they are applied to the problems of systematic analysis. They discard "dry" tests (apart from flame reactions) as being "tedious, often ambiguous, and misleading." They look with disfavour upon the practice of describing in detail, with equations, the individual reactions of the metals. The practice, they contend, is "pernicious and demoralising"; and the student, in the end, "simply copies into his notes what he sees in his text-book." It is by no means clear why this should be so. Surely it is the part of a capable teacher to find out, by a few suitable questions, whether a student really understands what the equations signify? If this is done there appears to be no particular objection to describing the individual reactions, and such a course simplifies the work of explanation. But be that as it may, there is no doubt that the student who works intelligently through the book under notice should obtain a good grasp of the matter. The questions propounded at the end of the sections will search out his weak points.

(5) This little book contains instructions for performing a series of simple exercises in physics, chemistry, and bacteriology. As occasion offers, the principles under discussion are applied to, or

exemplified by, domestic subjects. Thus, having learned various methods of determining specific gravity, the student uses some of them to find the density of milk. In connection with thermometry she learns how to use a clinical thermometer. In the chemistry exercises she is taught how to make soap, how to remove stains from calico, and so on.

The exercises are carefully graduated, and, on the whole, are well calculated to stimulate the pupil's interest. Here and there the text needs a little revision. Thus the experiment (3) on p. 45 is meaningless as it stands. A weighed quantity of household "blue" is mixed with water, the mixture evaporated to dryness, and weighed. The student is then asked to state the percentage of "blue" dissolved! Again (p. 59), permanently "hard" water is directed to be made by dissolving *common salt* in distilled water. Then, after the naïve remark that "we have used salt because it is convenient," the pupil is taught how to "soften" (such) permanently hard water by means of washing-soda. These exercises should be revised; they do not bring out the essential fact that it is the soluble salts of calcium and magnesium, not those of sodium, that cause permanent hardness. "Of the nitrogenous foods there are protein, water, and salts" (p. 70) is a cryptic saying; and it is not the only one. The impression given is that the author occasionally gets a little out of her depth; but the book as a whole will be found quite useful and convenient.

(6) At first sight the title "Acids, Alkalis, and Salts" appears rather unattractive—except perhaps to the chemist, who knows these products already. Mr. Adlam, however, manages to make quite a readable little volume on the subject. Many valuable works will, alas! always and necessarily be classed with the "books that are no books," since they must give the dry bones of facts, and no space is available for investing these facts with even a bare minimum of literary covering. This book, however, aims at being not only instructive, but also interesting. Though starting with little or no knowledge of chemistry, the general reader will have no difficulty in understanding the text, and will find in it a store of information concerning the acids and alkalis which is none the less trustworthy because it is easily and pleasantly acquired. The book may, in fact, be looked upon as a simple introduction to the subject of industrial chemistry. Incidentally, it may help to prevent other people following the example of the man mentioned by the author, who took his son to the Royal School of Mines to "learn copper," and not to waste his time over other parts of chemistry, because "they would be of no use to him."

C. S.

## Our Bookshelf.

*Die Gliederung der Australischen Sprachen: Geographische, bibliographische, linguistische Grundzüge der Erforschung der australischen Sprachen.* By P. W. Schmidt. Pp. xvi+299. (St. Gabriel-Mödling bei Wien: *Anthropos*, 1919.)

IN this reprint from *Anthropos* Father Schmidt discusses the structure and classification of the Australian languages. Of these he distinguishes two main divisions, the South Australian and the North Australian. The former comprises the languages of the southern halves of Western and South Australia, of Victoria and New South Wales, and the greater (southern) part of Queensland. The North Australian occupies North-west and Central Australia, the Northern Territory, and Cape York Peninsula. The southern languages are subdivided into twelve groups, the northern into three.

The establishment of the South Australian is based mainly on the likeness of grammar and the occurrence in the languages of similar words for names of parts of the body and personal pronouns. The differences in the various subdivisions are found to run parallel with the sociological grouping. They consist chiefly in the character of the finals, which are vocalic where the purely two-class system and mother-right prevail. In the west, north-east, and centre the finals *l*, *n*, *r* are found with the four-class system, and the two-class system in the south-east is found where the languages have final explosives and double consonants.

The northern languages are similarly grouped according to their final consonants. In the north-west and north, consonantal finals are common, around Carpentaria *l*, *n*, and *r* are found as finals, and vocalic endings are common in Central Australia and Cape York Peninsula. But isolated members of the groups are found all over northern Australia.

Father Schmidt's work is a valuable summary and exposition of the tangle of Australian linguistics. But the nature of the material is so uncertain that there will always be a doubt as to whether the similarities of the South Australian languages here formulated may not be due to their geographical contiguity, one language borrowing vocabulary from others, and all alike gradually assuming the same morphological form.

S. H. RAY.

*A First Book of School Celebrations.* By Dr. F. H. Hayward. Pp. 167. (London: P. S. King and Son, Ltd., 1920.) Price 5s.

THIS is a sequel to "The Spiritual Foundations of Reconstruction," and shows in further detail how some of the suggestions of that interesting book will work out in practice. It may be recalled that the authors—Dr. Hayward and Mr. Freeman—there insisted on the obviously sound idea that in school education more should be made of the emotional, artistic, dramatic, and social

approach. They believe, indeed, in scientific and historical wall-charts, the gist of which seeps in to the mind through the eye; they believe in lessons that appeal to the reason—the lessons which bear so little fruit that many of us are often inclined to disbelieve in them; but their hope is in a vast extension of the principle already embodied in Empire Day, Shakespeare Day, and St. David's Day celebrations. Dr. Hayward looks forward in the present book to a national school liturgy of the Bible, literature, music, and ceremonial. The ceremonials would be predominantly oral rather than visual, consisting largely of reading and recitation, song and story; they will be memorial, expository, seasonal, and ethical. It must not be supposed that the author's suggestions depreciate the appeal to reason or propose to codify the emotions; what is suggested is wise and well thought out. We know a little about schools, and our conviction is that the methods suggested would grip in a way that nothing except the teacher's personal influence has hitherto done. They would grip because they are psychologically sound. The celebrations outlined are skilfully devised, but individual teachers would of course vary them. They deal with Shakespeare, the League of Nations, Democracy, St. Paul, bards and seers, world conquerors, Samson, eugenics, temperance, commerce, summer, flying, Chaucer, Spenser. The author has made a notable contribution to the experimental study of education. To test the value of this contribution is an urgent duty, for the school is not very perfect as it is.

*New Zealand Plants and their Story.* By Dr. L. Cockayne. Second edition, rewritten and enlarged. (New Zealand Board of Science and Art. Manual No. 1.) Pp. xv+248. (Wellington, N.Z.: Dominion Museum, 1919.) Price 7s. 6d.

THE earlier edition of this book, published in 1910, was described as the first attempt to deal with the plant life of the New Zealand biological region on ecological lines. The second edition is virtually a new book. As an instance, the number of photographs which form so helpful an addition to the text has been increased to ninety-nine, and fifty of these did not appear in the original work. But the author and his subject are the same, and no one is so well qualified to describe New Zealand plant ecology as Dr. Cockayne.

An introductory chapter gives an account of the history of the botanical exploration of the islands from the first visit of Banks and Solander in 1769. Successive chapters are devoted to the various phases of vegetation—the sea-coast, the forests, the grass-lands, high mountains, and others—and a brief account of the vegetation of the outlying islands is given. The author discusses the changes which have taken place in the vegetation since the advent of the British, and strongly opposes the idea that the original New Zealand flora is in danger of being crushed out by European immigrants. On the contrary, practically "no truly

primitive plant formation is desecrated by a single foreign invader." The concluding chapters deal with the division of the islands into botanical districts, and the affinities, origin, and history of the flora. As regards the latter, Dr. Cockayne admits the necessity of great land extension in the Antarctic direction.

*Annual Reports on the Progress of Chemistry for 1919.* Issued by the Chemical Society. Vol. xvi. Pp. ix+234. (London: Gurney and Jackson, 1920.) Price 4s. 6d. net.

ONE of the most useful of the publications issued by the Chemical Society is the annual volume summarising the progress made each year in the various main branches of chemistry. With this bird's-eye view of the year's achievements at command, a worker is readily able to survey, in something like proper perspective, the advances made in other divisions of the science as well as in his own.

The period covered by the present volume synchronises with the return of many scientific workers from occupations connected more or less directly with the conduct of war to conditions which, in due time, will no doubt lead to a full resumption of scientific investigation for its own sake. Meanwhile it is too early to expect accounts of many such researches. For the moment, the aftermath of war work is being shown in papers dealing with technical problems on which chemists have worked during the last few years. There is, nevertheless, a fair amount of purely scientific research work recorded. Rutherford's investigations on atomic disintegration are of fundamental importance if the results are eventually confirmed; and other notable pieces of work are the studies on the "poisoning" of palladium as a catalyst by hydrogen sulphide, on the origin of alkaloids from amino-acids, and on fermentation. In the "crystallography" section, it may be noted, a good description is given, with figures, of the principles underlying X-ray methods of exploring crystal structure.

*The Ascent of Man: A Handbook to the Cases illustrating the Structure of Man and the Great Apes.* (London County Council.) Pp. 74. (London: The Horniman Museum and Library, n.d.) Price 6d.

THIS little handbook, by Dr. H. S. Harrison, curator of the Horniman Museum, is written in simple language, and admirably suited to stimulate interest in the recent remarkable progress in our knowledge of the ancestry of man. The bibliography with which it concludes will also be helpful to those who wish to pursue the subject further. Dr. Harrison emphasises the fact that man must be traced back to small arboreal mammals, and well observes: "It is scarcely too much to say that if the earth had borne no trees, there would have been no men." His anatomical descriptions are made readable and interesting by his frequent references to habits and modes of life.

A. S. W.

## Letters to the Editor.

[The Editor does not hold himself responsible for opinions expressed by his correspondents. Neither can he undertake to return, or to correspond with the writers of, rejected manuscripts intended for this or any other part of NATURE. No notice is taken of anonymous communications.]

### Relativity and Reality.

No one would wish to strain at a gnat. If the relativist finds it convenient to make the time-axes of his four-dimensional medium the pure imaginary direction by writing  $t = \tau\sqrt{-1}$ , that would appear to be a matter of indifference, so long as for each co-ordinate a single line or axis still suffices to indicate the values that  $x$ ,  $y$ ,  $z$ , and  $\tau$  can bear. But the matter becomes complicated as soon as we project in oblique directions. Thus take the equations of the "restricted" relativity theory,

$$x = \beta(x' - ut'), \quad t = \beta(t' - ux'), \quad \beta = (1 - u^2)^{-1/2},$$

which upon substitution become

$$x = x'(x' - iur'), \quad \tau = \beta(\tau' + iux'),$$

and these can be written

$$x = x' \cos \theta - \tau' \sin \theta, \quad \tau = x' \sin \theta + \tau' \cos \theta,$$

if  $\tan \theta = iu$ .

Thus  $(x, \tau)$  ( $x', \tau'$ ) are co-ordinates of the same point projected upon different axes, but not in any real direction. According to this system, A can grasp B's scheme of space-time only when he generalises his own  $x$ ,  $y$ ,  $z$ ,  $\tau$ , so that each of them stands for an unrestricted complex variable. But such a removal of restriction cannot be pictured without allotting a whole plane to each variable, and that means doubling our whole apparatus of representation and a description of events in terms of not fewer than eight real dimensions. Surely no physicist can be expected to take the system seriously.

The mathematician does not seem to be aware that he is asking one to swallow a camel. Thus in Prof. Eddington's recent book, "Space, Time, and Gravitation," we read (p. 48): "The observer's separation of this continuum into space and time consists in slicing it in some direction . . . clearly the slice may be taken in any direction; there is no question of a true separation and a fictitious separation." But there is the qualification, which surely deserves mention, that every real direction must be excluded, since the angle  $\theta$  is necessarily imaginary, because  $\beta$ , which is greater than unity, is its cosine. The original passage from  $(x, t)$  to  $(x', t')$  is real, and we get back to reality by slicing in an imaginary direction with respect to an imaginary axis. The device should be classed with the focioids, those two imaginary points at infinity where any two concentric circles touch. They recall to the mathematician's mind certain algebraic forms, but have no other actuality whatever. The point I would make, however, is this: If this analogy is dropped, the idea of time as a fourth dimension is not in any way advanced by the interpretation of the equations above from the position it has occupied since the days of Lagrange.

R. A. SAMPSON.

Royal Observatory, Edinburgh, July 26.

### An Attempt to Detect the Fizeau Effect in an Electron Stream.

WITHOUT in any way touching the theoretical aspect of the case, it seems worth while to put on record the null result of an experiment to see whether the Fizeau effect was present in the case of a beam of light passing along a rapidly moving stream of electrons.

A pair of Jamin plates giving a separation of the



interfering beams of 33 mm. was set up so as to produce achromatic fringes from the light of a mercury-vapour lamp.

Two tubes each about 100 cm. long, with worked glass plates cemented on the ends, were placed parallel, one in each of the interfering beams. Each tube was evacuated, but one contained a glowing cathode and a cylindrical anode which were connected to an alternating source of potential capable of delivering about 20 milliamperes at 100,000 volts, or alternatively 200 milliamperes at 5000 volts, these two potentials corresponding to electron velocities of about  $2 \times 10^{10}$  cm./sec. and  $4 \times 10^9$  cm./sec. respectively.

The method of experiment was to produce wide fringes in the observing telescope, and, by means of two tapping switches, to turn on first the filament-heating current and then the applied potential. In no case was any shift or certain broadening of the fringes observed.

The main difficulty in the experiment was the frequent fracture of the necessarily small glass tube employed as the result of the great heat dissipated inside.

R. WHIDDINGTON.

The Physics Laboratories, The University,  
Leeds.

#### Plant-life in Cheddar Caves.

WHILE recently visiting the famous caves at Cheddar I noticed small patches of moss-like vegetation growing near the electric lamps used to illuminate the caves. The caves extend a long way into the hill-side, and, as the entrances are but small, daylight penetrates into them to a very short distance only. They are lighted by wire filament electric lamps, of which some are hung from the roof, but many are laid upon their sides in the deep natural recesses, and, in order better to illuminate the formation and bring up the beautiful colouring and folding of the stalactites, are provided with reflectors. It was close against some of these lamps that I noticed the patches of vegetation, and they looked so strange that I asked the attendant if they had been placed there as an experiment. His answer was that they had not, and that he himself had noticed them growing near the lamps.

It seems to me to be curious that this vegetation should be flourishing under such absolutely artificial conditions where there is no trace of daylight. How the spores got so far in is also an interesting point, but possibly they were introduced by dirty spades used when the workmen were digging out the latest extension of the caves.

I should be glad to know if this curious phenomenon has been observed before, and what kinds of plant-life succeed in these unnatural conditions. As one of the excursions during the forthcoming meeting of the British Association at Cardiff will be to the Cheddar Caves, perhaps a botanical visitor will identify the growth and communicate his conclusions to NATURE.

LOUGH. PENDRED.

#### The Diamagnetism of Hydrogen.

IN a letter to NATURE of July 22 (p. 645) Dr. Ashworth discusses the atomic diamagnetism of liquid and gaseous hydrogen on the hypothesis that diamagnetism originates from rotations or oscillations of the paramagnetic atom or molecule. He ignores, however, the case of atomic hydrogen in normally saturated hydrocarbons given in my letter of July 8 (p. 581). The atomic susceptibility of hydrogen in these compounds is *constant and equal to*  $-30.5 \times 10^{-7}$  *at room-temperature*. Onnes and Perrier (Proc.

Amsterdam Acad., vol. xiv., p. 115, 1911) have shown that the specific susceptibility of liquid hydrogen is  $-27 \times 10^{-7}$ , with a probable error of 10 per cent., so that there is little difference between this value for hydrogen at a temperature less than  $-253^\circ$  C. and that derived from the hydrocarbons at room-temperature. According to the kinetic hypothesis of Dr. Ashworth, the paramagnetic atom will appear diamagnetic only if its oscillations exceed  $130^\circ$  on either side of the position of rest, and oscillations of this nature (or complete rotations) must be common to all the hydrogen atoms in any normally saturated compound. This, I think, Dr. Ashworth will scarcely admit is plausible.

Moreover, consider the general case of crystallisation of a diamagnetic substance. The specific susceptibility of the liquid may be less than or greater than that of the crystals, but each is diamagnetic (Ishiwara, Science Reports, Tôhoku, vol. iii., p. 303, 1914; Oxley, Phil. Trans. Roy. Soc., vol. ccxiv., A, p. 109, 1914). Therefore the oscillations of the atoms which appear diamagnetic must be at least  $130^\circ$  on either side of the position of rest, even in crystals—a conclusion which is scarcely consistent with the view that crystalline symmetry is in part determined by the electronic configuration of the atom.

A. E. OXLEY.

The British Cotton Industry Research  
Association, 108 Deansgate, Man-  
chester, July 29.

#### Loss of Fragrance of Musk Plants.

IT is important to ascertain whether the loss of scent which has been noticed lately in the musk plant (*Mimulus moschatus*) in certain areas is of general occurrence throughout the country.

There is no doubt that in many cases the descendants of musk plants which used to form such fragrant inhabitants of our cottage windows have lost the power of producing the peculiar musk-like scent. An important character has dropped out of the musk plant's hereditary equipment, and it becomes a matter of interest to know to what extent and in what manner this has come about.

If any plants can be found which still retain the old scent, intercrossing between these and the scentless variety would probably give genetic results of interest.

C. J. BOND.  
Fernshaw, Springfield Road, Leicester,  
July 26.

#### Meteorological Conditions of an Ice-Cap.

IN NATURE of July 29 Mr. R. M. Deeley criticises Prof. Hobbs's terminology in describing the meteorological conditions of an ice-cap as anticyclonic. He arrives at the conclusion from Prof. Hobbs's statements that low pressure exists at the centre. This is scarcely necessary.

The high pressure of an anticyclone in temperate regions is maintained by the descent of air in the centre drawn from the upper atmosphere; this compensates for the surface outflow due to the disturbing of the geocyclostrophic equilibrium by surface friction. The same conditions, i.e. the surface outflow and the central descent of air, exist in Prof. Hobbs's polar ice-cap anticyclone; the only difference is the physical origin.

In stating that the outflow of air over an ice-cap produced a vacuum which was filled by inflowing air from above, Prof. Hobbs was only describing in separate detail what is really a continuous process, no vacuum ever actually existing.

R. F. T. GRANGER.  
Lenton Fields, Nottingham, July 30.

## The Research Department, Woolwich.

By SIR ROBERT ROBERTSON, K.B.E., F.R.S.

### I.

#### *Explosives Section.*

THE Research Department at Woolwich has been in existence under various titles since 1900. Prior to 1914 the staff was small; thus for the seven years preceding the war the chemical branch had a staff of eleven chemists only, and the metallurgical branch of four.

The subjects occupying the chemical staff before the war were connected with the stability of explosives, the investigation of new explosives (such as tetryl, for which a manufacturing process was worked out and issued to a Government factory), and research on the properties of explosives and on the means of initiating them in Service components. These researches proved to have a double importance, in that they not only enabled immediate answers to be given to many questions that arose early in the war, when there was no time for prolonged research, but also afforded the staff the training necessary to meet the demands which became urgent on the outbreak of hostilities.

After the beginning of the war the increase in work imperatively demanded a larger staff, and more chemists were appointed, until at the beginning of 1917, the home supply having failed, permission was obtained to withdraw from France members of the Special Brigade, R.E., of whom more than thirty were transferred to the Department. Finally, the chemical staff numbered 107 chemists and physicists distributed in an organisation which had been gradually evolved, comprising sections for dealing with the different classes of work, such as organic chemistry, physical chemistry, analytical and general chemistry, physical investigation, calorimetry, stability, pyrotechny, applications of high explosives, fuse design, and records.

With increasing work and staff, new buildings for explosives investigation became necessary, and new laboratories were erected, including a well-appointed building (Fig. 1) for physico-chemical research, embodying many of the ideas of Prof. Donnan, and a new range of factory buildings and houses for a variety of specialised work. Climatic huts for storage trials under dry and moist conditions, which have always been an important feature of the Department, were increased in number. In the explosives section the laboratories occupy a space of 64,272 sq. ft., and the buildings

for experimental work on a larger scale 38,170 sq. ft. The Department's facilities for testing processes evolved in the laboratory on the semi-manufacturing scale have proved of the utmost value, affording confidence as to the practicability of processes on the full scale.

The Research Department acted as a central bureau for explosives research required by the Navy, Army, the Air Service, and the Ministry of Munitions. Many subjects were referred to it by the Ordnance Committee. Its work is embodied in official minutes and in collected researches termed R.D. Reports.

*Trinitrotoluene.*—One of the first subjects undertaken after the outbreak of war was the provision of an efficient and rapid process for the

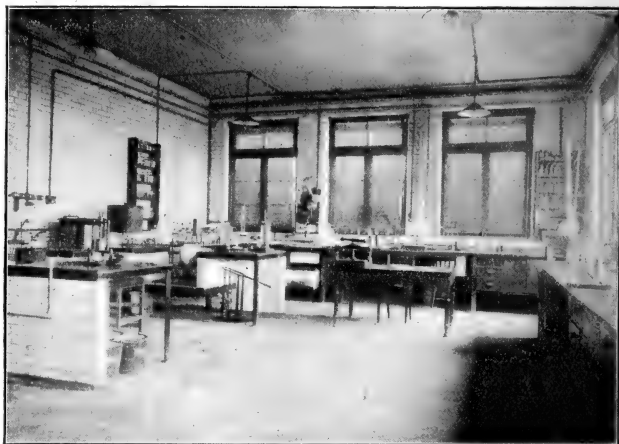

FIG. 1.—A physico-chemical laboratory.

manufacture of T.N.T., especially without the use of oleum. From the results of a large series of nitrations in the laboratory, a process was evolved characterised by several novel features, and this was put to the proof on the semi-industrial scale, a plant being designed and erected in the Department (Fig. 2) for the nitration on the quarter-ton scale, with appropriate arrangements for the mixing and concentration of acids. This small plant substantiated in a remarkable manner the process evolved from the laboratory work, and from the start turned out T.N.T. of good quality. The scheme of temperature-rise, the composition of the acid mixture, the nitration in cycles, the process of "detoluation," and other features of the process found immediate application in the large Government factories that were designed and erected by Mr. Quinan, and also in numerous private works built at this time.

These features have been little altered by later experience. Chemists were trained on this small plant for the purpose of starting Government

became practically the only explosive for land and aerial warfare, and justified its choice based on the early estimate of its properties and capabilities. In 1917 the production was at the rate of about 4000 tons a week. It is economical in that it makes use of a cheap ingredient, and has explosive properties that render it very suitable for the purposes for which it is used.

The Department continued the study of amatol especially with regard to its chemical stability and compatibility with the various materials with which it came into contact. Certain impurities in ammonium nitrate were discovered to be objectionable, and investigation of this led to an improvement in the purity of the ammonium nitrate supplied.

*R.D.B. Cordite.*—When the available quantity of acetone became quite inadequate for the cordite required, the Department brought forward a new type of cordite (Research Department "B" or R.D.B. cordite) as a result of experimental incorporations with ingredients chosen to give the same ballistics as ordinary cordite. It could be

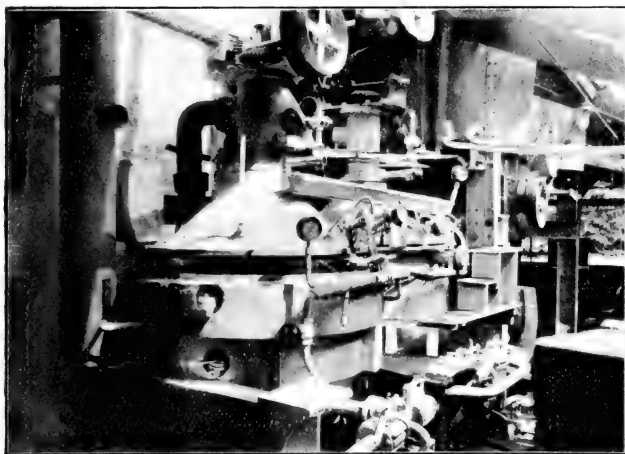

FIG. 2.—Small nitrating plant used to demonstrate the T.N.T. process.

and private factories, and for a time a few tons a week of the product were purified by alcohol-benzene in another plant erected in the Department to supply the Service with high-grade T.N.T. for exploders.

A study of T.N.T. in all its aspects was undertaken. Much attention was given to the chemistry of T.N.T., the proportions in which the isomers occur in the crude product being determined by thermal analysis, and investigations made on their interactions, stability, sensitiveness, heat values, and explosive properties.

*Amatol.*—As it soon became evident that the supply of the high explosives in use, lyddite and T.N.T., would not suffice, the Department put forward mixtures of ammonium nitrate and T.N.T., the amatols, as a result of study of their properties and of the violence they exhibited in shell-bursting trials. Gun trials substantiated the trials at rest, and their adoption quickly followed. Various methods of filling these mixtures into shell were at this time worked out, many of which have since been applied on the very largest scale.

It was found that 80/20 amatol (80 parts of ammonium nitrate to 20 of T.N.T.) was less easy to bring to detonation than lyddite or T.N.T., and required special arrangements in the train of initiation of detonation. These were successfully devised, and good and trustworthy detonation of our shell was secured. An illustration is here given (Fig. 3) of the fragmentation of an 18-pr. shell filled with 80/20 amatol.

As 80/20 amatol is practically smokeless, the constituents being arranged for complete combustion, mixtures producing a white smoke for indicating the point of burst were worked out for inclusion in the shell-filling. Ultimately, amatol

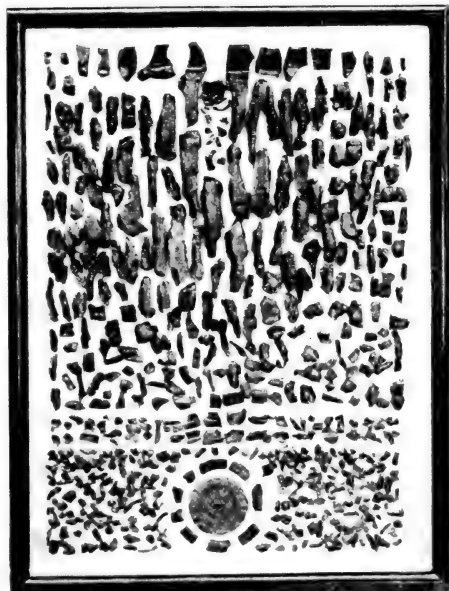

FIG. 3.—Fragmentation of 18-pr. shell by 80/20 amatol.

made with no alteration in the plant required for the manufacture of propellants. Instead of acetone, the solvent employed was ether-alcohol,

and instead of gun-cotton, a lower nitrate of cellulose was used. The great factory at Gretna, also built by Mr. Quinan, manufactured R.D.B. cordite exclusively, and this soon became the only propellant made in this country for the Land Service. It was produced both by Government and by private firms in enormous quantities.

The need for ether and alcohol for this propellant led to the restrictions imposed on alcohol.

The recovery of the new solvent presented new problems, and investigations on these were undertaken, which have increased our knowledge of the principles underlying the absorption of vapours.

As difficulties arose in the gelatinisation of the special nitrocellulose required for this powder, the Department continued its studies on the viscosity of cellulose and nitrocellulose with important results, which formed the groundwork of the procedure adopted in supply for obtaining uniformity in the cotton used in the nitration, and a diminished usage of solvent in the incorporation.

*Other Explosives.*—Many other explosives for special naval and land purposes were put forward by the Department and adopted by the Service after their properties had undergone investigation.

*Design of Ammunition.*—A feature of the work is the close connection between mechanisms connected with ammunition and the utilisation in them of explosives the properties of which have been found specially suitable. The Department was fortunate in the success which has attended its percussion fuse (No. 106), which played such an important part in the war.

*Pyrotechnics.*—New demands occasioned by the war led to the study of compositions for pyrotechnic and incendiary purposes and to chemical investigations on the compatibility of the ingre-

dients used. Many new compositions were devised and adopted for signals, stars, and incendiary shell.

*Study of the Theory of Explosives.*—The study of the chemical constitution of nitro-compounds has been referred to; but a large amount of information the usefulness of which has been reflected on Service requirements has accrued from the development of systematic work on such subjects as the calorimetry of explosives, for which new methods and apparatus have been devised, their sensitiveness, their rates of decomposition and of detonation, and the pressure of the blow they develop. The last was an extension of the work of the late Prof. B. Hopkinson, and has been fruitful in advancing knowledge of theory as well as in providing instruments for quantitative registration of the effects of explosives contained in Service components.

*General.*—The high quality and efficiency of our ammunition, in spite of shortage and the need for providing substitutes, have been obtained as a result of the continuous application of chemical and physical research. The research initiated and carried out provided in numerous cases methods for the production of explosives, and demonstrated the conditions for their safe employment; principles of fundamental importance were discovered which were utilised in the designing of ammunition; causes of failure at early stages were discovered, thus avoiding unsatisfactory issues of material; and substitutes and alternatives, without which some of our great war manufactures could not have been carried on, were sought and discovered.

(To be continued.)

## The Earliest Known Land Flora.<sup>1</sup>

By PROF. F. O. BOWER, F.R.S.

### II.

COMPARISON of these four fossil species from Rhynie with other fossils already known from the early Devonian period shows that a very homogeneous flora existed at that time, consisting chiefly of leafless and rootless land-living plants. These and other characters, such as their large, distal, sometimes solitary, and often forked sporangia, stamp these plants as exceptionally primitive. Among living plants the nearest of kin to them are clearly the Psilotaceæ, a family which has long presented a problem in morphology and classification. It comprises two living genera, *Psilotum* and *Tmesipteris*. Both genera are rootless. Their imperfect morphological differentiation is shown by the fact that botanists are not yet agreed whether their lateral appendages are to be held as truly foliar or not. *Psilotum* is native throughout the tropics, and is repre-

mented by two well-marked species. The commonest, *P. triquetrum*, has upright and shrubby aerial shoots, with radial construction and frequent bifurcations. These spring from leafless underground rhizomes, profusely bifurcated. They are covered with rhizoids, and contain a mycorrhizic fungus. On the lower part of the aerial shoots simple spine-like leaves are borne, but towards the distal ends these are replaced by forked spurs, between the prongs of which a synangium, usually with three loculi, is seated. The aerial shoot is traversed by a vascular strand consisting of xylem in the form of a hollow many-rayed star, with sclerotic core, and branch-strands run out to the appendages. The whole is covered by epidermis with stomata, and the cortex provides the photosynthetic tissue. *Tmesipteris* is represented by only one species, limited to Australasia. It grows usually among the massed roots that cover the stems of tree-ferns, but sometimes upon the ground. Its general form is like

<sup>1</sup> Discourse delivered at the Royal Institution on Friday, April 30<sup>th</sup>. Continued from p. 684.

that of *Psilotum*, but the underground rhizomes are longer and the appendages larger, while only two loculi are usually present in each syngonium. Clearly the form and vascular structure of these plants are generally like those of the Rhynic flora.

Until quite recently the Psilotaceæ remained the only living Pteridophytes of which the life-cycle was still incompletely known. In all the other groups the regular alternation of two generations had been demonstrated; one is the prothallus, which is sexual, and the other the established plant, which is non-sexual. In the Psilotaceæ also the plant as above described is the non-sexual generation, but hitherto the form or even the existence of the sexual generation remained problematical. Since 1914 the prothalli of both genera of the Psilotaceæ have been discovered, and their structure has been demonstrated by Darnell-Smith, Lawson, and Holloway; and so the very last of these life-histories has now been completed. It turns out that the prothallus of the Psilotaceæ is similar in its general characters to those of other archaic Pteridophytes, being colourless, and living in humus by means of fungal nourishment. In fact, these plants conform in their life-cycle to what is seen in the Lycopods and in the primitive Ferns. Analogy with the living Psilotaceæ makes it highly probable that these early Devonian plants also showed alternation. Though this has not been demonstrated for them, their preservation is so perfect that even the delicate prothallus may yet be revealed as the reward of further search.

The interest of the recent work on the modern Psilotaceæ centres not so much in the details of the prothallus as in their embryology. It has been shown by Holloway that the embryo of *Tmesipteris* is rootless from the first. This suggests that the rootlessness is primitive, and not the result of reduction. Since the Devonian plants were rootless also, it seems probable that this state was characteristic of such early plants of the land. Further, the existence of *Sporogonites*, and the very moss-like structure of its sporangium, together with its similarity to the sporangia of Rhynia and *Hornea*, seem to link up the latter naturally with the Bryophytes, which are also rootless. In fact, we see before us a flora of rootless plants, which raises afresh the question of the first establishment of the neutral generation as an independent, soil-growing organism. It originates in every case within the tissue of the sexual plant, and is at first dependent upon it. This condition is seen in the embryo of *Tmesipteris*, with details not unlike those of the *Anthocerotæ*. How, then, did it first establish itself independently upon the soil?

This question was first raised long ago by Dr. Treub, the brilliant director of the Botanic Gardens at Buitenzorg. He suggested that in the evolution of land-living plants a rootless phase would naturally precede the full establishment of the sporophyte in the soil. He saw this reflected in the embryonic state of certain Lycopods, where a parenchymatous tuber precedes the establish-

ment of the rooted plant. It is attached to the soil by rhizoids, and contains a mycorrhizic fungus. This tuber Treub styled the "protocorm." He regarded it as a general precursor of the established leafy plant in descent. During the war new examples of this protocorm-stage were described by Holloway, which show the condition in its most pronounced form. In *Lycopodium laterale* it constitutes the whole plant-body for the first season. It bears numerous protophylls, and may even branch, and reproduce itself vegetatively. It is only later that the leafy shoot and lastly the root are formed. The fact that *Hornea* shows a similar tuberous swelling at the base of the rootless plant, and retains it even in the adult state, brings the added interest that a permanent protocorm figures in the earliest known land flora. Its antiquity is thus undoubted. But the Devonian plants do not all show it in a distended form. The tuberous swelling is not conspicuous in Rhynia or in *Asteroxylon*, and it is significant that in the living *Tmesipteris* the rhizome is cylindrical. These facts indicate that the distended protocorm is neither an obligatory nor a constant feature.

It will not be necessary to do more than refer briefly to the controversy whether the appendages of the Psilotaceæ are truly leaves or branches. The fact suffices that the question has been in debate, and that similar questions arise in relation to these fossils of the Devonian period. In them it is impossible to assign the name "leaf" to any definite part in the full sense in which it is used in the higher vascular plants. The difficulties of their morphological analysis and their rootlessness are in themselves evidence of the primitive state of these fossils. We are, in fact, in the presence of what evolutionists call "synthetic types"—that is, such as link together groups which have diverged. The early Devonian plants and the Psilotaceæ show us just those forms which might have been anticipated as a consequence of comparative study, and some of their characters were actually forecast by Dr. Treub.

Though it may be difficult to place the parts of these synthetic types in the categories of stem, leaf, and root, as those terms are applied to more advanced forms, still they will serve to illuminate the probable origin of these parts. The rhizomes of *Asteroxylon* suggest an origin of roots from branched, leafless rhizomes. Its "leaves" suggest a relation with the leaves of Lycopods; but its most significant feature is the branch-system ascribed to *Asteroxylon*, bearing the distal sporangia, which is so like that already described for the enigmatical Carboniferous fossil *Stauropteris*. This comparison has already been pointed out by Kidston and Lang. On the other hand, approaching the question from the side of the living Ferns, I indicated in 1917 that "the distal and marginal position of a sorus, often monangial, is prevalent among primitive Ferns, and that more complex sori are referable in origin to it." Comparison of the distal sporangia of

the Psilophytales with those of Stauropteris, Botryopteris, the Ophioglossaceæ, Osmunda, and the Schizæaceæ, gives a sequence which sketches in broad lines, though not monophyletically, a probable origin of marginal sporangia for the Ferns. It is accompanied by reduction of size and spore-number in the later and derivative types, which is continued on to the most advanced of living Ferns. A reduction of the distal branchlets to a single plane, and the webbing of them laterally together, would give a type of sporophyll and fructification known in certain primitive Ferns. But if this were the real course of their evolution, the sporophyll so constructed would be a different thing from the "leaves" seen in *Asteroxylon*. This was the vision of the prophetic Lignier, who has not lived to see his ideas tested by these new discoveries. But such comparisons still leave in doubt the origin of the axis in fern-like types. It is not clear yet how near the truth for them my suggestion of 1884 may be: that "the stem and leaf would have originated simultaneously by differentiation of a uniform branch-system into members of two categories." Nevertheless, the important new fact, which now gives reality to this theory, is that a uniform branch-system has been shown to have existed in these early vascular plants. A sympodial development of it, after the manner shown in the leaves of living Ferns, would provide at least one type of foliar appendage, which would bear a relation to the axis similar to that of the pinnae to the phyllopodium or *Pachis* of the leaf.<sup>2</sup>

On the other hand, comparison of the Bryophytes will leave little doubt that the sporangium of the Psilophytales and the sporogonium are kindred structures. If this be so, then we shall see linked together by comparison with these new fossils, not only the sporogonia of Bryophytes and the sporangia of Ferns, but even the pollen-sacs and ovules of Flowering Plants. Long ago it was remarked that the widest gap in the sequence of plants was that between the Bryophytes and the Pteridophytes. It is within this gap that the newly discovered fossils take their natural place, acting as synthetic links, and drawing together more closely the whole sequence of land-living, sporangium-bearing plants. We still await with interest the considered comparisons of the authors of these notable memoirs, though they have already pointed out several fertile lines. But those who have been deeply engaged in comparative morphology may be excused for stating how these new facts strike them. Clearly the morphology of land-living plants is again in the melting-pot. It will emerge strengthened by new and positive facts, and refined by comparisons which can now be based upon solid data, and less than before on mere surmise.

The new facts are thus seen to link the Bryophytes and the Pteridophytes more closely together than ever before. It may be that these two great phyla of land-living plants have themselves diverged from some common source still

unknown. But that source is reflected more nearly in these early Devonian plants than in any other known forms. If that be so, whence may these still more primitive plants have sprung? The view has always been entertained that the Algae preceded land-living plants. For long the fresh-water green Algae were believed to have provided the source. Latterly from the Continent, but notably also here at home, at the instance of Lang and of Church, the belief has swung round towards marine forms. Highly specialised Algae flourish on every rocky shore. Some of these show alternation. All are rootless. Some have a differentiation of their branch-system which prefigures the relation of leaf and axis. Not a few of the Red Seaweeds have spore-tetrads borne internally, and located in the ends of specialised branches called stichidia. These are not altogether unlike sporogonia, or the large sporangia of the early Devonian plants. We may well regard it as improbable that any direct transition of such specialised types to a land-habit took place, though this has been hinted at more than once. But at least corresponding features of external differentiation and of spore-production are present in both. Homoplasmy may be the real explanation of the likeness, but still the similarity exists.

From what has been said it is clear that during the years of war plant morphology entered upon a new phase. The problems of origin of root and axis and leaf and sporangium have been propounded afresh in terms of the new discoveries. The day is past of that vague surmise on these points which bulked so largely in the discussions of recent decades. It was the paucity of facts that kept opinion in suspense, hovering between rival arguments rather than settling on assured data. Looking back upon the history of that branch of botanical science which is called comparative morphology, there is only one period that can rival the years from 1913 to 1920 in point of positive advance. It is the period which led up to the great generalisations of Hofmeister sixty years ago. In the glories of that work Britain had no direct share, though it was carried out at the very time when Lyell, Darwin, Wallace, Hooker, and Huxley were laying the theoretical foundations which gave their real significance to the discoveries then made by Hofmeister. In the words of Sachs: "When Darwin's theory was given to the world—the theory of Descent had only to accept what genetic morphology had already brought to view." Science, it is true, is cosmopolitan, and should always be held as such. But still we in Britain may feel a legitimate satisfaction that in these recent discoveries, which have transformed the problems of morphology, the material, the observations, and the arguments based upon them are mainly of British origin. The channel of publication of the results, so largely derived by Scottish workers from Scottish material, has naturally been the Transactions of the Royal Society of Edinburgh.

<sup>2</sup> Phil. Trans., 1884, p. 565.

## Meteorological Influences of the Sun and the Atlantic.<sup>1</sup>

By PROF. J. W. GREGORY, F.R.S.

THE prospects of long-period weather forecasting and the explanation of major variations of climate appear to rest on two lines of investigation. The effort of the first is to connect changes in the weather with those in oceanic circulation; the second attributes the changes to variations in the heat supply of the sun acting through the atmospheric circulation. Each theory has its own *a priori* probability. The oceanic control of climate has the attraction that each ocean is a potential refrigerator, since it is a reservoir of almost ice-cold water, which, if raised to the surface, must chill the air, disturb the winds, and enable polar ice to drift further into the temperate seas. Hence Meinardus, for example, connected the range of ice in the Icelandic seas and harvests in Germany with variations in the surface waters of the North Atlantic. The alternative theory has the recommendation that, since the earth receives its heat supply from the sun, variation in solar activity is the natural cause of climatic change.

The oceanic theory must be true in part. The abnormal character of some coastal climates is clearly due to the upwelling of cold water under the influence of off-shore winds. Moreover, unusual spells of weather on some of the coasts and islands of the Atlantic follow changes in the quality of its surface water, as proved by Dr. H. N. Dickson for North-western Europe, and by Prof. H. H. Hildebrandsson's demonstration that for fifteen years there has been constant coincidence between rainfall in British Columbia and the weather in the following autumn in the Azores. The alternative theory that the main factor in controlling the temperature of the earth is the varying heat from the sun acting through changes of wind and atmospheric pressure has been mainly advanced by the work of Sir Norman and Dr. W. J. S. Lockyer and of Prof. Frank Bigelow; they are now strongly reinforced by Dr. B. Helland-Hansen, the director of the biological station at Bergen, and Dr. Nansen, who remark that these views have hitherto received but little support.

The important memoir by these Norwegian oceanographers is based on a detailed study of variations in the temperatures of the air and surface waters along the steamer route from the English Channel to New York. Their detailed discussion of the results and associated problems is accompanied by a valuable series of temperature charts of the North Atlantic for the months of February and March from 1898 to 1910. The data are often uncertain, and the inconvenience of the Centigrade thermometer with its zero at freezing point is illustrated by records of water temperature of  $-3^{\circ}$  C. and  $-4^{\circ}$  C., which have to be rejected. Drs. Helland-Hansen and Nansen,

after discussion of the theory of oceanic control, reject it as quite inadequate. Thus the chilling effect of the drift of ice into the North Atlantic they estimate as "vanishingly small" in comparison with the heat transported by the air, or even by ocean currents. They consider that, though not yet fully established, the variations of the air temperature preceded, and were therefore not the result of, those of the water temperature. They hold that the variations of temperature require some much greater and more general cause than oceanic variations.

Faith in the meteorological influence of oceanic circulation was greatly favoured by the exaggerated estimates attached to what the authors refer to as "the so-called Gulf Stream." Thus the warmth of the water off the Norwegian coast was attributed to that current even by Petterson and Meinardus; this conclusion the authors describe as surprising because the evidence of salinity shows that the Norwegian waters are coastal and quite different from those of the mid-Atlantic. This sound criticism of the Swedish and Münster oceanographers renders it the more remarkable that there is no reference, either in the long historical discussion or in the bibliography, to the pioneer work on this subject in the earlier papers by Dr. H. N. Dickson, or to his observations as to the seasonal entrance of the Atlantic water into the North Sea. The authors agree with Schott in terminating the Gulf Stream west of Newfoundland, and calling the current off Western Europe the "Atlantic current," for which Dickson's name of "European current" is more descriptive and definite. The Atlantic is a large mass, and has a whole system of currents, of which the so-called Atlantic current is by no means the largest.

Drs. Helland-Hansen and Nansen, after rejecting the oceanic theory, accept as firmly established the dependence of variations in the earth's temperatures on the solar variations proved by sunspots, the numbers of solar prominences, and terrestrial magnetic disturbances. They point out that the influence of the sun on the weather of any area on the earth depends upon so complex a series of factors that the results at first sight appear inconsistent. The crude expectation that an increase of heat supply from the sun would raise the temperature of the whole earth was early dismissed, for the greater evaporation would lower the temperature on the coastlands by increased clouds, rain, and snow. Blanford pointed out, for example, the see-saw of oceanic and continental conditions; but, though his view has not been fully confirmed, his principle is supported by the proof that regions are oppositely affected by changes in the heat supply from the sun. Bigelow has divided the world into three groups of regions: in the "direct" group the temperature conditions vary directly with the sun; in the

<sup>1</sup> Björn Helland-Hansen and Fridtjof Nansen, "Temperature Variations in the North Atlantic Ocean and in the Atmosphere." Introductory Studies on the Cause of Climatological Variations. Smithsonian Miscellaneous Collections, vol. lxx., Publication 2537. 1920. Pp. viii+408+48 plates.

"indirect" group the variations agree in time, but are opposite in character; in the third, the "indifferent" group, there is no regular correspondence. Sir Norman and Dr. W. J. S. Lockyer have shown that a region may for years belong to the "direct" group, then suddenly become "indirect," and later return to the "direct" group. Drs. Helland-Hansen and Nansen accept this frequent inversion, and also their explanation of the phenomenon.

The authors' instructive study of North Atlantic temperatures therefore strengthens the case for

solar variations acting through the atmospheric circulation as the main cause of meteorological changes. To what extent the ocean helps by regulating the air temperature and circulation the authors do not discuss in the present memoir; that and other questions are to be dealt with after further investigations in a series of memoirs to which the present is introductory. The usefulness of the promised memoirs would be increased (should they have as many appendices and supplementary notes as the present) if each were provided with an index.

### The Thermionic Valve in Wireless Telegraphy and Telephony.<sup>1</sup>

By PROF. J. A. FLEMING, F.R.S.

THE thermionic valve is an invention which has vastly increased the powers and range of wireless telegraphy. Like many other inventions, the telephone, for instance, it is simple in its essential construction. It consists of a little electric lamp comprising a glass bulb, very highly exhausted of its air, containing a filament of carbon, or better tungsten, which can be rendered incandescent by an electric current. Within the bulb and around the filament are fixed certain metal plates or cylinders, and, it may be, spirals of wire or metal networks called the grid. To explain its origin in its simplest form I shall have to take you back in thought to the days when the physical effects taking place in incandescent electric lamps were first beginning to be considered carefully. In 1883 Mr. Edison for some purpose placed in the glass bulb of one of his carbon filament lamps a metal plate which was carried on a platinum wire sealed through the glass. When the filament was rendered incandescent by a current from a battery, he found that if the plate was connected by a wire, external to the lamp, with the positive terminal of the filament, a small electric current flowed through it, but if connected to the negative terminal no current, or at most a very feeble current, flowed. This new and interesting effect became known as the "Edison effect" in glow lamps, but Mr. Edison gave no explanation of it, and made no practical application of it.

Edison supplied some lamps with plates in the bulb to the late Sir William Preece, and the latter found that the current called the Edison effect current increased very rapidly as the filament was heated to higher and higher temperatures, and that the collecting plate could be placed a long way from the filament, even at the end of a side tube, without altogether causing it to vanish. At a little later date I took up the subject, and one of the first things discovered was that the Edison effect was greatly reduced if that side of the carbon loop filament in connection with the negative pole of the battery was enclosed in a glass or metal tube, or if a sheet of mica was interposed between the filament and the collecting plate. This seemed to indicate that the effect was

due to some material emission from the hot filament.

Another fact I observed very soon was that the filament was giving off torrents of negative electricity, and could discharge a positively electrified conductor connected to the plate, but not one negatively charged. Furthermore, I found that the vacuous space between the filament and the plate possessed a curious unilateral electric conductivity for low-voltage direct electric currents, and that even a single cell of a battery could pass a current from the hot filament to the collecting plate if the negative pole of the battery was in connection with the hot filament, but not in the opposite direction. This fact had, however, been previously noticed in another manner by W. Hittorf. These experiments were made in 1888 or 1889, and at that time were not satisfactorily explained.

It was not until nearly ten years later that your distinguished professor of natural philosophy, Sir Joseph Thomson, published accounts of his epoch-making and important researches, in which he proved that the agency we call negative electricity is atomic in structure, and exists in indivisible units now named electrons, which carry a certain electric charge and have a certain mass. These negative electrons are constituents of all chemical atoms. An electrically neutral atom which has lost one or more electrons is called a positive ion, and neutral atoms which have lost or gained electrons are said to be ionised. There are arguments in favour of the view that the majority of the atoms in metals and other good conductors of electricity are in a state of intermittent ionisation, and that intermingled with the atoms or positive ions, say in a wire of copper, tungsten, or carbon, there are electrons which are jumping from atom to atom with great velocity. If we apply to the wire an electromotive force, this causes a drift of these electrons at the instant they are free in the opposite direction to the force (on usual conventions), and this drift or unidirectional motion is superimposed on the irregular motion, and constitutes an electric current. The drift velocity may be very slow compared with the velocity of the irregular motion. The drift motion of the electrons superimposed on the irregular

<sup>1</sup> From a discourse delivered at the Royal Institution on Friday, May 21.



motion may be compared with that of a swarm of bees in which each insect is flying hither and thither rapidly, whilst the whole swarm is being blown by a gentle breeze slowly down a road. If the electrons merely surge to and fro, it gives rise to a form of current we describe as an alternating current, and if they execute this motion very rapidly we call it an electric oscillation.

The reason an electric current produces heat in a conductor is because the drift energy of the electrons is then being continually converted into additional irregular-motion energy in the free electrons and atoms by collisions of electrons with the atoms of the conductor. If, then, the temperature becomes very high—that is, if the irregular electronic motion becomes very great—certain electrons may acquire such velocities that they are flung out from the surface of the wire even against the attraction of the positive atomic ions left behind. If there is no electric force tending to make the electrons move away from the neighbourhood of the hot wire, these electrons constitute a *space charge* around it, and the repulsion they exercise on each other tends to keep other electrons from getting out into the space. Suppose, however, that the incandescent wire is placed in the axis of a highly exhausted glass tube, and is surrounded by a metal cylinder which is kept positively electrified, the electrons move to it, and others then make their exit from the wire. Such a tube with incandescent wire cathode and cold metal plate anode is now called a *thermionic tube*. The steady emission of electrons is called a *thermionic current*. In the case of a tungsten wire brilliantly incandescent *in vacuo* and under sufficient electric force, this current may amount to as much as an ampere per square centimetre of surface. This means that electrons are being flung or pulled out at the rate of millions of billions per second per square centimetre. So soon as Sir Joseph Thomson had proved by experiment that this electronic emission was taking place the explanation of the effects observed in incandescent electric lamps by Edison, Preece, and myself became clear. For in the Edison experiment we have a slow drift of electrons through the carbon filament superimposed on a very rapid and erratic motion, and multitudes of these electrons are escaping from the filament on all sides—just like steam escaping from a porous or leaky canvas steam pipe. If the plate in the bulb is connected to the positive pole of the filament-heating battery, it is positively electrified and it attracts these escaped electrons, and they enter it and drift through the external wire, forming the observed Edison current.

Suppose, then, that we connect the collecting plate by a wire external to the bulb with the negative terminal of the filament, and that we insert in this circuit a battery of a number of cells which can be altered so as to vary the potential of the plate, the said battery having its negative terminal connected to the filament, we then find that a thermionic current flows which can be measured by an amperemeter inserted in the circuit. If we vary the voltage from zero upwards we shall find that the thermionic current increases, but not indefinitely. It soon reaches a value at which no further increase of voltage raises the current. The reason the current does not increase indefinitely is because for each particular temperature of the filament there is a certain maximum possible rate of electronic emission. The electrons are drawn away from the filament at a rate which increases with the potential of the plate up to that point at which the maximum emission rate is reached.

The thermionic current then becomes stationary and is said to be *saturated*.

It is remarkable that although this emission of electricity from incandescent substances had been studied for more than a quarter of a century, none of them made any practical application of it prior to 1904. At that date I was so fortunate as to discover a totally unexpected application of this thermionic emission in wireless telegraphy. Before 1904 only three kinds of detector were in practical use in wireless telegraphy, viz. the coherer, or metallic filings detector, the magnetic-wire detector, and the electrolytic detector. The coherer and the electrolytic detectors were both rather troublesome to work with on account of the frequent adjustments required. The magnetic detector was far more satisfactory, and in the form given to it by Senator Marconi is still used. It is not, however, very sensitive, and it requires attention at frequent intervals to wind up the clockwork which drives the moving iron-wire band.

In or about 1904 many wireless telegraphists were seeking for new and improved detectors. I was anxious to find one which, while more sensitive and less capricious than the coherer, could be used to record the signals by optical means. Our electrical instruments for detecting feeble direct or unidirectional currents are vastly more sensitive than any we have for detecting alternating currents. Hence it seemed to me that we should gain a great advantage if we could convert the feeble alternating currents in a wireless aerial into unidirectional currents which could then affect a mirror galvanometer or the more sensitive Einthoven galvanometer. There were already in existence appliances for effecting this conversion when the alternations or frequency was low, namely, one hundred or a few hundred per second. After trying numerous devices my old experiments on the Edison effect came to mind, and the question arose whether a lamp with incandescent filament and metal collecting plate would not provide what was required even for extra high frequency currents, in virtue of the fact that the thermionic emission would discharge the collecting plate instantly when positively, but not when negatively, electrified. Accordingly I appealed to the arbitrament of experiment, and the following arrangement was tried.

Two coils of wire were placed at a distance, and in one of them electric oscillations were created by the discharge of a Leyden jar. The other coil had one terminal connected to the filament of a lamp, and the collecting plate to one terminal of a galvanometer, the second terminal of the latter being connected to the second terminal of the coil. I found, to my delight, that my anticipations were correct, and that electric oscillations created in the second coil by induction from the first were rectified or converted into unidirectional gushes of electricity which acted upon and deflected the galvanometer.

I therefore named such a lamp with collecting metal plate used for the above purpose an *oscillation valve*, because it acts towards electric currents as a valve in a water-pipe acts towards a current of water. I soon found that for the purposes of wireless telegraphy quite a small low-voltage lamp with a metal cylinder placed round a carbon or metal loop filament was a very effective rectifier, and could be used for converting the feeble alternating currents in a wireless receiving aerial into unidirectional currents capable of affecting a telephone or galvanometer. It was almost immediately adopted in practical wireless telegraphy as a simple and easily managed detector, and the intermittent rectified currents were passed through a telephone. Some time after the introduction of this oscillation valve I found that another

method of employing it as a detector was as follows:

If we connect the plate of the valve with the negative terminal of the filament-heating battery, and insert in that circuit a battery for creating a thermionic current, we can delineate a characteristic curve, as already described, by varying the E.M.F. of the plate circuit battery. That curve has generally some places in it at which the slope changes rather quickly. If we adjust the E.M.F. of the plate battery to work at that point, and then by means of a transformer superimpose a feeble oscillatory E.M.F. derived from a wireless receiving aerial, the thermionic current will oscillate from one value to another, and it is easy to see from the concave form of the characteristic curve that the mean value of this varying thermionic current is greater than the value of the steady thermionic current when the oscillations are not superimposed on the steady or battery voltage. This mode of usage in the case of valves with a certain degree of exhaustion in the bulb gives very great sensitiveness in the detection of radio-signals. It is commonly called the potentiometer method because the extra steady voltage required in the plate circuit is derived by employing a fraction of the voltage of the battery used for incandescing the filament by means of a potentiometer resistance.

This is, perhaps, the place to refer to another view of the mode in which my valve acts even when no additional E.M.F. is placed in the plate circuit. The characteristic curve of a valve is found not to start exactly from the point of zero voltage, but from a point on the negative side about  $\frac{1}{3}$  to 1 volt. This means that if the plate is connected to the negative terminal of a filament battery by a wire, there is found to be in it a small negative electric current flowing from the plate through the external circuit to the negative terminal. The reason probably is that the electrons are shot out of the filament with a certain velocity and accumulate round the plate. The result is a tendency for them to diffuse back through the external circuit, creating a feeble electron current which can be stopped only by introducing a small counter E.M.F. into that circuit. Hence the characteristic curve starts from a negative point on the voltage axis. At the place where it crosses the zero voltage point that curve is concave upwards, and hence, for the reason just explained, the introduction into the external thermionic circuit of a feeble alternating high frequency electromotive force will result in an increase in the mean or average thermionic current. Hence the valve is sensitive to feeble electric oscillations and rectifies them, not by quite suppressing all current in one direction, but because the thermionic current is greater for a given E.M.F. applied in one direction in the thermionic current than when that E.M.F. is applied in the opposite direction, whilst the mean value of the thermionic current throughout the complete cycle is greater than its value when the alternating E.M.F. is not applied.

We must now turn to consider an improvement which was introduced in 1907 into the thermionic valve, for which credit must be given to Dr. Lee de Forest. He placed a grid or zigzag of wire carried on a separate leading-in wire between the plate and the filament of my valve, and thereby made what is now called a three-electrode valve (Fig. 1).

In modern thermionic devices the grid takes the form of either a spiral wire or else a metallic gauze cylinder, which surrounds the filament without touching it, and is in turn surrounded by the plate or cylinder which does not touch the grid. This addition enables the valve to act as an amplifier of electric oscillations as follows:

Suppose we insert in the external plate circuit a

battery  $B_2$  (see Fig. 1) giving an E.M.F., say, of 100 volts, and also a current-measuring instrument A. If the battery has its positive terminal connected to the plate, the stream of electrons emitted by the filament will be drawn to the plate and give a thermionic current of three or four milliamperes if the valve is highly exhausted. This stream of electrons will reach the plate by shooting through the holes or inter-spaces in the mesh or spiral grid G.

Let us now suppose that we give the grid a small negative charge by a battery  $B_3$ . This will cause the electrons coming out of the filament to be partly repelled, and therefore the thermionic current in the plate circuit will be reduced perhaps even to zero. Again, let us give the grid G a small positive charge. This will attract the emitted electrons, and they will shoot through the grid with increased velocity. Therefore the thermionic current will be increased. The important point to notice is that, owing to the small electrical capacity of the grid, and also owing to the high voltage acting in the plate circuit, a very small expenditure of power on the grid circuit will vary or modulate a much larger amount of power in the plate circuit. Just as the pressure of a child's finger on the switch may start or stop an electric

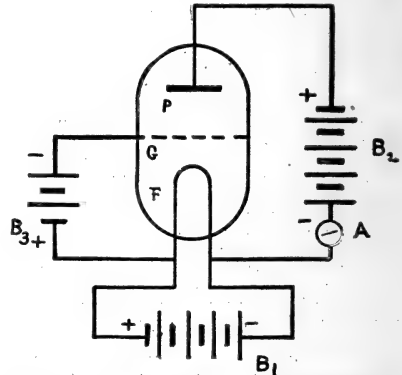

FIG. 1.—Conventional diagram of a three-electrode valve. P, a metal plate or cylinder in a highly exhausted glass bulb. G, a grid or perforated plate or spiral wire. F, the lamp filament.  $B_1$ , the filament-heating battery.

motor of several horse-power, or a feeble current passing through a telegraph relay start or stop a large current, so the three-electrode valve acts as a relay.

If we plot a curve delineating the variation of thermionic current with varying grid voltage or potential for such a three-electrode valve, we find that curve over wide limits to be nearly a straight line. This means that the change in plate current is proportional to the change in grid voltage. However rapidly the grid voltage may change, so nimble are these little electrons that the thermionic current copies on a magnified scale the changes of grid potential. Hence the arrangement is called a thermionic amplifier.

We can, however, advance further. If we cause the plate current of one valve to pass through the primary coil of a transformer, and then connect the terminals of the secondary coil of the latter respectively to the grid and filament of a second valve, we find that the fluctuations in the plate current of the first valve can be made to generate exalted potential variations of the second valve, and this again to create magnified variations of the plate current of the second valve. This mode of connection is not limited

to two valves; we can thus employ three, four, or more valves in *cascade*, as it is called, and each one multiplies or amplifies the effect of the one before. It is this use of three-electrode valves in cascade that has given us recently such vastly increased powers of detecting wireless waves. The last or final amplifying valve may be made to operate a detecting or rectifying valve, or perhaps a crystal detector.

But there is an additional very valuable power possessed by the thermionic valve, viz. that it can generate electric oscillations as well as detect them. We have already seen that the fundamental property of this valve is that variations of grid potential create similar variations of plate or thermionic current. Supposing, then, that this latter current is passed through a coil over which is wound another secondary coil connecting the grid and filament (Fig. 2). It is possible so to make the connections that any increase in the plate current will give the grid a negative charge and so immediately reduce the plate current. Conversely, any reduction of plate current will give the grid a positive charge which will again increase the plate current. Hence the operations in the plate current when once started will be maintained, the energy required being drawn from the battery B (see Fig 2) in the plate circuit. The action

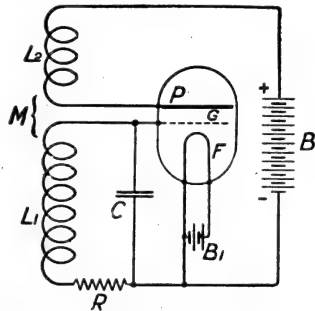

FIG. 2.—Connections for generator valve.

resembles that in the well-known experiment called the singing telephone.

The discovery of the oscillation-producing power of the valve was of great importance, because it at once put it in our power to conduct wireless telephony with simple, easily managed apparatus. The principles of radio-telephony are briefly as follows: At the transmitting station we have to establish in the sending aerial undamped or persistent oscillations and to radiate continuous waves. By means of a carbon microphone we have then to modulate the amplitude or intensity of these waves in accordance with the wave-form of the speaking voice.

The arrangements for a wireless telephone transmitter are, then, as follows: By means of a thermionic valve, with its plate and grid circuit inductively coupled, we set up, as already explained, persistent electric oscillations in the plate circuit, and these are transferred by induction to an aerial wire properly tuned to sympathetic vibration. High frequency electric currents, therefore, flow up and down the aerial. These produce magnetic and electric effects in surrounding space which are propagated outwards as an electromagnetic wave. We have in the next place to vary the amplitude of these radiated electromagnetic waves by a speaking microphone, and this is done by means of a control valve. This latter valve has its grid circuit inductively connected by a

transformer with a circuit containing a battery and a telephone transmitter.

Hence, when speech is made to the mouthpiece of the carbon microphone, this varies the electric current through it, and therefore the potential of the grid, in accordance with the wave-form of the speech sound. The plate circuit of this control valve is joined in parallel with that of the generating or power valve, and the result is that speaking to the carbon transmitter modulates the amplitude of the aerial current, and therefore the amplitude of the radiated waves, in accordance with the speech wave-form.

At the receiving station these electromagnetic waves impinge on the receiving aerial and create in it very feeble alternating currents, which are a copy on a reduced scale of those in the transmitting aerial. These are then amplified by valves in cascade, rectified, and sent through a Bell receiving telephone. The result is that the latter emits sounds which closely imitate the speech sounds made to the distant transmitter. We require very high E.M.F. to create a thermionic current of sufficient strength for wireless telephony. This is now obtained by rectifying a high-voltage low-frequency alternating current by a Fleming two-electrode valve.

The whole of the appliances are usually contained in a small cabinet. A  $\frac{1}{2}$ -kw. radio-telephone set as made by the Marconi Co. will work over 200 miles and transmit speech perfectly. More powerful arrangements on the same principle have telephoned from Chelmsford to Rome.

For aircraft radio-telephony it is usual to provide a small high-tension dynamo driven by a wind-screw to give the requisite direct high plate voltage. The filament-heating currents are provided from small closed storage cells. The aerial wire is a long trailing wire about 250 ft. in length, which is unwound when required from a drum. The actual valve apparatus may be placed at any convenient place in the aeroplane body and yet be controlled by the pilot or observer from his seat. The mere act of taking hold of the microphone transmitter closes a switch which lights up the valves and throws over the aerial wire into connection with the transmitting valve. Such aircraft radio-telephones will operate over a distance of fifty miles or more. So sensitive are these cascaded valve detectors that it is not even necessary to use a long aerial wire at all. A very few turns of insulated wire wound on a wooden frame, called a frame aerial, connected to the receiver suffice to collect and detect the electric wave signals.

Experiments were conducted in March, 1919, by the Marconi Co. to ascertain the minimum power required to transmit by these valve generators articulate speech across the Atlantic during daylight hours. The transmitting plant consisted of two three-electrode generating valves, with a third control valve for speech modulation. A small alternator of 2.5 kw. power supplied an alternating current which was stepped up in potential to 12,000 volts and rectified by a two-electrode or Fleming valve. The reception was by a series of six valves in cascade, with a final detector valve. The speech transmission was perfectly good and clear across the Atlantic, and so loud at Chelmsford, five hundred miles away from Ballybunion, Co. Kerry, that it could be heard on a simple frame aerial.

Before leaving the subject of radio-telephony it may be remarked that, both in connection with it and with the everyday uses of radio-telegraphy in maritime inter-communication, there is a great demand for an effective wireless call-bell. I have recently devised a form of call-bell which depends upon the use of a new type of four-electrode valve made as follows: A highly

exhausted glass bulb contains a straight filament of tungsten, which is rendered incandescent by a 6-volt battery. Around the filament are arranged four narrow curved metal plates having their curved sides facing the filament and very near to it. Each of these plates is carried on a wire sealed through the glass bulb. The plates are arranged round the filament, as shown in Fig. 3.

Two of these plates on opposite sides of the filament, viz. 3 and 4 (see Fig. 3), are called the potential plates, and the other two the collecting plates. The collecting plates are joined together outside the bulb and connected to the positive terminal of the filament-heating battery, and a galvanometer G or telegraphic relay is inserted in that circuit. The electronic emission from the filament then creates a current which flows through the galvanometer or the relay, as in the Edison experiment. If the two other plates have a small potential difference made between them, either of constant direction or else a high-frequency alternating difference, this suddenly reduces the thermionic current. The potential difference of the potential plates introduces a new electric force into the field which deflects away the electrons proceeding from the filament and prevents them from reaching the collecting

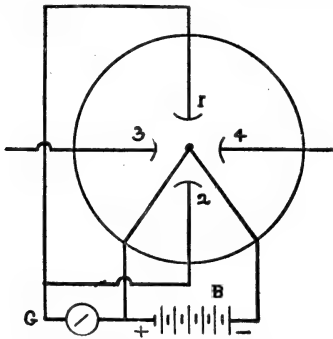

FIG. 3.—Fleming four-anode valve. 1 and 2 are the collecting plates. 3 and 4 are the potential or deflecting plates. B is the filament-heating battery, and the central dot is the end-on view of the straight filament. G is a relay or galvanometer.

plate. If, then, we connect the potential plates to the ends of a resistance of about 15,000 or 20,000 ohms, and include this resistance in the plate circuit of an ordinary three-electrode valve, the thermionic current of the latter flowing through the resistance will create a terminal potential difference which arrests the thermionic current of my new valve. Hence the relay does not operate. If, however, we give an extremely small negative potential to the grid of the three-electrode valve, then this reduces the thermionic current of the latter and increases that of the other valve, which again in turn causes the relay to close contact, and it may be caused thereby to ring a bell. The negative grid potential can be derived from the oscillations in an aerial wire as above described. In this manner I have constructed an arrangement by which the ordinary feeble antenna oscillations can be employed to ring a call-bell. The operator can then switch over the aerial to an ordinary valve receiving set and listen to the telephone.

It remains to say a few words on the methods by which the thermionic valve is employed in the reception of signals made by undamped or continuous waves. By far the best method of receiving signals

by these waves is by the so-called beat-reception. If two sets of waves of slightly different wave-length are superimposed, no matter what sort of waves they may be, the result is to produce a compound wave with periodically increasing and decreasing amplitude. These augmentations are called the beats.

If a continuous electric wave falls on an aerial it creates on it continuous oscillations. Suppose, then, that we generate also by some local means in the aerial wire undamped oscillations differing in frequency, say by 1000, from the incident waves. The result will be to produce in the aerial electrical beats having a frequency of 1000. These act to a receiver just as do damped trains of waves with a train frequency of 1000. They can be rectified and detected by a valve and telephone, as already explained. It is now quite easy to produce high-frequency oscillations of any required periodicity by coupling a three-electrode valve to the aerial and then coupling the grid and plate circuits of the valve. Sometimes a separate three-electrode valve is used to rectify and detect the beats. Capt. H. J. Round has, however, invented ingenious methods by which one and the same thermionic valve can be used simultaneously to generate and to detect the beats.

We must, in the last place, glance at the uses of the thermionic valve in connection with ordinary telephony with wires. When the rapidly fluctuating electric currents which are propagated when a speaker at one end of a long line converses by telephone with an auditor at the other flow along a copper telephone line, two effects take place which militate against clear and audible speech transmission. First, the current generally is enfeebled as it flows, and this is called the attenuation. Secondly, the different harmonic constituent currents which go to make up the complex wave-form which corresponds to each articulate sound are differently enfeebled.

The vibrations of high pitch are more enfeebled than those of lower pitch. The first effect reduces the loudness of the speech received, and the second its articulate clearness or quality. The cause of the general enfeeblement is the resistance of the line, which fritters away the energy of the speech electric currents. Until lately the only known method of overcoming it was by putting sufficient copper into the line, but this, of course, means cost.

The thermionic valve is, however, able to make a very large economy in copper. It has already been explained that the three-electrode valve can act as an amplifier. Suppose, then, that we cut a long telephone line in the middle and insert on one side a transformer, the secondary terminals of which are connected to the grid and filament of a valve, whilst the plate circuit also contains a battery and a transformer of which the secondary circuit is in connection with the continuation of the line. Feeble telephonic currents arriving at the valve would vary the potential of the grid, and this, as just explained, would fluctuate in like manner, but with increased energy, the plate current. The transformer in the plate circuit would then re-transmit the speech current, but with exalted amplitude. The valve can thus be used to counteract the effect of resistance on the line. In practice, however, the arrangements are a little more complicated, because a telephone line has to be used in both directions.

If our trunk telephone line system in Great Britain had to be laid over again, it is perfectly certain that a very great economy in copper could be made by a widespread use of the thermionic valve as a repeater and relay. It repeats so perfectly that we may certainly say it has completely outclassed all previously invented forms of microphonic relay.

## Obituary.

PROF. J. C. F. GUYON.

THE death of Prof. Jean Casmir Félix Guyon, at the end of his eighty-ninth year, removes the last of three famous Paris specialists in genito-urinary surgery; of these Civiale was much the senior, whereas Albarran (1860-1912) was Guyon's brilliant pupil and succeeded him in the professorial chair so far back as 1896. Guyon, though naturally little known to the younger generation of British surgeons, ranks with the late Sir Henry Thompson (1820-1904), with whom professionally he may be compared. Both these pioneers adopted and improved the eminent American surgeon Bigelow's practice of litholapaxy, or the complete removal of all the fragments of a crushed calculus from the urinary bladder at one sitting. Guyon was recognised as a great teacher in his speciality, and for years attracted students from all parts of the world to his clinic at the Necker Hospital.

Guyon was born on July 21, 1831, at St. Denis, in the island of Réunion, and it may be mentioned as a rather curious coincidence that his famous successor, Joaquin Albarran, was also born abroad, namely, in Cuba. Guyon worked first at Nantes and then at Paris, where he was *interne* in 1854 and prosector to the faculty in 1858. His graduation thesis, on "Fibroid Tumours of the Uterus," bears the date 1860; in 1862 he became surgeon to the Paris hospitals, in 1863 *agrégé*, and professor in 1877. His two chief works, "Leçons cliniques sur les maladies des voies urinaires" (1881)—which passed into a second edition in 1885, and a third in two volumes in 1894-96—and "Leçons cliniques sur les affections chirurgicales de la vessie et de la prostate" (1886)—edited by his former resident, Dr. F. P. Guiard—embodied his teaching at the Necker Hospital, and were both translated into German

and into Russian. Though famous as a genito-urinary specialist, Guyon took a broad view of surgery, adopted Lister's methods as early as 1876, and was the author of a work of 672 pages on general surgery, dealing with diagnosis and operations in general, entitled "Éléments de chirurgie clinique." Although now somewhat forgotten from his great age and the interval of almost a quarter of a century since he quitted the chair of genito-urinary surgery, Guyon received the honours due to his work and position; he was a Commander of the Legion of Honour, a member of the Institute (Academy of Sciences) and of the Academy of Medicine, and on August 3, 1900, his former pupils, of whom Lucas-Championnière was the senior, presented him with a medal executed by Bottée as a mark of their affection and admiration.

MR. ALEXANDER JAMES MONTGOMERIE BELL, who died on July 3, aged seventy-four, was a fellow of the Geological Society who devoted his leisure for many years to the study of the deposits in southern England in which palaeolithic flint implements occur. His researches on the gravels and associated deposits at Wolvercote, near Oxford, were especially valuable, and were described in a paper published in the Geological Society's Journal in 1904. He regarded certain disturbed layers as "ice-drifts," and emphasised the importance of distinguishing "rainwash-drifts" from regular deposits. From an examination of the fossil remains of plants and beetles, he concluded that in late Pleistocene times the climate of the Thames valley was more continental than it is at present. It is understood that Mr. Bell left a general summary of the results of his researches in a manuscript, which we hope may be found in a form suitable for publication.

## Notes.

DR. G. C. SIMPSON, F.R.S., Meteorologist to the Government of India, has been appointed Director of the Meteorological Office as successor to Sir Napier Shaw, who retires on reaching the age-limit after brilliant pioneer service. Dr. Simpson was meteorologist and physicist to the British Antarctic Expedition, 1910-13, and served on the Indian Munitions Board from 1917 to 1919. In 1905 he was appointed a Scientific Assistant in the Meteorological Office, and in 1906 joined the staff of the Indian Meteorological Department. He is the author of a number of papers of scientific importance, including one on the electricity of rain and its origin in thunderstorms, published in the Phil. Trans. in 1909. Only last year Dr. Simpson completed an elaborate discussion of the meteorological work of the British Antarctic Expedition, 1910-13. As successor to Sir Napier Shaw his appointment promises a continuation of progress along lines which will advance meteorological science and

maintain the high position which the British Meteorological Office now occupies through its work in recent years.

DR. L. V. KING has been appointed Macdonald professor of physics at the Macdonald Physics Building, McGill University. The chair has been held in succession by Prof. H. L. Callendar, Sir Ernest Rutherford, Dr. H. T. Barnes, Prof. H. A. Wilson, and by the present director, Dr. A. S. Eve. Prof. King was born at Toronto, Ontario, in 1886. In 1905 he graduated B.A. at McGill University with first-class honours and gold medal in mathematics and physics. He was elected scholar of Christ's College, Cambridge, in 1906, and appointed lecturer in physics at McGill University in 1910, assistant professor in 1912, and associate professor in 1915, when he also was awarded the D.Sc. degree of McGill University. In 1915 Prof. King began investigations on sub-

marine acoustics for the Electrical and Submarine Committee of the British Board of Inventions. He has been engaged for some time on important researches on the efficiency of fog-signal machinery and on the measurement and distribution of sound.

In an illuminating article in the *Times* of July 29 Dr. Herbert Levinstein explains the close co-operation of the German Government and the combine of the German aniline, dye manufacturers known as the "Interessen Gemeinschaft" or the "I.G.," which enabled the German General Staff to provide large quantities of high explosives and poison gases when the need arose after the Battle of the Marne. Until then the aniline dye factories had not been mobilised; they had continued their ordinary vocation of manufacturing dyes because the great accumulation of high explosives by the Germans had been expected to overwhelm the French in a short time. After the Marne, however, there was an actual shortage of munitions in Germany, and the vast resources of the dye factories were then requisitioned for the production of further quantities of high explosives and of poison gases. Whilst the varied collection of dye-making plant in Germany could be immediately adapted for this purpose, the special plant erected in this country cannot so easily be utilised in the reverse direction, and it is vitally necessary that we should possess extensive plants for the manufacture of dyes comparable with those of the "I.G.," so that not only can the necessary provision be made for any future war, but also facilities for chemical research, which, in chemical warfare and in the dye industry, can be supported only by the industry itself, may be provided to enable us to maintain a premier position.

We have now had an opportunity of examining at the London office of Messrs. Barr and Stroud, Ltd. (15 Victoria Street, S.W.1), the latest form of that remarkable instrument devised by Dr. E. E. Fournier d'Albe and perfected by Prof. Archibald Barr by which it is possible for a blind man to read ordinary print by listening to sounds in a telephone receiver. The apparatus, which is called the optophone, was fully described by the inventor in an article in *NATURE* of May 6 last, where the way in which, by the use of selenium cells, a series of distinctive sounds is produced as the "eye" of the instrument passes over the letters was explained. To anyone who has not tested the instrument it is difficult to believe in the possibility of making the sound combinations sufficiently distinctive for even a trained operator, blind or otherwise, to recognise the different letters easily. A few minutes' experimenting, however, is sufficient to dispel all such doubts. After realising the principles of the action, the present writer was, in one or two cases, actually able to name correctly the simpler letters at a first attempt, and there is no doubt that a blind person could be trained to read with the apparatus more easily than he could become expert in picking up a wireless message in Morse. The way in which the letter "w," for example, is represented by beautiful little descending and ascending arpeggios sung softly in one's ear, or a single harmonious chord denotes an "i," is quite fascinating. The adjustments

of the apparatus, although delicate, are not beyond the powers of a blind reader of intelligence, and we feel sure that the institutions (including St. Dunstan's and others) which have already acquired these instruments will find them appreciated by the sightless readers whom they train. We have not the space to direct further attention to the numerous little mechanical details which contribute so much to the success of the instrument. It must suffice to say that they are largely the result of long personal attention by Prof. Barr himself, who had at his disposal the unrivalled resources of the well-known firm of range-finder manufacturers.

MAJOR W. E. SIMNETT has retired from the direction and editorship of the *Technical Review* on his appointment to direct the Intelligence Branch of the Ministry of Transport.

THE Harveian oration of the Royal College of Physicians will be delivered by Sir Frederick Andrewes on St. Luke's Day, October 18; the Horace Dobell lecture by Sir William Leishman on November 2; the Bradshaw lecture by Dr. R. C. B. Wall on November 4; and the FitzPatrick lectures on the History of Medicine by Dr. E. G. Browne on November 9 and 11.

ACCORDING to a notice appearing in *La Technique Moderne* for May, a French committee is now engaged in the establishment of an institute for chemical research as applied to industry. The idea is to create, on the model of the Pasteur Institute and the large American research institutes, a powerful scientific organisation at which all kinds of researches of interest to industry may be carried out. In addition to founding the research institute at Paris, the committee intends to provide the means to make grants on a liberal scale to those workers who wish to carry out their work in private laboratories. Missions will also be sent abroad for the purpose of studying conditions there.

THE use of the different species of woods and the preference accorded to the various kinds in industry are determined mainly by experience. In France especially no methodical investigations have hitherto been carried out on the various timbers grown in the country. This want is now to be filled by the enterprise of the Administration des Eaux et Forêts. A series of researches will be undertaken by that Department in consultation with the Technical Section of the Aeronautics Department, dealing with the properties of native woods from the point of view of their utilisation. The first-named Department will collect samples of wood of known origin, and these will be subjected to suitable mechanical tests by the Aeronautics Department. The results of the tests, together with the specimens, will be sent to the research station of the Nancy Forestry School.

AN important discussion on "The Present Position of Vitamines in Clinical Medicine" was opened by Prof. F. Gowland Hopkins at the eighty-eighth annual meeting of the British Medical Association at Cambridge. A full report of the proceedings will be found in the *British Medical Journal* for July 31. Prof. Hopkins said that he deplored the scepticism

concerning the whole question of vitamins which has been displayed by certain members of the medical profession, and gave definite experimental evidence of the effects of deficient diets. The remainder of the paper was devoted to the principal forms of disease which are now recognised as associated with the absence, to a greater or less degree, of one or more of the vitamins from a dietary. The diseases mentioned were scurvy, beri-beri, the xerophthalmia of experimental animals, and rickets. During the discussion which followed further evidence of the importance of vitamins in a normal diet was given by various contributors.

WE have received from Messrs. Flatters and Garnett, Oxford Road, Manchester, a catalogue of mounted microscopical preparations which they are able to supply. The list is a very comprehensive one, ranging from numbers of protozoa, worms, insects, and other invertebrates to vertebrate tissues and structures. Botanical preparations, bacteria, diatoms, petrological specimens, and textile fibres are included, and the firm is also prepared to supply botanical material and pond-life for class purposes. The prices appear very moderate.

IN *Medical Science: Abstracts and Reviews* for July (vol. ii., No. 4) one of the reviews is devoted to the subject of diabetes, and some interesting particulars are given. In the years immediately preceding the war the deaths from diabetes remained constant, whereas during the four years 1916-19 they declined from 444 pre-war to 202. The male sex showed a greater decline than the female, and the percentage mortality among children sank as low as in adults. No case of diabetes was observed as the result of cerebral concussion. These facts give no support to the nervous hypothesis of the causation of diabetes. It is stated that there was a similar diminution in diabetes during the siege of Paris in 1870-71, and during the German occupation of Lille in the late war many of the less severe diabetic cases improved or recovered—probably as a result of the food scarcity.

A CHADWICK lecture on "Health Conditions in Eastern Europe: Typhus a Serious Menace" was given by Dr. Norman White (Medical Commissioner, Typhus Commission, League of Nations) on July 15 at the Surveyors' Institution, Westminster, S.W.1. The countries considered were Latvia, Estonia, Lithuania, Poland, and the Ukraine. Poland, through which pass the main lines of communication with Russia, has suffered more than her smaller neighbours. Sanitary conditions in this portion of Europe are in a deplorably backward condition, and soap, fuel, and other facilities for cleanliness are unobtainable in many districts, while louse infestation among the poorer classes is almost universal. A large portion of the lecture was devoted to the consideration of typhus fever, the part played by the louse in the conveyance of the disease being described. Emphasis was laid on the danger to other countries arising from the persistence of this focus of epidemic disease. The essential requirements for the anti-typhus campaign were outlined, and the point was

made that every country in the world has a very real concern in the existing health conditions of Eastern Europe, apart from humanitarian considerations.

DR. W. CROOKE in the *Journal of the Royal Anthropological Institute* (vol. xlix., July-December, 1919) discusses the question of "Nudity in India in Custom and Ritual." The present Hindus, like all Orientals, wear scanty clothing, but the rules of decency are generally observed. There are, or were until recently, several degrees of habitual nudity. The earliest stage of clothing seems to have been that of bark, and this and drapery made of sedge and other leaves are still in use in parts of the country. Nudity appears in various magical rites like rain-making, while in the case of some ascetics it implies the renunciation of all family and social obligations. This condition, in the case of rites connected with magic and witchcraft, is fully illustrated, as well as the aetiological legends which have been invented to explain the custom.

IN the *Journal of the Royal Anthropological Institute* (vol. xlix., July-December, 1919) Mr. Harold Peake discusses "The Finnic Question and some Baltic Problems." Until recent years it was generally supposed that the Finns, like the Lapps and Samoyeds, were an Asiatic people with Mongoloid affinities. On the other hand, Ripley supposes the Finns to be of the Nordic race or closely allied to them, while Ruggeri believes that Proto-Nordics, Proto-Finns, and Proto-Mediterraneans are branches of a common stock which originated on the confines of Europe and Asia. Mr. Peake's conclusion, after a careful review of the evidence from physical anthropology and culture, seems to be that towards the latter half of the third millennium a period of drought occurred in the steppe-lands of the northern hemisphere and caused the Nordic steppe-folk to disperse in various directions. It may be that to this date we must attribute the retreat to the Volga basin which resulted in the hybrid type known as the Red Finns, but the main body seems to have crossed or passed round the plain of North Germany to Denmark, where, perhaps, they met and coalesced with the people of the kitchen-middens; they afterwards passed across the Danish islands to Sweden as the men of the passage-graves, driving before them the Mongoloid aborigines, who had now reached the stage of Arctic culture.

THE lighting of picture-galleries and museums presents problems that have not yet been solved in practice, and especially is this the case with reflections from glass. In the July issue of the *Museums Journal* Mr. Hurst Seager sets forth the scientific principles that are necessary for success. At the recent conference of the Museums Association he gave a brilliant demonstration of their application, and an account of this appears in the August number of the journal. All museum directors should study Mr. Seager's advice, of which the correctness has been proved by a gallery at Wanganui, N.Z. With the July number the *Museums Journal* opened a new volume; with the August number its price is raised to 2s.

WE have received from the British Association Committee on Zoological Bibliography and Publication recommendations as to the way in which an author should introduce references to previous work quoted by him. Footnotes are condemned. The committee recommends that, at all events in the case of longer articles containing many references, a "list of works referred to," arranged with the names of authors in alphabetical order, should be printed at the beginning or end of each article. In these lists the title of the paper, name of the journal, date, number of series and volume and the pages should be given. It would then, in the text of the article, be necessary to quote only the author's name and the date, with the addition of a page-number where required. The committee also discusses additions to the rules which should be followed when introducing new genera or species in zoological publications.

IN the Report of the American Museum of Natural History for 1919 President H. F. Osborn continues his vigorous beating of the educational drum. The museum, he writes, "is actually going backward." Want of space and want of funds prevent the orderly arrangement of the material already accumulated. When the dinosaur ribs shoulders with the mammoth, small wonder that newspaper science represents them as contemporaries. The harmonious development of exhibition galleries is at a standstill. African, Asiatic, Polar, and Oceanic Halls are lacking; for lack of halls of fishes, of reptiles, and of birds of the eastern hemisphere these animals are untruthfully arranged. And the remedy? Extension of the museum on the plan originally intended, partly as a memorial to Theodore Roosevelt, whose connection with zoology is a great asset for more than one museum, and partly by separating the tax rolls and assessments for educational purposes from the general municipal rates and starting a direct poll-tax for education—a tax which would have a basis ten times as broad and would be more willingly paid. It must not be inferred that Dr. Osborn overlooks the research work of the museum, which is the necessary foundation of its educational activities. The team-work on fossil vertebrates accomplished under his guidance by Dr. W. D. Matthew and an accomplished staff is a brilliant witness to the contrary, and the report records a long list of researches and publications in various branches of science. But in New York, as in this country, it is through an appeal to the public on educational grounds that funds can most readily be raised.

*Science and Industry* for March, the official journal of the Australian Institute of Science and Industry, contains a detailed account of the results of investigations in New South Wales on the extraction of tannins from wattle-bark, which are of great importance to the Australian leather industry. For many years the bark used has been obtained from two species, the golden wattle of South Australia (*Acacia pycnantha*) and the black or green wattle (*A. decurrens*) and its varieties. As a result of the gradual destruction of wattle-trees the Australian supply has been largely supplemented by wattle-bark imported from Natal, where plantations grown from Australian

seed have been formed. A valuable tan-bark is also yielded by the mallet (*Eucalyptus occidentalis*) of Western Australia. The faulty methods adopted for the extraction of tannins are criticised, and an improved process is suggested.

IN his presidential address to the Linnean Society of New South Wales (abstract of Proceedings, March 31, 1920) Mr. J. J. Fletcher referred to the morphology of the so-called phyllodes characteristic of many of the Australian acacias. According to the definition in text-books, these are the flattened leaf-stalks of bipinnate leaves which have lost their blades, whereas they really represent the primary axes of bipinnate leaves which have lost their pinnae. Accordingly the name "euphyllode," as implying something more than merely flattened petioles, is proposed for them. The president also referred to the recent costly visitation of drought, and pointed out the need for a handbook or manual setting forth the theoretical complementary side of the practical activities of the man on the land, especially in relation to drought problems. A synopsis indicating the scope and contents of such a handbook was offered for discussion.

MR. F. DEBENHAM, who accompanied Capt. Scott on his last Antarctic expedition, puts forward (Quart. Journ. Geol. Soc., vol. lxxv., p. 51, 1920) an ingenious suggestion to explain the transfer of marine deposits from the sea-floor to the surface of glacier ice, and so finally to the land when glaciers melt away. A massive glacier protruding seaward may pick up such material by accreting ice along its base. Successive accretions from the freezing sea raise this lower layer until finally it comes to the surface, where ablation is active during summer. It may then be transported to some point impinged on by the ice. The interesting occurrence of sodium sulphate, as mirabilite, in the ice is held to be due to concentration of sea-water in cold sub-glacial lagoons, the water of which has furnished ice, enclosing the separated salt. The case of the Great Salt Lake of Utah, in which sodium sulphate separates when the temperature falls below about 20° F. (−7° C.), is cited as an illustration.

A MEMORANDUM regarding the probable amount of monsoon rainfall in 1920 by Dr. Gilbert T. Walker has recently been issued. Data of importance are given showing how the monsoon rainfall in India is affected by previous weather conditions over various parts of the earth. In summing up the effects of the various factors it is mentioned that the prejudicial effect of snowfall from Persia to the Himalayas is exerted when at the beginning of June the accumulations extend over a larger area than usual. The great excess of snow reported this year is confirmed by the low temperatures in the Punjab. Heavy rainfall in South Ceylon, Zanzibar, East Africa, and Seychelles is prejudicial, but data for this year show a moderate deficit or normal conditions. A close relationship exists between heavy rain in Java from October to March and low barometric pressure in Bombay in the succeeding six months; in Java the rainfall was nearly normal and its effect is negligible. High barometric pressure in Argentina and Chile is



a favourable condition, but this year pressure is in slight defect. It is stated that the conditions indicate that in North-West India the monsoon is likely to be weak, at any rate in the earlier part of the season, and for the rainfall of the Peninsula, North-East India, and Burma the indications are not sufficiently definite to justify a forecast.

THE Italian Laboratory of Practical Optics and Mechanics of Precision, which was founded in Florence last year on the suggestion of the Minister of Public Instruction to spread a knowledge of recent advances in instrument-making amongst those engaged in the industry in the country, has undertaken the issue of a monthly *Review of Optics and Mechanics of Precision*. The number for March and April consists of a little more than thirty quarto pages. The first seven are devoted to a continuation of a report by Prof. L. Silberstein on the quantum theory of spectra. The improvements which Sommerfeld has introduced into the theory by ascribing two degrees of freedom to the electron instead of the one degree of Bohr's theory are dealt with. Constructional optics is represented by articles on the calculation of achromatic objectives and on objectives for aerial photography. Metrology gets an article of sixteen pages on measurements of precision in the mechanics workshop by Mr. V. I. N. Williams, of Armstrong, Whitworth's, Manchester. There appears to be no publication in English which serves the same purpose for our own industries that this review does for those of Italy.

THE July issue of *Science Progress* contains a *résumé* by Mr. S. C. Bradford of the theory of the constitution of the atom propounded by Langmuir in the June issue of the *Journal of the American Chemical Society* last year. Unlike the "sun and planets" theory which has been so successfully developed by Bohr, the new theory assumes the electrons which surround the positive nucleus to be at rest. They form shells around the nucleus, the number in each shell being twice the square of the number of the shell counted from the nucleus. When the number of electrons is insufficient to fill a number of shells, it is the outer shell which is incomplete. In these outer shells there is a tendency for the electrons to form groups of eight or "octets" either amongst themselves or by association with the electrons of other atoms. The chemical properties of the atom depend mainly on the number of electrons in the outer shell not associated together in octets. The properties of hydrogen, helium, neon, lithium, carbon, nitrogen, oxygen, and fluorine, the similarity in the behaviour of  $\text{CO}_2$  and  $\text{N}_2\text{O}$ , of  $\text{CO}$  and  $\text{N}_2$ , and the difficulties which compounds of nitrogen raise on the usual theory of valency, are all explained in a simple way by the new theory.

IN NATURE of July 8 we gave an account of the work done recently at the National Physical Laboratory. The appearance of the report of the laboratory for the year 1919 enables us to supplement that account by some information as to the progress of the institution as a Government establishment. With regard to buildings, the new control appears to

involve exceptional delay. Extensions contemplated in 1918 and urgently needed have been approved by the Research Department, but not yet authorised by the Treasury. In consequence, apparatus already delivered cannot be housed and utilised. The number of posts in each grade of staff has been fixed, and the conditions of service approximate to those in the Civil Service. In special cases, however, promotion by length of service may be departed from, subject to the approval of the Research Department. Industry appears to be claiming many of the staff who have by their past work added materially to the reputation of the Laboratory, and it is of the utmost importance that the most promising of the younger members of the staff should be retained by sufficiently attractive posts. The Research Department has decided that commercial testing is not in future to be a function of the Laboratory.

A REPORT by Prof. J. C. McLennan on sources of helium in the British Empire has recently been issued by the Department of Mines, Canada (Bulletin No. 31). An investigation of the helium content of natural gas supplies was undertaken at the request of the Board of Invention and Research (London) in 1915, and the report embodies the results, which are now published by permission of the Admiralty. It appears that certain natural gases in Canada form the largest source of supply of helium at present known within the Empire. The percentage of helium present was found to range from zero in gases from the Toronto and British Columbia regions up to about 0.33 per cent. in gases from the Blackheath (Ontario) and Bow Island (Alberta) areas. Two methods were used for isolating the helium: (1) Combustion of the gas with oxygen, the resulting water and carbon dioxide being removed by suitable reagents, and the nitrogen and remaining traces of other gases by means of coconut charcoal cooled in liquid air; and (2) condensation of the hydrocarbons and other constituents having higher boiling points than helium in a condenser immersed in liquid air, the residue being then purified by means of charcoal as before. Figures of the apparatus employed are given. Methods based upon these processes are indicated for the large-scale manufacture of helium, and it is considered that commercial production of the gas is almost certain to be undertaken.

FROM the Central Scientific Co., Chicago, we have received a copy of its catalogue of apparatus used in chemical, bacteriological, biological, industrial, and soil-testing laboratories. The catalogue is very complete, and it indicates the thorough manner in which American manufacturers have developed the production of scientific apparatus. Practically all the articles described are stated to be "American made," the only important item of foreign manufacture being English (Whatman) filter-paper. Among other matters of interest we note the new "chain" analytical balance, in which the use of a rider and small weights is dispensed with. The finer weighings are obtained by varying the length of a small gold chain attached at one end to the beam of the balance, and at the other to a vernier which slides on a graduated vertical

column, and is operated by a milled head outside the balance-case. It is claimed that in this way the rapidity and accuracy of weighing are much increased.

AMONG the papers read at the annual meeting of the British Pharmaceutical Conference recently held in Liverpool was one by Messrs. Bernard F. Howard and Oliver Chick upon "Some Recent Samples of 'Grey' Cinchona Bark." A "parcel" consisting of 138 bales of South American cinchona bark received in March, 1920, and analysed by the authors, was found to contain 6.302 per cent. of total alkaloid, the bulk being cinchonine, the figure for which was 5.49 per cent. The bark contained only 0.027 per cent. of quinine. Mr. E. M. Holmes, curator of the Pharmaceutical Society's Museum, has examined the bark, and has expressed the opinion that it is the product of one, or possibly more forms of *Cinchona peruviana*, Howard. The large percentage of cinchonine found in the bark is probably due to the elevation at which the trees grow, as this factor, and the accompanying differences of heat and moisture, are known to influence the character of the alkaloids present.

At the recent annual meeting of the British Pharmaceutical Conference a paper entitled "Cresineol" was contributed by Mr. T. Tusting Cocking, who showed that when oil of eucalyptus and ortho-cresol are mixed heat is evolved, and on cooling a mass of glistening crystals, consisting of an equimolecular combination of cineole and ortho-cresol, is formed. This is a new compound, which has been named "cresineol." It may be recrystallised from various solvents, and forms beautiful white, transparent, prismatic crystals, melting at 55.2° C. and boiling at 185° C. Cresineol is volatile, and possesses a pleasant camphoraceous odour. It is not caustic in its action on the skin, and yet contains 41 per cent. of cresol. Having high germicidal properties, it is likely to prove of great value as an antiseptic for both internal and external application. The fact that a solid compound is formed when oil of eucalyptus and ortho-cresol are mixed can be made use of as a means of determining the amount of cineole in oil of eucalyptus. The method is based on the determination of the freezing point of a mixture of the oil with ortho-cresol; having observed this point, one may read off directly from a curve given by the author the percentage of cineole contained in the oil.

MESSRS. W. HEFFER AND SONS, LTD., Cambridge, have in the press a book by Dr. A. Harker entitled "Notes on Geological Map Reading," the object of which is to teach the student to visualise a geological map as in three dimensions, and to show that the questions which present themselves to the field-geologist reduce to exercises in very elementary geometry. This simplicity is gained by reckoning all slopes and dips as gradients, thus enabling trigonometry and the protractor to be dispensed with. The amount of dip, the thickness of a formation, the throw of a fault, etc., are measured directly upon a contoured geological map by the use of the scale alone.

## Our Astronomical Column.

THE HILL OBSERVATORY, SIDMOUTH.—The council of this observatory has just issued its annual report for the year ending June, 1920, and it is satisfactory to note that all instruments and other equipment are in good condition and that the observatory is now in full working order again. The chief work undertaken consists in photographing the spectra of stars down to magnitude 5.30 and classifying them according to Sir Norman Lockyer's scheme of increasing and decreasing temperatures. Spectra are also photographed of nebulae and other special objects. An interesting addition has recently been made to the regular work of the observatory in the form of a line of investigation suggested by Prof. W. S. Adams. Prof. Adams has found that the relative intensities of certain lines in stellar spectra vary with the absolute magnitude of the star, and thus, provided the apparent magnitudes are known, a fairly simple method is available for the determination of stellar parallaxes. The line intensities referred to are measured by means of a wedge of dark glass specially made for the purpose, the position of the wedge being noted at which the lines are just obliterated. Some encouraging results have been obtained from preliminary work. A party of members of the British Association visited the observatory at the close of the Bournemouth meeting. The party included several eminent astronomers, some of whom have consented to form a research committee, intended to act as an advisory body on all matters connected with the research work of the observatory.

THE INFRA-RED ARC SPECTRA OF SEVEN ELEMENTS.—No. 372 of the Scientific Papers of the U.S. Bureau of Standards gives the results of an investigation on the wave-lengths longer than 5500 Å. in the arc spectra of seven elements made by Messrs. C. C. Kiess and W. F. Meggers. The yellow, red, and infra-red regions of the arc spectrum of titanium, vanadium, chromium, manganese, molybdenum, tungsten, and uranium were photographed with a large concave grating spectrograph. The photographs were made on plates sensitised to these spectral regions by means of pinacyanol and dicyanin dyes. The wave-lengths of more than 2500 spectral lines were measured, extending from the green at 5500 Å. into the infra-red beyond 9700 Å. So far as is known, impurity lines and spurious lines have been eliminated from the wave-length tables. Frequency differences which were suspected of being constant have been found in each of the spectra. Those who are specially interested in this work may obtain a copy of the paper by applying to the Bureau of Standards, Washington.

NEW SOLAR RADIATION STATION IN ARIZONA.—An anonymous benefactor has given funds to the Smithsonian Institution for the establishment of a new solar observing station in the Haqua Hala mountains in the Arizona desert. The site was chosen as "being probably the most consistently cloudless region in the United States." Dr. C. G. Abbot has gone to set up this station, which will duplicate the work that has been done for some years at Calama, Chile; it is stated that the results obtained there are of assistance in predicting the weather and temperature in Argentina. As is well known, Dr. Abbot considers that, besides the 11-year variation, there are irregular changes in the solar radiation from day to day amounting to as much as 5 per cent., which he suggests may be due either to alterations in the circulation in the sun and consequent variation in the amount of hotter matter brought from the interior, or to changes in the transparency of the solar envelopes.

### Iron-depositing Bacteria.<sup>1</sup>

THE appeal of the monograph before us, which is one of the Professional Papers issued under the ægis of the United States Geological Survey, will probably be of direct interest only to a comparatively small section of scientific workers. Although there is much to attract the general reader, it is obvious that the work was not initiated with this end in view. It is worthy of note and a sign of the times that the data supplied by the bacteriologists should be used as a serious weapon of offence in attacking a geological problem.

Many changes, due to biological influences, take place on the earth's surface which profoundly modify the constitution of the material which is destined to become the geological strata of the future. A study of these changes will obviously throw light on the causes which have operated in the past to bring the earth's crust into being. We find in Mr. Harder's paper by far the most comprehensive treatment which we have yet seen of the activities of bacteria in effecting chemical changes in various iron compounds which come within the scope of their influence. He has undertaken the task of bringing together in the form of a critical survey the salient facts of our knowledge of the iron bacteria. This subject occupies the first half of the monograph, and is treated by the author with a masterly regard for essentials, and in it is included the results of some of his own observations and experiments on these interesting micro-organisms. It is interesting to note that the same iron bacteria are found in America as in Europe, although there are slight differences in their distribution and numbers. Thus *Spirophyllum ferrugineum* appears to possess a wider distribution than is the case in this country.

In the preface, which is written by Mr. F. L. Ransome, especial attention is directed to the results of Mr. Harder's inquiry into the physiology of the iron bacteria. Hitherto each investigator has assumed that the results claimed by him as a result of his research on the physiology of some particular species held good for all the iron bacteria. Mr. Harder, however, concludes that there are three principal groups of iron-depositing bacteria: (1) A group the members of which precipitate ferric hydroxide from solutions of ferrous bicarbonate. (2) A second group of iron bacteria that does not require ferrous bicarbonate for its vital processes. (3) A third group that attacks iron salts of organic acids, using the organic acid radicles as food and leaving ferric hydroxide, or basic ferric salts that gradually change to ferric hydroxide. We must confess to a scepticism as to the existence of such deep-seated differences among these organisms, and incline to the opinion that the phenomenon of iron-deposition on micro-organisms shows the working of a simple physiological law which operates on all in the same manner. In support we would advance the fact that *Spirophyllum* and *Leptothrix* are so closely allied that some have regarded them as pleiomorphic varieties of one and the same organism. They live in the same waters, they reproduce alike, and are in every way similar except in external form; and yet *Spirophyllum* is stated to be an example of the first group, whilst *Leptothrix* is relegated to the second group. A more cogent ground for scepticism lies in the fact that other organisms, including some of the algæ and the protozoa, possess the same attraction for iron compounds. Possibly a closer investigation of the *chemico-irritability* of micro-organisms will throw some light on the question.

<sup>1</sup> "Iron depositing Bacteria and their Geologic Relations." By Edmund C. Harder. United States Geological Survey. Professional Paper 113.

We can recommend the second half of the monograph to all who wish concise information from an authoritative source of the iron deposits of the world and of the factors which influence the formation and determine the mode of deposition of the iron precipitations that are taking place at the present day. With one exception iron is the most abundant element in the earth's crust. Iron salts are being constantly decomposed, and the genesis of the active agents which bring about their decomposition is given in detail. A consideration of these agents brings home to us the necessity of studying the life-histories of various micro-organisms in order to understand how the present deposits came into being. To give one example. The most important of the iron deposits is ferric hydroxide, and a study of the conditions of its formation centres largely round the fact that ferrous compounds are soluble in water containing CO<sub>2</sub> in excess. Now, in particular, ferrous bicarbonate percolates upwards in solution, and when it reaches the surface becomes subject to the interplay of forces, both chemical and biological, which determine its subsequent fate. We must refer the reader to the work itself for more precise information regarding the manner in which this fate is determined.

We are also given a very complete account of the various types of ferruginous sedimentary ores, and in each case the intervention of biological agencies, either in the primary or in the secondary rôle, as factors in the determination of the final deposition is explained in a comprehensive and accurate manner. Of greatest interest of all is, we consider, the examination of the conditions which determine the formation of bog-iron ore. These are undoubtedly mainly of a biological nature, and deserve more consideration than they have hitherto received. The interest in this ore is enhanced on account of its formation being a possible stepping-stone to the development of limanites and hæmatites, although Mr. Harder himself has not raised the point. In his reference to the ferrous carbonate deposits he does well to speak with reticence of the factors which have brought about their formation; enough evidence, however, is advanced to give pause to those who would eliminate altogether the activities of micro-organisms from the list of active agents which have brought these deposits into being. Again, Mr. Harder makes out a clear case for the intervention of micro-organisms in the formation of some, at any rate, of the iron sulphide deposits. Sulphuretted hydrogen is evolved as a result of the decomposition of animal and vegetable matter by the saprophytic bacteria. The formation of sulphides with iron compounds is the next step, and it is of great interest that we see the process at work at the present day in the development of the "blue mud" of the ocean bottom.

Both biologists and geologists will be grateful to Mr. Harder for the work which he has done in the preparation of this monograph. DAVID ELLIS.

### The Association of Technical Institutions.

THE Association of Technical Institutions opened its summer meeting at the University of Cambridge on July 23, with the Marquess of Crewe, the president, in the chair. The meeting was extended over the following day, when the chairman of the council, Mr. Dan Irving, M.P., presided. Papers were submitted on "A National System of Education," by Principal J. C. M. Garnett (Manchester); on "The Necessity for Close Co-operation between Technical Colleges and the Universities," by Principal C. Coles (Cardiff); on "Continuation

Schools and their Relation to Technical Institutes and Colleges," by Principal C. L. Eclair-Heath (Newcastle-upon-Tyne); and on "Local Colleges and Adult Education," by Principal L. Small (Bootle).

The suggestions of Mr. Garnett for the establishment of a national system of education in England during the next ten years are embodied in a pamphlet presented to a meeting of the newly formed Federal Council of Lancashire and Cheshire Teachers' Associations in January last. It is accompanied by an elaborate "flow" diagram showing graphically in colour the various types of scholastic institutions suggested, of which as many as sixteen are depicted, ranging from the elementary school upwards to the university, and dealing with school and university life up to the twenty-fifth year. It is declared that "it is the main business of all education to form in the mind of every person a single wide interest centred in a supreme purpose," and that "it is the subordinate business of education to train young people so that they shall be able to realise their central purpose in some particular form of service to their fellows. For example, the particular form of service for which technical and commercial education prepares is that of providing the material wealth without which no community—so different in this respect from an individual—can make much progress towards the fulfilment of high spiritual purposes." The pamphlet proceeds to divide those who are to occupy the various positions in industry, commerce, and other departments of national life into four classes: Leaders in thought and action, about 3 per cent.; skilled managers and assistants, about 17 per cent.; skilled wage-earners, about 40 per cent.; and unskilled labourers and repetition workers, about 40 per cent.

The scheme suggested received the attention of a meeting, held in June last, of the headmasters of secondary schools in Lancashire, Cheshire, Cumberland, and Westmorland, who expressed strong disapproval of its proposals, which they thought too mechanical, and of the suggestion that there should be lower and higher secondary schools. They were not persuaded that it was desirable to prevent the individual growth and development of each school, and that whilst transference and change of grade seemed to be its keynote, the headmasters believed in elasticity, growth, and continuous development.

The purpose of Mr. Coles's paper is to set forth the present unsatisfactory position of technical institutions in this country, and to propose remedies therefor in respect alike of the development of higher education in technical institutions and of the administration thereof, so as to bring them into closer relation with the work of the universities. Mr. Coles advocates the institution of faculties of technology and commerce in connection therewith, and suggests that an investigation should be set up, as in 1882, into the condition of higher technological education in the United Kingdom.

Mr. Small's paper, accompanied by notes by Principal J. F. Hudson (Huddersfield), deals with local colleges and adult education. The authors advocate the development of the technical institute into "the local college," an official term appearing for the first time in the revised regulations for continuation, technical, and art courses issued by the Board of Education in February, 1917, so that it shall include not only the training of workers in commerce and in specific industries, but also their continued education as citizens by the introduction of humanistic studies, and to provide generally for non-vocational subjects of a literary, scientific, and recreative character, together with facilities for the study by adult workers of ques-

tions calculated to promote a better understanding of the character and problems of social life. Already with this end in view the Huddersfield Technical College has entered into close relations with the Yorkshire District Council of the Workers' Educational Association.

Mr. Eclair-Heath in his paper declares that the idea of continuation schools is not new, and instances the excellent example of the Royal Dockyard School at Deptford and elsewhere. He says that early vocational education is undesirable, and that the schools should be held apart from works. He favours mixed schools and the introduction of religious instruction, and suggests that there should be set up a system of selection whereby only suitable students should be allowed the privilege of continued education up to eighteen years of age.

Resolutions were adopted welcoming a large development of humane studies in the constituent institutions of the association in connection especially with adult education:—"That the association accepts the description of the work of a 'local college' contained in Appendix III. of the Draft Regulations of the Board of Education for continuation, technical, and art courses in England and Wales"; and "That each local college should be the recognised centre for the organisation of educational courses for adults in its area and for the supply of qualified lecturers and class tutors and adequate library and other facilities." It was resolved to refer to the council the question that the Board of Education should be asked to accept as "recognised service" the services of teachers engaged in organisation, supervision, and inspection with the view of qualifying such persons for pension under the recent Superannuation Act, and that the Board should furnish to every teacher of forty-five years of age and upwards a statement of his position as to the period of "recognised service" and "qualifying service" at present placed against his name for the purpose of pension.

### The Asiatic Origin of Man.<sup>1</sup>

THE author of the speculative paper referred to below is an evangelist of the gospel of evolution according to Dr. W. D. Matthew. The idea of the Asiatic origin of the dominant orders of mammals, in its source as old as Buffon, was in 1915 placed on a firm basis by Matthew in his paper "Climate and Evolution." This idea Dr. Griffith Taylor now takes up and applies to the case of man. Penck's fourfold subdivision of the Ice Age is regarded as applying generally, and the development of the prehistoric races in Asia is presumed to occur in the successive mild periods as follows:

Chellian and Acheulian.	Pliocene.
Mousterian.	Gunz-Mindel.
Aurignacian, Solutrean, and Magdalenian.	Mindel-Riss.
Azilian and Neolithic.	Riss-Würm.
Bronze-using Races.	Post-Glacial.
Mongolians.	Late Post-Glacial and Historic.

The following Ice Age in each case and in post-Glacial times the progressive desiccation of Asia are presumed to have caused migration from the homeland to the peripheral continents. The migrations are thus fairly well timed to enable the respective races to keep their appointments in Europe, with, perhaps, the exception of the Chellians, Acheulians, and Mousterians, who are too early, if we may judge

<sup>1</sup> "Climatic Cycles and Evolution." By Dr. Griffith Taylor. *Geographical Review*, December, 1919.

by Penck's placing of these culture stages, which, however, rests only on indirect evidence.

Taking as his criteria of evolutionary advance four characters, namely, (1) cephalic index, (2) orbital index, (3) hair section, and, in a modified degree, (4) skin colour, Dr. Griffith Taylor then attempts an analysis of the existing races of mankind, and, so far as the available data permit him, shows that the more primitive races, or those with low cephalic and orbital indices and relatively flattened hair section (generally associated with depth of skin colouring), have been thrust to the more distant parts, from a migrant's point of view, of the outlying continents. Closer in to the centre of distribution come races with successively higher indices, rounder, straighter hair, and reduced colouring, passing through brown, olive, and white to the yellow, brachycephalic, and excessively straight-haired Mongolians, who are the last development of all. So far this is Dr. W. D. Matthew elaborated. A new element is now, however, introduced into the discussion, for an attempt is made to correlate the living with the prehistoric races. One remembers Sollas's tentative comparisons in 1911 ("Ancient Hunters"), viz. Tasmanian with Eolithic or Early Palaeolithic, Australian with Moustertian, Bushman with Aurignacian, and Eskimo with Magdalenian. The author now postulates direct descent for these and many other races too numerous to mention here.

To bring out the nature of the climatic impulse that is supposed to have initiated the successive waves of migration from the homeland in Asia, the author employs the analogy of the seasonal oscillation of the belts of tropical rains, desert, and polar rains in Australia. As he effectively remarks, Nature has placed Australia like a blackboard, on which are recorded the results of the mobile but very regular and law-abiding climatic zones of the southern hemisphere. He brings forward evidence to show that these zones underwent an analogous migration during the climatic oscillations of the Ice age.

The analysis outlined above forms parts i.-iii. of the paper. The general exposition of the argument is crude, and, were it not for the explicitness of the diagrams, would be difficult to follow. This tabulating and precise definition of material largely speculative gives an illusory impression of the state of the subject, but, if the reader is not misled by it, it certainly conduces to clearness. The adroit handling of a subject so as to distinguish fact and legitimate inference from mere speculation is the last art of the scientific writer.

The remainder of the paper is devoted to geological speculations of less interest. Part iv. is an exposition of Chamberlin's theory of cyclic change. Chamberlin's writings (1897-1901) on the subject are not, however, quoted, the principal authority relied on being Schuchert (1914). In this section a table of roughly approximate temperatures is given for the periods from the Triassic to the present. That this type of tabulated speculation is dangerous is instanced by the fact that both zoological and botanical evidence show that the temperature of Europe in the Neolithic period was several degrees higher than it is at the present day, instead of 7° F. lower, as stated.

Part v. is an estimate of geological time based on various authorities. The statement is made that "Joly quotes similar figures, indicating about 300,000,000 as the time interval since the same epoch" (the Cambrian). It is difficult to conceive the author's motive, if any, for this implicit misrepresentation of the works cited, for it matters not a straw to his theory whether the interval since the Cambrian is 300,000,000 or less than 100,000,000 years, as concluded by Joly.

Part vi. is a suggestion, on astronomical lines, of rhythmic oscillations of climate, etc. It is on a par with many former theories of the Ice age in assigning a cause which there is no independent evidence to show was ever operative.

Papers such as this which deal in giddy speculation have for some time past been looked at askance by the more puritanically minded of our elder geologists. We are not sure that they deserve the contempt with which they are treated. In this matter, however, there is a golden mean, and we should have preferred to see the present paper made less comprehensive, and the leading subject-matter of human migrations more thoroughly dealt with. It is of no use trying to straighten out the universe in an article.

W. B. WRIGHT.

### Long-range Forecasting in Java.

PUBLICATION No. 5, 1919, of the Royal Observatory of Batavia, entitled "Atmospheric Variations of Short and Long Duration in the Malay Archipelago and Neighbouring Regions, and the Possibility to Forecast Them," by Dr. C. Braak, embodies the results of a long investigation into the sequence of rainfall in the equatorial regions east of the Indian Ocean. Three kinds of variation are studied: (1) with periods of one or more years up to and including the sun-spot period, (2) secular variations, and (3) with periods less than a month, comparable with Abbot's short-period solar fluctuations. The variations, the period of which is intermediate between (1) and (3) above, are treated as disturbances of (1). Dr. Braak lays much stress on a three-year period, of the persistence of which he gives plausible, though not quite convincing, examples. He classifies three groups of years, of high barometer, low barometer, and transition (from high to low), but naturally finds a proportion of years not strictly true to any of these types. It is scarcely surprising that he finds in general a correlation between barometric pressure and rainfall. For the east monsoon he finds strong positive correlation between high pressure and drought, and weaker between low pressure and excess of rain. For the west monsoon he finds, with some local exceptions, excess of rain with high barometer, and deficit with low barometer. His problem is thus reduced to the intensity of the correlation and the chances of a correct forecast of the barometer variation. His next step takes into account temperature changes which may be expected to modify pressure conditions, but his result is disappointing. He obtains rules, but their application is so far a failure that they appear to break down most thoroughly in years of drought—that is, when, if correct, they would be most valuable.

Turning to secular variations, he finds no evidence of progressive change in Batavian rainfall; in fact, the only progressive change on which he lays stress is in Batavian air-temperature. Comparison with stations in India, Australia, and other places in the same quarter of the globe provides other types of change, but none agreeing with Batavia, and the question is left unsolved.

There remain the short-period pressure waves. The equatorial manifestations of these he attributes to a kind of surge, caused by the great disturbances in higher latitudes, exercising a sucking influence or its converse, with slight variations of the rainfall, less than 10 per cent. of the normal, the effect of which is to compensate the pressure difference by cooling or heating air probably above the 3000-metre level.

Other variations of rainfall, humidity, and cloudiness he considers to be local, and, on the whole, rejects

the possibility of forecasting any short-period variations in the rainfall. Inasmuch as we are bound to regard the tropics as the first stage in the translation of solar variation into weather, it seems a pity that the result obtained in what is probably the best known region of the tropics in regard to meteorological statistics should appear so meagre and wanting in definiteness. Similar work in temperate regions may well be discouraged, but there is still an enormous mass of data

W. W. B.

### Insects of Arctic Canada.

THE insects of various orders—as well as a few spiders, mites, and centipedes—collected by members of the recent Canadian Arctic Expedition (1913-18) have been recorded and described in vol. iii. of the Report (Ottawa, 1919-20). The lists contain much information of value to students of zoological geography. Among the Lepidoptera (described by Arthur Gibson) it is interesting to see varieties of such well-known British butterflies as *Pieris napi*, *Papilio machaon*, and *Vanessa antiopa*. Most of the Coleoptera (by J. M. Swaine, H. C. Fall, C. W. Leng, and J. D. Sherman) belong to species already known in North America, and the same remark applies to the bees described by F. W. L. Sladen, who points out that bumble-bees are "particularly well adapted to Arctic conditions," and records the capture of five nearly full-fed *Bombus* larvæ on Melville Island (75° N. lat.) on June 21, 1916. The sawflies, described by A. G. MacGillivray, are mostly new species, and, as might have been expected, willow feeders. Among the Diptera (by C. P. Alexander, H. G. Dyar, and J. R. Malloch) there are some interesting details of larvæ as well as descriptions and records of flies, which are relatively numerous in species. The occurrence of larvæ of *Oedemagena tarandi*—the warble-fly of the European Reindeer—in Barren-ground Caribou at Bernard Harbour is noteworthy. Mosquitoes of a couple of species of the genus *Edes* were observed (and felt) in swarms. As regards wingless parasites, Prof. G. H. F. Nuttall records that head-lice (*Pediculus capitis*) from the Copper Eskimo of Coronation Gulf show no varietal distinction from members of the species found elsewhere. Dr. J. W. Folsom enumerates a dozen species of springtails (Collembola); two only of these are new, but his figures of structural details, drawn carefully from Arctic specimens of common and widespread northern forms, will be welcome to students of this order.

G. H. C.

### Earthquake Waves and the Elasticity of the Earth.

DR. C. G. KNOTT delivered a lecture on "Earthquake Waves and the Elasticity of the Earth" before the Geological Society on June 9. He pointed out that seismograph records of the earth-movements due to distant earthquakes proves that an earthquake is the source of two types of wave-motion which pass through the body of the earth, and a third type which passes round the surface of the earth. Before earthquake records were obtained, mathematicians had shown that these three types of wave-motion existed in and over a sphere consisting of elastic solid material. Many volcanic phenomena, however, suggest the quite different conception of a molten interior underlying the solid crust. At first statement these

views seem to be antagonistic, but there is no difficulty in reconciling them. Whatever be the nature of the material lying immediately below the accessible crust, it must become at a certain depth a highly heated fairly homogeneous substance behaving like an elastic solid, with two kinds of elasticity giving rise to what are called the compressional and distortional waves. The velocities of these waves are markedly different, being at every depth nearly in the ratio of 1.8 to 1. Both increase steadily within the first thousand miles of descent towards the earth's centre, the compressional wave-velocity ranging from 4.5 miles per second at the surface to 8 miles per second at depths of 1000 miles and more; the corresponding velocities of the distortional wave are 2.5 and 4.3 at the surface and at the 1000-mile depth respectively. At greater depths these high velocities seem to fall off slightly; but the records fail to give us clear information as to velocities at depths greater than about 2500 miles. Down to this depth the earth behaves towards these waves as a highly elastic solid. The elastic constants, which at first increase with depth more rapidly than the density, become proportional to the density, for the velocity of propagation becomes practically steady. About half-way down, however, the material seems to lose its rigidity (in the elastic sense of the term), and viscosity possibly takes its place, so that the distortional wave disappears. In other words, there is a nucleus of about 1600 miles radius which cannot transmit distortional waves. This nucleus is enclosed by a shell of highly elastic material transmitting both compressional and distortional waves exactly like an elastic solid.

### University and Educational Intelligence.

ABERDEEN.—Dr. R. D. Lockhart has been appointed a lecturer in anatomy.

It has been decided to institute a full-time lecture-ship in bacteriology in the department of pathology.

BIRMINGHAM.—It has been decided that the fees payable by new students entering the University next session shall be increased by 25 per cent. The reasons given for the increase are: (1) The great rise in the cost of administration, materials, maintenance, taxation, and the wages of employees; and (2) the necessity for improving the payment of the academic, particularly the non-professorial, staff.

The Vice-Chancellor (Sir Gilbert Barling), according to the *Birmingham Post*, states that "it is absolutely necessary to increase the stipends of the staff for two reasons: the present salaries are quite inadequate to maintain the teachers in a reasonable state of comfort; and, secondly, because without such increase they will be attracted to other places where stipends are more commensurate with their capacity and worth."

CAMBRIDGE.—The Balfour Memorial Fund student-ship will be vacant on October 1 next. Applications are invited for it. Candidates should apply by, at latest, September 15 to Prof. J. Stanley Gardiner, Zoological Laboratory, Cambridge.

On July 29 the honorary degree of Doctor of Law was conferred upon Dr. A. L. Lowell, president of Harvard University; Prof. J. J. Abel, professor of pharmacology, Johns Hopkins University; and Prof. H. Cushing, professor of surgery at Harvard University.

OXFORD.—The fear expressed in some quarters that the application by the University for a Government grant would check the liberality of private benefactors has proved to be groundless in at least one con-

spicuous instance. Mr. Walter Morrison, of Balliol College, has just paid to Bodley's librarian the sum of 50,000l. for the capital account of the library. No further conditions are annexed to the gift. This is not the only benefaction for which the University is indebted to Mr. Morrison, for some eight years ago he gave 10,000l. to each of three funds—one for the readership in Egyptology, another for the promotion of the study of agriculture, and a third towards the establishment of a professors' pension fund.

THE Cairo correspondent of the *Times* announces that the American Presbyterian Board proposes to establish a university at Cairo, and has purchased a fine site for the building. The new University will be composed of five colleges, namely, arts, Oriental languages, teachers, commerce, and agriculture. It is stated that the first of these will be opened in October.

NOTICE is given that, provided sufficient merit be shown, an election to a fellowship in experimental physics or physical chemistry at Trinity College, Dublin, will take place in May, 1921. Candidates must submit papers or theses (published or unpublished) on or before March 25 next. Further particulars may be obtained from the Registrar, Trinity College, Dublin.

ON the occasion of the meeting of the British Association at Cardiff on August 24-28 the University of Wales will confer the honorary degree of D.Sc. upon the following:—Dr. H. F. Osborn, president of the American Museum of Natural History, or, if he is unable to attend, Prof. C. A. Kofoid, University of California; Prof. G. Gilson, University of Louvain, or, if he cannot attend, Dr. C. H. Ostenfeld, University of Copenhagen; Don Guillermo Joaquin de Osma, Madrid; and Prof. Yves-Guyot, Paris.

THE following subjects of wide educational interest are to be discussed at meetings of the Old Students' Association of the Royal College of Science, London, in the autumn:—September 14, Pre-Kensington History of the Royal College of Science and the University Problem in London, Prof. H. E. Armstrong; October 12, The Proposed University of Science and Technology: Can a Useful and Worthy University be based on Pure and Applied Science?, Mr. J. W. Williamson; and November 9, The Nationalisation of Universities, Viscount Haldane.

DR. R. S. CLAY, principal of the Northern Polytechnic Institute, Holloway, London, N.7, informs us that the governors are re-establishing in September the school of rubber technology at this Polytechnic, and that the school will in future be under the directorship of Dr. P. Shidrowitz, well known by his researches and publications on the chemistry and technology of rubber. There will be a day course open only to students who have had a thorough training in chemistry—preferably at one of the universities—and evening classes for those already in the industry. The school will be in close touch with the industry, as it will be under an advisory committee composed of representatives of the manufacturers, growers, dealers, rubber engineers, etc., and will, therefore, afford a sound theoretical and practical training for those proposing to enter a rubber factory.

THE May issue of *School Life*, issued by the U.S. Bureau of Education, shows that there has been a large increase in the demand for collegiate education during the ten years between 1905-6 and 1915-16. The period shows an advance, especially in public institutions, from 258,603 in 1905-6 to 387,106 in 1915-16, being an increase in the case of men of 40.1 per cent., and in that of women of 70 per cent. The number of

teachers engaged has also risen from 23,950 to 31,312. The total income of these institutions has grown during this period from 62,499,931 dollars to 133,627,911 dollars, or 113 per cent., made up of students' fees 36,133,969 dollars, productive funds 18,983,868 dollars, United States Government 6,258,931 dollars, State or city 32,204,111 dollars, private benefactions 30,196,006 dollars, and other sources 9,850,326 dollars. The endowment fund increased from 248,430,394 dollars in 1905-6 to 425,245,270 dollars in 1915-16, or 71.2 per cent. A further table shows that during the last three years there has been a general increase of attendance of 25 per cent. at these institutions.

THE activities of the U.S. Department of the Interior (Bureau of Education) include the bi-monthly issue of a journal entitled *School Life*. That of May last is concerned largely with the question of the supply and remuneration of teachers, a problem apparently even more acute in America than in this country, as is instanced by the fact that on a given day in May the School Board Service Division of the Bureau of Education received 436 requests for teachers, with only seven teachers applying for posts. The chief of the Division reports that a year ago there were 14,000 registrations from teachers willing to take positions. A recent canvass of this list showed only about 4000 now available for service. The maximum average annual salary of teachers for any State is 1600 dollars, whilst the minimum is 93 dollars. The journal further deals with the payment of university teachers, and asks the question: Does it pay to be a college professor? The result of a recent inquiry circular sent out by the Bureau, to which more than two-thirds of the colleges and universities returned detailed and accurate answers, was that in privately supported institutions full professors are receiving on the average 2304 dollars per annum, while assistant professors and instructors draw salaries of about 1800 dollars and 1200 dollars respectively. The salaries of professors at State institutions average 3126 dollars, of assistant professors 2100 dollars, and of instructors 1400 dollars. There is an interesting table comparing the salaries in 1919 of professors, assistant professors, and instructors with those of artisans and labourers, much to the advantage of the latter in some cases.

THE development of social activities in the country districts is a problem of the first importance, and in the May issue of the *Journal of the Ministry of Agriculture* there is a most interesting paper entitled "Social Service in Rural Areas." The author, Sir Henry Rew, points out that if we are to maintain our agricultural output we must provide for the recreation of our farm labourers and their families. The conditions of village life, and, indeed, the whole psychology of the village people, have undergone great changes in the last few years. The young men returning from the Army to their native villages have found expression; the economic status of the farm-worker is improved; and, above all, there now exists a definite organisation of the farm-workers. These men are essentially a practical race; their ambitions are not restricted to increased wages; they simply make a reasonable claim that life shall not be merely a weary monotony of toil, but that there shall be opportunities for enjoyment—more than are afforded by the village alehouse. The demand is universal, and must be met without delay. In the Report of the Adult Education Committee it is suggested that every village should be provided with an institute under full public control. This institute should be the centre of all communal activity, educational, social, and recreational.

## Societies and Academies.

SYDNEY.

Royal Society of New South Wales, June 2.—Mr. James Nangle, president, in the chair.—H. G. Smith and A. R. Penfold: The manufacture of thymol, menthone, and menthol from eucalyptus oils. Work was undertaken in order to determine the molecular structure of piperitone, the peppermint ketone of eucalyptus oils. Piperitone is a menthenone with the carbonyl group in the 3 position. When oxidised with ferric chloride in the ordinary way 25 per cent. of thymol was produced. By reducing piperitone with hydrogen in the presence of a nickel catalyst an almost quantitative yield of menthone was obtained, which on further reduction with sodium in aqueous ether produced menthol. The abundance of piperitone obtainable from *Eucalyptus dives* makes this ketone probably the best source for the manufacture of thymol and menthone.—R. H. Cambage: A new species of Queensland ironbark. This new eucalyptus comes from about 120 miles westerly from Cairns, in tropical Queensland, and furnishes a good, red timber. It was found growing on granite formation in open forest country, and resembles *E. crebra* in bark and timber, but differs in the shape of buds and fruits, which latter are hemispherical with exserted valves.

## Books Received.

The Physical Chemistry of the Metals. By Prof. R. Schenck. Translated and annotated by R. S. Dean. Pp. viii+239. (New York: J. Wiley and Sons, Inc.; London: Chapman and Hall, Ltd.) 22s. 6d. net.

A Constitution for the Socialist Commonwealth of Great Britain. By Sidney and Beatrice Webb. Pp. xviii+364. (London: Longmans, Green, and Co.) 12s. 6d. net.

Governors and the Governing of Prime Movers. By Prof. W. Trinks. Pp. xviii+236. (London: Constable and Co., Ltd.) 22s. 6d. net.

The World Crisis: A Suggested Remedy. By Sir G. Paish. Pp. 30. (London: Benn Bros., Ltd.) 6d.

A Manual of the Timbers of the World: Their Characteristics and Uses. By A. L. Howard. Pp. xvi+446. (London: Macmillan and Co., Ltd.) 30s. net.

Dead Towns and Living Men: Being Pages from an Antiquary's Notebook. By C. L. Woolley. Pp. viii+259. (London: Oxford University Press.) 12s. 6d. net.

Le Rythme Universel. Comme base d'une Nouvelle Conception de l'Univers. By Prof. Dr. C. Mereschkovsky. Pp. 48. (Genève et Lyon: Georg & Co.)

Liverpool School of Tropical Medicine. Historical Record, 1898-1920. Pp. viii+103+plates. (Liverpool: University Press.)

General Botany for Universities and Colleges. By Prof. H. D. Densmore. Pp. xii+459. (Boston and London: Ginn and Co.) 12s. 6d. net.

Internal-Combustion Engines: Their Principles and Application to Automobile, Aircraft, and Marine Purposes. By Lt.-Comdr. W. L. Lind. Pp. v+225. (Boston and London: Ginn and Co.) 10s. net.

Types and Breeds of Farm Animals. By Prof. C. S. Plumb. Revised edition. Pp. viii+820. (Boston and London: Ginn and Co.) 16s. 6d. net.

Geodesy: Including Astronomical Observations, Gravity Measurements, and Method of Least Squares. By Prof. G. L. Hosmer. Pp. xi+368. (New York:

J. Wiley and Sons, Inc.; London: Chapman and Hall, Ltd.) 18s. 6d. net.

Prospecting for Oil and Gas. By L. S. Panyity. Pp. xvii+249. (New York: J. Wiley and Sons, Inc.; London: Chapman and Hall, Ltd.) 18s. net.

London County Council. Education Act, 1918. Draft Scheme of the Local Education Authority. Pp. 112. (London: L.C.C. Education Offices.)

Free Will and Destiny. By St. G. Lane-Fox Pitt. Pp. xix+100. (London: Constable and Co., Ltd.) 5s.

The Victoria History of the Counties of England. A History of the County of Surrey. Part 1, Geology, by G. W. Lamplugh; Palæontology, by R. Lydekker. Pp. 34. 3s. 6d. net. Part 2, Botany, edited by W. H. Beeby. Pp. 35-70. 3s. 6d. net. Part 3, Zoology. Pp. 71-226. 12s. 6d. net. Part 4, Early Man, by G. Clinch. Pp. 227-54. 2s. 6d. net. (London: Constable and Co., Ltd.)

La République Argentine: La Mise en Valeur du Pays. By Dr. P. Denis. Pp. 303+vii plates. (Paris: A. Colin.) 14 francs.

A Little Book about Snowdon. By H. V. Davis. Pp. 30. (Crewe: The Author, "Noddfa," Wistaston.) 8d.

Canada. Department of Mines. Mines Branch. Graphite. By H. S. Spence. Pp. ix+202+plates. (Ottawa.)

Peetickay: An Essay towards the Abolition of Spelling. By Dr. W. Perrett. Pp. 96. (Cambridge: W. Heffer and Sons, Ltd.) 6s. net.

Atomic and Molecular Theory. By D. L. Ham-mick. Pp. 82. (Winchester: P. and G. Wells.)

## CONTENTS.

	PAGE
University Grants	701
Tanks and Scientific Warfare	702
Physiology of Farm Animals	704
Chemical Text-books. By C. S.	705
Our Bookshelf	707
Letters to the Editor:—	
Relativity and Reality.—Prof. R. A. Sampson, F.R.S.	708
An Attempt to Detect the Fizeau Effect in an Electron Stream.—Prof. R. Whiddington	708
Plant-life in Cheddar Caves.—Lough. Pendred	709
The Diamagnetism of Hydrogen.—Dr. A. E. Oxley	709
Loss of Fragrance of Musk Plants.—Hon. Col. C. J. Bond, C.M.G.	709
Meteorological Conditions of an Ice-cap.—R. F. T. Granger	709
The Research Department, Woolwich. I. (Illustrated.) By Sir Robert Robertson, K.B.E., F.R.S.	710
The Earliest Known Land Flora. II. By Prof. F. O. Bower, F.R.S.	712
Meteorological Influences of the Sun and the Atlantic. By Prof. J. W. Gregory, F.R.S.	715
The Thermionic Valve in Wireless Telegraphy and Telephony. (Illustrated.) By Prof. J. A. Fleming, F.R.S.	716
Obituary:—	
Prof. J. C. F. Guyon	721
Notes	721
Our Astronomical Column:—	
The Hill Observatory, Sidmouth	726
The Infra-red Arc Spectra of Seven Elements	726
New Solar Radiation Station in Arizona	726
Iron-depositing Bacteria. By Dr. David Ellis	727
The Association of Technical Institutions	727
The Asiatic Origin of Man. By W. B. Wright	728
Long-range Forecasting in Java. By W. W. B.	729
Insects of Arctic Canada. By G. H. C.	730
Earthquake Waves and the Elasticity of the Earth. University and Educational Intelligence	730
Societies and Academies	732
Books Received	732



THURSDAY, AUGUST 12, 1920.

*Editorial and Publishing Offices:*

MACMILLAN &amp; CO., LTD.,

ST. MARTIN'S STREET, LONDON, W.C.2.

Advertisements and business letters should be  
addressed to the Publishers.

Editorial communications to the Editor.

Telegraphic Address: PHUSIS, LONDON.

Telephone Number: GERRARD 8830.

### Progress!

THE word "progress" primarily signifies "a stepping forwards"—*forwards* not in relation to some real or imaginary goal the arrival at which we assume to be desirable, but merely in regard to the individual moving—in fact, a stepping "frontwards" as opposed to standing still or to stepping "backwards." In the course of the past few centuries it has, however, acquired a definite secondary limitation—that of the movement or development of human society towards a desirable goal—namely, earthly felicity, happiness, even perfection—or towards the attainment of perfect happiness in a future state of existence. The measure of "progress" thus necessarily has varied according to the conception of happiness—about which there have always been divergent opinions, and never an accepted definition. The philosophers of antiquity were pessimists: they did not entertain a belief in progress, but, on the contrary, held (with the notable exception of the Epicureans) that we are receding from a long-past golden age of happiness.

The notion of earthly progress was opposed by the Christian Church, which endeavoured to fix men's minds on a future state of rewards and punishments. A belief in the distribution of these by its intervention was the chief basis of the authority and power of the Church. The spirit of the Renaissance—the challenge to the authority of the ancients and of the Church, the emancipation of the natural man in the fields of art and of literature, and, later, in the sphere of philosophical thought—was accompanied by the development of the idea of progress. Ramus, a

mathematician, writes in the year 1569: "In one century we have seen a greater progress in men and works of learning than our ancestors had seen in the whole course of the previous fourteen centuries." The French historian, Jean Bodin, about the same time, reviewing the history of the world, was the first definitely to deny the degeneration of man, and comes (as Prof. Bury tells us in the fascinating book which we have used<sup>1</sup> as the text of this article) nearer to the idea of progress than anyone before him. "He is," says Prof. Bury, "on the threshold." And then Prof. Bury proceeds to trace through the writings of successive generations of later philosophers and historians—such as Le Roy, Francis Bacon, Descartes, the founders of the Royal Society, and others, such as Leibnitz, Fontenelle, de Saint Pierre, Montesquieu, Voltaire, Turgot, Rousseau, Condorcet, Saint Simon, and Comte—the various forms which this idea of "progress" assumed, its expansions and restrictions, its rejection and its defence, until we come to the Great Exhibition of 1851, and, later still, to the new aspect given to the idea of progress by the doctrine of evolution and the theories of Darwin and of Spencer.

These chapters provide the reader with a valuable history of an important line of human thought. But the most interesting part to many of us must be the closing pages in which the actual state of the idea of progress as it appears in the light of evolution is sketched, and the questions are raised, which it has not been Prof. Bury's purpose to discuss, viz. Granted that there has been progress, in what does it consist? Is it likely to continue? Does the doctrine of evolution, now so firmly established, lead us to suppose that "progress" will continue, and, if so, what will be its character? Or is it (however we define it) coming to an end? Will stagnation, or will decay and degeneration, as some suppose, necessarily follow? Or is "progress" (whatever one may mean by that word) a law of human nature?

The doctrine of the gradual evolution of the inorganic universe had already gained wide acceptance before the epoch when Darwin's "Origin of Species" brought man into the area of evolution, and established the accepted belief in the "progress" of man from an animal ancestry to the present phase of the more

<sup>1</sup> "The Idea of Progress: An Inquiry into its Origin and Growth." By Prof. J. B. Bury. Pp. xv+377. (London: Macmillan and Co., Ltd., 1902.) Price 14s. net.

civilised races. It does not follow as a matter of course that such a development means the movement of man to a desirable goal. But (as Prof. Bury reminds us) Darwin, after pointing to the fact that all the living forms of life are lineal descendants of those which lived long before the Silurian epoch, argues that we may look with some confidence to a secure future of equally immeasurable length; and, further, that, as natural selection works solely by and for the good of each being, all corporeal and mental endowments will tend to progress towards perfection. Darwin was a convinced optimist.

Equally so was Spencer. According to him, change is the law of all things, and man is no exception to it. Humanity is indefinitely variable, and perfectibility is possible. All evil results from the non-adaptation of the organism to its conditions. In the present state of the world men suffer many evils, and this shows that their characters are not yet adjusted to the social state. Now the qualification requisite for the social state is that each individual shall have such desires only as may fully be satisfied without trenching upon the ability of others to obtain similar satisfaction. This qualification is not yet fulfilled, because civilised man retains some of the characteristics which were suitable for the conditions of his earlier predatory life. He needed one moral constitution for his primitive state; he requires quite another for his present state. The result is a *process of adaptation* which has been going on for a long time, and will go on for a long time to come. Civilisation represents the adaptations which have already been accomplished. *Progress means the successive steps of the process.* (There we have the scientific definition of human progress according to the apostle of evolution.) The ultimate development of the *ideal man* by this process (says Spencer) is logically certain—as certain as any conclusion in which we place the most implicit faith: for instance, that men will all die. Progress is thus held by Spencer to be not an accident, but a necessity. In order that the human race should enjoy the greatest amount of happiness, each member of the race should possess faculties enabling him to experience the highest enjoyment of life, yet in such a way as not to diminish the power of others to receive like satisfaction.

Let me say, in order to avoid misapprehension, that in what follows I am not citing Prof. Bury, but stating my own opinions and suggestions.

It has been urged in opposition to the optimistic doctrine of Darwin and Spencer that it is a prominent fact of history that every great civilisation of the past progressed to a point at which, instead of advancing further, it stood still and declined. Arrest, decadence, decay, it is urged, have been the rule. This, however, is but the superficial view of the historian who limits his vision to the last four or five thousand years of man's development. It is not confirmed when we trace man from the flint-chippers of 500,000 years ago to the present day.

Naturalists are familiar with the phenomenon of *degeneration* in animal descent. Higher, more elaborate forms have sometimes given rise to simplified, dwindled lines of descent, specialised and suited to their peculiar environments. The occasional occurrence of such development in the direction of simplification and inferiority, and even the extinction of whole groups or branches of the genealogical tree of organisms, endowed with highly developed structural adaptations, and the survival of groups of extreme simplicity of structure, does not invalidate the truth of the conclusion as to a vast and predominating evolution—with increase of structure and capacity—of the whole stock of animal and vegetable organisms. A similar line of argument applies to the long and extended history of mankind.

The conclusion adverse to the reality of the evolutionary progress of mankind which is held by those who declare that the ancient Greeks and other products of human evolution of like age had developed a degree of artistic execution and feeling, of devotion to intellectual veracity and ideal justice, to which more modern civilisation has not attained, is a fanciful exaggeration in which it pleases some enthusiasts to indulge. But an examination of the facts makes it abundantly clear that the conclusion is altogether erroneous.

Another attempt to discredit the belief in progress consists in an ambiguous use of the word "happiness" when it is declared that the teeming millions of China or even the herds of sheep browsing on our hill-sides are "happier" than the civilised peoples of Europe and America. Spencer's definition of the goal of human progress as determined by the general laws of organic evolution should lead in this discussion either to the abandonment of the use of the vague term "happiness," or to a critical examination of the state of feeling which it implies, and of the causes to which they are specifically related.

When we ask whether the conditions which have been the essential factors in human evolution and progress are still in operation and likely to operate for an indefinite period in the same direction, there is, in spite of the view as to their permanence held both by Spencer and by Darwin, room for doubt and for re-examination of the situation.

The struggle for existence, the natural selection thereby of favoured variations, and their transmission by physical heredity from parent to offspring, suffice to explain the evolution of man's bodily structure from that of preceding ape-like animals, and even to account for the development of man's brain to greatly increased size and efficiency. But a startling and most definite fact in this connection has to be considered and its significance appreciated. The fact to which I refer is that since prehistoric man, some hundred thousand years ago, attained the bodily structure which man to-day possesses, there has been no further development of that structure—measurable and of such quality as separates the animals nearest to man from one another. Yet man has shown enormous "progress" since that remote epoch. The brain and the mental faculties connected with it have become the dominant and only progressive, "evolving," attribute of man. And even in regard to the brain there is, since the inception of the new phase of development which we have now to consider, no increase of size, though were we able to compare the ultimate microscopic structure of the brains of earlier and later man we should almost certainly find an increased complexity in the minute structure of the later brain.

It seems to be the fact that—when once man had acquired and developed the power of communicating and receiving thought, by speech with his fellow-man (so as to establish, as it were, mental co-operation), and yet further of recording all human thought for the common use of both present and future generations, by drawing and writing (to be followed by printing)—a totally new factor in human evolution came into operation of such overwhelming power and efficiency as to supersede entirely the action of natural selection of favoured bodily variations of structure in the struggle for existence. Language provided the mechanism of thought. Recorded language—preserved and handed on from generation to generation as a thing external to man's body—became an ever-increasing gigantic heritage, independent of the mechanism of variation and of the survival

of favoured variations which had hitherto determined, the organic evolution of man as of his ancestry. The observation, thought, and tradition of humanity, thus independently accumulated, continually revised, and extended, have given to later men that directing impulse which we call the moral sense, that still, small voice of conscience, the voice of his father-men, as well as that knowledge and skill which we call science and art. These things are, and have been, of far greater service to man in his struggles with the destructive forces of Nature and with competitors of his own race than has been his strength of limb and jaw. Yet they are not "inborn" in man. The young of mankind enter upon the world with a mind which is a blank sheet of "educable" quality, upon which, by the care of his elders or by the direction of his own effort, more or less of the long results of time embodied in the Great Record, the chief heritage of humanity, may be inscribed. From this point of view it becomes clear that knowledge of "that which is," and primarily, knowledge of the Great Record, must be the most important factor in the future "Progress of Mankind." Thus one of the greatest services which man can render to his fellows is to add to the common heritage by making new knowledge of "that which is," whilst a no less important task is that of sifting truth from error, of establishing an unflinching devotion to veracity, and of promoting the prosperity of present and future generations of his race by facilitating, so far as lies within human power, the assimilation by all men of the chief treasures of human experience and thought.

The laws of this later "progress" are not, it would seem, those of man's earlier evolution. What they are, how this new progress is to be made more general and its continuance assured, what are the obstacles to it and how they are to be removed, are matters which have not yet been adequately studied. The infant science of psychology must eventually help us to a better understanding. Not only the reasoning intelligence, but also the driving power of emotion must be given due consideration. "Education" not only of the youth, but also of the babe and of the adult, must become the all-commanding interest of the community. Progress will cease, to a large extent, to be a blind outcome of natural selection; it will acquire new characteristics as the conscious purpose of rational man.

E. RAY LANKESTER.

### Complex Elements in Geometry.

*The Theory of the Imaginary in Geometry, together with the Trigonometry of the Imaginary.* By Prof. J. L. S. Hutton. Pp. vii+215. (Cambridge: At the University Press, 1920.) Price 18s. net.

WHEN we interpret  $\phi(x, y) = 0$ ,  $\psi(x, y) = 0$  as the point-equations of two loci, we are bound to consider any values  $(x_i, y_i)$  which satisfy both equations as the co-ordinates of a point common to both curves. The simplest case is when  $\phi, \psi$  are polynomials with ordinary integral coefficients; here the values  $(x_i, y_i)$  are determinate, and can be calculated, either exactly or to any desired degree of approximation. Abstractly,  $(x_i, y_i)$  are a perfectly definite set of couples of algebraic numbers. A couple  $(x_i, y_i)$  may be real, and then corresponds to a real point; but it may be, and often is, complex. What is the most appropriate and fruitful way, from a geometrical point of view, of interpreting these complex solutions of the given pair of equations? This is one of the fundamental problems of analytical geometry, and there are two ways in which it may be attacked. Suppose that the coefficients of  $\phi, \psi$  are real, complex intersections  $(x_i, y_i)$  fall into conjugate pairs. The usual analytical formula gives a real line as the join of two conjugate points, and we may call this a common chord of the two loci. The visible result of combining  $\phi = 0$ ,  $\psi = 0$  may be said to be a certain number of real intersections and a certain number of real lines which, from an algebraical point of view, are to be regarded as common chords. The most familiar case is that of two circles and their radical axis; and here we have a geometrical definition of the radical axis which applies whether it meets the two circles or not. We can construct a definition of a common chord of two conics by analogy, whether it meets them in two real or two conjugate complex points; but the procedure is artificial, and there is no obvious way of extending it to higher curves.

The other way is to try to find, as the image or representative of  $(x, y)$ , when  $x, y$  are not both real, some definite constructible geometrical entity to which we can give the name of "point" without violating the axioms of projective geometry—e.g. it must still be true that any two points determine a line, and so on. This, of course, involves an appropriate definition of a complex line.

It is to von Staudt that we owe an absolutely perfect solution of this difficult problem. Its basic idea is this: Given a real conic, and a real line which does not cut it (in the ordinary sense), there

is on the line an elliptic involution of pairs of points conjugate to the conic. With this elliptic involution we can associate either of two opposite "senses" (or directions), and we can interpret the involution, with either sense, as a complex point. These complex points are distinct, and conjugate in a sense analogous to the algebraic one. This geometrical distinction of conjugate complex points appears to have been the one thing with which von Staudt had the greatest difficulty; it must be remembered that he was trying to find a theory applicable to three dimensions as well as to two, and that he wanted to define the line joining any two points in space whether real or complex, and this by purely projective considerations. The "join" of two non-conjugate complex points in space is von Staudt's "line of the second kind," and the most difficult to realise of all his concepts.

What we may call a metrical, or Cartesian, image of a complex point  $(a+bi, c+di)$  is a segment  $\overline{OP}$  drawn from the real point  $(a, c)$  to the real point  $(a+b, c+d)$ . The conjugate point is represented by a segment  $\overline{OP'} = -\overline{OP}$ , and these two conjugate points are on the real line  $PP'$ . Poncelet, following that Will-o'-the-Wisp, the "principle of continuity," very nearly hit upon this representation; for if we consider  $x^2 + y^2 = a^2$ ,  $x = b$  ( $b > a$ ), we have as the intersections  $(b, \pm i\sqrt{b^2 - a^2})$ , which, in this representation, are the principal ordinates of the real hyperbola  $x^2 - y^2 = a^2$ .

Prof. Hutton practically adopts this metrical definition, but in doing so, as it seems to us, introduces unnecessary vagueness, and occasionally wabbles between the two points of view. He begins by an "axiom" which von Staudt breaks up into two definitions, and, so far as we can see, ignores it in all his algebraical "verifications." There is no such thing as an algebraical verification in the true theory. The algebra is taken for granted, and we have to show that our geometrical definitions and postulates and axioms agree with ordinary complex algebra. In the Cartesian representation a point which we may call  $(\overline{OP})$ , or more simply  $(OP)$ , corresponds to von Staudt's representation  $(O \infty PP')$ , where  $O$  bisects  $PP'$ , and  $\infty$  is the point at infinity on the real line  $POP'$ .

So long as we keep to von Staudt's projective definition, the questions of such things as "distance," "angle," etc., do not arise. "Sense" and "order" are essential, the latter especially when we consider von Staudt's theory of "casts" and cross-ratios.

It is in connection with the Cartesian imagery

that we are confronted with questions about distances, angles, and so on. We are bound to interpret the distance ( $\delta$ ) between the points  $(a + bi, c + di)$  and  $(a' + b'i, c' + d'i)$  as given by

$$\delta^2 = \{(a-a') + (b-b')i\}^2 + \{(c-c') + (d-d')i\}^2,$$

and there are corresponding theorems about angles.

On the whole, we think Prof. Hatton's book will be most useful in suggesting ways in which the Cartesian way of regarding complex points (and lines) is brought into line (without sacrificing logic) with the projective theory. What we may call the complex point (OP), meaning the involution (with a definite sense) of which O is the centre, and  $-OP^2$  the invariant ( $OQ.OQ' = -OP^2$ ), is a perfectly definite idea, and is a special case of von Staudt's representation of any complex point in the harmonic form  $(O \infty PP')$  or  $(O \infty P'P)$  with the initial point O.

Von Staudt's theory is purely projective, apart from the discussion of improper casts. The Cartesian theory is bound to deal with metrical quantities, such as distance and angle, and simply because these notions are derivative, it offers a field of research of a more complicated character. It may be asserted with some confidence that any real extension of von Staudt's theory will be of a metrical kind, and that, if it is worth anything, it will be applicable to three dimensions (or more) as well as to two.

G. B. MATHEWS.

P.S.—Since the above was written, I have had time to reflect further upon Prof. Hatton's book, and have read Prof. G. H. Hardy's review of it in a recent number of the *Mathematical Gazette*. I do not wholly agree with Prof. Hardy's attitude, because I still think that there are geometrical notions not reducible to arithmetic—still less to formal logic. But I do agree with him that Prof. Hatton's book has no theoretical value, and, disagreeable as it is, I think it is my duty to say so, especially as I have been informed that another reviewer has praised the book in absurdly exaggerated terms.

G. B. M.

### Motion Study and the Manual Worker.

*Motion Study for the Handicapped.* By Frank B. Gilbreth and Dr. Lillian Moller Gilbreth. (Efficiency Books.) Pp. xvi+165. (London: George Routledge and Sons, Ltd., 1920.) Price 8s. 6d. net.

THE work of Mr. Frank B. Gilbreth upon applied motion study and fatigue study is well known, and the present volume describes various extensions and additions to his previously recorded

methods, especially with the intention of assisting men who are handicapped by the loss of a limb or of their eyesight. In Mr. Gilbreth's latest scheme the manual worker whose movements are being studied has a small electric light attached to the hand or other working member of the body, and thereby the path of the motions made can be determined in detail if a series of photographs is taken by kinematograph. Other photographs are taken with a stereoscopic camera, and by this means the path of the motion in three dimensions is ascertained. It is then possible to construct wire models showing exactly the path of a given motion, and such models are found to be very useful for instruction purposes. Series of models are exhibited at the Smithsonian Institution, Washington, and elsewhere, so that skilled mechanics are able to see for themselves what are considered to be the best methods of performing certain motions, and to determine if they themselves fall short of the ideal.

Again, Mr. Gilbreth represents on diagrams, termed "simultaneous-motion cycle charts," the results of his studies on micro-motion. Such charts, when read downwards, present in chronological sequence the various activities performed by any member of the body, the posture taken during the action, and the time consumed. If read across, the charts give a record of all the working members of the body at any one time, and they enable one to see which parts of the body are working most and which are being delayed. It is maintained that this chart system enables the workmen to visualise their efforts graphically, and thereby to lessen waste and increase efficiency.

The great ingenuity of Mr. Gilbreth's methods will be admitted by everyone, but it is more important for us to determine their practical value. Mr. Gilbreth photographs champions playing baseball, champion typists, skilled surgeons when operating, in addition to skilled tradesmen, and he believes that the skill shown is in every case based on one common set of fundamental principles, the principles of economy of effort and rhythm of motion. The application of this hypothesis to practical ends is, however, very far distant. The concrete instances quoted of the employment of micro-motion study in actual practice are very few and not very striking, but doubtless it will take a good deal of time before they can be adequately tested and applied.

The portion of the book devoted specially to the handicapped describes several useful methods, though it strikes the uninitiated that they could have been evolved equally well without elaborate micro-motion study and motion-cycle charts. The one-armed typist is supplied with a typewriter

which has a magazine of paper lasting him a week, and he is enabled to type four copies at once by means of ribbons instead of carbon paper. The blind man is trained by visualisation, and is taught to use a cross-sectioned visualising board, on which the tools and equipment he is using are placed at fixed points. Thereby great waste of time and effort is saved. The importance of finding work that cripples can do, and of teaching them to do the work, is insisted on. Not only have the war cripples to be considered, but also the very numerous workers crippled as the result of industrial accidents.

H. M. V.

### Our Bookshelf.

*Engrais. Amendements Produits anticryptogamiques et Insecticides.* Par Dr. E. Demoussy. Pp. xi+297. Paris and Liège: Ch. Béranger, 1919. Price 15 francs.

DR. DEMOUSSY'S manual on the analysis of fertilisers is written for the trained chemist; it is founded on the methods laid down in 1897 by the Comité des stations agronomiques, but unofficial methods in use in the principal French laboratories are also described. After a short introduction on the laws regulating the sale of fertilisers, the author deals in the first two chapters with the collection of samples and their qualitative examination. The following four chapters treat of the determination of nitrogen, phosphoric acid, potash, and manganese, the arrangement being according to the substance to be determined, and not the material in which it is found. The methods are for the most part well known in this country, and call for only a few remarks. The longest section is that devoted to nitrogen. The official method for nitrates is that of Schloesing, and no mention is made of the zinc-copper couple, while for organic nitrogen the Kjeldahl and soda-lime processes are both recommended. The latter has fallen into almost complete disuse in this country, and probably few chemists here would agree with the opinion that it is the more economical in time when many samples are to be examined. Where a purely chemical analysis would be of little value, as in the case of dried blood, drawings of the materials as seen under the microscope are given. The value of these would have been greatly increased if the magnification had been stated. Under the head of potash no reference is made to flue-dust; in this case the official methods would have to be slightly modified to ensure complete removal of silicic acid.

The second and third parts of the book deal with materials such as lime and with fungicides and insecticides. Tables for the calculation of results are added, and the appendix contains the French laws and regulations dealing with the sale of fertilisers.

The book is well arranged and clearly written, and its value is added to by notes on the form in which the various materials are put upon the

market and the adulterations to which they are liable. It should prove very useful in analytical laboratories in this country as well as in France.

DONALD J. MATTHEWS.

*Flora of Jamaica: Containing Descriptions of the Flowering Plants known from the Island.* By William Fawcett and Dr. Alfred Barton Rendle. Vol. iv., *Dicotyledons: Families Leguminosae to Callitrichaceae*. Pp. xv+369. (London: British Museum (Natural History), 1920.) Price 25s.

THE fourth volume of this admirable tropical flora has lately appeared, and contains the Dicotyledons from Leguminosae to Callitrichaceae (on the Englerian system). It maintains the high standard of its predecessors, and shows a great advance upon some well-known tropical floras in being illustrated by excellent text figures, and not by a series of separate plates, which are usually troublesome to consult. The index is also convenient in being only a single list of both scientific and popular names and synonyms. Turning to the contents of the book, which have been worked up with much care and after consultation of all the older authors and collections, an interesting feature that may be noticed is the extraordinary generic similarity of the flora to that of other islands, even at immense distances from Jamaica. In the Leguminosae, for example, the first family in the volume, 118 Jamaica species, or 80 per cent., belong to genera that also occur in Ceylon, 74 per cent. to genera occurring in Formosa, and even in the case of so far distant an island as New Caledonia 63 per cent. of the Jamaica species belong to common genera. It is clear that the islands on the whole contain the older genera, which have been able to reach them. Of the Jamaica genera of Leguminosae 70 per cent. are cosmopolitan, and only 14 per cent. are confined to the New World. Again, one notices that the proportion of endemic species is small in Leguminosae, and larger in Euphorbiaceae and some of the other families, just as in other floras. It would appear a promising piece of work to make a careful statistical study of numbers and proportions of endemics in many countries, for it evidently follows definite, if perhaps recondit, laws.

*Butter and Cheese.* By C. W. Walker Tisdale and Jean Jones. (Pitman's Common Commodities and Industries.) Pp. ix+142. (London: Sir Isaac Pitman and Sons, Ltd., n.d.) Price 2s. 6d. net.

THE writers of this book have succeeded in giving to the general reader a very good account of the essential facts in connection with the dairying industry. As was to be expected, it was necessary to treat the subject on what are generally termed popular lines, but certain of the chapters are written in a particularly clear manner and with full regard to the essential technical points. Not only the chief branches of the dairy industry—cheese-making and butter-making—are dealt with, but also the production of milk, the methods of analysis, and the judging of dairy produce are

touched upon. In connection with the production of milk it would have been useful to include a short account of the practice of milk-recording, for the general reader has but little idea of the system and the benefits it confers.

The methods employed in separating cream and preparing it for churning are fully dealt with, and the chief machinery, such as the separator, the cream ripener, the regenerative heater, and the pasteuriser are described.

Cheese-making is dealt with by taking Cheddar cheese as a type, and the principles and practice are fully explained, as are also the essential points in the maturing and marketing of the produce.

Notes on judging cheese and also butter are given, and should prove helpful, whilst attention is directed to the advantages which have followed the control of butter in Denmark and cheese in New Zealand. The reproach still to be heard that a lot of home produce is not of the quality that might reasonably be expected is probably warranted, but a great deal is being done to teach proper methods, and an improvement in quality may be expected throughout the country in the near future.

*Elgie's Weather Book: For the General Reader.*

By Joseph H. Elgie. Pp. xii + 251. (London: The Wireless Press, Ltd., 1920.) Price 5s. net.

This work is essentially for the uninitiated in weather study. The author presupposes no technical knowledge, and has throughout avoided mathematics and formulæ. A rough survey is taken of elementary meteorology in a way which must commend itself to all who take an interest in ordinary weather changes. In the opening sentences the author appeals to boy or man; he might also as well appeal to the other sex, who are now taking a keen interest in all branches of science.

The book is divided into fifteen chapters, which separate the subject into well-recognised divisions. A weather vocabulary is given at the end which the reader will find helpful, and in this, as well as in the general text, the latest official and recognised publications have been consulted, which is an immense advantage, as meteorology at present is making rapid strides in its advance.

Weather and health are doubtless intimately associated, and in this respect reference is made to the close relationship between rainfall and diphtheria, as shown by Sir Arthur Newsholme, the disease varying inversely with the amount of rain. There are few points in the book with which a meteorologist could find fault, and the author certainly imparts a large amount of useful knowledge.

*Selected Studies in Elementary Physics: A Handbook for the Wireless Student and Amateur.*

By E. Blake. Pp. viii + 176. (London: The Wireless Press, Ltd., 1920.) Price 5s.

We have here something of a short cut to knowledge which occupies a peculiar position in scientific literature. Addressed to those already

familiar with the phenomena of wireless telegraphy, it assumes some knowledge of electrical matters on the part of the reader, a little mathematics, but an almost complete ignorance of the physical and chemical properties of matter. We do not say that this attitude is necessarily unsound, as there must be many "amateurs" who have tried to run in pursuit of electrical subjects before they could walk, and it is praiseworthy to endeavour to teach them to walk by a quick method, as they are not likely to possess the time or the temperament to plod through more laborious courses. Granted, then, that there is a justification for presenting the elements of physics and chemistry in such a severely compressed form, the author displays skill in dealing with his difficult task, although there are some inconsistencies in the degree of knowledge that he assumes his reader to possess. We like, among other things, the way in which the author encourages the student to think in vectors early in his career, and to keep continually in mind the dimensions of the quantities that he is considering. If the reader is enabled, by taking advantage of the guidance offered, to form scientific habits of thought which he would not have acquired otherwise, the book will be a success.

*The Coolidge Tube: Its Scientific Applications.*

*Medical and Industrial.* By H. Pilon. Authorised translation. Pp. v + 95. (London: Bailière, Tindall, and Cox, 1920.) Price 7s. 6d. net.

M. PILON has not been so careful in selecting a translator for his little book on the Coolidge tube as he was in the original material. The French version was excellent, both from the practical point of view and the judicious selection of data bearing upon recent developments in radiography. Curiously enough, passages which in the original present no difficulty to the reader now lack that clearness which any translator should carefully preserve. We select a paragraph which explains the first figure in the text: "This rising part, denoted by  $e$ , is on account of the electrons, by traversing from one electrode to the other under the influence of a large potential difference, acquiring such a speed that on encountering gas molecules, they split up. . . ." Again, on p. 17, in describing the radiator type of tube, we read: "The limiting power it is capable of bearing oscillates between 500 and 600 watts."

We notice that the letterpress of many of the diagrams remains in the French language. The developments of the Coolidge tube and the uses to which it may be put will doubtless necessitate a further edition by M. Pilon, and we trust that he will then give the English edition more careful consideration.

*Techno-Chemical Receipt Book.* Compiled and edited by W. T. Brant and Dr. W. H. Wahl. Pp. xxxiii + 516. (London: Hodder and Stoughton, Ltd., 1919.) Price 15s. net.

This book contains a very large number of recipes covering an amazing field. As might be expected,

many of these are of questionable value, either on account of the methods having been replaced by more up-to-date processes or because the materials specified, which were by-products of long-vanished industries, cannot now be obtained. Apart from this defect, which is inherent in all books of this type, there is no doubt that the present volume will be of great service to workers in laboratories as well as to those engaged in industry. The authors state that "the materials have been principally derived from German technical literature, which is especially rich in receipts and processes which are to be relied on." From the impossible nature of several of the processes, one might have guessed this: British workers are familiar with the "reliable" character of some German specifications.

*Photography and its Applications.* By William Gamble. (Pitman's Common Commodities and Industries.) Pp. xii+132. (London: Sir Isaac Pitman and Sons, Ltd., n.d.) Price 2s. 6d. net.

MR. GAMBLE, having had a lifelong experience in connection with technical photographic processes and their applications, speaks with authority on these matters. But the very limited scope afforded by so small a volume as this, and the innumerable applications that have to be dealt with, give him only a poor opportunity of presenting the subject to his readers. The short summary often passes into a mere catalogue of operations, and this into a mere dictionary-like mention. A little more care might well have been bestowed on the revision of the text. Working instructions are not given. We can recommend the book to those who wish to get in a small compass a general, but superficial, knowledge of the character of photography and its applications.

*The Chemists' Year Book, 1920.* Edited by F. W. Attack, assisted by L. Whinyates. Vol. i., pp. vi+422; vol. ii., pp. vii-viii+423-1136. (London and Manchester: Sherratt and Hughes, 1920.)

SUCCESSING editions of this handy laboratory manual are increasingly useful. The present volumes supply the need formerly satisfied by the "Chemiker Kalender"; English chemists have now no necessity to go outside their own country for such books. A valuable feature of "The Chemists' Year Book" is the series of articles written by specialists, such as that on "Alkaloids" by Dr. E. Hope. The tables and numerical data are very complete.

*Ions, Electrons, and Ionising Radiations.* By Dr. J. A. Crowther. Pp. xii+276. (London: Edward Arnold, 1919.) Price 12s. 6d. net.

THE subjects dealt with include gaseous conduction, thermionic emission, photo-electricity, X-rays, radium rays, and the electron theory. The treatment involves a knowledge of elementary mathematics, and the work forms a useful appendix to the ordinary text-book of physics. A clear and very readable account is given of the "quantum" theory of radiation.

NO. 2650, VOL. 105]

## Letters to the Editor.

[The Editor does not hold himself responsible for opinions expressed by his correspondents. Neither can he undertake to return, or to correspond with the writers of, rejected manuscripts intended for this or any other part of NATURE. No notice is taken of anonymous communications.]

### University Grants.

THE article on university grants in NATURE of August 5 is opportune, and does not overstate the gravity of the situation. The proposed recurrent half-million is welcome, but quite inadequate. The annual grant to the universities of the United Kingdom should be at least three millions.

We have been rigidly economical in our expenditure. There is no question of the value of the work which has been done. Everyone agrees that vigorous and well-found universities are indispensable to the national welfare, but they are hampered at nearly every point by insufficiency of income. Large numbers of their teachers are very seriously underpaid. Many departments are undermanned. Advanced studies and research are lamentably curtailed. Libraries are stinted of necessary books.

Before prices rose the universities had not the financial resources which their work required. Since the change in the value of money their position has become critical; some of them are threatened with disaster. In Leeds we have done everything in our power to raise salaries in order to meet the increased cost of living. The emergency was so grave that we decided to run a great risk. We have incurred obligations which will entail an annual deficit of 25,000. Even this expenditure falls far short of what should be incurred if the high standard of university teaching is to be maintained permanently. It will be impossible for us to continue the present rate of expenditure unless large new grants are forthcoming. In the absence of further aid from the Government I see nothing for it but the abandonment of work which is now well done, indispensable, and nationally advantageous. We need an additional income of about 60,000 a year in order to maintain the supply of teachers of the right type. The annual grant from the Government to the universities of the United Kingdom should be three times as large as what is given this year. M. E. SADLER.

The University, Leeds, August 9.

### The Carrying Power of Spores and Plant-Life in Deep Gaves.

MY sister and I observed a similar growth of vegetation to that which Mr. Lough. Pendred describes in the Cheddar Caves in NATURE of August 5, p. 709. We were on a knapsack-walking tour together in the Hartz Mountains in 1900, and saw this effect in the beautiful, great, deep Rübeldan Caves. These were then lit up by both oil and electric lamps placed, as in the Cheddar Caves, in recesses or on the floor so as to illuminate the stalactites and bone remains. We were told that the ex-Kaiser had ordered the electric illumination, not being content with the previous oil lamps, but both kinds of lighting were still there.

It was very noticeable that the vegetation spread out fan-like in front of the electric lamps to a much greater extent than behind them, or than near the oil lamps, and yet the electricity must have been, at that date, of fairly recent supply. It is true that the



oil lamps are more likely to have had an indefinite position, as they must be handled to fill, but they had probably been much longer close to the situations in which we saw them. The less vegetative growth round them and the shadow effect behind the electric lamps would seem to show that it was the shorter light-waves which were requisite for this plant-life rather than contact-warmth or longer heat and reddish light.

With regard to the transport of the spores to the depths of the caves, some experiments by Profs. Zeleny and McKeenan are of interest. At the Winnipeg meeting of the British Association in 1909 they read a paper, followed by a discussion, on experimental verifications of Stokes's law for the fall of spherical bodies in a viscous fluid. They deduced a discrepancy between theory and experiment which would seriously affect the cloud estimate of gaseous ionisation. A fuller paper and further experiments were published in *Physikalische Zeitschrift* for February, 1910, in which they showed that while a cloud of minute smooth paraffin spheres or mercury droplets obeyed Stokes's law, yet similar experiments with the spores of *Lycopodium*, *Polyttricum*, and *Lycopodium* (all nearly spherical) gave only about half the terminal velocities required by mathematical theory. In NATURE of January 6, 1910, I offered an explanation of the apparent discrepancy shown by their results. By using a large-aperture microscopic objective with oblique illumination and spectrum-sifted blue solar light, the spores can be seen, just within the limits of visibility, to be coated with a mass of very fine hairs more than a radius in length. Substituting in Stokes's formula for the terminal velocity

$$v = \frac{2ga^2d}{9\mu},$$

where  $a$  is the radius,  $\mu$  the air viscosity, and  $d$  the density of the spores, the effective diameter comes out to be just double that of the measured diameter as seen in an ordinary microscope. This increase of effective diameter is what should be expected if a mass of air be entangled with the spore, or a tail of eddies formed. Hence the physical measurement of the terminal velocity of fall confirms the microscopic observation of the hirsute coating in all the three sets of cases where spores were used. The spores are enabled to be wafted great distances, therefore, much as are the seeds of a dandelion. No Brownian motion or rotation was observed, and this also suggests the coating of hairs. Since the spore-walls are not absolutely spheres or smooth in the sense that surface tension makes the droplets, some Brownian motion would have been expected if the external air molecules could strike directly on the spore-wall. The air entangled in the *chevaux de frise* of hairs will, however, soften down the average result of individual impacts of external air molecules by making the effect slower, and therefore the resultant average smoother.

Yet another indication of this coating of long hairs is the difficulty of wetting *Lycopodium* dust until it has lain on the water long enough to get water-logged, viz. long enough, probably, for the entangled air to be dissolved out. While the air is so entangled the effective density is more nearly one-eighth than a little above unity as measured by Profs. Zeleny and McKeenan.

That this hairy coating provides these spores with a special mechanism which enables them to be carried great distances, is only to make them resemble many other wind-borne fruits, and the fact is therefore likely from general considerations.

The method of verifying a difficult, almost ultra-microscopic, observation in botany by measuring the terminal velocity, as of a small falling body in a viscous fluid, is perhaps not common.

EDITH A. STONEY.

King's College for Women, London.

### Curious Formation of Ice.

IN NATURE of December 12, 1912, was published a letter wherein I described a curious formation of ice in the hope that some of your readers would be able to explain the cause, but there was no reply. After five years the formation occurred again in similar circumstances, and I submit a partial explanation which occurred to me on seeing this second example of the phenomenon. The ice was again formed on water in a rough hole or pond (about 2 ft. by 1 ft.) in the garden in clay soil. It was observed at 3.30 p.m. on January 13, 1918. The "dark, sinuous lines" in this case were about  $\frac{1}{4}$  in. wide, and again ran "about parallel to the major axis" of the small pond. These dark lines were again due to the ridges of ice on the under-side of the ice covering the water, but were closer together than before, being about  $\frac{1}{2}$  in. apart. The cross-section of the ridges was again of "dovetail" shape, the attachment being at the smaller end of the "dovetail."

The partial explanation appears to be as follows: A uniform layer of ice about  $\frac{1}{4}$  in. thick forms over the whole surface of the water. The water slowly leaks out of the pond. The ice sags in the middle, keeping in contact with the water over its central area, but, owing to the support of the sides of the pond, the edges do not sag, and an air-space forms under the ice round its margin. The vertical cross-section of this air-space is a long, narrow triangle lying on one long side (the free surface of the water); the under-side of the ice forms the other long side, and the mud-bank of the pond the short side. At night, or at any other time when the temperature again falls below freezing point, the water at the margin (where the ice and surface of the water meet at an acute angle) freezes to the slab of ice and forms a ridge on the under-side of the ice. The water leaking slowly from the pond all the while would help the formation of the ridge. The next day, or when the temperature is again slightly above freezing, the water, continuing to leak away, allows a further slight sagging of the ice and the enlargement of the air-space, thus giving the space between the ridges of ice. The next freezing forms the second ridge, and so on.

This explanation appears to account for the ridges, their spacing, and their being roughly parallel to the major axis of the pond, but it does not account for the beautifully sharp, regular, and symmetrical formation of the cross-section of the ridges. One expects an asymmetrical cross-section instead of the symmetrical "dovetail." It has been suggested to me that the "dovetail" shape is due to the ridge being partly melted (where it is joined to the top slab of ice) during the period when the temperature is above freezing by the comparatively warm top surface of the water. This seems to be a possible explanation if the cross-section of the ridge when first formed is rectangular.

I hope that with this as a basis someone will be able to complete or modify the explanation of the curious formation of ice observed.

ALFRED S. E. ACKERMANN.

25 Victoria Street, Westminster, London,  
S.W.1, August 3.

### Bees and the Scarlet-Runner Bean.

DARWIN directed attention to the slight asymmetry in the petal growth of the scarlet-runner bean, *Phaseolus multiflorus*, that offered advantage to the bee for more easily reaching the nectar on that side of the flower where fertilisation would be helped by the visiting insect. I remember some years ago many times satisfactorily confirming the recorded fact by observation, but this year I am surprised to note quite a different practice in respect to insect visits to these flowers.

The humble-bees follow the habit they have long acquired in rifling the tubular flower of the jasmine of its honey: that of gnawing a hole near the base of the corolla, through which the proboscis can reach and extract the nectar. A similar plan is now adopted with the flower of the scarlet-runner bean. The bee no longer dives into the more open side of the bloom, where it would brush against the protruding anthers and stigma in an endeavour to reach the nectaries at their base, but on alighting moves immediately to underneath the blossom and, if not already done, gnaws through the calyx and sheath of filaments close to the nectaries, which are then easily reached and emptied. The honey-bees follow, and this season I have observed no instance of an insect attempting to reach the honey in the way the development of the flower suggests as that of reciprocal advantage.

The asymmetry of the bloom is due to the peculiarly coiled shape that the carina or keel part of the papilionaceous corolla develops. This causes the stamens and pistil to take a spiral form as they grow through and protrude together from the extremity of the enveloping carina, and exposes them between the more separated left wing and standard petals.

Though perfectly adapted to self-fertilisation, the flower, by the change of habit of the bees, would appear to lose the occasional advantage of cross-pollination, and the injury done by the gnawing of the bloom apparently causes a diminution in the amount of pollen formed and a quicker fading and falling of the bloom, with the probable consequence of fewer pods "setting." HARFORD J. LOWE.

The Museum, Torquay.

### The Condition of Kent's Cavern.

SINCE a recent visit to Kent's Cavern I have been wondering if it would be possible for something to be done by which any important finds that may be made there could be brought to the notice of those interested in ancient man. The cave now seems to be one of the sights of Torquay which any curious visitor can see, just as he visits the caves elsewhere when on a holiday. There is a well-informed man who shows the sights to visitors, and he stated to a party, of which I was one, that quite recently a jaw of a human being had been found, and that this was in the possession of a local collector. A human tooth has also been found. It seems highly desirable that the jaw should be examined by a competent authority. During the famous excavations which were made some years since a jaw was found, but this was examined and described only a year or two ago; and although Prof. Keith thought that it represented the Neanderthal type in this country, I believe Dr. Duckworth pronounced that it did not differ from modern races. If this further jaw were examined the question might be settled, and it would be of great interest if it were found that, after all, the race was actually represented in this country.

EDWARD A. MARTIN.

285 Holmesdale Road, South Norwood, S.E.25,

July 29.

NO. 2650, VOL. 105]

### Calculation of Vapour Densities.

WHEN determining vapour densities I believe that many, if not most, experimenters go through three processes, viz.: (1) Correct the observed volume to that at N.T.P.; (2) find the mass of hydrogen which would occupy this latter volume; and (3) divide this mass of hydrogen into that of the substance used, whence density  $d$  on the hydrogen standard is found.

Now if we evaluate the constant  $R$  in the gas equation  $pV=RT$ , using mm. of mercury-column as units of pressure  $p$ , and taking  $v$  as the gram-molecule in litres—which on the oxygen standard at N.T.P. is 22.4 litres—we get the figure 62.36.

Then, for finding density, the equation becomes

$$d = \frac{mRT}{2pv}$$

where  $m$  is the mass in grams and  $v$  is in litres.

To quote an example: 0.5 gram of iodine expelled 50 c.c. of air at 17° C. and 750 mm. from V. Meyer's apparatus. Was the temperature to which the iodine had been subjected high enough to cause dissociation?

This problem, if done by the "three processes," takes some time, and gives  $d=119.6$ , which now requires to be multiplied by 1.008 if we wish to compare it with published figures for atomic weights ( $119.6 \times 1.008 = 120.56$ ).

Using the single equation given above,

$$d = \frac{0.5 \times 62.36 \times 290}{2 \times 750 \times 0.05} = 120.5.$$

The answer to the problem is evident. Slight dissociation had occurred, since  $d$  for  $I_2$  demands 126.9.

I venture on these remarks because  $R$  is seldom, if ever, given in the above-mentioned units. It is expressed usually in such units as are suitable for solving energy problems. This number, 62.36, is an "equator" of the four steps which themselves, no doubt, are valuable from an educational point of view. Readers of NATURE who are engaged in science teaching may find the "equator" of some service.

REGINALD G. DURRANT.

Rosetree, Marlborough, July 31.

### Use of Sumner Lines in Navigation.

CAPT. TIZARD's reference to my book entitled "The Sumner Line," etc. (NATURE, July 1, vol. cv., p. 552), contains an error which should be corrected. His statement regarding what he calls the zenith point, "which spot is named by Mr. Comstock the sub-polar point," seems to imply that I have introduced a new name not approved in the criticism that follows. In fact, I have nowhere used the obnoxious term "sub-polar point," but have employed in this connection a well-known phrase, "the sub-solar point," for which I can claim no authorship. See Young, "General Astronomy," 1868 edition; Muir, "Navigation," 1918, *et al.* G. C. COMSTOCK.

Washburn Observatory, University of Wisconsin, Madison, July 20.

I REGRET that I inadvertently wrote "sub-polar" for "sub-solar" in my remarks on Prof. G. C. Comstock's book on Sumner lines, but this lapse makes no difference really to the statement that the proper description should be zenith point, and not sub-solar point (see p. vi of preface and pp. 2, 3, 5, etc.). Sub-solar refers to the sun only, and does not necessarily include sub-stellar or sub-lunar, but zenith point is common to all.

T. H. TIZARD.

23 Geneva Road, Kingston-on-Thames,

August 5.

## The Research Department, Woolwich.<sup>1</sup>

By SIR ROBERT ROBERTSON, K.B.E., F.R.S.

### II.

#### *Metallurgical Branch.*

THE metallurgical branch of the Research Department had been established for some years before the war, the staff consisting of four metallurgists. As work increased, additions became imperative, and before the armistice the scientific staff numbered thirty-seven, of whom a number were women. At the end of 1916 the branch removed into a new building 120 ft. long and 55 ft. wide, divided into laboratories well equipped for mechanical testing of all kinds, chemical analysis, microscopy and photomicrography, experimental heat-treatment, the thermal study of alloys, and other branches of physical metallurgy. Figs. 4 and 5 show two of these laboratories. The machine shops of the Department, on which metallurgical work made great demands, were much extended and improved.

During the war the metallurgical branch was mainly occupied with a great variety of problems connected with the metallic materials of warlike stores used by the Navy, Army, and Air Force. The work was carried out in close association with the Ordnance Committee and other Departments concerned. It is possible to mention here only a very few of the specific problems attacked.

Before the war the manufacture of gun forgings was in the hands of a few armament firms of long experience, but with the great increase in output which took place from 1915 onwards a wider source of supply was drawn upon. The heat-treatment applied was not always the most suitable, and sometimes caused serious irregularity of properties throughout the forgings. Much was done to define the temperature limits appropriate to the different steels employed and to secure their application, thus eliminating those weaker tubes which were so frequently found among those which failed by stretching, choke, or expansion. The inspection tests were improved, especially in the determination of the yield point, a matter of great importance in a highly stressed structure such as a gun.

The extreme brittleness of some gun forgings put forward for test directed attention to the occurrence of "temper-brittleness" in nickel-chromium steel, and made investigation an urgent

necessity. Slow cooling in the furnace after tempering was identified as the main cause of this form of brittleness, which is detected by the notched-bar impact test, and was accordingly forbidden by specification. Examination of samples representative of forgings in current supply made at the beginning of 1916 and at the end of 1918 showed that the notched-bar impact figure of the average nickel-chromium steel forging had very greatly improved, with no detriment to the other mechanical properties. The study of the notched-bar test was continued in association with the British Engineering Standards Committee, and much knowledge was gained as to its significance and conditions of application.

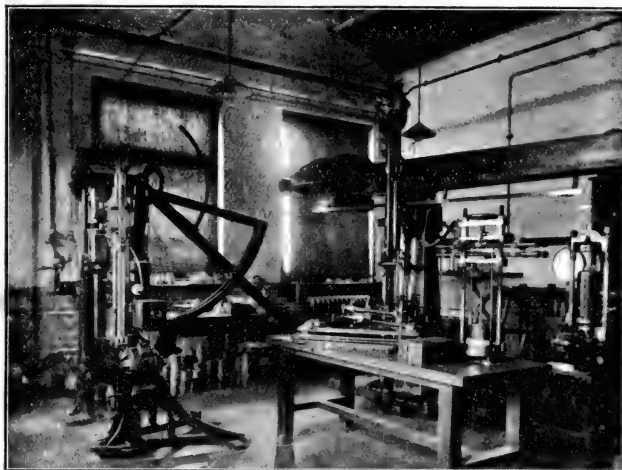

FIG. 4.—Portion of mechanical testing laboratory.

Much time has been given to the study of the elastic properties of steels and of the effect of overstrain and recovery, a subject of importance in connection with the strength of guns and their construction by methods involving the use of internal pressure.

Erosion, wear, and the development and extension of cracks in the bore have been studied in rifle and machine-gun barrels, as well as in guns. Many questions were solved in connection with the design and manufacture of bullet envelopes and the cores of armour-piercing bullets.

A method of applying the Brinell hardness test for the individual testing of H.E. shells which for one reason or another were in question as to their strength was developed, and resulted in the successful utilisation of very large numbers of shells which might otherwise have been rejected.

The numerous components of ammunition and

<sup>1</sup> Continued from p. 712.

fuzes were the subject of many investigations. As an example may be mentioned the hammer of the No. 106 fuze. This was liable to failure at a time of great output until the causes of difficulty were ascertained and sound methods of manufacture established. The introduction of a simple form of heat-treatment rendered possible the use of a rapid and economical stamping method which greatly assisted supply.

An investigation carried out upon brass small arm cartridge cases gave very complete information connecting the behaviour of the case in the rifle with its properties, and especially with its hardness. The hardness is chiefly dependent on the degree of cold-work received in the final drawing operation, and manufacturers were assisted by information as to the requisite hardness at different parts of the case and the dimensions of the necessary tools for producing it. The measure-

central core of unsound material, in brass rod used for fuzes led to an extended study of the extrusion process, in which the flow of the hot brass is liable to form internal defects in a remarkable and characteristic way. A method of controlling the plastic flow to produce entirely sound rod has been devised.

The necessities of the war demanded that first consideration should be given to the solution of immediate practical problems. The use of substitutes and alternative methods of manufacture when supplies ran short, the easing of specifications to increase output with safety, the adaptation and introduction of inspection tests to meet changing conditions, the examination of enemy material, the tracing of causes of failure and the discovery and application of remedies, provided a large field for investigation. Work on the fundamental properties of metals and alloys, which is so necessary if research in applied metallurgy is to continue to be fruitful, was, however, continued throughout the war, and is now being further developed.

#### *Radiological Branch.*

In the beginning of 1916 the question of the penetration of metals by X-rays was first considered by the Research Department. After experiments with various types of apparatus under different conditions, it was found possible to penetrate a block of steel half an inch in thickness and show internal flaws. The Department at once realised the possibilities involved in this new use of X-rays as applied to Service requirements, and took steps with the best apparatus available to evolve a technique for applying the new method as widely as possible, not only for detecting flaws in steel, but also for the examination of various articles, such as unknown enemy ammunition, where for reasons of safety it was desirable to know the internal construction before breaking down. X-rays were also applied to many Service stores for the purpose of indicating defective assembly, and for discovering faults such as blow-holes and internal flaws in metals.

As research progressed it became apparent that in order to obtain the best results the whole subject of radiology needed careful study so that its methods might be modified and adapted to this new use. More powerful tubes and high-power electrical machinery were essential, and the photographic side of the subject required special treatment. A general scheme of research on the subject of radiology as applied to the examination of Service materials was consequently undertaken,

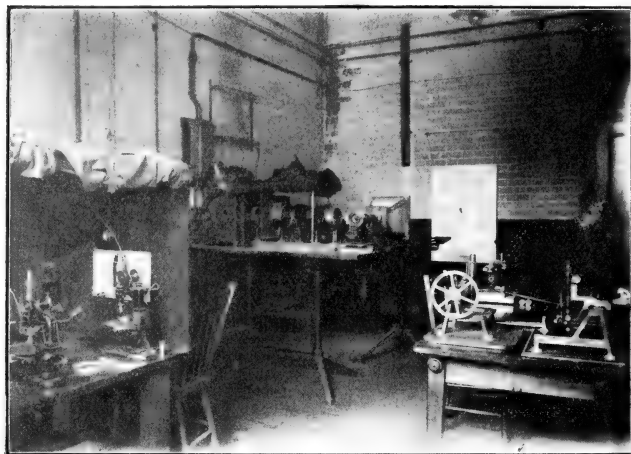

FIG. 5.—View in microscope room.

ments to ensure exact control of the hardness have been made possible by the use of a small machine designed in the Research Department shortly before the war for the determination of the hardness of very thin specimens. In this machine, which has proved useful in many unexpected ways, the Brinell test may be made on samples one-hundredth of an inch or even less in thickness, with balls as small as 0.8 mm. in diameter.

A thorough investigation of the phenomenon of "season-cracking" in brass and its prevention by low-temperature annealing has had a useful application in the removal of internal stress from cartridge cases.

Methods of casting brass ingots have been much improved. The long, narrow moulds formerly employed for ingots to be used in the manufacture of rod were productive of troublesome defects in the finished article.

The occurrence of the "extrusion defect," a

and this included the construction, in the Department, of special apparatus and high-tension electrical machinery; research was also undertaken on such associated subjects as the detection of feeble radiation and the measurement of its intensity.

Certain progress has been made, with the result that X-rays are being used to a much greater extent as research proceeds. X-ray examination of welds is the only method by which their soundness can be demonstrated, and it is now possible to penetrate more than  $2\frac{1}{2}$  in. of steel to show internal flaws. Fig. 6 shows part of one installation in the Research Department for the examination of materials.

#### *Proof and Experimental Branch.*

All guns are tested to a pressure in excess of their working pressures, and the ballistics of all lots of propellants are ascertained, by firing into sand butts. Carriages, recuperators, and many small stores are also similarly proved before acceptance.

Velocities are measured by means of Boulangé chronographs, and pressures by means of copper crushers in piston gauges. Flat-headed shot are used, to keep the penetration into the sand butts as low as possible.

Experimental firing, which principally consists in the determination of the weights of propellant necessary to give specified ballistics under various conditions, is also undertaken, and for this purpose the proof butts staff work in collaboration with the internal ballistic branch, by which the preliminary calculations are made.

Considerable expansion of *personnel* and *matériel* was necessary during the war to cope with the vast amount of proof and experiments. At the armistice the staff had increased to nearly ten times its pre-war figure, and included a number of women, who were most efficiently performing their trying duties on the firing batteries.

#### *Internal Ballistic Branch.*

Starting with a staff of two in the early part of the war, the branch numbered at the armistice more than twenty members, who dealt with all problems relating to the internal ballistics of propellants and the internal design of guns for all the Services. Newer and more powerful apparatus has been devised for determining the burning characteristics of explosives, and a great improvement has taken place in methods of analysing data. This is especially noticeable as regards the ballistic design of ordnance. The old system of calculation in use prior to the war was based on trial and error, and involved a series of laborious and lengthy operations. It had the added disadvantage of restricting the calculator to working out this result with one definite set of initial conditions only, and consequently no certain predictions could be made as to whether the best combination of charge weight, propellant size, chamber capacity, etc., had been employed.

It was thus frequently found that the finished gun was not suitable for the original purpose in

view. Research into the thermodynamical properties of propellants led to the construction of a more accurate theory on which to base design, and, apart from the economy effected in the labour of calculation, it became possible to select with considerable accuracy the best and most economical combination for any ballistic requirements. Also by an application of the calculus of variations the calculator is now enabled to predict with considerable accuracy the probable deviation in the ballistics from round to round, a valuable criterion of the practical utility of a design.

The application of this new theory effected considerable changes in design. For example, it was found that large reductions could be effected in the chamber capacities of several guns, with

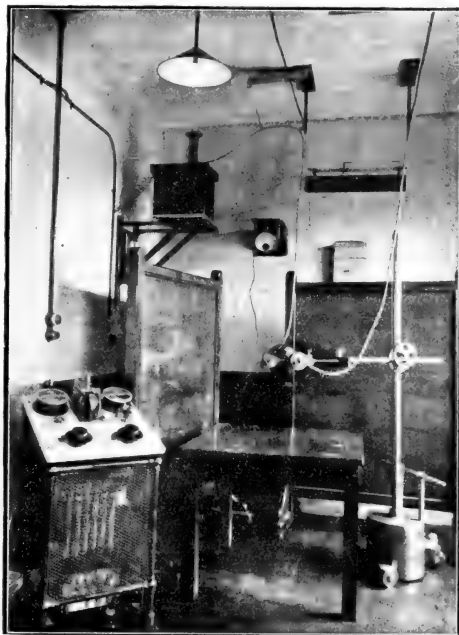

FIG. 6.—Portion of radiological laboratory.

corresponding reductions in the charge weights, without affecting the ballistics. This modification had the result of materially increasing the life of the guns, and the reduction in charge weight effected an appreciable economy in the financial cost of each round, a serious consideration in view of the magnitude of the scale on which operations were conducted.

Since the armistice the ballistic branch has been to a large extent occupied in digesting and interpreting the data amassed during the war, the results being published in the form of R.D. Reports.

A programme has been drawn up for future research, and good progress is being made in all branches of the science and its applications.

### The Romance of Bird Life.

MR. ARTHUR BROOK has made a welcome addition to the "British Birds" Photographic Series; he deals skilfully with the buzzard at home, and gives us twelve fine pictures.<sup>1</sup> During the last three or four years the buzzard has increased markedly in central Wales. It builds upon trees and in cliffs, or even amongst heather and rushes, and an inaccessible nest is

of the mountain ash. The cock did all the hunting, usually bringing his booty to the hen, who sat on a knoll near the nest. She carried the food to the young ones in her beak or talons. Occasionally the cock brought the food to the nest himself. The hen decorated the nest daily with fresh leaves, and she also brought tufts of mountain grass on which the young ones cleaned

their beaks. One day the booty included four young wild ducks, about two days old, and one of these was swallowed whole. If food is scarce the stronger of the two young buzzards will kill its weaker companion. The observer saw the young birds practising flight and playing with the food. He captured one that flew off too soon, and replaced it in the nest, whence in the afternoon of the same day it took wing successfully. The buzzard is said to be a coward, but when the cock bird discovered Mr. Brook leaving the "hide" it showed great courage, making disconcerting swoops at a high velocity, and following him closely for quite two miles.

With an inexpensive little Kodak, and often in bad weather conditions, Miss Hilda Terras has managed to give us a score of very presentable and interesting pictures of various events in the history of a cuckoo's egg in a hedge-sparrow's nest.<sup>2</sup> She had this good luck, however, that the cuckoo was obliging enough to put the egg in question into a nest almost on the doorstep of the observer's home. Only a true amateur—we use the word very discriminatingly—could have such luck. The hedge-sparrow made for the prospecting cuckoo like a little demon; nesting birds have a highly developed sense of "territory," or is there more—of homestead? The cuckoo persisted; there was a cessation of hostilities; at an urgent moment circumstances were opportune; the cuckoo flew on to the hedge

about 2 ft. from the nest, and looked about in a nervous, cunning way. "I could almost swear it was saying to itself anxiously, 'Are they looking? No—thank goodness, I've done them at last.'" And then, without any hesitation, it hopped straight into the hedge and disappeared from view. For about

<sup>2</sup> "The Story of a Cuckoo's Egg." Told and pictured by Hilda Terras. Pp. 95. (London: The Swarthmore Press, Ltd., n.d.) Price 6s. net.



FIG. 1.—The hen buzzard alighting at the nest. From "The Buzzard at Home."

the exception rather than the rule. The one studied by Mr. Brook was on a cliff, where with some difficulty a hiding-place was built for the observer. There were two young birds about a week old, and when observations began the nest contained several mice, one frog, one mole, half a dozen castings, and a quantity of fresh leaves

<sup>1</sup> "The Buzzard at Home." By Arthur Brook. ("British Birds" Photographic Series.) Pp. 15+12 plates. (London: Witherby and Co., 1920.) Price 3s. 6d. net.

a minute it was there; then it came out and flew away. Burning with curiosity, I hurried into the garden, and, eagerly parting the branches of the hedge, looked into the nest—and lo and behold, there, lying in Henrietta's dear little cup-shaped, softly lined cradle, I saw the cuckoo's egg! One of my sisters had watched the whole affair with me, and once more we were amazed at the positively uncanny sagacity of the bird. The whole thing seemed so extraordinarily intelligent and so mean."

The observer noticed that the cuckoo had not her egg in her bill, and concluded that it was in its mouth out of sight. But might not the cuckoo lay the egg in the nest? The hedge-sparrow laid four eggs, and when the young cuckoo was hatched the usual tragedy occurred. "For the first two days his shiny naked little body was dark fawny-pink in colour, but by the fourth day he had gone almost black, and his eyes, covered over with blue-black skin, looked disproportionately large. From the moment that his eyes opened he showed signs of surprising viciousness whenever I put my hand anywhere near the nest." When the young cuckoo was a fortnight old, more than filling the nest, the foster-mother was seen brooding, "uncomfortably crouched on top of his broad and ample back. It was rather like a pigeon trying to brood a hen." Whenever either of the foster-parents approached, the young cuckoo made a "strange little tinkling noise, . . . just like a tiny tinkling silver bell." The menu consisted of grubs, daddy-long-legs, butterflies, caterpillars, and small insects, and the number collected and consumed in a day was amazing. The indefatigable foster-parents continued to feed the cuckoo for more than a week after it had left the nest.

Miss Terras tells her story in a very attractive way. We do not know whether she has done this by instinct or by art, but we know we have



FIG. 2.—Hedge-sparrow feeding a young cuckoo. From "The Story of a Cuckoo's Egg."

had a most delightful hour. We recommend the book very strongly to young people and to those who would renew their youth.

## Helium: Its Production and Uses.<sup>1</sup>

By PROF. J. C. McLENNAN, F.R.S.

IN 1868 Janssen (*Compt. rend.*, 1868, vol. lxvii., p. 838) directed attention to the existence of certain lines hitherto unobserved in the solar spectrum, which we now know are given by the element helium. In the same year Frankland and Lockyer<sup>2</sup> (*Proc. Roy. Soc.*, 1868, vol. xvii., p. 91), from their observations on these spectral lines, were led to announce the existence of an

element in the sun which up to that time had not been found on the earth. To this element they gave the name "helium."

In 1882 the discovery was made by Palmieri (*Gazzetta*, 1882, vol. xii., p. 556) that the helium spectrum could be obtained from rocks and lavas taken from Vesuvius.

In the United States of America, Hillebrand in 1890 (*Bull. U.S. Geol. Survey*, 1890, No. 78, p. 43) succeeded in obtaining a quantity of gas

<sup>1</sup> From a lecture delivered before the Chemical Society on June 17.

<sup>2</sup> See *NATURE* for May 20, p. 361.

from the mineral uraninite, which from chemical and spectroscopic tests he concluded was nitrogen. This gas, we now know, was, in fact, helium.

Finally, in 1895, Sir William Ramsay (*Chem. News*, 1895, vol. lxxi., p. 151) discovered that a gas could be obtained from the mineral cleveite. This gas he purified, and, on examining its spectrum, he found it to be the long-sought-for element helium. From 1895 up to the present, investigation has shown that helium is widely diffused throughout the earth. It can be obtained from many types of rocks, minerals, and earths, and it is present in varying amounts in practically all natural gases and spring waters. It is present, too, in the atmosphere of the earth to the extent of about four parts in one million by volume.

The gases from some springs in France have been shown to contain as much as 5 per cent. of helium. In the Western States of America, especially in Texas, natural gases exist which contain from 1 to 2 per cent. of helium, but within the British Empire no natural gases which have been examined show a helium content as high as 0.5 per cent.

Until the spring of 1918 not more than 3 or 4 cubic metres of helium had, in the aggregate, been collected, and its market price, though variable, was about 300l. per cubic foot.

The principal characteristics of helium are:

(1) Its extreme lightness. It is only twice as heavy as hydrogen, the lightest element as yet isolated.

(2) Its absolute inertness. All attempts to effect combinations of helium and the rare gases, neon, argon, krypton, and xenon, as well, with other elements have as yet failed.

(3) Its close approximation to an ideal or perfect gas. It is monatomic, and is liquefiable at a temperature below that of liquid hydrogen. By causing liquid helium to evaporate in a vacuum, Onnes (*Proc. K. Akad. Wetensch. Amsterdam*, 1915, vol. xviii., p. 493) has succeeded in reaching a temperature within  $1^{\circ}$  or  $2^{\circ}$  of the absolute zero.

(4) Its low sparking potential. Electric discharges can be passed through helium more easily than through most other gases.

No element has had a more romantic history than helium, and none is of greater interest to men of science than is this gas at the present time. Its formation as a disintegration product of the radio-active elements, and the identity of the nuclei of helium atoms with  $\alpha$ -rays, give it a unique position among the elements.

Intense interest has been aroused by Sir Ernest Rutherford's recent discovery that in the nuclei of helium atoms in the form of  $\alpha$ -rays we have a powerful and effective agent for disintegrating and simplifying the nuclei of atoms generally. This discovery points the way to still further progress. In the past helium has been considered a rare and precious gas. To-day it is being produced in large quantities, and in view of the proposal now being put forward to use this gas in place of hydrogen as a filling for airships, one is apt

to consider it to be not so precious as heretofore. It may be, however, that such vast and vitally important directions will suddenly be opened up in which helium can be utilised that the conservation of the gas, while it is still available to us, will become a matter of the first importance.

Shortly after the commencement of the war in 1914, it became evident that if helium were available in sufficient quantities to replace hydrogen in naval and military airships, losses in life and equipment would be very greatly lessened.

The fact that helium is both non-inflammable and non-explosive, and possesses 92 per cent. of the lifting power of hydrogen, makes it a most suitable filling for airship envelopes. By the use of helium the engines of airships can be placed within the envelope if desired. A further advantage possessed by helium over hydrogen is that the buoyancy may be increased or decreased at will by heating or cooling the gas by electric or other means, which fact may possibly lead to considerable modifications in the technique of airship manoeuvring and navigation. Moreover, the loss of gas from diffusion through the envelope is less with helium than with hydrogen to the extent of about 30 per cent.

Although there are indications that proposals had been put forward during the war by men of science in Allied and enemy countries, as well as in the British Empire, regarding the development of supplies of helium for aeronautical purposes, it should be stated that the movement that led up to the investigation which it was my privilege to undertake was initiated by Sir Richard Threlfall. The existence in America of supplies of natural gas containing helium in varying amounts was known to him and others, and preliminary calculations as to the cost of production, transportation, etc., which he made led him to believe that there was substantial ground for thinking that helium could be obtained in large quantities at a cost which would not be prohibitive.

Sir Richard's proposals were laid before the Board of Invention and Research of the British Admiralty, and in the autumn of 1915 the author was asked by that Board to determine the helium content of the supplies of natural gas in Canada, and later on of those within the Empire, to carry out a series of experiments on a semi-commercial scale with the helium supplies which were available, and also to work out all technical details in connection with the production of helium in quantity, as well as those relating to the re-purification, on a large scale, of such supplies as might be delivered and become contaminated with air in service. The present paper aims at giving a brief account of this investigation.

#### *Composition of the Natural Gases Investigated.*

In commencing the investigation, a survey was made of all the natural gases available in larger or smaller quantities within the Empire with the view of ascertaining their helium content. Natural gases from Ontario and Alberta, Canada, were found to be the richest in helium, and these



sources, it was found, could supply from 10,000,000 to 12,000,000 cubic feet of helium per year. The following is a summary of the results obtained from the analyses of a number of the gases investigated. They include, it will be seen, a few samples from outside the Empire. For a complete account of this part of the investigation, the reader is referred to Bulletin No. 31 of the Mines Branch, Department of Mines, Canada, 1920.

(a) *Ontario Gases.*—The analysis made by Profs. Ellis, Bain, and Ardagh (Report of Bureau of Mines of Ontario, 1914) of the natural gases supplied to the experimental station, initially set up at Hamilton, Ontario (Blackheath System), is as follows:—

Methane	...	...	...	80 per cent.
Ethane	...	...	12	"
Nitrogen	...	...	8	"

It was found, however, on operating with this gas that the percentage assigned to methane really included a considerable proportion of gasoline, pentane, and butane as well. The helium content of the gas was found to be 0.34 per cent.

(b) *Alberta Gases.*—Gas taken from the mains leading from the Bow Island supply to Calgary was found to be quite free from the heavier hydrocarbons. At times it contained slight amounts of water vapour and occasionally a trace of carbon dioxide as well. Its approximate composition is given under I.

	I.	II.
Helium	0.33 per cent.	0.36 per cent.
Methane	87.6 "	91.6 "
Ethane	0.9 "	1.9 "
Nitrogen	11.2 "	6.14 "
Carbon dioxide	trace	trace
Water vapour	trace	trace

One well in particular, namely, No. 25 Barnwell, which has recently been driven, and now supplies gas to the system, was found to have a product of the composition II.

(c) *New Brunswick Gases.*—Some natural gases obtained from wells struck near Moncton, New Brunswick, Canada, were examined, and found to have the following composition:

Methane	...	...	80.0 per cent.
Ethane	...	...	7.2 "
Carbon dioxide	...	...	None "
Oxygen	...	...	None "
Nitrogen	...	...	12.8 per cent.
Helium	...	...	0.064 "

(d) *New Zealand Gases.*—A series of samples of the natural gases from the Hamner, Kotuka, Weber, Blairlogie, and Rotorua supplies in New Zealand was forwarded by Mr. J. S. McLaurin, Dominion Analyst of Wellington, New Zealand, for examination, but was found to have an insignificant helium content, the richest containing not more than 0.077 per cent.

(e) *Italian Gases. Pisa.*—A sample of the natural gas brought by pipe to the city of Pisa, NO. 2650, VOL. 105]

in Italy, was examined, and found to have the following composition:

Methane	...	...	80.0 per cent.
Ethane	...	...	4.0 "
Carbon dioxide	...	...	3.5 "
Nitrogen	...	...	11.9 "
Oxygen	...	...	0.6 "
Helium	...	...	None "

(f) *Miscellaneous Analyses.*—An analysis of the natural gas supply from Heathfield, Sussex, England, showed it to have a helium content of but 0.21 per cent. The gas from the King Spring, Bath, England, was found to contain 0.16 per cent. of helium, and analyses of natural gases obtained from Trinidad and from Peru showed their helium content to be negligible. An interesting observation was made in connection with natural gases obtained from Pitt Meadows, Fraser River Valley, and Pender Island, in the Gulf of Georgia, British Columbia. Both these gases were found to have a nitrogen content of more than 99 per cent.

*Preliminary Experiments.*

Soon after taking up the investigation, it was found, as mentioned above, that large supplies of helium were available in the natural gas fields of Southern Alberta, and that a small supply could be obtained from a gas field situated about twenty-five miles to the south-west of the city of Hamilton, in Ontario. In 1917 the Board of Invention and Research decided to endeavour to exploit these sources of supply, and operations were begun by setting up, as already stated, a small experimental station near the city of Hamilton.

At this station efforts were directed towards constructing a machine which would efficiently and economically separate out the helium from the other constituents present in the natural gas. The carrying out of this work expeditiously was made possible through the hearty co-operation of L'Air Liquide Société de Paris and Toronto, which generously lent, free of cost, a Claude oxygen column and the necessary auxiliary liquefying equipment for the investigation.

By making suitable additions to, and modifications in, this oxygen rectifying column, it was ascertained that the problem of separating, on a commercial scale, the helium which was present in this crude gas to the extent of only 0.33 per cent. was one capable of satisfactory solution. Early in 1918 it was found possible to raise the percentage of helium in the gas to 5.0 by passing it through the special rectifying column once only, and as the gas obtained in this way consisted of nitrogen and helium with a small percentage of methane, it became therefore a comparatively simple matter to obtain helium of a high degree of purity. In one particular set of experiments on this final rectification, helium of 87 per cent. purity was obtained.

*Experimental Station at Calgary, Alberta.*

In order to operate on the natural gas of the Bow Island system in Southern Alberta, an experi-

mental station was established at Calgary in the autumn of 1918, and, starting with the knowledge acquired through the preliminary operations at Hamilton, rapid progress was made in developing a rectification and purifying column, together with the requisite auxiliary equipment, which would efficiently and cheaply separate the helium from the natural gas.

#### *Development of the Rectification Column.*

In proceeding to develop an equipment for separating the helium from the other constituents of natural gas, three lines of attack appeared to be open, namely, (a) by producing the refrigeration necessary to liquefy all the gases except the helium by the cold obtainable from the natural gas itself, (b) by using external refrigeration entirely, such as that obtainable with ammonia, carbon dioxide, liquid air, liquid nitrogen, etc., and (c) by combining methods (a) and (b).

The last method had been successfully used for the production of helium by the naval authorities of the United States in the Texas field, but from the information supplied it did not appear that this process could be considered to be an economical one.

The preliminary experiments at Hamilton, Ontario, made it abundantly clear that method (a) was very promising and likely to be both efficient and economical. This method was therefore adopted. It was evident from the start that to produce an efficient method the main difficulty to overcome would be the securing of a proper balance between the heat exchangers, the liquefier, the vaporisers, and the rectification portions of the machine. A machine was therefore designed, constructed, and supplied with piping which possessed great flexibility, and, in its general scheme, followed the lines of the Claude oxygen-producing column. It is unnecessary to go into details regarding the operation of this machine. It will suffice to say that it was tested under a variety of conditions. Notes were taken of the temperatures reached at different points in the machine under equilibrium conditions when the gas was passed through it in various ways. As a result of this procedure, it was soon found what parts of the machine could be eliminated and what parts could be modified with advantage. When those changes were made which seemed desirable in the light of the experience gained, it was found that a machine had been evolved which would give highly satisfactory results.

In operating with this machine, it was found that helium of 87 to 90 per cent. purity could be regularly and continuously produced.

#### *Operations.*

The experimental machine just described was used continuously for a series of trial runs from December 1, 1919, to April 17, 1920. In making a run, about 500,000 cubic feet were passed through the machine, and from this amount upwards of 20,000 cubic feet of the gas, containing

5 to 6 per cent. of helium, were obtained. As this low-grade product was made it was stored in a large balloon, and the residual gas was passed back into the mains for use in the city of Calgary. The 5 to 6 per cent. product was compressed to from 20 to 30 atmospheres, and then passed through vaporisers. The amount of final product, of 87 to 90 per cent. purity, obtained in each run rose steadily in the course of the operations from about 300 cubic feet to more than 700 cubic feet per run. From this it will be seen that the efficiency obtained with each of the two operations was about 67 per cent. In special runs made under exceptionally good conditions a still higher efficiency was obtained. One of the curves given in Fig. 1 shows that the purity of the high-grade final product was steadily maintained in the series

#### HELIUM RUNS AT CALGARY

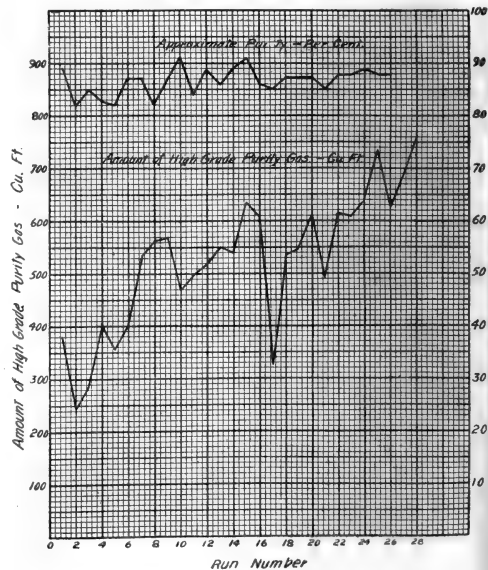

FIG. 1.

of runs, and the other curve exhibits the steady increase made in the production of helium of high-grade purity.

#### *High-grade Purification.*

When it was seen that the highest purity obtainable with the experimental machine under actual running conditions was about 90 per cent., steps were taken to design and construct an auxiliary piece of apparatus for raising the purity of the gas up to 99 per cent. or higher. This apparatus as constructed could be used, not only for obtaining a product of high purity at the works, but also for purifying helium which became contaminated with air by use in balloons in service. Through numerous delays experienced in obtaining delivery of tubing, liquefying equipment, etc.,

this purifying apparatus has not been given any more than a preliminary trial. From this, however, it is quite evident that it will prove satisfactory in operation. For the purpose of carrying out this scheme of high-grade purification, a liquid-air plant was installed by the University of Toronto. Motors and an electric current supply were furnished by the Hydro-Electric Commission of Ontario, and a special financial grant was made by the Honorary Advisory Council for Scientific and Industrial Research of Canada to supplement that made by the Admiralty and the Air Board of Great Britain.

#### *Final Design of Helium-extracting Apparatus.*

Every step in the production of high-grade helium has been carefully examined and tested. From the experience gained, we have been able to draw up specifications for a commercial plant which will enable one to treat the whole of the natural gas of the Bow Island supply in Alberta. The unit proposed will deal with about 1600 cubic metres or 56,500 cubic feet of gas per hour at normal pressure and temperature. At the altitude of Calgary, this would be equivalent to 62,200 cubic feet per hour. The machine would easily cope with 66,000 cubic feet per hour or 1100 cubic

feet per minute. Of these machines, six would deal with 9,500,000 cubic feet of gas per day, and would thus take about the average daily supply available from the field, as based on records of the average yearly consumption. In order to have sufficient machines to operate regularly to capacity, it would probably be advisable to have eight helium columns included in the plant.

The cost of a commercial plant suitable for treating the whole of the supply of the Alberta field would probably be less than 150,000. The amount of helium of upwards of 97 per cent. purity obtainable per year from the field would be about 10,500,000 cubic feet. This is based on the assumption of an efficiency of 80 per cent., which experience has shown is obtainable. As to operating costs, our experience has shown that, allowing for interest on the investment, a ten years' amortisation, salaries, supplies, and running charges, helium can be produced at the Alberta field for considerably less than 10s. per 1000 cubic feet. This sum does not, of course, include the cost of purchasing cylinders or of transporting them from and to the works. Neither does it include any compensation to the owners of the field for the supply of gas.

(To be continued.)

### Obituary.

PROF. JOHN PERRY, F.R.S.

THE death of Prof. John Perry on August 4, at the age of seventy, leaves a blank in our scientific circle which cannot well be filled. A man of original mind and original manner, a warm-hearted Protestant Irishman, impulsive and enthusiastic in whatever cause he might engage, simple-minded to a degree and a thorough-going optimist, one of the most delightful of companions, he was of the class of lovable men and popular accordingly; he will be much missed, particularly at meetings of the British Association, of which he had been the general treasurer of late years.

Perry was educated in Belfast, finally at Queen's College, where he came under Andrews, one of the ablest and most original men of his day; it was from Andrews that he imbibed his feeling for chemistry, unusual in the engineer and mathematician: at least, he learnt to appreciate the part played by the electrolyte in chemical interchanges—as he once told me, through having fused out the bottom of Andrews's platinum crucible by heating potash in it. Later he was an assistant to William Thomson (Lord Kelvin). Under the influence of two such men his genius could not but unfold.

Perry began his career at Clifton College. I first met him at Clifton, at a dinner, where, of course, he out-talked everyone: I can well recollect how he amused us and how he called Sir Walter Scott an upholsterer. He was always a voracious novel-reader and remembered what he

had read in an extraordinary way. On the occasion of the British Association visit to Winnipeg, he often astonished his travelling companions by his local knowledge, as he identified spot after spot with Fenimore Cooper's characters.

From Clifton, Perry went to Glasgow to assist Thomson, I imagine on Andrews's recommendation. In 1875 he went to Japan and was one of the band who gave the Japanese their first lessons in science—to be cast off when done with; like Ayrton and Divers, however, he was an ultra-enthusiastic Japanophile. In Japan he became associated with Ayrton and a constant flow of communications, mainly on electrical subjects, to the Royal and other societies was the consequence of the partnership. In those days what Ayrton and Perry did not know or do or claim to have done was not worth knowing, doing or claiming; no two men, in the exuberance of their youth, were ever better satisfied with themselves. They were in remarkable contrast: entirely diverse yet complementary natures, each cognisant and respectful of the other's special ability. Ayrton was the worldly, practical member of the firm, Perry the dreamer. Ayrton always had a sense of what was wanted and what would pay; he, I believe, usually set the problem; Perry worked out a solution, which Ayrton then criticised and referred back to Perry for development. In the same manner, I believe, he co-operated, during the war, with the mechanical genius of Sidney Brown—the husband of his niece—in the development of the gyrostatic compass.

The partnership with Ayrton was continued several years after their return to England in 1879. They were in the van of electrical progress, in some respects before their time—as in the case of Telpherage, which they developed in association with Fleeming Jenkin. Those were wonderful days: we were just learning to know and use electricity. A little later, Perry's house was often the scene of most stimulating debates, especially when Larmor and Lodge forgathered there with Fitzgerald, whom Perry adored.

Perry's best work was done at the Finsbury Technical College. Ayrton and I were called on to lay the foundations of the work of the City and Guilds Institute for the Advancement of Technical Education in October, 1879; we began in temporary quarters in Cowper Street, Finsbury. I found not only that plans were prepared for a separate chemical laboratory but also that steps had already been taken towards the erection of the building. I took exception to the scheme on the ground that more than a mere knowledge of chemistry would be required of the technical chemist of the future: that he must know something of the fundamentals of mathematics, of physics—especially electricity—and of engineering—drawing in particular. My view prevailed and we set to work to excogitate a practical programme and design a building. In 1871 we roped in Perry to our aid: our trio always fought like thieves over every detail but remained as one man throughout. The outcome was the present Finsbury Technical College and the original Finsbury scheme: I say "original" because our successors were never whole-hearted followers of our convictions and aspirations. This much I may assert as the last of the Finsbury Mohicans—we were in advance of our time and our fate has been the usual fate of pioneers and prophets. We cut the college adrift from all external examinations. We imposed an entrance examination on applicants. Not only was the course comprehensive but also the methods were special, practical and advisedly educative rather than informative; our students were young and their period of training was short but at its close, although they did not know a great deal, they had learnt to think for themselves and to do by themselves, so that they were mentally prepared to continue learning when left to their own devices. Now the college is to experience the fate of our scheme; it is said that it will be closed next year. When established it was the most original school in the country and it has been a remarkable success. We are a strange people: we seem never to know when we have hold of a good thing and cannot long maintain a consistent policy. In abandoning Finsbury the City and Guilds Institute signs its own death-warrant; but it has long been practically defunct, the men of imagination and outlook who founded it having bred no successors.

Perry did not leave Finsbury until 1896, when he became professor of mathematics and mechanics in the Royal College of Science, South Kensington. He had the advantage of being a

practical engineer by training; this, added to his mathematical genius and his intimate knowledge of electrical science, not forgetting his literary proclivities, made him a man of unusual breadth and sanity of outlook. No special scientific achievement is to be associated with his name; his real interest lay in the work of education and he will go down to fame as an original and constructive teacher who laid the foundation of a new era. He made mathematical teaching practical and taught many who could never have mastered the abstract subject to use such knowledge and ability as they had with effect. As examiner in mathematics to the Science and Art Department he exercised a wide and beneficent influence on the teaching of this subject. His methods were not everywhere popular, but this was mainly because of the special demands their practice made on the intelligence of the teacher. As he more than once remarked to me, few really understood him. Still, the written word remains: Perry has left much on record which will be of service to a future, more appreciative generation.

H. E. A.

PROF. PERRY'S love of research and restless spirit of inquiry have inspired the lives of innumerable students who came under his influence. Who can measure what the nation owes to Perry for the intellectual gifts he distributed so freely to so many men? Who can measure the boundaries to which his influence will reach through the lives and activities of his students? The man who inspires is in time forgotten, but those whom he stimulates inspire others, so that his influence increases as time goes on. An engineering work like a fine bridge can be seen of all, and the builder is applauded and rewarded. The scientific spirit is apprehended by few, and those who possess it and spend their lives in the true service of the nation by cherishing it and by passing it on to others are unknown and unrewarded by authority, but are held in respect and affection by those who receive from them what so few are able to give. Perry gave lavishly, and his students responded with enthusiastic affection. He ranged wide in the regions of science. In Japan he and his friend and colleague Ayrton experimented furiously. Paper after paper came red-hot from their intellectual forge until even Lord Kelvin said that the pole of scientific research had shifted to Japan.

Finsbury Technical College was founded to do something in technical education which had not been done before. Perry and his colleagues, Ayrton and Armstrong, launched the college. They made it a pioneer in technical education. They made it world-famous. Everything which these men did was new, unorthodox, stimulating, and vastly interesting to the keen young men who flocked from the workshop to the college to hear and often to help them. Perry was unorthodox of the unorthodox. He taught his students to mistrust authority and to try things out for themselves.

Perry will probably be chiefly remembered by engineers as the man who broke through the formal defences of mathematics and taught them mathematics through what they knew of machinery. His book on "Practical Mathematics," originating in his Finsbury course, has been translated into many languages, and many generations in many lands will therefore benefit from Perry's determination to teach his own students the fundamental truths of mathematics so well that they could use their knowledge as easily as they could use their mother tongue.

Perry continued his work as professor of mathematics and mechanics at the Royal College of Science, leaving Finsbury in 1896. In those days the professors at the Finsbury Technical College were expected to run an arduous day course, and in addition an evening course as well. His relief at the escape from this double duty was great. In more recent years he guided the fortunes of the British Association for the Advancement of Science as its general treasurer. Perry has done a great work, and his work will live after him.

W. E. D.

PROF. AUGUSTO RIGHI, FOR.MEM. R.S.

PROF. AUGUSTO RIGHI, who died suddenly on June 8 at seventy years of age, is said to have been appointed assistant to the professor of physics in the University of Bologna—his native city—at the age of twenty-one. In 1877 he was *Libero Docente*, and in 1880 was appointed ordinary professor at Padua, whence after a few years he returned to Bologna as head of the physics department.

Righi was a skilled experimenter and an industrious worker. His original investigations lay chiefly in the domain of electricity, magnetism, and light. One of his discoveries was the variation of the resistance of bismuth in a magnetic field, a phenomenon on which an instrument for measuring the intensity of a field has been based. He was led to this discovery by an examination of the Hall effect in different metals in the year 1883. His results were published in the *Journal de Physique* (2), 1883, p. 512, and in the *Comptes rendus*, vol. xcvi., p. 672, as well as in Italian; most fully in Bologna Acad. Sci. Mem., vol. v., 1883, pp. 103-26. An abstract was given in NATURE, vol. xxx., p. 569.

Righi's earliest papers appeared in 1873, and dealt with a variety of topics, many of them connected with electrostatic problems and voltaic electricity. One of the subjects on which at one time he laid stress was the dilatation of the glass or quartz of a Leyden jar, and of insulators in general, under electric stress—what he called "galvanic dilatation": see, for instance, *Comptes rendus*, vol. lxxxviii., 1879, p. 1262. He also examined the changes of length due to magnetisation, and discussed the phenomena of permanent steel magnets. About 1880 Righi began a long series of researches on electric discharge *in vacuo* and in air,

and pursued the subject in various forms to the end of his life. He was much interested in photoelectric effects, and contributed some new facts to the discharge of electrified bodies by ultra-violet light. He failed to discover electrons, but he knew that carriers of negative electricity were liberated, and took steps to observe their trajectory in a magnetic field, thus exhibiting the phenomenon as a variety of cathode rays. He also found that the discharge could be stopped by an electric charge of inverse sign, constant in density for a given metal.

Righi was keenly interested in the work of Hertz, and corresponded with the present writer on the subject of electric waves. A special form of Hertz oscillator, known as Righi's pattern, consisting of a couple of spheres with adjacent faces immersed in oil and charged at the back from two other spheres, was used by some people, and is depicted as a form appropriate to wireless telegraphy in Mr. Marconi's first patent, though the connection of the outer spheres to an elevated plate and to ground respectively—a plan efficiently introduced by Mr. Marconi for practical purposes—really converted the spherical oscillator into nothing but a series of spark gaps. It is understood that Mr. Marconi had visited Righi's laboratory and seen his experiments on Hertzian waves, but was not one of his students. Righi, in his correspondence, frequently expressed surprise at the novelty attributed to the invention in its very early days by Sir William Preece and other English officials.

In the Memoirs of the Academy of Sciences of the Institute of Bologna, Righi expounded many of the new discoveries as they were being made in physics—among others an excellent and semi-mathematical exposition of the Zeeman phenomenon (see vol. viii., ser. 5, pp. 59-90, December, 1899). He also wrote on the equations of Hertz and their solution, in vol. ix. of the Memoirs of the same Academy, pp. 3-28 (February, 1901); and, again, on the electromagnetic mass of electrons in vol. iii., ser. 6, pp. 71-84 (February, 1906). These papers show that though chiefly an experimental physicist, he had a sound grasp of general theory, and must have had considerable influence in making known the work of British and other physicists to his countrymen. A memoir on the theory of relativity was contributed by Righi to the Institute of Bologna so recently as April 18 last (vol. vii., ser. 7, pp. 70-82).

An experimental paper of Righi's on the possible existence of magnetic rays, dated May 17, 1908, vol. v., ser. 6, of the same Memoirs, pp. 95-150, deserves mention, because of the cathode ray inquiry there described and the speculation based upon it. The subject is continued in vol. vi., pp. 45-64, and in vol. x., pp. 79-103, also in vol. i., ser. 7, pp. 3-36, where results are described for many different gases. It is taken up again, after a discussion of the paths of electrons in magnetic fields, in vol. ii., ser. 7, pp. 11-41.

Righi describes further experiments in vol. iii.,

pp. 23-42, and he has a paper on ionisation in a magnetic field in vol. iv., ser. 7, pp. 27-44. His chief work, in which he summarises these and other results, is entitled "I fenomeni elettro-atomici sotto l'azione del magnetismo," a work which met with a very cordial reception among Italian physicists, who must, indeed, have been indebted to Righi's activity and clearness of exposition for much of their knowledge of contemporary physics.

Students adequately familiar with Italian—as the writer cannot claim to be—speak of Righi's writings as marked by extraordinary clearness and simplicity of style, so that they can be read by people of average culture, at least in their non-mathematical portions.

Numerous honours were conferred upon Righi, among others a 10,000 lira prize of the Accademia dei Lincei, and the Hughes medal of the Royal Society. The Royal Society also selected him as a foreign member, and he succeeded Lord Kelvin as foreign member of the Royal Academy of

Sciences at Upsala. In 1905 he was elected a Senator of the Italian Parliament.

By Righi's death Italy probably feels that she has lost her foremost physicist. He was anxious, up to the last, for information about every new discovery, and showed himself capable of appreciating results in many departments of physics. He was well known by reputation in this country as a thinker and worker of exceptional keenness and width of outlook. OLIVER LODGE.

A REUTER message from Stockholm announces the death, at seventy-seven years of age, of ADMIRAL A. L. PALANDER, who was in command of Baron Nordenskiöld's vessel, the *Vega*, which completed the navigation of the North-East passage from the Atlantic to the Pacific along the north coast of Asia (1878-79). Admiral Palander was an honorary corresponding member of the Royal Geographical Society and of many other scientific societies both in Sweden and abroad.

### Notes.

A MOVEMENT set on foot in the early part of last year for the founding of an institution or society the membership of which should be open to those particularly interested in problems connected with the fields of administration and organisation in relation to industrial enterprises was brought to a head at a public meeting held on April 26 last at the Central Hall, Westminster, by the appointment of a provisional organising committee which was instructed to prepare a draft constitution for such an institution, to be named the Institute of Industrial Administration. This committee presented its report, accompanied by a draft constitution embodying (1) a schedule of objects, (2) the conditions of membership, and (3) the form of government, at a public meeting held at the above-named hall on July 15. This draft constitution was, with slight amendments, adopted on the date last mentioned, and the first board of management, consisting of eighteen members representing a variety of industries, was elected on the same occasion. The objects of the institute as set out in the draft constitution are briefly as follows:—To promote the general advancement of knowledge relative to the principles of industrial administration and their applications; to facilitate the exchange of information and ideas regarding the principles and practice of industrial administration; to collect and publish information and proposals bearing on any aspect of industrial administration; and to co-operate with professional, industrial, or educational societies, organisations, or authorities in pursuance of these objects. The government of the institute is to be vested in an advisory council composed of honorary members and a board of management representing the various classes of membership of the institute. Mr. E. T. Elbourne was elected hon. secretary of the institute, the offices of which are temporarily located at 110 Victoria Street, Westminster, S.W.1.

THE U.S. National Research Council, with headquarters at Washington, has elected the following chairmen of its various divisions for the year beginning July 1, 1920:—Division of Foreign Relations: George E. Hale, director, Mount Wilson Observatory, Carnegie Institution of Washington. Government Division: Charles D. Walcott, secretary of the Smithsonian Institution and president of the National Academy of Sciences. Division of States Relations: John C. Merriam, professor of palaeontology, University of California, and president-elect of the Carnegie Institution of Washington. Division of Educational Relations: Vernon Kellogg, professor of entomology, Stanford University, and permanent secretary of the National Research Council. Division of Industrial Relations: Harrison E. Howe. Research Information Service: Robert M. Yerkes. Division of Physical Sciences: Augustus Trowbridge, professor of physics, Princeton University. Division of Engineering: Comfort A. Adams, Lawrence professor of engineering, Harvard University. Division of Chemistry and Chemical Technology: Frederick G. Cottrell, director of the Bureau of Mines. Division of Geology and Geography: E. B. Mathews, professor of mineralogy and petrography, Johns Hopkins University. Division of Medical Sciences: George W. McCoy, director of the U.S. Hygienic Laboratory since 1915. Division of Biology and Agriculture: C. E. McClung, professor of zoology, University of Pennsylvania. Division of Anthropology and Psychology: Clark Wissler, curator of anthropology, American Museum of Natural History, New York.

THE Department of Scientific and Industrial Research has established four Sub-Committees to assist the Radio Research Board in the investigation of certain problems in connection with the work of the Board. The constitution of the Board and its Sub-Committees is at present as follows:—*Radio Research Board*: Admiral of the Fleet Sir Henry B.

Jackson (chairman), Comdr. J. S. C. Salmond (representing the Admiralty), Lt.-Col. A. G. T. Cusins (representing the War Office), Wing Comdr. A. D. Warrington Morris (representing the Air Ministry), Mr. E. H. Shaughnessy (representing the General Post Office), Sir J. E. Petavel (presenting the National Physical Laboratory), Sir Ernest Rutherford, and Prof. J. S. E. Townsend. *Sub-Committee A on the Propagation of Wireless Waves*: Dr. E. H. Rayner (chairman), Prof. E. H. Barton, Major J. R. Erskine-Murray, Prof. H. M. MacDonald, and Prof. J. W. Nicholson. *Sub-Committee B on Atmospheric*: Col. H. G. Lyons (chairman), Mr. A. A. Campbell Swinton, Prof. S. Chapman, Major H. P. T. Lefroy, Mr. G. L. Taylor, Mr. R. A. Watson Watt, and Mr. C. T. R. Wilson. *Sub-Committee C on Directional Wireless*: Mr. F. E. Smith (chairman), Mr. M. P. Hinton, Capt. C. T. Hughes, and Capt. J. Robinson. *Sub-Committee D on Thermionic Valves*: Prof. O. W. Richardson (chairman), Mr. E. V. Appleton, Capt. S. Brydon, Capt. H. L. Crowther, Prof. C. L. Fortescue, Mr. B. Hodgson, Prof. F. Horton, Major A. G. Lee, Mr. H. Morris Airey, Mr. R. L. Smith-Rose, and Prof. R. Whiddington.

The following appointments have been made in connection with the Royal College of Physicians of London:—Dr. F. Parkes Weber, Mitchell lecturer, 1921; Dr. G. Graham, Goulstonian lecturer, 1921; Dr. T. Lewis, Oliver Sharpey lecturer, 1921; Dr. A. Whitfield, Lumleian lecturer, 1921; Dr. R. O. Moon, FitzPatrick lecturer, 1921; and Dr. G. M. Holmes, Croonian lecturer, 1922.

It was resolved in the House of Commons on August 9 to provide a sum not exceeding 100,000l. as a guarantee against loss resulting from the holding of a British Empire Exhibition in London next year. The grant is conditional on the provision of a further sum of 500,000l. by the promoters of the enterprise.

We learn from the *British Medical Journal* that the second International Congress of Comparative Pathology will be held at Rome in the spring of 1921 under the presidency of Prof. Perronico. Communications should be sent to the secretary, Prof. Mario Tevi Della Vida, Via Palermo 58, Roma.

With the view of popularising scientific knowledge in Spain, a weekly periodical bearing the title of *Ibérica* has recently made its appearance. The journal contains current notes on scientific matters in Spain and Latin-America, general notes, and abstracts of important foreign scientific papers written in a manner that will appeal to the popular reader of average education. Each number also includes a monograph or an instalment of a monograph on some popular scientific subject written by a leading authority. The contents conclude with a bibliography of current scientific literature and meteorological information. The weekly is published by the Observatorio del Ebro, Tortosa.

We are glad to see that the British Museum authorities have begun to issue additions, naturally under present conditions of publication in a less

attractive form, to the valuable series of Handbooks, such as those provided before the war for the Assyrian, Babylonian, Egyptian, and Ethnographic Galleries. The latest is an account by Sir E. A. Wallis Budge of the Egyptian "Book of the Dead." This is a vague title now commonly given to the first collection of funerary texts which the ancient Egyptian scribes composed for the benefit of the dead, consisting of spells and incantations, hymns and litanies, magical formulæ and names, words of power and prayers, which are found cut or painted on the walls of pyramids and tombs, and engraved on coffins, sarcophagi, and rolls of papyrus. The pamphlet, which is well supplied with illustrations, provides for the use of students and visitors to the galleries an admirable introduction to the study of the death rites and theories of the soul current among the ancient Egyptians.

Under the title of "The Medical History of Ishi," by Mr. Saxton T. Pope, the University of California has published in its American Archaeological and Ethnological Series a remarkable study of human pathology. The subject of the monograph, Ishi, was the last Yahi Indian, who was brought to the University Hospital after his capture in 1911, and died from tuberculosis in 1916. "We see him first as the gaunt, hunted wild man, his hair burnt short, his body lean and sinewy, but his legs strong and capable of great endurance. He suggests the coyote in this character." At first civilisation agreed with him, but then came a gradual change. "His energy waned. He no longer was keen to shoot at targets with a bow. His skin became darker." Then he contracted another cold and his malady increased. This monograph is supplied with full statistics of his case and excellent photographs and illustrations—most valuable for the study of the life-history of a Californian Indian, the last of his race.

A REMARKABLE stone bowl now deposited in the Museo Arqueológico, Madrid, is described in the July issue of *Man* by Mr. B. Glanvill Corney. It was obtained in 1775 at Tahiti by Máximo Rodríguez, a creole of Lima, and it was brought to that city in a Spanish ship-of-war, being finally sent to Spain in 1788. It is made of the hard, compact, black stone of which adze-blades and pestles for crushing taro and bread-fruit of the Society Islands were formed, and which was quarried only in the remote island called Maurua. It is not quite certain for what purpose this bowl was used. The local chiefs believe it to have been a sacred potion bowl, in which herbal draughts were prepared by trituration and infusion by the medico-sacerdotal functionaries. Others suppose that the function of the bowl was to receive viscera of victims sacrificed, and possibly it was used for some form of augury by inspection of the entrails of sacrificial victims. The bowl thus suggests interesting problems which, it may be hoped, further research will enable us to solve.

THE *Medical Record* for March 27 contains an interesting paper by Dr. C. B. Davenport on the influence of the male on the production of twins. It is well known that twins may be biovulate or

uniovulate, the latter type having a single chorion, and it is found that about 1 per cent. of all human births are plural births. But in the relatives of mothers who have repeated twins this proportion rises to 4.5 per cent., indicating the inheritance of twinning in the strain. Twinning is, however, almost equally frequent (4.2 per cent.) in the near relatives of the fathers of twins. The tendency to repetition of identical twins is even higher than when both types are considered together. Double ovulation is far commoner (frequency 5-10 per cent.) than twin births, and here the male factor comes in, for it has now to be recognised that human germ-cells frequently contain lethal factors which arrest development at an early stage, or may even prevent more than one egg being fertilised. In relation to this is the fact that highly fecund families more frequently have twins. Human beings thus possess the biovulate type of twinning found in carnivora, herbivora, and rodentia, and also the uniovulate type found in the armadillo, which regularly produces four young of the same sex at a birth by budding from the young embryo.

THAT the Philippine hawkbill turtle (*Eremochelys imbricata*) is in dire need of stringent protection is evident from the account of this species given in the *Philippine Journal of Science* (vol. xvi., No. 2) by Mr. E. H. Taylor, of the Bureau of Science, Manila. Practically all the Philippine tortoiseshell is brought into the market by the native fishermen, who are so eager to secure their prizes that they wait for days for the arrival of the female to lay her eggs on the beach. Often she is speared before a single egg is laid. Should they have patience enough to allow her to fill the "nest" the end is the same, for every egg is eaten. Obviously it will not be long before this source of revenue is lost for ever.

THE August number of *Conquest*, a magazine devoted to the popularisation of science, is a model of what such magazines should be, for not only are its contents designed to appeal to a wide circle of readers, but also every article is lucidly written and well illustrated. Taking subjects at random—for it would be difficult to make a deliberate choice—one may mention the essay by Mr. R. I. Pocock on the common animals of the sea-shore, that on wild white clover by Mr. J. J. Ward, and the article on the Davon micro-telescope by Mr. F. Talbot. Besides these are not less fascinating talks on the ships of the future by Mr. W. Horsnaill, on seaside meteorology by Mr. Joseph Elgie, and on the sands of the sea-shore by Mr. C. Carus Wilson.

THE attention of those who are interested in the campaign against rats may be directed to the second edition of Mr. M. A. C. Hinton's pamphlet (67 pp., 2 plates and 6 text-figures) which has been recently issued by the British Museum (Natural History). This work contains an excellent summary of the characters, habits, and economic importance of rats, and of the relation of rats to the spread of disease in man and animals. In this edition additional details are given on the rate of increase of rats, and refer-

ence is made to the occurrence in the rat of *Spirochaeta icterohaemorrhagiae*, the organism of spirochaetal jaundice (Weil's disease) in man. After emphasising the urgent need for action against the large rat population of Great Britain, Mr. Hinton gives a concise account of the chief repressive measures. Barium carbonate is recommended as the safest poison, mixed in the proportion of one part with eight parts of oatmeal, and made up with a little water into a stiff dough. Among other methods to which attention is directed are trapping, which should be continuous and systematic, and placing in the run-ways of the rats birdlime trays with an attractive bait in the centre—a method which has given good results in Liverpool, London, and elsewhere.

ITALIAN biologists are to be congratulated on their enterprise in founding, in difficult circumstances, a new biological publication, *Revista di Biologia*, which is published bimonthly in Rome, and is edited by Profs. Gustavo Brunelli and Osvaldo Polimanti. The review is to be devoted largely to the consideration of problems of general biological interest, but its pages are also open to record the results of researches in special subjects. Six fascicles, forming the first volume of 744 pages, have recently reached us. Prof. Brunelli contributes to the first fascicle a vigorous article on the place which science, and especially biology, should occupy in the national life of Italy. He points out that the future of Italy is essentially bound up with agriculture and problems of the land, and that in the economic development of the nation biology must therefore take a leading part. He pleads also for more attention to hydrobiology, and for a closer co-operation between medical practitioners and biologists—for instance, in anti-malarial measures and in social hygiene generally. Among the special articles two may be briefly referred to: the first by Prof. Pierantoni on physiological symbiosis, with special reference to the part played by symbiotic organisms in light-production in luminous organs, and the second by Prof. Enriques on the results of experiments in breeding blow-flies (*Calliphora erythrocephala*), in which he shows that while some of the pairings give rise to a high proportion of living offspring, other pairings produce larvæ about one-fourth of which, although kept under optimum conditions, cease to feed after two or three days and die. Prof. Enriques does not consider that the explanation of Morgan, in his important work on lethal factors in *Drosophila*, holds for *Calliphora*. The *Revista* will not only fulfil its object in stimulating and encouraging biological research in Italy, but will also afford workers in other countries a ready means of keeping in touch with the chief lines of research of Italian biologists, and we cordially wish it success.

DR. R. RUGGLES GATES has given (Proc. Roy. Soc. London, B, vol. xci., 1920, pp. 216-23) a preliminary account of the meiotic phenomena in the pollen mother-cells and tapetum of lettuce, in which several matters of general bearing on cytological conceptions and on problems of genetics are considered. The chromatin of the nuclei of the tapetal cells, particularly of the binucleate cells, exhibits the synaptic knot



and other appearances which have hitherto been observed only in spore mother-cells of plants and in the primary spermatocytes and oocytes of animals. In lettuce, therefore, there is the unusual condition of all transitions between tapetal and germinal cells. Dr. Gates's material also affords, in the earlier stages of formation of the diakinetid chromosomes, a good example of chiasmatty—the crossing-over of two members of a pair of chromosomes—which has not hitherto been definitely described in plants, though it is now well known in certain animals, e.g. in the fruit-fly, *Drosophila*, in which the phenomenon has been interpreted by Morgan and his collaborators as the probable basis of the crossing-over of factors. Another observation of much interest on the meiotic chromosomes of lettuce is the tendency for one or two pairs of the bivalent chromosomes to coalesce more or less completely on the equatorial plate of the heterotypic spindle. There is no evidence that such coalesced chromosome pairs pass over bodily to one pole of the spindle; rather they will both split in the usual way, but the manner of their previous coalescence will determine the nature of their distribution—whether, for instance, the paternal halves of each chromosome will go to the same pole or to opposite poles of the spindle. There is here a possible basis for the phenomena of partial coupling and repulsion, apart altogether from the crossing-over phenomena, which latter are based on relations between the two members of a pair of chromosomes in their earlier post-synaptic stages.

In vol. xvii., No. 4 (October-December, 1919), of the Bulletin of the Imperial Institute Mr. W. Bevan, Director of Agriculture in Cyprus, continues his account of the agricultural industries of the island. Among the more interesting products discussed by Mr. Bevan are fodders and feeding-stuffs (including the carob bean), essential oils and perfumes, oils and oilseeds, fibres (including cotton and silk), drugs, and tobacco. Certain minor agricultural industries are also described. The reports of recent investigations at the institute have reference to fibres from India, Africa, and the West Indies, the utilisation of New Zealand hemp-waste, Pappia seeds from South Africa as a source of oil, Cyprus castor-seed, and distillation trials with talh wood (*Acacia Seyal*) from the Sudan. The general articles include an account of the present position of Para rubber-seed as a source of oil and feeding-cake, in which it is pointed out that the possibility of exploitation very largely depends upon the cost of collecting the seed on the plantations. A further article deals with cassava as a source of industrial starch and alcohol. As usual, much useful information is recorded as notes and in the section devoted to recent progress in agriculture and the development of natural resources. We observe that H.R.H. the Prince of Wales has arranged for a selection of the presents and addresses received during his visit to Canada to be exhibited at the Imperial Institute. An index to vol. xvii. of the Bulletin is included in this part.

In many respects we pay too little attention to our West Indian Possessions. The present difficulties of

NO. 2650, VOL. 105]

communication hinder visits from our own men of science, and it is natural that those of the neighbouring United States should undertake tasks that we regretfully leave undone. Thus we learn from the Report of the American Museum of Natural History that towards the end of last year Mr. H. E. Anthony, who had previously secured many interesting mammalian remains from the caves of Cuba and Porto Rico, extended his researches to Jamaica, whence the skull of a marine mammal was the only example known. His hunt was successful, but the collections remain to be worked out. They are certain to throw light on the nature of former connection with the mainland. That we are not altogether idle may, however, be gathered from the fact that a collection of fossil sea-urchins from Antigua and Anguilla, made by Prof. J. W. Gregory some years ago, was reported on by Dr. J. Lambert, of Troyes, during the war, and is now being arranged in the geological department of the British Museum. That department has also been presented by Dr. C. T. Trechmann with an excellent dried specimen of the recent crinoid *Holopus*, rare because it grows under ledges of reef-rock and so escapes the dredge, inoperative because of its adaptation in form to that peculiar position. This individual comes from Barbados, on which island Dr. Trechmann has recently spent some months investigating the raised reefs and collecting their fossils. None the less, the West Indies still present a large field for research, and British labourers are all too few.

THE *Agricultural News* of May 29 has an article on camphor-growing in the British Empire, based on a contribution by Prof. P. Carmody, formerly Director of Agriculture in Trinidad, to the *Times Trade Supplement*. The chief source of commercial camphor is Formosa, and the Japanese monopoly has led to an enormous increase in price in recent years. Various, but so far not commercially successful, attempts have been made in camphor cultivation within the Empire, namely, in Ceylon, the Federated Malay States, Mauritius, and the West Indies; in some cases distillation tests have shown a satisfactory yield, but in Mauritius and the West Indies the prunings may yield only oil and no solid camphor. Experimenting in Trinidad, Prof. Carmody found that trees grown in the Botanic Garden made very poor growth, but when transplanted to better soil the growth was satisfactory, and a normal yield of solid camphor was obtained. It is suggested that, owing to their bushy, evergreen habit, camphor-trees might be used as a windbreak in cacao cultivation. The successful cultivation of camphor within the Empire is no longer doubtful if a few necessary precautions are adopted. Seeds or seedlings from trees that yield no solid camphor must not be used; stiff clay soil must be avoided; in good average soil not more than 300 trees to the acre should be grown; and a sufficient area should be cultivated for economical distillation. When the trees are four or five years old they can be clipped, and thereafter three or four times a year. The same journal directs attention to the development of other sources of camphor, namely, rosemary in Spain, species of *Artemisia*, and the swamp-bay (*Persea pubescens*) in California.

METEOROLOGICAL observations made at secondary stations in Netherlands East India have recently been published for 1917. Since the publication of the previous volume a well-equipped meteorological station has been started at the aerodrome at Sockamiskin. Cloud observations have been almost wholly discontinued, and sunshine records are substituted; the cloud estimations (0-10) are said not to be trustworthy—which is scarcely surprising, since it is stated that the lower half of the sky was not taken into account, and that density had its say. Sunshine observations are from Jordan recorders, but the Campbell-Stokes recorder would give results more comparable with European observations. In addition to the ordinary detailed observations of rainfall, tables under the heading of "cloud-bursts" are given practically for all stations, which show the individual instances of rainfall of 1 mm. and more per minute, the minimum duration being five minutes. At Batavia the maximum mean monthly air-pressure occurred in August, and the minimum in April. July was the warmest month and December the coldest. The mean relative humidity, saturation being expressed as 1000, ranged from 879 in February to 793 in August. The percentage of bright sunshine was greatest in August and least in January. By far the greatest amount of rain falls in the winter months, January being the wettest, whilst May and June are the driest months. Wind results are given at only a few stations, but the observations clearly indicate a diurnal range in direction and velocity. A more complete discussion of winds would be of value for aeronautics, whilst the movement and, if practicable, the height and speed of clouds would add much to a better knowledge of the upper air.

THE *Bulletin de la Société d'Encouragement pour l'Industrie Nationale* for March-April gives a full report of the work of M. Martial Entat on the destructive effect of light on certain materials such as textiles, dopes, and rubberised fabrics. It is difficult, if not impossible, in these climates to make quantitative measurements of the effect in the case of sunlight, and M. Entat accordingly used ultra-violet light from a mercury-vapour lamp in his experiments. He found that the mercury lamp was twenty times as effective as full sunlight in its destructive action on such materials. As is now well known, considerable protection may be afforded by the use of various dyes for absorbing the ultra-violet light. M. Entat's experiments indicate that the dyes commonly employed in aviation for protecting the fabric of aircraft have a "coefficient of protection" of from 50-75 per cent., the most efficient being the red dye from quinoline. A spectrographic measurement of the absorption of the ultra-violet light placed the various dyes in the same order as the tensile tests on the dye-protected fabrics which had been exposed to the rays. Experiments similar to those of M. Entat were carried out during the war at the Royal Aircraft Establishment at Farnborough. An account of the work was given by Dr. Aston to the Royal Aeronautical Society last year.

No. 4 of Abstracts of Papers in Scientific Transactions and Periodicals, published as a supplement to the minutes of the Proceedings of the Institution of Civil Engineers, contains a large number of brief abstracts taken from papers and periodicals published outside the United Kingdom. These are classified under the main headings of (1) measurement, measuring, and recording instruments; (2) engineering materials; (3) structures; (4) transformation, transmission, and distribution of energy; (5) mechanical processes, appliances, and apparatus; (6) specialised engineering practice; (7) economics, etc. There are several subdivisions to each of these main headings. It is not easy to produce abstracts which shall contain the information required and thus obviate the necessity for those interested having to consult the original papers; we note that these abstracts are satisfactory in this respect, and therefore provide a mine of information which we trust will be available to engineers who are outside the ranks of the Institution of Civil Engineers and would gladly purchase the Abstracts. The editing is somewhat loose occasionally; thus we note on p. 16 that an acceleration has been stated as "slightly more than 2 ft. per sec." A slip of this kind would have to pay a penalty at the institution examinations.

THE special requirements in dental radiography are met by the radiator dental type of Coolidge tube, obtainable from the British Thomson-Houston Co., Ltd. This embodies the original features of the radiator type of tube whereby a large portion of the heat generated is conducted away by a copper radiator, but, in addition, the new tube allows greater proximity of the anode to the part under exposure. The cathode-arm extends 2 in. from the bulb at right angles to the anode-arm; this method of construction secures the emission of the X-rays in a line with the axis of the anode. The cathode circuit is earthed, so that there is only one high-tension wire, which is connected to the part of the tube most remote from the subject under exposure; this allows a minimum distance between the dental film and the focal spot, with consequent reduction in the time of exposure. The tube is self-rectifying within the limits of its allowable energy output, and is designed for an input not exceeding 10 milliamperes at an alternative spark-gap of about 3 in. The tube being designed to run only under specified electrical conditions, the manipulations are reduced to a minimum, and the only variable left in the hands of the operator is the time for which the film is to be exposed. In dental radiography this attempt at standardisation and simplification of procedure is likely to meet with considerable success.

MR. A. THORBURN, whose sumptuous volumes, "British Birds" and "A Naturalist's Sketch Book," have been so well received, is bringing out through Messrs. Longmans and Co. a companion work entitled "British Mammals." It will be in two volumes and contain fifty plates in colour and many illustrations in black-and-white. Vol. i. is promised for the coming autumn, and vol. ii. for the spring of next year.

### Our Astronomical Column.

**AN INTERESTING METEORITE.**—Vol. Ivii. of the Proceedings of the United States National Museum contains an analysis by Mr. G. P. Merrill of a meteorite that was seen to fall at Cumberland Fells, Kentucky, on April 9, 1919. It is stated that if the object had not been seen to fall, its meteoric character would not have been suspected. It is a "meteoric breccia composed of fragments of two quite dissimilar stones." The lighter-coloured portion contained 55 per cent. silica, 39 per cent. magnesia, 3 per cent. ferrous oxide, with traces of some seventeen other compounds. The darker portion, which more closely resembles other analysed meteors, contains 42 per cent. silica, 9 per cent. ferrous oxide, 28 per cent. magnesia, 12 per cent. iron, etc. "Apparently the admixture of the two kinds of fragments took place prior to the evident compression."

The author conjectures that it is evidence of the destruction of some pre-existing planet, but the suggestion seems more reasonable that it is an earth-born meteor expelled in a mighty eruption in long-past ages. Sir Robert Ball was a strong advocate of the terrestrial origin of meteors, and it appears tenable in cases where the relative velocity is not very high. A lunar origin was suggested by Prof. Sampson; this also is preferable to the postulate of some purely hypothetical planet.

**THE UNION OBSERVATORY, JOHANNESBURG.**—Circular No. 47 of this observatory contains a search for proper motions by the blink method on two plates taken at Paris in 1887 and 1914. The region is R.A. 18h. 35m., N. decl.  $31^{\circ} 10'$ . The plates have already been measured at Paris, and the region is included in the Greenwich 1910 Catalogue, so the research was intended as a test of the comparative efficiency of the blink method. The result shows that it is undoubtedly the most rapid way of detecting all the displacements, but, of course, the method is purely differential, and absolute motions can be found only by using meridian observations of the reference stars on the plate. In the present case comparison with the Greenwich catalogue shows that the stellar background is moving  $3.8''$  per century towards  $113^{\circ}$ , so that the blink results are referred to an origin moving in this manner. It is found that each of the three methods of examining the region has revealed some motions not shown by the others, so that they all have their use. Mr. Innes gives the following summary of his results:—Two stars moving more than  $20''$  per century, eight between  $20''$  and  $10''$ , seven between  $10''$  and  $8''$ , twenty-seven between  $8''$  and  $6''$ , and forty-nine (probably incomplete) below  $6''$ .

**GALACTIC CONDENSATION.**—The results of an examination of stellar density at different galactic latitudes, derived from plates taken at Sydney, are given in Circular No. 47 of the Union Observatory, Johannesburg. The plates are fairly complete down to magnitude 15; there are very few of these faintest stars in the regions remote from the galaxy; the galactic condensation of the fainter stars is greater than that deduced at Groningen. Incidentally, Mr. Innes criticises Prof. Eddington's statement in "Stellar Movements" that the depth of the stellar system is about three times as great towards the galaxy as towards its poles, and also that the stellar density in the galactic regions is greater than in the polar ones. Mr. Innes shows that, granting, as he does, the latter statement, the ratio of depths becomes very much less than three to one; in other words, the stellar system is more spherical than previously stated.

### The British Empire Forestry Conference.

**T**HE Forestry Commission, constituted in November, 1919, has not been long in bringing about what promises to be one of the most important events in the history of forestry in the British Empire. We allude to the British Empire Forestry Conference which, with intervals for visits to certain selected forest areas in England and Scotland, held its sittings in London on July 7–22 under the chairmanship of Lord Lovat. The delegates included representatives from the United Kingdom, Australia, Canada, India, Newfoundland, New Zealand, South Africa, the Sudan, and most of the Crown Colonies. The main objects of the conference were to bring together such information as exists at present regarding the forest resources of the Empire, and to devise means of forming a more accurate estimate of these resources and of developing them to the utmost; to focus attention on the necessity for a more rational forest policy in the various parts of the Empire; to bring to light some of the more salient problems connected with technical forestry; and to consider certain important questions relating to forestry education and research.

No more opportune time could have been selected for such a conference. Of the many forcible lessons taught us by the Great War there are few which require to be taken more to heart than the lesson taught us in regard to the maintenance of our timber supplies. The view once held, that the timber resources of the Empire are inexhaustible, is no longer tenable, for we are already faced with a probable world-shortage of timber which will become more and more acute if steps are not taken to prevent reckless waste and to ensure that production keeps pace with exploitation. In the affairs of our Empire the scientific aspect of forestry has been too long relegated to the background, largely owing to misapprehension as to its true aims. For forestry, no less than agriculture, is an industry based on the productive capacity of the land, with this important difference: that whereas agricultural crops are harvested within a year, forest crops may take a century or more to mature. Hence in forestry, far more than in agriculture, the State must take a direct interest in the growing of the crops concerned, for the success of which continuity of management based on scientific principles is the keynote.

Among the most important proposals approved of by the conference was that relating to the formation of an Imperial Forestry Bureau to be located in London. This Bureau, constituted somewhat on the lines of the Imperial Mineral Resources Bureau, would act as a clearing-house of information on all subjects connected with forestry and forest products. It would undertake to collect, co-ordinate, and disseminate information on forest education, research, policy and administration, and the resources, utilisation, consumption, and requirements of timber and other forest products. In this way the Bureau cannot fail to prove a valuable link in forest matters between the various parts of the Empire.

Among the more important specific questions which it is hoped the Bureau will lose no time in taking up are the standardisation of technical terms used in forestry and the correct identification of timbers in commercial use, with the standardisation of their trade names so far as this is possible.

The question of forest research work was fully considered. The conference held that this work, for various reasons, is primarily the concern of the State. Speaking generally, forest research is divisible into two main branches: (i) that dealing with the grow-

ing of forest crops, and (2) that dealing with the utilisation of timber and other forest products. Each of these two main branches can be considered from two points of view, namely, the general and the local, the former being concerned with the principles and methods governing research work, and the latter with the application of principles to a limited range of conditions. General research may, consequently, be conducted at one centre for very wide areas, while local research must be conducted on the spot. Although the two main branches of research are intimately connected, from their nature they cannot always be conducted at the same institution; it is, however, impossible to lay down any hard-and-fast rule in the matter, and, provided adequate co-ordination is secured, there is no reason why the two branches of research may not be conducted successfully either together or apart, as circumstances may dictate. Most of the research problems of outstanding importance fall under the head of sylvicultural, statistical (that is, the collection and collation of data dealing with rate of growth and production), or technological. The conference recorded the opinion that in no part of the Empire is sufficient attention paid to the investigation of sylvicultural and statistical problems, considering their great importance in connection with the future maintenance and economic working of the forests; accordingly it recommended that each part of the Empire should include in its forest service at least one research officer, and that adequate funds should be placed at his disposal to ensure progress in these branches of research.

Specific proposals were made in respect of forest research work in different parts of the Empire, and it may be of interest to note the views of the conference in regard to the organisation of work in the United Kingdom. It was held that requirements would be met by the establishment of (1) a research institute to deal with problems connected with the growing of forest crops, and (2) a research organisation which should include a central institute to deal with problems connected with the utilisation of forest products. It was proposed that the latter should be governed by a research board composed of official and non-official members, the board being an executive body similar to the research boards established by the Department of Scientific and Industrial Research. Such a board, which would have definite sums allotted to it for research on forest products, would decide where any particular problem should be investigated, and distribute the funds at its disposal accordingly.

The question of forestry education in its various aspects was fully discussed, and although this question presented numerous difficulties the conference succeeded in clearing the ground to a considerable extent. In approaching this question sufficient discrimination is not always shown between the training of forest officers for service in different parts of the Empire and the training in forestry of owners and managers of private woodlands and others who do not desire to take the course of instruction required for the various forest services. In the United Kingdom the training of owners and managers of private woodlands is a matter of great importance in view of the large proportion of such woodlands existing in the British Isles. Such training, however, must be carried out on somewhat different lines from the training of forest officers for the various parts of the Empire. So far as concerns the latter, the conference held that one institution should be established in Britain for the training of forest officers for the United Kingdom and for those parts of the Empire which, for climatic or other reasons, may be unable

to establish such an institution of their own, or desire to send students to Britain for training. Students would be selected from graduates who have taken honours in science at any recognised university. An integral part of the work of the institution would be to arrange supplementary courses at suitable centres for students requiring special qualifications, and also special courses for forest officers from any part of the Empire, whether at the institution itself or at centres of training in other parts of the world. A department of research into the formation, tending and protection of forests would be associated with the training institution.

In view of the success of the conference just held, and of the far-reaching results likely to follow, it is proposed that this should be only the first of a series of similar forestry conferences to be held at intervals of a few years in different parts of the Empire. Such conferences cannot fail to stimulate public opinion in regard to what is a very important national question or to advance the cause of scientific and economic forestry, which has hitherto been too much neglected by the Empire at large.

### Colloidal Electrolytes.

**C**OLLOIDAL electrolytes are defined as solutions of salts in which one ion has been replaced by a heavily hydrated multivalent "micelle," or cluster of ions, carrying an electrical charge equal to the sum of the charges of the constituent ions, and (by reason of its reduced resistance to movement through the fluid) serving as an excellent conductor of electricity. This new class of electrolytes probably includes most organic compounds, containing more than eight carbon atoms, which are capable of forming ions—e.g. proteins, dyes, indicators, sulphates, and soaps; it may also include inorganic compounds, such as chromium salts, tungstates, silicates, etc., which have a marked tendency to form highly complex ions. Work on this subject has been in progress in the laboratory of physical chemistry at the University of Bristol during a period of several years, and the results of the investigation have recently been published by Prof. J. W. McBain in papers communicated to the Royal Society (Proc. R.S., 1920, A, 97, 44-65), to the Chemical Society (Trans. C.S., 1919, 115, 1279-1300), and to the American Chemical Society.

The earlier experiments at Bristol showed that soap solutions possess a high degree of electrical conductivity, not only in dilute, but also in concentrated, solutions. This electrical conductivity could not be attributed to hydrolysis, since the absence of all but mere traces of free alkali could be demonstrated by measurements both of rate of catalysis and of electro-motive force. The high conductivity of the solution must therefore be due to the soap itself. Experiments on the depression of the freezing-point of soap solutions, and later experiments on the lowering of vapour-pressure, showed that, whilst the salts of the simpler fatty acids have an osmotic activity diminishing steadily as the concentration increases, salts of the higher homologues (from  $C_{10}$  upwards) have an osmotic activity which passes through a minimum and then through a maximum before finally diminishing to a low value in the most concentrated solutions. The high osmotic activity of the soaps in concentrated solutions, coupled with the remarkable electrical conductivity of these solutions, is explained most satisfactorily by the theory of the ionic micelle. In its simplest form this micelle might be merely a polymer of the negative radical, in a strongly hydrated condition, but it is possible, and even

probable, that the micelle carries, condensed on its surface, not only a considerable proportion of the solvent, but also much of the undissociated solute.

In reference to the general aspects of this work, two comments may be made. In the first place, Prof. McBain, in attempting to determine the real character of soap solutions, has tackled one of the big outstanding problems that called most urgently for a clear solution; the six years which he has devoted to this work have therefore been used far more advantageously than in solving the hosts of minor problems which appeal so strongly to workers who are anxious for immediate publication of results. In the second place, the elucidation of the nature of soap solutions by the theory of the ionic micelle is perhaps the biggest advance that has been made in the theory of electrolytic dissociation since the early work of Arrhenius and van't Hoff. Other workers, especially in physiology, have made use of similar ideas, but in no previous case has the experimental evidence been so complete or the theory established on so firm a basis as in the case of the soap solutions investigated in the Bristol laboratory. T. M. L.

### Plant Culture in Denmark.

IN Denmark during the past twenty years there have been great advances in the development of the various branches of plant culture. The organisation and aims of this work are described by Prof. F. Kolpin Ravn in a recent number of the *Scottish Journal of Agriculture* (vol. iii., No. 2, April, 1920). The first Danish experiments on plant culture were commenced in 1860 by B. S. Jørgensen, who took Rothamsted as his model. Later development followed various lines, but one of the most famous pioneers was P. Nielson, who in 1886 became director of the first State experiment station, and laid the foundation of the extensive State experimental work carried on at the present day. In 1893 the root experiments which had previously been instituted by the Society for the Improvement of Cultivated Plants were placed under the control of the State experiment stations, and in 1903 the same thing happened with the wheat and malt-barley experiments of the Royal Agricultural Society.

During the closing years of the nineteenth century various agricultural societies became keenly interested in plant-culture experiments, and by means of special committees on plant industry a large amount of useful work has been carried out. Since 1905 an increasing number of field experiments have been started by the "smallholders'" societies, the members of which have taken up this experimental work with great enthusiasm. All this work is carried out either by the State itself or by institutions with the aid of Government subsidies, the State contributing annually about 25,000*l.* for the development of plant culture. There are eleven State experiment stations, eight of which specialise in agricultural problems and the other three in horticultural problems. Field experiments and laboratory work are included, while various sub-departments carry out investigations on weeds, on plant diseases, and on chemical, physical, and bacteriological problems. The State stations deal with those problems requiring lengthy and very accurate experiments, while the agricultural societies conduct experiments designed to throw light on matters of actual and of local interest. The majority of these experiments deal with the use of fertilisers, and hints as to the final results appear in a very short time. Another section of experimental work is that of plant breeding, which is practised both by public and by private institutions. This work is supported by the

State experiment stations in that all novelties appearing on the market are accurately tested by variety and strain experiments without regard to the person or institution by whom they have been grown. In this way a competition open to all seed-growers and plant-breeders is formed, and this excites great interest, since the results of the experiments determine the market price of the seed.

Prof. Ravn points out that although the work appears to be very much scattered, yet the various institutions keep in close touch with each other by joint meetings, etc., when the general lines of work are discussed and common methods decided upon. It is thought that this type of organisation is most favourable to the development of initiative and to the proper testing of new ideas and products.

### Short-period Meteorological Variations.

NO. 102 of the Publications of the Royal Netherlands Meteorological Institute contains Dr. E. van Rijckevorsel's eleventh communication on the subject of secondary maxima and minima. The author maintains that if sufficient years be taken to mask the long-period variations, and mean values for an element such as temperature or barometric pressure be set down for each day in the year, the resulting figures for any station will show a series of waves of an average period of between ten and eleven days, so that thirty-five maxima appear in the annual curve.

The present contribution is devoted principally to a comparison of the barometer values for thirty-three stations from periods varying from forty-three years at Haparanda to only four years at Honolulu and St. Vincent, with those obtained in the long series of seventy-two years (1838 to 1909) at Christiania. The Christiania data are analysed more thoroughly, as the whole series is divided into two thirty-six-year periods A and B; and also the first twenty-four years of A, the last twelve years of B, and the first six years of B are treated separately. Moreover, the data from Christiania, Nertchinsk, and Innsbruck have been specially examined, the means from an equal number of years of maximum and minimum sun-spots having been taken for each of the three stations. Innsbruck is not one of the thirty-three stations, which are themselves grouped according to latitude, the mean latitude of the groups being 67°, 52°, 42°, and 21° respectively. They are fairly well distributed in longitude. Diagrams are given of twelve pulsations, the groups being separated and the stations in each group arranged in order of longitude, and an attempt is made to indicate a sort of systematic variation in the agreement between the several curves.

A final diagram gives apparently ideal curves of temperature and pressure through the year, showing the subsidiary period only affected by some annual variation which flattens the waves at the equinoxes, compared with actual values from fifteen years' data at Bucharest. Dr. van Rijckevorsel has devoted himself for many years to this particular investigation, but it does not seem to have enlisted much support up to the present time. W. W. B.

### University and Educational Intelligence.

CAMBRIDGE.—Prof. S. J. Hickson, of Manchester, has been elected an honorary fellow of Downing College. Mr. A. J. Berry has been re-elected to a fellowship.

GLASGOW.—Dr. A. J. Ballantyne has been appointed lecturer in ophthalmology in succession to Dr. M. Ramsay.

LIVERPOOL.—A contribution of 10,000*l.* in support of the University Appeal Fund has been made by the Cunard Steamship Co., Ltd.

The Pacific Steam Navigation Co., Liverpool, has made a contribution of 1000*l.* to the same fund.

THE directors of Messrs. Brunner, Mond, and Co. were authorised at an extraordinary meeting held at Liverpool on August 4 to distribute 100,000*l.* out of the investment surplus reserve account to universities or other scientific institutions in the United Kingdom for the furtherance of scientific education and research. Proposals for the allocation of this grant are under consideration, but no scheme has yet been adopted by the directors.

An examination for the Aitchison memorial scholarship, of the value of 30*l.*, and tenable in the full-time day courses in technical optics at the Northampton Institute, Clerkenwell, will be held in September next. The scholarship is open to candidates of both sexes between sixteen and nineteen years of age. The compulsory subjects are English and elementary mathematics. The optional subjects, of which only two must be taken, are additional elementary mathematics, physics (heat, light, and sound), chemistry, electricity, and magnetism. Full particulars are given in a leaflet which can be obtained from the hon. secretary and treasurer, Mr. Henry F. Purser, 35 Charles Street, Hatton Garden, London, E.C.1.

NEWS has just reached us that Prof. A. T. De Lury was appointed some months ago to be head of the department of mathematics in the University of Toronto by the Board of Governors on the recommendation of the president of the University, Sir R. A. Falconer. The Staff, Council, and Senate have nothing to do with appointments, and the only check upon the action of the president and the Board of Governors is public opinion. Prof. De Lury has been a member of the teaching staff of the University for many years, and is the author of a number of mathematical text-books which have done service in the schools of the province of Ontario. He possesses high teaching ability, but has not been associated with the research activities which it should be the essential function of a university to create and foster. Without men engaged in the production of new knowledge the work of a university differs little from that of a secondary school preparing students for examinations. Toronto has won much distinction by the scientific investigations of such men as Profs. Macallum, McLennan, and Brodie, and it was hoped that the chair of mathematics would have been filled by someone who possesses the highest research qualifications in mathematics that Canada could produce. If Prof. De Lury can and will build up a strong research staff under him, he will be doing the best service to his University and extend the stimulating atmosphere which some of his scientific colleagues have given to the institution by their work.

AMONG the recent bulletins issued by the U.S. Bureau of Education, Washington, is one (No. 61) entitled "Public Discussion and Information Service of University Extension." It comprises some fifty pages octavo, and deals with the extra-mural activities of the numerous universities and library commissions of the various States. The bulletin submits that university extension should not only offer the opportunity of self-directed study for the great mass of persons who wish to continue systematically their preparation for personal advancement, but should also provide the indispensable connection between scientific knowledge and the everyday practice necessary for sound community development, between the facts

accumulated through research and their application to the practical problems which must be met by individual communities in a democratic society. University education is not merely educational in the limited sense; it attempts to make facts, knowledge, and truth operative in the daily life of the people. The scope of university extension so interpreted includes bureaux of information, lecture schemes—club study and library service—assistance in debates and in other forms of public discussion, together with a novel institution known as the package-library service, by which is meant the compilation by specialists at each university or library centre of information of pamphlets, bulletins, clippings from articles in magazines and other sources on subjects and questions of interest to the public, which are sent on application to individuals or organisations in districts, however remote, within the State. Wisconsin, for example, had in 1918-19 more than 1000 subjects, and the Texas bureau 550, represented in their package-library collections, the contents of each of which are changed from time to time. They cover the whole domain of civic, economic, and State activities. The bulletin gives full particulars of the cost, methods, and organisation of the service, which might with much advantage be introduced into this country. The information bureaux were made much use of, since nearly 180,000 requests for information were received in fourteen States, and in twenty-four States the lectures arranged were attended by upwards of 2,000,000 persons.

## Societies and Academies.

### PARIS.

Academy of Sciences, July 19.—M. Henri Deslandres in the chair.—F. E. Fournier: The resistance of a fluid to the horizontal translation of a spindle-shaped or spherical body with deep immersion.—A. Haller and Mme. Ramart-Lucas: Bromohydrins and dibromoderivatives obtained from the alkylallylacetophenones,

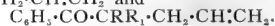

Compounds of the latter type give bromohydrins on treatment with bromine; under the same conditions methylallylacetophenone gives a stable dibromide,  $C_6H_5 \cdot CO \cdot CH(CH_3) \cdot CH_2 \cdot CHBr \cdot CH_2Br$ .—F. Widal, P. Abrami, and N. Iancovescu: Proof of digestive hæmoclasis in the study of hepatic insufficiency. It has been shown in an earlier communication that for some time after a nitrogenous meal incompletely digested proteids pass into the portal vein from the intestine, and that these substances are prevented from passing into the general circulation by the normal action of the liver. This has now been applied clinically after a meal of 200 grams of milk or of meat and eggs. No symptoms of hæmoclasis are given by healthy subjects or by subjects suffering from various illnesses provided the liver is in a normal condition, but with the liver diseased a similar meal is followed by a hæmoclasic crisis, with alterations in the number of white corpuscles, arterial pressure, coagulability of the blood, and refractometric index of the serum. These symptoms have proved capable of detecting latent disease of the liver when the usual signs are wanting.—E. Ariès: The determination of the last of the three functions which defines the equation of state of ether.—G. Fubini: Automorphic functions.—G. J. Remondos: The modulus and zeroes of analytical functions.—A. Petot: The spherical representation of surfaces and the correspondence by parallel tangent planes.—G. Bruhat: Remarks on the compression of saturated

vapours.—**M. Sauzin**: The propagation of sustained dielectric oscillations in water and the dielectric constant of water. Oscillations with wave-lengths in air of 444 cm. and 242 cm. gave 73 as the dielectric constant of distilled water—a little lower than the usually accepted figure, 80.—**C. Zenghelis**: New researches on the action of gases in a very fine state of division. A continuation of experiments described in a previous paper on the same subject. From a mixture of hydrogen and carbon dioxide, formaldehyde and its condensation products were identified. The reduction was favoured by light, especially by the ultra-violet rays.—**J. Cournot**: The annealing of electrolytic iron. The removal of hydrogen from electrolytic iron by annealing can be effected by heating for two hours at 95° C. or one hour at 105° C. At 85° C. or lower temperatures micrographic study and hardness determinations proved the annealing to be incomplete even after six hours' heating.—**L. Guillet**: Some new researches on special brasses. Studies of brasses containing cobalt, chromium, silver, and gold.—**G. Gire**: The oxidation of arsenious anhydride in alkaline medium in presence of ferrous sulphate.—**G. Denigès**: Iodic acid as a microchemical reagent characteristic of gaseous ammonia. A 10 per cent. solution of iodic acid gives characteristic crystals of ammonium iodate on exposure to gaseous ammonia. As little as 0.1 milligram of ammonia can be detected by this means.—**A. Desgréz** and **J. Meunier**: The incineration of organic matter with the view of determining its mineral constituents; application to blood analysis.—**A. Korczynski**, **W. Mrozinski**, and **W. Vielau**: New catalytic elements for the transformation of diazo-compounds. Salts of cobalt and nickel may replace copper salts in certain applications of Sandmeyer's reaction.—**J. Martinet** and **O. Dornier**: A new indigo colouring matter, 5-[dioxo-2:4-pyrimidino]-2-indolindigo.—**H. Hubert**: New contact phenomena of the diabases in Western French Africa.—**A. de Puymaly**: A new small green alga, *Prasiola leprosa*.—**A. Paillot**: The Encocytoides and Teracytes.—**A. Dehorne**: Atypical characters in somatic mitosis in *Corethra plumicornis*.—**B. Guérithault**: The presence of copper in plants, and particularly in food of vegetable origin. Copper was present in forty-four materials of vegetable origin (vegetables, seeds, and fruits) in amounts varying between 9 and 63 milligrams per kilogram of dried substance.—**A. Krempf**: The last phases of the development of the endodermic metamorphosed organs of the larvæ of Anthozoa and the formation of the pharynx.—**E. Chatton**: Palisporogenesis: a mode of reproduction special to certain parasite Flagellæ.—**J. Feytaud**: Young colonies of the luminous Termite.—**A. Ch. Holland** and **P. Vernier**: *Cocobacillus insectorum*, var. *malacosomæ*, a pathogenic bacillus of the blood of the caterpillar, *Malacosoma castrensis*.

## PHILADELPHIA.

**American Philosophical Society**, April 22.—**Prof. W. B. Scott**, president, in the chair.—**Dr. L. M. Haupt**: Beach-protection works.—**Prof. D. W. Johnson**: Geographic aspects of the Adriatic problem.—**A. G. Mayor**: The reefs of Tutuila, Samoa, in their relation to coral-reef theories.—**Prof. H. F. Reid**: Distribution of land and water on the earth. The conception of the land of the earth as being a deeply dissected and loosely joined together mass, with its centre about half-way between the equator and the poles, explains nearly all the characteristics of the distribution of land and water, such as the antipodal relation, the concentration of land about the North Pole and of water about the South Pole,

etc.—**Prof. E. C. Kendall**: Thyroxin.—**Dr. S. J. Meltzer**: The dualistic conception of the processes of life. The dualistic conception of the life-processes may be presented as follows: Irritability is a characteristic property of all living tissues. Irritability means the property of the tissues to react with a change in each state to a proper stimulus. The change may consist in an excitation—an increase in activity, or an inhibition—a decrease in activity. Each and every state of life of the plain tissues or of the complex functions is a resultant from the combination of the two antagonistic factors, excitation and inhibition.—**Dr. F. G. Blake**: The relation of the *Bacillus influenzae* to influenza. The experiments described establish the etiological relationship of *Bacillus influenzae* to the type of bronchopneumonia with which the organism has been found constantly associated in man. They also prove that *B. influenzae* can initiate an infection of the upper respiratory tract and produce a disease that closely resembles influenza and is associated with the same complications as influenza. They do not prove that *B. influenzae* is the primary cause of influenza, however, since it is impossible to determine whether the disease produced in monkeys by inoculation with *B. influenzae* was actually identical with pandemic influenza.—**Dr. W. E. Dandy**: X-rays of the brain after injection of air into the ventricles of the brain and into the spinal canal.—**Prof. J. D. Prince**: Celt and Slav. Slavs and Celts are strikingly similar to each other in habits of mind and expression, although far removed geographically. The Russians, Poles, Czechoslovaks, Serbo-Croatians, and Bulgarians, all speaking Slavonic idioms, although racially very various, have certain marked traits in common which they all share with the Celts, viz. the Irish, Scottish, and Manx Gaels, the Armorican Bretons of France, the Welsh, still Celtic-speaking, and the Cornish, whose Celtic language is now extinct. The similarity between Slavs and Celts is twofold, viz. temperamental discontent and morbid joy in sorrow. As a concomitant of this discontent goes the spirit of quest after the unattainable, which is manifest in both Slavonic and Celtic trends of thought. The sun of common sense has never risen on either the Slav or the Celt, and it is doubtful whether the Slavs can exist very long without the guiding hand of strangers. The charm of the Celt and Slav is great and durable, but it is charm and not character, feeling and sentiment rather than thought and reasoning, which dominate the east and west of Europe alike.—**Prof. R. B. Dixon**: A new theory of Polynesian origins. The question of the racial origins of the Polynesian peoples has long attracted the attention of anthropologists. Previous studies have dealt mainly with small portions of the area, and have not satisfactorily correlated the various factors characterising physical types, or the Polynesian types with those of the rest of Oceania. The present study seeks to secure more satisfactory results by including the whole of Oceania and Eastern Asia in its scope. Following a method differing from those previously employed, a number of fundamental physical types are defined, and their distribution and that of their derivatives traced. One of these fundamental types unexpectedly proves to be Negrito, the other two most important ones being Negroid and Malavoid. The Negrito and Negroid types, being marginal in their distribution, are probably the older.—**Prof. A. V. W. Jackson**: The Zoroastrian doctrine of the freedom of the will. The purpose of this paper was to show the significance of the doctrine of the freedom of the will in the dualistic creed of Zoroaster more than 2500 years ago.—**Prof. M. Jastrow, jun.**: The Hittite civilisation. The Hittites seem to have been composed of a

conglomeration of various ethnic elements, and about 1500 B.C. a strong Hittite empire was located in northern Asia Minor which was powerful enough to threaten both Egypt on one side and Babylonia and Assyria on the other. These Hittites, moving along the historical highway across Asia Minor, left their rock monuments and their fortresses as traces of the power and civilisation which they developed. Their contact with Assyria appears to have been particularly close, and it is not impossible that the earliest rulers were actually Hittites. The "sons of Heth" associated in tradition with Abraham are Hittites, and there were Hittite generals in the army of the Jewish Kings.—Prof. M. Bloomfield: The decipherment of the Hittite languages.—Prof. P. Haupt: The beginning of the Fourth Gospel. John i. 1 should be translated: "In the beginning was reason." Greek "logos" denotes both "word" and "reason." Logic is the science of reasoning. According to the Stoics, reason (Greek "logos") was the active principle in the formation of the universe.

### Books Received.

Scottish National Antarctic Expedition. Report on the Scientific Results of the Voyage of S.Y. *Scotia* during the Years 1902, 1903, and 1904. By Dr. W. S. Bruce. Vol. vii., Zoology. Parts 1-13, Invertebrates. Pp. viii+323+15 plates. (Edinburgh: Scottish Oceanographical Laboratory.) 50s.

Le Radium. Interprétation et Enseignements de la Radioactivité. By Prof. F. Soddy. Traduit de l'Anglais par A. Lepape. Pp. iii+375. (Paris: Félix Alcan.) 4.90 francs.

Tracks and Tracking: A Book for Boy Scouts, Girl Guides, and Every Lover of Woodcraft. By H. M. Batten. Pp. 95. (London and Edinburgh: W. and R. Chambers.) 2s. net.

Criticism of the Nile Projects. Submitted by the Commission of Egyptian Engineers to the Nile Projects Commission, 1920. Pp. 36. (Cairo.)

Zi-ka-wei Observatory Atlas of the Tracks of 620 Typhoons, 1893-1918. By Louis Froc, S.J. Pp. 4+charts. (Zi-ka-wei.)

Records of the Indian Museum. Vol. xvii., June. Catalogue of Oriental and South Asiatic Nemoera. By E. Brunette. Pp. 300. (Calcutta: Zoological Survey.) 5 rupees.

Records of the Indian Museum. Vol. xx., June. A Monograph of the South Asian, Papuan, Melanesian, and Australian Frogs of the Genus *Rana*. By Dr. G. A. Boulenger. Pp. 226. (Calcutta: Zoological Survey.) 6 rupees.

Western Australia. Astrographic Catalogue, 1900-0. Perth Section, Dec.  $-31^{\circ}$  to  $-41^{\circ}$ . From photographs taken and measured at the Perth Observatory under the direction of H. B. Curlewis. Vol. xvii. Pp. 55. Vol. xviii. Pp. 107. Vol. xix. Pp. 101. Vol. xx. Pp. 99. Vol. xxi. Pp. 54. Vol. xxii. Pp. 105. Vol. xxiii. Pp. 100. Vol. xxiv. Pp. 75. (Perth.)

Transactions of the Royal Society of Edinburgh. Vol. lii., part 4. New Stellar Facts, and their Bearing on Stellar Theories for the Ferns. By Dr. J. M'L. Thompson. (Edinburgh: R. Grant and Son; London: Williams and Norgate.) 5s. 6d.

Monograph of the Lacertidae. By Dr. G. A. Boulenger. Vol. i. Pp. x+352. (London: British Museum (Natural History).) 2s.

Eugenics, Civics, and Ethics. By Sir C. Walston. Pp. 56. (Cambridge: University Press.) 4s. net.

Essays on Early Ornithology and Kindred Subjects. By I. R. McLymont. Pp. vii+35+3 plates. (London: B. Quaritch, Ltd.) 6s.

The Sugar-Beet in America. By Prof. F. S. Harris. Pp. xviii+342+xxii plates. (New York: The Macmillan Co.; London: Macmillan and Co., Ltd.) 12s. net.

British Museum (Natural History). Furniture Beetles: Their Life-History and How to Check or Prevent the Damage Caused by the Worm. By Dr. C. J. Gahan. (Economic Series, No. 11.) Pp. 23+1 plate. (London: British Museum (Natural History).) 6d.

British Museum (Natural History). British Antarctic (*Terra Nova*) Expedition, 1910. Natural History Report. Zoology. Vol. ii., No. 9, Mollusca. Part iii., Eupteropoda (Pteropoda Thecosomata and Pterota Pteropoda Gymnosomata). By Anne L. Massy. Pp. 203-32. 7s. 6d. Vol. ii., No. 10, Mollusca. Part iv., Anatomy of Pelecypoda. By R. H. Burne. Pp. 233-56+4 plates. 8s. 6d. Vol. iv., No. 3, Echinoderma (part ii.) and Enteropneusta. Larvæ of Echinoderma and Enteropneusta. By Prof. E. W. MacBride. Pp. 83-94+2 plates. 7s. 6d. (London: British Museum (Natural History).)

The Prevention of Tetanus during the Great War by the Use of Antitetanic Serum. By Maj.-Gen. Sir David Bruce. Pp. 27. (London: Research Defence Society.) 1s.

Der Aufbau der Materie; drei Aufsätze über moderne Atomistik und Elektronentheorie. By Max Born. Pp. v+81. (Berlin: J. Springer.) 8.60 marks.

### CONTENTS.

	PAGE
Progress! By Sir E. Ray Lankester, K.C.B., F.R.S.	733
Complex Elements in Geometry. By Prof. G. B. Mathews, F.R.S.	736
Motion Study and the Manual Worker. By H. M. V.	737
Our Bookshelf	738
Letters to the Editor:—	
University Grants.—Sir Michael E. Sadler, K.C.S.I.	740
The Carrying Power of Spores and Plant-life in Deep Caves.—Edith A. Stoney	740
Curious Formation of Ice.—Alfred S. E. Ackermann	741
Bees and the Scarlet-runner Bean.—Harford J. Lowe	742
The Condition of Kent's Cavern.—Edward A. Martin	742
Calculation of Vapour Densities.—Reginald G. Durrant	742
Use of Summer Lines in Navigation.—Prof. G. C. Comstock; Capt. T. H. Tizard, C.B., F.R.S.	742
The Research Department, Woolwich. II. ( <i>Illustrated</i> ) By Sir Robert Robertson, K.B.E., F.R.S.	743
The Romance of Bird Life. ( <i>Illustrated</i> ).	746
Helium: Its Production and Uses. ( <i>With Diagram</i> ). By Prof. J. C. McLennan, F.R.S.	747
Obituary:—	
Prof. John Perry, F.R.S.—H. E. A.; W. E. D. Prof. Augusto Righi, For. Mem. R.S.—Sir Oliver Lodge, F.R.S.	751
Notes	754
Our Astronomical Column:—	
An Interesting Meteorite	759
The Union Observatory, Johannesburg	759
Galactic Condensation	759
The British Empire Forestry Conference	759
Colloidal Electrolytes. By T. M. L.	760
Plant Culture in Denmark	761
Short-period Meteorological Variations. By W. W. B.	761
University and Educational Intelligence	761
Societies and Academies	762
Books Received	764



THURSDAY, AUGUST 19, 1920.

*Editorial and Publishing Offices:*

MACMILLAN &amp; CO., LTD.,

ST. MARTIN'S STREET, LONDON, W.C.2.

Advertisements and business letters should be  
addressed to the Publishers.

Editorial communications to the Editor.

Telegraphic Address: PHUSIS, LONDON.

Telephone Number: GERRARD 8830.

### The Control of Water Resources.

IN June, 1918, a Committee, with Sir John Snell as chairman, was appointed by the Board of Trade and the Ministry of Reconstruction "to examine and report upon the water-power resources of the United Kingdom and the extent to which they can be made available for industrial purposes." The Committee issued an Interim Report early in 1919, directing attention to nine large sources of water-power in Scotland which could be developed at once so as to supply electrical energy at economic rates. It was no doubt while investigating the conditions of water-power that the complexity of the general problem of the use of natural water was appreciated by the Committee, for in October, 1919, the terms of reference were extended by the Board of Trade to "consider what steps should be taken to ensure that the water resources of the country are properly conserved and fully and systematically utilised for all purposes." At the same time the Committee was strengthened by the addition of two officials of the Ministry of Health and three eminent water engineers. The enlarged Committee has issued a Report<sup>1</sup> dealing with the special subject of the new reference. It should be remembered that water for potable supplies must be delivered in a high state of purity, so that it cannot be collected from the surface in urban or agricultural areas. Water subject to organic impurities may, indeed, be rendered potable by

chemical and bacteriological means, as Sir Alexander Houston has demonstrated on the citizens of Greater London. But many communities demand a natural and untreated supply, and this, in default of deep wells, can be obtained only from uncultivated moorlands, most of which in England and Wales have already been appropriated.

The present method of allocating supplies is for a local authority to select a suitable gathering ground and then to promote a private Bill in Parliament. The proposed scheme, after being found to conform to Standing Orders, is examined in turn by a Committee of each House, the members of which may or may not have some knowledge of water supply and of parliamentary usage. An able counsel urges the necessity and perfection of the scheme on the Committee and brings forward experts to prove that the selected area can yield enough water and no more than is required. Certain Government Departments have the right to report upon the Bill, e.g. the Ministry of Health with regard to the quality of the supply and the needs of the population, the Ministry of Agriculture and Fisheries with regard to land drainage and possible damage to fish, and the Board of Trade or Ministry of Transport with regard to any possible effect on navigation. If the promoters succeed in arriving at an arrangement with the public bodies and private persons who appear as opponents, their scheme is likely to be passed by the Committee without any very critical inquiry, and it may be that broad national aspects of the case are never considered at all.

In Scotland there is in most cases an alternative to the promotion of a private Bill, by obtaining a provisional Order from the Scottish Office after an inquiry by a joint Committee of both Houses of Parliament sitting in the locality, and not at Westminster. In the absence of opposition the Order is confirmed by Parliament without further examination. A multitude of public and private opponents have a *locus standi* with regard to a Water Bill, but the fundamental idea appears to be that opposition is a matter for individual interests, and that it is not the business of any impartial authority to ascertain the facts of any particular case in the public interest alone. Selfish opposition often makes the passage of a Water Supply Bill difficult, and in the case of water-power the difficulty is much greater, as alternative sources of power are merely a matter of price.

The Report before us gives the considered

<sup>1</sup> Board of Trade. Second Interim Report of the Water-Power Resources Committee. Presented to Parliament by Command of His Majesty. Pp. 23. Cmd. 776. (London: H. M. Stationery Office, 1920.) Price 4d.

opinion of the Committee on the question of the most desirable mechanism of control for the whole water resources of the country, and it is evident that some diversity of opinion had to be reconciled in arriving at it. One member, Mr. W. A. Tait, of Edinburgh, submits a Minority Report in which he considers that all the reforms required can be secured by improving the present system, both by assimilating the law of England to that of Scotland and by making certain simplifications in procedure. He holds that there is no justification for a new central water authority. One member signs the Majority Report with a reservation in which he deprecates the creation of a Water Commission, on the ground that the Ministry of Health, if strengthened, can deal adequately with the matter. Another signs with the reservation that he would have preferred a Central Department to deal with all water interests. The remaining seventeen members found the terms of the Majority Report sufficiently comprehensive and guarded to express their views.

One might imagine that the easiest way to simplify the confusion of contending water interests would be to create a Central Department for the United Kingdom to which all existing Departments should transfer their duties as regards water, and in which any additional powers which might be required should be vested. By the constitution of the Committee the water problem in Ireland was referred to a special Irish Subcommittee, and recent events naturally confirm the policy of keeping Irish interests by themselves. But the Committee has not found it possible or expedient even to recommend the retention of Great Britain as a unit, and the scheme outlined refers in its entirety to England and Wales, Scottish interests being left to the Scottish Office.

It seems unfortunate, in the present state of public feeling, that a rearrangement of duties could not have been suggested which should avoid adding to the present number of officials; but, on the other hand, it is necessary to bear in mind that the Committee set itself to devise a practicable scheme which could be got to work with the minimum disturbance of existing Departments. Viewed as a workable compromise, the plan suggested by the Committee has sound qualities which probably compensate its obvious theoretical deficiencies.

The Committee points out that nine previous Royal Commissions and Select Committees which

had considered water problems between 1866 and 1910 had concurred in recommending the creation of a central water authority to control the allocation of water, to act as an advisory body to Parliament, and to collect information as to water resources. Much fresh evidence was called by the Committee, and the final scheme for control put forward in this Report is as follows.

The allocation of sources of water in England and Wales should be entrusted to a body of four Commissioners appointed by the Minister of Health, to whom their responsibility should be direct. The chairman of the Commission should be a Civil Servant or lawyer having ripe experience of administration and legislation. The other three should be technical members, all to be paid and to devote their whole time to the work. An Inter-departmental Committee representing the "multiplicity of interests to be reconciled" and including representatives of various scientific services should be set up by statute to assist the Commissioners.

In order that the Commission may perform its duty of allocating water, its first concern is held to be to acquire all necessary information on the subject. This should be obtained from the Departments already engaged in collecting such data, particularly the Ordnance Survey, the Geological Survey, and the Meteorological Office; but as these do not cover the whole ground the Commission should be empowered to set up a Hydro-metric Survey. The Commission should consult with the Scottish and Irish authorities with a view to the compilation of all records on a uniform system.

It is recommended that every proposal to take water from the surface or from underground, except for private domestic use, should be submitted to the Commission for its licence. If the Commission sees cause to withhold its consent, the promoters can still proceed by means of a private Bill; but if a licence is issued, they need apply only to the Department dealing with the particular use of water, and this Department should be empowered to grant an Order which, if unopposed, should take effect without confirmation by Parliament. Existing Departments are empowered to deal with all uses of water except water-power, and it is proposed to create either in the Board of Trade or under the Electricity Commissioners a new Department for the study, control, and encouragement of the use of water-power in Great Britain. Encouragement should include the grant of temporary financial assistance to promising power

schemes. This subject is to have fuller treatment in the final Report of the Committee.

In addition to new allocations the Water Commission should have power to revise existing allocations, including the compensation water already prescribed by Act of Parliament. Another duty would be the setting-up of local Rivers Boards to control individual rivers as a whole.

One further safeguard is suggested, namely, the appointment by the Commission of an advisory committee, or committees, consisting of "representatives of water undertakings and scientific institutions, consulting engineers, and other qualified persons." Presumably the services of these specialists are to be solicited gratuitously, for the Commission "also" ask to be empowered "to obtain and pay for professional advice in connection with their investigations."

Perhaps one might be inclined to doubt whether the Committee has always kept clearly in mind the essential distinction between scientific and technical advice; but in one respect at least the Report will be welcome to scientifically minded people. It places in the forefront of the duties of the Water Commissioners the investigation by scientific study of the actual water resources of the country and the strengthening of existing agencies by the creation of a hydrometric survey of rivers. One cannot help regretting that the various survey bodies are not united under one scientific Department, for it would be a natural development if the Department of Scientific and Industrial Research were to add to the care of the Geological Survey that of the Ordnance Survey, the Meteorological Office, and the proposed Hydrometric Survey. In these matters, however, simplification comes slowly, and it is a great matter to find a clear statement of the truth, which is not self-evident to all our legislators, that one must first ascertain what our resources are before we proceed to distribute them.

We have endeavoured to state the conclusions as briefly and simply as possible, but the Report goes into much detail and requires careful reading. The system suggested is, we believe, as simple and efficient as it could be made, bearing in mind the initial determination to work so far as possible through existing agencies. But it is open to doubt the wisdom of that determination and to ask whether the creation of a Central Department dealing with all water questions, and with water questions only, might not, after all, be a simpler, cheaper, and more efficient solution of the problem.

NO. 2651, VOL. 105]

### The Mathematician as Anatomist.

*Department of Applied Statistics, University of London, University College: Drapers' Company Research Memoirs. Biometric Series, x.: A Study of the Long Bones of the English Skeleton.* By Karl Pearson and Julia Bell. Text: Part i., The Femur. Chaps. i. to vi. Pp. v+224. Atlas: Part i., The Femur. Pp. vii+plates lix+Tables of Measurements and Observations. (Cambridge: At the University Press, 1919.) Price, Text and Atlas, Part i., 30s. net.

*Department of Applied Statistics, University of London, University College: Drapers' Company Research Memoirs. Biometric Series, xi.: A Study of the Long Bones of the English Skeleton.* By Karl Pearson and Julia Bell. Text: Part i., Section ii., The Femur of Man, with special reference to other Primate Femora. Chaps. vii. to x., Appendices, Bibliography, and Indices. Pp. 225-539. Atlas: Part i., Section ii., The Femur of the Primates. Pp. vii+plates lx-ci+Tables of Femoral Measurements of the Primates. (Cambridge: At the University Press, 1919.) Price, Text and Atlas, Part i., Section ii., 40s. net.

IF in the rapid increase of knowledge at the present time there is a tendency for men to limit their labours more and more to one narrow field of investigation, there is also, we are glad to note, an opposite tendency leading men who have become eminent in their own particular subject to cross professional frontiers and to carry war, seldom peace, into neighbouring or even distant specialities. In the present two great publications, devoted chiefly to the human thigh-bone, containing more than a quarter of a million words, with tables which give the results of at least 70,000 measurements, and illustrated by 105 anatomical plates, we find Prof. Karl Pearson, the mathematician, definitely settling himself in the front bench of speculative anatomists. He cannot have expected a warm welcome in his new quarters, for there are few British anatomists who do not bear the mark of at least one of those biometrical brickbats at the throwing of which Prof. Pearson has manifested very considerable skill. They did not hurt any the less because they were meant kindly! In spite of all their scars, however, British anatomists—nay, anatomists of every country—who study these volumes will forget their past sores and be glad to welcome him to their membership for the great service he has rendered to their subject, not only in this, but also in previous memoirs.

To understand aright what has been accomplished in the memoir now under review one has to go back twenty-five years to 1895, when Prof. Pearson, then the occupant of the chair of applied mathematics at University College, London, showed how the mathematical theory of statistics could and should be applied to all the manifestations of life. He was the only man then in England to perceive that Francis Galton was a really great man, and that if the knowledge relating to man and to living things was to be placed on a sound foundation, it must be laid by an application and an amplification of the Galtonian methods. Anatomists had made a survey of the human body and recorded their experience by giving accurate descriptions of what they had seen and broad generalisations as to what they thought. Prof. Pearson realised, as Galton had done before him, that no progress could be made in our knowledge of populations, races, or species until accurate standard methods of measurements had been applied to great numbers of individuals, and hence the first task which faced him, in building up a biometrical school, was the gathering of data to which statistical methods could be applied. Fortunately Sir George Thane, when professor of anatomy at University College, had had the foresight to store in his department great assemblages of human bones recovered from burial grounds in the East End of London—presumably remains of seventeenth-century Londoners who had died of the plague. This material became a treasure trove for the growing biometrical school.

Prof. Pearson's methods were applied to the skulls by the late Dr. W. R. Macdonald, and for the first time we had given to us standard data relating to the skull of the Englishman. Skulls have always been a favourite means for the study of racial characters, but Prof. Pearson wished to show that other bones had also their racial values, and by 1907 he was in a position, with the assistance of Miss Julia Bell, to commence his investigation of the thigh-bone.

Prof. Pearson had in the East London collection about 800 examples of this bone—each of which was examined, and in almost every instance measurements were made and estimates formed relating to eighty characters—in some examples to as many as a hundred—in order to establish the prevailing features of the thigh-bone of English men and women. He had to standardise old methods of making measurements and indices and to invent many new ones. In the course of his work he has brought to light many important facts which are new to anatomists. From this first phase of his investigation he was led, very naturally, to a second—to see how the English

thigh-bone compared with that of Continental peoples. He had to search foreign records, and found them almost as barren of accurate details as those at home, but we cannot help noting his leniency towards the shortcomings of anatomists who live beyond the shores of England. Then followed in due course a third step—a comparison of the thigh-bone of the European with that of other races of the world—and a fourth—a comparison of the thigh-bone of modern man with that of ancient and extinct races of mankind. A fifth extension of his original aim was a comparison of the human femur with that of other members of the Primate class—the gorilla, the chimpanzee, the orang (the great anthropoids), the gibbon (or small anthropoid), the monkeys of the Old and of the New Worlds, and lastly with the lowest of Primate forms—the Lemuroids, including Tarsius. Then came a sixth extension—a study and comparison of the thigh-bones of extinct apes and Lemuroids. Finally, on the evidence he had thus accumulated from an intensive study of the thigh-bone, we have the construction of a pedigree or lineage of their owners—a pedigree which gives us the conception he has formed of man's evolutionary history and of man's relationship to the higher members of the animal kingdom.

By this natural sequence of inquiries the professor of mathematics has become an exponent of human phylogenetics. Setting out in 1907 with the intention of examining the femur of the Londoner, he ended in 1919 with a survey of the world of Primates.

Those who have had experience in arranging the members of a group of plants or animals—in conformity with their natural affinities—in a scheme which will express their evolutionary relationships are well aware that diverse, even contradictory, results are obtained, according to the system of parts used in framing the scheme of classification. If we arrange the Primates by grouping them according to the anatomical characters of their teeth, we get one result; if by their brains and nervous system, a second and very different grouping; if by their digestive system, a third; if by their reproductive system, a fourth, and so on. All the systems have to be taken into account, and to some, such as the brain, much more weight must be given than to others. In the most perfect scheme of classification there are always blemishes; the evidence of one system will be found to contradict or be at variance with that of another.

There need be no surprise at this variance of evidence; it should be so if heredity works in a Mendelian way. If we confine our attention, in

framing a pedigree, to the parts of one system, more particularly to a single element of one system, as Prof. Pearson has done, there is a great risk of obtaining a purely artificial scheme of arrangement. If we use the thigh-bone alone, our classification of the Primates will serve to show only the evolution of their locomotory systems.

We are not forgetful that the discovery of a single fossil thigh-bone may be the sole basis on which we have to reconstruct an extinct form of man or ape. In such an event this memoir would be invaluable, for it gives us, for the first time, the basis on which a rational prophecy can be framed. There is a case in point which is very elaborately dealt with by Prof. Pearson—the thigh-bone of *Pithecanthropus*. He has applied more accurate and more elaborate tests to the anatomical characters of this bone than has hitherto been the case, and comes to the conclusion, as the majority of anatomists have already done, that in no essential point does it differ from that of modern man. And yet the skull assigned to this primitive humanoid form is almost as much that of an ape as of a man. Prof. Pearson is too cautious a man of science to deny the possibility of a being having at the same time an almost perfect human femur and a skull and brain which are non-human, but he is clearly more than sceptical, for in his scheme of classification *Pithecanthropus* must be given a place amongst races of modern man. Even when he has given us, as he has promised—and it is sincerely to be hoped he will be able to carry it out—his programme of research—the correlative of the thigh-bone to all the other bones of the body and their relationships to the jaws and cranium—there will still remain the infinitely more difficult task of stating in mathematical terms the correlative of one system to another, such as that of the nervous to the digestive system, or of the respiratory to the reproductive, circulatory, and other systems. For some time, it is clear, we must depend, as in the past, on the somewhat crude methods of anatomical appreciation and analysis.

We have already told how the principal author of this monograph was led, during the latter part of the twelve years he devoted to a study of the femur, to ascertain what light his results shed on the evolutionary histories of mankind, the anthropoid apes, monkeys, and lemurs. It is true that his method of comparison sometimes leads him to quite surprising situations—of the humour of which he is perfectly aware—as when man and the pig find themselves the closest of allies as regards the diameters of their femoral shafts, or when the Old World monkeys find themselves cheek by jowl

with man because of the equality of length in their femoral condyles. But on the whole his results and deductions must be regarded as helpful and trustworthy. It so happens that the writer of this review has, these thirty years past, been collecting data from all the systems of the Primate body (see *NATURE*, 1911, vol. lxxxv., p. 508), and has from time to time assorted his observations to see how far a scheme of Primate evolution could be framed which would give a coherent explanation of the distribution of anatomical characters such as is now seen in the bodies of man, the anthropoid apes, and the monkeys of the Old and New Worlds. The results which have been reached by Prof. Pearson and the reviewer are, in the main, in harmony. The mathematical anatomist insists upon an anthropoid or troglodytic link in man's lineage; he claims to have reinstated the great anthropoid or troglodyte as a necessary stage in man's ancestry; but he will find that very few anatomists who have given this problem due thought have dismissed the anthropoid apes from the place given to them by Huxley. Prof. Pearson gives *Tarsius* a remote place in his scheme of human evolution. He is right, too, in dismissing the present-day gibbon from man's family tree, but altogether wrong if he supposes that the hylobatian stock from which the modern gibbon (highly specialised so far as limbs are concerned) arose plays no part in man's lineage. He is right, too, in concluding that the gibbon has no claim to be brigaded with the great anthropoids—the gorilla, chimpanzee, and orang. In their essential structure the gibbons form a separate group, one which serves to link together—or at least to bridge the gaps between—the monkeys of the Old and New Worlds and the great anthropoids. They are the essential link between monkeys and anthropoids. The femoral characters of the gibbon give a somewhat misleading indication of its true place in the phylum of the higher Primates.

As a common ancestor of the human and great anthropoid group—the pre-troglodyte in man's lineage—Prof. Pearson postulates a "Protsimio-human" Primate form, which he believes will turn out to be more human than anthropoid, a mathematical deduction with which few naturalists will agree. On the other hand, certain inferences made regarding the status and relationship of early races of man in Europe, founded entirely on the characters of their thigh-bones, are particularly worthy of attention. There has been much speculation regarding the existence of negroids in southern Europe in late Pleistocene times, founded on the discovery of remains of two Grimaldi indi-

viduals in a cave near Mentone. From a study of their skulls the reviewer came to the conclusion that they had nothing of the African negro in them, but that they were of the Cromagnon race, a conclusion which Prof. Pearson has reached independently from a study of their thigh-bones. He is uncertain of the relationship of Neanderthal and of Cromagnon man to modern races of mankind—uncertain as to whether these two types of ancient Europeans should figure as stages, or links, in the chain of modern man's evolution, or whether they really represent branches which have sprung from that stem. The evidence of their skulls and teeth leaves modern anatomists in little doubt as to their true relationships; Neanderthal man represents the terminal stage of a side branch, whereas Cromagnon man is but one of the numerous varieties of modern man. One other point is to be noted: in surveying the evolutionary evidence yielded by a single bone the same discordant array of indications is found as when all the systems of the body are studied; the final result has to be obtained by an exercise of judgment on the part of the classifier.

It is a matter of everyday observation that no two people walk exactly alike; there is the same infinite variety in the human gait as is found in the human face. Women have their own particular kind of progression; not one of us uses the right limb in exactly the same way as the left; the left foot is more frequently inturbed to a greater degree than is the right. If, as medical men believe, bone-cells are peculiarly sensitive and responsive to the muscular and other stresses which are brought to bear on them, then there ought to be just that range of variation of form in the thigh-bone which this monograph demonstrates to exist. A functional explanation of the structural variation of the femur is one which Prof. Pearson is not prepared to entertain, and unfortunately medical men have as yet neglected, or almost neglected, the study of the living femur, and are therefore unable to say whether or not the anatomical forms of the femur are correlated to certain peculiarities of gait. The improvement in our means of examining the anatomy of the thigh-bone in the living by the aid of X-rays is likely to fill up this blank in our knowledge, and at the same time to offer a rational explanation of many puzzling features noted and estimated by Prof. Pearson and his collaborator. A study of the manner of progression of anthropoids in their natural habitats will help to show how closely form and function are correlated. In the orang, for instance, the hind limbs are reduced to mere grasping organs; in it and in the gibbon the swinging arms are the chief organs of progres-

sion. In the reviewer's opinion all measurements and calculations should be made, so far as is practicable, not only to indicate the degree and kind of racial characteristics, but also to express degrees and kinds of function. Indices should be of such a nature as to convey to the student a precise conception of the degree and kind of function.

This great memoir opens up a prospect which may well appal the heart of the stoutest anatomist. Here we have two parts, running to 539 pages, each page containing on an average more than 500 words, devoted to the subject which the authors speak of as femorology and the special students of which are called femorologists, with the promise of a third part. When the examination of the human skeleton is completed on a corresponding scale we shall have an immense library. We may not like the prospect, but is there any option if our knowledge of mankind is to be based on a foundation which will last? The reviewer does not think there is any other way, and feels sure that the time will certainly come, if it has not already come, when anatomists the world over will acknowledge the courage, industry, and prescience of the English school of biometrics and of its founder. It would be a set-back to the progress of our knowledge of mankind were Prof. Pearson's projected programme to be in any way curtailed by a lack of financial assistance.

A. KEITH.

### The Theoretic Basis of Psychotherapy.

*The New Psychology and its Relation to Life.*

By A. G. Tansley. Pp. 283. (London: George Allen and Unwin, Ltd., 1920.) Price 10s. 6d. net.

ABOUT fifteen years ago Prof. Scripture, of Yale, published his book upon "The New Psychology." The psychology which was "new" then was experimental psychology; now the new psychology is something very different—the study of the non-rational processes of the human mind. Most of the material of Mr. Tansley's book consists in theories which are contained in the works of Prof. Freud, of Vienna; of Dr. Jung, of Zurich; and of Mr. William McDougall, who is just now leaving Oxford to settle at Harvard. The work of these three researchers has achieved world-wide renown; Mr. Tansley has done a good service in presenting some important elements of them in a compact and readable form. Mr. McDougall's books are accessible enough, but the views of the two Continental savants are scattered through various publications in a way which is rather baffling to the English reader. With

the help of Mr. Tansley anyone can now make himself acquainted with the main points at issue.

The work of Freud and Jung deals mainly with the sub-conscious, that mysterious twilight region of the mind whence spring most of our deepest and strongest motives. The key which Freud has used to unlock its secrets is sex. He lays stress upon the immature sex-experience of young children and upon the repressed sexual desires of adult life which show themselves in dreams and in lapses of memory and behaviour. In this way he explains not merely the unusual phenomena of hysteria, but also the mental strains and stresses which trouble the peace of ordinary sane men. Dr. Jung, on the other hand, takes a wider view; he argues that not only sex, but also every strong natural human interest—the desire for self-preservation, for example—may be the cause of mental conflicts and nervous disorders. His view has been strikingly confirmed by the experience of the physicians who have treated the complicated war-neuroses which are familiar to the public under the term of "shell-shock." It is another side of the sub-conscious that has engaged the attention of Mr. McDougall. He has written more upon our instinctive life and shown how much of the experience which seems to us distinctively human is really based upon tendencies that are shared with the animals below us. He has done a great work in analysing our various instincts and in showing how they influence our conduct and our emotional life.

The main reason why the new psychology has so greatly impressed popular imagination is that most excellent results have been produced by it in the treatment of nervous disorders. The early workers in this field were men who were either practising physicians, or closely in touch with medicine. As soon as they formed a theory they proceeded at once to put it to the test of practice. Extraordinary cures have been performed by working upon the assumption that the trouble in the patient is of mental origin, and that the bodily symptoms are merely the physical expression of mental strain. In psychotherapy, as in medicine generally, our knowledge of detail and of derivative facts far exceeds our knowledge of fundamental principles. We know, for example, that if the physician is able to discover the nature of a hidden mental conflict which is troubling the patient, and can talk and reason with him about it, the symptoms are usually relieved. This process is technically termed "ab-reaction," and the real efficacy of it is attested by scores of incontestable cures.

This being so, it is easy to explain why Mr. Tansley's book is most satisfactory when he is  
NO. 2651, VOL. 105]

dealing with such matters as the interpretation of dreams, the "rationalisations" by which men try to justify conduct which is really prompted by non-rational motives, and the great psychic complexes which correspond to the main instincts of man. And we can explain why the book is less satisfactory in the general theoretical chapters with which it opens. Mr. Tansley has done his best to combine "new" psychological theories from Freud, Jung, and McDougall into a consistent whole. The result is not very clear or convincing. But perhaps in the present state of our knowledge we could scarcely look for greater success. H. S.

### Industrial Research.

*The Organisation of Industrial Scientific Research.* By Dr. C. E. Kenneth Mees. Pp. ix + 175. (New York and London: McGraw-Hill Book Co., Inc., 1920.) Price 12s.

THE author of this book is a distinguished worker in the branch of science with which he is associated, and his experience as the director of a large industrial research organisation has been such as to warrant careful consideration of his views. The book is mainly intended for manufacturers who, while convinced of the need for research in their industries, have had no occasion to consider in detail the planning and administration of a works research department. Many scientific workers will also welcome an opportunity of acquainting themselves further with the broad questions of research policy and organisation in industry, which the individual engaged on a specific task often fails to see in correct perspective. The scope of the book and the sequence of chapters are admirable. Consideration is given to various types of research laboratories, to the development of co-operative research, and particularly to the internal organisation and staffing of the works research laboratory, together with its relation to the other parts of the factory. Some general details are also given relating to the design and equipment of the laboratory, and a comprehensive bibliography is attached.

The classification of research laboratories largely resolves itself into a list of the various agencies by which the laboratories are financially maintained. To avoid the obvious disadvantages of such a grouping, the author distinguishes between "convergent" and "divergent" laboratories, depending on whether varied problems and phenomena converging on a common object are studied, such, for instance, as at the pottery school at Stoke-on-Trent or at the laboratory for glass technology at Sheffield, or whether a wider field is covered having no particular common

feature, such as at the National Physical Laboratory or at a laboratory serving the interests of a group of works producing many kinds of manufactured articles.

Criticising the research associations developed in this country, the author deprecates the degree of control remaining in the hands of the Research Department, the character of the *personnel* of the Advisory Council and its committees, and the policy of secrecy which is fostered by a research association comprising a group of manufacturers in one industry; and considers the difficulty of determining the choice of researches and the disposal of results to be serious. Many people, however, will not display any particular enthusiasm for the author's alternative proposal, a co-operative laboratory conducted by an association of users. It may be admitted that users have a common interest, but this is less clearly defined and much more difficult to focus on one line of research than that of an association of producers. Users also have less experience in the production of the material they employ, and in industry it is highly desirable to make use of existing knowledge as a basis for research. The author may not be aware that, in some cases at least, British research associations are dual in character, comprising both producers and consumers, this probably being an ideal combination.

It is important to note that the author considers it undesirable to divorce a works research department from works problems, and the success of notable instances to the contrary should not obscure the principle.

Many readers will doubtless wish that the author had gone further into detail than is the case in many chapters. The economic and social benefits of research should perhaps not have been taken for granted, and the question of the co-ordination of research and the collection and distribution of scientific intelligence could have been dealt with to advantage. In general, however, the book bears the marks of experience throughout, and will well repay perusal.

A. P. M. FLEMING.

### Science and Crime.

*Legal Chemistry and Scientific Criminal Investigation.* By A. Lucas. Pp. viii+181. (London: Edward Arnold, 1920.) Price 10s. 6d. net.

THERE are numerous text-books on the subject of forensic medicine, but, with the exception of works on toxicology, there are very few which deal with analogous problems to the investigation of which chemistry is applicable. This little book makes no pretension to being a complete

NO. 2651, VOL. 105]

treatise on forensic chemistry, and to this extent its title is misleading, for it consists largely of notes on the cases which have come within the author's experience, together with a few general remarks on the methods of dealing with exhibits and presenting the evidence in such cases.

As director of the Government laboratory in a country such as Egypt, where frauds of all kinds appear to be exceptionally numerous, the author has had the advantage of applying the methods described in various journals in a great number of cases, and of noting their deficiencies, and he gives particulars of these cases arranged alphabetically under the headings of the different subjects.

As a rule, original methods have not been devised, but some of the sections give interesting details of the author's investigation in connection with special subjects. For example, referring to human hair, he shows that it is doubtful whether the alleged change in the colour of the hair to red has ever been caused by the Egyptian method of embalming. Another novel point of chemical interest is that in no instance has pitch or bitumen been found in the pitch-like material used in preserving human mummies, the material examined invariably consisting of resins or gums which have become naturally blackened by age.

From the point of view of the practical chemist, the most useful section is that dealing with the examination of documents, in which questions connected with the composition of paper and inks are dealt with at some length. In one land case it was found that out of 168 documents no fewer than 163 were forgeries, the frauds ranging from simple alterations of names to the elaborate fabrication of documents by joining parts of other documents, and concealing mutilations by partly scorching the paper. In this connection the author lays stress upon the importance of knowing the dates of changes in the methods of manufacturing paper and the like.

As carbon ink is still frequently used in Egypt for title deeds of land, the author has had the exceptional opportunity of studying modern documents written in ink similar to that used prior to the invention of iron gall inks, and he gives interesting particulars of his observations. Contrary to the commonly accepted belief, the carbon inks on several of the older Arabic documents between A.D. 1677 and 1871 were partly brown, and the same thing was noted on still earlier manuscripts dating back to A.D. 622. Hence the conclusion is drawn that it must be regarded as proved that carbon inks which were originally black may become brown with age.

The questions of secret writing and its develop-



ment, the imitation of seal impressions, the forgery of postage stamps, and the examination of handwriting are also briefly touched upon in this section, whilst there is a cognate section upon the detection of robbery from letters and parcels in transit.

Other subjects which are discussed include the examination of dust and stains, the development of finger-prints, the investigation of the cause of fires and of damage to crops, and the examination of fibres, ropes, and clothing. In each case references to literature on the subject are appended, and illustrative cases usually given.

Regarded as a whole, the book should be welcomed by every chemist whose work is likely to include any problems in which legal questions are involved, and it might well be made the nucleus of a more comprehensive work on forensic chemistry. It is sometimes urged against the publication of details of scientific methods as applied to the detection of crime, such as are given here, that it is dangerous to provide prospective criminals with information in a convenient form for reference; but this objection applies with more cogency to the publication of the scientific methods of combating the adulteration of food. The adulterator is frequently waiting to be made acquainted with the scientific drawbacks of his methods, whereas the persons who commit other forms of fraud are nearly always without scientific training and, if they were to attempt to avoid one scientific pitfall, would be almost certain to fall into another.

C. A. M.

### Our Bookshelf.

*Optical Projection.* By Lewis Wright. Fifth edition, rewritten and brought up to date by Russell S. Wright. (In two parts.) Part i., *The Projection of Lantern Slides.* Pp. viii+87. (London: Longmans, Green, and Co., 1920.) Price 4s. 6d. net.

This completely revised edition of Mr. Lewis Wright's book is very welcome. We are glad to see that the oil-lantern, which is so handy in small class-rooms and in the huts of camps, is still regarded as a possible projector. It may be mentioned that if this lantern is filled for each occasion, and set up lighted in an adjacent room, or, better still, in the school-yard, for forty minutes or so before the lecture, all risk of producing offensive fumes will be avoided. In regard to screens for such class-rooms, may we add that a square of mounted diagram-paper, which is made 5 ft. wide, gives an excellent surface, and can be kept rolled up and fixed with large drawing-pins as required? Lastly, when Mr. R. S. Wright gives suggestions as to flash-signals, should he even tolerate the "next slide" system of com-

munication with the operator? The recently introduced silent wave of the pointer has escaped mention in this useful treatise.

G. A. J. C.

*Elementary Agricultural Chemistry: A Handbook for Junior Agricultural Students and Farmers.* By Herbert Ingle. Third edition, revised. (Griffin's Technological Handbooks.) Pp. ix+250. (London: Charles Griffin and Co., Ltd., 1920.) Price 5s.

THERE are no essential differences between this and the second edition of Mr. Ingle's book. The volume provides an excellent introduction to its subject in a form which should be intelligible to the practical agriculturist as well as to the scientific student. It contains a number of interesting and useful tables, and on account of its very reasonable price it should be popular with students of agriculture. Although described on the cover as "A Practical Handbook," it contains no account of experiments or methods of analysis, but these would no doubt have increased the size of the book beyond the limits desired.

*Luck, or Cunning, as the Main Means of Organic Modification? An Attempt to Throw Additional Light upon Darwin's Theory of Natural Selection.* By Samuel Butler. Second edition, re-set, with author's corrections and additions to index. Pp. 282. (London: A. C. Fifield, 1920.) Price 8s. 6d. net.

THIS is a reprint of the first edition published in 1886. The only important changes are in the index, which has been considerably enlarged by additions made from notes by the author in a copy of the first edition. As is announced in the introduction, the book is written round Samuel Butler's favourite theories, "the substantial identity between heredity and memory," and "the re-introduction of design into organic development."

*Notes on Chemical Research: An Account of Certain Conditions which apply to Original Investigation.* By W. P. Dreaper. Second edition. (Text-books of Chemical Research and Engineering.) Pp. xv+195. (London: J. and A. Churchill, 1920.) Price 7s. 6d. net.

THE first edition of this stimulating work was reviewed in NATURE for February 6, 1913. The new edition is divided into two portions, the first dealing with the history and method of research, and the second with modern works practice. A chapter in the latter portion is given up to the consideration of the training desirable for a research student. An index would have been helpful.

*Spiritual Pluralism and Recent Philosophy.* By C. A. Richardson. Pp. xxi+335. (Cambridge: At the University Press, 1919.) Price 14s. net.

THE author examines the Weber-Fechner law of sensation and shows that "unperceived sense-data," such as are sometimes deduced from it, are not logically admissible. He expresses spiritual

pluralism as the assumption that our sense-perceptions are due to other "subjects of experience" of a non-material nature, and akin to our own subjective self. Guided by this principle, he discusses determinism and immortality, the relation of mind and body, and certain abnormal phenomena usually called "spiritualistic."

*Unconscious Memory.* By Samuel Butler. Third edition, entirely reset; with an Introduction and Postscript by Prof. Marcus Hartog. Pp. xxxix + 186. (London: A. C. Fifield, 1920.) Price 8s. 6d. net.

THE first edition of this work was reviewed in NATURE for January 27, 1881. The second edition, noticed in NATURE for November 3, 1910, contained an introduction by Prof. Marcus Hartog, giving an outline of Samuel Butler's works and discussing their value to science. In the present edition Prof. Hartog has appended to his introduction a postscript in which he sets forth, briefly, the position of Samuel Butler's biological works in modern science.

*Wild Fruits and How to Know Them.* By Dr. S. C. Johnson. Pp. xi + 132. (London: Holden and Hardingham, Ltd., n.d.) Price 1s. net.

A BRIEF description of most of the trees and shrubs found on the English countryside is given, special attention being paid to the forms of inflorescences and fruits. Identification of specimens is greatly simplified by the large number of sketches, showing both foliage and fruit, which are included. The last chapter is devoted to the commoner plants and weeds which have conspicuous fruits.

*Silver: Its Intimate Association with the Daily Life of Man.* By Benjamin White. (Pitman's Common Commodities and Industries.) Pp. xi + 144. (London: Sir Isaac Pitman and Sons, Ltd., n.d.) Price 2s. 6d. net.

THIS volume is more concerned with the statistics and economics of silver than with technology, although an interesting account of the extraction, purification, and utilisation of silver is given. There are many useful tables. An interesting chapter deals with "The Evolution of British Coinage." The book is addressed to the general reader, but contains much of service to teachers and students.

*The Identification of Organic Compounds.* By the late Dr. G. B. Neave and Prof. I. M. Heilbron. Second edition. Pp. viii + 88. (London: Constable and Co., Ltd., 1920.) Price 4s. 6d. net.

THE second edition of this useful manual has undergone practically no alteration. It is one of the best books of its kind, and contains a large amount of information in a handy and compact form. We have no doubt that it will continue to find favour among students and teachers of chemistry.

*Gold: Its Place in the Economy of Mankind.* By Benjamin White. (Pitman's Common Commodities and Industries.) Pp. xi + 130. (London: Sir Isaac Pitman and Sons, Ltd., n.d.) Price 3s. net.

THE steps by which gold has acquired its high value, and its past history with regard to production and uses, are described. The last portion of the book is devoted to a review of the gold stocks in the world and their movements before and during the Great War. A number of tables is included, showing the amount and value of gold in use in various countries; these should be of interest to students of commercial geography and economics.

*Pastimes for the Nature Lover.* By Dr. S. C. Johnson. Pp. 136. (London: Holden and Hardingham, Ltd., n.d.) Price 1s. net.

SOME of the plants and smaller animals commonly found in this country are described, and methods of preserving them or of studying their habits, as the case may be, are given. Silkworms and Nature photography are also mentioned. The book would be of use to young collectors.

#### Letters to the Editor.

[The Editor does not hold himself responsible for opinions expressed by his correspondents. Neither can he undertake to return, or to correspond with the writers of, rejected manuscripts intended for this or any other part of NATURE. No notice is taken of anonymous communications.]

#### University Grants.

I AGREE with Sir Michael Sadler in thinking that the article on university grants in NATURE of August 5 is very opportune, and I concur completely in all that he says on the subject in the issue for August 12. It is not necessary for me to repeat the arguments and the statements so briefly and emphatically expressed by the Vice-Chancellor of the University of Leeds, because I feel sure that everyone with a competent knowledge of the situation in the modern universities would agree that Sir Michael Sadler has by no means understated the gravity of the crisis with which the universities are faced.

At Birmingham, as at Leeds, we have been rigidly economical in our expenditure. We know that we are doing work the value of which is appreciated by our students and the community of the Midlands whom we endeavour to serve. But unless large new grants are forthcoming it will be impossible for us not only to continue to meet those needs, but also to maintain the standard of work in the various departments.

To what Sir Michael Sadler has said I would add only two points:

(1) Unless the stipends of the non-professional staffs of the universities are placed on something like equality with those obtaining for skilled intellectual work elsewhere, e.g. in the Government service or in the service of the great municipalities, it will be impossible to obtain or retain the men and women with the requisite qualifications for university work; and it is from the members of the non-professional

staffs, when they have been trained in the universities, that the universities must later look for filling the professorships. A decrease, therefore, in the number and the quality of the non-professorial staffs of the universities means ultimately a decrease in the number and quality of the professors throughout the country. University teachers, particularly of professorial status, cannot be improvised or provided at a moment's notice. Competent professors are the result of attracting the requisite ability to the service of the universities in the junior grades and providing those junior grades with the opportunities for training in teaching and in research until they have reached the standard expected for professorial purposes. Unless, therefore, the universities are properly staffed, in a few years' time the whole standard of teaching and of research and of knowledge throughout the universities will inevitably drop; and it is desirable to remember that on the maintenance of the standards of the professoriate the training of the non-professorial staff largely depends.

Serious as is the situation to-day, its full meaning will not be apparent until some years hence, and it will then be impossible to make good what can be made good now, if we are not penny wise and pound foolish.

(2) Inadequate staffs, inadequate teaching, and overworked professors mean a drop in the quality of the students turned out by the universities. It is to the university-trained student that the Government, the municipalities, the schools, and the whole commerce and industry of the country must look for its *personnel*. If the universities are not doing their work up to the standard required, it is not the universities ultimately which will suffer most, but the whole nation. We shall be beaten as a nation because we shall be inferior as a nation.

The policy of the Government and of the local education authorities at present is to encourage, and rightly to encourage, the extension and the elevation of secondary schools in order to increase both the number of boys and girls to be kept on until they are eighteen years of age, and the number of boys and girls who will be fit to profit by a university education. What is the use of spending millions on adding to and improving the secondary schools throughout the country if the universities, which are the apex of this educational system, are to be starved? The secondary schools will be pouring out students which the universities will not be able to take; or, if they do take them, will not be able to give them a proper university education under proper teachers. Because you refuse to spend three millions, you will waste twenty or thirty millions.

Research in the universities, owing to the present congestion and inadequacy in numbers of the staff, is at present at a standstill; and unless steps are taken *now* to provide competent researchers, as well as a proper organisation and opportunities for research, the advancement of knowledge in Great Britain will come to an end. Organised research cannot be carried on anywhere except in a properly equipped university; and where industrial firms are carrying it on in a few specialised branches of industrial science from their own resources, they rely upon being provided from the universities with men and women fit to do the research required. It is not the business of, nor is it possible for, great firms to do the work of the universities in all the departments of knowledge.

The Government and the nation must make up their minds not so much as to whether the universities are to continue as to seeing that the universities are really universities and doing university

work. The funds cannot be provided from the tuition fees of the students. Seventy-five per cent. of the cost of maintaining a university must be provided from other sources than those of fees. I agree, therefore, with Sir Michael Sadler that while we welcome the additional half-million promised twelve months hence, another million and a half at least are required in order that the universities may be maintained on an adequate basis.

At Birmingham, as at Leeds, we need another 60,000*l.* a year in income in order to meet absolutely necessary expenditure. C. GRANT ROBERTSON.

The University, Birmingham, August 13.

#### Aerial Navigation and Meteorology.

PROF. VAN EVERDINGEN'S outspoken criticism in NATURE of July 22, p. 637, of the meteorological arrangements outlined in Annexe G of the Convention for International Air Navigation is very welcome. Prior to the war the International Meteorological Committee met every three years in friendly gatherings for social intercourse and the transaction of business. Broadly speaking, the difficulties of the members were in obtaining sufficient funds to enable them, in their respective services, to achieve the ends upon which they were agreed rather than in securing agreement on the desiderata for international exchange. Now that the former difficulties have been largely met as a result of the achievements of meteorology in the war, it would be calamitous if meteorologists failed to overcome the latter, and disturbed the unity of European meteorology at a time when their efforts ought to be directed to achieving unity in world-meteorology.

I am convinced that the scheme of Annexe G is a good one, and that a frank discussion of the details with the Continental meteorologists who were not present at the Peace Conference in Paris in May, 1919, would lead to the general adoption of the scheme with the slight modifications which experience of its working has indicated.

Prof. van Everdingen states that Annexe G was discussed at the meeting in London of members of the pre-war International Meteorological Committee. He has been misinformed. Permission to put Annexe G before that meeting was definitely refused. If such a discussion had been permissible, it would probably have removed many misapprehensions.

To take some examples from Prof. van Everdingen's article:

(1) He objects that in Appendix III. (apparently a misprint for Appendix I.) he finds "wind, temperature, and humidity in the upper air as additional and facultative." By "facultative" he means "optional." But Annexe G neither says nor implies that such reports are "optional." The exact words are: "Reports will give information on [wind, etc.], and also on upper air-currents and upper air-temperature and humidity from stations where facilities are available for observation." All standard meteorological stations are able to report wind, pressure, temperature, and weather phenomena three or four times daily all the year round; but only specially equipped stations can report upper air-currents, temperature, and humidity, and no station could in 1919, or can now, report upper-air information with the same frequency and regularity as standard stations report surface observations.

(2) Prof. van Everdingen states that the use of the telegraphic scale 1-72 means that an accuracy of 5° is claimed for surface wind direction. That is not so. In the past a scale of 1-32 has been nominally used (actually the

and numbers are usually not utilised), but no one thinks that an accuracy of  $1\frac{1}{4}^\circ$  is thereby claimed, and everyone knows that the exposure of the anemometer and the turbulence of the wind cause larger variations with space and time than  $1\frac{1}{4}^\circ$ . The scale 1-72 was adopted for the following reasons: Nearly all the observations of wind in the upper air are made by theodolites graduated in degrees and read to tenths of a degree (or exceptionally to minutes). The direction of the upper wind is obtained in degrees. Division of the number so obtained by 5 leads to the scale 1-72. It is much simpler than division by  $1\frac{1}{4}$ , which would lead to the scale 1-32. Moreover, the variation of wind direction with height cannot be indicated with sufficient precision by a scale 1-32. Also, the general practice in scientific work is to specify directions in degrees, and the practice is extending both at sea and in the air. The scale 1-72 is the most precise two-figure scale which is readily converted into degrees.

Whatever method is used for obtaining wind direction at the surface, the result can be telegraphed in the scale 1-72 without difficulty; if only the eight principal directions (N., N.E., E., etc.) are used, then only the corresponding numbers of the scale (72, 9, 18, etc.) will be used.

(3) Prof. van Everdingen objects to the use of two figures for reporting "weather." The need for an extension of the existing one-figure code has been apparent for a long time. A meteorologist at headquarters requires from a reporting station sufficient information to enable him to say with precision and certainty what the weather was at the station at the time of report. With the pre-war code for international exchange this was not done. A few drops of rain or a little drizzle were reported by the same figure as the most torrential downpour. A few flakes of snow or some fine ice-crystals were reported by the same figure as the heaviest snowstorm. No figure was provided for hail or sleet, and no indication given of the thickness of a fog (in past weather). A sky nearly covered with thin, white clouds at 20,000 ft. or 30,000 ft. was described by the same figure as the darkest, gloomiest day of the year. All this was due to the restriction of the pre-war code to one figure. It was not due to failure on the part of pre-war meteorologists to recognise the phenomena which ought to be recorded and the need for differentiation of intensity. *Practically the whole of the phenomena for which provision is made in the ninety-five figures of the code of Annexe G are included in the "hydrometeors" for which provision was made in Appendix I. of the fourth meeting of the International Meteorological Congress at Vienna in 1874.* Annexe G merely makes provision for reporting by telegram, at the time when it is of direct use, the information which the Congress at Vienna arranged should be written down and reported in *monthly returns* for later scientific investigation. As to the observer being puzzled, there will always be some occasions when he is required to use intelligence in deciding which number to select, whether the single-figure pre-war code is in use or the fuller two-figure code. The difficulty is minimised for him in Annexe G by arranging that all occasions on which precipitation occurs shall be reported by a number greater than 50. We have not found in actual practice the troubles which Prof. van Everdingen fears.

The severest criticism is directed against the inclusion of detailed codes in the Convention. Holland signed the International Convention for the Safety of Life at Sea in 1914; that Convention included detailed codes for meteorological reports. Meteorology is

more vital to the safety of life in the air than even ice reports to the safety of life at sea. The latter were made obligatory in 1914.

No one questions the *competence* of the International Meteorological Committee to fix the details of a code. That Committee must be in substantial agreement on the details of any code before it can be made generally obligatory. But at present the urgent need is for the trial of a scheme by the nations of Western Europe which is capable of being extended to the whole globe. The scheme of Annexe G is the only one in the field which provides both the general forms for meteorological messages and the detailed specifications necessary for reports to be made and interpreted in the confidence that their meaning is clear and definite, and that the information which they contain meets the present needs of an organised meteorological service. E. GOLD.

8 Hurst Close, N.W.4, July 25.

(1) COL. GOLD is not too well informed about the history of the International Meteorological Committee. The introduction of improvements in the reports and codes has often given rise to animated discussions; for example, when barometric tendency was introduced. It is true that the opponents remained friends, and that the minority co-operated in carrying out the resolutions, but that was a reason not to insist upon the introduction of a resolution which had been adopted by 7 votes against 6.

(2) There is at present no unity in European meteorology; it is no use to quarrel about who disturbed it; discussion of *various systems* by a competent body is the only way to restore it. I am very glad that the British weather reports for aerial navigation have modified already part of the codes of Annexe G. This certainly is a step towards reconciliation.

(3) The minutes of the meeting of members of the pre-war International Meteorological Committee held in London in July, 1919, at which both Col. Gold and I were present, contain a collection of codes almost identical with that of Annexe G. Col. Gold is right when he says that Annexe G was not discussed then, but that makes very little difference.

(4) Every standard station can report cloud motion or pilot-balloon observations. I am glad to state that cloud motion has now been introduced in regular British reports.

(5) The reading of the theodolite is accurate enough, but the direction of upper wind derived from the results is, in general, not accurate to less than  $10^\circ$ . A scale 1-36 is used in Holland and elsewhere. For scientific use a more accurate indication may be useful; for practical purposes it is useless.

(6) I only object to the way in which the two figures are combined for reporting weather; extension of the space for description of weather is welcome.

(7) My remarks referring to numbers to be used by observers in reporting phenomena are based on the practice we actually have had with the British reports.

(8) Annexe G can have its trial at the present moment if the Powers who signed it care. There are several other systems and codes being tried by various countries, and when these have had their course we shall be in a better position to decide what the present needs of an organised meteorological service are and how they can be met. E. VAN EVERDINGEN.

Koninklijk Nederlandsch Meteorologisch Instituut, De Bilt, August 9.

### Growth of Waves.

THERE has always been some difficulty in accounting for the growth of waves under the action of wind. Do the individual waves grow in length, or does the wind raise waves of all lengths which separate in virtue of the dependence of wave-velocity on wave-length? The late Lord Rayleigh was in favour of the latter hypothesis, but I believe that the true explanation is that the waves do not increase in length unless they are breaking.

The excess of energy supplied by the wind to the water beyond that which can be carried in an unbroken wave is expended partly in causing local turbulence (ultimately converted into heat) and partly in producing a surface current in the direction of the travel of the wave. In effect, this surface current increases the wave-velocity; and since the addition to the current by each wave depends on the time for which that wave has been in existence, the waves first formed will, after the lapse of time, be travelling faster than the more recently formed waves which follow. Thus if waves are set up by wind on a previously calm water-surface, the wave-length will continuously increase from windward to leeward.

I have made some rough observations on a pond something like 1000 ft. in length, and found that in a brisk breeze the waves formed at the windward end showed as ripples of a few inches from crest to crest, while at or near the leeward margin the wave-length was about 2 ft. If it is assumed that the wave-length increases regularly, there would be about a thousand crests in the length of the pond, and the gain in length from wave to wave would be about 1/1000th of the mean wave-length. All the waves from the least to the greatest were in a breaking condition. The ripples did not show any foam at their crests, but it was clear from their shape that they were actually breaking.

There is no satisfactory theory of the shapes assumed by breaking waves. Stokes, in one of his earlier papers, showed that the irrotational form of wave cannot have an angle of less than  $120^\circ$  at the crest (the corresponding limit for the trochoidal wave, i.e. for the cycloid, is  $90^\circ$ ), but he considers that the wave will break before the  $120^\circ$  limit is reached.

In the problem presented by breaking waves—as, indeed, in most problems relating to the actual phenomena exhibited by fluids in motion—the simple assumptions on which the hydrodynamical theory of text-books rests are insufficient, and experiments are required.

It would be quite possible to try (say at the Froude tank at the National Physical Laboratory) the effect of a steady artificial wind on a length of several hundred feet of water, and to observe and record the form, length, and velocity of the waves throughout the length of the channel. It would probably be found that the waves were started by the instability due to the discontinuous motion at the boundary of two fluids, and that these waves increased in amplitude only until they began to break, but that after the breaking state was reached the wave-length, as well as the amplitude, increased until there was some approach to equality between the velocity of the wind and the wave.

I have worked out the results for various assumptions as to the rate at which the wind can transfer energy to the water, but in the absence of experimental data the conclusions are scarcely worth publication.

A. MALLOCK.

9 Baring Crescent, Exeter, August 10.

NO. 2651, VOL. 105]

### The Antarctic Anticyclone.

IN his letter entitled "The Mechanics of the Glacial Anticyclone Illustrated by Experiment" published in NATURE for July 22, Prof. Hobbs remarks: "In all my writings upon the glacial anticyclone I have been at much pains to explain that the domed surface of the ice is essential to the development both of the anticyclone and of the alternating calms and blizzards which record its strophic action." As, however, one goes on to read the letter one finds that Prof. Hobbs's explanation demands another "essential," namely, that the domed surface must be cooler than the air in contact with it. Remove this defect of temperature, and the mechanism ceases to act; reverse it, and the mechanism works in the reverse direction, producing a cyclone instead of an anticyclone.

Assuming that the Antarctic continent has the domed form postulated by Prof. Hobbs, one might be led to accept his conclusions so far as the winter months are concerned, but what about the summer months? During the summer, with its continuous insolation, the surface of the dome must be at a higher temperature than the adjacent air, for there is plenty of evidence that the temperature of a snow surface is very susceptible to solar radiation. The mean amplitude of the daily variation of air-temperature over the Barrier during November, December, and January was found by Scott's Expedition to be  $11.5^\circ$  F., while between November 17-22, 1911, the average amplitude was  $20^\circ$  F., and this with the sun oscillating only between  $10^\circ$  and  $35^\circ$  above the horizon! If Prof. Hobbs's theory were correct the Antarctic would have a pronounced monsoon climate, while we know from observations that anticyclonic conditions last throughout the year.

G. C. SIMPSON.

London.

### Trichodynamics.

THE present writer has had interesting associations since 1915 in various ways with projects for industrial research in the cotton industry and with its actual conduct. In all these the need for a word which would define and describe the field of research peculiar to the textile industries has been intermittently obvious, especially with respect to the processes of spinning and weaving.

In consequence of this I proposed, in the course of the discussion on industrial research at the tenth International Conference held in Zurich in June last, that the word "trichodynamics" should be adopted in order to effect this generalisation, together with the related term "trichostatics." The analogy with aerodynamics is obvious, and hence also my justification for suggesting the word. The word itself is open to question, since, if used in the literal sense, it includes only the hair textiles, e.g. wool and cotton, but the significance intended is akin to that of the word "capillary," which now conveys a definite meaning independently of actual hairs.

The chemical and colloidal constitution of textile raw materials, their biology, and the engineering aspects of their utilisation are fields of study not strictly peculiar to the textile industry. On the other hand, the movements and mutual contacts of attenuated filaments and the changes which take place in their arrangement as they pass from the tangle of the raw material to their orderly sequence in yarn or cloth, which the proposed names would cover, form a well-defined field of a peculiar kind which awaits physical investigation.

W. LAWRENCE BALLS.

Edale, Derbyshire, August 11.

Helium: Its Production and Uses.<sup>1</sup>

By PROF. J. C. McLENNAN, F.R.S.

## II.

*Miscellaneous Investigations.*

IN the course of the investigation on the development of a machine for extracting helium from natural gas, supplies of helium of varying degrees of purity became available. These were highly purified, and used for the investigation of certain collateral problems which demanded solution. Among the results obtained, it was found that for aeronautical purposes hydrogen could be mixed with helium to the extent of 15 per cent. without the mixture becoming inflammable or explosive in air. Mixtures containing even as much as 20 per cent. of hydrogen could be burnt or exploded only when treated in an exceptional manner. The permeability of rubbered balloon fabrics for helium was shown to be about 0.71 of its value for hydrogen. For skin-lined fabrics, the permeability to hydrogen and helium was about the same. Thin soap films were found to be about one hundred times more permeable to hydrogen and helium than rubbered balloon fabrics, but untreated cotton fabrics when wetted with distilled water were but feebly permeable to these gases. It was found that rapid estimations of the amount of helium in a gas mixture could be made with a pivoted silica balance, a Shakspear katharometer, or a Jamin interferometer.

The latent heats of methane and ethane have been determined, as has also the composition of the vapour and liquid phases of the system methane-nitrogen. It has also been shown that helium containing as much as 20 per cent. of air, oxygen, or nitrogen can be highly purified in large quantities by simply passing it at slightly above atmospheric pressure through a few tubes of coconut charcoal kept at the temperature of liquid air. In the spectroscopy of the ultra-violet helium has been found to be exceptionally useful. Arcs in helium between tungsten terminals can be easily established and maintained. In a particular investigation with a vacuum grating spectrograph, it was found that by the use of arcs in helium under 30 cm. pressure illumination could be maintained continuously for hours, and with such arcs spectra could easily be obtained extending to below 1000 Å.U.

Although it is known that free electrons can exist in highly purified helium to an amount easily measurable, it was found that pure helium under a pressure of more than 80 atmospheres did not exhibit anything in the nature of metallic conduction. Moreover, the mobilities of both positive and negative ions formed by  $\alpha$ -rays in helium under this high pressure were found to have about one-third the value expected on the basis of an inverse pressure law.

<sup>1</sup> From a lecture delivered before the Chemical Society on June 17. Continued from p. 751.

*The Uses of Helium.*

The investigation into the problem of producing helium in large quantities was originally undertaken with a view to the utilisation of the gas in aeronautical warfare. The investigation has shown that it can be produced at a cost which is not excessive, but it has also been shown that from the sources in the Empire which are known and have been examined the supply of helium cannot be greater than about 12,000,000 cubic feet per year. This quantity clearly would be sufficient to keep only a very few of our airships of the larger type in commission, even if the gas were diluted to the extent of 15 per cent. with hydrogen. This amount would, however, suffice to keep a number of the smaller aircraft supplied. Moreover, it might be used to fill fireproof compartments adjacent to the engines if it were ever decided to install these within the envelopes of our larger airships.

Since it has been demonstrated that helium can be produced in quantity, one is led naturally to consider in what directions one can hope to use the gas other than that originally intended. In industry it may be used as a filling for thermionic amplifying valves of the ionisation type. It may also be used for filling tungsten incandescent filament lamps, especially for signalling purposes where rapid dimming is an essential, and for producing gas arc lamps in which tungsten terminals are used, as in the "Pointolite" type. Both these varieties of lamp possess the defect, however, of soon becoming dull owing to the ease with which incandescent tungsten volatilises in helium and deposits on the surface of the enclosing glass bulbs. As regards illumination, helium arc lamps possess an advantage over mercury arc lamps in that the radiation emitted has strong intensities in the red and yellow portions of the spectrum.

It has been shown by Nutting (*Electrician*, March, 1912) that Geissler tubes filled with helium are eminently suitable, under certain conditions, for light standards in spectrophotometry, but the amount of the gas which could be used in this way is very small.

In spectroscopy, especially for investigations in the ultra-violet region, helium is invaluable. Doubtless its use in this field will be rapidly extended. The use of the gas in physical laboratories generally, and especially where certain investigations on the properties of matter are carried out, will also be greatly increased.

It has recently been proposed to use helium in place of oil for surrounding the switches and circuit-breakers of high-tension electric transmission lines. If the gas should prove suitable for this purpose, large quantities could be utilised, but it has yet to be demonstrated (and it is not clear

that it can be) that in this field helium possesses any advantage over the oils now used.

It has been suggested by Elihu Thomson and others that if divers were supplied with a mixture of oxygen and helium, the rate of expulsion of carbon dioxide from the lungs might be increased, and the period of submergence as a consequence be considerably lengthened.

It is probable, however, that in the field of low-temperature research helium will immediately find its widest application. For this work helium is unique in that, when liquefied and possibly solidified, it enables one to reach the lowest temperatures attainable. Every effort should be exerted towards the exploitation of its use in this direction.

One point that is important and should not be overlooked is that the supplies of natural gas from which helium can be extracted are being rapidly used up. When our natural gas fields are depleted it would appear that our main source of supply of helium will have disappeared. Careful consideration should, therefore, be given to the problem of producing helium in large quantities while it is still available, and of storing it up for future use. As already stated, it may be that in the future it will be of paramount importance to have even a moderate supply of the gas available.

#### *A Cryogenic Laboratory.*

To chemists and physicists especially, the discovery that helium can be produced in quantity at a moderate cost opens up a vista in the realm of low-temperature research of surpassing interest. By means of liquid oxygen, the properties of substances can be studied down to a temperature of  $-182.5^{\circ}\text{C}$ . Liquid nitrogen provides us with a temperature of  $-193.5^{\circ}\text{C}$ ., and hydrogen, which was originally liquefied in 1898 by Sir James Dewar, enables us to reach  $-252.8^{\circ}\text{C}$ . It is but a few years since Onnes, after prolonged effort, secured sufficient helium to enable him to liquefy this gas, too. In a brilliantly conceived research he succeeded in accomplishing this feat in 1908, and in doing it reached a temperature within approximately  $1^{\circ}$  or  $2^{\circ}\text{C}$ . of the absolute zero.

The amount of liquid helium which Onnes obtained in his investigation was small, but it sufficed to enable him to show that a number of the elements possessed a remarkable "super-conductivity" at this low temperature. Mercury in particular, at the temperature of liquid helium, possessed an electrical conductivity ten million times greater than at ordinary room temperature, and currents started by induction in a coil of lead wire at the temperature of liquid helium maintained their intensity for more than an hour with but little diminution in magnitude.

The results obtained by Onnes, although limited in number, are of great importance, for they show that if liquid helium were rendered available in quantity, fundamental information of the greatest value on such problems as those connected with electrical and thermal conduction, with specific and

atomic heats, with magnetism and the magnetic properties of substances, with phosphorescence, with the origin of radiation, and with atomic structure, could be obtained.

In spectroscopy supplies of liquid helium would enable us to extend our knowledge of the fine structure of spectral lines, and thereby enable us to obtain clearer ideas regarding the electronic orbits existing in the atoms of the simpler elements. This would lead naturally to clearer views on the subject of atomic structure generally.

In other fields, too, important information could be obtained by the use of temperatures between that of liquid hydrogen and that of liquid helium. What of radio-activity? Would this property be lost by uranium, thorium, radium, and other similar elements at temperatures attainable with liquid helium? Would all chemical action cease at these temperatures? Would photo-chemical action disappear completely? Would photo-electric action cease or be maintained at such low temperatures?

In the fields of biological and botanical research, information on problems pressing for solution could be gained also. For example, would all life in spores and bacteria be extinguished by subjecting them to temperatures in the neighbourhood of absolute zero?

The list of problems rendered capable of attack by the use of liquid helium might be easily extended; but those cited already will serve to show that the field is large, and that it is well worth while for us to make a special effort to secure adequate financial support for the equipment and maintenance of a cryogenic laboratory within the Empire.

It is probably beyond the ordinary resources of any university to equip and maintain such a laboratory; but the project is one which merits national, and probably Imperial, support. It should appeal to private beneficence as well, for it is a project deserving strong and sympathetic help.

A properly equipped cryogenic laboratory should include:

- (1) A liquid-air plant of large capacity.
- (2) A liquid-hydrogen plant of moderate capacity.
- (3) A liquid-helium plant of small capacity.
- (4) Machine tools, cylinders, glass apparatus, measuring instruments, etc.

Such an equipment would probably cost more than 10,000*l*.

For building purposes, probably an additional 10,000*l*. or 15,000*l*. would be required.

The staff should include one or two skilled glass-blowers, two or three mechanics and instrument-makers, and two or three helpers for running the machinery. To provide this staff and meet charges for light, heat, and power, probably 3000*l*. a year at least would be needed.

For an administrative and technical staff, probably 2500*l*. would be necessary.

In addition to the above, special provision would have to be made to secure an adequate supply of helium. If industrial uses can be found for helium and a works were established in

Alberta for the production of helium on a large scale, the problem of supply would be solved, for the amount of the gas which would be required for low-temperature research would probably not be more than 20,000 or 30,000 cubic feet a year. In default of a production-works on a large scale being established, it would be necessary to install a small plant at Calgary for the specific purpose of supplying the cryogenic laboratory with helium. This could easily be done at the present time, as the experimental plant is still *in situ*. It would require from 3000*l.* to 4000*l.* to make the changes in the plant which experience has shown are necessary, and to provide the additional auxiliary machinery, tools, etc., required.

If this plant were run for three or four months each year, an adequate supply of helium could be obtained. The expense of running the plant under these conditions would be high, and it would probably be found that it would require from 2000*l.* to 3000*l.* to operate it for a period of three or four months each year. This amount would, of course, have to cover charges for salary of staff, compensation to the owners of the natural gas, light, power, miscellaneous supplies, freight charges on cylinders, etc.

From the above it will be seen that a scheme such as that outlined would require in the aggregate a capital expenditure of about 30,000*l.* for buildings and plant, and the interest on an endow-

ment of about 125,000*l.* for operating and maintaining the cryogenic laboratory, together with the supply station.

If a cryogenic laboratory, with its auxiliary supply station, were established along the lines indicated, it would probably be found to be more economical to run the supply station continuously for a number of years, and to store for future use the helium accumulated. In this connection it should be stated that the experimental plant as it exists would probably not produce more than 100,000 cubic feet of helium per year. The plant could, however, be easily manifolded, and the Governments of Great Britain and Canada might, from the point of view of national safety, legitimately be asked to assume responsibility for operating it.

Much of our knowledge acquired in the field of low-temperature research we owe to the brilliant work of such distinguished men as Andrews, Davy, Faraday, and Dewar. The discovery of the rare gases, helium, neon, argon, krypton, and xenon, we owe to Lockyer, Rayleigh, Ramsay, and Dewar. How could we more fittingly perpetuate the work of these great men than by establishing on a permanent basis a cryogenic laboratory for the purpose of making still further progress in the field of low-temperature research—a field in which British men of science have made such brilliant and notable advances?

### The Cardiff Meeting of the British Association.

IT is twenty-nine years since the Association met in Cardiff. It is safe to say that any members who may have been present on that occasion will not now be able to recognise the city, for there can scarcely be any other town in the country which has not merely grown, but also altered, so much in that period. In 1891 there was on the north side of what is now one of the main streets a large tract of finely timbered ground called Cathays Park, adjacent to Cardiff Castle and its park, and also the property of the Marquess of Bute. In Cathays Park now stand a number of large and handsome public buildings, including the City Hall, Law Courts, University College, Technical College, and the National Museum of Wales. These are the buildings in which the meetings of the Association will take place, and not one of them was in existence at the time of the former meeting.

As usual, it is difficult to estimate the probable success of the meeting from the point of view of numbers, but locally every effort is being made to ensure it, and a good average meeting is expected. It is certain that the Association can never have been better provided in the matter of meeting rooms and lecture halls. The local arrangements are now almost complete. The housing shortage, particularly serious in Cardiff, and the fact that this is the holiday season have made the task of the rooms and hospitality committees

rather trying, but it has been accomplished, and ample accommodation will be available.

The reception room, general offices, post office, and luncheon and tea room are situated in the City Hall; Sections A, F, H, and L meet in the University College; Section G has the use of the South Wales Institute of Engineers close by; and all the other sections are accommodated in the Technical College. In the Technical College also there is an assembly hall for special meetings. The inaugural general meeting, evening discourses, and citizens' lectures take place in the Park Hall, which is near one corner of Cathays Park.

Regarding the programmes of the individual sections, little can be added to the account of them published in *NATURE* of July 15. The journal of sectional and other proceedings will be ready on the first day of the meeting, but has lost its right to the name, for it will not be published daily as hitherto. Members should therefore retain their copies throughout the meeting. Any alterations in the sectional programmes will be shown from day to day on the notice board in the reception room.

The inaugural general meeting will take place on Tuesday, August 24, in the Park Hall, at 8 p.m., when the president, Prof. W. A. Herdman, will deliver his address. On Wednesday there will be a reception by the Lord Mayor of



Cardiff at the University College at 8 p.m. The evening discourses by Sir R. T. Glazebrook and Sir Daniel Hall will be delivered in the Park Hall at 8 p.m. on Thursday and Friday respectively. The conference of delegates of corresponding societies will be held at 2 p.m. on Wednesday and on Friday in the assembly hall of the Technical College.

Three citizens' lectures will be delivered in the Park Hall at 8 p.m. on Monday, Wednesday, and Saturday, the lecturers being respectively Prof. J. Lloyd Williams ("Light and Life"), Prof. A. W. Kirkaldy ("Present Industrial Conditions"), and Dr. Vaughan Cornish ("The Geographical Position of the British Empire"). Members of the Association as such are not admitted to these lectures. The distribution of tickets, which are free, is in the hands of the Workers' Educational Association, and they may be obtained at the reception office during the meeting.

The programme of excursions is a varied one. The geologists are visiting Cefn On and Caerphilly on Tuesday, Penylan on Wednesday, the Barry Coast on Thursday, and Lavernock on Friday. Section E (Geography) will explore the Vale of Glamorgan on Wednesday, and the Taff and Rhondda Valleys on Thursday. The engineers will be shown over the Bute Docks on Tuesday, the Melingriffith Tinsplate Works on Wednesday, the Dowlais Steelworks on Thursday, and the Great Western Colliery on Friday. Section H (Anthropology) will investigate the Roman remains at Caerwent (between Newport and Chepstow) on Wednesday. A botanical expedition to Wenvoe

takes place on Thursday. The Section of Education will inspect the summer school at Barry on Friday. One or two demonstrations have also been arranged. On Wednesday Section I will be shown the new physiological laboratories of the University College, where a new electrokymograph will be demonstrated. On Thursday afternoon members of the Association, particularly those of Sections B, A, and I, are invited to the chemical laboratories of the Cardiff City Mental Hospital, where demonstrations will be given of some new chemical and physiological methods, and also of a modern high-powered X-ray installation equipped with auto-transformer and Coolidge tube. All these sectional excursions and demonstrations take place in the afternoons.

On Saturday, August 28, two general excursions of the Association will be made. One party will drive through the Wye Valley, taking lunch at Tintern and calling at Llanover, near Abergavenny, at the invitation of Lord Treowen, to take tea on the return journey. The other party will cross the Bristol Channel and visit the famous Cheddar caves, Wells Cathedral, and Glastonbury Abbey. The numbers in these excursions (and also in many of the sectional expeditions already mentioned) are limited. Members are requested to signify their intention of taking part in any of them as soon as possible after the beginning of the meeting. By so doing they will not only ensure their own participation, but also lighten the work of those responsible for organising the excursions, for in the present local conditions the difficulties of arranging transport are considerable.

### Obituary.

#### Sir Norman Lockyer, K.C.B., F.R.S.

THE death of Sir Norman Lockyer on Monday last deprives the world of a great astronomer, and the nation of a force which it can ill afford to lose. Though it had been known for several months that Sir Norman was in a feeble state of health, his many friends cherished the hope that the vigour which was characteristic of him would revive, and that the devoted attention of his wife and daughter would preserve him to us for a few more years; but this was not to be. The alert mind and acute understanding which influenced so many men and advanced so much scientific work over a period of sixty years or so are now at rest, yet there remains to us a recollection which will not soon be effaced, and there stands in the archives of science a record of his achievement which will command admiration so long as the pursuit of knowledge is regarded as worthy human endeavour.

In the jubilee issue of NATURE in November last Dr. Deslandres, Sir Archibald Geikie, Sir Ray Lankester, and other distinguished men of science paid tribute to the work and influence of the founder of this journal, the volumes of which form an enduring monument to his memory.

Sir Norman was not only a pioneer worker in the fields of science, but also an advocate of the claims of science to recognition in modern polity, and this rare combination was used to further scientific interests as well as to secure the progress of knowledge. He was the embodiment of mental activity, and never relinquished a task to which he had put his hand. Until a short time ago he was as eager to learn of developments and discoveries in astronomical work, and as ready to suggest new lines of research, as a man in the prime of life, and it is difficult to realise that this fund of energy is now no longer available to those of us who derived benefit from it. When Goethe wrote: "The quickening power of science only he can know from whose soul it gushes free," he must have had in mind a researcher of the type of him whose loss we now mourn.

Sir Norman Lockyer was born at Rugby on May 17, 1836. He was educated at various private schools, and in 1857 received an appointment at the War Office. His work there was so much appreciated that in 1865 he was entrusted with the editorship of the Army Regulations. In 1870 he was appointed secretary of the Duke of Devonshire's Royal Commission on scientific

instruction and the advancement of science. The reports of this Commission are most valuable records of the position and needs of science, and if the recommendations had been put into force this country could easily have been in advance of all others as regards scientific development. When the work of the Commission was completed in 1875 Sir Norman was transferred to the Science and Art Department. He afterwards became professor of astronomical physics in the Royal College of Science, and was director of the Solar Physics Observatory at South Kensington from 1885 to 1913. He was elected a fellow of the Royal Society in 1869, was Rede lecturer to the University of Cambridge in 1871, and Bakerian lecturer to the Royal Society in 1874, in which year he received the Rumford medal of the society. In 1875 the Paris Academy of Sciences elected him a corresponding member in the section of astronomy. He was a corresponding member of numerous national scientific societies, and honorary member of many others. He received honorary degrees from the Universities of Oxford, Cambridge, Glasgow, Edinburgh, and Aberdeen, and the Order of Knight Commander of the Bath was conferred upon him by the King in 1897.

Sir Norman Lockyer's early spectroscopic work was devoted to the sun. His first observations were directed to a scrutiny of the spectrum of sunspots as compared with that of the general surface. In the course of the paper in which these observations were described, read before the Royal Society on November 15, 1866, he remarked:—"May not the spectroscopist afford us evidence of the existence of the 'red flames' which total eclipses have revealed to us in the sun's atmosphere, although they escape all other modes of examination at other times?" The spectroscopist he then employed proved to be of insufficient dispersive power for his researches, but by the aid of the Government Grant Committee of the Royal Society an instrument of greater power, though not quite complete, was obtained on October 16, 1868. Four days later his efforts were crowned by the detection of a solar prominence by means of the bright lines exhibited in its spectrum. An account of this discovery was immediately communicated to the Royal Society and to the Paris Academy of Sciences. Meanwhile had occurred the total solar eclipse of August 18, and Dr. Janssen, who had observed with eminent success the spectrum of the prominences during the eclipse, came to the conclusion that the same mode of observation might enable one to detect them at any time, and he saw them in this manner the next day. The first account of the discovery, which was sent by post, reached the Paris Academy a few days after the communication of Sir Norman Lockyer's observation of October 20, and, as was described in NATURE of May 20 last, a medal was struck in honour of the joint discovery.

This notable application of the spectroscope revealed the prominences as local disturbances in

the continuous luminous layer which Sir Norman Lockyer called the chromosphere, and from the field of research opened by his discovery rich harvests have since been reaped. The gas, named by him helium, commonly occurring in solar prominences, was not isolated on the earth until twenty-seven years later, when Sir William Ramsay extracted it from the mineral clèveite. Now, as Prof. McLennan has described in these columns, it is possible to obtain millions of cubic feet of helium per day from natural gas in Alberta, and there is every reason to believe that this supply will become of immense scientific and industrial value.

It is beyond the bounds of this general record of Sir Norman Lockyer's scientific services to venture into the field of astronomical physics which he made particularly his own. An appreciative account of that work will be contributed to a later issue by a spectroscopist familiar with its special significance and value. Here we need only remark that Sir Norman's meteoritic hypothesis of celestial evolution is chiefly responsible for the change of view which has taken place as to the nature of nebulae and the existence of stars of increasing as well as of decreasing temperatures. Dark nebulae—sheets or streams of non-luminous cosmic dust—are no longer considered hypothetical, but are as real as dark stars, and the incipient luminosity of nebulae in general represents the visible portion only of vastly more extensive congeries of invisible cosmic matter. Some of the most noteworthy discoveries of astronomical science in recent years are, indeed, those which suggest or demonstrate that space may include as much dark matter as bright, and they largely owe their origin to Sir Norman Lockyer's meteoritic hypothesis and the classification of stellar types based upon it.

In his work and conclusions upon the subject of dissociation, Sir Norman Lockyer was likewise much in advance of his times. Fifty years ago he was convinced by his spectroscopic observations that the view that each chemical element had only one line spectrum was erroneous, and that the various terrestrial and solar phenomena were produced by a series of simplifications brought about by each higher temperature employed. In his studies of dissociation he was really collecting facts concerning the evolution of the chemical elements, and he pointed out especially that the first steps in this evolution were probably best determined by observations of stellar spectra.

Sir Norman Lockyer was the chief of eight British Government solar eclipse expeditions, and organised the programmes of several others while director of the Solar Physics Observatory. His use of the slitless spectroscope during the eclipses from 1871 onwards provided a wealth of information for study. From the photographs obtained during the total solar eclipse of 1893 the wave-lengths of many chromospheric and coronal lines were determined, and a very complete series of pictures and spectra of the corona and chromosphere was obtained during the

eclipse of 1898, the true wave-length of the chief corona line being then determined as 5303.7. Further knowledge was secured from the eclipses of 1898, 1900, and 1905, and it was all brought into relationship with the laboratory work and discussions of stellar types carried on at the Solar Physics Observatory.

When the first Solar Physics Committee was appointed in 1879, reference was made to the desirability of an inquiry into the possible effect of solar conditions on meteorological phenomena, but it was not until 1898 that Sir Norman Lockyer undertook, with his son, Major W. J. S. Lockyer, a definite and searching inquiry into the most trustworthy meteorological records, with the view of discovering indications of solar influence on weather factors. It was established that the oscillations of annual pressure in South America are closely related to those of the Indian Ocean, but inverse in character, high pressure years in India being represented by low pressure years in Cordoba. This "see-saw" phenomenon was found to hold good for numerous other districts, and its importance for long-period forecasting is now being recognised. Drs. Helland-Hansen and Nansen refer particularly to the work of Sir Norman and Major Lockyer upon this subject in their valuable memoir noticed in *NATURE* of August 5, p. 715.

A report on the work of the Solar Physics Observatory during the period 1889-1909 was issued by Sir Norman Lockyer when the Solar Physics Committee was dissolved and the observatory transferred to Cambridge. This abrupt break in his life's work was acutely felt by Sir Norman, and he never really recovered from its effects, though he was as keen as ever upon progress in astrophysics. What he desired particularly was that the observatory should be transferred to a site which would permit increased opportunity for observation, and when, to his great disappointment, the institution to which he had devoted so many active years was summarily reorganised without consideration for his interests in it, and placed in a position little better than that which it had long occupied under his directorship, his hope for the development of astrophysical researches started at the observatory received a sudden and pathetic check.

Obstacles were, however, always used by Sir Norman Lockyer as opportunities. When the Solar Physics Observatory was taken from South Kensington to Cambridge in 1913, and his official connection with the observatory ceased, he devoted himself to erecting a new observatory at Salcombe Regis, Sidmouth, where he spent his declining years. Later, the Hill Observatory Corporation was formed to promote the development of this observatory and to carry on its work permanently. Sir Norman and Lady Lockyer gave the site of seven and a half acres upon which stand the present buildings, and there is ample room for extension, while the position of the observatory is as fine as could possibly be desired. Thanks chiefly to Sir Norman's gifts

of instruments and to the generosity of Lt.-Col. Frank McClean, Mr. Robert Mond, and others, the observatory is already one of the best equipped in the country, and it could become one of the best in the world if wealthy benefactors here were as much interested in the promotion of astronomical science as they are in the United States, where the most notable work is now being done in astrophysics. No memorial to Sir Norman Lockyer could have a more appropriate object than that of providing means to increase the staff and develop the work of the Hill Observatory.

Sir Norman Lockyer's archaeological observations are not so well known as they should be, for most of them belong to the first rank. In continuation of his work on the astronomical uses of Egyptian temples, he turned his attention to some of the stone circles and other stone monuments in this country, and he was able to establish the conclusion that such monuments were built to observe and mark the rising and setting of the sun and other heavenly bodies at different times of the year. The date of construction of Stonehenge was thus found to be between about 1900 and 1500 B.C., and it appeared that a thousand years before circles were built in Cornwall, commencing about 2400 B.C., avenues were erected in other parts of Britain.

When president of the British Association in 1903-4, Sir Norman Lockyer delivered at the Southport meeting a notable address on "The Influence of Brain-power on History." This address attracted wide attention, but the nation was not then ready to learn the lesson taught by it, and it has taken the greatest war of all time to awaken national consciousness to its significance. A strong plea was made to prepare by intellectual effort for the struggles of peace and of war, and it was added:—"Such an effort seems to me to be the first thing any national or Imperial scientific organisation should endeavour to bring about." Sir Norman Lockyer hoped that the British Association would expand one of its existing functions and become the active missionary body adumbrated in his address; but his appeal did not meet with the active support he expected from the council, most of the members of which were more interested in scientific work itself than in national aspects of it. With characteristic energy, however, Sir Norman set himself the task of establishing an organisation which would bring home to all classes of the community the necessity of making the scientific spirit a national characteristic to inspire progress and determine policy in affairs of all kinds, and as a result the British Science Guild was founded in 1905.

Throughout his career Sir Norman Lockyer's public activities made contact with national life at many points, and the British Science Guild is an institutional representation of them which remains to attain the objects at which he consistently aimed. The purpose of the Guild is to stimulate not so much the acquisition of know-

ledge as the appreciation of its value, and the advantage of applying the methods of scientific inquiry in affairs of every kind. Such methods are not less applicable to the problems which confront the statesman, the administrator, the merchant, the manufacturer, the soldier, and the schoolmaster than to those of the scientific worker. These were the convictions of Sir Norman Lockyer, and he had the satisfaction in recent years of hearing them proclaimed from the house-tops, while the Guild itself stands as a monument of their power and his prescience.

In 1904 a large and influential deputation urged upon Mr. Balfour, then Prime Minister, the need for further assistance to university education and research, and in announcing that the grant would at once be doubled, as well as redoubled in the following year, Mr. Balfour stated that the increase, which represented a capital sum of 3,000,000*l.* at 2½ per cent., was given as the result of the appeal made in 1903 by Sir Norman Lockyer in his presidential address to the British Association at Southport. This represents one result only of his ceaseless activity on behalf of science and higher education; the pages of NATURE throughout its existence afford ample testimony of the use of the same zeal for progress.

"There must," he once said, "be only one kind of education—the best—and that is to be given to everybody." He expected the best work from everybody associated with him, and would not tolerate any lower standard for either individual or national aims. His fingers have now loosed their grasp upon the torch of science which he held aloft for so many years, but the light still burns on the bank of the dark river he has crossed; and in admiration, hope, and reverence it will be borne onwards by workers whom he inspired. His body will be laid to rest on Saturday morning at Salcombe Regis Church, Sidmouth, but his spirit will remain in the observatory on the hill-top near-by to stimulate others to reach out and touch the sky.

Sir Edward Brabrook writes:—

Among the many who have been honoured by the friendship of Sir Norman Lockyer and are in sorrow at his death, I count myself, as having had opportunities of being associated with him in more than one capacity. I was one of those members of the Civil Service whom he invited to join with him in a welcome to Mowatt, of the Treasury, on the occasion of his election as a member of the Athenæum. In the year when Sir Norman presided over the British Association, I was one of the sectional presidents, and was nominated by him as a member of the council. I warmly sympathised with the wishes he then entertained for the extension of the functions of the association, and when these were seen to be not realisable in the form in which he desired them, I accepted his invitation to join in the formation of the British Science Guild. Others will be better able than I to tell the story of his labours for that institution, and

of the success that has attended them; but I may say a few words on another aspect of his untiring intellectual work, viz. his contributions to archaeology. In this respect he was an example of the interdependence that exists between the sciences, for it was the pursuit of his favourite science of astronomy that gave the direction to his studies of ancient civilisation. In the temples of Egypt and in the stone circles of our own country he found evidence of the astronomical knowledge and purpose with which they were erected, and his own profound acquaintance with the problems they presented to him from that point of view led him to conclusions which, as in the case of fixing the date of Stonehenge, were closely verified by the evidence afterwards derived from excavations on the spot.

AGRICULTURAL chemistry has lost a distinguished exponent by the death of PROF. EDWARD KINCH on August 6 at the age of seventy-one. Prof. Kinch was educated at the Grammar School, Henley-on-Thames, and the Royal College of Chemistry, and successively occupied the following positions:—Chief assistant to the professor of chemistry (the late Sir Arthur Church) at the Royal Agricultural College, Cirencester, 1869-73; on chemical staff of Royal School of Mines, 1873-75; superintendent of minerals, India Museum, 1875-76; professor of chemistry, Imperial College of Agriculture, Tokyo, 1876-81; professor of chemistry, Cirencester, 1881-1915, when the Royal Agricultural College closed on account of the war. He published many technical papers on agricultural chemistry, in which he was a leading authority, always distinguished by the soundness of his judgment. As a teacher Prof. Kinch did much for his subject both in this country and in Japan, and he will be remembered with respect and affection by many generations of students and numerous former colleagues. His life was saddened by the premature death of his young wife (a daughter of the late Rev. Geo. Huntington), whom he married in 1889, and after this he led a somewhat retired life. Those privileged to be his intimate friends will not easily forget his many sterling qualities and quiet sense of humour.

J. R. A.-D.

WE regret to note that the death of MR. JOHN KIRKALDY is announced in *Engineering* for August 13. Mr. Kirkaldy was born in 1853, and was head of the well-known London firm of John Kirkaldy, Ltd. Quite early in life he took over the management of his father's business, and under his direction the firm played an important part in introducing fresh-water distilling apparatus for use on board ship. Plant of this kind was also designed for use in the Ashanti campaign, and in 1883 and 1885 in connection with the Egyptian campaigns. Mr. Kirkaldy was a member of the Institution of Civil Engineers, and also of the Institution of Mechanical Engineers.

## Notes.

ARCHÆOLOGISTS will fully appreciate the announcement that one of the first official acts of the new High Commissioner of Palestine has been the establishment of a Department of Antiquities. An International Board will advise the director on technical matters. Provision is made for an inspector, for a museum, and for the custody of the historical monuments. The museum starts with more than 100 cases of antiquities collected by the Palestine Exploration Fund and other bodies before the war. On August 9 the new British School of Archaeology was formally opened at Jerusalem by Sir Herbert Samuel.

At the council meeting of the National Association of Industrial Chemists, held at Sheffield on August 7, the hon. secretary reported that a number of firms had given a definite undertaking to consult the officials of the association in all matters relating to chemists, their appointment, salaries, and conditions of employment. On the whole, the salaries paid to members of the association were fairly satisfactory; in this connection a report had been issued giving a schedule of minimum salaries, and this would be circulated shortly. The hon. secretary took a gloomy view of the future before industrial chemists. He stated that the number of unemployed was increasing rapidly, and there was every indication of a coming great slump in the engineering and allied industries in which their members were employed. It was more than ever imperative for industrial chemists to unite to preserve their interests. Mr. A. B. Searle (Sheffield) was unanimously elected president for the coming year, and Mr. J. W. Merchant appointed secretary. The proposal to appoint an organising secretary for propaganda work was also carried.

A MEMORIAL has been presented to the German National Assembly urging the formation of an Imperial Chemicotechnical Test Laboratory, which it is recommended should be formed from the Military Test Bureau which existed during the war. According to a report in the *Zeits. des Vereines deutscher Ingenieure* for May 20, it is suggested that the functions of the new laboratory should be, *inter alia*, the execution of scientific and technical investigations relative to raw materials, and particularly (1) the production of materials of importance to the public, e.g. spirit from wood and acetylene instead of from potatoes, and of fatty acids from the products of coal- or lignite-tar or paraffin, and the utilisation and improvement not only of cellulose as a substitute for cotton, but also of ammonium nitrate obtained synthetically in large quantities as a fertiliser; and (2) the determination of substitutes for chemical and metallurgical products not available in the country or of which there is a shortage, i.e. substitutes for paraffin, camphor, and glycerine, for substances used in the preservation of leather and metals, also substitutes for lubricants, rubber, gutta-percha, etc. In addition, the proposed new institute would carry out researches of general interest, e.g. on rust-prevention and the corrosion of metals, on the determination of

stresses in internal-combustion engines, on the effect of winter cold and upper-air temperatures on implements and raw materials, and on the testing and improvement of aeroplane and airship fabrics. It is also suggested that scientific and technical investigations should be carried out dealing with the prevention of accidents and the protection of workers in a number of important industries.

THE autumn meeting of the Institute of Metals will be held at Barrow-in-Furness on September 15-16, under the presidency of Sir George Goodwin.

WE have received the quarterly report of the Research Defence Society containing an account of the annual general meeting. The Jenner Society has become affiliated to the society, and its hon. secretary, Dr. Drury, has joined the committee. At the close of the meeting Col. McCarrison gave an address on "Vitamines," an abstract of which is published in the report.

*Medical Science: Abstracts and Reviews* for August (vol. ii., No. 5) contains a review of recent work and articles upon "lethargic encephalitis" (see NATURE, January 1, p. 452), a disease which appeared in this country at the commencement of 1918. Cases have been reported in almost every European country and in Africa, India, the United States, and Canada. Netter points out that descriptions of a similar disease are given by Hippocrates, Aretæus, and Cælius Aurelianus, and the works of Celsus contain a chapter on "lethargic fever." Sydenham in the seventeenth century also gave a description of the same kind of disease under the name of "comatose fever." It appears reasonable to suppose, therefore, that this disease is not new, but has been in abeyance for seventy years or more. No causative organism has yet been discovered.

ON the occasion of the opening of the third laboratory of the Liverpool School of Tropical Medicine on July 24 (see NATURE, July 29, p. 696) the Liverpool University Press issued a volume (103 pp., 37 plates) giving an account of the inception of the School and its history from that time up to the present. In addition to the records of the important contributions of the School to the advance of our knowledge of tropical diseases, the volume records the benefactions which have enabled the School to develop and to perform its functions so successfully. Among recent developments may be mentioned the establishment of research laboratories at Manáos and at Sierra Leone, where continuous investigations into the diseases of these localities can be carried on. We join in the confident hope expressed that the city of Liverpool and those "whom destiny binds in diverse ways to tropical lands" will continue to support the School.

THE Research Defence Society has issued a paper by Major-Gen. Sir David Bruce on the prevention of tetanus during the Great War by the use of antitetanic serum. Sir David Bruce states in his introduction that the object of this paper is to controvert the assertions of the supporters of anti-vivisection in regard to tetanus, and to prove that antitetanic serum

is of the greatest use in preventing the onset of the disease, and if not successful in this, in mitigating the severity of the symptoms and lessening the death-rate. Statistics of the incidence of tetanus among the wounded sent home, about 1,242,000, are given; there were among them 1458 cases of tetanus, a ratio of about 1 per 1000. In September, 1914, 6000 wounded men were landed in England, and 514 men wounded in that month were attacked by tetanus, a ratio of 9 per 1000. In November, 1914, there was a sudden drop to a ratio of 2.3 per 1000, and the ratio never afterwards exceeded about 2.7, and was frequently less. This sudden drop coincides with the systematic inoculation of all the wounded with antitetanic serum. The case-mortality per cent. of those who developed tetanus was 53.5 among those unprotected with antitetanic serum, and 23.0 among those who received a preventive injection of the serum. The use of antitetanic serum also markedly lengthened the incubation period of the disease, and the longer the incubation period, the milder does the disease tend to be. With a long incubation period the disease frequently assumes a localised form in the neighbourhood of the wound, and while in 1914 the percentage of cases of the acute and generalised form was 98.9 and of the local form 1.1, in 1918 the respective figures were 83.5 and 16.5. Sir David Bruce concludes, therefore, that by the preventive use of antitetanic serum (1) the incidence of the disease is lowered ten to twelve times; (2) the incubation period is lengthened four or five times; (3) the disease becomes milder, many of the cases showing only local manifestations; and (4) the death-rate is lowered fourfold.

FOUR specimens of Gephyrea were taken from the stomachs of fish at two widely separated stations by the Canadian Arctic Expedition, 1913-18. These are referred by Mr. R. V. Chamberlin (Report of the Expedition, vol. ix., Part D, 1920) to the widespread northern *Priapulid humanus*. A short account is given of other Canadian Gephyrea, which represent six species—the *Priapulid* already mentioned and five *Sipunculids*, one of which is a new species of *Phascolosoma*. The author appends a useful, but not quite complete, bibliography of the Gephyrea containing the titles of about 430 works.

THE remarkable habits of the sage grouse form the subject of a brief but valuable essay by Mr. Bruce Horsfall in *Zoologica* (vol. ii., No. 10), the organ of the New York Zoological Society. One of the most striking features of the displays described is the use of the wings in thrusting forward the inflated air-pouch, which plays a prominent part in the performance. The author contends that these displays are not "courtship" antics, because no notice was taken of one or two females which "meandered through the throng" while the performance was in full swing. But since the breeding season seems only just to have begun, one feels inclined to doubt the validity of this interpretation. A number of unusually good text-figures and a coloured plate add greatly to the value of this most welcome addition to our knowledge of the ecology of the sage grouse.

NO. 2651, VOL. 105]

THE nesting of the bee-eater in Scotland is an event in the annals of British ornithology which is indeed worthy of record, and we are greatly indebted to Mr. J. Kirke Nash for his carefully kept notes thereon which he publishes in *British Birds* for August. A pair of these birds were first seen on June 3 perched on a wire fence surmounting a sand-bank of the River Esk, near Musselburgh. When discovered they were engaged in catching flies, after the fashion of the flycatcher. On June 7 they were found entering and leaving a hole in the bank, and as the male was seen feeding his mate it was clear that they were nesting. On June 13, however, the female fell a victim to the stupidity of a gardener, who captured it, placed it in a greenhouse, and "fed" it on breadcrumbs. Needless to say, it died within two days, after laying an egg. A few days later the unfortunate survivor was caught and killed by a cat.

DR. B. H. RANSOM contributes to the Proceedings of the United States National Museum (vol. lviii., pp. 527-73, 33 figs., 1920) a synopsis of the Trematode family Heterophyidae, with descriptions of a new genus and five new species. This family is composed of a number of genera of small Trematodes, usually not more than 2 mm. long, parasitic in the intestine of mammals and birds, usually fish-eaters. Two of these flukes, *Heterophyes heterophyes* and *Metagonimus yokogawai*, occur in the small intestine of man—the former in Egypt, China, and Japan, and the latter in Formosa, Japan, and Korea. These occur also in the dog and cat, and five other flukes of this family have been recorded from these animals. The author gives a key to the characters of the nine genera which he recognises as valid, and also supplies the necessary keys to the species.

THE first annual report of the Industrial Fatigue Research Board (H.M. Stationery Office) contains an interesting record of work completed or in progress. Of the four reports already issued that of Dr. Vernon dealing with the influence of hours of work and ventilation on output in the tinplate industry is the most extensive, while the report by Mr. Major Greenwood and Miss Hilda Woods upon the incidence of industrial accidents (the statistical theory of this investigation has been further developed in a paper by Messrs. Greenwood and Yule published in the March, 1920, issue of the Journal of the Royal Statistical Society) suggested some important problems which the Board proposes to study further. Mrs. Osborne's paper on the output of female munition workers and Dr. C. S. Myers's analysis of the results obtained in a factory after the introduction of motion study are also of interest. Amongst investigations not yet completed, that on the relation between length of shift and fatigue in the iron and steel industry, entrusted to Dr. H. M. Vernon, is almost ready for publication, and progress has been made with inquiries into special conditions affecting the cotton, boot and shoe, and silk industries. The Board has a large number of tasks in hand, and it is yet too early to decide which are likely to be most remunerative. It is, however, clear that careful thought has been

devoted to the organisation of research, and we have no doubt that the outcome will be of the greatest benefit to both employers and employed.

COPIES of new editions of several pamphlets in the Economic Series published by the Natural History Museum have come to hand. No. 1 on the house-fly (*Musca domestica*) by Major Austen is in its third edition, and has been enlarged and almost entirely rewritten. It deals with the house-fly under normal conditions in the British Isles; those who desire further information, including Army requirements, should consult the larger pamphlet, No. 1A, in the same series. The illustrations are exceedingly clear, and several of these, along with the letterpress, will help to distinguish the commoner house-frequenting flies from the true house-fly, which they closely resemble. *Musca autumnalis* is a case in point; it frequently enters houses, etc., and hibernates therein during the winter, giving rise to the popular belief that the winter habits of *M. domestica* are well known. The latter feature, however, is one concerning which we need much more extensive observation than has been accorded to it in the past. The breeding habits of the house-fly are also dealt with, and simple remedial and preventive measures against this pest are enumerated. No. 3, by Mr. J. Waterston, deals with fleas and their relation to man and domestic animals. It is noteworthy that eleven species have up to the present proved capable of transmitting plague. Five of them are common in Britain, while the plague-flea *par excellence* (*Xenopsylla cheopis*) is occasionally introduced. No. 4, on mosquitoes, is written by a recognised student of the family, Mr. F. W. Edwards. The relation of these insects to disease and the control measures in vogue are clearly explained. No. 6, by Mr. H. Hirst, deals with scorpions, mites, ticks, spiders, and centipedes in so far as they may be injurious to man. Nos. 3 and 6 are reprints, without alterations, of their predecessors, and No. 4 differs from its original edition only in a few small additions to the letterpress.

AN interesting account of the development of the mica industry in Eastern Transvaal during the last ten years is given by Mr. A. L. Hall in Memoir 13 of the Geological Survey of the Union of South Africa (1920). The "books" of mica that are of economic value occur as constituents of coarse-grained pegmatites which cut the older granite of the Pietersburg district. The memoir gives a review of the uses of mica and of the qualities and occasional defects that must be considered from a commercial point of view.

MR. SEITARÔ TSUBOI has published a complete study, structural and petrographical, of the island volcano of Oshima, the largest of the "Seven Islands" group south-west of the Bay of Tokyo (Journ. Coll. of Sci., Imp. Univ. Tokyo, vol. xliii., May 10, 1920). Incidentally, he introduces a method for the determination as nearly as possible of the maximum and minimum refractive indices of minerals represented by minute crystal grains, by using a large number of grains immersed in various liquids above a Nicol.

NO. 2651, VOL. 105]

The great crater-ring formed by ancient ejecta is now dominated by the recent central cone of Miharayama, which is still active. The author is not afraid of technical terms, and concisely describes the volcano as consisting of "double homates—a somma and a central one," and as "built up of numerous layers alternately accumulated of rheumatitica and clasmatica of basaltic nature."

MR. H. VALENTINE DAVIS sends us a copy of his "Little Book about Snowdon," published by him at Wistaston, Crewe. This is illustrated with sketches, sketch-maps, and sections drawn to the same vertical and horizontal scale, which should do much to interest the visitor to Llanberis in the many features of scientific interest that are so well displayed on Snowdon. It is a forerunner of a larger guide-book, and hence only the Llanberis path is treated as a route to Y Wyddfa. Without being didactic, Mr. Davis introduces the right touches at the right points, and gives just enough to make the reader think. The section showing the descent of the erratic maen d'ur arddu from the back of the cwm contains a lot of glacial lore, and might well be enlarged as a typical diagram of cirque-formation for the class-room. This alone is worth the sevenpence charged (*Sd.* post free) for this unassuming but effective little pamphlet. Will Mr. Davis consider in the quiet of "Noddfa" whether he or his printers are responsible for "Grib Goch" (regularly repeated), "ffynon," and "carreg"?

THE latest issue of the Journal of the Royal Statistical Society (vol. lxxxiii., part iii.) contains an interesting paper by Mr. M. S. Birkett, statistical officer of the National Federation of Iron and Steel Manufacturers, on "The Iron and Steel Trades during the War," which brings out very clearly the efforts made by this industry to produce the enormous supply of munitions of war that were needed for the great struggle. The author makes it clear that it was the character rather than the quantity of material produced that had to be modified. Thus in 1913 the total production of pig-iron was about 10,250,000 tons, which had fallen in 1914 to just under 9,000,000 tons, and remained approximately stationary at that figure throughout the war. The classes of pig-iron used essentially for steel-making, namely, hæmatite and basic, had, however, risen from 58 per cent. to 72 per cent. of the total, by far the biggest increase being in the latter class, the output of which in 1918 was 50 per cent. above that of 1914. There was a corresponding increase in the output of steel, which reached 9,500,000 tons in 1918, an increase of 1,700,000 tons over 1914, the bulk of the increase again being in basic steel, of which there was above 50 per cent. more made in 1918 than in 1914. It is interesting to note that there were employed on the blast furnaces 39,200 men in July, 1914, as against 54,900 in July, 1919, so that the efficiency of the men employed had gone down very considerably. The total numbers employed in the industry at those two dates were 304,000 and 376,300 respectively, or, deducting those employed on blast furnaces, ironfounding, and tinplate manufacture,

which are given separately, 178,400 and 235,700 respectively, an increase of nearly one-third; by far the larger number of these were undoubtedly engaged in steel manufacture. The paper deals also with the production of iron and steel in France and in the United States, and includes an interesting table of the production and export of iron and steel in the chief iron-producing countries of the world, which shows strikingly the amount of loss that the war has inflicted upon the German iron and steel industries.

HONG-KONG Royal Observatory has recently issued its report for the year 1919, under the directorship of Mr. T. F. Claxton. The report deals mainly with meteorology, but it includes in a general way the magnetic elements and time services, with the necessary astronomical observations for the latter. In the description of the various meteorological instruments in use a doubt is thrown on the relation between the temperatures in the thermograph shelter and the hourly readings by the rotation thermometers, and it is stated that the difference is not constant throughout the day. Details of the comparison would be useful and interesting. In addition to the automatic records, eye observations of the same elements are said to be made each hour; perhaps less frequent eye observations would be sufficient, and time thus saved might with advantage be devoted to a discussion of clouds, the character and direction of which are said to be observed every three hours. Attention is directed to the large departures from normal from month to month in atmospheric pressure, temperature, and wind. A typhoon on August 22 occasioned a squall at the rate of 84 m.p.h., although the centre of the disturbance passed about 150 miles to the south-west of Hong-Kong. The greatest rainfall in twenty-four hours was 4.80 in. on July 5, and the greatest in one hour was 1.35 in. between 5 and 6 a.m. on October 1. The total rainfall for the year at the observatory was 76.14 in., of which 49.92 in. fell in June, July, and August; and in these months, in the heaviest rains occasioning floods, 38.79 in. fell in 186 hours. Seventy-one per cent. of the daily weather forecasts are said to have been completely successful. Meteorological logs were received from eighty-one ships operating in the Far East, representing 2587 days' observations. It would be a valuable asset for aeronautics if observers could be encouraged to give especial attention to cloud observations; marine and aeronautic meteorology are becoming closely interlocked.

THE June issue of *Terrestrial Magnetism and Atmospheric Electricity* contains Capt. J. P. Ault's preliminary results of the magnetic observations taken on the United States Magnetic Survey ship *Carnegie* during her voyage from Buenos Aires to St. Helena in February and March last. According to the new measurements, the deviation of the compass and the dip as given on the most recent British Admiralty Chart No. 3775 are in many cases  $1^{\circ}$  out in the deviation and  $2^{\circ}$  or  $3^{\circ}$  out in the dip. The most serious differences are to be found in the region between  $45^{\circ}$  south latitude  $329^{\circ}$  east longitude, and  $36^{\circ}$  south  $354^{\circ}$  east, where the British chart gives

the deviation to the west too small by about  $1^{\circ}$ ; while over the region  $33^{\circ}$  south  $2^{\circ}$  east to  $16^{\circ}$  south  $8^{\circ}$  east the dip is given between  $2^{\circ}$  and  $3^{\circ}$  too small. The horizontal intensity given on the chart is everywhere too large by about one unit in the second decimal place of the value in C.G.S. units.

THE Journal of the Torquay Natural History Society, vol. ii., No. 6, has just reached us. Among other interesting papers is one on the scientific correspondence of Charles Kingsley and William Pengelly. An account of the life of Charles Kingsley is given, together with extracts from letters written by him between 1867 and 1870 to William Pengelly. Points of natural history, mostly of a geological nature, were raised in these letters. Another paper of interest is "Mendelism and Selection." The results of recent experiments by Prof. Castle are discussed in terms of germ-plasm with the view of reconciling Mendelism with selection. In yet another paper some account is given by Mr. H. G. Lowe of the origin of the needle; its history is traced back through three needle-like implements which have been found while excavating in Kent's Cavern. The view taken is that the discovery of the needle marked the first step in man's struggle from a purely animal state of existence.

MESSRS. GAUTHIER-VILLARS, of Paris, are publishing a series of works of great men of science entitled "Les Maîtres de la Pensée Scientifique," with the object of making the original works known to scientific students. We have received four volumes containing writings of Lavoisier, Huygens, and Spallanzani, each including a short biographical note on its author. "Mémoires sur la Respiration et la Transpiration des Animaux," by Lavoisier, is a collection of four papers read to the Académie des Sciences between 1777 and 1790. The text is taken from the Mémoires of the society for the appropriate years. "Traité de la Lumière," by Huygens, is reprinted from the original work published in 1690, with some necessary alterations in spelling and punctuation. The two volumes entitled "Observations et Expériences faites sur les Animalcules des Infusions," by Spallanzani, are copies of a translation of the original work by Jean Senebier published at Geneva in 1786. The diagrams included in the translation are not reproduced. When the series is completed it will serve as a ready means of access to the works of men prominent in the history of science, and it should be particularly valuable to the student by giving him an opportunity of learning at first hand the methods and arguments by which scientific knowledge has been advanced.

MESSRS. SIFTON, PRAED, AND CO., LTD., promise for the autumn publishing season an illustrated volume by Miss Gardner King on the present condition of the inhabitants of the Fiji Islands, based upon the author's experiences among them shortly before the war. Miss King lived much among the natives in their own homes, and should therefore have an interesting story to tell.



**Our Astronomical Column.**

**TEMPEL'S COMET.**—M. Fayet has given a very probable explanation of the discordance of the Kudara observation of this comet on May 25. He finds that its true R.A. on that day was exactly 2h. greater than the Kudara one, the declination being correct. Hence the alteration of a single figure in the announcement, which may have been set down wrong by inadvertence in preparing the message for telegraphic transmission, will make everything accordant, and further explain the fact that whereas Mr. Kudara stated that the comet was visible in a small telescope, many European observers searched in vain round the position indicated. The calculated daily motion on May 25 is +3m. 34s., N. 8', which agrees fairly well with the observed value +3m. 4s., N. 8'; the latter was probably deduced from observations extending over an hour or two. The following positions have been announced:

G.M.T.		App. R.A.		App. S. decl.		Observer	Place
d. h. m.	h. m. s.	h. m. s.	° ' "	° ' "	"	"	"
May 25	7 10 0	22 55 7	0 45 3	0	"	Kudara	Kyoto
July 20	14 5 6	1 52 49	1 17 0	0 7	"	Michkovitch	Marseilles
	21 13 55	1 55 14	1 44 1	18 58	5	"	"
	21 13 12	1 55 8	6 10 1	18 43	"	Mundler	Königstuhl
	22 14 35	1 57 37	5 12 1	2	"	Polit	Barcelona
	24 13 40	2 2 10	6 3 1	26 5	2	Mundler	Königstuhl

The first R.A. is conjecturally increased by 2h. The following is a continuation of the ephemeris for Greenwich midnight:

		R.A.		S. Decl.	Log r	Log Δ
		h. m. s.	° ' "	"	"	"
Aug.	20 ...	2 48	26	3 55	0.1866	9.9466
	24 ...	2 52	36	4 29	"	"
	28 ...	2 56	1	5 5	0.1987	9.9428
Sept.	1 ...	2 58	38	5 44	"	"
	5 ...	3 0	28	6 24	0.2112	9.9400
	9 ...	3 1	29	7 5	"	"

M. Michkovitch noted that the coma appeared round, the diameter exceeding 1'. There was a well-defined nucleus of magnitude 9.8. Dr. Palisa noted that this was eccentrically placed in the coma.

**STONYHURST OBSERVATIONS IN 1919.**—The annual volume of the results obtained at Stonyhurst Observatory last year contains an interesting summary by the director, the Rev. A. L. Cortie, of the solar observations. The mean spot areas for 1917-18-19 are 12.1, 7.9, and 8.4 respectively, while the mean daily magnetic declination ranges in the same years are 11.8°, 12.4°, and 12.7°. The year 1919 probably represents the hump on the downward curve, which is frequently shown both in sun-spots and variable stars. Father Cortie associates the delayed maximum of magnetic—as compared with sun-spot—activity with the declining mean latitude of sun-spots, which increases their magnetic efficiency, since it makes them cross the sun more centrally.

The most remarkable spot group of 1919 was a triple group which was on the disc from August 13 to 25 (central about August 19). A very violent magnetic storm occurred on August 11-12; if this was connected with the spot group the discharge must have been directed tangentially, not radially, from the sun. The spot group persisted through four rotations, being last seen on December 7.

The report also gives the result of a comparison between the drawings of faculae and the photographs of calcium flocculi. A close correspondence in position is found, so that every prominent flocculus has an accompanying facula.

A research is also in progress with the view of

tracing the flow of faculae in regions of long-continued spot activity. It is anticipated that this flow will prove to be connected with the cyclonic movements that produce the magnetic field in sun-spots.

**THE STRUCTURE OF THE UNIVERSE.**—*Science* for July 23 contains a lecture on this subject by Prof. W. D. MacMillan, of the University of Chicago. Prof. MacMillan dwells on the numerous analogies between the microcosm of atoms and electrons and the stellar universe. For example, he shows the close analogy between the two electrons of the hydrogen atom and the sun-Neptune system, the relation between their diameters and mutual distance being about the same. He gives the number of atoms in the solar system as  $6 \times 10^{35}$ , and the volume of the sun's domain in the stellar universe as 20 cubic parsecs, or  $6 \times 10^{56}$  c.c. So that, on the average, there is 1 atom to 10 c.c., which would put the atoms about as far apart relatively to their diameter as the stars.

It will be remembered that Prof. Eddington and others have recently made the suggestion that the annihilation of atoms through collision and the consequent release of their stores of energy may be going on in the hottest stars, and thus add enormously to the duration of their output of light and heat. Prof. MacMillan endorses these speculations, and adds the suggestion that the radiant heat of the stars in its passage through space may perform the converse transformation and build up matter once more from the products of such atomic collisions, restoring to them the property of mass which they had lost. He claims as a result of these agencies to have constructed a universe that is infinite, eternal, and unchangeable. But he can scarcely claim that this conclusion is based exclusively on known facts. Many of his postulates are doubtful, and rest on analogy only.

**Textile Industries and Technical Education in Canada and the United States.**

**I**NDUSTRIES ALFRED F. BARKER, of the Textile Industries Department of the University of Leeds, has written an interesting report<sup>1</sup> of nearly 130 pages of text, accompanied by numerous photographic illustrations, of a visit paid in the summer of 1919 to Canada and the United States. In the course of the report he discusses, among other matters, the vast resources in water-power of Canada, which, used directly or in the development of electrical energy, render to manufacturing industry an immense service, and also education and educational institutions, housing, work and wages, and industrial enterprise as they came under his observation in both Canada and the States; and he offers interesting comparisons with the conditions which prevail in the United Kingdom. Prof. Barker is, however, chiefly concerned with the extent, variety, and progress of textile manufacture connected with the production of cotton, wool, and silk goods. He was everywhere given the fullest facilities for his inquiries and investigations, with the result that his observations cannot fail to be of the highest interest and value to producers and merchants engaged in these industries.

Almost all the cotton mills in the Dominion are in the province of Quebec, attributable, Prof. Barker observes, possibly to climatic conditions, to the manipulative skill and cheap labour of the French Canadian, or to some combination of all these causes with

<sup>1</sup> "A Summer Tour (1919) through the Textile Districts of Canada and the United States." By Prof. A. F. Barker. Pp. xi+157. (Leeds: Printed by Jowett and Sowry, Ltd., n.d.)

other causes not so much in evidence. Many of the cotton mills are quite extensive in their buildings and equipment, and almost without exception are con-

of education and educational institutions alike in Canada and in the States. In the province of Quebec there is to be found well-equipped agricultural schools



FIG. 1.—The Arlington mills, consuming 200,000 lb. of greasy wool per day.

trolled by British or British Canadian managers, some of whom received their training in Lancashire textile schools or in those of the States. It is a unique feature of Canadian mills, as distinguished from those of Lancashire and Yorkshire, that every operation from the yarn to the finished cloth, even including the dyeing and printing, is carried out in one and the same factory, which obviously makes it much more interesting to visit than that of a similar works in this country. The woollen industry is mainly centred in Ontario, and is far less well organised than that of cotton, but the hosiery mills are in evidence in every textile district of the Dominion, and a great future lies before the industry, since the equipment and staff of workers are of the most efficient character (Fig. 1).

Referring to textile manufacture in the States, Prof. Barker remarks that fine wool yarns are now spun there which cannot be beaten in any European country, but that neither in Canada nor in the States did he see a fine cotton yarn approaching that produced by Lancashire mills. On the other hand, he visited a mill in New Jersey which produced finer and better finished dress fabrics than Bradford, and in New York he was shown worsted fabrics impossible to exceed in beauty of texture and colour.

Much space is given in the report to the subject

and agricultural research stations designed to serve the farming interests, whilst in Montreal, the largest city of Canada dominated by industry and commerce, there is the splendid McGill University, with its

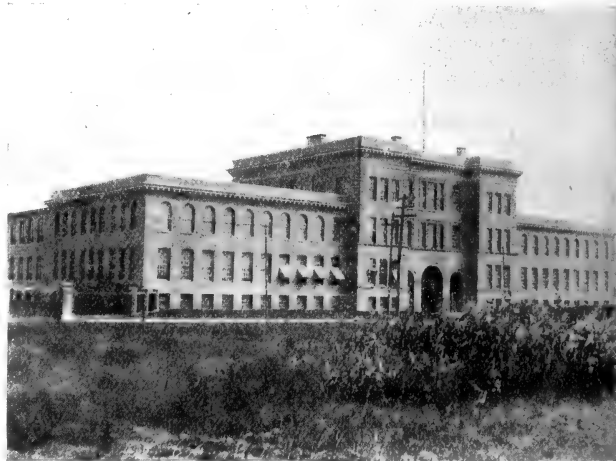

FIG. 2.—Lowell Textile School.

magnificently equipped engineering school; and in Toronto, the capital of Ontario, there is the University, beautifully situated in the park-like centre of the

city, noted for its strong Faculty of Applied Science, and not less is the city celebrated for its fine Technical High School, wherein industries and industrial processes are made to serve the highest educational purposes for its three thousand day students. At night the school is attended by six thousand apprentices in the various trades the equipment covers. In short, Canada, in proportion to its population, is well provided with institutions of university rank, and in the near future she will have educational facilities second to no other country in the world. Prof. Barker is also not less loud in his praise of the educational activities and institutions of the States, especially of the Massachusetts Institute of Technology, in many respects one of the finest institutions in the world, wherein nothing is spared to make the courses good and experimental and research work so efficient that it cannot be left out of the industrial sequence, with the result that the institution is simply flooded with students who are inspired with the possibilities of discovery. He speaks highly of the provision for textile training and education, and especially of the fine school at Lowell (Fig. 2), which represents for the textile industries what the Institute of Technology of Boston represents for mining and engineering. The report is full of apt observation upon educational and industrial aims and methods.

### Sunshine in the United States.<sup>1</sup>

THE United States *Monthly Weather Review* for January, 1920, contains a discussion on "Sunshine in the United States" by Mr. J. B. Kincer, Meteorologist attached to the Weather Bureau, Washington, from observations mostly for the twenty years from 1895 to 1914.

Data are given showing the actual amount of sunshine in hours and tenths and the percentage of the possible amount, both methods having their special advantages. Charts and diagrams show the mean solar time of sunrise and sunset, and the average length of day, sunrise to sunset. The seasonal and annual distributions of sunshine are given in percentages of the possible amount, and a table shows for each month and for the year the percentage of possible amount of sunshine for all stations where records are made.

Some dissatisfaction is expressed at the records of the automatic instruments available, as they in no way indicate the different degrees of sunshine intensity—an anomaly shared by all other countries. In describing three forms of sunshine recorders in use, the Campbell-Stokes, the Jordan, and the electrical thermometric recorder, which is said now to be in general use by the Weather Bureau, the *Review* states: "The Campbell-Stokes burning recorder, consisting of a lens or burning-glass which scorches, during bright sunshine, a trace on a strip of cardboard placed at the proper focal distance and adjusted by clockwork to revolve with the sun"; this description seems open to objection, as the card is stationary, and the sun revolving impinges its image on the card bearing the time-scale.

Distribution of sunshine with geographical position is well treated. For the year as a whole the least amount of sunshine occurs along the North Pacific coast, where it is only 40 per cent. of the daylight hours. The maximum amount in the United States occurs in the south-west; in the Lower Colorado River valley the duration of sunshine is 90 per cent. of the total number of hours from sunrise to sunset. July is the month of maximum amount in nearly one-

half of the country, including all the northern districts.

Data are given showing the average annual percentage of days clear, partly cloudy, and cloudy. Dealing with diurnal variations in sunshine, it is stated that the amount is least during the early morning hours, with a secondary minimum in the late afternoon. The greatest amount occurs near midday.

Prof. R. de C. Ward, of the Harvard University, contributed an article to the U.S. *Monthly Weather Review* for November, 1919, bearing the title "Bibliographic Note on Sunshine in the United States." Foreseeing the issue of a series of new sunshine charts for the United States, a brief account is given of previous sunshine charts issued.

Reference is made to work done by van Bebbler in 1896 and by Gläser in 1912, and it is mentioned that "the available material was confessedly very inadequate." In charts prepared by Prof. A. J. Henry in 1898 the percentages of sunshine were obtained by subtracting the mean annual cloudiness from 100, and a map of normal annual sunshine compiled from observations at the Weather Bureau stations from 1871 to 1908 inclusive seems to have been obtained in the same way. The system seems open to serious objection, and is far less satisfactory than using the records of the automatic sunshine instrument.

C. H.

### The Peat Resources of Ireland.

THE Fuel Research Board has issued as a Special Report (No. 2) a lecture on the above subject delivered by Prof. P. F. Purcell before the Royal Dublin Society last year. The importance of using the lower grade fuels has been greatly enhanced by the enormous rise in the price of our higher grade staple fuel, coal; and Sir George Beilby, in his introductory remarks to the Report, ascribes the revival of interest in peat as a fuel not only to the general scarcity of fuel, but also to the great and apparently permanent increase in the cost of coal.

The peat resources of Ireland are of paramount interest in that country, where the bogs cover one-seventh of the area, and Prof. Purcell estimates that the peat reserves in these bogs are more than ten times those of the *proved* coal reserves of that country. The estimated "anhydrous peat" is 3,700,000,000 tons, equivalent to 5,000,000,000 tons of average air-dried peat. Sixty-two per cent. of the farmsteads are entirely dependent upon peat fuel, and it is estimated that the annual consumption is between 6,000,000 and 8,000,000 tons.

The problem of the utilisation of peat is, as is well known, one of the economical removal of excess water, the average content of which is about 90 per cent. The effect of water is, perhaps, best emphasised when it is stated that "with 80 per cent. present, the 11 per cent. of dry peat will just be sufficient to evaporate the 80 per cent. of water." In the natural process of air-drying peat, difficulties of a practical and economic nature are met with; thus the drying season is only from five to six months. In winter, water freezing in the blocks causes their breaking down, and the whole year's supply has to be won in the limited dry season of the year. "It thus happens that a great number of hands are required for a portion of the year, and few for the remainder," and these considerations furnish a very strong incentive to the invention of economical methods of artificial drying.

In Prof. Purcell's opinion, in spite of the many methods which have been tried for the removal of

<sup>1</sup> From U.S. *Monthly Weather Review*, January, 1920, vol. xlviii., pp. 12-17 and charts i-iv; November, 1919, vol. xlvii., pp. 794-95.

excess water and improvements in mechanical and industrial operations, the air-drying of peat by natural means is the only recognised commercially successful method in use to-day. Reduction of the water-content from 90 to 70 per cent. by pressure alone on the raw peat is considered by the author to be the maximum, and he does not consider that drying by artificial heat becomes a practical proposition until this 70 per cent. content is reached, "and even then it is a very doubtful financial proposition."

For use under boilers the water should be reduced to 30-35 per cent.; for gas producers it is stated that several leading manufacturers claim successful working with 60-70 per cent., but Prof. Purcell considers that the possibility of using peat with as high a moisture-content as 60 per cent. is doubtful, and quotes the Canadian authority, Haakel, in support. "If it were permissible [to use such wet peat] it would render the industry less dependent on the weather, extend the peat-winning season, and simplify the whole problem."

Prof. Purcell considers that a clear case for the extended development of the peat deposits exists from an agricultural point of view, for the reclamation of land by removal of the bog and drainage must add to the food-producing capacities of a country. But labour costs are no small difficulty, for, as Sir George Beilby points out in his introduction, the development of a bog with 20 ft. of good peat is in some respects analogous to the proposal to develop a coalfield of similar area containing a single seam of only 15 in. thickness. It is true that the peat bog entails only surface working, but the whole depth has to be worked and 10 tons of raw material excavated and handled for 1 ton of dry peat. J. S. S. B.

### Past and Present Sewage Systems.

TWO Chadwick public lectures recently delivered at Colchester by Mr. A. J. Martin dealt with the nature and treatment of sewage. Since the very earliest days there have been codes of sanitary laws, but all kinds of readjustments had to be made as soon as men began to congregate in large cities. These crowded conditions seem to be met most satisfactorily by the water-carriage system, by which the clean water supplied to a town returns ultimately to the sewers charged with all manner of pollution. When sewers were first laid the sewage was discharged straight into the rivers. The results were, of course, disastrous, and successive Royal Commissions were set up to find a remedy. The whole problem of sewage purification was obscure, and very little progress was made for a whole generation. Great hopes were centred in sewage farms as a method of disposing of the sewage, and the various local authorities hoped at the same time to reap a profit from the cheap manuring of the land. Sewage farms, however, rarely pay in a humid climate such as ours, for the land cannot deal with the huge amounts of water brought down from the sewers. Many other methods were tried, but in all of them the investigators failed to recognise the existence of the tiny scavengers which Nature provides to deal with our waste products.

The modern method of sewage purification was evolved after Pasteur's discovery of the bacteria which induce fermentation, and after the work of Warington and of Winogradsky on the nitrifying bacteria in the soil. The purification is carried out in two stages. The first stage is treatment in the "septic tank," through which the sewage passes extremely slowly. The solids sink

to the bottom, where they are attacked by anaerobic organisms flourishing there, and ultimately either liquefied or turned into gas. The second stage of the process consists in the oxidation of the dissolved polluting matter. This matter has to be brought into contact with a large supply of atmospheric oxygen in the presence of certain small organisms which are able to oxidise the organic materials. This contact may be effected in the soil, in a specially constructed filter, or in a large volume of water. When soil forms the contact bed, purification is brought about either by "filtration," when the sewage percolates downwards through the soil, or by "broad irrigation," when the sewage merely passes over the soil surface. The method chosen depends on the openness or otherwise of the soil and subsoil. When suitable land is not available, artificial filters are made of broken clinker, destructor slag, etc. These materials provide a home for the nitrifying bacteria. The sewage is allowed to trickle slowly through, and with a good filter a purification of 80-90 per cent. is effected. When purification is allowed to take place in water, the volume of the water into which the sewage flows needs to be about five hundred times greater than the volume of the sewage.

Engineers had just settled down to the septic tank and trickling filter as the standard method for sewage purification when the "activated sludge" process was introduced by Drs. Fowler and Arden. In this process the whole purification is completed in a tank provided with particles of activated sludge to serve as homes for the nitrifying bacteria. The sludge (i.e. solid deposit from the sewage) is activated by being submitted to currents of air for several days. It is then placed in the tank with the sewage, and air forced through for some hours until purification is effected. The drawback of this method is the great bulk of the resultant sludge, and the problem now is to find an economical way of disposing of the sludge so that the plant-food which is contained in sewage shall not be wasted.

### Experimental Cottage Building.

IN view of the present housing difficulties, considerable interest has been centred in the results of the experiments in cottage building which have been carried out on the Ministry of Agriculture's Farm Settlement at Amesbury. These results are published in the Weekly Services for May 15 and 22, where we also learn that on Wednesdays for two or three months competent guides have been available to show visitors the experiments actually in progress. The present scheme includes thirty-two cottages, sixteen of which are for comparison purposes, and are built of brick on normal lines of construction, while the other sixteen are more directly experimental. Each cottage consists of parlour, living-room, scullery, bath-wash-house, larder, fuel store, etc., on the ground floor, with three bedrooms on the upper floor. Experiments in building in chalk include a cottage with cavity walls built of blocks made of chalk and cement, one with walls of chalk and cement rammed between shuttering, one with walls of chalk alone (chalk pisé), and one with walls of chalk and straw (chalk cob) built without shuttering. There is also one cottage of monolithic reinforced concrete and two concrete-block cottages with hollow walls. These two cottages are being erected under contract by two proprietary firms; for all the other experimental cottages direct labour is employed. The experiment also includes a pair of timber-framed cottages faced with

elm weather-boarding and two Army huts converted into permanent bungalows. With regard to the latter experiment, results show that no economy is effected by using these huts. Another cottage has walls of clay and gravel, while two single and one pair of cottages are being erected in pisé-de-terre. One of the single pisé cottages is now being roofed—this is the first two-storied pisé house erected in England.

Pisé-de-terre walls are built by ramming nearly dry soil between movable shutters arranged as a temporary mould. The method was known in England a century ago, but had fallen into disuse, and a large number of investigations have been carried out to determine the best lines for its revival. All soils are not suitable for pisé work, for not only must the particles cohere firmly when rammed and dried, but also there must be no excessive shrinkage in the drying process. Calcium carbonate helps to reduce shrinkage, while organic constituents are particularly liable to shrinkage, and therefore weaken coherence in the soil as a whole. The amount of water present in the soil at the time of use is an all-important factor. Generally speaking, this water should be between 7 per cent. and 14 per cent. of the weight of the dried earth. The most suitable method of shuttering and the best form of rammer have been decided, while experiments are also being made to find the most satisfactory material and method for rendering the exterior face of the wall. Pisé building can be carried out in the winter if there is sufficient protection from severe weather, but consideration of the expenses involved in providing tarpaulins, screens, etc., makes it evident that it is not sound economy to undertake pisé construction in the winter months. When building in pisé the foundations have to be of brick or concrete; the pisé work may be started only at about 9 in. to 1 ft. above the ground-level. This is an important factor in the consideration of the cost of pisé building, which, however, will probably prove to be a considerably cheaper process than building in brick.

### Cotton Growing.

**T**HE Empire Cotton Growing Committee of the Board of Trade, which presented its first report on cotton growing in the British Empire in January last (*NATURE*, February 26 and March 25), has now published a note on "Future Organisation," which may be regarded as an appendix to the report. While it is merely indicative of the trend of the Committee's ideas, in that such organisation is subject to the appointment of the director and his staff, it makes the situation more definite by estimating the probable expenditure upon the various branches of work contemplated.

As in the case of the original report, all the organisation proposed is for common service, since the expenditure can bring no direct return, but it should, in the Committee's opinion, indirectly bring about an increase in the cotton supplies. The Committee concludes that in order to carry out the work adequately an annual sum of approximately 200,000*l.* ought to be assured. This amount may appear large until we remember that cotton to the value of about 50,000,000*l.* is imported into this country annually.

The note sketches the proposals for finance and superior organisation, executive work, and the central office; for staff abroad; for supplementing staffs of agricultural departments oversea, and pioneering; for education and information; and for commercial handling. In the last case the setting up of semi-commercial experimental enterprises is excluded from

the scope of the note. Amongst these headings the Committee proposes an initial expenditure of 20,000*l.* per annum upon its own research station abroad. It also proposes to provide for a staff of ninety men, including scientific workers and agricultural officers of different grades, for the purpose of supplementing local agricultural department staffs "after full consultation with and on invitation by the local administration."

Under the heading of "Education" the Committee makes proposals which take the initiative in a move towards obtaining co-operation between all the plant-using industries in order to increase the facilities for training men in pure science, later to be of economic value to the various agricultural services abroad. It estimates that university staffs in this country should be increased specially for this purpose by at least four professorships, fifteen lectureships, and six administrative and technical lectureships, together with a provision of twenty post-graduate studentships. The annual cost is estimated at 27,000*l.*, of which it is suggested that the cotton industry should contribute 12,000*l.* as its share.

### Thermostatic Metal.

**T**HE British Thomson-Houston Co., Ltd., has sent us specimens of a new bimetallic strip for use in thermostatically controlled devices. The strip is prepared by the permanent union over their entire length of two metals with widely differing coefficients of expansion. The union between the two component metals is complete and durable, and the strip may be bent, twisted, or hammered without causing the separation of the metals at any point, and even on heating the bond will not be broken so long as the temperature remains below the melting point of the softer of the two metals. Owing to this permanency of union the metal can be formed into any desired shape, annealed after formation, and safely employed at any temperature below 500° F. The component metals do not corrode under ordinary conditions, and may be used in any reasonable situation without fear of deterioration or change in operating characteristics. The amount of deflection obtained is always the same in a strip of given length and thickness for a given temperature change, and consequently the strip provides a trustworthy basis for the operation of any thermostatic device, and may be employed for work of high precision. The deflection due to temperature change varies inversely as the thickness, directly as the square of the length, and directly as the temperature change. With a strip 4 in. long, 0.31 in. wide, and 0.03 in. thick the deflection obtained for a temperature change of 100° F. is about 0.57 in. The force exerted varies as the square of the number of degrees of temperature change and as the square of the thickness, and directly as the width, and is not affected by changes of length. For a strip of the dimensions above-mentioned the force exerted for 100° F. change of temperature is about 3 oz. weight, whereas for a strip of the same dimensions but 0.1 in. thick the force exerted is about 24 oz. weight. To produce a permanent set in a strip 4 in. long, 0.31 in. wide, and 0.03 in. thick a force of about 7 oz. weight would be required. The metal is manufactured in standard sizes ranging from 0.015 in. to 0.25 in. in widths up to 6 in., and lengths up to 26 in. It can, however, generally be supplied cut to widths and lengths to suit the purchaser, and in special cases thermostatic metal parts may be completely formed to the purchaser's specifications.

## University and Educational Intelligence.

CAMBRIDGE.—Last week the large theatre of the School of Anatomy was the scene of an interesting presentation to Dr. W. L. H. Duckworth, fellow of Jesus College and senior demonstrator in anatomy, on the completion of twenty-one years of devoted service to the University as lecturer in physical anthropology. This remarkable tribute to the esteem and affection in which he is held was the spontaneous desire of every demonstrator, assistant, and student to contribute some token of appreciation of Dr. Duckworth's unflinching courtesy and ever-ready help. His sympathy and charm of manner have made him one of the most approachable of teachers, and endeared him to all who have come in contact with him during his period of service. A fine inscribed silver salver was presented to Dr. Duckworth, together with a book containing the signatures of two hundred and twenty subscribers, by Dr. D. Reid on August 13 in the presence of the staff and students of the anatomy department. In addition to his brilliant academic qualities, Dr. Duckworth has shown great capacity for organisation, especially during the past year, when the chair of anatomy has been vacant and the entire control of the anatomy department has devolved upon him.

THE Dr. Jessie Macgregor prize of the Royal College of Physicians, Edinburgh, has been awarded to Miss Lucy Davis Cripps for her work on tetryl.

THE following free illustrated lectures are to be delivered in the Canada Building, Crystal Palace, at 6 p.m., under the auspices of the Institution of Petroleum Technologists:—"Oil Prospecting," G. Howell (September 1); "Petroleum Refining," Dr. A. E. Dunstan (September 8); "Utilisation of Volatile Oils," Dr. W. R. Ormandy (September 15); and "Utilisation of Heavy Oils," Prof. J. S. S. Brame (September 22).

A PROSPECTUS of the faculty of engineering of the University of Bristol, which is provided and maintained by the Society of Merchant Venturers in the Merchant Venturers' Technical College, has just reached us. Courses of study are available at the college for persons intended to engage in civil, mechanical, electrical, or automobile engineering, and particulars of these courses are given in the prospectus. The ordinances and regulations relating to degrees and certificates in engineering subjects are included, and some particulars of the Bristol sandwich system of training engineers are also given. The prospectus can be obtained from the Registrar of the University, Tyndall's Park, Bristol.

THE Bureau of Education, Calcutta, India, has issued its Report on Education in British India for 1918-19, abundantly illustrated with photographs. The terrible epidemic of influenza which broke out at the close of the year 1918 and carried off millions of people throughout India, together with the widespread failure of the crops, caused grave dislocations in the schools and colleges, though it called forth all that was best in the life and spirit of many of these institutions. The number of pupils and students in the public schools and colleges on March 31, 1918, was 7,338,663, and in private institutions 597,914—a total of 7,936,577, or 3.25 per cent. of the total population of upwards of 241,000,000 in British India alone, which percentage is nearly one-third that of Russia, probably the most backward country in Europe. The number of pupils under instruction has risen from 300,000 in 1860 to nearly 8,000,000 in 1920, and the expenditure

has advanced from 200,000*l.* to upwards of 9,000,000*l.* within the same period. In 1918-19 140,000*l.* was granted for agricultural education and 60,000*l.* for technical education of a pressing nature pending the Indian Industrial Commission's report. The schools and colleges now number 162,330. One of the principal recommendations of the Calcutta University Commission, viz. the transfer of intermediate classes to the school system, has been carried out at the Patna College. Many developments show that the universities are alive to the necessity of assisting in the commercial and industrial revival. Schools of economics have been established in the Universities of Madras, Bombay, Allahabad, and the Punjab, whilst the Benares Hindu University is opening a college of mechanical and electrical engineering. Proposals for new universities at Rangoon and Nagpur are being completed, and sites have been acquired. A Bill was introduced in 1919 for a unitary university at Dacca. New outlying colleges have been opened or proposed in Bombay, Bengal, and the Punjab. Many of the colleges are said to be overcrowded with youths unfitted for an academic career, which is also borne out in the report of the Calcutta University Commission. There is immense work for education yet to be accomplished in India.

## Societies and Academies.

PARIS.

Academy of Sciences, July 26.—M. Henri Deslandres in the chair.—The president announced the death of Dr. Guyon.—G. Bigourdan: An economical means of utilising the energy of tides.—Ch. Depéret: An attempt at the general chronological co-ordination of Quaternary time.—L. Mauguere and E. Demoussy: The toxicity of iron (towards plants) and the antitoxic properties of copper in presence of ferrous salts.—F. Vidal, P. Abrami, and N. Iancovesco: The proof of digestive hæmoclasis and latent hepatitis. A development of the method of detecting liver trouble described in an earlier communication. After the absorption of a glass of milk it is only necessary to determine the fall in the arterial pressure, the lowering of the number of white corpuscles, the inversion of the leucocytic coefficient, and other phenomena easily determined in the laboratory to discover the functional working of the liver. Numerous examples of the application are given, with especial reference to the disturbances caused by the administration of arsenic compounds in syphilitic cases.—A. Perot: Comparison of the wave-lengths of a line of the cyanogen band in the light of the sun and that of a terrestrial source. The solar wave-length is greater than the terrestrial wave-length, their difference in relative value being  $(2.22 \pm 0.10) \cdot 10^{-6}$ . This difference is reduced by a correction for the descending movement of the absorbing centres to  $(1.6 \pm 0.3) \cdot 10^{-6}$ . The figure calculated from Einstein's theory of generalised relativity is between the corrected and uncorrected numbers.—A. Schaumasse: Discovery and observations of the comet 1920b (Schaumasse). This comet was discovered on July 18 at the Nice Observatory. It is about the 11th magnitude, and appears as a diffuse nebulosity of 2.5' diameter. It may be the second periodic comet of Tempel.—G. Fayet: Probable identity of the 1920b comet (Schaumasse) with Tempel's second periodic comet.—P. Chofardet: Observations of the periodic comet Tempel II. (Schaumasse) 1920a, made at the Observatory of Besançon with the bent equatorial. Three positions on July 20-21 are given. The comet was of about the 11th magnitude.—C.

**Raveau**: The isotherms in the neighbourhood of the critical state. The adiabatic expansion of saturated fluids.—**R. Dongier**: The point-crystal or point-metal auto-detector telephone receiver.—**F. Michaud**: The correspondence of bodies in the solid state.—**A. Pictet** and **P. Castan**: Glucosane. Glucosane was readily obtained in a pure state by heating glucose under a pressure of 15 mm. to a temperature of 150–155° C. A study of its chemical reactions leads to the conclusion that it probably has a composition analogous with ethylene oxide.—**A. Mailhe**: The catalytic hydration of nitriles. If a mixture of steam and benzonitrile vapour is passed over thoria at 420° C., benzoic acid is produced by the hydrolysis of the nitrile. The generality of the reaction has been proved by applying it to seven nitriles.—**G. Dubois**: The discovery of a fossil-bearing layer in the Flanders clay at Watten (Nord). The fauna found in this layer confirms the stratigraphical identity of London clay, Cuise sands, and Flanders clay.—**A. Carpentier**: Some siliceous fossil plants from the neighbourhood of Sainte-Marie-aux-Mines (Alsace).—**L. Blaringhem**: The heredity and nature of peloria in *Digitalis purpurea*.—**R. Souèges**: The embryogeny of the Compositæ. The first stages of the development of the embryo in *Senecio vulgaris*.—**F. Chiffot**: The gum-bearing secreting canals of the roots of the Cycadaceæ, and more particularly those of *Stangeria paradoxa*.—**Em. Perrot**: Biological notes on the Acacias producing gum, known as gum arabic, in the Egyptian Sudan.—**H. Ricome**: The action of gravity on plants.—**L. Emberger**: Cytological study of the Selaginella.—**A. Guilliermond**: New cytological observations on Saprolegnia.—**G. Truffaut** and **N. Bezsonoff**: Comparative study of the microflora and the amount of nitrogen in soils partly sterilised by calcium sulphide.—**A. Lumière**: Are vitamins necessary to the development of plants? It is generally admitted that vitamins are necessary to the growth of plants. The author, whilst admitting the accuracy of the experiments on which this view is based, considers that the experimental results have been misinterpreted. Fresh yeast, rich in vitamins and rapidly curing polyneuritic troubles in pigeons, after heating to 135° C. for one hour, completely loses all its antiscorbatic properties, but still serves for the preparation of culture fluids, giving good development of fungi. Even after heating to incipient carbonisation to 250° C. these extracts retain their fertilising properties.—**A. H. Roffo** and **P. Girard**: The effects of electrical osmosis on cancerous tumours of rats.—**M. Fauré-Fremiet**, **J. Dragouin**, and **Mlle. Du Vivier de Streel**: The growth of the foetal lung in the sheep and the concomitant variations in its composition.—**R. Sazerac**: Culture of the tubercle bacillus on a medium of autolysed yeast. It has been proved that both human and bovine tubercle bacilli will grow normally on this medium, the detailed preparation of which is given. It contains, in addition to autolysed yeast, 5 per cent. of common salt and 4 per cent. of glycerol.—**J. Nageotte**: Osteogenesis in grafts of dead bone.—**A. Trillat**: The influence of the presence of infinitesimal traces of nutritive substances in air-moisture on contagion.

## PHILADELPHIA.

**American Philosophical Society**, April 23.—**Dr. A. A. Noyes**, vice-president, in the chair.—**Dr. D. T. MacDougal**: The components and colloidal behaviour of protoplasm. The living matter of plants is composed chiefly of mucilages and albuminous compounds in varying proportions mixed in the form of an emulsion or as a jelly. The molecules of solid matter are aggregated into groups, which also include

a number of molecules of water. Growth consists of the absorption of additional water to these groups, with more solid material being added at the same time, the process being termed "hydration." The resultant increase may be detected by determination of increased dry weight or measured as increase in length, thickness, or volume. More exact studies in growth have become possible by the establishment of the fact that mixtures of 25–50 per cent. mucilage and 50–75 per cent. albumin show the hydration reactions of cell-masses of plants. It is also found that certain amino-compounds, such as histidine, glycocoll, alanine, and phenylalanine, which are known to promote growth, also increase the hydration of the "biocolloids," as the above mixtures are called.—**Prof. W. J. V. Osterhout**: Respiration. A simple method of measuring respiration has been developed whereby determinations can be made at frequent intervals (as often as once every three minutes). The application of this method to the study of anaesthesia shows the incorrectness of the theory of Verworn, according to which anaesthesia is a kind of asphyxia, due to the inhibition of respiration by the anaesthetic.—**Prof. B. M. Davis**: (1) The behaviour of the *sulphurea* character in crosses with *Oenothera biennis* and with *Oenothera franciscana*. (2) *Oenothera funifolia*, a peculiar new mutant from *Oenothera Lamarckiana*.—**Prof. G. H. Shull**: A third duplication of genetic factors in shepherd's-purse. In the third generation of a cross between a wild biotype of the common shepherd's-purse (*Bursa bursa-pastoris*) from Wales and Heeger's shepherd's-purse (*B. Heegeri*) there appeared a small number of plants of unique type, having a more coriaceous texture than in the plants of either of the two original strains involved in the cross. This new type has been designated *coriacea*.—**Prof. E. M. East**: Some effects of double fertilisation in maize.—**Dr. T. B. Osborne**: The chemistry of the cell.—**Prof. G. A. Hulett**: The relation of oxygen to charcoal.—**Prof. C. E. Munroe**: Products of detonation of T.N.T. It is known that among the products are considerable quantities of carbon monoxide, hydrogen, and some hydrocarbons, such as methane, together with free carbon in a soot-like form. Hence T.N.T. is not suitable for use in underground work or close places, because the gas evolved is poisonous and inflammable, and can form explosive mixtures with the atmosphere in these close places.—**Prof. J. W. Harshberger**: A new map of the vegetation of North America.—**Prof. A. G. Webster**: The vibrations of rifle-barrels. (Dr. H. L. Carson, vice-president, in the chair.)—**Dr. L. Wittner**: Symposium on psychology in war and education.—**Dr. J. McK. Cattell**: Methods. The speaker reviewed the development of experimental and quantitative methods in psychology, and especially the transfer of its main concern from introspection to the study of individual differences in behaviour. By co-operation with other sciences it is possible for psychology to change the environment, and behaviour can be controlled more effectively by a change in the environment than by a change in the constitution of the individual.—**Dr. R. M. Yerkes**: Psychological examining and classification in the United States Army. The initial purpose of examining was the discovery and prompt segregation or elimination of men of markedly inferior intelligence. The uses which were actually made of results of psychological examinations were extremely varied, and covered the classification of men to facilitate military training, the selection of men of superior ability for training as officers or for special tasks, the segregation and special assignment of men whose intelligence was inadequate to the demands of regular military training, and, finally, the elimination of the

low-grade mental defective.—Prof. R. Dodge: The relation of psychology to special problems of the Army and Navy.—Dr. J. K. Angell: Relation of psychology to the National Research Council. The supporting scientific societies elect representatives who compose the several divisions of the Council, and these in turn, comprising, as a rule, about twenty men selected for their eminence in their particular branch of work, come together and determine the special needs and opportunities for the improvement of research in their own fields. Special attention is paid to the possibilities of bringing about effective co-operation among research men and research agencies. Scientific investigation has hitherto been largely individualistic, and the most pressing need at the present moment is not so much the expansion of research agencies, although this is desirable, as the more effective employment of those already in existence.—Dr. B. Ruml: Psychological methods in business and industry.—Prof. A. J. Jones: The individual in education.—Prof. R. W. Wood: Invisible light in war and peace.

## HOBBART.

**Royal Society of Tasmania**, June 8.—Mr. L. Rodway, vice-president, in the chair.—G. H. Hardy: Australian Stradiomidae. The paper included a description of new species.—H. H. Scott and C. Lord: Studies of Tasmanian mammals, living and extinct. Part ii. The paper was divided into two sections, and dealt mainly with the skeleton of *Nototherium Mitchelli* recently obtained from the north-west coast of Tasmania. The first section gave a *résumé* of the history of the genus, and the second dealt with the osteology of the cervical vertebrae. The authors desire to show that the species was one essentially adapted for aggressive warfare. They point out that whereas the skulls of *N. Mitchelli* and *N. tasmanicum* at least (with the possibility of other species) are equally large and weighty, yet their cervical vertebrae show marked differences: one being an exaggeration of the standard of the modern wombat in about the same ratio of power (*N. tasmanicum*), while the other shows an additional power with interspersal muscles and paddings, suitable to the resisting of great shocks in the long axis of the head and vertebrae.

## Books Received.

Symbiosis: A Socio-physiological Study of Evolution. By H. Reinheimer. Pp. xii+295. (London: Headley Bros.) 15s. net.  
Ministry of Munitions. Department of Explosive Supply. Preliminary Studies for H.M. Factory, Gretna, and Study for an Installation of Phosgene Manufacture. Pp. xvi+145. (London: H.M. Stationery Office.) 15s. net.  
Prospector's Field-Book and Guide in the Search for and the Easy Determination of Ores and other Useful Minerals. By H. S. Osborn. Ninth edition, thoroughly revised and enlarged, by M. W. von Bernerwitz. Pp. xiii+364. (London: Hodder and Stoughton.) 12s. 6d. net.  
The Kalahari, or Thirstland Redemption. By Prof. E. H. L. Schwarz. Pp. vi+163+xiv plates. (Cape Town: T. Maskew Miller; Oxford: B. H. Blackwell.) 8s. 6d. net.  
Department of Statistics, India. Agricultural Statistics of India, 1917-18. Vol. ii. Pp. ix+118. (Calcutta: Government Printing Office.) 1 rupee.  
Botanical Survey of South Africa. Memoir No. 1: Phanerogamic Flora of the Divisions of Uitenhage

and Port Elizabeth. By S. Schonland. Pp. 118. (Pretoria: Agricultural Department.) 2s. 6d.  
A Manual of Dental Metallurgy. By E. A. Smith. Fourth edition. Pp. xvi+285. (London: J. and A. Churchill.) 12s. 6d. net.  
The Bible: Its Nature and Inspiration. By E. Grubb. Pp. 247. (London: Swarthmore Press, Ltd.) 2s. 6d. net.  
Manual of Psychiatry. Edited by Dr. A. J. Rosanoff. Fifth edition. Pp. xv+684. (New York: J. Wiley and Sons, Inc.; London: Chapman and Hall, Ltd.) 22s. net.  
Radiant Motherhood: A Book for those who are Creating the Future. By Dr. Marie C. Stopes. Pp. 246. (London: G. P. Putnam's Sons.) 6s. net.  
Relativity: The Special and the General Theory. By Prof. A. Einstein. Authorised translation by Dr. R. Lawson. Pp. xiii+138. (London: Methuen and Co., Ltd.) 5s. net.  
Liquid Air and the Liquefaction of Gases. By Dr. T. O'Connor Sloane. Third edition. Pp. 394. (London: Constable and Co., Ltd.) 21s.  
Airscrews in Theory and Experiment. By A. Fage. Pp. ix+108+7 plates. (London: Constable and Co., Ltd.) 34s.  
Smithsonian Institution, United States National Museum. Report on the Progress and Condition of the United States National Museum for the Year ending June 30, 1919. Pp. 211+7 plates. (Washington.)  
Principles and Practice of Aerial Navigation. By Lieut. J. E. Dumbleton. Pp. vii+172+v plates. (London: Crosby Lockwood and Son.) 12s. 6d. net.  
The Outdoor Botanist: A Simple Manual for the Study of British Plants in the Field. By A. R. Horwood. Pp. 284+20 plates. (London: T. Fisher Unwin, Ltd.) 18s. net.

## CONTENTS.

	PAGE
The Control of Water Resources . . . . .	765
The Mathematician as Anatomist. By Prof. A. Keith, F.R.S. . . . .	767
The Theoretic Basis of Psychotherapy. By H. S. Industrial Research. By A. P. M. Fleming, C.B.E. . . . .	770
Science and Crime. By C. A. M. . . . .	771
Our Bookshelf . . . . .	772
Letters to the Editor:—	
University Grants.—Principal C. Grant Robertson	774
Aerial Navigation and Meteorology.—Lt.-Col. E. Gold; Prof. E. van Everdingen . . . . .	775
Growth of Waves.—A. Mallock, F.R.S. . . . .	777
The Antarctic Anticyclone.—Dr. G. C. Simpson, F.R.S. . . . .	777
Trichodynamics.—Dr. W. Lawrence Balls . . . . .	777
Helium: Its Production and Uses. II. By Prof. J. C. McLennan, F.R.S. . . . .	778
The Cardiff Meeting of the British Association . . . . .	780
Obituary:—	
Sir Norman Lockyer, K.C.B., F.R.S. . . . .	781
Notes . . . . .	785
Our Astronomical Column:—	
Tempel's Comet . . . . .	789
Stonyhurst Observations in 1919 . . . . .	789
The Structure of the Universe . . . . .	789
Textile Industries and Technical Education in Canada and the United States. (Illustrated.) . . . .	789
Sunshine in the United States. By C. H. . . . .	791
The Peat Resources of Ireland. By J. S. S. B. . . . .	791
Past and Present Sewage Systems . . . . .	792
Experimental Cottage Building . . . . .	792
Cotton Growing ? . . . . .	793
Thermodynamic Metal . . . . .	793
University and Educational Intelligence . . . . .	794
Societies and Academies . . . . .	794
Books Received . . . . .	796



THURSDAY, AUGUST 26, 1920.

*Editorial and Publishing Offices:*

MACMILLAN &amp; CO., LTD.,

ST. MARTIN'S STREET, LONDON, W.C.2.

Advertisements and business letters should be  
addressed to the Publishers.

Editorial communications to the Editor.

Telegraphic Address: PHUSIS, LONDON.

Telephone Number: GERRARD 8830.

### The Forthcoming Census.

THE Census Act of 1920 will have one great advantage over previous Census Acts—that it will be a permanent measure, and not, as they have been, limited to the operation of taking the one census that was at the time in contemplation. We have travelled far from the days when the numbering of the people was considered to be an offence that would provoke Divine anger, and it is quite time that the old hesitating policy of passing a new enactment and creating a new staff and machinery every ten years, which doubtless had its origin in consideration for those superstitious scruples, should be definitely abandoned. The system had one indirect advantage while it lasted. For the eleven decenniums since 1801 the eleven separate Acts that have had to be passed have been gradually strengthened and made more workable, as experience has shown what improvements it has been possible to introduce into the practice, and thus have ripened into the materials for a permanent statute. All the same, the necessity for organising a scratch staff of new men every ten years, and dismissing it as soon as the census work was over, has been a great drawback to the efficiency of the Department, and it is to be hoped that one result of the new Act will be to enable the Census Office so to distribute its work over the whole decennium as usefully to retain the services of an experienced and competent staff of permanent officials. Much credit is due to the successive controllers of the census for the good work they have done under all disadvantages, and it is no disparagement to them to say that they have been hampered by circumstances.

The Act contemplates, but does not require, a quinquennial census. It enacts that no census shall be required to be taken in any part of Great

Britain in any year unless at the beginning of that year at least five years have elapsed since the beginning of the year in which a census was last taken in that part of Great Britain; but it leaves to the King in Council to fix the date on which each successive census is to be taken. There can be no doubt that for some statistical purposes the interval of ten years is too long, and that not infrequently in the course of that interval events arise that materially affect the applicability of averages drawn between censuses distant ten years from each other. With careful organisation a quinquennial census might be made the rule, but the Act leaves this question entirely open. It allows, however, of a special local census being made, independent of the date of the last previous census, upon the application of a local authority through the Minister of Health to his Majesty in Council for the purpose of facilitating the due performance by the authority of its statutory duties.

An important provision of the Act is that which prohibits inquiry at a census into any particulars other than those specified in the schedule to the proposed enactment. These are:—Name, sex, age; occupation, profession, trade, or employment; nationality, birthplace, race, language; place of abode and character of dwelling; education; infirmity or disability; condition as to marriage, relation to head of family, parentage, issue; and "any other matters with respect to which it is desirable to obtain statistical information with a view to ascertaining the social or civil condition of the population." The generality of this last item would no doubt be controlled by the *ejusdem generis* principle of interpretation, and there need be little fear that any Order in Council would authorise an undesirable extension of it; but care would still have to be taken against the use of the census for indirect or partisan motives. It may be stated as a general principle that the more you increase the number of items of information that you demand, the more you diminish the probability that the information you actually obtain will be accurate. A wise investigator, therefore, while naturally anxious to get all the sound information that he can, will carefully distinguish between that which is essential and verifiable, and that which cannot be relied upon.

Much light may be expected to be derived from the census returns upon subjects that have recently been prominently before the public, such as the diminution in the birth-rate, the extent to

which it has prevailed among the various strata of the community, the results of the war as affecting population and health, the effect of the shortage in housing on the general welfare, and other questions to which the events of the decade have given a new urgency; but in all these matters the principle we have just indicated of judging information, not by the number of details you are able to amass, but by the weight of accuracy and authenticity that they bear—*non numero, sed pondere*—will have to be borne in mind. The experience of the Registrar-General, backed by the enlightened enthusiasm of the Ministry of Health, will have ample exercise in these respects.

The Act is intitled "An Act to make provision for the taking from time to time of a census for Great Britain or any area therein and for otherwise obtaining statistical information with respect to the population of Great Britain." The Registrar-General, in addition to his formal Reports on the Census Returns, is to have power to supply local authorities and others concerned with statistical information derived from the census returns. The second branch of the title is provided for by section 5, which enables him also to publish statistics of the number and condition of the population derived from other sources, and for that purpose to enter into relations with other Government Departments so as to further the supply and provide for the better co-ordination of such information. If he were enabled to enter into similar relations with other countries as well, the very excellent object of obtaining uniformity in the statistics of the several nationalities might be materially promoted.

#### Prof. Alexander's Gifford Lectures.

*Space, Time, and Deity: The Gifford Lectures at Glasgow, 1916-18.* By Prof. S. Alexander. (In two volumes.) Vol. i. Pp. xvi+347. Vol. ii. Pp. xiii+437. (London: Macmillan and Co., Ltd., 1920.) Price 36s. net.

PROF. ALEXANDER has written a book which requires more than cursory reading. It deserves careful study. For it embodies a thoroughly modern exposition of New Realism in full detail. Moreover, these two volumes are not merely the outcome of a sustained effort at accurate investigation. They are distinguished by their admirable tone and temper. The author is throughout anxious to understand and to represent faithfully the views of those with whom he is in controversy. His reading of what has been written by the great thinkers of other schools has been closer and more intelligent than that of

NO. 2652, VOL. 105],

most New Realists, and he displays no traces of arrogance. He has done all he could to appreciate the materials furnished, not merely by mathematical and physical science, but by biology and psychology; highly important fields for his inquiry.

These very merits of Prof. Alexander's method have, however, produced their drawbacks. They have driven him beyond the current conceptions of the New Realist type into others which are not always easy to reconcile with them. In the second volume, particularly, where the author is chiefly concerned with such problems as those of the nature of the tertiary qualities of reality, of value, and of deity, the treatment leaves the impression that the subject-matter passes beyond the limits which alone are for the method legitimate. None the less, the effort made to be consistent is a notable one. But under this head I must refer the reader to the book, for the only aspect of the doctrine in it with which space allows me to concern myself is its cardinal principle as applied to physical knowledge.

To begin with, it is necessary to be clear as to what is peculiar to himself and his school in Prof. Alexander's teaching. It is not sufficiently realised that to-day the New Realists comprise a variety of groups divided by differences that are of far-reaching importance. These differences relate to the nature attributed to mind. For some of the most prominent of the American New Realists mind has no characteristic at all that distinguishes it from its objective content. Seeing means colours occurring; hearing means sounds occurring; thinking means thoughts occurring. Mind is itself just a casual selection out of the field of consciousness, and has no nature distinct from that field. When we speak of a mind, the grouping arises out of relations possessed by the objective elements themselves, relations which exist quite independently of our own action in perceiving. Minds are thus subordinate groups in a larger universe of being which includes them, and which would be unaltered if minds disappeared from it. Consciousness is thus merely a demonstrative appellation.

Now for Prof. Alexander, and, I think, for most of the English New Realists, mind has a reality independent of its object. With the latter, whatever it is, it is "compresent." The act of perceiving is one reality, the object perceived is another. Left to itself, the activity which we call mind reveals the object, with its relations (which may be universals) just as they exist independently of it. But the activity is a separate reality, which does not belong to the ordinary object world, but reveals itself in consciousness, in which it is said by Prof. Alexander to be "enjoyed." Here

we have dualism, a dualism which he gets over by referring the origin of the activity of mind and the object with which it is compresent, alike, to a final reality which is the foundation of both, an ultimate space-time continuum. This, inasmuch as the flow of time enters into its very essence, is not static, but dynamic. The activity which we are conscious of (in the form, not of perception, which is of objects, but of self-enjoyment) is therefore in its turn dynamic, and its character is that of a conation.

I am not sure that the Americans, notwithstanding their boldness, are not here on safer ground. They project everything, thought, feeling, and tertiary qualities, such as goodness and beauty, into what they call a non-mental world. Prof. Alexander is more cautious. With him the native hue of resolution is, at times at least, as he progresses in his enterprise, sicklied o'er with the pale cast of thought. He seems to feel that he must retain something for a mental world. Starting with space and time as having no reality apart from one another, but as mere abstractions from aspects or attributes of the foundational reality, which is space-time or motion, the "stuff of which all existents are composed," he has to account for our actual experience. His foundationally existent activity breaks itself up into the complexes of which we are aware, and which possess, as belonging to their nature, certain fundamental and all-pervasive features which we recognise as categories. There result also qualities which appear in our experience. These form

"a hierarchy, the quality of each level of existence being identical with a certain complexity or collocation of elements on the next lower level. The quality performs to its equivalent lower existence the office which mind performs to its neural basis. Mind and body do but exemplify, therefore, a relation which holds universally. Accordingly, time is the mind of space, and any quality the mind of its body; or, to speak more accurately, mind and any other quality are the different distinctive complexities of time which exist as qualities. As existents within space-time, minds enter into relations of a perfectly general character with other things and with one another. These account for the familiar features of mental life; knowing freedom, values, and the like. In the hierarchy of qualities the next higher quality to the highest attained is deity. God is the whole universe engaged in process towards the emergence of this new quality, and religion is the sentiment in us that we are drawn towards him, and caught in the movement of the world towards a higher level of existence."

I have given the general result of his inquiry as summed up in the author's own words, those

used by him in concluding his final chapter. But it would be unfair to suggest that the nature of this result can be appreciated from any isolated quotation. The whole book must be read. It is admirable alike in thoroughness of method and in command of material. Still, it is obvious that the entire edifice depends for its stability on its foundation, and that the author's conception of the ultimately real as being space-time, a continuum of point-instants or pure events entirely independent of mind, is the crucial point in his reasoning. If he is right, it must be in terms of this existent that all else must be capable of expression, and it cannot itself be expressed in terms of anything beyond itself. Of course, Prof. Alexander does not dispute that when we speak of space and time as of this character we are going beyond what we learn through sense, or intuitively, and are employing constructions of reflection. He is quite entitled to do this if a non-mental world can include universals, as he insists, in common with all New Realists. Our simplest experience is, as he says, "full of our ideas." The question is whether they belong to mind or to what is not mind. We shall see presently to what path this conclusion conducts.

At this stage we have to put before us the author's analysis of the relation of space to time, an analysis that seems to me altogether admirable. Space taken in abstraction from time has no distinction of parts. Time in so far as it is purely temporal is a mere now. To find a continuum we must find distinguishable elements. Without space there would be no connection in time. Without time there would be no points to connect. There is therefore no instant of time apart from a position in space, and no point of space except in an instant of time. The point occurs at an instant, and the instant occupies a point. The ultimate stuff of the universe is thus of the character of point-instants or pure events, and it is so that we get our continuum. The correspondence is, however, not a one-to-one, but a many-one, correspondence. For one point may occur at more than one instant, and one instant may, analogously, occupy several points.

Prof. Alexander thinks that he is here in full accord with Minkowski's well-known conception of an absolute world of four dimensions, of which ordinary geometry omits the fourth, the time element. When he wrote his book Einstein's doctrine of relativity was only fully known in its first form, the "special" theory, and Prof. Alexander believes that his view of the character of the space-time continuum has left him free to accept the so-called principle of relativity in this form.

For it suggests really no more than the unification of the observations of two sets of observers who may be observing an absolute world in space-time, by means of formulas of transformation in which the observations of observers with one system of co-ordinates can be rendered in terms of the co-ordinates of observers with a different system. 'It may be, he says, that the formulas are not really independent, inasmuch as they are ultimately numerical, and numbers may be wholly dependent on an absolute space and time system. Thus it would be an absolutely identical set of relations which was observed from the two systems of reference, moving rectilinearly with a relative velocity which remained uniform.

But can this be accepted in the fresh light cast by the general theory of relativity, of which the special theory is now shown by Einstein to be a mere special case? Here metaphysicians have to look over a fence into ground at present mainly occupied by the mathematician. But not exclusively so occupied. The ground is in truth a borderland where mathematics and epistemology trench on each other, and the fence is not of barbed wire. We are, indeed, compelled to try to do the best we can with unfamiliar topics if we would get at the truth about the nature of reality. The relativity doctrine now extends to accelerating motion. It has also, apparently, been demonstrated that a principle of equivalence obtains according to which any changes which an observer takes to be due to what he supposes to be attraction within a gravitational field would be perceived by him in precisely the same way if the observer's system of reference were moving with the acceleration which was characteristic of the gravitation at the observer's point of observation. The combination of these principles gives us relativity of measurement in actual experience without restriction. The gravitational principle is, in addition, here based, not on a supposed elementary law of gravitational force, whatever that means, which would leave us in metaphysical perplexities about action at a distance, but on elementary laws of the *motion* of bodies relatively to each other in a so-called gravitational field. There is no decision either for or against Euclidean geometry as a possible special case. But there is a decision that space, as a physical thing with unvarying geometrical properties, is to be banished, just for the same sort of reasons as the æther was banished before it. Only observable things are to be recognised as real in the new system of modern physicists.

It is therefore asserted by Einstein that, all motions and accelerations being relative to the system of reference of the observer, neither space

nor time has physically independent objectivity. They are not measurable in themselves. They mean only the framework in which the minds of the observers arrange physical events, according to the conditions under which observation takes place. We may choose such frameworks as we please, but in point of fact we naturally choose so that the application of our method is the one that appears best adapted to the character of what we observe. The standard used will give their physical significances to our "geodetic lines." The apparent order in space and time has no independent existence. It manifests itself only in the events that present themselves as so ordered.

But the revolution in conception does not stop here. As so-called "gravitational fields" are everywhere present, the old special theory of relativity is nowhere an accurate account of phenomena. The velocity of light, for instance, cannot really be constant under all conditions. It is the things we observe in space and time that give to these their definite structure, and the relations in them of the things depend on the system of observation. To get at the fundamental law of the change which takes place in the space-time continuum we must look for the principle which governs the motion of a point in it as of the form of a differential law for the motion of such a point, not merely in a straight line in the Euclidean sense, but in a geodetic line which will be relative to any possible form of motion and acceleration in a gravitational field. If we can reach such a differential law under the aspect of an equation sufficiently elastic in its variables, we shall be able to fit into it mathematical expressions based on actual observation which give the "gravitational potentials" required for the application of the law. The form of the differential equation which expresses the law must therefore be such as to be applicable whatever may be the four co-ordinates of reference of the observer of motion in any conceivable gravitational field. The principle of equivalence necessitates this, and we get as the result a science of motion depending on the relativity of every kind of motion. All that is required is that the co-ordinates which are the variables in the equation of motion of a point-mass moving uniformly and rectilinearly should be so expressed as to be capable of transformation into the co-ordinates, whatever their shape, of any system of reference which moves in any path and has any accelerated motion whatsoever. This appears to have been done completely. The result is intelligible to the epistemologist who can even do no more than look across the boundary fence. The mathematical details and scaffolding he may be wholly unable to appreciate.

But not the less does he feel compelled to take off his hat reverently before the shades of Gauss and Riemann, and before those who have been able to wield the mighty sword with which these great thinkers cut the knots that held physicists back from the unrestricted calculus of to-day, purified as it now is from the old assumptions.

Now the importance of this thorough-going application of the principle of the relativity of the character of the point-event continuum to the observer is obvious. It means relativity in significance for intelligence. As Prof. Eddington has recently remarked in a notable article in *Mind*, the intervention of mind in the laws of Nature is more far-reaching than is usually supposed by physicists. He develops this conclusion in a fashion which is impressive. Freundlich and Schick in their recent books insist on the same thesis.

But what does the word "mind" mean when used thus? Not a substance in space-time, as Prof. Alexander would have it. To start with, such an assumption would involve either the rejection of the modern doctrine of relativity as the school of Einstein has put it forward as dependent on interpretation, or something tending towards solipsism. Nor can mind mean substance in another aspect, that in which Berkeley and the Mentalists have sought to display it. Few competent students of the history of thought look on philosophy as shut up to such a view, the view which New Realism seeks to bind into the "egocentric predicament."

There is another interpretation of the meaning of mind in which it signifies neither any of these things nor yet an Absolute Mind apart from that of man, but just our own experience interpreted as being in every stage relative in its presentation, and not so merely in the relation of measurement. For Einstein's doctrine seems to be only a fragment of a yet larger and even more striking view of reality. Relativity is surely not to be confined to judgments based on the co-ordinates we employ in measurement. It may equally arise in other instances from the uncritical applications of conceptions concerned with quality as much as with quantity. From such a point of view reality, including human experience, is what it is only because we are ever unconsciously, under the influence of practical ends to be attained, limiting our systems of reference, interpreted in even a wider sense than that of Einstein. These may be limiting ends imposed on us by the mere fact that we are human beings with a particular position in Nature. The relativity of knowledge will thus assume the form of relativity of the real to general points of view, and will result in a principle of degrees extending through all knowledge

and reality alike, which fall short of ideal completion. It is an old principle, as old as Greek thought. If it is true, it solves many problems and gets rid of the distinction between mental and non-mental, between idealism and realism, between mind and its object. For it accepts the "that," and confines the legitimate problem to the "what." It also gets rid of the perplexing idea of an Absolute Mind as something to be conceived as apart from us while working in us.

The idea and the method, recurring as they do in ancient and modern philosophy, are worth study by those who feel the stimulus of the new atmosphere which Einstein has provided. They may find a convenient analogue to the special principle of relativity in Kant's "Critique of Pure Reason," with its investigation of the general conditions which are required in order to render any individual experience possible. If they seek for an analogue to Einstein's general principle, they may look either in the "Metaphysics" of Aristotle or in the "Logic" of Hegel. The greatest thinkers have presented resembling conclusions in varying language.

This path is one that is not easy to tread. It is as hard to enter on as is that of the metaphysician who has to try to understand the meaning for philosophy of the absolute differential equations which Einstein employs. Prof. Alexander, however, knows the direction, if he does not now look that way. And it may be that the difficulties with which the new principle of general physical relativity seems to threaten New Realism, with its non-mental and static reality, may lead him, with his openness of mind, to consider once again whether he should not wend his steps afresh towards the wicket-gate for a further pilgrimage. But whatever the direction in which he is looking, his new book is full of stimulating material, even as it stands.

HALDANE.

### Principles and Practice of Surveying.

*Surveying.* By W. Norman Thomas. Pp. viii + 536. (With Answers.) (London: Edward Arnold, 1920.) Price 31s. 6d. net.

ALL British surveyors will give the heartiest welcome to this excellent book. We have become accustomed to American and German survey literature, and have relied too much upon it. The author has gone far to relieve us of this necessity. He succeeds admirably in emphasising the importance of a due appreciation of the errors involved, and his mathematical investigations and notes on the accuracy of each method are clear and convincing.

The matter sequence is curious. We start with chain surveying and do not reach triangulation until p. 377. Surveys for purely engineering ends are often limited in extent, but none the less each method has suffered from being considered on its own merits and not as part of a whole. Geodesy and topographical surveying are barely mentioned.

We start with the field work, plotting, and area computing of chain surveys. The subject is clearly put, and the investigations of errors and of the accuracy of linear measurement are particularly valuable. It is curious to find reference in this chapter to British war maps, which owed none of their characteristics to chaining. The chapter on optics and on magnetism is welcome, though it might with advantage have gone further. After a description of instruments of minor importance and of the vernier and micrometer microscope, the author deals with theodolites, omitting mention, unfortunately, of Messrs. Watts and Co.'s latest patterns, which embody many improvements. Adjustments are fully described, and are followed by a few pages on the accuracy of angular measurements and on geodetic results.

Having already dealt with linear measurement, the author confines his description of traverses mostly to angular measurement by compass, dial, or theodolite. The investigation of errors of closure is valuable and includes an interesting mathematical analysis of Bowditch's rule. The surveyor who traverses between stations of an existing triangulation will find little help, however, for the problems which then arise are practically ignored. Two consecutive chapters deal with levels, levelling, contouring, trigonometrical levelling, and various relative and absolute methods of determining altitude. Mention is made of the Zeiss patterns of level in use on the Ordnance Survey, but there is no mention of the "water level" for contouring purposes. As usual, the student will have no excuse for failing to understand the relative values of different levelling methods. There is a brief mention of precise levelling generally, including a note on the new geodetic levelling of Great Britain. Tacheometry is thoroughly dealt with, the optics and attainable results being lucidly described, and leads on to range-finders, with special reference to the "Barr and Stroud." The chapter on plane-tableing is not so convincing as the rest, and is all too short. The plane-table has been used with success in climates as difficult as our own, and is an indispensable method of survey.

Chapters on curve ranging, earthwork calculations, and hydrographic surveying contain well-arranged information rarely to be met with elsewhere. It is under hydrographic surveying,

curiously enough, that one finds a description of instrumental resection. As a subject it deserves more attention than it gets, and should not be confined to a solution from three points. Triangulation and base measurement are well dealt with and illustrated by historical references. The experienced surveyor will find little fresh information on astronomical surveying (except an interesting note on Driencourt's prismatic astrolabe), but will relish the simple and yet thorough way in which the theory is put.

The concluding chapter, on photogrammetry, deals with the photo-theodolite and contains a brief reference to stereophotogrammetry and to aeroplane photography. The get-up, printing, and paper are a pleasure to see. All surveyors should possess a copy of this book.

H. S. WINTERBOTHAM.

### Australian Hardwoods.

*The Hardwoods of Australia and their Economics.*

By Richard T. Baker. (Technological Museum, New South Wales: Technical Education Series, No. 23.) Pp. xvi + 522 + plates. (Sydney: The Technological Museum, 1919.)

THE author states in the preface to this work that his object is to make known to Australians and the world generally the diversity of the hardwoods with which Nature has endowed the vast Australian continent. Such a book can scarcely have been introduced at a more opportune time, when the problem of how to provide sufficient timber for the world's growing needs has become increasingly acute since the war. It is a remarkable fact that, while Australia has probably the largest variety of hardwoods in the world, covering hundreds of thousands of square miles, the number of species they represent is comparatively few—probably less than 500. Moreover, nearly half of these belong to the genus *Eucalyptus*, which covers at least two-thirds of the whole surface, and supplies the bulk of hardwoods required for commercial purposes.

The book is divided into three main sections. Part i. deals with the physical properties of timber, colour, grain, taste, odour, structure, weight, durability, combustibility, and other features. The author emphasises the great aid afforded by colour in the identification of Australian woods, and the fine series of chromatic plates scattered through the volume, illustrating the newly planed surface of all the important timbers, shows in a very striking manner the great beauty and variety of these woods. The writer of this notice has had an opportunity of comparing a number of these plates with specimens in the

fine collection of Australian woods at the Imperial Institute, and can vouch for their accuracy as regards both colour and delineation. Every timber has a distinct colour, though at times this is far from easy to describe in the absence of any standard colour nomenclature; in such cases coloured plates are a great help. Some of the colour terms seem to be used in a rather loose sense. The author employs eight types—(1) dark red, (2) red, (3) pink, (4) grey, (5) chocolate, (6) yellow, (7) pale, (8) white—but on comparing some of the plates we find it hard to draw the line between the types pink and pale, while some of the timbers described under the heading of white would be more correctly termed buff-coloured. The illustrations in black-and-white showing wood anatomy should also be a material aid to identification.

In part ii. we have a description of each species in botanical sequence, followed by a list of timbers arranged in grades of hardness. Part iii. contains technical articles on (i) the determination of specific timbers; (ii) nomenclature; (iii) the seasoning of timber; (iv) the preservation of timbers, concluding with an account of the economic uses of the woods. The book contains a vast amount of information useful to both foresters and students.

The typographical arrangement is somewhat open to criticism. The use of unnecessarily large types for specific names and authorities, with a wide margin, entails a great waste of space, and makes the book rather cumbersome. On the other hand, the systematic portion of the work might with advantage have been in larger type. These minor defects, however, do not detract from the general excellence of the book.

Mr. Baker is to be congratulated upon a valuable addition to the literature of Australian forestry, which should bring home to Australians the importance of preserving these many valuable woods from the extinction which threatens them by a well-devised and vigorous scheme of re-forestation.

A. B. J.

### The Columbian Tradition.

*The Columbian Tradition on the Discovery of America and of the Part Played therein by the Astronomer Toscanelli: A Memoir addressed to the Profs. Hermann Wagner, of the University of Göttingen, and Carlo Ervera, of Bologna.* By Henry Vignaud. Pp. 62. (Oxford: At the Clarendon Press, 1920.) Price 3s. 6d. net.

IN various publications, especially in his "Histoire de la Grande Entreprise de Christophe Colomb" (Paris, 1911, 2 vols.), Mr. Vignaud has endeavoured to upset the traditional view of the

discovery of America. According to that view, Columbus set out in 1492, not to discover unknown lands, but to reach the eastern parts of Asia by sailing westward across the Atlantic, having already in 1474 been encouraged to do so by the well-known astronomer Toscanelli of Florence. In this pamphlet Mr. Vignaud has again summed up the results of his studies and defended them against the attacks of his two principal opponents.

All we know about Columbus and the object of his first voyage comes from himself or his son or his blind admirer, Las Casas, and not one of these is a trustworthy witness, as the exposure of various falsehoods told about the family and early history of Columbus has proved. No trace exists of Columbus ever having spoken of going to Eastern Asia before he returned from his great discovery; but that idea is spoken of in a letter to the "Catholic Kings," which Las Casas placed as a preface to the log-book of the first voyage. This letter is, however, neither found nor alluded to elsewhere, and bears no date. In the log-book Columbus says that his sole object is *las Indias*, but that book was edited by Las Casas, and in the days when he wrote, this expression only meant the Antilles and neighbouring lands, and never the East Indies. Columbus, when leaving Palos, did not sail straight across the Atlantic, as would have been natural if his goal had been "Cipangu" (Japan), or "Cathay" (China); he first went down to the Canaries and then sailed straight westward along the 28th parallel. At 700 or 750 leagues west of the Canaries he fully expected to find land, and was greatly disturbed when none was seen, so that he must have had some private reason to believe that there were islands near that spot; and the discovery of these would seem to have been the sole object of the voyage. It has been objected to this that Columbus (according to Las Casas) carried with him credential letters for the "Great Khan." But it is known that his partner, Pinzon, had some idea of going in search of Cipangu. Mr. Vignaud suggests that it was to secure the indispensable co-operation of Pinzon that Columbus included the visit to Cipangu in his plan, but that when he only found land much further west than he had expected, he believed that what he had found was Cipangu, a belief which he kept to his dying day.

With regard to the alleged letter and map of 1474, attributed to Toscanelli, these were never alluded to by Columbus himself; and the copy of the letter found at Seville in 1871 was probably not written by him, but by his brother. The information in the letter (the map is lost) is such

as a distinguished *savant* would have scorned to supply, while it is quite in accordance with Columbus's own geographical ideas derived from the antiquated "Imago Mundi" of Cardinal d'Ailly. The letter was probably fabricated by the family of Columbus after his death to disprove the rumour that he owed his success, not to his studies in cosmography, but to some information about unknown islands privately obtained. The true glory of Columbus is that he found what he went out to find—a New World. J. L. E. D.

### Our Bookshelf.

*Electricity: Its Production and Applications.* By Reg. E. Neale. (Pitman's Common Commodities and Industries.) Pp. viii+136. (London: Sir Isaac Pitman and Sons, Ltd., n.d.) Price 2s. 6d. net.

The author addresses himself to the general reader who desires to understand something of the way in which electricity is produced and is utilised in present-day industries. The generation, distribution, and storage of electric power are first explained briefly, and then the author passes on to deal successively with lighting, heating, electric driving of machinery, traction, haulage, etc. Further chapters skim lightly over the leading features of electrochemistry, electrometallurgy, electric welding and cutting, telegraphy and telephony, and medical applications. So large a field can be covered in a little volume like this only by limitation to the barest essentials, but it is remarkable how complete and accurate is the information given. The reader is, however, hurried on unpleasantly fast, and is never allowed to pause where his interest is aroused. We are not as a rule over-fond of "tabloid" education, but the ubiquitous use of electricity in industry and daily life makes it desirable for everyone to know something of its nature and scope. It will be an advantage to many to have at their disposal so well compiled a summary of the subject rather than to rely on the loose statements too often made in conversation and in the non-technical Press.

*The Nature-study of Plants in Theory and Practice for the Hobby-Botаниst.* By T. A. Dymes. Pp. xviii+173. (London: S.P.C.K.; New York: The Macmillan Co., 1920.) Price 6s. net.

The first part of this book is devoted to an explanation of the meaning of the phenomena of plant life and its interdependent functions. Wherever possible, comparisons are drawn with human life, and, in consequence, chapters are given curious titles, such as "Marriage" and "Settling Down for Life." The second portion of the book is a detailed account of the life-history of the Herb Robert and its relatives. Tables are appended showing the separation of the sexes in time, the mode of pollination, and the method of seed dispersal of British species of

Cranesbills and Storksills. The book should be a stimulus to intelligent and intensive Nature-study.

*Eugenics, Civics, and Ethics: A Lecture delivered to the Summer School of Eugenics, Civics, and Ethics on August 8, 1919, in the Arts School, Cambridge.* By Sir Charles Walston (Waldstein). Pp. 56. (Cambridge: At the University Press, 1920.) Price 4s. net.

A STRONG plea is made in this lecture for the organisation and development of the study of ethics, or, as the author prefers to call it, ethology. The interdependence of eugenics and civics, and the foundation of both in ethics, are discussed, and warning is given against striving to produce the perfect physical specimen of man without due consideration of character and mental attributes. Towards the end of the lecture the progressive nature of ethical codes is made clear, and great stress is laid on the importance of the establishment of our ideal of the perfect man and the teaching of such practical ethics in both schools and homes.

*A Second Book of School Celebrations.* By Dr. F. H. Hayward. Pp. 133. (London: P. S. King and Son, Ltd., 1920.) Price 5s. net.

"A FIRST BOOK OF SCHOOL CELEBRATIONS" was reviewed in NATURE for August 5. The new volume contains a further series of celebrations dealing with the military conflicts in Palestine, toleration, Alfred the Great, Pasteur and Lister, Sir Philip Sidney, G. F. Watts, Empire Day, political parties, school leaving day, work, and five of a new type, termed by the author "homage celebrations," which deal with the artist, the martyr, the musician, Ireland, and Poland.

*Stories for the Nature Hour.* Compiled by Ada M. Skinner and Eleanor L. Skinner. Pp. 253. (London: George G. Harrap and Co., Ltd., 1920.) Price 5s. net.

A NUMBER of short stories from the pens of many authors have been collected in this volume. Hans Andersen, Ruskin, and Charles Lamb are represented, and the compilers themselves have supplied eight legends. The book should be useful to the teacher giving lessons on natural history subjects to small children, and should also make interesting reading for older children.

*A Manual of Elementary Zoology.* By L. A. Borradaile. Third edition. Pp. xviii+616+xxi plates. (London: Henry Frowde, and Hodder and Stoughton, 1920.) Price 18s.

The last edition of this work was reviewed in NATURE for April 3, 1919. The only important change made in the new edition is the inclusion of twenty-one large plates, most of which are particularly valuable for laboratory work. Plate xii, showing various breeds of British sheep, is crude, and seems unworthy of a place in a book which is otherwise remarkable for its clear diagrams and realistic illustrations.



*Le Radium: Interprétation et Enseignement de la Radioactivité.* Par Prof. Fr. Soddy. Traduit de l'Anglais par A. Lepape. (Nouvelle Collection scientifique.) Pp. iii+375. (Paris: Félix Alcan, 1919.) Price 4.90 francs.

THE third edition of Prof. Soddy's book, "The Interpretation of Radium," which was reviewed in NATURE for February 20, 1913, is the original from which this translation was made. The translator has added an appendix in which the work of the period 1914-19 is described, and consequent modifications of theory are indicated.

*Grasses and Rushes and How to Identify Them.* By J. H. Crabtree. Pp. 64. (London: The Epworth Press, n.d.) Price 1s. 9d. net.

THIS little book is a catalogue of all the grasses and rushes of the English countryside. A brief description, accompanied by an illustration, is given of each plant mentioned. The book should be of value to both farmers and students.

*Experiments with Plants. A First School-book of Science.* By J. B. Philip. Pp. 205. (Oxford: At the Clarendon Press, 1919.) Price 3s. net.

MOST of this book is devoted to the experimental study of the elementary physiology of seeds and plants. An account of the reproductive process is included, and the elementary physics and chemistry of soils are briefly indicated. In the appendices a sketch is given of the scientific principles which are necessary to a study of botany. An index would have been a useful addition to the book.

*Aluminium: Its Manufacture, Manipulation, and Marketing.* By G. Mortimer. (Pitman's Common Commodities and Industries.) Pp. viii+152. (London: Sir Isaac Pitman and Sons, Ltd., n.d.) Price 2s. 6d. net.

THIS interesting book gives a particularly good account of the numerous applications which aluminium now finds in modern industry. The technical processes for the extraction of aluminium and its adaptation, both in the pure state and in the form of alloys, to industry are carefully and fully described. The book is well illustrated, and cannot fail to be of interest to chemists, engineers, and the general reader.

*Chemical Theory and Calculations: An Elementary Text-Book.* By Prof. F. J. Wilson and Prof. I. M. Heilbron. Second edition. Pp. vii+144. (London: Constable and Co., Ltd., 1920.) Price 4s. 6d. net.

THIS is an admirable collection of problems covering a wide range, and including many of an advanced character. A pleasing feature is the brief but lucid account of chemical theory, including a short section on atomic numbers. The book should prove of great service to teachers and to students preparing for degree examinations. It is distinctly better than most books on chemical arithmetic, since it aims at a higher standard.

## Letters to the Editor.

[The Editor does not hold himself responsible for opinions expressed by his correspondents. Neither can he undertake to return, or to correspond with the writers of, rejected manuscripts intended for this or any other part of NATURE. No notice is taken of anonymous communications.]

### University Grants.

I AM glad to see that the very urgent necessity for the provision of increased University grants which was so ably stated in your leading article of August 5 has led to the position in Leeds and Birmingham being brought forward so clearly by Sir Michael Sadler and Principal Grant Robertson in NATURE of August 12 and 19. There can be no doubt that every university in the country is feeling the need of largely increased financial assistance, without which it will be impossible to carry on efficiently, if at all, departments such as those of science, which must always be a source of large expenditure and financial loss to any university.

It is probably generally true that the higher the efficiency of a department, the greater is its cost of maintenance, and, consequently, the greater the financial loss to the university. Therefore, so long as reasonable economy in administration is practised, the expenditure of money on a successful department should be welcomed and encouraged, and every effort made to provide funds so that its work may have free scope and not be hampered in any way. Only under conditions of proper equipment as regards both staff and material and freedom from financial worry can a department be expected to develop to its fullest extent and to produce knowledge.

In the *Times* of August 18 Prof. Soddy and I directed attention to the critical condition of science at Oxford, and pointed out that there is actually no proper accommodation here even for the teaching of physical and inorganic chemistry. The antiquated buildings which are now used for the purpose are quite out of date, besides being far too small to cope with the large number of students who are presenting themselves for the honours degree.

The case of organic chemistry is also very serious because, although the laboratory which was built four years ago, largely owing to the generosity of Dr. C. W. Dyson Perrins, is modern and well-equipped, it is far too small.

A new extension is in course of construction, but the funds necessary to pay for it are not available, and must be borrowed, and there is, moreover, no adequate endowment to provide for upkeep when the buildings are completed. A similar state of things is to be found in connection with the new chair of biochemistry recently endowed through the generosity of Mr. Edward Whitley. There are no laboratories associated with this chair, and in the meantime accommodation must be provided in the already overcrowded physiological laboratories. A careful estimate of the cost of urgently required new buildings shows that at least 250,000*l.*, as well as an endowment bringing in 10,000*l.* per annum, must be forthcoming if the study of chemistry is to be placed on a firm basis in this University.

I have dealt more particularly with chemistry because it is generally admitted that the most pressing need in this University is that chemistry shall be placed on such a footing that teaching and research may be done under conditions very different from those which prevail at the present time. But the other branches of physical science are also urgently in need of financial assistance, partly for new build-

ings and partly to provide funds sufficient to maintain and work them.

There are clearly only two sources from which the very large sums required by the universities can be obtained, and those are (1) Treasury grants and (2) private benefactions.

You have pointed out that the proposed Treasury grant of 1,500,000*l.* included in the Estimates for 1921-22 is quite inadequate, and it is obvious that this must be the case. It is, therefore, to be hoped that careful inquiry into the needs of the universities by the Treasury will result in this sum being substantially augmented. With regard to private benefaction, I think we may look forward with confidence to very liberal response in the near future from generous individuals, and more particularly from wealthy firms interested in the progress of science and education. The action of Messrs. Brunner, Mond, and Co. in setting aside 100,000*l.* as a contribution to the universities is an example which will certainly be followed by other firms who owe much of their success to the work of chemists, engineers, and others sent to them from the universities.

If it were to become a recognised practice for firms who can afford to do so to set aside yearly some comparatively small sum as a contribution to the universities, the combined effort would go far to solve the difficulties in which we find ourselves at the present time.

W. H. PERKIN.

The University Museum, Oxford, August 22.

#### Use of Sumner Lines in Navigation.

MAY I venture to point out, in the interests of navigational science, that although the article by Capt. Tizard in NATURE of July 1 under the above title is an admirably clear and concise account of the application of Sumner lines in navigation at the date given in his examples, it is scarcely descriptive of the best practice of to-day?

Of the two methods of drawing the lines described by Capt. Tizard, the first, or "original Sumner method," is now merely of academic interest, and is seldom practised outside schools and examination-rooms. Its defects are, first, that each sight has to be worked out twice (once for each of the two assumed latitudes), and, secondly, that it is inapplicable to sights taken near the meridian. It may also be remarked that unless the two assumed latitudes are very close together, the true circle of position may differ considerably from the straight line joining the two points found on the Mercator chart.

The second method described by Capt. Tizard, usually known as the "chronometer method," is still used to some extent. It avoids the double working out of each sight, but gives good results only for observations taken on large bearings; it is inapplicable to sights taken near the meridian.

For observations near the meridian what is called the "ex-meridian method" may be used to draw the position-lines. In this method the longitude is assumed, and the sight is worked out as a latitude observation; the position-line is then drawn, at right angles to the bearing, through the point where the meridian of the assumed longitude is cut by the parallel of the observed latitude. This method gives good results for sights near the meridian, but fails on large bearings.

A combination of the last two methods is sometimes employed, the sights near the meridian being worked out by the "ex-meridian method," and those on large bearings by the "chronometer method." This combined procedure has been advocated by several writers, especially by Capt. Blackburne, who

undertook the immense labour of computing tables specially adapted for the purpose. The main objection to it is that the procedure is not uniform for all sights.

A much better method of drawing the Sumner lines than any of the above, and one which seems destined to replace all others, being now in extensive use by navigators of all nations and recognised as the standard method in the Royal Navy, is known as the Marq<sup>c</sup> Saint-Hilaire method, or the "new navigation." It consists in assuming a dead-reckoning position in both latitude and longitude, and then finding how much the observed zenith-distance of a heavenly body differs from that calculated on the assumption that the dead-reckoning position was correct. The difference between the observed and calculated zenith-distances is laid off from the assumed position in a direction to or from the observed object (according as the observed zenith-distance is less or greater than the calculated one), and the position-line is then drawn through the point so found at right angles to the bearing. The great advantage of this method is that it is perfectly *general*; it gives equally good results whatever the bearing of the object sighted.

Though called the "new navigation," the Marq<sup>c</sup> Saint-Hilaire method of drawing the Sumner lines is by no means a recent invention, having been used in the French Navy for more than forty years. Its advantages were advocated so long ago as 1888 by that indefatigable worker for the advancement of navigation, the Rev. William Hall, R.N., and have since been frequently pointed out by other English writers on navigation. Its superiority over all other methods for drawing the Sumner lines or position-lines being indubitable, there is a little difficulty in understanding its comparative neglect by British navigators up to recent times. One reason, no doubt, is conservatism; the British seaman usually prefers to use time-honoured methods with which he is familiar rather than to adopt new-fangled notions, and fears to risk his ship by the possibility of making a mistake in a process with which he has not been made acquainted during his early training. Another reason which operated powerfully until within the last twenty years or so was the absence of any tables for facilitating the calculation of altitudes comparable in scope with the tables of Davis and Burdwood, which so greatly helped in the rapid reduction of sights by the "chronometer method." This last difficulty was removed by the publication of the excellent "Altitude Tables" of my namesake, the Rev. F. Ball, M.A., of the Royal Navy, and at the present time it is just as simple a matter to work out sights by the "new navigation," with the aid of these tables, as it was to work the old "chronometer method" with the help of Burdwood and Davis.

Until within the last decade it was seldom worth while to attempt to fix a ship's position at sea within a mile or two, because so long as the longitude, whether found by Sumner lines or by any other method, was dependent entirely on the Greenwich time as found by the transport of chronometers over long distances, it was usually impossible to be sure of the longitude within that amount, no matter how accurately star observations were made. This difficulty affected the hydrographic surveyor as well as the navigator; and, indeed, it provides the explanation why so many charted longitudes—down the Red Sea, for instance—are in error by a mile or more. But nowadays, when wireless time-signals enable the error of a ship's chronometer to be found daily with an accuracy of a few tenths of a second anywhere on the seas, there is no reason why the longitude should

ever be uncertain by so much as the tenth of a mile, provided only that sights can be taken with a corresponding degree of accuracy. Thus the advent of wireless telegraphy, by removing at one stroke the most serious of all pre-existing limitations to precision in the results, has made it worth while to improve the methods of position-finding at sea. Simultaneously progress has been made in the construction of charts and instruments adapted for navigation, giving to the navigator another stimulus towards attaining that refinement of method by which alone he may hope to steer his ship from port to port not only in safety, but also with that economy of time and fuel which is demanded by modern competition.

As regards the number of position-lines required to determine a ship's position, it is obvious that if only two sights are taken, no matter how favourable the angle at which the position-lines cut each other, the position found will be correct only if the observations are free from instrumental and other errors, and if dip and refraction are correctly allowed for. With only two sights a large unknown centring error in the sextant employed, or abnormal refraction, or a mistake in one of the sights, may render the position found quite false, and there is no means of detecting the error. If the two sights are not simultaneous or nearly so, there will, of course, be an added uncertainty in the position due to the difficulty in accurately estimating the ship's run in the interval. If three sights are taken constant errors can be eliminated, but accidental errors cannot be readily detected. If four sights are taken, however, as nearly as possible simultaneously, on bearings differing by approximately  $90^\circ$ , not only will a constant error of even two or three minutes in the measured altitudes, or in the allowance for dip, be without influence on the accuracy of the result, but if a mistake has been made in one of the sights the fact can readily be detected. This is a powerful argument for making the astronomical determination of a ship's position depend, whenever possible, on at least four Sumner lines or position-lines deduced from observations of four stars differing by approximately  $90^\circ$  in bearing.

It can easily be proved geometrically that when the altitudes of three or more stars have been equally accurately observed, the most probable position is the centre of that circle which most nearly touches all the position-lines, and in which the directions of the stars from the points of contact are either all towards or all away from the centre; also, that the radius of the circle gives the amount of any constant error in the observed altitudes, whether due to errors of the sextant employed or to error in the assumed dip of the horizon or refraction. If with more than three sights no circle can be drawn satisfying the condition of approximately touching all the position-lines, while at the same time having the star-directions from the points of contact pointing either all towards or all away from its centre, then it is certain that a mistake has occurred in one or more of the observations; either an altitude or a time has been wrongly recorded or one of the stars wrongly identified, or else there has been a mistake in the calculation for one or more of the sights.

The importance of considering the directions of the stars, as well as the position-lines themselves, is well illustrated by reference to the first of the examples given by Capt. Tizard. If the non-intersection of the three position-lines in his Fig. 1 is due to a constant error in all the altitudes, caused either by instrumental error or by error in the tabular allowance for dip or refraction (as will usually be the case in sights taken by a practised observer), then

the true position is not, as might at first be thought, within the little triangle formed by the crossing of the lines, but *outside* it; and the true longitude is not  $145^\circ 4'$ , as Capt. Tizard concludes, but  $145^\circ 5'$ . For, as will be seen by Fig. 1, on which I have indicated the star-directions by arrows, no other circle than the one shown can be described so as to touch all three position-lines, while the three star-directions from the points of contact point either all towards or all away from its centre.

So great is the importance of accuracy in the fixing of the ship's position at sea in modern navigation, and so well is the "new navigation" with four position-lines crossing at about  $90^\circ$  adapted to secure this accuracy, that at the recent International Hydrographic Conference in London it was proposed by an eminent authority, Comdr. Alessio, of the Royal Italian Navy, that it would be desirable for the conference to prescribe as a fundamental rule of navigation that "the normal astronomical determination of a ship at sea must be made with the method of four Sumner lines by observing four stars the position-lines of which cut at approximately  $90^\circ$ ." It was decided that the prescribing of rules for navigation did not fall within the scope of the 1919 Conference,

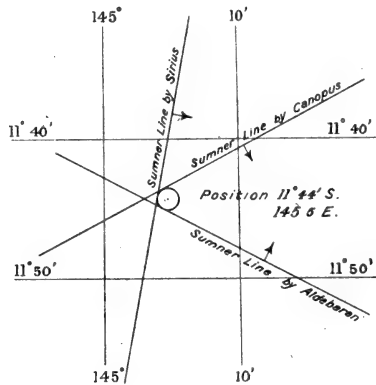

FIG. 1.

and consequently the matter was not further discussed. But there can be no doubt that if navigators of all nations could be persuaded to follow so excellent a rule as that suggested by Comdr. Alessio, it would add greatly to the safety of shipping. The method is so simple, and affords such security against error, that if it were once systematically taught in schools of navigation and included in the Board of Trade requirements for masters' certificates, it would probably by its own merits displace all other processes for fixing positions at sea under normal conditions. It would, of course, still be advisable to retain the ordinary meridian or ex-meridian sights for latitude and the morning or afternoon sights for longitude as a stand-by against the possibility of clouds or fog interfering with the twilight observations of stars, but whenever the suggested rule could possibly be followed it could be trusted to give far more accurate results than any observations of the sun.

A word may perhaps be added as to the manner of calculating the altitudes in the "new navigation." Comdr. Alessio (Report of the International Hydrographic Conference, London, 1919, p. 230) recommends logarithmic calculation with five-place tables,

using a formula which permits of a ready check. This only takes about five minutes for each sight, and is, no doubt, the best way; in fact, it is the only safe way where a very considerable degree of precision is aimed at. But most navigators prefer to avoid computation so far as possible by the use of tables, and in ordinary circumstances the altitude tables used in the Royal Navy will give sufficiently accurate results. The great defect of the tabular method is that one has to round off the dead-reckoning latitude to the nearest degree for the assumed position in order to enter the tables, and consequently the position-lines may extend over so great a distance on the chart that their curvature cannot properly be neglected. With logarithmic calculation, on the other hand, the actual dead-reckoning position can be taken as the assumed position, and the position-lines will then be so short that their curvature can be neglected without any perceptible loss of accuracy.

It may not be out of place to remark in conclusion that the utility of the Sumner line or position-line principle is not confined to position-fixing with a sextant at sea. I have shown in two recently published papers ("Notes on the Working of the New Navigation," Cairo, 1918, and "The Prismatic Astrolabe," *Geographical Journal*, July, 1919, p. 37) that the "new navigation" is capable of useful application on land in conjunction with theodolite observations and wireless time-signals, and that determinations of geographical position of very considerable accuracy may be made in this way. The method has since been put into practice by Dr. Hamilton Rice on exploratory land surveys in South America. (see the *Geographical Journal* for July, p. 59) with satisfactory results.

JOHN BALL.

Survey of Egypt, Cairo, July 24.

### Relativity and Hyperbolic Space.

OBSERVATION tells us that while gravitation dominates the history of a lump of matter moving in the vast ocean of free æther, it has practically no effect on the history of a pulse of light in similar circumstances. Since last mail I have investigated the bearings of space being hyperbolic on light-rays.

The central-projection map of the space, used before, in which  $r = \tanh \theta$ , where  $r$  is the radius vector of the map and  $R\theta$  the radius vector in the space, will be called a gnomonic map; planes are mapped as planes. If the projection used be given by  $r = 2 \tanh \frac{1}{2} \theta$ , the map will be called stereographic; small regions are mapped in correct shape, spheres and planes as spheres, and the two sheets of a pseudo-sphere as two spheres intersecting and making equal angles with the sphere representing the median plane, in a circle lying on the absolute,  $r = 2$ . (A pseudo-sphere is the locus of a point at a given distance from a given plane, called its median plane. The characteristic of the map-sphere which represents a plane is that it cuts the absolute  $r = 2$  orthogonally.) A point  $(x, y, z)$  on the gnomonic map becomes  $[x/(1+\frac{1}{2}r^2), y/(1+\frac{1}{2}r^2), z/(1+\frac{1}{2}r^2)]$  on the stereographic map.

The behaviour of a ray of light is fully described by saying that its path on the gnomonic map may be put in the form  $x^2/a^2 + y^2 = 1$ , where  $a$  is less than 1, and that the eccentric angle is  $t/R$ , where  $t$  is co-ordinate time. This ellipse really represents the two branches of a pseudo-circle; the ray goes out to infinity (in the space) along one branch and returns along the other, the complete circuit having the period  $2\pi R$ . The median line of the pseudo-circle

passes through the origin—that is, through the observer.

If from a given point rays start in all directions there will be a definite wave-front. For a finite time before  $t$  attains the value of a quarter-period,  $\frac{1}{4}\pi R$ , this front will form the single sheet of a true sphere the centre of which recedes to infinity, whereupon the front develops the two sheets of a pseudo-sphere, the one proceeding in the same direction as before, and the other, together with the median plane, returning from infinity, having been reflected back by the absolute. By the time  $t = \frac{1}{2}\pi R$  the median plane has just reached the origin, and the reflected sheet is chasing both the other sheet and the median plane back on the way to infinity. In the next quarter-period these motions are reversed in order of time, in direction of motion, and in position relative to the origin. At the time  $t = \pi R$  the front has contracted down to a point focus situated on the opposite side of the origin from the radiant point at a distance equal to that of the point. At the time  $t = 2\pi R$  the original circumstances recur, and everything is about to be repeated. A ray always moves normal to the front, although the centre of the true sphere and the median plane of the pseudo-sphere themselves move from and to infinity in a finite time.

All these motions can be exactly imitated in Euclidean space. Let, at a given point in such a space, the velocity of light be  $1+r^2/4R^2$ , the same in all directions, and let the sphere  $r=2R$  be a perfect reflector. Then light will in this medium behave exactly as does the light in the stereographic map (when the scale of that map is increased in the ratio of  $R$  to 1). Indeed, this seems the easiest method to get the differential equation of the path of a point in the hyperbolic space, for which  $\int dt$  is stationary. I may remark, however, that when the equation is obtained, later work is much simplified by changing the dependent to a form corresponding to the gnomonic map.

In the stereographic map the rays after an even number of reflections, by the absolute, form a system of coaxial circles through the radiant point and that point on the *opposite* side of the origin which is inverse to the sphere  $r=2$ . (For radiant point let  $0 = x - a = y = z$ . Then for the second point mentioned it is meant that  $0 = x + a = y = z$ . Ordinary inverse point would be  $0 = x - 4/a = y = z$ .) After an odd number of reflections they are similarly related to the focus mentioned above. The fronts are the spheres cutting these coaxial circles orthogonally.

ALEX. MCAULAY.

University of Tasmania, June 10.

### The Antarctic Anticyclone.

IN NATURE for August 5 Mr. R. F. T. Granger remarks: "The same conditions, *i.e.* the surface outflow and the central descent of air, exist in Prof. Hobbs's polar ice-cap anticyclone; the only difference is the physical origin."

In the case of the ice-cap there are other differences as well; the temperature is lower in the case of an ice-cap than in an anticyclone. The ice-cap conditions which resemble those of an anticyclone are, as Mr. Granger says, "surface outflow and the central descent of air." The differences are low temperature, low pressure, and different physical origin. My suggestion was that these differences made it inadvisable to call them both anticyclones.

R. M. DEELEY.

Tintagel, Kew Gardens Road, Surrey,  
August 18.

## A Method of Reaching Extreme Altitudes.

By ROBERT H. GODDARD, Professor of Physics, Clark College, Worcester, Mass.

IT is the purpose of the present article to state the general principles and possibilities of the method of reaching great altitudes with multiple charge rockets, from which the exploded gases are ejected with high efficiency.

### Fundamental Principle.

The basic idea of the method, briefly stated in general terms, is this: Given a mass of explosive material of as great energy content as possible, what height can be reached if a large fraction of this material is shot downwards, on exploding, with as high a speed as possible? It is evident, intuitively, that the height will be great if the fraction of material that remains is small and the velocity of ejection of the gases is high.

A theoretical treatment of the subject shows that, provided the speed of ejection of the gases is high, and the proportion of propellant is large, the initial masses necessary to raise a given mass to great heights are surprisingly small, but are enormously large if these conditions are not satisfied.

### Principles to be Applied in Practice.

(1) In order to apply practically the general principle above stated, there are three conditions that must be realised experimentally: First, the gases produced by the explosion must be ejected downwards with the greatest efficiency possible. This requirement must be met by burning the explosive in a strong combustion chamber, to which a tapered nozzle is attached, in order to obtain the work of expansion of the gases.

The apparatus used in the first experiments is shown in Fig. 1, in which P is the charge of dense smokeless powder, and B is the wadding. Three steel plugs were used, to vary the size of the powder chamber. The velocity of the gases

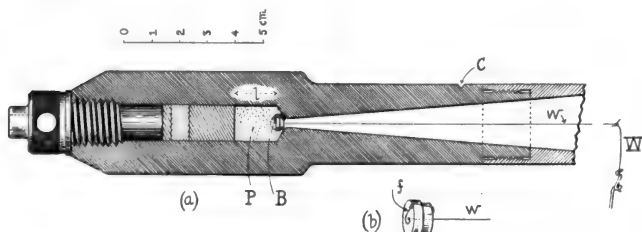

FIG. 1.—Chamber used in early experiments.

was measured by supporting the chamber in a ballistic pendulum, and observing the motion of the recoil.

It was found, by experiment, that the energy of motion of the ejected gases as compared with the heat energy of the powder could be increased very greatly over that for ordinary rockets, the

highest velocity being nearly 8000 ft.-sec., produced by the chamber shown in Fig. 2, whereas

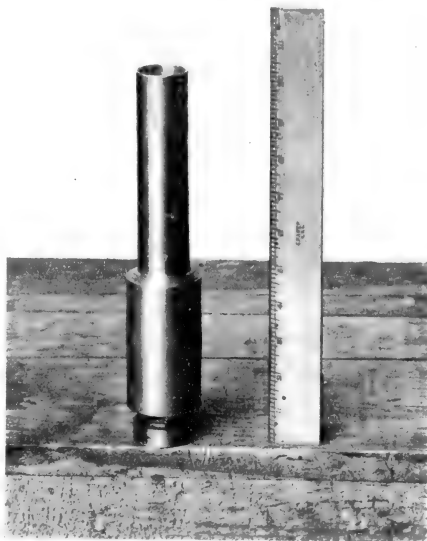

FIG. 2.—Chamber by which ejected gases were given a velocity of nearly 8000 ft. per sec.

for ordinary rockets the velocity is but 1000 ft.-sec. Incidentally, the energy of motion of the gases in the case under discussion is more than 64 per cent. of the heat energy of the powder, whereas for ordinary rockets the efficiency thus defined is but 2 per cent.

An interesting way of emphasising the magnitude of the velocity, 8000 ft.-sec., is to compare it with the "velocity of escape," or the "parabolic velocity" of planets. This velocity of escape is the velocity a body would require, projected upwards from a planet, in order to escape to infinity, and is a perfectly definite velocity, depending only upon the mass and diameter of the planet. For the moon the velocity is 1.5 miles per second, and for the planet Mars 3.0 miles per second. Thus if the chamber shown in Fig. 2 were placed upon the surface of the moon

and fired, *most of the gases would escape from the moon's attraction.* The highest velocity gases would without doubt (since 8000 ft.-sec. is only the *average velocity*) escape from Mars, if the planet had no atmosphere.

It should be remarked that, as shown by experimental results, the best form of nozzle has not yet been made, so that even 8000 ft.-sec. can be exceeded by further research.

(2) The heavy chamber, as mentioned above, while permitting high velocities of the ejected gases to be obtained, would be an actual disadvantage if a single charge were to be fired,

necessary that one or more rockets, really copies in miniature of the larger primary rocket, should be used if the most extreme altitudes are to be reached, in order that the above fraction will, *at no time during the ascent,* become small.

#### Summary of Results to Date.

The theoretical work, done at Princeton University in 1912, was not followed by experimental tests until 1915, at Clark University. The work has since been continued at Clark University, in the magnetic laboratory at the Worcester Polytechnic Institute, and at the

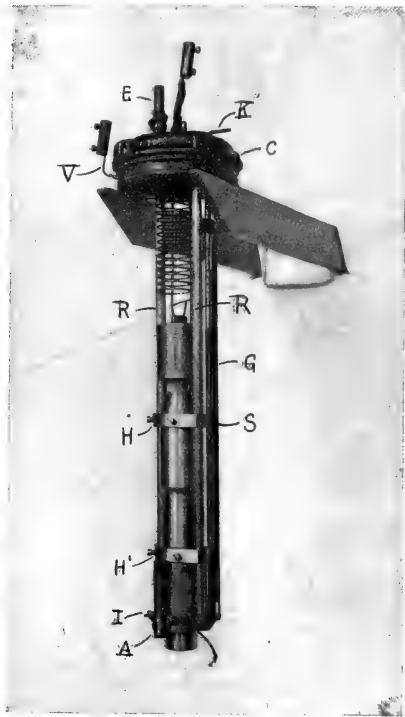

FIG. 3.—Chamber held in a support to test influence of air upon the propulsion of a rocket.

because of the large weight. It is necessary, then, that some means should be employed whereby charges may be fed successively into the same combustion chamber. If this is done it is evident that *most of the rocket can consist of propellant,* which is one of the conditions necessary for the attainment of great altitudes.

(3) When the magazine containing the charges just mentioned is nearly empty, it is easily seen that the propellant is no longer a large fraction of the entire mass of the apparatus. Hence, in order that the fraction shall remain large, it is

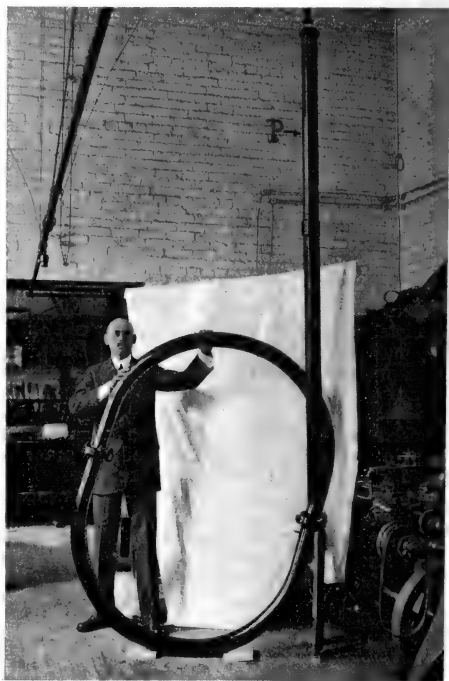

FIG. 4.—Pipe into which chamber was fired to a tank exhausted to a low pressure, the gases moving in a circular path until stopped by friction.

Mount Wilson Observatory in California—for the greater part of the time under a grant from the Smithsonian Institution.

The results of this work have shown, first, that most of the heat energy of even so powerful a propellant as dense nitroglycerine smokeless powder can be converted into kinetic energy of the ejected gases. They have demonstrated, secondly, that a multiple charge rocket can be made which will fire several charges in succession, is light and simple, and travels straight.

In order to demonstrate whether or not the rocket depended for propulsion upon the presence

of air, a large number of experiments were performed in which the chamber, Fig. 1, was held in a support, Fig. 3, and fired in a 3-in. pipe, P, on a large tank, Fig. 4, exhausted to a low pressure. These experiments demonstrated that the presence of the air was not necessary for reaction and that the recoil is produced by reaction from the high-velocity gases that are ejected. The operation of the jet *in vacuo* need not appear mysterious if one thinks of the ejected gases as a charge of fine shot moving with a very high velocity. Obviously the chamber will react, or "kick," when this charge is fired,

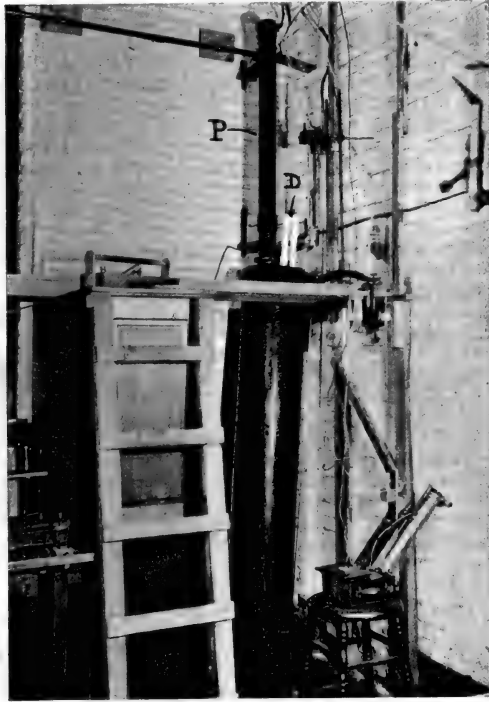

FIG. 5.—Tank in which the gases struck a coil of wire-fencing.

exactly as a shot-gun "kicks" when firing a charge of ordinary shot.

The gases were prevented from rebounding from the bottom of the tank, Fig. 4, by the form of the tank, the gases moving in a circular path until stopped by friction. Another tank, Fig. 5, was also used, in which rebound was prevented by the gases striking a large coil of  $\frac{1}{2}$ -in. mesh wire-fencing. The results with both tanks agreed down to the lowest pressure employed, 0.5 mm. of mercury, which is probably the pressure that exists at a height of thirty miles.

The figures given in the Smithsonian publication regarding the initial masses necessary to propel 1 lb. to various heights, such as 12.3 lb. for 430 miles, and 438 lb. for an "infinite" altitude (for the most favourable conditions, *in so far as they are set forth in that publication*), do not assume a larger velocity of ejection of the gases than has been obtained experimentally, but do assume a greater lightness than has so far been obtained. No attempt has, however, been made to reduce any part of the apparatus to the minimum weight possible, and it is believed that with further research such lightness as is assumed is realisable.

At the present time, the work that is being done is the developing of a rocket, of small size, for employing a large number of cartridges, or charges, and this is being done on the remainder of the original grant from the Smithsonian Institution.

#### Application of the Method.

The most important of the immediate applications of the method is in the providing of a simple and, when sufficiently developed, inexpensive means of obtaining meteorological data at the 10-kilometre level. It is well recognised that this is the most important level for studying pressure, temperature, humidity, and wind velocity; and any means of sending recording instruments rapidly into this region, and of obtaining data soon after the ascent has been made, is certain to be of value in weather forecasting.

At greater elevations the study of temperature, pressure, wind velocity, and composition of the atmosphere is of scientific importance, and also the study of the aurora, during the day as well as at night, and the radiations from the sun that are otherwise absorbed by the atmosphere.

A further application of much general interest is the possibility of sending a mass beyond the predominating gravitational field of the earth. Concerning the possibility of demonstrating this point by hitting the moon with a rocket, it can be said, apart from the questions of aiming and of correcting the flight, that the ignition of but a few pounds of flash powder should be visible in a powerful telescope, provided, of course, that the conditions of ignition were substantially the same as those in certain experiments described in a recent Smithsonian publication, in which  $1/20$  of a grain fired *in vacuo* was observed at a distance of  $2\frac{1}{2}$  miles.

Regarding these questions, as well as others which naturally follow, the writer believes that detailed discussion, before one has checked up matters completely by experiment, is unwise, for this merely precipitates a flood of useless argument, to which reply, in some form, must be made. The ideal method, which unfortunately is not always possible, is to solve a problem completely, as was done with the tests of the jet *in vacuo*, and then to state the results.

## New Aspects in the Assessment of Physical Fitness.

By DR. F. G. HOBSON, Department of Pathology, University of Oxford.

*A Physician in a great city seems to be the mere plaything of Fortune; his degree of reputation is for the most part casual; they that employ him know not his excellence; they that reject him know not his deficiency.*—SAMUEL JOHNSON.

THESE words might, with truth, have been written of Dr. John Hutchinson, one time physician to the Brompton Hospital for Diseases of the Chest. His earlier years devoted to the study of engineering, he later turned to medicine, and carried with him into his profession that enthusiasm for the accurate expression of scientific data which must have been engendered by his early training. In 1846 he published a paper "On the Capacity of the Lungs and on the Respiratory Functions" (1)<sup>1</sup>, in which he showed that he possessed the inspiration which is ever the mark of true genius, combined with the ability for accurate observation and the patient collection of data. He made the earliest investigations into the physiological effects of "forced breathing"; by means of a mercurial manometer he examined "expiratory force"; but interest lies for the special ends of the present subject in the extensive series of observations which he made upon the "vital capacity"<sup>2</sup> of more than 3000 persons covering a wide range of body size, occupation, and mode of life.

Dr. Hutchinson claimed that he had shown that "vital capacity" increases in simple arithmetical progression with increasing height, and believed that he had disproved any relationship between "vital capacity" and body weight, trunk length, or circumference of the chest. The fact that his conclusions might be open to criticism, and that the fundamental principles underlying his investigation might yet have eluded his grasp, was present in his mind, and he concluded his treatise with the following remarkable sentences, which could well be taken as a model by any scientific worker:—

The matter of this communication is founded upon a vast number of facts—immutable truths which are infinitely beyond my comprehension. The deductions which I have ventured to draw therefrom I wish to advance with modesty, because time, with its mutations, may so unfold science as to crush these deductions and demonstrate them as unsound.

Nevertheless, the facts themselves can never alter nor deviate in their bearing upon respiration, one of the most important functions of the animal economy.

This prediction has, with the passage of time, been fulfilled.

Prof. G. Dreyer, of Oxford University, has made an extensive re-investigation of the whole subject, drawing upon Hutchinson's data as well as upon his own records. In a brilliant analysis

<sup>1</sup> The figures in brackets refer to the Bibliography at the end of the article.

<sup>2</sup> The term "vital capacity" is used to indicate the maximum amount of air the individual is able to expel from his lungs, by voluntary effort, after the deepest possible inspiration.

of this considerable body of observations, he has conclusively proved the existence of physiological laws which escaped the mind of the pioneer Hutchinson. On practically every point do these laws refute the conclusions reached by Hutchinson.

Prof. Dreyer (2) has shown that definite relationships do exist between "vital capacity" and body surface, body weight, trunk length, and the circumference of the chest, while no true relationship can be traced when "vital capacity" is regarded as a simple function of the standing height, as claimed by Hutchinson.

Hutchinson's misconception of the facts may be attributed in part to faulty mathematical analysis, in part to the fact that his observations were made upon subjects covering an insufficiently wide range of weight and size. It is obvious that physiological laws, if such exist, must be applicable over the entire period of growth of the individual, and must be inadequate if they can be established only over a limited range of variations of sex, age, stature, body weight, etc.

The scientific world is now familiar with the conception that certain physical, physiological, and anatomical attributes of the living organism are functions of the surface, and not of the volume, of that organism. Heat loss offers possibly the most familiar example, being relatively greater for the small body than for the large, by virtue of the relatively greater surface area presented by the small body for a given volume.

How can the surface of an animal be determined? It is simply necessary in this brief article to state that the surface can be determined indirectly from the body weight, of which it is a constant function. For justification of this procedure reference should be made to the original articles which describe the methods by which this relationship was determined (3 and 4).

Prof. Dreyer has in recent years shown that the blood volume (4), the cross-section of the aorta (5), and the cross-section of the trachea (6) are "surface functions" of the warm-blooded mammals, and not simply related to the body weight, as has often been maintained. It comes, therefore, as no surprise when he finds that "vital capacity" is also a "surface function," since this must represent, in one direction, the limit of the capacity possessed by the organism for oxygenating its blood and discharging the waste products of its metabolism, and consequently be a physiological expression of one most important aspect of respiration. It follows that this measurement gives us an index of the "vitality" of the organism, i.e. its ability to meet the various strains and stresses of its life.

If the "vital capacity" is a "surface function," there is the further difficulty to be faced: What

(Continued on p. 829.)



## Oceanography and the Sea-Fisheries.\*

By WILLIAM A. HERDMAN, C.B.E., D.Sc., Sc.D., LL.D., F.R.S.,

*Professor of Oceanography in the University of Liverpool, President.*

IT has been customary, when occasion required, for the president to offer a brief tribute to the memory of distinguished members of the Association lost to science during the preceding year. These, for the most part, have been men of advanced years and high reputation who had completed their life-work and served well in their day the Association and the sciences which it represents. Such are our late general treasurer, Prof. Perry, and our past-president, Sir Norman Lockyer, of whom the retiring president has just spoken. We have this year no other such losses to record; but it seems fitting on the present occasion to pause for a moment and devote a grateful thought to that glorious band of fine young men of high promise in science who, in the years since our Australian meeting in 1914, gave, it may be, in brief days and months of sacrifice, greater service to humanity and the advance of civilisation than would have been possible in years of normal time and work. A few names stand out already known and highly honoured—Moseley, Jenkinson, Geoffrey Smith, Keith Lucas, Gregory, and more recently Leonard Doncaster—all grievous losses; but there are also others, younger members of our Association, who had not yet had opportunity for showing accomplished work, but who equally gave up all for a great ideal. I prefer to offer a collective rather than an individual tribute. Other young men of science will arise and carry on their work, but the gap in our ranks remains. Let their successors remember that it serves as a reminder of a great example and of high endeavour worthy of our gratitude and of permanent record in the annals of science.

At the last Cardiff meeting of the British Association in 1891 you had as your president the eminent astronomer Sir William Huggins, who discoursed upon the then recent discoveries of the spectroscope in relation to the chemical nature, density, temperature, pressure, and even the motions of the stars. From the sky to the sea is a long drop, but the sciences of both have this in common: that they deal with fundamental principles and with vast numbers. More than three hundred years ago Spenser in the "Faerie Queene" compared "the seas abundant progeny" with "the starres on hy," and recent investigations show that a litre of sea-water may contain more than a hundred times as many living organisms as there are stars visible to the eye on a clear night.

During the past quarter of a century great advances have been made in the science of the sea, and the aspects and prospects of sea-fisheries research have undergone changes which encourage the hope that a combination of the work now carried on by hydrographers and biologists in most civilised countries on fundamental problems of the ocean may result in a more rational exploitation and administration of the fishing industries.

And yet even at your former Cardiff meeting thirty years ago there were at least three papers of oceanographic interest—one by Prof. Osborne Reynolds on the action of waves and currents, another by Dr. H. R. Mill on seasonal variation in the temperature of lochs and estuaries, and the third by our honorary local secretary for the present meeting, Dr. Evans Hoyle, on a deep-sea tow-net capable of being opened and closed under water by the electric current.

It was a notable meeting in several other respects,

\* Presidential address delivered at the Cardiff meeting of the British Association on August 24.

of which I shall merely mention two. In Section A Sir Oliver Lodge gave the historic address in which he expounded the urgent need, in the interests of both science and the industries, of a national institution for the promotion of physical research on a large scale. Lodge's pregnant idea put forward at this Cardiff meeting, supported and still further elaborated by Sir Douglas Galton as president of the Association at Ipswich, has since borne notable fruit in the establishment and rapid development of the National Physical Laboratory. The other outstanding event of that meeting is that you then appointed a committee of eminent geologists and naturalists to consider a project for boring through a coral reef, and that led during following years to the successive expeditions to the atoll of Funafuti, in the Central Pacific, the results of which, reported upon eventually by the Royal Society, were of great interest alike to geologists, biologists, and oceanographers.

Dr. Huggins, on taking the chair in 1891, remarked that it was more than thirty years since the Association had honoured astronomy in the selection of its president. It might be said that the case of oceanography is harder, as the Association has never had an oceanographer as president; and the Association might well reply, "Because until very recent years there has been no oceanographer to have." If astronomy is the oldest of the sciences, oceanography is probably the youngest. Depending as it does upon the methods and results of other sciences, it was not until our knowledge of physics, chemistry, and biology was relatively far advanced that it became possible to apply that knowledge to the investigation and explanation of the phenomena of the ocean. No one man has done more to apply such knowledge derived from various other subjects and to organise the results as a definite branch of science than the late Sir John Murray, who may therefore be regarded as the founder of modern oceanography.

It is to me a matter of regret that Sir John Murray was never president of the British Association. I am revealing no secret when I tell you that he might have been. On more than one occasion he was invited by the council to accept nomination, and he declined for reasons that were good and commanded our respect. He felt that the necessary duties of this post would interfere with what he regarded as his primary life-work—oceanographical explorations already planned, and the last of which he actually carried out in the North Atlantic in 1912, when above seventy years of age, in the Norwegian steamer *Michael Sars* along with his friend Dr. Johan Hjort.

Anyone considering the subject-matter of this new science must be struck by its wide range, overlapping as it does the borderlands of several other sciences and making use of their methods and facts in the solution of its problems. It is not only world-wide in its scope, but it also extends beyond our globe, and includes astronomical data in their relation to tidal and certain other oceanographical phenomena. No man in his work, or even thought, can attempt to cover the whole ground, although Sir John Murray, in his remarkably comprehensive "Summary" volumes of the *Challenger* Expedition and other writings, went far towards doing so. He, in his combination of physicist, chemist, geologist, and biologist, was the nearest approach we have had to an all-round oceanographer. The International Research Council probably acted wisely at the recent Brussels Confer-

ence in recommending the institution of two International Sections in our subject, one of physical and the other of biological oceanography, although the two overlap and are so interdependent that no investigator on one side can afford to neglect the other.<sup>1</sup>

On the present occasion I must restrict myself almost wholly to the latter division of the subject, and be content, after brief reference to the founders and pioneers of our science, to outline a few of those investigations and problems which have appeared to me to be of fundamental importance, of economic value, or of general interest.

Although the name "oceanography" was only given to this branch of science by Sir John Murray in 1880, and although, according to that veteran oceanographer Mr. J. Y. Buchanan, the last surviving member of the civilian staff of the *Challenger*, the science of oceanography was born at sea on February 15, 1873,<sup>2</sup> when at the first official dredging station of the expedition, to the westward of Tenerife, at 1525 fathoms, everything that came up in the dredge was new, and led to fundamental discoveries as to the deposits forming on the floor of the ocean, still it may be claimed that the foundations of the science were laid by various explorers of the ocean at much earlier dates. Aristotle, who took all knowledge for his province, was an early oceanographer on the shores of Asia Minor. When Pytheas passed between the Pillars of Hercules into the unknown Atlantic and penetrated to British seas in the fourth century B.C., and brought back reports of Ultima Thule and of a sea to the north thick and sluggish like a jellyfish, he may have been recording an early planktonic observation. But passing over all such and many other early records of phenomena of the sea, we come to surer ground in claiming as founders of oceanography Count Marsili, an early investigator of the Mediterranean, and that truly scientific navigator Capt. James Cook, who sailed to the South Pacific on a *Transit of Venus* expedition in 1769, with Sir Joseph Banks as naturalist, and by afterwards circumnavigating the South Sea about latitude 60° finally disproved the existence of a great southern continent; and Sir James Clark Ross, who, with Sir Joseph Hooker as naturalist, first dredged the Antarctic in 1840.

The use of the naturalist's dredge (introduced by O. F. Müller, the Dane, in 1799) for exploring the sea-bottom was brought into prominence almost simultaneously in several countries of North-West Europe—by Henri Milne-Edwards in France in 1830, by Michael Sars in Norway in 1835, and by our own Edward Forbes about 1832.

The last-mentioned genial and many-sided genius was a notable figure in several sections of the British Association from about 1836 onwards, and may fairly be claimed as a pioneer of oceanography. In 1839 he and his friend the anatomist, John Goodsir, were dredging in the Shetland seas, with results which Forbes made known to the meeting of the British Association at Birmingham that summer, with such

<sup>1</sup> The following classification of the primary divisions of the subject may possibly be found acceptable:—

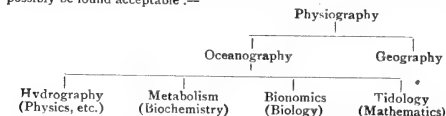

<sup>2</sup> Others might put the date later. Significant publications are Sir John Murray's Summary Volumes of the *Challenger* (1865), the inauguration of the Musée Océanographique at Monaco in 1910, the foundation of the Institut Océanographique at Paris in 1906 (see the Prince of Monaco's letter to the Minister of Public Instruction), and Sir John Murray's little book, "The Ocean" (1913), where the superiority of the term "oceanography" to "thalassography" (used by Alexander Agassiz) is discussed.

good effect that a "Dredging Committee"<sup>3</sup> of the Association was formed to continue the good work. Valuable reports on the discoveries of that committee appear in our volumes at intervals during the following twenty-five years.

It has happened over and over again in history that the British Association, by means of one of its research committees, has led the way in some important new research or development of science, and shown the Government or an industry what wants doing and how it can be done. We may fairly claim that the British Association has inspired and fostered that exploration of British seas which through marine biological investigations and deep-sea expeditions has led on to modern oceanography. Edward Forbes and the British Association Dredging Committee, Wyville Thomson, Carpenter, Gwyn Jeffreys, Norman, and other naturalists of the pre-*Challenger* days—all these men in the quarter-century from 1840 onwards worked under research committees of the British Association, bringing their results before successive meetings; and some of our older volumes enshrine classic reports on dredging by Forbes, McAndrew, Norman, Brady, Alder, and other notable naturalists of that day. These local researches paved the way for the *Challenger* and other national deep-sea expeditions. Here, as in other cases, it required private enterprise to precede and stimulate Government action.

It is probable that Forbes and his fellow-workers on this "Dredging Committee" in their marine explorations did not fully realise that they were opening up a most comprehensive and important department of knowledge. But it is also true that in all his expeditions—in the British seas from the Channel Islands to the Shetlands, in Norway, and in the Mediterranean as far as the Ægean Sea—his broad outlook on the problems of Nature was that of the modern oceanographer, and he was the spiritual ancestor of men like Sir Wyville Thomson, of the *Challenger* Expedition, and Sir John Murray, whose accidental death a few years ago, whilst still in the midst of active work, was a grievous loss to this new and rapidly advancing science of the sea.

Forbes in these marine investigations worked at border-line problems, dealing, for example, with the relations of geology to zoology and the effect of the past history of the land and sea upon the distribution of plants and animals at the present day, and in these respects he was an early oceanographer. For the essence of that new subject is that it also investigates border-line problems, and is based upon and makes use of all the older fundamental sciences—physics, chemistry, and biology—and shows, for example, how variations in the great ocean-currents may account for the movements and abundance of the migratory fishes, and how periodic changes in the physico-chemical characters of the sea, such as variations in the hydrogen-ion and hydroxyl-ion concentration, are correlated with the distribution at the different seasons of the all-important microscopic organisms that render our oceanic waters as prolific a source of food as the pastures of the land.

Another pioneer of the nineteenth century who, I sometimes think, has not yet received sufficient credit for his foresight and initiative is Sir Wyville Thomson, whose name ought to go down through the ages as the leader of the scientific staff on the famous *Challenger* Deep-Sea Exploring Expedition. It is due chiefly to him and to his friend, Dr. W. B.

<sup>3</sup> "For researches with the dredge, with a view to the investigation of the marine zoology of Great Britain, the illustration of the geographical distribution of marine animals, and the more accurate determination of the fossils of the Pleistocene period: under the superintendence of Mr. Gray, Mr. Forbes, Mr. Goodsir, Mr. Patterson, Mr. Thompson of Belfast, Mr. Ball of Dublin, Dr. George Johnston, Mr. Smith of Jordan Hill, and Mr. A. Strickland, 607." Report for 1839, p. xxvi.

Carpenter, that the British Government, through the influence of the Royal Society, was induced to place at the disposal of a committee of scientific experts, first the small surveying steamer *Lightning* in 1868, and then the more efficient steamer *Porcupine* in the two succeeding years, for the purpose of exploring the deep water of the Atlantic from the Faroes in the north to Gibraltar and beyond in the south, in the course of which expeditions they got successful hauls from the then unprecedented depth of 2435 fathoms, nearly three statute miles.

It will be remembered that Edward Forbes, from his observations in the Mediterranean (an abnormal sea in some respects), regarded depths of more than 300 fathoms as an azoic zone. It was the work of Wyville Thomson and his colleagues, Carpenter and Gwyn Jeffreys, on these successive dredging expeditions to prove conclusively what was beginning to be suspected by naturalists, that there is no azoic zone in the sea, but that abundant life belonging to many groups of animals extends down to the greatest depths of from four to five thousand fathoms—nearly six statute miles from the surface.

These pioneering expeditions in the *Lightning* and *Porcupine*—the results of which are not even yet fully made known to science—were epoch-making, inasmuch as they not only opened up this new region to the systematic marine biologist, but also gave glimpses of world-wide problems in connection with the physics, the chemistry, and the biology of the sea which are only now being adequately investigated by the modern oceanographer. These results, which aroused intense interest amongst the leading scientific men of the time, were so rapidly surpassed and overshadowed by the still greater achievements of the *Challenger* and other national exploring expeditions that followed in the seventies and eighties of last century, that there is some danger of their real importance being lost sight of; but it ought never to be forgotten that they first demonstrated the abundance of life of a varied nature in depths formerly supposed to be azoic, and, moreover, that some of the new deep-sea animals obtained were related to extinct forms belonging to the Jurassic, Cretaceous, and Tertiary periods.

It is interesting to recall that our Association played its part in promoting the movement that led to the *Challenger* Expedition. Our general committee at the Edinburgh meeting of 1871 recommended that the president and council be authorised to co-operate with the Royal Society in promoting "a circumnavigation expedition, specially fitted out to carry the physical and biological exploration of the deep sea into all the great oceanic areas"; and our council later appointed a committee consisting of Dr. Carpenter, Prof. Huxley, and others to co-operate with the Royal Society in carrying out these objects.

It has been said that the *Challenger* Expedition will rank in history with the voyages of Vasco da Gama, Columbus, Magellan, and Cook. Like these, it added new regions of the globe to our knowledge, and the wide expanses thus opened up for the first time, the floors of the oceans, though less accessible, are vaster than the discoveries of any previous exploration. Has not the time come for a new *Challenger* expedition?

Sir Wyville Thomson, although leader of the expedition, did not live to see the completed results, and Sir John Murray will be remembered in the history of science as the *Challenger* naturalist who brought to a successful issue the investigation of the enormous collections and the publication of the scientific results of that memorable voyage; these two Scots share the honour of having guided the destinies of what is still the greatest oceanographic exploration of all time.

In addition to taking his part in the general work of the expedition, Murray devoted special attention to three subjects of primary importance in the science of the sea, viz.: (1) The plankton or floating life of the oceans, (2) the deposits forming on the sea-bottoms, and (3) the origin and mode of formation of coral-reefs and islands. It was characteristic of his broad and synthetic outlook on Nature that, in place of working at the speiography and anatomy of some group of organisms, however novel, interesting, and attractive to the naturalist the deep-sea organisms might seem to be, he took up wide-reaching general problems with economic and geological as well as biological applications.

Each of the three main lines of investigation—deposits, plankton, and coral-reefs—which Murray undertook on board the *Challenger* has been most fruitful of results both in his own hands and in those of others. His plankton work has led on to those modern planktonic researches which are closely bound up with the scientific investigation of our sea-fisheries.

His work on the deposits accumulating on the floor of the ocean resulted, after years of study in the laboratory as well as in the field, in collaboration with the Abbé Renard, of the Brussels Museum, afterwards professor at Ghent, in the production of the monumental "Deep-Sea Deposits" volume, one of the *Challenger* reports, which first revealed to the scientific world the detailed nature and distribution of the varied submarine deposits of the globe and their relation to the rocks forming the crust of the earth.

These studies led, moreover, to one of the romances of science which deeply influenced Murray's future life and work. In accumulating material from all parts of the world and all deep-sea exploring expeditions for comparison with the *Challenger* series, some ten years later, Murray found that a sample of rock from Christmas Island, in the Indian Ocean, which had been sent to him by Comdr. (now Admiral) Aldrich, of H.M.S. *Egeria*, was composed of a valuable phosphatic material. This discovery in Murray's hands gave rise to a profitable commercial undertaking, and he was able to show that some years ago the British Treasury had already received in royalties and taxes from the island considerably more than the total cost of the *Challenger* Expedition.

That first British circumnavigating expedition on the *Challenger* was followed by other national expeditions (the American *Tuscarora* and *Albatross*, the French *Travailleur*, the German *Gauss*, *National*, and *Valdivia*, the Italian *Vettor Pisani*, the Dutch *Siboga*, the Danish *Thor*, and others) and by almost equally celebrated and important work by unofficial oceanographers such as Alexander Agassiz, Sir John Murray with Dr. Hjort in the *Michael Sars*, and the Prince of Monaco in his magnificent ocean-going yacht, and by such other good work by many investigators in smaller and humbler vessels. One of these supplementary expeditions I must refer to briefly because of its connection with sea-fisheries. The *Triton*, under Tizard and Murray in 1882, while exploring the cold and warm areas of the Faroe Channel separated by the Wyville Thomson ridge, incidentally discovered the famous Dubh-Artach fishing-grounds, which have been worked by British trawlers ever since.

Notwithstanding all this activity during the last forty years since oceanography became a science, much has still to be investigated in all seas in all branches of the subject. On pursuing any line of investigation one very soon comes up against a wall of the unknown or a maze of controversy. Peculiar difficulties surround the subject. The matters investigated are often remote and almost inaccessible. Un-

known factors may enter into every problem. The samples required may be at the other end of a rope or a wire eight to ten miles long, and the oceanographer may have to grope for them literally in the dark and under other difficult conditions which make it uncertain whether his samples when obtained are adequate and representative, and whether they have undergone any change since leaving their natural environment. It is not surprising, then, that in the progress of knowledge mistakes have been made and corrected, and that views have been held on what seemed good scientific grounds which later on were proved to be erroneous. For example, Edward Forbes, in his division of life in the sea into zones, on what then seemed to be sufficiently good observations in the Ægean, but which we now know to be exceptional, placed the limit of life at 300 fathoms, while Wyville Thomson and his fellow-workers on the *Porcupine* and the *Challenger* showed that there is no azoic zone even in the great abysses.

Or, again, take the celebrated myth of Bathybius. In the sixties of last century samples of Atlantic mud, taken when surveying the bottom for the first telegraph cables and preserved in alcohol, were found when examined by Huxley, Hæckel, and others to contain what seemed to be an exceedingly primitive protoplasmic organism, which was supposed on good evidence to be extended widely over the floor of the ocean. The discovery of this Bathybius was said to solve the problem of how the deep-sea animals were nourished in the absence of seaweeds. Here was a widespread protoplasmic meadow upon which other organisms could graze. Belief in Bathybius seemed to be confirmed and established by Wyville Thomson's results in the *Porcupine* Expedition of 1869, but was exploded by the naturalists on the *Challenger* some five years later. Buchanan in his recently published "Accounts Rendered" tells us how he and his colleague Murray were keenly on the lookout for hours at a time on all possible occasions for traces of this organism, and how they finally proved, in the spring of 1875 on the voyage between Hong-Kong and Yokohama, that the all-pervading substance like coagulated mucus was an amorphous precipitate of sulphate of lime thrown down from the sea-water in the mud on the addition of a certain proportion of alcohol. He wrote to this effect from Japan to Prof. Crum Brown, and it is in evidence that after receiving this letter Crum Brown interested his friends in Edinburgh by showing them how to make Bathybius in the chemical laboratory. Huxley at the Sheffield meeting of the British Association in 1879 handsomely admitted that he had been mistaken, and it is said that he characterised Bathybius as "not having fulfilled the promise of its youth." Will any of our present oceanographic beliefs share the fate of Bathybius in the future? Some may, but even if they do they may well have been useful steps in the progress of science. Although, like Bathybius, they may not have fulfilled the promise of their youth, yet we may add they will not have lived in the minds of man in vain.

Many of the phenomena we encounter in oceanographic investigations are so complex, are or may be affected by so many diverse factors, that it is difficult, if indeed possible, to be sure that we are unravelling them aright and see the real causes of what we observe.

Some few things we know approximately, nothing completely. We know that the greatest depths of the ocean, about six miles, are a little greater than the highest mountains on land, and Sir John Murray has calculated that if all the land were washed down into the sea the whole globe would be covered by an ocean

averaging about two miles in depth.<sup>4</sup> We know the distribution of temperatures and salinities over a great part of the surface and a good deal of the bottom of the oceans, and some of the more important oceanic currents have been charted and their periodic variations, such as those of the Gulf Stream, are being studied. We know a good deal about the organisms floating or swimming in the surface waters (the epiplankton), and also those brought up by our dredges and trawls from the bottom in many parts of the world, although every expedition still makes large additions to knowledge. The region that is least known to us, both in its physical conditions and in its inhabitants, is the vast zone of intermediate waters lying between the upper few hundred fathoms and the bottom. That is the region that Alexander Agassiz, from his observations with closing tow-nets on the *Blake* Expedition, supposed to be destitute of life, or at least, as modified by his later observations on the *Albatross*, to be relatively destitute compared with the surface and the bottom, in opposition to the contention of Murray and other oceanographers that an abundant meso-plankton was present, and that certain groups of animals, such as the Challengerida and some kinds of Medusæ, were characteristic of these deeper zones. I believe that, as sometimes happens in scientific controversies, both sides were right up to a point, and both could support their views upon observations from particular regions of the ocean in certain circumstances.

But much still remains unknown or only imperfectly known even in matters that have long been studied and where practical applications of great value are obtained—such as the investigation and prediction of tidal phenomena. We are now told that theories require reinvestigation, and that published tables are not sufficiently accurate. To take another practical application of oceanographic work, the ultimate causes of variations in the abundance, in the sizes, in the movements, and in the qualities of the fishes of our coastal industries are still to seek, and, notwithstanding volumes of investigation and a still greater volume of discussion, no man who knows anything of the matter is satisfied with our present knowledge of even the best-known and economically most important of our fishes such as the herring, the cod, the plaice, and the salmon.

Take the case of our common fresh-water eel as an example of how little we know and at the same time of how much has been discovered. All the eels of our streams and lakes of North-West Europe live and feed and grow under our eyes without reproducing their kind; no spawning eel has ever been seen. After living for years in immaturity, at last near the end of their lives the large male and female yellow eels undergo a change in appearance and in nature. They acquire a silvery colour and their eyes enlarge, and in this bridal attire they commence the long journey which ends in maturity, reproduction, and death. From all the fresh waters they migrate in the autumn to the coast, from the inshore seas to the open ocean and still westward and south to the mid-Atlantic, and we know not how much further, for the exact locality and manner of spawning have still to be discovered. The youngest known stages of the *Leptocephalus*, the larval stage of eels, have been found by the Dane, Dr. Johannes Schmidt, to the west of the Azores, where the water is more than 2000 fathoms in depth. These were about one-third of an inch in length, and were probably not long hatched. I cannot now refer to all the able invest-

<sup>4</sup> It was possibly in such a former world-wide ocean of fresh water that, according to the recent speculations of A. H. Church ("Thalassiophyta," 1919), the first living organisms were evolved, to become later the floating unicellular plants of the primitive plankton.

tigators—Grassi, Hjort, and others—who have discovered and traced the stages of growth of the Leptocephalus and its metamorphosis into the "elvers" or young eels which are carried by the North Atlantic drift back to the coasts of Europe and ascend our rivers in spring in countless myriads; but no man has been more indefatigable and successful in the quest than Dr. Schmidt, who in the various expeditions of the Danish investigation steamer *Thor* from 1904 onwards found successively younger and younger stages, and is during the present summer engaged in a traverse of the Atlantic to the West Indies in the hope of finding the missing link in the chain, the actual spawning fresh-water eel in the intermediate waters somewhere above the abysses of the open ocean.<sup>4</sup>

Again, take the case of an interesting oceanographic observation which, if established, may be found to explain the variations in time and amount of important fisheries. Otto Pettersson in 1910 discovered by his observations in the Gullmar Fjord the presence of periodic submarine waves of deeper saltier water in the Kattegat and the fjords of the west coast of Sweden, which draw in with them from the Jutland banks vast shoals of the herrings which congregate there in autumn. The deeper layer consists of "bank-water" of salinity 32 to 34 per thousand, and as this rolls in along the bottom as a series of huge undulations it forces out the overlying fresher water, and so the herrings living in the "bankwater" outside are sucked into the Kattegat and neighbouring fjords and give rise to important local fisheries. Pettersson connects the crests of the submarine waves with the phases of the moon. Two great waves of saltier water which reached up to the surface took place in November, 1910, one near the time of full moon and the other about new moon, and the latter was at the time when the shoals of herring appeared inshore and provided a profitable fishery. The coincidence of the oceanic phenomena with the lunar phases is not, however, very exact, and doubts have been expressed as to the connection; yet, if established, and even if found to be due, not to the moon, but to prevalent winds or the influence of ocean currents, this would be a case of the migration of fishes depending upon mechanical causes, while in other cases it is known that migrations are due to spawning needs or for the purpose of feeding, as in the case of the cod and the herring in the west and north of Norway and in the Barents Sea.

Then, turning to a very fundamental matter of purely scientific investigation, we do not know with any certainty what causes the great and all-important seasonal variations in the plankton (or floating minute life of the sea) as seen, for example, in our own home seas, where there is a sudden awakening of microscopic plant-life, the Diatoms, in early spring when the water is at its coldest. In the course of a few days the upper layers of the sea may become so filled with organisms that a small silk net towed for a few minutes may capture hundreds of millions of individuals. And these myriads of microscopic forms, after persisting for a few weeks, may disappear as suddenly as they came, to be followed by swarms of Copepoda and many other kinds of minute animals, and these again may give place in the autumn to a second maximum of Diatoms or of the closely related Peridinales. Of course, there are theories as to all these more or less periodic changes in the plankton, such as Liebig's "law of the minimum," which limits the production of an organism by the amount of

<sup>4</sup> According to Schmidt's results, the European fresh-water eel, in order to be able to propagate, requires a depth of at least 500 fathoms, a salinity of more than 35‰ per mille, and a temperature of more than 7° C. in the required depth.

that necessity of existence which is present in least quantity, it may be nitrogen or silicon or phosphorus. According to Raben, it is the accumulation of silicic acid in the sea-water that determines the great increase of Diatoms in spring and again in autumn. Some writers have considered these variations in the plankton to be caused largely by changes in temperature supplemented, according to Ostwald, by the resulting changes in the viscosity of the water; but Murray and others are more probably correct in attributing the spring development of phyto-plankton to the increasing power of the sunlight and its value in photosynthesis.

Let us take next the fact—if it be a fact—that the genial, warm waters of the tropics support a less abundant plankton than the cold polar seas. The statement has been made and supported by some investigators and disputed by others, both on a certain amount of evidence. This is possibly a case like some other scientific controversies where both sides are partly in the right or right under certain conditions. At any rate, there are marked exceptions to the generalisation. The German Plankton Expedition in 1889 showed in its results that much larger hauls of plankton per unit-volume of water were obtained in the temperate North and South Atlantic than in the tropics between, and that the warm Sargasso Sea had a remarkably scanty microflora. Other investigators have since reported more or less similar results. Lohmann found the Mediterranean plankton to be less abundant than that of the Baltic; gatherings brought back from tropical seas are frequently very scanty, and enormous hauls, on the other hand, have been recorded from Arctic and Antarctic seas. There is no doubt about the large gatherings obtained in northern waters. I have myself in a few minutes' haul of a small horizontal net in the north of Norway collected a mass of the large Copepod, *Calanus finmarchicus*, sufficient to be cooked and eaten like potted shrimps by half a dozen of the yacht's company, and I have obtained similar large hauls in the cold Labrador current near Newfoundland. On the other hand, Kofoid and Alexander Agassiz have recorded large hauls of plankton in the Humboldt current off the west coast of America, and during the *Challenger* Expedition some of the largest quantities of plankton were found in the equatorial Pacific. Moreover, it is common knowledge that on occasions vast swarms of some planktonic organism may be seen in tropical waters. The yellow alga, *Trichodesmium*, which is said to have given its name to the Red Sea, and has been familiarly known as "sea-sawdust" since the days of Cook's first voyage,<sup>5</sup> may cover the entire surface over considerable areas of the Indian and South Atlantic Oceans; and some pelagic animals, such as Salpae, Medusae, and Ctenophores, are also commonly present in abundance in the tropics. Then, again, American biologists' have pointed out that the warm waters of the West Indies and Florida may be noted for the richness of their floating life for periods of years, while at other times the pelagic organisms become rare and the region is almost a desert sea.

It is probable, on the whole, that the distribution and variations of oceanic currents have more than latitude or temperature alone to do with any observed scantiness of tropical plankton. These mighty rivers of the ocean in places teem with animal- and plant-life, and may sweep abundance of food from one region to another in the open sea.

But even if it be a fact that there is this alleged deficiency in tropical plankton, there is by no means

<sup>5</sup> See "Journal" of Sir Joseph Banks. This and other swarms were also noticed by Darwin during the voyage of the *Beagle*.

<sup>7</sup> A. Agassiz, A. G. Mayer, and H. B. Bigelow.

agreement as to the cause thereof. Brandt first attributed the poverty of the plankton in the tropics to the destruction of nitrates in the sea as a result of the greater intensity of the metabolism of denitrifying bacteria in the warmer water; and various writers since then have more or less agreed that the presence of these denitrifying bacteria, by keeping down to a minimum the nitrogen concentration in tropical waters, may account for the relative scarcity of the phyto-plankton, and, consequently, of the zoo-plankton, that has been observed. But Gran, Nathansohn, Murray, Hjort, and others have shown that such bacteria are rare or absent in the open sea, that their action must be negligible, and that Brandt's hypothesis is untenable. It seems clear, moreover, that the plankton does not vary directly with the temperature of the water. Furthermore, Nathansohn has shown the influence of the vertical circulation in the water upon the nourishment of the phyto-plankton—by rising currents bringing up necessary nutrient materials, and especially carbon dioxide, from the bottom layers; and also possibly by conveying the products of the drainage of tropical lands to more polar seas so as to maintain the more abundant life in the colder water.

Pütter's view is that the increased metabolism in the warmer water causes all the available food materials to be used up rapidly, and so puts a check to the reproduction of the plankton.

According to van't Hoff's law in chemistry, the rate at which a reaction takes place is increased by raising the temperature, and this probably holds good for all biochemical phenomena, and therefore for the metabolism of animals and plants in the sea. This has been verified experimentally in some cases by J. Loeb. The contrast between the plankton of Arctic and Antarctic zones, consisting of large numbers of small crustaceans belonging to comparatively few species, and that of tropical waters, containing a great many more species generally of smaller size and fewer in number of individuals, is to be accounted for, according to Sir John Murray and others, by the rate of metabolism in the organisms. The assemblages captured in cold polar waters are of different ages and stages, young and adults of several generations occurring together in profusion,<sup>8</sup> and it is supposed that the adults "may be ten, twenty, or more years of age." At the low temperature the action of putrefactive bacteria and of enzymes is very slow or in abeyance, and the vital actions of the Crustacea take place more slowly and the individual lives are longer. On the other hand, in the warmer waters of the tropics the action of the bacteria is more rapid, metabolism in general is more active, and the various stages in the life-history are passed through more rapidly, so that the smaller organisms of equatorial seas probably live only for days or weeks in place of years.

This explanation may account also for the much greater quantity of living organisms which has been found so often on the sea-floor in polar waters. It is a curious fact that the development of the polar marine animals is, in general, "direct" without larval pelagic stages, the result being that the young settle down on the floor of the ocean in the neighbourhood of the parent forms, so that there come to be enormous congregations of the same kind of animal within a limited area, and the dredge will in a particular haul come up filled with hundreds, it may be, of an Echinoderm, a Sponge, a Crustacean, a Brachiopod, or an Ascidian; whereas in warmer seas a young pass through a pelagic stage and so become

<sup>8</sup> Whether, however, the low temperature may not also retard reproduction is worthy of consideration.

more widely distributed over the floor of the ocean. The *Challenger* Expedition found in the Antarctic certain Echinoderms, for example, which had young in various stages of development attached to some part of the body of the parents, whereas in temperate or tropical regions the same class of animals set free their eggs and the development proceeds in the open water quite independently of, and it may be far distant from, the parent.

Another characteristic result of the difference in temperature is that the secretion of carbonate of lime in the form of shells and skeletons proceeds more rapidly in warm than in cold water. The massive shells of molluscs, the vast deposits of carbonate of lime formed by corals and by calcareous seaweeds, are characteristic of the tropics; whereas in polar seas, while the animals may be large, they are for the most part soft-bodied and destitute of calcareous secretions. The calcareous pelagic Foraminifera are characteristic of tropical and sub-tropical plankton, and few, if any, are found in polar waters. Globigerina ooze, a calcareous deposit, is abundant in equatorial seas, while in the Antarctic the characteristic deposit is siliceous Diatomaceous ooze.

The part played by bacteria in the metabolism of the sea is very important and probably of wide-reaching effect, but we still know very little about it. A most promising young Cambridge biologist, the late Mr. G. Harold Drew, now unfortunately lost to science, had already done notable work at Jamaica and at Tortugas, Florida, on the effects produced by a bacillus which is found in the surface waters of these shallow tropical seas and in the mud at the bottom; and which denitrifies nitrates and nitrites, giving off free nitrogen. He found that this *Bacillus calcis* also caused the precipitation of soluble calcium salts in the form of calcium carbonate ("drewite") on a large scale in the warm shallow waters. Drew's observations tend to show that the great calcareous deposits of Florida and the Bahamas previously known as "coral muds" are not, as was supposed by Murray and others, derived from broken-up corals, shells, nullipores, etc., but are minute particles of carbonate of lime which have been precipitated by the action of these bacteria.<sup>9</sup>

The bearing of these observations upon the formation of oolitic limestones and the fine-grained unfossiliferous Lower Palaeozoic limestones of New York State, recently studied in this connection by R. M. Field,<sup>10</sup> must be of peculiar interest to geologists, and forms a notable instance of the attendant character of oceanography, bringing the metabolism of living organisms in the modern sea into relation with palaeozoic rocks.

The work of marine biologists on the plankton has been in the main *qualitative*, the identification of species, the observation of structure, and the tracing of life-histories. The oceanographer adds to that the *quantitative* aspect when he attempts to estimate numbers and masses per unit-volume of water or of area. Let me lay before you a few thoughts in regard to some such attempts, mainly for the purpose of showing the difficulties of the investigation. Modern quantitative methods owe their origin to the ingenious and laborious work of Victor Hensen, followed by Brandt, Apstein, Lohmann, and others of the Kiel school of quantitative planktologists. We may take their well-known estimations of fish-eggs in the North Sea as an example of the method.

The floating eggs and embryos of our more important food-fishes may occur in quantities in the plankton during certain months in spring, and Hensen and

<sup>9</sup> Journ. Mar. Biol. Assoc., October, 1911.

<sup>10</sup> Carnegie Institution of Washington, "Year Book for 1919," p. 297.

Apstein have made some notable calculations based on the occurrence of these in certain hauls taken at intervals across the North Sea, which led them to the conclusion that, taking six of our most abundant fish, such as the cod and some of the flat-fish, the eggs present were probably produced by about 1,200,000,000 spawners, enabling them to calculate that the total fish population of the North Sea (of these six species) at that time (the spring of 1895) amounted to about 70,000,000,000. Further calculations led them to the result that the fishermen's catch of these fishes amounted to about one-quarter of the total population. Now all this is not only of scientific interest, but also of great practical importance if we could be sure that the samples upon which the calculations are based were adequate and representative, but it will be noted that these samples represent only 1 square metre in 3,465,968,354. Hensen's statement, repeated in various works in slightly differing words, is to the effect that, using a net of which the constants are known hauled vertically through a column of water from a certain depth to the surface, he can calculate the volume of water filtered by the net and so estimate the quantity of plankton under each square metre of the surface; and his whole results depend upon the assumption, which he considers justified, that the plankton is evenly distributed over large areas of water which are under similar conditions. In these calculations in regard to the fish-eggs he takes the whole of the North Sea as being an area under similar conditions, but we have known since the days of P. T. Cleve and from the observations of Hensen's own colleagues that this is not the case, and they have published chart-diagrams showing that at least three different kinds of water under different conditions are found in the North Sea, and that at least five different planktonic areas may be encountered in making a traverse from Germany to the British Isles. If the argument be used that wherever the plankton is found to vary there the conditions cannot be uniform, then few areas of the ocean of any considerable size remain as cases suitable for population-computation from random samples. It may be doubted whether even the Sargasso Sea, which is an area of more than usually uniform character, has a sufficiently evenly distributed plankton to be treated by Hensen's method of estimation of the population.

In the German Plankton Expedition of 1889 Schütt reports that in the Sargasso Sea, with its relatively high temperature, the twenty-four catches obtained were uniformly small in quantity. His analysis of the volumes of these catches shows that the average was 3.33 c.c., but the individual catches ranged from 1.5 c.c. to 6.5 c.c., and the divergence from the average may be as great as +3.2 c.c.; and, after deducting 20 per cent. of the divergence as due to errors of the experiment, Schütt estimates the mean variation of the plankton at about 16 per cent. above or below. This does not seem to me to indicate the uniformity that might be expected in this "halistic" area occupying the centre of the North Atlantic Gulf Stream circulation. Hensen also made almost simultaneous hauls with the same net in quick succession to test the amount of variation, and found that the average error was about 13 per cent.

As so much depends in all work at sea upon the weather, the conditions under which the ship is working, and the care taken in the experiment, with the view of getting further evidence under known conditions I carried out similar experiments at Port Erin on four occasions during last April and on a further occasion a month later, choosing favourable weather and conditions of tide and wind so as

to be able to maintain an approximate position. On each of four days in April the Nansen net, with No. 20 silk, was hauled six times from the same depth (on two occasions 8 fathoms and on two occasions 20 fathoms), the hauls being taken in rapid succession and the catches emptied from the net into bottles of 5 per cent. formaline, in which they remained until examined microscopically.

The results were of interest, for although they showed considerable uniformity in the amount of the catch—for example, six successive hauls from 8 fathoms being all of them 0.2 c.c., and four out of five from 20 fathoms being 0.6 c.c.—the volume was made up rather differently in the successive hauls. The same organisms occur for the most part in each haul, and the chief groups of organisms are present in much the same proportion. For example, in a series where the Copepoda average about 100, the Dinoflagellates average about 300 and the Diatoms about 8000, but the percentage deviation of individual hauls from the average may be as much as *plus* or *minus* 50. The numbers for each organism (about 40) in each of the twenty-six hauls have been worked out, and the details will be published elsewhere, but the conclusion I come to is that if on each occasion one haul only in place of six had been taken, and if one had used that haul to estimate the abundance of any one organism in that sea-area, one might have been about 50 per cent. wrong in either direction.

Successive improvements and additions to Hensen's methods in collecting plankton have been made by Lohmann, Apstein, Gran, and others, such as pumping up water of different layers through a hose-pipe and filtering it through felt, filter-paper, and other materials which retain much of the micro-plankton that escapes through the meshes of the finest silk. Use has even been made of the extraordinarily minute and beautifully regular natural filter spun by the pelagic animal, *Appendicularia*, for the capture of its own food. This grid-like trap, when dissected out and examined under the microscope, reveals a surprising assemblage of the smallest protozoa and protophyta, less than 30 micro-millimetres in diameter, which would all pass easily through the meshes of our finest silk nets.

The latest refinement in capturing the minutest-known organisms of the plankton (excepting the bacteria) is a culture method devised by Dr. E. J. Allen, director of the Plymouth Laboratory.<sup>11</sup> By diluting half a cubic centimetre of the sea-water with a considerable amount (1500 c.c.) of sterilised water treated with a nutrient solution, and distributing that over a large number (70) of small flasks in which after an interval of some days the number of different kinds of organisms which had developed in each flask was counted, he calculates that the sea contains 464,000 of such organisms per litre; and he gives reasons why his cultivations must be regarded as minimum results, and states that the total per litre may well be something like a million. Thus every new method devised seems to multiply many times the probable total population of the sea. As further results of the quantitative method, it may be recorded that Brandt found about 200 Diatoms per drop of water in Kiel Bay, and Hensen estimated that there are several hundred millions of Diatoms under each square metre of the North Sea or the Baltic. It has been calculated that there is approximately one Copepod in each cubic inch of Baltic water, that the annual consumption of these Copepoda by herring is about a thousand billion, and that in the sixteen square miles of a certain Baltic fishery there is Copepod food for more than 530,000,000 herring of an average weight of 60 grams.

<sup>11</sup> Journ. Mar. Biol. Assoc., vol. xii, p. 1, July, 1919.

There are many other problems of the plankton in addition to quantitative estimates—probably some that we have not yet recognised—and various interesting conclusions may be drawn from recent planktonic observations. Here is a case of the introduction and rapid spread of a form new to British seas.

*Biddulphia sinensis* is an exotic Diatom which, according to Ostenfeld, made its appearance at the mouth of the Elbe in 1903, and spread during successive years in several directions. It appeared suddenly in our plankton gatherings at Port Erin in November, 1909, and has been present in abundance each year since. Ostenfeld in 1908, when tracing its spread in the North Sea, found that the migration to the north along the coast of Denmark to Norway corresponded with the rate of flow of the Jutland current to the Skager Ræk, viz. about 17 cm. per second—a case of plankton distribution throwing light on hydrography—and he predicted that it would soon be found in the English Channel. Dr. Marie Lebour, who recently examined the store of plankton gatherings at the Plymouth Laboratory, finds that, as a matter of fact, this form did appear in abundance in the collections of October, 1909, within a month of the time when, according to our records, it reached Port Erin. Whether or not this is an Indo-Pacific species brought accidentally by a ship from the Far East, or whether it is possibly a new mutation which appeared suddenly in our seas, there is no doubt that it was not present in our Irish Sea plankton gatherings previous to 1909, but has been abundant since that year, and has completely adopted the habits of its English relations, appearing with *B. mobiliensis* in late autumn, persisting during the winter, reaching a maximum in spring, and dying out before summer.

The Nauplius and Cypris stages of *Balanus* in the plankton form an interesting study. The adult barnacles are present in enormous abundance on the rocks round the coast, and they reproduce in winter at the beginning of the year. The newly emitted young are sometimes so abundant as to make the water in the shore-pools and in the sea close to the shore appear muddy. The Nauplii first appeared at Port Erin in 1907 in the bay gatherings on February 22 (in 1908 on February 13), and increased with ups and downs to their maximum on April 15, and then decreased until their disappearance on April 26. None were taken at any other time of the year. The Cypris stage follows on after the Nauplius. It was first taken in the bay on April 6, rose to its maximum on the same day with the Nauplii, and was last caught on May 24. Throughout the Cypris curve keeps below that of the Nauplius, the maxima being 1740 and 10,500 respectively. Probably the difference between the two curves represents the death-rate of *Balanus* during the Nauplius stage. That conclusion I think we are justified in drawing, but I would not venture to use the result of any haul, or the average of a number of hauls, to multiply by the number of square yards in a zone round our coast in order to obtain an estimate of the number of young barnacles or of the old barnacles that produced them; the irregularities are too great.

To my mind it seems clear that there must be three factors making for irregularity in the distribution of a plankton organism:

(1) The sequence of stages in its life-history, such as the Nauplius and Cypris stages of *Balanus*.

(2) The results of interaction with other organisms, as when a swarm of *Calanus* is pursued and devoured by a shoal of herring.

(3) Abnormalities in time or abundance due to the physical environment, as in favourable or unfavourable seasons.

And these factors must be at work in the open ocean as well as in coastal waters.

In many oceanographical inquiries there is a double object. There is the scientific interest and there is the practical utility—the interest, for example, of tracing a particular swarm of a Copepod like *Calanus*, and of making out why it is where it is at a particular time, tracing it back to its place of origin, finding that it has come with a particular body of water, and perhaps that it is feeding upon a particular assemblage of Diatoms; and endeavouring to give a scientific explanation of every stage in its progress. Then there is the utility—the demonstration that the migration of the *Calanus* has determined the presence of a shoal of herring or mackerel that are feeding upon it, and so have been brought within the range of the fisherman and have constituted a commercial fishery.

We have evidence that pelagic fish which congregate in shoals, such as herring and mackerel, feed upon the Crustacea of the plankton, and especially upon Copepoda. A few years ago when the summer herring fishery off the south end of the Isle of Man was unusually near the land, the fishermen found large red patches in the sea where the fish were specially abundant. Some of the red stuff brought ashore by the men was examined at the Port Erin Laboratory, and found to be swarms of the Copepod, *Temora longicornis*; and the stomachs of the herring caught at the same time were engorged with the same organism. It is not possible to doubt that during these weeks of the herring fishery in the Irish Sea the fish were feeding mainly upon this species of Copepod. Some ten years ago Dr. E. J. Allen and Mr. G. E. Bullen published<sup>12</sup> some interesting work from the Plymouth Marine Laboratory demonstrating the connection between mackerel and Copepoda and sunshine in the English Channel; and Farran<sup>13</sup> states that in the spring fishery on the West of Ireland the food of the mackerel is mainly composed of *Calanus*.

Then again, at the height of the summer mackerel fishery in the Hebrides in 1913, we found<sup>14</sup> the fish feeding upon the large Copepod, *Calanus finmarchicus*, which was caught in the tow-net at the rate of about 6000 in a five minutes' haul, and 6000 was also the average number found in the stomachs of the fish caught at the same time.

These were cases where the fish were feeding upon the organism that was present in swarms—a monotonous plankton—but in other cases the fish are clearly selective in their diet. If the sardine of the French coast can pick out from the micro-plankton the minute Peridiniales in preference to the equally minute Diatoms which are present in the sea at the same time, there seems no reason why the herring and the mackerel should not be able to select particular species of Copepoda or other large organisms from the macro-plankton, and we have evidence that they do. Nearly thirty years ago the late Mr. Isaac Thompson, a constant supporter of the Zoological Section of this Association and one of the honorary local secretaries for the last Liverpool meeting, showed me in 1893 that young plaice at Port Erin were selecting one particular Copepod, a species of *Jonesiella*, out of many others caught in our tow-nets at the time. H. Blegvad<sup>15</sup> showed in 1916 that young food-fishes, and also small shore-fishes, pick out certain species of Copepoda (such as Harpacticoids) and catch them individually—either lying in wait or searching for them. A couple

<sup>12</sup> Journ. Mar. Biol. Assoc., vol. viii. (1909), pp. 394-406.

<sup>13</sup> Conseil Internat. Bull. Trimestr., 1902-8, "Planktonique," p. 89.

<sup>14</sup> "Snellia Runiana," lili, Linn. Soc. Journ., Zoology, vol. xxvii, p. 95, 1918.

<sup>15</sup> Rep. Danish Biol. Stat., vol. xxiv., 1916.



of years later<sup>16</sup> Dr. Marie Lebour published a detailed account of her work at Plymouth on the food of young fishes, proving that certain fish undoubtedly do prefer certain planktonic food.

These Crustacea of the plankton feed upon smaller and simpler organisms—the Diatoms, the Peridinians, and the Flagellates—and the fish themselves in their youngest post-larval stages are nourished by the same minute forms of the plankton. Thus it appears that our sea-fisheries ultimately depend upon the living plankton, which no doubt, in its turn, is affected by hydrographic conditions. A correlation seems to be established between the Cornish pilchard fisheries and periodic variations in the physical characters (probably the salinity) of the water of the English Channel between Plymouth and Jersey.<sup>17</sup> Apparently a diminished intensity in the Atlantic current corresponds with a diminished fishery in the following summer. Possibly the connection in these cases is through an organism of the plankton.

It is only a comparatively small number of different kinds of organisms—both plants and animals—that make up the bulk of the plankton that is of real importance to fish. One can select about half a dozen species of Copepoda which constitute the greater part of the summer zoo-plankton suitable as food for larval or adult fishes, and about the same number of generic types of Diatoms which similarly make up the bulk of the available spring phyto-plankton year after year. This fact gives great economic importance to the attempt to determine with as much precision as possible the times and conditions of occurrence of these dominant factors of the plankton in an average year. An obvious further extension of this investigation is an inquiry into the degree of coincidence between the times of appearance in the sea of the plankton organisms and of the young fish, and the possible effect of any marked absence of correlation in time and quantity.

Just before the war the International Council for the Exploration of the Sea<sup>18</sup> arrived at the conclusion that fishery investigations indicated the probability that the great periodic fluctuations in the fisheries are connected with the fish-larvæ being developed in great quantities only in certain years. Consequently they advised that plankton work should be directed primarily to the question whether these fluctuations depend upon differences in the plankton production in different years. It was then proposed to begin systematic investigation of the fish-larvæ and the plankton in spring and to determine more definitely the food of the larval fish at various stages.

About the same time Dr. Hjort<sup>19</sup> made the interesting suggestion that possibly the great fluctuations in the number of young fish observed from year to year may not depend wholly upon the number of eggs produced, but also upon the relation in time between the hatching of these eggs and the appearance in the water of the enormous quantity of Diatoms and other plant plankton upon which the larval fish, after the absorption of their yolk, depend for food. He points out that if even a brief interval occurs between the time when the larvæ first require extraneous nourishment and that when such food is available, it is highly probable that an enormous mortality would result. In that case even a rich spawning season might yield but a poor result in fish in the commercial fisheries of successive years for some time to come. So that, in fact, the numbers of a year-class may depend not so much upon a favourable spawning season as upon a coincidence between the hatching of

the larvæ and the presence of abundance of phyto-plankton available as food.<sup>20</sup>

The curve for the spring maximum of Diatoms corresponds in a general way with the curve representing the occurrence of pelagic fish-eggs in our seas. But is the correspondence sufficiently exact and constant to meet the needs of the case? The phyto-plankton may still be relatively small in amount during February and part of March in some years, and it is not easy to determine exactly when, in the open sea, the fish-eggs have hatched out in quantity and the larvæ have absorbed their food-yolk and started feeding on Diatoms.

If, however, we take the case of one important fish—the plaice—we can get some data from our hatching experiments at the Port Erin Biological Station, which have now been carried on for a period of seventeen years. An examination of the hatchery records for these years in comparison with the plankton records of the neighbouring sea, which have been kept systematically for the fourteen years from 1907 to 1920 inclusive, shows that in most of these years the Diatoms were present in abundance in the sea a few days at least before the fish-larvæ from the hatchery were set free, and that it was only in four years (1908, 1909, 1913, and 1914) that there was apparently some risk of the larvæ finding no phyto-plankton food or very little. The evidence so far seems to show that if fish-larvæ are set free in the sea so late as March 20 they are fairly sure of finding suitable food<sup>21</sup>; but if they are hatched so early as February they run some chance of being starved.

But this does not exhaust the risks to the future fishery. C. G. Joh. Petersen and Boysen-Jensen in their valuation of the Limfjord<sup>22</sup> have shown that in the case not only of some fish, but also of the larger invertebrates on which they feed, there are marked fluctuations in the number of young produced in different seasons, and that it is only at intervals of years that a really large stock of young is added to the population.

The prospects of a year's fishery may, therefore, depend primarily upon the rate of spawning of the fish, affected, no doubt, by hydrographic and other environmental conditions; secondarily, upon the presence of a sufficient supply of phyto-plankton in the surface-layers of the sea at the time when the fish-larvæ are hatched, and that, in its turn, depends upon photosynthesis and physico-chemical changes in the water; and, finally, upon the reproduction of the stock of molluscs or worms at the bottom which constitute the fish-food at later stages of growth and development.

The question has been raised in recent years: Is there enough plankton in the sea to provide sufficient nourishment for the larger animals, and especially for those fixed forms, such as sponges, that are supposed to feed by drawing currents of plankton-laden water through the body? In a series of remarkable papers from 1907 onwards Pütter and his followers put forward the views: (1) that the carbon requirements of such animals could not be met by the amount of plankton in the volume of water that could be passed through the body in a given time, and (2) that sea-water contained a large amount of dissolved organic carbon compounds which constitute the chief, if not the only, food of a large number of marine animals. These views have given rise to

<sup>20</sup> For the purpose of this argument we may include in "phyto-plankton" the various groups of Flagellata and their minute organisms which may be present with the Diatoms.

<sup>21</sup> All dates and statements as to occurrence refer to the Irish Sea round the south end of the Isle of Man. For further details see Report Lancs Sea-Fish. Lab. for 1919.

<sup>22</sup> Report of Danish Bio'l. Station for 1919.

<sup>16</sup> Journ. Mar. Biol. Assoc., May, 1918.

<sup>17</sup> See E. C. Jee, "Hydrography of the English Channel," 1904-17.

<sup>18</sup> Rapports et Proc. Verbs., vol. xix., December, 1915.

<sup>19</sup> *Ibid.*, vol. x., 1914, p. 204.

much controversy, and have been useful in stimulating further research, but I believe it is now admitted that Pütter's samples of water from the Bay of Naples and at Kiel were probably polluted, that his figures were erroneous, and that his conclusions must be rejected, or at least greatly modified. His estimates of the plankton were minimum ones, while it seems probable that his figures for the organic carbon present represent a variable amount of organic matter arising from one of the reagents used in the analyses.<sup>23</sup> The later experimental work of Henze, of Raben, and of Moore shows that the organic carbon dissolved in sea-water is an exceedingly minute quantity, well within the limits of experimental error. Moore puts it at the most at one-millionth part, or 1 mgm. in a litre. At the Dundee meeting of the Association in 1912 a discussion on this subject took place, at which Pütter still adhered to a modified form of his hypothesis of the inadequacy of the plankton and the nutrition of lower marine animals by the direct absorption of dissolved organic matter. Further work at Port Erin since has shown that, while the plankton supply as found generally distributed would prove sufficient for the nutrition of such sedentary animals as Sponges and Ascidians, which require to filter only about fifteen times their own volume of water per hour, it is quite inadequate for active animals such as crustaceans and fishes. These latter are, however, able to seek out and capture their food, and are not dependent on what they may filter or absorb from the sea-water. This result accords well with recorded observations on the irregularity in the distribution of the plankton and with the variations in the occurrence of the migratory fishes which may be regarded as following and feeding upon the swarms of planktonic organisms.

This, then, like most of the subjects I am dealing with, is still a matter of controversy, still not completely understood. Our need, then, is research, more research, and still more research.

Our knowledge of the relations between plankton productivity and variation and the physico-chemical environment is still in its infancy, but gives promise of great results in the hands of the biochemist and the physical chemist.

Recent papers by Sørensen, Palitzsch, Witting, Moore, and others have made clear that the amount of hydrogen-ion concentration as indicated by the relative degree of alkalinity and acidity in the sea-water may undergo local and periodic variations, and that these have an effect upon the living organisms in the water and can be correlated with their presence and abundance. To take an example from our own seas, Prof. Benjamin Moore and his assistants in their work at the Port Erin Biological Station in successive years from 1912 onwards have shown<sup>24</sup> that the sea around the Isle of Man is a good deal more alkaline in spring (say April) than it is in summer (say July). The alkalinity, which gets low in summer, increases somewhat in autumn, and then decreases rapidly, to disappear during the winter; and then once more, after several months of a minimum, begins to come into evidence again in March, and rapidly rises to its maximum in April or May. This periodic change in alkalinity will be seen to correspond roughly with the changes in the living microscopic contents of the sea represented by the phyto-plankton annual curve, and the connection between the two will be seen when we realise that the alkalinity of the sea is due to the relative absence of carbon dioxide. In early spring, then, the developing myriads of

Diatoms in their metabolic processes gradually use up the store of carbon dioxide accumulated during the winter or derived from the bicarbonates of calcium and magnesium, and so increase the alkalinity of the water until the maximum of alkalinity, due to the fixation of the carbon and the reduction in amount of carbon dioxide, corresponds with the crest of the phyto-plankton curve in, say, April. Moore has calculated that the annual turnover in the form of carbon which is used up or converted from the inorganic into an organic form probably amounts to something of the order of 20,000-30,000 tons of carbon per cubic mile of sea-water, or, say, over an area of the Irish Sea measuring 16 square miles and a depth of 50 fathoms; and this probably means a production each season of about two tons of dry organic matter, corresponding to at least ten tons of moist vegetation, per acre—which suggests that we may still be very far from getting from our seas anything like the amount of possible food-matters that are produced annually.

Testing the alkalinity of the sea-water may therefore be said merely to be ascertaining and measuring the results of the photosynthetic activity of the great phyto-plankton rise in spring due to the daily increase of sunlight.

The marine biologists of the Carnegie Institution, Washington, have made a recent contribution to the subject in certain observations on the alkalinity of the sea (as determined by hydrogen-ion concentration), during which they found in tropical mid-Pacific a sudden change to acidity in a current running eastwards. Now in the Atlantic the Gulf Stream and tropical Atlantic waters generally are much more alkaline than the colder coastal water running south from the Gulf of St. Lawrence—that is, the colder Arctic water has more carbon dioxide. This suggests that the Pacific easterly set may be due to deeper water, containing more carbon dioxide (=acidity), coming to the surface at that point. The alkalinity of the sea-water can be determined rapidly by mixing the sample with a few drops of an indicator and observing the change in colour; and this method of detecting ocean currents by observing the hydrogen-ion concentration of the water might be useful to navigators as showing the time of entrance to a known current.

Oceanography has many practical applications, chiefly, but by no means wholly, on the biological side. The great fishing industries of the world deal with living organisms, of which all the vital activities and the inter-relations with the environment are matters of scientific investigation. Aquiculture is as susceptible of scientific treatment as agriculture can be; and the fisherman, who has been in the past too much the nomad and the hunter—if not, indeed, the devastating raider—must become in the future the settled farmer of the sea if his harvest is to be less precarious. Perhaps the nearest approach to cultivation of a marine product, and of the fisherman reaping what he has actually sown, is seen in the case of the oyster and mussel industries on the west coast of France, in Holland, America, and, to a less extent, on our own coast. Much has been done by scientific men for these and other similar coastal fisheries since the days when Prof. Coste in France in 1859 introduced oysters from the Scottish oyster-beds to start the great industry at Arcachon and elsewhere. Now we buy back the descendants of our own oysters from the French ostriculterists to replenish our depleted beds.

It is no small matter to have introduced a new and important food-fish to the markets of the world. The remarkable deep-water "tile-fish," new to science and

<sup>23</sup> See Moore, etc., *Bio-Chem. Journ.*, vol. vi., p. 266, 1912.

<sup>24</sup> "Photosynthetic Phenomena in Sea-water," *Trans. Liverpool Biol. Soc.*, vol. xxix., p. 233, 1915.

described as *Lopholatilus chamaeleonticeps*, was discovered in 1879 by one of the United States fishing schooners to the south of Nantucket, near the 100-fathom line. Several thousand pounds' weight was caught, and the matter was duly investigated by the United States Fish Commission. For a couple of years after that the fish was brought to market in quantity, and then something unusual happened at the bottom of the sea, and in 1882 millions of dead tile-fish were found floating on the surface over an area of thousands of square miles. The schooner *Navarino* sailed for two days and a night through at least 150 miles of sea thickly covered, so far as the eye could reach, with dead fish, estimated at 256,000 to the square mile. The Fish Commission sent a vessel to fish systematically over the grounds known as the "Gulf Stream slope," where the tile-fish had been so abundant during the two previous years, but she did not catch a single fish, and the associated sub-tropical invertebrate fauna was also practically obliterated.

This wholesale destruction was attributed by the American oceanographers to a sudden change in the temperature of the water at the bottom, due in all probability to a withdrawal southwards of the warm Gulf Stream water and a flooding of the area by the cold Labrador current.

I am indebted to Dr. C. H. Townsend, director of the celebrated New York Aquarium, for the latest information in regard to the reappearance in quantity of this valuable fish upon the old fishing-grounds of Nantucket and Long Island, at about 100 miles from the coast to the east and south-east of New York. It is believed that the tile-fish is now abundant enough to maintain an important fishery, which will add an excellent food-fish to the markets of the United States. It is easily caught with lines at all seasons of the year, and reaches a length of more than 3 ft. and a weight of 40-50 lb. During July, 1915, the product of the fishery was about 2,500,000 lb. weight, valued at 55,000 dollars, and in the first few months of 1917 the catch was 4,500,000 lb., for which the fishermen received 247,000 dollars.

We can scarcely hope in European seas to add new food-fishes to our markets, but much may be done through the co-operation of scientific investigators of the ocean with the administrative departments to bring about a more rational conservation and exploitation of the national fisheries.

Earlier in this address I referred to the pioneer work of the distinguished Manx naturalist, Prof. Edward Forbes. There are many of his writings and of his lectures to which I have no space to refer which have points of oceanographic interest. Take this, for example, in reference to our national sea-fisheries. We find him in 1847 writing to a friend: "On Friday night I lectured at the Royal Institution. The subject was the bearing of submarine researches and distribution matters on the fishery question. I pitched into Government mismanagement pretty strong, and made a fair case of it. It seems to me that at a time when half the country is starving we are utterly neglecting or grossly mismanaging great sources of wealth and food. . . . Were I a rich man I would make the subject a hobby for the good of the country and for the better proving that the true interests of Government are those linked with and inseparable from Science." We must still cordially approve of these last words, while recognising that our Government Department of Fisheries is now being organised on better lines, is itself carrying on scientific work of national importance, and is, I am happy to think, in complete sympathy with the work of independent scientific investigators of the sea and desirous of closer

co-operation with university laboratories and biological stations.

During recent years one of the most important and most frequently discussed of applications of fisheries investigation has been the productivity of the trawling grounds, and especially those of the North Sea. It has been generally agreed that the enormous increase of fishing power during the last forty years or so has reduced the number of large plaice, so that the average size of that fish caught in our home waters has become smaller, although the total number of plaice landed had continued to increase up to the year of the outbreak of war. Since then, from 1914 to 1919, there has of necessity been what may be described as the most gigantic experiment ever seen in the closing of extensive fishing-grounds. It is still too early to say with any certainty exactly what the results of that experiment have been, although some indications of an increase of the fish population in certain areas have been recorded. For example, the Danes, A. C. Johansen and Kirstine Smith, find that large plaice landed in Denmark are now more abundant, and they attribute this to a reversal of the pre-war tendency, due to less intensive fishing. But Dr. James Johnstone has pointed out that there is some evidence of a natural periodicity in abundance of such fish, and that the results noticed may represent phases in a cyclic change. If the periodicity noted in Liverpool Bay<sup>25</sup> holds good for other grounds, it will be necessary in any comparison of pre-war and post-war statistics to take this natural variation in abundance into very careful consideration.

In the application of oceanographic investigations to sea-fisheries problems one ultimate aim, whether frankly admitted or not, must be to obtain some kind of a rough approximation to a census or valuation of the sea—of the fishes that form the food of man, of the lower animals of the sea-bottom on which many of the fishes feed, and of the planktonic contents of the upper waters which form the ultimate organised food of the sea—and many attempts have been made in different ways to attain the desired end.

Our knowledge of the number of animals living in different regions of the sea is for the most part relative only. We know that one haul of the dredge is larger than another, or that one locality seems richer than another, but we have very little information as to the actual numbers of any kind of animal per square foot or per acre in the sea. Hensen, as we have seen, attempted to estimate the number of food-fishes in the North Sea from the number of their eggs caught in a comparatively small series of hauls of the tow-net, but the data were probably quite insufficient and the conclusions may be erroneous. It is an interesting speculation to which we cannot attach any economic importance. Heineke says of it: "This method appears theoretically feasible, but presents in practice so many serious difficulties that no positive results of real value have as yet been obtained."

All biologists must agree that to determine even approximately the number of individuals of any particular species living in a known area is a contribution to knowledge which may be of great economic value in the case of the edible fishes, but it may be doubted whether Hensen's methods, even with greatly increased data, will ever give us the required information. Petersen's method, of setting free marked plaice and then assuming that the proportion of these recaptured is to the total number marked as the fishermen's catch in the same district is to the total population, will hold good only in circumscribed areas where there is practically no migration and the fish

<sup>25</sup> See Johnstone, Report Lancs Sea-Fish. Lab. for 1917, p. 60; and Daniel, Report for 1919, p. 51.

are fairly evenly distributed. This method gives us what has been called "the fishing coefficient," and this has been estimated for the North Sea to have a probable value of about 0.33 for those sizes of fish which are caught by the trawl. Heinecke,<sup>26</sup> from an actual examination of samples of the stock on the ground obtained by experimental trawling ("the catch coefficient"), supplemented by the market returns of the various countries, estimates the adult plaice at about 1,500,000,000, of which about 500,000,000 are caught or destroyed by the fishermen annually.

It is difficult to imagine any further method which will enable us to estimate any such case as, say, the number of plaice in the North Sea, where the individuals are so far beyond our direct observation and are liable to change their positions at any moment. But a beginning can be made on more accessible ground with more sedentary animals, and Dr. C. G. Joh. Petersen, of the Danish Biological Station, has for some years been pursuing the subject in a series of interesting reports on "The Evaluation of the Sea."<sup>27</sup> He uses a bottom-sampler or grab, which can be lowered down open and then closed on the bottom so as to bring up a sample square foot or square metre (or in deep water one-tenth of a square metre) of the sand or mud and its inhabitants. With this apparatus, modified in size and weight for different depths and bottoms, Petersen and his fellow-workers have made a very thorough examination of the Danish waters, and especially of the Kattegat and the Limfjord, have described a series of "animal communities" characteristic of different zones and regions of shallow water, and have arrived at certain numerical results as to the quantity of animals in the Kattegat expressed in tons—such as 5000 tons of plaice requiring as food 50,000 tons of "useful animals" (mollusca and polychæt worms), and 25,000 tons of starfish using up 200,000 tons of useful animals which might otherwise serve as food for fishes, and the dependence of all these animals directly or indirectly upon the great Beds of *Zostera*, which make up 24,000,000 tons in the Kattegat. Such estimates are obviously of great biological interest, and, even if only rough approximations, are a valuable contribution to our understanding of the metabolism of the sea and of the possibility of increasing the yield of local fisheries.

But on studying these Danish results in the light of what we know of our own marine fauna, although none of our seas have been examined in the same detail by the bottom-sampler method, it seems probable that the animal communities as defined by Petersen are not exactly applicable on our coasts, and that the estimates of relative and absolute abundance may be very different in different seas under different conditions. The work will have to be done in each great area, such as the North Sea, the English Channel, and the Irish Sea, independently. This is a necessary investigation, both biological and physical, which lies before the oceanographers of the future, upon the results of which the future preservation and further cultivation of our national sea-fisheries may depend.

It has been shown by Johnstone and others that the common edible animals of the shore may exist in such abundance that an area of the sea may be more productive of food for man than a similar area of pasture or crops on land. A Lancashire mussel-bed has been shown to have as many as 16,000 young mussels per square foot, and it is estimated that in the shallow

waters of Liverpool Bay there are from 20 to 200 animals of sizes varying from an amphipod to a plaice on each square metre of the bottom.<sup>28</sup>

From these and similar data which can be readily obtained it is not difficult to calculate totals by estimating the number of square yards in areas of similar character between tide-marks or in shallow water. And from weighings of samples some approximation to the number of tons of available food may be computed. But one must not go too far. Let all the figures be based upon actual observation. Imagination is necessary in science, but in calculating a population of even a very limited area it is best to believe only what one can see and measure.

Countings and weighings, however, do not give us all the information we need. It is something to know even approximately the number of millions of animals on a mile of shore and the number of millions of tons of possible food in a sea area, but that is not sufficient. All food-fishes are not equally nourishing to man, and all plankton and bottom invertebrates are not equally nourishing to a fish. At this point the biologist requires the assistance of the physiologist and the biochemist. We want to know next the value of our food-matters in proteids, carbohydrates, and fats, and the resulting Calories. Dr. Johnstone, of the oceanography department of the University of Liverpool, has already shown us how markedly a fat summer herring differs in essential constitution from the ordinary white fish, such as the cod, which is almost destitute of fat.

Prof. Brandt at Kiel, Prof. Benjamin Moore at Port Erin, and others have similarly shown that plankton gatherings may vary greatly in their nutrient value according as they are composed mainly of Diatoms, of Dinoflagellates, or of Copepoda. And, no doubt, the animals of the "benthos," the common invertebrates of our shores, will show similar differences in analysis.<sup>29</sup> It is obvious that some contain more solid flesh, others more water in their tissues, others more calcareous matter in the exoskeleton, and that therefore, weight for weight, we may be sure that some are more nutritious than others; and this is probably at least one cause of that preference we see in some of our bottom-feeding fish for certain kinds of food, such as polychæt worms, in which there is relatively little waste, and thin-shelled lamellibranch molluscs, such as young mussels, which have a highly nutrient body in a comparatively thin and brittle shell.

My object in referring to these still incomplete investigations is to direct attention to what seems a natural and useful extension of faunistic work for the purpose of obtaining some approximation to a quantitative estimate of the more important animals of our shores and shallow water and their relative values as either the immediate or the ultimate food of marketable fishes.

Each such fish has its "food-chain" or series of alternative chains, leading back from the food of man to the invertebrates upon which it preys, and then to the food of these, and so down to the smallest and simplest organisms in the sea, and each such chain must have all its links fully worked out as to seasonal and quantitative occurrence back to the Diatoms and Flagellates, which depend upon physical conditions, and take us beyond the range of biology, but not beyond that of oceanography. The Diatoms and the Flagellates are probably more important than the more obvious seaweeds not only as food, but also in

<sup>28</sup> "Conditions of Life in the Sea," Cambridge University Press, 1908.

<sup>29</sup> Moore and others have made analyses of the protein, fat, etc., in the soft parts of Sponge, Ascidian, Aplysia, Fusus, Echinus, and Cancer at Port Erin, and find considerable differences—the protein ranging, for example, from 8 to 51 per cent., and the fat from 2 to 14 per cent. (see *Bio-Chemical Journ.*, vol. vi., p. 291).

<sup>26</sup> F. Heinecke, *Cons. Per. Internat. Explor. de la Mer*, "Investigations on the Plaice," Copenhagen, 1913.

<sup>27</sup> See Reports of the Danish Biological Station, and especially the Report for 1918, "The Sea Bottom and its Production of Fish Food.

supplying to the water the oxygen necessary for the respiration of living protoplasm. Our object must be to estimate the rate of production and rate of destruction of all organic substances in the sea.

To attain to an approximate census and valuation of the sea—remote though it may seem—is a great aim, but it is not sufficient. We want not only to observe and to count natural objects, but also to understand them. We require to know not merely what an organism is—in the fullest detail of structure and development and affinities—where it occurs—again in full detail—and in what abundance in different circumstances, but also *how* it lives and what all its relations are to both its physical and its biological environment, and that is where the physiologist, and especially the biochemist, can help us. In the best interests of biological progress the day of the naturalist who merely collects, the day of the anatomist and histologist who merely describe, is over, and the future is with the observer and the experimenter animated by a divine curiosity to enter into the life of the organism and understand how it lives and moves and has its being. "Happy indeed is he who has been able to discover the causes of things."

Cardiff is a seaport, and a great seaport, and the Bristol Channel is a notable sea-fisheries centre of growing importance. The explorers and merchant venturers of the south-west of England are celebrated in history. What are you doing now in Cardiff to advance our knowledge of the ocean? You have here an important university centre and a great modern

national museum, and either or both of these homes of research might do well to establish an oceanographical department, which would be an added glory to your city and of practical utility to the country. This is the obvious centre in Wales for a sea-fisheries institute for both research and education. Many important local movements have arisen from British Association meetings, and if such a notable scientific development were to result from the Cardiff meeting of 1920, all who value the advance of knowledge and the application of knowledge to industry would applaud your enlightened action.

In a wider sense, it is not to the people of Cardiff alone that I appeal, but to the whole population of these islands, a maritime people who owe everything to the sea. I urge them to become better informed in regard to our national sea-fisheries and to take a more enlightened interest in the basal principles that underlie a rational regulation and exploitation of these important industries. National efficiency depends to a very great extent upon the degree in which scientific results and methods are appreciated by the people and scientific investigation is promoted by the Government and other administrative authorities. The principles and discoveries of science apply to aquiculture no less than to agriculture. To increase the harvest of the sea the fisheries must be continuously investigated, and such cultivation as is possible must be applied, and all this is clearly a natural application of the biological and hydrographical work now united under the science of oceanography.

## Summaries of Addresses of Presidents of Sections of the British Association.

### Mathematical and Physical Science.

PROF. EDDINGTON'S presidential address to Section A deals with the investigation of the internal conditions of the stars. Most of the naked-eye stars have densities so low that they may be treated as spheres of perfect gas (giant stars). In familiar hot bodies the energy existing in the æther (radiant heat) is extremely small compared with that associated with the matter (molecular motions); conditions might exist in which this disproportion was reversed; but the stars are of just such a mass that the two kinds of energy are roughly equal. It is thought that this balance cannot be a coincidence, but determines why the masses of the stars are always close to a particular value. From astronomical data as to the masses and radiation of the stars it is possible to determine the opacity of stellar material to the radiation traversing it. The opacity turns out to be very high and of the same order of magnitude as that found for X-rays in the laboratory. (At the high temperatures in the stars the radiation consists mainly of soft X-rays.) A rather surprising result is that the opacity varies very little with the temperature of the star or wave-length of the radiation. The discussion leads to many astronomical results which appear to be generally confirmed by observation; in particular, it fixes within fairly narrow limits the period of a mechanical pulsation of any star, and this agrees in all known Cepheid variables with the observed period of light-pulsation. The question of the source of a star's heat is raised in an acute form by these investigations. It appears that the energy of gravitational contraction is quite inadequate. The recent experimental results of Aston and Rutherford seem to throw some new light on the often-discussed question whether sub-atomic energy can be made available in the stars. The address concludes with some observations on the legitimate place of speculation in scientific research.

### Chemistry.

MR. C. T. HEYCOCK deals in his presidential address to Section B with the manner in which our present rather detailed knowledge of metallic alloys has been acquired, starting from the sparse information which was available thirty or forty years ago, and sketches briefly the present position of the subject. He considers chiefly the non-ferrous alloys, not because any essential difference in type exists between these and ferrous alloys, but because the whole field presented by the chemistry of the metals and their alloys is too vast to be covered in an address of reasonable length. Though Réaumur in 1722 employed the microscope to examine the fractured surfaces of white and grey cast-iron and steel, and Widmanstätten in 1808 polished and etched sections from meteorites, the founder of modern metallography is undoubtedly H. C. Sorby, whose methods of polishing and etching alloys and of vertical illumination are used to-day by all who work at this subject. The first important clue to what occurs on cooling a fused mixture of metals was given by Guthrie's experiments on cryohydrates, and these researches, with those of Sorby, undertaken as they were for the sake of investigating natural phenomena, are remarkable examples of how purely scientific experiment can lead to most important practical results. Raoult's work on the depression of the freezing point of solvents due to the addition of dissolved substances led to the establishment by van't Hoff of a general theory applicable to all solutions. Later experiments established the similarity between the behaviour of metallic solutions or alloys and that of aqueous and other solutions of organic compounds in organic solvents; and in 1807 Neville and Heycock determined the complete freezing-point curve of the copper-tin alloys, confirming and extending the work of Roberts-Austen, Stansfield, and Le Chatelier. These were probably the first of the binary alloys on

which an attempt was made to determine the changes which take place in passing from one pure constituent to the other; and without a working theory of solution the interpretation of the results would have been impossible. Many difficulties are encountered in the examination of binary alloys, but they are enormously increased in the investigation of ternary alloys, and with quaternary alloys they seem almost insurmountable; in the case of steels containing always six, and usually more, constituents, information can be obtained at present by purely empirical methods only.

### Geology.

In discussing the relations of palæontology to other branches of biology in his presidential address to Section C, Dr. F. A. Bather emphasises the influence of the time-concept, which gives palæontology a fourth dimension and necessitates a new method of classification. The known facts of succession, while upsetting some rash speculations, do not, unaided, prove descent. Recapitulation, however, does furnish the desired proof. The "line-upon-line" method of research is the only sure one, and this has brought out a continuous transition in development, and definite directions leading to a seriation of forms. But this appearance of seriation, though it may be sometimes due to determinate variation, in no way implies determination; and still less do the facts warrant the belief in predetermination so generally held by palæontologists. After rebutting the various arguments for predestination, counter-adaptive degeneration, and momentum in evolution, Dr. Bather shows how light is thrown on the supposed instances by the study of adaptive form and of habitat. The varying rate of evolution, the recurrent cycles of structure, and the birth and death of races, all are dependent on the secular changes of environment. To correlate the succession of living forms with those changes is the task of the palæontologist. When completed, our geological systems will express truly the rhythm of evolution. But if there is no inevitable law of progress for any living creature, neither is there a law of decadence; and man, by controlling his environment and adapting his race through conscious selection, has but to aim at a high mark in order to prolong and hasten his ascent.

### Zoology.

Prof. Stanley Gardiner in his presidential address to Section D asks the consideration of the public to the claims of zoology to support, and of the professional students of the science to the comparative sterility of much of their teaching and research. The chief claim of zoology lies in its broad applicability to human life. Harvey's researches on circulation and embryology apply directly to medicine and human growth. Malaria, typhus, dysentery, trench fever, and now, perhaps, cancer, are understandable only by the studies of the pure zoologist on insects and on the physiology of unicellular organisms. Mendel's work gives hopes of the understanding of the laws governing human heredity and of establishing immunity to many diseases. Economic entomology is founded on the seventeenth-century study of insect life-histories, and now we struggle for knowledge of the enemies or parasites of insects wherewith to destroy them by natural means. Curiosity as to the possibilities of life in the deep sea led to the opening up of great banks, without which our fishing industry would still be a small thing. River-eels migrate thousands of miles to breed, and mackerel migrations are correlated with sunlight; the Swedish herring fisheries depend on cycles of sun-spots and longer cycles of lunar changes.

Great as are such results, they approach the limit of what can be attained from the old zoological studies of anatomy, distribution and development. The future lies in the study of the living protoplasm, its universal association with water, the effects of acidity or alkalinity on reproduction and growth, the possibilities of dissolved food substances and perhaps of vitamins in water, and, finally, reproduction without the help of the male. Yet zoology is in danger, for its results are seldom immediately applicable to industry, and economic specialists are trying to make their students study their specialities without having a sufficiently broad scientific education to be able to consider what life really is. The old naturalists were largely cataloguers, but what they sought was the understanding of life. Then came in succession the anatomists, the embryologists, and the evolutionists, the last clearly seen to-day in that the subject as taught in many schools is merely history. Zoology must emancipate itself from its dry bones, and recognise that its museums and institutions are means only for the study of life itself.

### Geography.

In his presidential address to Section E Mr. J. McFarlane discusses the principles upon which the territorial rearrangement of Europe has been based. He considers that the promise of stability is greatest in those cases where geographical and ethnical conditions are most in harmony, and least where undue weight has been given to considerations which are neither geographical nor ethnical. The transfer of Alsace-Lorraine to France must be defended, if at all, on the ground that its inhabitants are more attached to France than to Germany. The loss of territory which Germany has sustained both in the east and in the west is aggravated by the fact that from the regions lost she has in the past obtained much of her coal and iron-ore. Serious as her position is, however, her economic stability is not necessarily threatened. The position of Poland is geographically weak, partly because the surface features are such that the land has no well-marked individuality, and partly because there are no natural boundaries to prevent invasion or to restrain the Poles from wandering beyond the ethnic limits of their State. On the other hand, the population is sufficiently large and the Polish element within it sufficiently strong to justify its independence on ethnical grounds.

Czecho-Slovakia, in various ways the most interesting country in the reconstructed Europe, is alike geographically and ethnically marked by some features of great strength and by others of great weakness. Bohemia possesses geographical individuality, and Slovakia is at least strategically strong, but Czecho-Slovakia as a whole does not possess geographical unity, and is, in a sense, strategically weak, since Moravia, which unites Bohemia and Slovakia, lies across the great route from the Adriatic to the plains of Northern Europe. Rumania has sacrificed unity of political outlook and ethnic homogeneity by the annexation of Transylvania, while her position on the Hungarian plain is likely sooner or later to involve her in further trouble with the Magyars. Indeed, the treatment of the Hungarian plain is the most unsatisfactory part of the whole Peace settlement. In that great natural region the Magyar element is the strongest, and to divide it as has been done is to induce a position of unstable equilibrium which is likely to lead to trouble in the future.

The troubles of Austria are due to the fact that she has failed to realise that an empire such as hers can be permanently retained only on a basis of common

political and economic interest. At present she has no place in the reconstructed Europe, and a complete political re-orientation will be necessary if she is to emerge successfully from her present trials.

The pre-war frontier of Italy in the east is unsatisfactory, because it assigns to Austria the essentially Italian region of the Lower Isonzo. But beyond that region and a position on the neighbouring highlands for strategic purposes, Italy has no claim except what she can establish on ethnic grounds. The so-called "Wilson line" meets her requirements fairly well.

#### Economic Science and Statistics.

Dr. J. H. Clapham's presidential address to Section F contains a comparison and contrast between the economic condition of Western Europe after the Napoleonic wars and its economic condition to-day. Figures for the total losses of France and for the debt accumulated by Great Britain during the former period go to prove that if warfare in those days lacked intensity, it made up in duration. As in 1918, France was short of men, and her means of communication had suffered; her rapid recovery illustrates the essential difference between the two periods: a hundred years ago few men were demobilised in either France or Germany, and these were readily absorbed in an agricultural community. In 1816 the harvest was bad, and Western Europe approached starvation; the situation was saved only by the excellent harvest of the following year. Economic organisation was primitive, but elastic. A modern parallel is Serbia, which has improved wonderfully since the bountiful harvest of 1919. Germany suffered rather longer owing to the lack of a strong central Government; the States which have risen from the wreckage of the Austro-Hungarian Empire are now in a similar plight. Great Britain was partly industrial, and recovery was delayed by mismanagement of supplies, taxation, and demobilisation. Stocks of Colonial goods had accumulated with which home markets were flooded, and a commercial and industrial crisis followed. A similar situation exists now in the United States; she is a creditor nation with a big export trade, but she will not permit indiscriminate exchange. Modern financial methods are staving off such a crisis as followed the Napoleonic wars. The central problem is: When will the inability of war-damaged countries to pay for the material they require to restart their industries be felt by the nations supplying them? If trade balances are adjusted, the post-war slump will become a slow decline; otherwise, a crisis must occur when international obligations cannot be met. Another feature of the situation in the early part of the nineteenth century was the rapid growth in population observed everywhere. Official figures indicate the possibility of a repetition of this phenomenon.

#### Engineering.

Prof. C. F. Jenkin in his presidential address to Section G suggests that the time has come for an extensive revision of the theory of the strength of materials as used by engineers. The mathematical theory needs to be extended to cover anisotropic materials, such as timber, and to enable concentrations of stress such as occur at all changes of section to be calculated. Our knowledge of the physical properties of materials requires to be extended so that their suitability for all engineering purposes may be known. The need for the wider theory and for more research into the properties of materials is illustrated by examples of the problems which occurred in aeroplane construction during the war. The first material dealt with by the Air Service was timber. How was the strength of such

material to be calculated? It was shown that the components of the tensile stress in three principal directions must not exceed the tensile strengths in those directions. Curves limiting the stress at any angle to the grain have been drawn for spruce, ash, wainut, and mahogany. For plywood, "split-off" veneers were recommended in place of "cut-off" wood. The method used for the determination of Young's modulus for wood neglects the effect of shear, and is therefore inaccurate. As an example of an isotropic substance steel is discussed. Fatigue limit is suggested as a measure of strength; in samples examined it was found to be slightly less than half the ultimate strength. Research is necessary to determine the effects of the speed of testing, rest and heat treatment, and previous testing. For this improved methods are required; Stromeyer's method would be useful if modified for commercial use. Present methods of testing in torsion are unsatisfactory, and knowledge of the internal mechanism of fatigue failure is required. For members of structures subjected to steady loads a proof-load specification which limits the permanent set to  $\frac{1}{2}$  per cent. or  $\frac{1}{4}$  per cent. is suggested. If fatigue limit is the basis for engineering calculation, the distribution of stresses in irregularly shaped parts of the machine must be investigated. Prof. Coker's optical method has been applied to this end, but A. A. Griffith's calculations on the effects of grooves and polishing have not been tested. Wood and steel are the only materials about which trustworthy data have been collected.

#### Anthropology.

Prof. Karl Pearson in his presidential address to Section H urges the importance of anthropology, "the true study of mankind." Science should be studied, not for itself, but for the sake of man. For this reason there is no use for the collection of measurements of height, span, size of head, etc. The important characteristics are the psycho-physical and psycho-physiological factors, reaction-time, mental age, and pulse-tracing. Body measurement has no connection with "vigorimetry" and psychometry, for no pure "line" in man has been traced. Moreover, present methods are entirely qualitative; they must be made quantitative. Three things are urged as essential to the recognition of anthropology as a useful science. First, folk-psychology as well as individual psychology should be studied as a means to determine race efficiency. For this purpose, the ancestry of man must be investigated in order that we may know which is likely to have the greater influence on his future, Nature or nurture. Secondly, institutes for the study of anthropology ought to be established in at least three of our universities. There the workers would be in touch with allied sciences, they would have a wide field open for measurements, and would be able to teach as well as to research on the subject. In this way men could be fitted for important "extra-State" work as diplomatic agents, traders, etc., in foreign lands. Another section of the work should be devoted to a study of the population at large; the schools, the factories, and the prisons must all be investigated, so that the present wasteful organisation of society may be remedied. When its value to the State has been proved, anthropology can ask for adequate support as its right. The third point urged is the adoption of a new technique. Logical accuracy and mathematical exactness must be introduced; training should start with anthropometry in its broadest sense, advancing later to ethnology, sociology, prehistory, and the evolution of man. Only by devotion to problems of real use can anthropology achieve her true position as "Queen of the Sciences."

### Physiology.

Mr. Joseph Barcroft in his presidential address to Section I deals particularly with anoxæmia—by derivation a deficient quantity of oxygen in the blood—which is used to cover a larger field embracing all those conditions in which the supply of oxygen to the tissues is inadequate. The statement has been made that anoxæmia not only stops, but also wrecks, the machine. An inquiry into this statement cannot be made without first specifying whether the anoxæmia is sudden and profound, as in drowning, poisoning with mine-gas, etc., or is of long duration but trivial in degree. In the former case the stoppage of the machine may be almost complete, as in the case of persons rendered unconscious by carbon monoxide, by stoppage of the cerebral circulation, or by attaining an altitude in the air at which the oxygen pressure is too low. In such cases the permanent damage to the machinery is very slight. On the other hand, mild anoxæmia continued over weeks and months, as in sufferers from gas-poisoning, shallow respiration, and deficient ventilation of portions of the lung, is stated by Haldane, Meakins, and Priestley to produce far-reaching effects on the central nervous system. Anoxæmia may be classified as consisting of three categories. They are tabulated as follows, with examples:

#### ANOXÆMIA.

Types	I. Anoxic	II. Anæmic	III. Stagnant
Characteristics	Too little oxygen pressure and too much reduced hæmoglobin in arterial blood, which is too dark in colour	Too little oxy-hæmoglobin, but normal oxygen pressure in arterial blood, which is bright unless discoloured by some abnormal pigment	Arterial blood normal in oxygenation, but blood-flow too slow
Examples	Mountain sickness, pneumonia, etc.	Anæmia CO poisoning Methæmoglobin poisoning	Shock Back pressure

For a given deficiency of oxygen carried to the tissue in unit time the first type is the most serious, and the last least so. The anoxic type is measured by the percentage saturation of the arterial blood; the anæmic by the quantity of oxyhæmoglobin in it; and the stagnant by the "minute volume."

### Botany.

Miss E. R. Saunders in her presidential address to Section K deals with the subject of Heredity. In the brief historical introduction attention is directed to the fundamental opposition between the earlier statistical methods of representing the hereditary process and the Mendelian conception which has its foundation in the act of sexual reproduction. Various complex relations which have proved capable of elucidation through the application of Mendelian principles are illustrated, and evidence is adduced in proof of the applicability of these principles to the case of specific hybrids. Certain cases are described where the unit for which the Mendelian factor stands appears to be a particular state of physiological equilibrium, and where lack of conformity of phenotypic appearance to genotypic constitution can be readily induced by a change in environmental conditions. The assumptions and difficulties involved in the explanations offered by the reduplication theory and the chromosome view respectively are discussed, together with the bearing of the evidence to date upon the question whether the same end-result, viz. segrega-

tion, may not be effected by a different mechanism, or at a different phase of the life-cycle, in different types. As a practical outcome greater co-operation is pleaded for between cytologists, physiologists, chemists, and breeders in attacking genetical problems.

### Educational Science.

Sir Robert Blair in his presidential address to Section L directs attention to two of the wider aspects of present educational activities. The first part of the address is devoted to a general statement of the lines of advance and the success obtained in the application of psychology to the problems of education. The president, however, desires that education should become something more than applied psychology. The science of education "must be built up, not out of the speculations of theorists or from the deductions of psychologists, but by direct, definite, *ad hoc* inquiries concentrated upon the problems of the class-room by teachers themselves. When by their own researches teachers have demonstrated that their art is, in fact, a science, then, and not till then, will the public allow them the moral, social, and economic status which it accords to other professions." The second part of the address consists of an appeal to all voluntary effort to associate itself directly with the work of the local education authority. Sir Robert Blair thinks that our system of education will become national only when such national institutions as the public schools, the endowed grammar schools, and the universities have joined forces with the local education authorities and take a direct share in the solution of their problems. He seeks a form of association which will retain all the advantages of the older traditions.

### Agriculture.

Prof. F. W. Keeble's presidential address to Section M is devoted to the subject of intensive cultivation. Commencing with a review of the work done by horticulturists during the war, it passes on to consider the prospects of success of any large development of intensive cultivation which may be undertaken. It insists on the great need for organisation in research, education, and administration, and describes the organisation which the author established during his tenure of the office of Controller of Horticulture in the Ministry of Agriculture. In this connection the important question of the relation of the "expert" and the "administrator" is considered, and the conclusion reached that "if the work of a Government office is to be and remain purely administrative, no creative capacity is required, and it may be left to the sure and safe and able hands of the trained administrator; but if the work is to be creative it must be under the direction of minds turned, as only research can turn them, in the direction of creativeness." The consideration of our imports, of the reduced acreage under fruit, and of the continuous rise in the standard of living throughout the world suggests that the acreage under fruit might be increased by a good many thousand acres without fear of over-production. After illustrating by a series of striking examples the effect which the practice of intensive cultivation has on bringing about the colonisation of the countryside, the address reaches the conclusion that it is the duty of the State to help the intensive cultivator to hold his own against world-competition by perfecting the organisation of horticulture, and, above all, by providing a thorough and practical system of horticultural education. The measure of success which intensive cultivation will achieve will depend ultimately on the quality and kind of education which the cultivators are able to obtain.



(Continued from p. 812.)

is to be taken as the normal weight of the animal, if we are to determine its surface from its weight? This fundamental question has hitherto defied solution, but is now brought into the realms of exact science, since the work of Prof. Dreyer and Dr. Ainley Walker (2 and 7) has shown that in animals and man definite relationships exist between the trunk length, chest circumference, and body weight of individuals in health, while no accurate relationship, as has long been realised by those familiar with the subject, can be traced between standing height and body weight.

The value of these measurements is enhanced by the fact that, as anatomical data, they will be practically immune from change in diseases which may be accompanied by a loss of weight, and, further, that as they bear a constant relation to the body weight, so must they bear a constant relation to the surface area of that animal.

The relationships which have definitely been shown to exist between "vital capacity," body weight, trunk length, and the circumference of the chest can be expressed by the following formulæ (8):—

(i)  $\frac{W^n}{V.C.} = K_1$ , where the power  $n$  is approximately  $\frac{2}{3}$ , though more accurately 0.72;

(ii)  $\frac{\lambda^n}{V.C.} = K_2$ , where the power  $n$  is approximately 2, though more accurately in males 2.26, in females 2.3;

(iii)  $\frac{Ch^n}{V.C.} = K_3$ , where the power  $n$  is approximately 2, though more accurately in males 1.97, in females 2.54;

while the relationships between body weight, trunk length, and circumference of the chest, respectively, can be expressed as follows:—

(iv)  $\frac{W^n}{\lambda} = K_4$ , where the power  $n$  is approximately  $\frac{1}{3}$ , though more accurately in males 0.319, in females 0.313;

(v)  $\frac{W^n}{Ch} = K_5$ , where the power  $n$  is approximately  $\frac{1}{3}$ , though more accurately in males 0.365, in females 0.284.

In all the above formulæ  $W$ =net body weight in grams,  $\lambda$ =trunk length in centimetres,  $Ch$ =circumference of the chest in centimetres, and  $V.C.$ =vital capacity in cubic centimetres.

The procedures for taking the above-mentioned measurements, briefly described, are as follows:—

(i) Body weight=net weight, without clothes, in grams.

(ii) Trunk length in centimetres is taken by making the subject sit on a level floor with the knees flexed, the os sacrum, spine, and occiput being in contact with an upright measuring standard.

(iii) Circumference of the chest is taken at the

nipple level in males, and just under the breasts in females, the subject being encouraged to talk and breathe naturally while the measurement is being taken.

(iv) The "vital capacity" in cubic centimetres is obtained by taking five consecutive readings with a suitable spirometer. The subject is instructed patiently and carefully how to proceed, and encouraged to make the maximum effort, the highest reading of the five measurements being recorded as the "vital capacity."

The relationships established by Prof. Dreyer, by the examination of individuals in perfect health, provide standards with which an individual or groups of individuals can be compared as regards two fundamental attributes, namely, "physique" and "physical fitness." These two attributes have hitherto been subject to the widest possible individual interpretation, and even in the judgment of one individual are liable to undergo monthly, if not diurnal, variations, dependent upon humour and an infinity of changeable circumstances in observer and observed.

Applying the standards determined for individuals in perfect health, it is found, as might have been expected, that different persons exhibit considerable deviations from these standards, particularly in respect to their "vital capacity," dependent upon their occupation and mode of life. Thus persons living a healthy outdoor life exhibit a greater "vital capacity" than persons following a sedentary occupation, and when this deficiency is *not* due to fundamental bodily defects it can be remedied by properly regulated training and outdoor life.

Critical examination of the available data has enabled Prof. Dreyer to grade the community, for all practical purposes, into three classes, A, B, and C, representing conditions of perfect, medium, and poor physical fitness. A classification on such lines is essential when any degree of accuracy is required in the determination of the aberrations from normal met with in disease. It would obviously be unjustifiable in disease (9) to apply A class standards to the individual who, by reason of his occupation and mode of life, belongs in normal health to C class. The consideration of this aspect of the question, however, need not detain us longer, as being outside the scope of the present article.

It is extremely difficult in so brief an account to do full justice to the immense significance and the great possibilities which lie behind this recent work of Prof. Dreyer's, but sufficient, it is hoped, has been said to show that by systematic measurement of "vital capacity" and the body measures herein discussed, in adults and adolescents, it should be possible to ascertain what detrimental or beneficial effects environment and occupation exert upon the development and health of the individual. Further, it is clear that most important information, from the point of view of national health, should become available in connection with the methods employed to ameliorate the conditions

of those who show deficiencies from the standards obtaining in conditions of perfect health.

## BIBLIOGRAPHY.

- (1) Hutchinson, John: "On the Capacity of the Lungs and on the Respiratory Functions, etc." *Medico-Chirurgical Transactions*, vol. xxix., 1846, London, p. 137; *Lancet*, vol. i., 1846, p. 630.  
 (2) Dreyer, G.: "The Normal Vital Capacity in Man and its Relation to the Size of the Body." *Lancet*, August 9, 1919.  
 (3) Meeh, K.: "Oberflächenmessungen des Menschlichen Körpers." *Zeitschr. für Biologie*, vol. xv., p. 425.  
 (4) Dreyer, G., and Ray, W.: *Phil. Trans. Roy.*

- Soc. London*, series B, vol. cci., p. 133, and vol. ccii., p. 191.  
 (5) Dreyer, G., Ray, W., and Walker, Ainley E. W.: *Proc. Roy. Soc., B*, vol. lxxxvi., 1912, p. 39.  
 (6) *Idem*: *Proc. Roy. Soc., B*, vol. lxxxvi., 1912, p. 56.  
 (7) Walker, Ainley E. W.: "The Growth of the Body in Man; the Relationship between the Body Weight and Body Length." *Proc. Roy. Soc., B*, vol. lxxxix., 1915, p. 157.  
 (8) Dreyer, G., and Hanson, G. F.: "The Assessment of Physical Fitness" (Cassell and Co.).  
 (9) Burrell, L. S. T., and Dreyer, G.: "The Vital Capacity Constants applied to the Study of Pulmonary Tuberculosis." *Lancet*, June 5, 1920.

### The British Association at Cardiff.

THE eighty-eighth annual meeting of the British Association opened at Cardiff on Tuesday morning, in the very unfortunate circumstances of a general strike of tramwaymen and some other sections of the city workmen. It is to be feared that as, unfortunately, paragraphs about this found their way into the Sunday newspapers, this local trouble has had the effect of diminishing the attendance at the meeting. Members and intending members might have rested assured that the city of Cardiff would rise to the occasion. The local secretaries immediately arranged a British Association motor service for the use of members, but it appears that no inconvenience was felt by those who are attending the meeting, and most of the services have now been withdrawn.

It is not possible at the moment of writing to give exact figures of the membership, but it exceeded 1200 on Tuesday morning, so that a fair average meeting was even then certain, in spite of the strike. The weather, always inclined to be wet in this part of the country, and particularly atrocious during the present summer, has taken a turn for the better, and the visitors have had the opportunity of seeing the sun in Cardiff, when the residents had almost forgotten its existence.

The citizens' lecture on "Light and Life," by Prof. J. Lloyd Williams, of University College, Aberystwyth, in the Park Hall, on Monday evening, attracted a large audience, notwithstanding that many of those present had to face a long walk home.

At the inaugural general meeting on Tuesday evening, when Prof. Herdman delivered the illuminating address published in full elsewhere in this issue, the retiring president, Sir Charles Parsons, read a message which the council had sent to the King offering, at this meeting in Wales, the grateful congratulations of the Association for the inspiring work done for the Empire

by the Prince of Wales during his Australasian tour. Sir Charles Parsons read also messages of condolence sent to relatives of Prof. J. Perry and Sir Norman Lockyer at the loss sustained by the recent deaths of these two distinguished representatives of British science—one of whom was general treasurer of the Association from 1904 until his death, while the other was president in 1903-4.

At the meeting of the general committee on Tuesday, the report of the council was adopted nominating Sir Edward Thorpe as president of the Association for the meeting next year in Edinburgh, and Sir Charles Parsons as a permanent trustee, in succession to the late Lord Rayleigh.

The whole of the presidential addresses are this year published in volume form under the title "The Advancement of Science, 1920," at the price of 6s., or 4s. 6d. to members at the meeting. The volume makes a valuable record of the progress and position of many departments of science, and of authoritative conclusions concerning them.

Whilst the meeting is not likely to rank as a "record," the members present are very keen, and everything possible to ensure its success is being done by the city authorities and local Press.

The palatial apartments of the City Hall are being used for the reception room and other offices, whilst in the University College and Technical College near by all the sections are provided with excellent accommodation. The Park Hall, in which the president's address, the evening discourses, and the citizens' lectures are delivered, has a seating capacity of well above 2000, and everyone present has an uninterrupted view and hearing.

The numerous sectional and the two general excursions have not been interfered with by the strike, as they rely chiefly on road or railway transport.

R. V. S.

## Sir Norman Lockyer's Contributions to Astrophysics.

By PROF. A. FOWLER, F.R.S.

BY the death of Sir Norman Lockyer the science of astrophysics has lost the energising and stimulating influence of the last of the great pioneers whose labours opened the way to so vast an extension of our knowledge of the universe. The science of celestial chemistry and physics had its real beginning in 1859, when Kirchhoff's famous experiment on the reversal of spectral lines furnished the key to the interpretation of the dark lines of the solar spectrum, and thence to the determination of the composition of the sun and stars. During the earlier years the outstanding features in the development of the new science were the brilliant investigations of Huggins on the spectra of stars and nebulae, and those of Rutherford and Secchi on the spectroscopic classification of the stars. Curiously enough, the sun had received but little attention during this period, and Lockyer was practically entering a virgin field when, in 1866, he attached a small spectroscope to the modest 6-in. equatorial of his private observatory, and observed the spectrum of a sun-spot independently of the rest of the solar surface. Simple as it may now seem, this process of "taking the sun to bits," as Sir Norman used to call it, was an advance of fundamental importance. It not only gave an immediate and decisive answer to the question as to the cause of the darkness of sun-spots which was then under vigorous discussion in England and France, but also very soon led to the famous discovery of the method of observing solar prominences without an eclipse, with which Lockyer's name, in conjunction with that of Janssen, will for ever be associated. The story of this epoch-making observation has been told too often to need repetition, but it should not be forgotten that the principle of the method had been clearly recognised by Lockyer two years before he succeeded in obtaining a spectroscope suitable for the purpose in view.

Those who have become familiar with the beautiful solar phenomena presented by this method of observation will best understand the enthusiasm and delight with which Lockyer continued his observations whenever the sun was visible. On the first day of observation—October 20, 1868—he had identified the C and F lines of hydrogen, and a yellow line near D, in the spectra of the prominences, and on November 5 he discovered that the prominences were but local upheavals of an envelope entirely surrounding the photosphere, to which he gave the name of the *chromosphere*, as being the region in which most of the variously coloured effects are seen during total eclipses of the sun. The peculiarities of the bright F line at once suggested to his fertile mind that the spectroscope might disclose the physical state, as well as the chemical composition of the chromo-

sphere and prominences, through the medium of laboratory experiments, and from this beginning the close association of the laboratory with the observatory became the dominant note in his life's work. His first experiments were made in collaboration with his friend Frankland, and it was shown that the widening of the F line at the base of the chromosphere was to be accounted for by an increase of pressure. These experiments further demonstrated that the yellow line of the chromosphere, which had been named  $D_3$ , was quite distinct from hydrogen, and the then unknown gas to which it was to be attributed was given the now well-known name of *helium*. Up to the year 1873, however, Lockyer's work was carried on almost entirely in his private observatory, and in the laboratory which he had established in his house at Hampstead. He not only continued his solar observations with conspicuous success, but also commenced his well-known "Researches on Spectrum Analysis in Connection with the Spectrum of the Sun," in which he developed experimental methods which afterwards became common practice.

On his transfer to South Kensington, with which his connection continued for forty years, the facilities at Lockyer's disposal for research were at first very meagre, but additions to equipment and staff were made from time to time, and in the later years the observatories and laboratories were well adapted for their special purposes. Lockyer's dream of becoming director of a permanent astrophysical observatory, comparable with those established by Governments in other countries, however, was never realised, and his work throughout was carried on in temporary buildings, and for the greater part of the time with modest grants in aid from year to year. In 1912, on the transfer of the Solar Physics Observatory to the control of the University of Cambridge, Lockyer, in spite of his weight of years, courageously set about the erection of a new observatory at Sidmouth, and continued his work on stellar spectra almost to the close of his life. It is a lamentable fact that much of his time and energy was almost continually taken up with a struggle to obtain adequate means to carry on his researches.

The contributions to astrophysics made by Lockyer during nearly sixty years of strenuous endeavour in its various fields of investigation form the subject-matter of more than 200 papers and memoirs, and it is only possible here to refer to some of the larger questions in which he was specially interested. His work, both in the laboratory and in the observatory, was largely guided by bold speculations, which he was usually careful to regard as working hypotheses, and from time to time the main points were brought together

in appropriate sequence in the form of books, among which are "The Chemistry of the Sun" (1887), "The Meteoritic Hypothesis" (1890), and "Inorganic Evolution" (1900). His observations and his views on their significance were thus made widely known, and the trend of his work could be the more readily followed. It was especially his desire to impress upon chemists and physicists the importance of the sun and stars as a means of investigating the behaviour of matter at high temperatures, and as possibly throwing light upon the nature of atoms and molecules.

Among the researches which have had the most potent influence, and have led to very definite advances, were those which dealt with the changes in the spectrum of the same element under different conditions of experiment. Lockyer was early led by his solar observations to a comparative study of the flame, arc, and spark spectra of some of the metallic elements, and one of his first successes was to show that some of the lines most characteristic of solar prominences, other than those of hydrogen and helium, were produced only under high temperature conditions, while some of those prominently affected in sun-spots were produced at a low temperature. With these and other observations as a basis he put forward, in 1873, his well-known dissociation hypothesis, which became the subject of much discussion. The hypothesis supposed that at successively higher temperatures the "molecular groupings" which existed at lower stages were broken up into finer forms of matter, or possibly into new elements, producing different spectral lines, and on this view it was shown that a multitude of solar observations which had seemed to be wholly inexplicable on the ground of previous laboratory experience became easy of explanation. Thus his view of the construction of the solar atmosphere was that if we could observe a section of it we should see it divided into a number of layers, each with its appropriate spectrum, and the spectrum would be simpler the nearer the layer was to the photosphere. The metallic elements, instead of existing as such in a reversing layer, were considered to be entirely broken up in the vicinity of the photosphere, and their germs distributed throughout the atmosphere, the molecular groupings becoming more complex as they became further removed from the source of heat. The theory doubtless calls for some re-statement in the light of modern views as to the structure of atoms and the origin of spectra, but it was a valuable guide to observation, and Lockyer anticipated the conclusion reached by St. John in recent years, that the complete absorption of any one element in the solar spectrum is the integration of lines special to various levels in the solar atmosphere. Lockyer himself seems to have been convinced that the ultimate products of dissociation were hydrogen and helium; but although this is so closely in accord with recent work on the structure of atomic nuclei, it does not seem probable that the phenomena studied by Lockyer were directly

related to those investigated by Rutherford. The writer well remembers numerous attempts to produce the lines of hydrogen or of helium by the passage of powerful condensed discharges between metallic electrodes, all of which, however, were unsuccessful.

Work on the varying spectra of the elements was vigorously resumed by Lockyer in connection with the interpretation of the photographs of the chromospheric spectrum which had been taken under his direction during the solar eclipses of 1893 and 1896, and of a series of photographs of stellar spectra which he had commenced at Kensington about 1890. Several elements were investigated over a long range of spectrum, and numerous additional lines were found to be intensified on passing from the arc to the spark spectrum, or which only appeared in the spark. These were designated "enhanced lines," and the work at once led to the definite assignment of origins to many chromospheric and stellar lines which had previously resisted explanation. But this was not all; the enhanced lines were shown to belong to a special class which were only fully developed at high temperatures, so that they gave valuable evidence of physical conditions in the atmospheres of the sun and stars as well as of their chemical constitutions. It would scarcely be too much to claim that this further work on enhanced lines introduced a new principle into astronomical spectroscopy, inasmuch as it justified the chemical identification of celestial spectra which could not be completely reproduced in the laboratory. The only assumption it was necessary to make was that the series of changes indicated in the flame, arc, and spark would be continued if still more powerful means of excitation were available, so that at sufficiently high temperatures the enhanced lines would be the sole survivors. In accordance with his views on dissociation, and for convenience of reference, the enhanced lines were designated "proto-metallic" lines, and attributed to "proto-metals," which were regarded as simplified forms of the vapours which yielded the arc lines.

Apart from any special views as to the cause of their appearance, however, the discovery of enhanced lines has proved to be of the first importance in astrophysical inquiries, and the tables of such lines which were compiled at South Kensington have been much utilised by astronomers throughout the world. Among other applications, as Lockyer was the first to show, the interpretation of the spectra of new stars in their early stages is almost entirely dependent upon a knowledge of the enhanced lines of iron, titanium, and other elements. In collaboration with his assistants, Lockyer showed later that enhanced lines were also developed under the action of strong electrical discharges in non-metallic elements, including silicon, carbon, sulphur, and nitrogen, and the lines observed in these experiments have also led to important celestial identifications. There can be little doubt that the continuation of

these investigations, as in Fowler's experiments on helium and oxygen, and Merton's further work on carbon, will yield results of high value in the interpretation of the spectra of stars at the highest stages of temperature, and possibly also of the nebulae.

Another of the chief subjects which attracted Lockyer during a great part of his life was the classification of stellar spectra, and the order of celestial evolution which might be inferred. He was at first mainly dependent upon stellar observations made by others, but he soon saw the necessity for first-hand data, and, following Pickering's remarkable success with the objective prism, he adopted this form of instrument in most of his work at Kensington, and afterwards at Sidmouth. He early adopted the suggestion made by Tait that in nebulae and comets the luminosity may be due to solids heated by impact, as well as to heated gas generated by the impacts, and about 1887 developed it into his "meteoritic hypothesis." The fundamental idea is that all self-luminous celestial bodies are composed either of swarms of meteorites, or of masses of meteoritic vapour produced by heat, the heat being developed by condensation due to gravity, and the vapour being finally condensed into a solid globe. The classification of stellar spectra which he based upon this theory has undergone modifications in detail, chiefly in the direction of subdivision and more complete definition of the criteria for the various stellar groups; but the essential idea has remained unchanged throughout. In common with other astronomers, Lockyer adopted the view that the spectroscopic differences between the various classes of stars are mainly due to differences of temperature, but, unlike most of them, he insisted that in place of a single line of evolution from hot (white) to cool (red) stars the progression must be from cool to hot stars and back again to cool stars. That is, in accordance with the theory of condensing swarms of meteorites or masses of gas, the classification made a distinction between stars of increasing temperature and those which are on the down-grade towards the extinction of luminosity.

Some of the earlier evidence for the separation of the stars on the two branches of the "temperature curve" which Lockyer pictured may be of doubtful validity, but the valuable photographic data accumulated later, in combination with laboratory researches, placed his classification on a much firmer basis. It was found, for example, that when stars at any given stage of temperature were brought together by reference to the relative intensities of enhanced and arc lines, they were definitely divisible into two groups, showing that the spectra were dependent in part upon physical conditions other than those imposed by temperature alone. This difference was attributed to differences in the state of condensation, one group being less condensed than the other, and therefore to be considered as being in an earlier stage of evolution, notwithstanding equality of temperature. The Harvard classification, which

has been adopted by most astronomers, is along one line of temperature only, and accordingly disregards this difference. It is clearly of great importance, however, that the difference should be taken into account in questions relating to stellar distribution and other matters connected with the structure of the sidereal universe, and it was a source of profound regret to Lockyer that greater attention was not given to it. In the case of the helium stars, however, Lockyer's classification has received substantial corroboration from a discussion by Herassimovitch of their radial velocities and absolute magnitudes, in which the catalogues of Lockyer were utilised. Among the results it was shown that the stars which Lockyer had located on the ascending branch of the temperature curve were brighter than those on the descending branch, and, assuming the average masses to be equal, it would follow that the former were of greater volume and lower density than the latter, in accordance with Lockyer's hypothesis.

The theory of stellar evolution put forward a few years ago by Prof. H. N. Russell resembles that of Lockyer in its main outlines, though based mainly on deductions as to the densities and absolute magnitudes of the stars. The criteria are thus somewhat different in the two cases, but there can be little doubt that in one form or other the recognition of an ascending, as well as of a descending, line of stellar temperatures will take an important place in the astronomy of the future.

The observation of total eclipses of the sun also occupied much of Lockyer's attention. He personally took part in nine eclipse expeditions, and was responsible for several others in which the observations were undertaken by his assistants. On several occasions, when H.M. ships were detailed to assist the expeditions, his exceptional organising ability enabled him effectively to utilise the services of officers and men so as to cover the widest possible range of observations. The outstanding feature of his work in this connection, however, was the introduction and use, first of a visual spectroscope without slit or collimator, and afterwards, when photographic methods could be adopted, of the prismatic camera. With instruments of this type he was able clearly to differentiate between the coronal and chromospheric radiations, and, besides detecting several new coronal lines, he obtained splendid records of the "flash" spectrum. He was thus able to determine the various heights to which the different vapours extended, and he identified a multitude of the bright lines with enhanced lines which he had so diligently investigated in the laboratory.

Lockyer would have been the last to claim that his work was wholly free from errors, but it was almost invariably of a stimulating character, and has played a leading part in the development of the science of astrophysics practically from its very beginning. Much of his work will have an enduring place in the history of the science to which he devoted his great gifts.

## Notes.

THE triennial prize competition for the best original contribution to the scientific advance or the technical progress of electricity, known as the Fondation George Montefiore Prize, and administered by a committee of the Association of Electrical Engineers from the Montefiore Technical Institute of Liège, which had lapsed during the war, is now to be revived, and the competition which would have been held in 1917 is now announced for 1921. The prize will amount to 20,000 francs. Competitors must send in their work by April 30, 1921, and all particulars can be obtained from the Secretary, Fondation George Montefiore, rue Saint-Gilles 31, Liège, Belgium. Contributions may be in English or French, and if successful are published in French in the *Bulletin de l'Association des Ingénieurs Electriciens sortis de l'Institut Technique Montefiore*.

NELA RESEARCH LABORATORY was organised in 1908 under the directorship of Dr. Edward P. Hyde as the physical laboratory of the National Electric Lamp Association. The name was changed to Nela Research Laboratory in 1913, when the National Electric Lamp Association became the National Lamp Works of the General Electric Co. For some years the laboratory was devoted exclusively to the development of those sciences on which the art of lighting has its foundation, but in 1914 the functions of the laboratory were extended by the addition of a small section of applied science which had an immediate practical objective. The section of applied science is now being largely extended as a separate laboratory of applied science under the immediate direction of Mr. M. Luckiesh, who becomes director of applied science, and a new building is being constructed to house this branch of the work. Dr. Ernest Fox Nichols, formerly president of Dartmouth College, and more recently professor of physics at Yale University, has accepted an invitation to assume the immediate direction of the laboratory of pure science under the title of director of pure science. The work of this laboratory, which will be continued in the present building, will be somewhat further extended under the new organisation. The laboratory of pure science and the laboratory of applied science will together constitute the Nela Research Laboratories, and will be co-ordinated under the general direction of Dr. Hyde, who becomes director of research.

THE Public Health Department of the Portsmouth Town Council, having evidently investigated thoroughly the scientific evidence submitted to it on the practicability of preventing the infection of venereal disease by the use of a disinfectant immediately after exposure to risk, has recently issued two descriptive leaflets giving the information necessary to carry out the disinfectant process effectually. We understand that about a dozen other Health Departments are taking, or about to take, similar measures. The leaflets, entitled "What Every Man should Know," embody in clear words the ascertained knowledge on this matter which has been acquired by observation and experiment, and contain a succinct

and useful summing-up of the multifarious evils of venereal disease. The council states that it has come to the conclusion that, in view of the terrible effects of this disease on national and family life, it is its bounden duty to make public a knowledge of the means by which this scourge can be prevented. These leaflets pay due regard to both the social and scientific aspects of the much-discussed subject of prompt self-disinfection after incurring the risk of infection. The Portsmouth Public Health Department deserves to be congratulated on its action in this seriously important matter of sanitation.

"EPIDEMIC stupors" are often referred to in early records (seventeenth and eighteenth centuries) as occurring in times of influenza prevalence, and in this country encephalitis lethargica made its appearance immediately before and during the influenza epidemic of 1918-19. It is of interest, therefore, to record the occurrence of the same disease in Karachi at the end of 1919 during an epidemic of influenza. A full description of the outbreak, consisting of seventeen cases, is given by Capt. Malone and Maitra in the *Indian Journal of Medical Research* (vol. vii., No. 3).

IN the *Journal of the Royal Society of Arts* (vol. lxxviii., No. 3533, August, 1920) we have a report of the Sir George Birdwood memorial lecture on "The Enduring Power of Hinduism" by Sir Valentine Chirol. Sir Valentine admits that he writes "not as a student, but merely as a layman." He has, however, been a diligent student, and his wide knowledge of contemporary politics and his experience of personal visits to many of the most important sites where archaeological investigation is being conducted by Sir John Marshall have enabled him to construct a graphic picture of the historical development of India in relation to Hinduism. This lecture is thus of considerable importance, and it is rendered more attractive by the picturesqueness of the author's style. He has not followed so completely the trend of modern studies as to grasp the fact that the survival of Hinduism, in spite of the rise of Buddhism and the cataclysm of the Mohammedan invasion, is due to its amorphous character, its eclecticism, and its capacity for adapting itself to novel conditions. But with these reservations the lecture gives an admirable account of the development of Hinduism.

THE character of the prehistoric culture of the people of the Malay Peninsula has as yet received inadequate attention, but much good work is being done in continuation of that summarised in "The Pagan Races" by Messrs. Skeat and Blagden. Thus we find in the *Journal of the Federated Malay States Museum* (vol. ix., part 1, January, 1920) an excellent account by Mr. I. H. N. Evans of the exploration of a rock shelter in the Batu Kurau Parish, Perak, with a description of the flint-weapon industry. In more recent times the influence of Islam has been predominant, but it has absorbed and assimilated much of the indigenous animistic beliefs. In this connection, in the same issue of the journal, Mr. R. O. Winstedt refers to some curious analogies between the local customs and those of the Brahmins of South

India, which point to the widespread influence of Hinduism in the peninsula prior to the establishment of Islam as the dominant faith.

MR. HENRY BALFOUR has reprinted his interesting presidential address from the Proceedings of the Somersetshire Archaeological and Natural History Society (vol. lxxv., 1919, pp. xxiii sqq.). He claims connection with Somersetshire on the ground that his late colleague, Sir E. B. Tylor, was a Somersetshire man by birth, and that Mr. H. St. G. Gray, now curator of the Taunton Museum, was his own assistant at Oxford. In his address Mr. Balfour crosses the county border to Rushmore and Cranborne Chase, on the border of Wilts and Dorset, the home of a great archaeologist and ethnologist, Col. Pitt Rivers. He closes his review of this notable man with the remark that "he has left his own record of diligent and broad-minded research, and the example afforded by his enthusiasm, characteristically tempered with caution, should have the effect both of stimulating and of restraining the work not only of this generation, but of generations to come."

THE Quarterly Summary for July issued by the Royal Botanic Society of London contains notes on some plants of interest in the gardens. The gigantic floating leaves of the *Victoria regia* water-lily are now 7 ft. in diameter, and, as each new leaf at this time of year exceeds its predecessor, it seems likely that they will reach the maximum of 8½ ft. by the end of August. As the sunlight becomes less the new leaves get smaller, until the plant dies down in October. One of the earliest accounts of this remarkable tropical American water-lily was that given by Lindley in the Proceedings of the society in 1839 (vol. i.). The plant was discovered by Robert Schomburgk, the traveller, on the River Bernice, in Guiana, and the detailed description which he sent home was sufficient to enable Lindley to recognise it as a distinct genus of water-lilies, which was, by permission, dedicated to the young Queen. Efforts to grow the plant at Kew were at first unsuccessful, but in 1849 some fifty plants were successfully raised from seed and distributed to various gardens. The fine specimen growing at Kew is one of the most popular attractions of the Royal Gardens. Another interesting plant in the same tank at the Botanic Gardens is the Lotus, *Nelumbium speciosum*, which has flowered profusely this year. Its large salver-shaped leaves and tall pink flowers rising from the water present a striking appearance. The plant was held in esteem by many ancient peoples in the East; in Egypt paintings of it decorate the temples, and it is still associated with temples in India, where the long, fleshy roots are eaten as well as the oval, nut-like seeds. The society has also been making experimental growths of the soya bean, with the view of ascertaining the most suitable variety for cultivation in this country.

AMONG the recently issued reports of the Canadian Arctic Expedition, 1913-18, are two on the Crustacea, which form part of vol. vii. An account of the marine Copepoda is given by Prof. Arthur Willey (in NO. 2652, VOL. IO5]

Part K) and of the Cladocera by Dr. Chancey Juday (in Part H). Cladocera have been examined previously from Greenland and from Alaska, but not from the intervening region of Arctic America. Seven fresh-water and two marine species are recorded, all of which are well known and have a wide geographical range. The fresh-water species belong to the genera *Daphnia* (*pulex* and *longispina*), *Bosmina*, *Eurycerus*, *Alona*, *Chydorus*, and *Polypheumus*, and the marine species to *Podon* and *Evadne* respectively. The common *Daphnia pulex* is also recorded from Polaris Bay, Greenland, about 82° N. latitude, where it was collected by the United States North Polar Expedition on August 1, 1872. This seems to be the most northerly record for any of the Cladocera. The material of this species from Polaris Bay consists of several hundred specimens, the great majority being females with ephippia. The specimens of *Daphnia pulex* in the various catches of the Canadian Expedition show that the winter eggs in the ephippia probably hatch during the latter half of June; that females bearing parthenogenetic or summer eggs appear about the first week in July; and that males and ephippial females make their appearance in late July and in August. The season is therefore a relatively short one.

A NOTEWORTHY contribution to the study of that fascinating group of insects, the parasitic aculeate Hymenoptera, is made by Prof. W. M. Wheeler in the Proceedings of the American Philosophical Society (vol. lviii., 1919, No. 1). Prof. Wheeler gives a comprehensive summary of the subject, citing and criticising a long array of literature, and discussing the evolution of the parasitic habit. He is disposed to regard the aculeate parasites as originating directly or indirectly from the insects which serve as their hosts. "The object of the parasite is to secure the provisions accumulated by the host for its own progeny. This involves a destruction of the egg or young larva of the host." But a higher specialisation is reached by the social insects which foster the host-brood so that their own young may be reared and fed.

ANATOMICAL details of some morphological importance are elucidated by Prof. G. H. Carpenter and Mr. F. J. S. Pollard in a recent paper (Proc. R. Irish Acad., B, vol. xxxiv., No. 4) on the presence of lateral spiracles in the larvæ of warble-flies (*Hypoderma*). Six pairs of these vestigial structures, suggesting a primitive peripneustic condition of the respiratory system, are recognisable in the ripe warble-maggot, connected with the outer lateral tracheæ by fine, thread-like, solidified air-tubes.

DR. E. H. PASCOR, of the Geological Survey of India, revived at a meeting of the Geological Society of London in March, 1919, in a new form the question of the relations of the Indus, the Brahmaputra, and the Ganges (Quart. Journ. Geol. Soc., vol. lxxv., p. 138, 1920). He traces back the now divided system to a river, the Indobrahm, the headwaters of which were in, or soon cut back into, the Brahmaputra region of Assam, while the mouth was in the Indus region of the Arabian Sea. This river

originated in the beginning of the Siwalik epoch, when the depression at the foot of the Himalayas ceased to be the scene of conflicting lagoon and terrestrial conditions, and became finally silted up. The great river was guided along this depression westward, while a contemporaneous river ran on the Tibetan side of the range, of which the alluvium remains from Pemakoi, north-east of the Bay of Bengal, to Gilgit, north of the great Indus bend. This river joined the Oxus, or reached the Arabian Sea by an independent course. It is urged that the Indobrahm captured the upper waters of the northern river by cutting back into them along its tributaries at successive points in the recesses of the range from which the Indus now runs south-westward. The speakers in the discussion of the paper, including Mr. R. D. Oldham, approved the main geographical contentions, but laid more stress than the author on earth-movements in determining the diversions and the courses of the tributaries through the hills.

SIMULTANEOUSLY with the investigations of Dr. Pascoe, Dr. G. E. Pilgrim, of the Geological Survey of India, put forward his suggestion of a great Pliocene river running on the south side of the Himalayas from Assam to the Indus course. Dr. Pilgrim's paper and maps (Journ. Asiatic Soc. of Bengal, vol. xv., p. 81, 1919) appeared, indeed, before the printing of Dr. Pascoe's work, and, as that author points out, the argument based on the direction from which the tributaries meet their primaries in the mountain-belt originated with Dr. Pilgrim. The two papers should be read together, and they form a great addition to our conceptions of the past geography of India. Dr. Pilgrim gives prominence to earth-movements as promoting the dislocation of the Assam-Punjab or Siwalik River. His maps of Western Asia in Eocene, Miocene, and Pliocene times are highly useful.

THE "Fossils from the Miura Peninsula and its Immediate North" form the subject of an important memoir by Prof. M. Yokoyama (Journ. Coll. Sci., Tokyo Imp. Univ., vol. xxxix., art. 6, pp. 193, 20 pls.). The geological formations of the peninsula are in part undoubtedly Pliocene, and in part either Pliocene or Pleistocene; those of the plain are divisible into an upper, sub-aerial, and a lower marine series several hundred feet in thickness. The sub-aerial series is made up of a brown loam, an altered volcanic ash, wholly devoid of stratification and organic remains. The marine series, which the author names the Musashino formation, is divisible into an upper and a lower series. In the upper, remains of *Elephas namadicus*, Falc. and Caut., are not uncommon, and are perhaps the most important of the fossil contents. The Lower Musashino beds are provisionally divided by the author into six zones. From the whole series, 232 species of Mollusca and 6 of Brachiopoda are recorded, 91 of the former and 2 of the latter being described as new; the whole are well illustrated, but the nomenclature, as, alas! too generally the case in papers of this class, lags behind the times. The number of forms not known to be living is 88, or about

37 per cent. of the whole fauna, and 7 species have not yet been found in Japanese waters. The author therefore classes these Musashino beds as Pliocene of about the same age as the English Red Crag of Newbourne = Austelien of the Netherlands.

THE *Geologische Reichsanstalt* of Vienna, which was able in Imperial times to spread the influence of a great school of geology over Polish, Transylvanian, and Dalmatian lands, has been forced to adopt, from the opening of 1920, the restricted title of *Geologische Staatsanstalt*. Dr. Emil Tietze, the director, retires after long and honourable service, recognising in the "geschickte Diplomatie des Königs Eduard von England" the prime cause of the restriction of his official field. The *Verhandlungen* for 1919 indicate many changes on the staff, some workers whose names are familiar having become aliens through territorial readjustments. We must hope that their common science will maintain the federal spirit shown in the last publications of the *Reichsanstalt*. Many of the papers deal with mountain structure. Dr. F. Heritsch claims that the discovery of tabulate corals in the supposed Mesozoic mantle of the Hohe Tauern disposes of the idea that the mass has been imported by overfolding, and we may be prepared for continued criticism in Austria of the theory of recumbent folds in general. Dr. O. Ampferer, who becomes one of the *Chefgeologen* and also a *Bergrat*, contributes a paper in his lucid and systematic manner on the very considerable influence that deep notches (*Kerben*) cut by erosion may have on tectonic features when a region comes under processes of crust-folding.

CHEMICAL as well as geological workers will welcome a new and enlarged edition of W. F. Hillebrand's "Analysis of Silicate and Carbonate Rocks" (Bull. 700, U.S. Geological Survey, 1919). The accurate methods described are obviously of service in the analysis of potassium silicates and refractories for commercial use, as well as in the refined discrimination of types of natural rock. The importance of the estimation of small quantities of unusual or commonly overlooked constituents is here pointed out. At the same time this may be quite unnecessary in many cases of ordinary practice, and for these a system of "condensed analysis" is charitably described in the concluding pages.

AN interesting example of the applications of zonal palæontology is afforded by Messrs. F. L. Kitchin and J. Pringle, who show (*Geol. Magazine*, vol. lviii., pp. 4, 52, and 100, 1920) that a mass of Gault and Cenomanian strata at Shenley, near Leighton Buzzard, 250 yards long and 150 yards wide, has been inverted on Lower Greensand. The fossils provide the clue, being in inverse succession to those in the undisturbed beds of the neighbourhood. As a boulder pushed by ice, this presents some parallel with the famous block described by Mr. R. G. Carruthers in the heart of Caithness (*NATURE*, vol. lxxxix., p. 229), in which a quarry has been opened 160 yards in length.



THE occurrence of barytes in the upper parts of lodes containing metallic sulphides is probably well recognised, and postulates an infiltration of barium chloride upwards during the formation of the lode or downwards to meet the sulphates that are in solution. Mr. H. W. Greenwood suggests (*Proc. Liverpool Geol. Soc.*, vol. xii., part 4, p. 355, 1920) that the barytes which is common in the English Triassic strata, and mainly found in the upper beds, was derived from overlying Jurassic strata. The source of an exceptional quantity of barium in the Jurassic seas is not indicated. Might it not have been brought into the Triassic pan-deposits from the denudation of our Armorican lode-formations?

IN a general "Review of the Reptilian Fauna of the Karroo System" (*Trans. Geol. Soc. S. Africa*, vol. xxii., p. 13, 1920) Mr. S. H. Haughton concludes that the preservation of complete skeletons of Pareiasaurians in the beds south of Prince Albert Road station was determined by a rapid deposition of fine mud or silt. In the discussion on this paper (*Proc. ibid.*, p. xli.) Dr. van Hoepen supported, by his personal observations on the skeletons of various genera, the view of entombment in swampy lakes rather than, as Mr. Watson had suggested, in wind-borne sand. Dr. du Toit stated that he was unwilling to return to the old supposition of a general Karroo lake in Lower Beaufort times, but he pictured a surface "that became periodically inundated and, at certain stages, semi-arid in climate."

THE present summer has so far experienced some disturbing weather anomalies, the abnormal features being chiefly the persistent low temperatures and the frequent heavy rains. Some improvement has been generally experienced during the present month owing to the greater prevalence of anticyclonic conditions. A disturbance, however, traversed the north of Ireland and the southern portion of Scotland on the night of August 17 and the early part of August 18. The storm area followed a track fairly due east, and was preceded and accompanied by a heavy downpour of rain which occasioned considerable damage in Edinburgh and the surrounding neighbourhood. The rainfall at Edinburgh for the twenty-four hours to Wednesday morning was 3.1 in., and in twelve hours the fall amounted to 2 in. At Leith the fall in twenty-four hours was 2.84 in., and at Renfrew 2.80 in. A subsidiary disturbance occasioned heavy rain in the south of England, and at Falmouth the fall was 2.21 in. between 8 a.m. and 7 p.m. on August 18. Very cool northerly winds spread over the country in the rear of these disturbances. On the morning of August 20 frost occurred on the ground in the open in Scotland and in parts of England, whilst in places the thermometer in the screen fell to 36°. At Greenwich the exposed thermometer registered 33° and in the shade 41°, which was only 3° above the lowest figure reached in August since 1841, 38° being recorded in 1864, when the exposed thermometer fell to 27°. At Kew it was the coldest August night since 1891, and at Falmouth it was as cold as any time in August during the last half-century.

AMONG recent pamphlets issued officially by the Meteorological Office under the heading of Professional Notes is one by Mr. J. S. Dines entitled "Methods of Computation for Pilot-balloon Ascents." Without claiming to be exhaustive, this gives some account of, at any rate, the better-known methods of determining wind velocities at different heights. Part i. deals with the most practised single-theodolite ascents, and nine methods are described, including those in general use by the military Meteorological Services of France, Italy, and the United States, partly graphical and partly depending upon a special slide-rule. The ideal method for open-air work discards the graphical method so far as possible. Part ii., dealing with double-theodolite ascents, gives six methods of dealing with these, including, as does part i., the Meteorological Office method, which depends entirely on the slide-rule. Part iii., on balloon-tail, gives two graphical methods besides the Meteorological Office slide-rule plan. Perhaps more interesting than any of these is the appendix dealing with various methods of obtaining velocities at heights when cloud-sheets prevent the observation of pilot-balloons. The smoke from anti-aircraft shells set to explode at a given height can be observed through a comparatively small break in the cloud, and even when the cloud-sheet is quite unbroken the position of bomb-bursts can be determined by sound-ranging from the ground or by observation from an aeroplane.

IT was scarcely likely that proposals so far-reaching in effect and importance as those put forward by the Egyptian Ministry of Public Works for the extensive development of the cultivable area of the valley of the Nile by the construction of a dam and other irrigation works should escape a large measure of hostile criticism, and we have on several occasions alluded to the attacks made by Sir William Willcocks on the validity and trustworthiness of the data on which the scheme is founded. These attacks, it will be recalled, led to the appointment of a Special International Commission of Inquiry, which has had the projects under review. We have now received a copy of a brochure issued by an independent Commission of Native Egyptian Engineers, who take up an attitude of strong and uncompromising opposition to the official proposals on the grounds that there are obvious inconsistencies in the fundamental calculations, and an evident tendency on the part of the Technical Adviser to the Egyptian Government to "adapt" his data to the requirements of the case. The objectors state that they fear that any attempt to cut off or decrease the supply of water and silt to Egypt from the Blue Nile will be fraught with disastrous consequences, and they set out their arguments in a series of sixteen criticisms of the official scheme. An addendum by Dr. Mahgoub Sabitt, professor of medical jurisprudence and toxicology at the Egyptian University, advances reasons for considering the construction of the proposed dam likely to prove detrimental to public health. A protest is also entered against the alleged secrecy in which the proposals were prepared and formulated, and finally a call is made for a mixed committee of native and foreign

engineers, "free from all bias," to investigate the matter thoroughly on account of its vital importance to the welfare of the whole country.

THE paper by W. L. Cheney on the measurement of hysteresis values when using high magnetising forces, which has just been published by the U.S. Bureau of Standards (Paper No. 383), will be of interest to all engaged in magnetic research. When employing ordinary methods it is extremely difficult to get the accurate values of the remanent induction and the coercive force owing to what has been called magnetic viscosity. This probably also slightly affects the author's results. His method is a modification of the isthmus method, and consists essentially of a du Bois electromagnet with flat pole-pieces separated by an air-gap and pierced coaxially so that a rod may be inserted. The magnetic force and the induction are measured by suitable coaxial test coils. Magnetic forces up to 2500 gauss were employed. Quenching eutectoid steel (0.85 per cent. carbon) in oil lowered the remanent induction, but considerably increased the coercive force. Experiments were made on the K.S. magnet steel prepared by Prof. Honda, and the high coercive force of 200 gauss was obtained when the specimen had been magnetised with 800 gauss.

AN uncommon piece of work is described in *Engineering* for August 13 in the form of a long wooden jib for a derrick crane designed and constructed for the Admiralty during the war by the Imber Court Engineering Works, Thames Ditton, Surrey. The crane, with a 50-ft. post, had to be capable of raising a 3-ton load up to a platform 100 ft. high. The jib was 135 ft. long from the centre of the bottom pin to the centre of the rope-wheel, and the wooden construction adopted resulted in a jib being produced of one-third the weight and having a higher factor of safety than steel would have given. Including the rope-wheel and end casings, the jib complete weighed only 2 tons 13 cwt. The jib was built up of four corner-posts, each post being made of nine laminations of Oregon pine glued together with waterproof glue. The jib was divided into panels by struts, also of Oregon pine, and each panel had diagonal bracing, both longitudinal and transverse; these bracings were composed of stranded piano-wire. The struts were fixed to the corner-posts by welded steel clamping boxes, to which the diagonal braces were also connected by means of bolts on which the wire was wound. The bolt-heads were formed with teeth, with which two spring pawls engaged, so that turning the bolt tightened the wires and slacking back was prevented by the pawls.

THE concluding volume—the sixth—of the Scientific Papers of the late Lord Rayleigh is to be published by the Cambridge University Press in the spring of next year. It will range over the period 1911–20. Among the other forthcoming publications of the Cambridge University Press is "The Spectrum of Nova Geminorum II," by F. J. M. Stratton. It will constitute vol. iv., part i., of the *Annals of the Solar Physics Observatory*, and is promised for the end of the present year.

## Our Astronomical Column.

DISCOVERY OF A NOVA IN CYGNUS.—Mr. W. F. Denning, of Bristol, writes that on the evening of August 20 he observed a star previously unknown to him in the northern region of Cygnus. He has made it a practice during the last few years of carefully searching for these objects while he has been watching for meteors. The object when discerned on August 20 was of about  $3\frac{1}{2}$  magnitude, and its rough position was in R.A. 19h. 56m. and declination  $53\frac{1}{2}^{\circ}$  N. It formed a little triangle with the stars  $\psi$  and  $d$  ( $z\theta$ ) Cygni. On referring to star-charts, etc., Mr. Denning quite failed to identify the object in question, and therefore concluded it to be a new star.

The position of the nova in the Milky Way is in accordance with past experience, for nearly all past novæ have been in the Milky Way or on its borders.

Mr. Denning saw the present object again on August 21 in the openings between swiftly passing clouds, and it appeared of about the same brightness as on the previous night, but only hurried glimpses were obtainable.

On August 22 the brightness was estimated = 2.8 mag., and on August 23, 2.2 mag., so that its light is increasing.

PARALLAX OF THE B-TYPE STAR BOSS 1517.—Mr. J. Voûte recently announced a large parallax and proper motion for this star. Mr. A. J. Roy showed, however, that the true proper motion in R.A. was only one-tenth of Mr. Voûte's value, being  $-0.023''$ ; that in declination is  $+0.129''$ . Mr. Voûte has recomputed the parallax with this value, and finds  $0.048''$ , which is in good accord with Kapteyn's hypothetical value  $0.033''$ .

The star is one of the nearest of the B stars, being at about the same distance as Achernar. Its chief interest lies in its surprisingly low absolute magnitude for a B-type star, its apparent visual magnitude being 5.9. According to Mr. R. E. Wilson, of the D. O. Mills Observatory, the radial velocity is  $+102$  km./sec., or  $+83$  corrected for the sun's motion. The position for 1910 is R.A. 6h. om. 59.436s., south decl.  $32^{\circ} 10' 10.91''$ .

PUBLICATIONS OF THE ASTRONOMICAL LABORATORY AT GRONINGEN, No. 29.—This is a further instalment of Prof. J. C. Kapteyn's valuable researches on the stellar system. He summarises the large amount of new material that has become available since he first took up the subject, and shows that the time is appropriate for a fresh investigation of the secular parallaxes of stars of different magnitudes and spectral classes. The secular parallax is defined as the angle subtended at the star by the unforeshortened annual motion of the sun. Assuming its speed to be  $19\frac{1}{2}$  km./sec., then annual parallax = sec. par.  $\times 0.243$ . The following values are found for the variation of parallax with galactic latitude: From latitude  $90^{\circ}$  to  $40^{\circ}$ , parallax =  $1.17$  of mean; from  $40^{\circ}$  to  $20^{\circ}$ ,  $0.96$  of mean; and from  $20^{\circ}$  to  $0^{\circ}$ ,  $0.87$  of mean.

Many investigators have found discordant values of the declination of the solar apex as derived from stars of different magnitudes. Prof. Kapteyn is inclined to attribute this to imperfect elimination of magnitude equation in declination from the catalogues employed, since he makes the discordance very small.

Prof. Kapteyn emphasises the importance of separating stars of different spectral type in these investigations. In view of the great range of absolute magnitude according to type, he says that the grouping of all types is like making a single statistical investigation of the

whole animal kingdom, from the elephant to the flea, instead of dividing them into species.

The following table gives the mean secular parallaxes for different magnitudes and spectral types, the former being visual on the Harvard scale :

Mag.	B stars	A stars	F stars	G stars	K stars	M stars
1.0	0.138	0.253	0.591	0.627	0.362	0.172
2.0	0.0921	0.170	0.392	0.422	0.241	0.116
3.0	0.0622	0.115	0.267	0.285	0.163	0.0786
4.0	0.0422	0.0780	0.182	0.192	0.110	0.0537
5.0	0.0285	0.0526	0.123	0.129	0.0749	0.0361
6.0	0.0192	0.0355	0.0827	0.0876	0.0506	0.0244
7.0	0.0130	0.0240	0.0560	0.0599	0.0342	0.0163
8.0	0.0087	0.0161	0.0379	0.0403	0.0231	0.0108
9.0	0.0059	0.0109	0.0254	0.0271	0.0156	0.0073

The small values near the end of the final column show that these distant M stars are giants nearly equivalent to the B stars in absolute magnitude. On the other hand, the M stars mentioned on page vii. as being 17½ magnitudes fainter than the B stars are dwarfs.

## Universities, Research, and Brain Waste

THIS is the subject of a presidential address by Prof. J. C. Fields to the Royal Canadian Institute, Toronto, on November 8, 1919. It contains a review of the relations which must subsist between universities and research and between research and the progress of the world in civilisation, and it opens up so many aspects of these questions which are debatable that for that very reason it ought to be read extensively. Though, on the whole, Prof. Fields's views are consolatory to us in the Mother Country, they also show how much has yet to be done in England, as in other countries, to prevent or reduce the waste of potential brain power in the generations to come. Conditions are now greatly improved whereby the educational net is able to select out of the masses of population the individuals whose mental qualities deserve and, in the interest of the community, require due cultivation, but for the full benefit we must wait a generation or two.

It is premature to make comparisons between the different races and nations in respect to intellectual qualities, but it seems to be incontestable that the Germans have for generations been distinguished by their respect for learning and intellectual achievement, and this is illustrated by the way in which during the war their highly trained men were preserved from too much risk. The Allies, on the other hand, took no special care to protect and preserve such men as Moseley, who was allowed to sacrifice his life in Gallipoli. Such waste is, as Prof. Fields says, a tragedy of the first order. But there is similar waste going on every day in the neglect to give every boy of promise an open road to the university and the right kind of teaching when he gets there.

It is a question open to discussion whether the opportunity to do research lies only in a university career. The successive great discoverers at the Royal Institution in London, from Davy and Faraday onwards, and men like Joule, who was a brewer, and others unconnected with educational institutions, rise at once to mind. But it certainly is true that in the universities the example, the methods, and the spirit of research should be found associated with the teaching in every faculty and in every department.

Prof. Fields was severe on the constitution and government of the American universities, but while it appears to be true that most of the professors there

are overworked and that the standard of attainment among the graduates is inferior to those of the universities of Europe, the work that has been done at Johns Hopkins, Baltimore, and Harvard Universities must not be forgotten. Probably the next generation on both sides of the Atlantic will profit by the interchange of visits by representatives of the higher educational institutions and by the opportunities for exchange of students, both graduate and undergraduate. It is probable also that there is still great ignorance, especially among the masses of the people in all countries, of the fact that the most potent factor in bringing the world out of barbarism to its present better condition of life has been *science*. "Is it not," Prof. Fields says, "of the first importance that every boy and girl should be made aware of this fact?" With that object in view modern history requires to be taught by teachers better qualified than in the past.

## The Sun as a Weather Prophet.

SOME forty years ago Prof. Langley, while engaged on his early bolometric work on the sun, grasped the principle that, inasmuch as solar radiation is the governing factor in world meteorology, it should ultimately become possible to forecast weather changes, so soon as sufficient information had been obtained in regard to the mechanism of the radiation effect, by continuous observation of the intensity of radiation. Gradual improvement in instruments and methods has enabled his successors to state positively that the so-called "solar constant" is subject to variations of long and short period, and of late years determined attempts have been made, chiefly by the Smithsonian observers, to trace the meteorological changes that may fairly be attributed to these variations. It is clear that there are, from time to time, disturbing factors of apparently terrestrial origin—for instance, the eruption of Mount Katmai, in Alaska, in 1912, brought a promising summer to an abrupt and chilly close in mid-July; but it is becoming more and more probable that the Smithsonian investigation is on the right lines, and will give definite aid to forecasting, at any rate in tropical and sub-tropical regions.

Publication No. 2544 of the Smithsonian Miscellaneous Collections (vol. lxxi., No. 3) is devoted to a full statement of the case as regards Argentina, Chile, and Brazil in connection with regular observations of solar radiation at the new solar observatory at Calama, in Chile. Clear evidence is provided by the temperatures found at Buenos Aires that high values of solar radiation are followed by maximum values of temperature at an interval of nearly eleven days. The interval is not the same for lower maxima of radiation, and the amount of lag appears to be connected with the latitude of outbreaks on the sun, but more remains to be explained than the solar rotation will cover. The lag is also not the same for all stations considered. Twenty such were chosen in the countries mentioned, and differences are noted in the intensities as well as in the intervals, and also between the effect of longer and shorter waves. The observations do not cover every day, so that the correlation is probably not so good as it would be if complete data could be provided. The change due to a variation of 1 per cent. in the solar radiation appears to range between 0.2° C. and 0.8° C. in the tropics; in the temperate zones the effect, though less direct, is greater, even exceeding 2° C. at some stations.

Having thus obtained satisfactory evidence that, with the exception of the diurnal and annual varia-

tions due to the rotation and revolution of the earth, all weather changes are caused chiefly by variation of solar radiation, the next step was clearly to bring it into practice for forecasting. This has now been done for Central Argentina with promising results, but the ideal of daily measures of solar radiation is not yet attainable, because more stations are required. Even at Calama, which is nearly cloudless, good observations are not always possible on account of haze.

The concluding paragraph of the report states: "The ideal arrangement for this solar work would be to carry it on in co-operation with the Smithsonian Astrophysical Observatory. If the work at several widely separated observatories could be directed by one capable institution, so that the methods could be uniform and the results comparable, and then if it could be collected and weighted at the central office before cabling to the various weather surfaces of the world, probably a complete and reliable day-to-day record of the solar changes could be obtained which would be of the greatest value to practical meteorology. If the Smithsonian Institution is unable or unwilling to do this work, then it is hoped that observatories will be established by several countries and some direct method of exchange instituted." W. W. B.

### Cotton Industry Research.

THE British Cotton Industry Research Association, which was incorporated in June, 1919, has just issued its first annual report. The association is comprised of 1408 individual members representative of all branches of the cotton industry, and its council includes not only members of the great firms engaged in the industry, but also those representing the various associations of operatives.

The association has appointed as its director of research Dr. A. W. Crossley, who took up his duties last Easter. A large mansion some five miles from the Manchester Exchange, standing in 13½ acres of ground, has been bought for the purposes of the association, to which it is proposed to add extensive buildings, for which it is intended to raise a special fund of 250,000*l.*, to accommodate the various departments of chemistry, physics, colloids, botany, and technology, and to appoint as heads of these departments highly qualified men of science. In order to bring to the notice of the members all available information of work done in the past, Dr. J. C. Withers, of London, has been appointed to direct the abstracting and indexing of scientific and technical matters in connection with the Records Bureau, and the council, in co-operation with the Textile Institute, has arranged for the publication of abstracts from English and foreign papers dealing with matters relevant to the textile industries. It is proposed to establish an extensive library of standard scientific works of reference and of scientific and technical journals. A scheme of education falls within the scope of the association, and already certain Oldham and other mills have arranged to provide scholarships in some branch of science for students who are desirous of becoming members of the staff of the association. The plan of research is intended to cover the qualities of the cotton cuticle and the influence thereon of different reagents employed in mercerisation, bleaching, etc.; the effect of reagents on the strength and elasticity of the fibre, yarn, and fabric; the character of the change due to mercerisation; the nature of tendering in the various types of fibre; the variation in the physical properties of sized

yarn with change in the colloid properties of the material used; the action of the dyeing process, with critical regard to the established purity of materials; the nature of the dye solution, and the chemical change in the latter during the dyeing process; finally, the devising of methods for obtaining exact information as to the length of staple, the behaviour of fibres under stress and strain, the degree of variation in counts and in the diameter of yarn, relative twist, the degree of resistance of yarn to weaving friction, etc. Arrangements have been made for co-operation with the Empire Cotton-Growing Committee (Board of Trade), and in co-operation therewith the Research Association has made a grant of 250*l.* for 1919-20 to a student of botany at Oxford in aid of botanical research in the subject of cotton-growing. The joint committee has likewise arranged for two other students to take up like work in the ensuing session. The income of the association is derived from a call upon the members to the extent of about 9000*l.* and a Government grant from the Department of Scientific and Industrial Research of 7000*l.* The Department has shown the greatest interest and given all possible help in the furtherance of the objects of the British Cotton Industry Research Association.

### Sugar Cultivation in India.

THE existing world-shortage of sugar lends special interest to all experimental work directed towards any advance in the quantity and quality of this essential crop. Sugar-growing and its improvement are attracting an increasing amount of attention in India, the area under sugar-cane having risen from 2,184,801 acres in 1909-10 to 2,808,204 acres in 1917-18, while in addition the date-palm and palmyrapalm occupied 184,412 acres in the latter period ("Agric. Statistics for India," 1917-18, vol. i.). More than half the sugar-cane is grown in the United Provinces, chiefly Agra, and the Punjab accounts for about one-fifth. Palm-sugar, on the other hand, is chiefly associated with Madras, Bengal, and Upper Burma, little being produced elsewhere. The output of sugar for 1918-19 was 2,337,000 tons (Report on Progress of Agriculture in India for 1918-19), but, as this was insufficient to meet home requirements, a large quantity had to be imported. Before the war India was able to produce a surplus of sugar for export, but as this can no longer be done the Government is investigating the possibility of reorganising and developing the sugar industry of the country, and a strong committee has been appointed to determine future policy in this direction. Dr. Barber, who has worked much on the problem, considers that a case has been made out for the foundation of an Imperial Sugar Bureau, of which the "whole duty will be to collect and collate the results obtained in various directions, and thus be in a position to assist the isolated efforts in different parts of the country with sound advice, based on experience gained by a general survey of the work done in India now and in the past and that accomplished in other countries" (Annual Report of the Board of Scientific Advice for India, 1918-19).

Throughout India much work is being done on the improvement of the sugar-cane and on the selection and breeding of varieties suitable for different conditions and localities. At the cane-breeding station at Coimbatore, under the direction of Dr. Barber, a large number of hybrids have been raised and are under observation, some of the seedlings proving very resistant to red rot and smut, two of the most serious

diseases of sugar-cane. As a result of this work it has been possible to pass out a number of seedlings for further testing on a large scale in different places. The trial of new varieties is also carried out in Madras and the United Provinces, for the old ones which have hitherto been grown are rapidly losing favour with the cultivators, and it is necessary to find new and improved varieties to replace them. When imported canes are used it is necessary constantly to renew the stock from the country of origin. Soil and climate have a marked effect on the canes, and varieties that are markedly superior in one area often deteriorate rapidly in quality if transferred elsewhere, and, consequently, experience gained from experimental work in one part of the cane-growing tract is often of doubtful value for another area. This fact makes a strong argument for an increase in the number of sugar research stations in order that the most suitable stocks may be determined for the various localities.

Newly broken up land does not give very satisfactory results, but it should be left for at least a year before planting. If a proper rotation of crops is used, an increase of as much as 5 tons of cane per acre can be obtained. Manurial experiments in Assam have shown that the use of phosphatic fertilisers gives an average increase of 2-3 tons per acre, and in Pusa it is found that rape-cake, farmyard manure, and nitrate of soda can all be utilised with profit. In Madras it is estimated that careful manuring will raise the crop from 25 to 30 tons per acre, which is probably the limit for that particular climate.

Apart from the actual selection and cultivation, special attention is being devoted to the handling of the sugar-cane in order to avoid damage and deterioration. Canes are often stored by windrowing, and tests made over a period of several months show that this does not lead to any appreciable decrease in the quality or amount of sugar obtainable from equal weights of the original and the windrowed cane, but that after a certain time has elapsed deterioration sets in. Experiments suggest that this deterioration is not dependent upon the length of storage, but that the falling off of the quality is probably due to a seasonal rather than a biological factor.

Special methods have been devised at Coimbatore (*Agric. Journ.*, India, xv., part ii.) for the transport of cane for short distances and overseas. In the latter case it is advised that the pieces of cane be pickled in Bordeaux mixture for a short time in order to avoid the introduction of disease from one locality to another. Charcoal-dust, teak sawdust, and wood-shavings all make satisfactory packing materials.

Attention is now being directed to the use of the palmyra-palm as a sugar producer (*Agric. Journ.*, India, xv., part i.). Toddy is made in Bihar from the sweet juice of this palm, but as less than 10 per cent. of the trees are tapped it is probable that the manufacture of sugar would pay. The process of tapping needs special care to obtain the best results. The tins of the flowering stalks are cut off after the male and female inflorescences have been sauced or otherwise injured to irritate them into producing a good flow of sweet sap. The insides of the collecting pots are coated with lime to preserve the juice and prevent fermentation. The crude sugar obtained from this juice contains lime, which is removed by passing a current of carbon dioxide through the sugar solution until all the lime is precipitated, and a cheap white sugar can then be prepared. It is suggested that as the production of sugar from the wild date-palm has so far been satisfactory, it would be well worth while to give the palmyra-palm industry a fair trial.

W. E. BRENCHLEY.

## University and Educational Intelligence.

LIVERPOOL.—The title of emeritus professor of engineering has been conferred upon Prof. H. S. Hele-Shaw.

MR. R. S. GLENNIE, of the Battersea Polytechnic, has been appointed chief lecturer in pharmacutics at the Royal Technical College, Glasgow.

The Treasury has made to the University College at Swansea a grant of 5000*l.* in a lump sum towards expenses, and also an annual grant of another 5000*l.*

REFERENCE has already been made in these columns to the establishment of a new Department of Aeronautics at the Imperial College at South Kensington. This addition to the work of the college was initiated by the generous action of Sir Basil Zaharoff, who endowed the University of London chair of aviation known as the Zaharoff chair, tenable at the college, to which Sir Richard Glazebrook was appointed with the duty of directing the new department. A comprehensive scheme of instruction and training, mainly post-graduate in character, has been arranged for next session, beginning in October, including special sections in aeronautical engineering, meteorology, and navigation, and with the valuable co-operation of the Air Ministry the services of a distinguished staff of experts have been engaged. Apart from the director with his great experience of this work at the National Physical Laboratory, Sir Napier Shaw will be professor of meteorology and Mr. Leonard Baird professor of aerodynamics; Mr. A. J. Sutton Pippard will deal with the structure and strength of aircraft, and Mr. A. T. Evans with aircraft engines. Courses of lectures will also be given dealing respectively with airships and with navigation, while arrangements are in hand for special instruction in air-cooled engines, high-compression engines, dopes, instruments, wireless telegraphy, and similar subjects. Subject to certain necessary restrictions, it has also been arranged that students of the department will carry out part of their practical training in one or other of the Government establishments concerned with aeronautics.

The Bureau of Education at Washington has just issued a Bulletin (No. 11) giving statistics relating to school systems in the United States for the year 1917-18. The bulletin is concerned with elementary and secondary education only, and is an elaborate document covering 153 pages octavo, accompanied by 62 tables of statistics and by 49 maps and diagrams illustrative of the various aspects and conditions of primary and higher education, other than university and professional, in the several States. From the figures set forth it would appear that the total population of the States has increased from 38.2 millions in 1870 to 105.4 millions in 1918, and that the children of school age between five and eighteen have increased from 12 to 27.2 millions, and the school enrolment from nearly 7 to nearly 21 millions; whilst the pupils in the high schools, who numbered 80,000 in 1871, were about 1,700,000 in 1918. The number of teachers employed was 650,700, being 105,104 men and 545,515 women, whose average salary in 1918 was 635 dollars, as compared with 189 dollars in 1870. The percentage of scholars enrolled of school age between five and eighteen was 75 in 1918 and 67 in 1870, largely due to better teaching and supervision, a more suitable course of study, transportation of pupils, and improved economic and general condi-

tions. The total value of school buildings, sites, and equipment is stated to be of the vast total of nearly 2,000,000,000 dollars. The school dollar income is spent as follows: 3.3 cents on general control, 58.2 on instruction, 15.5 on new buildings and grounds, and 23 miscellaneous. The average length of the school year is stated to be 160 days, though the cities usually provide a school term of nine months. More than 6,000,000 children attend school, on an average, less than five months in each year. Great diversity exists throughout the States, due to climatic conditions, the scattered nature of much of the population, racial differences, and varying educational legislation, which largely accounts for the striking differences which prevail. The bulletin is well worthy the close attention of educational authorities in this country.

## Societies and Academies.

LONDON.

**Physical Society**, June 25.—Sir W. H. Bragg, president, in the chair.—Dr. J. H. Vincent: The origin of the elements. The atomic weights are regarded as the weighted mean values of the atomic weights of the isotopes of the elements; but it is assumed that, as a rule, the atomic weight is near that of some one isotope. Figures and tables are drawn up showing how this accounts for the values of a large number of atomic weights, if one also assumes that the weights and positions in the periodic table of any isotope are conditioned by laws similar to those holding in the recognised radio-active families. The elements are all supposed to be derived from parent elements by processes known to occur in actively radiating families, but their radio-activity is not, in general, detectable by the usual means owing to the velocity of expulsion of the particles being low. The possibility of the reversibility of some radio-active processes is regarded favourably. The various difficulties in connection with the views advocated are discussed, and some suggestions for experiments made. Finally, the theory is used to explain the so-called laws of the atomic weights of elements of low atomic weight, and the shape of the curve obtained when the atomic weights are plotted against Moseley's numbers.—W. H. Wilson and Miss T. D. Epps: The construction of thermo-couples by electro-deposition. The method, which was devised to overcome the difficulty of making satisfactory soldered joints between the elements of thermopiles having a large number of closely packed junctions, consists in using a continuous wire of one of the elements and coating those parts of it which have to form the other element with an electrolytic deposit of another metal. If the conductivity of the latter is considerably greater than that of the former, and a fairly thick sheath is deposited, a thermo-couple is produced which is not appreciably impaired in efficiency by the short-circuiting effect of the core. Constantan wires coated with either copper or silver sheaths were found to be suitable for most purposes.—J. Guild: The use of vacuum arcs for interferometry. The paper discusses the relative merits of short and long mercury arcs for this work, and points out that the defect of the former is due to the broadening of the spectrum lines consequent on the high vapour pressure within the lamp. It is shown that by attaching a condensing bulb to the lamp, so as to prevent excessive rise of vapour pressure, the short lamp can be made practically as good as the long one as regards sharpness of lines, while still being of much greater intrinsic brightness.—S. Butterworth: The maintenance of a vibrating system by means of a triode valve. This paper gives a mathematical analysis of the arrangement, previously

described by Eccles, whereby the vibrations of a tuning-fork are maintained by means of a triode.

PHILADELPHIA.

**American Philosophical Society**, April 24.—Dr. G. E. Hale, vice-president, in the chair.—Prof. E. W. Brown: The problem of the evolution of the solar system.—W. H. Wright: Certain aspects of recent spectroscopic observations of the gaseous nebulae which appear to establish the relationship between them and the stars. The paper summarises in non-technical terms the evidence afforded by a study of the stellar condensations in the planetary or small gaseous nebulae which are shown to be spectroscopically identical with stars of the Wolf-Rayet group (Pickering's Class O). A brief account is given of some of the present-day conceptions of stellar evolution for the purpose of indicating the somewhat critical nature with respect to these ideas of the relationship indicated.—Prof. E. P. Adams: The Einstein theory. The extension of the principle of relativity and the resulting revision of the concepts of space and time led to Einstein's interpretation of gravitation as a property of space itself when modified by the presence of matter.—Dr. L. A. Bauer: The results of geophysical observations during the solar eclipse of May 29, 1919, and their bearing upon the Einstein deflection of light. The present paper gives the results of a special study of the cause of the non-radial effects of the light deflections observed by the British expedition at Sobral, Brazil. It is shown that these non-radial effects may be completely accounted for by incomplete elimination of differential refraction effects in the earth's atmosphere. The same cause may apparently also explain why the observed radial deflections of light exceeded, on the average, by about 14 per cent. the amounts predicted on the basis of the Einstein law of gravitation.—Prof. J. B. Whitehead: The high-voltage corona in air. The paper describes the nature of the corona and recent studies of the laws governing its appearance in high-voltage circuits. Its influence as a limiting factor in long-distance transmission occurs through deterioration of insulation and a leakage loss of power between the high-voltage lines. The appearance of corona on a clean round wire is very sharply marked, and may be used for the measurement of high alternating voltages to a degree of accuracy not heretofore possible.—Prof. D. C. Miller: The velocity of explosive sounds. Most of the experiments were made in connection with 10-in. and 12-in. rifles, though a few were made with 6-in. and 8-in. guns. The amount of powder charge and the value of the internal pressure developed in the gun are taken into account. The sounds were received by means of specially constructed carbon-granule microphones, those for use near the gun being of unusually rugged construction, while others were of a very sensitive type. The records were made by a specially constructed moving-film camera in connection with a string-galvanometer capable of recording from six stations simultaneously, of the type used by the U.S. Army for sound-ranging. Meteorological observations were made by special observers in the distant stations and on the field near the guns at the time of the experiments, and continuous records were made at the Proving Ground Headquarters and at the United States Weather Bureau Station. These observations covered temperature, barometric height, humidity, wind velocity, and wind direction. Measurements were also made of the velocity of the sound at a series of stations located on a line at right angles to the line of fire and on a line at 45° to one side of the line of fire. Heretofore there has been a general

impression that explosive sounds travel much farther than do ordinary sounds, the velocity being, perhaps, several times the normal velocity. These experiments show conclusively that the velocity at a distance of 100 ft. from a 10-in. gun is about 1240 ft. per second, or 22 per cent. above normal; at 200 ft. from the gun the velocity is only about 5 per cent. above normal. For all distances above 500 ft. from the gun the velocity of the explosive sound from the largest-sized gun is practically normal.—Dr. H. C. **Hayes**: The U.S. Navy MV-type of hydrophone as an aid and safeguard to navigation.—Dr. A. E. **Kennelly**: The transient process of establishing a steady alternating electric current on a long line from laboratory measurements on an artificial line. It is known that the current and voltage do not build up steadily and continuously, but advance by little jumps which occur at regular short intervals of time, accompanying successive reflections of electromagnetic waves from one end of the line to the other. There is presented in this paper a number of observations which have been secured photographically of the rise of voltage and current on a long artificial electric power transmission line in the laboratory, and have compared the observed rates of growth with those which are indicated by theory with a fairly satisfactory agreement.—N. W. **Akimoff**: The strophoscope.—Prof. R. S. **Dugan**: New features in the eclipsing variable U Cephei. (Prof. W. B. Scott, president, in the chair).—Prof. E. N. **Harvey**: Animal luminescence and stimulation. The production of light by animals is due to the burning or oxidation of a substance called luciferin in the presence of an enzyme or catalyst called luciferase. Light production by animals differs from light produced by combustion in that the oxidation product of luciferin, oxyluciferin, can be easily reduced to luciferin, which will again oxidise with light production. The reaction is reversible, and appears to be of this nature:  $\text{luciferin} + \text{O} \rightleftharpoons \text{oxyluciferin} + \text{H}_2\text{O}$ . The difference between luciferin and oxyluciferin lies probably in this: that the luciferin possesses two atoms of hydrogen, which is removed to form  $\text{H}_2\text{O}$  when the luciferin is oxidised. The  $\text{H}_2$  must be added to re-form luciferin. Not only is it most efficient so far as the radiation (being all light) it produces is concerned, it is also most economical so far as its chemical processes are concerned. The above reactions can be demonstrated in a test-tube with a mixture of oxyluciferin, luciferase, and ammonium sulphide. The ammonium sulphide is probably represented in living cells by reducing enzymes or reductases. If such a test-tube is allowed to stand, oxyluciferin is reduced to luciferin, which will luminesce only at the surface of the fluid in the test-tube in contact with air. When the tube is agitated so as to dissolve more oxygen of the air, the liquid glows throughout. Even a gentle knock or "stimulus" to the tube is sufficient to cause enough oxygen to dissolve to give a momentary flash of light which is strikingly similar to the flash of light given by luminous animals themselves on stimulation. This suggests that when we agitate a luminous animal, or when the luminous gland-cells of a firefly are stimulated through nerves, with the resultant flash of light, in each case the stimulus acts by increasing the permeability of the surface-layer of the cells to oxygen. This then upsets an equilibrium involving the luciferin, luciferase, oxyluciferin, oxygen, and reductase within the cell, with the production of light and the formation of more oxyluciferin. So long as the luminous cell is resting and unstimulated, the tendency is for reduction processes to occur and luciferin to be formed. It must be pointed out that not all sorts of stimulation can be explained in

this way, as the stimulation of muscles or nerve-fibres may take place in the complete absence of oxygen.—Prof. G. H. **Parker**: The phosphorescence of Renilla. During the day Renilla cannot be excited to phosphoresce, but at night on stimulation it can be made to glow with a beautiful golden-green light. The light is produced in wave-like ripples that spread out from the spot stimulated and run over the upper surface of the animal. They travel at a relatively slow rate that agrees with that at which the nervous impulses of the animal travel. Hence it is concluded that the phosphorescence of Renilla is under the control of the nerve-net of the animal, which apparently pervades the whole colony.—Prof. W. M. **Wheeler** and I. W. **Bailey**: Feeding habits of Pseudomyrme ants. Examination of the mouth of the larva reveals a singular hitherto undescribed organ, evidently used for reducing the food-pellet to such a finely divided state that it can, when acted upon by the digestive juices of the stomach, yield a certain amount of nutriment which the worker-ant could not extract from it while it was in the infrabuccal pocket. This larval organ may be called the trophorhinium. In all Pseudomyrme larvae, and in many larvae of the other sub-families, except the Dorylinae and Cerapachyinae, the trophorhinium is beautifully developed, although in many ants (Ponerinae) it must be used for comminuting parts of insects given directly to the larvae by the workers. In its development the trophorhinium bears a strange resemblance to the stridulatory organs of the orthium and post-petiole of many adult ants.—Dr. A. E. **Pörtmann**: Correlation of shape and station in fresh-water mussels. It has been found that for certain species more swollen specimens are found down-stream in the larger rivers and more compressed specimens more up-stream, and that in the intermediate stretches of a river these extremes are connected by gradual transitions.—Prof. H. F. **Osborn**: Evolution principles deduced from a study of the even-toed Ungulates known as Titanotheria.—Prof. W. B. **Scott**: The Astropotheria.—B. F. **Howell**, jun.: The Middle Cambrian beds at Manuels, Newfoundland, and their relations. These beds are of special scientific interest because they contain large numbers of unusually well-preserved fossils, which prove that the creatures that swarmed in the waters then covering much of what is now New England, south-eastern Canada, and south-eastern Newfoundland were of practically the same sort as those living in the seas which at the same period washed over many parts of Scandinavia and the British Isles. North America has probably been joined to Europe in this way several times in the geological past, so that the animals living in the coastal waters could spread from one hemisphere to the other.—Prof. W. H. **Hobbs**: (1) The Michigan meteor of November 26, 1919. (2) The glacial anticline and the blizzard in relation to the domed surface of continental glaciers.

## ROME.

**Reale Accademia dei Lincei**, March 7.—A. Róiti, vice-president, in the chair.—Q. **Majorana**: Gravitation, viii.—O. **Chisini**: Analytic representation of the fold of a surface by a series of fractional powers of two variables.—U. **Cisotti**: Integration of the equation of wave-motion in a deep canal, ii. The equation of the free surface is determined.—O. **Onicescu**: Newtonian fields in the neighbourhood of a given vectorial field. An application of Levi-Civita's notion of harmonics in the neighbourhood of an assigned function. The author deduces the lamellar and solenoidal magnetisation which gives rise to a given magnetic field, and applies the result to deal with the existence and unique nature of the magnetisation in soft iron.

—**L. Tonelli**: Researches on primitive functions, iii.  
 —**V. Sabatini**: Leucitic lavas of the volcano of Roccamonfina. This deals mainly with the composition of the spurs, and particularly with the presence of leucite.—**B. Peyrouel**: A parasite of the lupin, *Blepharospora terrestris*. In December, 1919, plants of lupin were received infected with this parasite from Pantano and Pratolongo, near the Lake of Regillo. It appears to kill the plants, completely destroying the tubercles of the roots. The question is raised as to whether the parasite is of American origin, but the author considers it probably an indigenous type that has recently become destructive.—**T. Levi-Civita**: Harmonics in the neighbourhood of an assigned function. The problem is reduced to the determination of the Newtonian function having the given function as its density.—**R. Perotti**: Nitrogen of the cyanic group in manures. A contribution to the determination of the mechanism of action of cyanic nitrogen in vegetable nutrition and the conditions for its utilisation.—**M. Ascoli** and **A. Fagioli**: Sub-epidermic pharmacodynamic experiences, ii. The action of pituitrin is discussed. The limit of reactivity in normal subjects fluctuates about a dilution of 500.—**L. Cattolica**: Obituary notice of G. Dalla Vedova, professor of geography in the University of Rome.—**Sig. Baglioni**: The life and work of the late Luigi Luciani, professor of pathology at Parma from 1875 to 1880, and afterwards professor of physiology at Siena, Florence, and Rome in succession.

March 21.—**F. D'Ovidio**, president, in the chair.—**Q. Majorana**: Gravitation, ix. Gravitation may be partly absorbed by matter, and this absorption may give rise to heat. Bodies will then have two kinds of mass, apparent and real, and the real density of the sun will then be three times its apparent or astronomical density. An experimental test is being arranged at Turin for studying the action of 100 quintals of lead on a small central mass.—**O. Chisini**: Contact of curves of diramation for an algebraic function of two variables.—**M. De Angelis**: Crystalline forms of nitrodichloroacetanilide. This substance is dimorphic, modifications  $\alpha$  and  $\beta$  both being monoclinic and prismatic, the former with  $a:b:c = 1:1.507:1:1:1.348$  and  $\beta = 66^\circ 23'$ , the latter with the values  $1:5.792:1:1:1.0952$  and  $62^\circ 23.5'$ . The second form is decidedly unstable, and when left in the mother-solution, or even dried, it transforms in time into an aggregate of crystals of the stable phase.—**R. Perotti**: Measure of the ammoniating power of soils. The best conditions for employing the method of solutions are 10 c.c. solution of peptone of 1.5 per cent. in test-tubes, adding 5 c.c. of a mixture formed of 50 grams of earth in 500 grams of water; cultivation for four days in a thermostat at  $20^\circ-25^\circ$  C., and determination of ammonia by distillation on oxide of magnesia.—**M. Ascoli** and **A. Fagioli**: Sub-epidermic pharmacodynamic experiences, iii. Certain alkaloids, such as atropine, pilocarpine, muscarine, physostigmine, morphine, eserine, nicotine, cocaine, and scopolamine, which offer a cutaneous reaction of oedematogenous type, are referred to.

### Books Received.

The Theory of Electric Cables and Networks. By Dr. A. Russell. Second edition. Pp. x+348. (London: Constable and Co., Ltd.) 24s. net.

Wild Creatures of Garden and Hedgerow. By Frances Pitt. Pp. ix+285. (London: Constable and Co., Ltd.) 12s. net.

Every Boy's Book of Geology. By Dr. A. E. Trueman and W. P. Westell. Pp. 315. (London: R.T.S.) 6s. net.

The Fall of the Birth-Rate. By G. Udney Yule. Pp. 43. (Cambridge: At the University Press.) 4s. net.

Kritik der Abstammungslehre. By Prof. J. Reinke. Pp. v+133. (Leipzig: J. A. Barth.) 13 marks.

History of the Theory of Numbers. By Prof. L. E. Dickson. Vol. ii., Diophantine Analysis. Pp. xxv+803. (Washington: Carnegie Institution.)

An Introduction to the Study of Hypnotism: Experimental and Therapeutic. By Dr. H. E. Wingfield. Second edition. Pp. viii+195. (London: Baillière, Tindall, and Cox.) 7s. 6d. net.

Industrial Colonies and Village Settlements for the Consumptive. By Sir German Woodhead and P. C. Varrier-Jones. Pp. xi+151. (Cambridge: At the University Press.) 10s. 6d. net.

A Handbook of Physics and Chemistry. By H. E. Corbin and A. M. Stewart. Fifth edition. Pp. viii+496. (London: J. and A. Churchill.) 15s. net.

### CONTENTS.

	PAGE
The Forthcoming Census . . . . .	797
Prof. Alexander's Gifford Lectures. By the Right Hon. Viscount Haldane . . . . .	798
Principles and Practice of Surveying. By Lt.-Col. H. S. Winterbotham . . . . .	801
Australian Hardwoods. By A. B. J. . . . .	802
The Columbian Tradition. By J. L. E. D. . . . .	803
Our Bookshelf . . . . .	804
Letters to the Editor:—	
University Grants.—Prof. W. H. Perkin, F.R.S. . . . .	805
Use of Sumner Lines in Navigation. (With Diagram.) —Dr. John Ball . . . . .	806
Relativity and Hyperbolic Space.—Prof. Alex. McAulay . . . . .	808
The Antarctic Anticyclone.—R. M. Deeley . . . . .	808
A Method of Reaching Extreme Altitudes. (Illustrated.) By Prof. Robert H. Goddard . . . . .	809
New Aspects in the Assessment of Physical Fitness. By Dr. F. G. Hobson . . . . .	812
Oceanography and the Sea-Fisheries. Presidential Address to the British Association. By Prof. W. A. Herdman, C.B.E., D.Sc., Sc.D., LL.D., F.R.S. . . . .	813
Summaries of Addresses of Presidents of Sections of the British Association . . . . .	825
The British Association at Cardiff. By R. V. S. . . . .	830
Sir Norman Lockyer's Contributions to Astrophysics. By Prof. A. Fowler, F.R.S. . . . .	831
Notes . . . . .	834
Our Astronomical Column:—	
Discovery of a Nova in Cygnus . . . . .	838
Parallax of the B-type Star Boss 1517 . . . . .	838
Publications of the Astronomical Laboratory at Groningen, No. 29 . . . . .	838
Universities, Research, and Brain Waste . . . . .	839
The Sun as a Weather Prophet. By W. W. B. . . . .	839
Cotton Industry Research . . . . .	840
Sugar Cultivation in India. By Dr. W. E. Brenchley . . . . .	840
University and Educational Intelligence . . . . .	841
Societies and Academies . . . . .	842
Books Received . . . . .	844





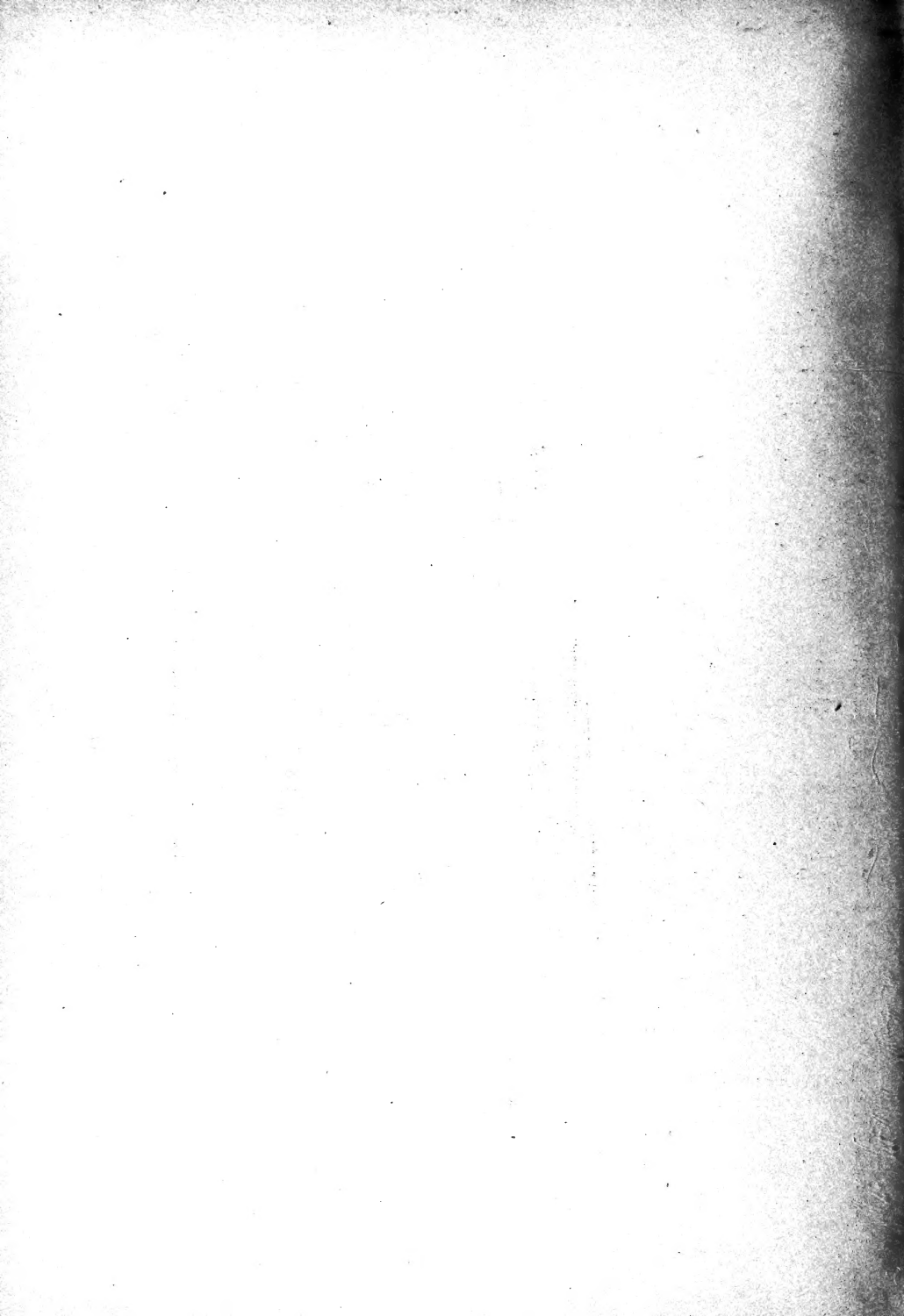

Q

1

N2

v. 105

cop. 2

**Physical &  
Applied Sci.  
Serials**

Nature

v. 105

PLEASE DO NOT REMOVE  
CARDS OR SLIPS FROM THIS POCKET

---

UNIVERSITY OF TORONTO LIBRARY

---

